

TGD AND FRINGE PHYSICS

Matti Pitkänen

Köydenpunojankatu D 11, 10900, Hanko, Finland

Contents

0.1	Background	1
0.2	Basic Ideas of TGD	1
0.2.1	TGD as a Poincare invariant theory of gravitation	1
0.2.2	TGD as a generalization of the hadronic string model	2
0.2.3	Fusion of the two approaches via a generalization of the space-time concept	2
0.3	The five threads in the development of quantum TGD	2
0.3.1	Quantum TGD as configuration space spinor geometry	2
0.3.2	p-Adic TGD	3
0.3.3	TGD as a generalization of physics to a theory consciousness	3
0.3.4	TGD as a generalized number theory	6
0.3.5	Dynamical quantized Planck constant and dark matter hierarchy	7
0.4	Bird's eye of view about the topics of the book	10
0.5	The contents of the book	11
0.5.1	Anomalies related to the classical Z^0 force and gravitation	11
0.5.2	The notion of free energy and many-sheeted space-time	12
0.5.3	About strange effects related to rotating magnetic systems	14
0.5.4	Did Tesla discover the mechanism changing the arrow of time?	15
0.5.5	Ufos, aliens, and the new physics	16
1	Anomalies Related to the Classical Z^0 Force and Gravitation	21
1.1	Introduction	21
1.1.1	TGD based view about dark matter	21
1.1.2	New Physics effects related to the new space-time concept	22
1.1.3	Some gravitational anomalies	23
1.1.4	Anomalies related to Z^0 force in astrophysical length scales	23
1.1.5	Anomalies related to rotating systems	23
1.2	The new view about inertial and gravitational energy	24
1.2.1	Two manners to circumvent the infinite vacuum energy	24
1.2.2	Zero energy vacuum is matter-antimatter asymmetric	24
1.2.3	Creation of matter from vacuum by annihilation of laser waves and their phase conjugates?	25
1.2.4	Re-interpretation of TGD inspired cosmology	25
1.3	Some gravitational anomalies	27
1.3.1	Anomalous time dilation effects due to warping as basic distinction between TGD and GRT	27
1.3.2	Anomalies related to spinning astrophysical objects	29
1.4	Is electro-gravity possible in TGD framework?	31
1.4.1	Classical gravitational fields for space-time surfaces for which CP_2 projection corresponds to a homologically non-trivial geodesic sphere	31
1.4.2	TGD does not predict anomalously large coupling of gravitation to classical gauge fields	33
1.4.3	Gravito-Maxwell field associated with a dipole field	34
1.5	Allais effect and TGD	35
1.5.1	Introduction	35
1.5.2	Could gravitational screening explain Allais effect	36
1.5.3	Allais effect as evidence for large values of gravitational Planck constant?	41

1.5.4	Could Z^0 force be present?	46
1.6	Dark Z^0 force in astrophysical length scales	47
1.6.1	The regularities in radio active decay rates linked to astrophysical cycles	47
1.6.2	Torsion fields or Z^0 fields	50
1.7	How to test the presence of the Z^0 force in micrometer-millimeter length scale range?	51
1.7.1	Scaling law for dark Z^0 charges	52
1.7.2	How to directly test the presence of classical Z^0 force?	53
1.8	Appendix: Allais effect as manifestation of classical Z^0 force?	58
1.8.1	Screening of dark Z^0 MEs emitted by Sun as an explanation of Allais effect?	58
1.8.2	Quantitative picture	59
2	The Notion of Free Energy and Many-Sheeted Space-Time Concept	67
2.1	Introduction	67
2.1.1	Basic new elements of TGD ontology	67
2.1.2	Could living systems teach us something about energy technology?	68
2.1.3	Various anomalies as support for the picture	68
2.1.4	Free energy anomalies	69
2.2	Basic ontology of TGD	70
2.2.1	T(opological) G(eometro)D(ynamics) very briefly	70
2.2.2	Many-sheeted space-time and the notion of field body	71
2.2.3	The hierarchy of Planck constants and of dark matter	71
2.2.4	Zero energy ontology	74
2.2.5	p-Adic physics as physics of cognition and intentionality	77
2.3	Many-sheeted space-time, universal metabolic quanta, and plasmoids as primitive life forms	78
2.3.1	Evidence for many-sheeted space-time	78
2.3.2	Laboratory evidence for plasmoids as life forms	81
2.3.3	Universal metabolic quanta	83
2.3.4	Life as a symbiosis of plasmoids and biological life	85
2.4	Podletnov effect and Modanese-Podkletnov effect	87
2.4.1	Modanese-Podkletnov effect	87
2.4.2	Podkletnov effect	89
2.4.3	Biefeld-Brown effect, lifters, corona wind, and Modanese-Podkletnov effect	91
2.5	New hydrogen technologies and new physics	95
2.5.1	Anomalies related to the dissociation of water and hydrogen molecules	95
2.5.2	The anomalies associated with the dissociation of water molecules	96
2.5.3	The anomaly related to the thermal dissociation of molecular hydrogen	100
2.5.4	Hydrino atoms, anyons, and fractional quantization in many-sheeted space-time	100
2.5.5	An explanation of findings of Mills in terms of quantized Planck constant	103
2.5.6	Could q-Laguerre equation relate to the claimed fractionation of the principal quantum number for hydrogen atom?	104
2.5.7	Free energy from atomic hydrogen	110
2.6	Appendix: A generalization of the notion of imbedding space inspired by hierarchy of Planck constants	110
2.6.1	The original view about generalized imbedding space	110
2.6.2	Fractionization of quantum numbers is not possible if only factor spaces are allowed	111
2.6.3	Both covering spaces and factor spaces are possible	111
2.6.4	Do factor spaces and coverings correspond to the two kinds of Jones inclusions?	112
2.6.5	Fractional Quantum Hall effect	113
3	About Strange Effects Related to Rotating Magnetic Systems	123
3.1	Introduction	123
3.1.1	Anomalies associated with rotating magnetic systems	124
3.1.2	Possible other similar systems	126
3.2	Summary about the New Physics effects predicted by TGD	126
3.2.1	The new view about the relationship between gravitational and inertial energy	126

3.2.2	Generalized four-wave mechanism as a basic mechanism of remote metabolism	127
3.2.3	The classical Z^0 fields as TGD counterpart for torsion fields	129
3.2.4	Gravitational anomalies and many-sheeted space-time	129
3.2.5	Questions related to the vacuum charge densities associated with rotating systems	130
3.3	About strange effects related to rotating magnetic systems	132
3.3.1	The experiment, the observed effects, and their interpretation in TGD framework	133
3.3.2	The electric fields associated with rotating magnetic fields	137
3.3.3	A classical model for the weight change and spontaneous acceleration involving only em and Z^0 fields and Faraday effect	139
3.3.4	The role of the material composition of the system	157
3.3.5	Magnetic fields associated with the Searl device	164
3.3.6	Remote energy and angular momentum transfer in rotating magnetic systems	165
3.3.7	Connection with the dark matter hierarchy	169
3.3.8	Discussion	171
3.4	Effects related to Searl effect	174
3.4.1	N-machine of DePalma and space-energy generator of Tewari	174
3.4.2	Some anomalies related to the behavior of spinning systems	175
3.5	Project Flyaway and Searl effect	176
3.5.1	Description of the device	176
3.5.2	About the bi-filar coils	177
3.5.3	Trying to explain the claimed effects	178
3.6	Appendix	181
3.6.1	Miscellaneous considerations	181
3.6.2	Some general facts about classical solutions of field equations	184
3.6.3	Could spontaneous acceleration be due to the change of inertial mass?	186
4	Did Tesla Discover the Mechanism Changing the Arrow of Time?	197
4.1	Introduction	197
4.2	Discussion of the basic ideas and concepts	198
4.2.1	Do negative energy space-time sheets have counterparts in quantum field theory?	198
4.2.2	Is the TGD view about phase conjugate waves consistent with the existent wisdom?	200
4.2.3	Pulses, Tesla transformers, and binary coils	203
4.2.4	Could negative energy photons induce the transition to effective superconductivity?	206
4.3	The scalar waves of Tesla in TGD framework	207
4.3.1	The properties of the scalar waves	207
4.3.2	Could nonlinearity of TGD allow scalar waves?	207
4.3.3	Lowest order solution ansatz	208
4.3.4	First order corrections to the solution ansatz	209
4.3.5	Properties of the solution ansatz	210
4.3.6	More general solutions representing electric field of constant action density are possible	211
4.3.7	Support for Tesla's scalar waves/classical Z^0 MEs	212
4.4	Does the model explain the basic observations of Tesla?	214
4.4.1	Switching the current on as a time reversal for switching the current off	214
4.4.2	Do scalar wave pulses appear also outside electric circuits?	215
4.4.3	Why the radiation observed by Tesla was so difficult to detect using photography?	215
4.4.4	How Tesla transformer manages to yield so high voltage amplification?	216
4.4.5	Why no current was observed in the secondaries of Tesla transformers?	216
4.5	Super-luminal velocities, massless extremals, and quantum jumps between quantum histories	217
4.5.1	General model for super-luminal velocities	217
4.5.2	Quantitative model	220
4.5.3	Possible technological implications	222
4.6	Figures and illustrations	228

5	Ufos, Aliens, and the New Physics	231
5.1	Introduction	231
5.2	Basic vision	232
5.2.1	Quantum-classical correspondence	232
5.2.2	Classical physics as exact part of quantum theory	232
5.2.3	p-Adic physics as physics of cognition and intentionality	234
5.2.4	The core ideas of TGD inspired theory of consciousness and quantum biology	235
5.3	TGD based view about life	237
5.3.1	The notion of magnetic body	237
5.3.2	Time mirror mechanism as a fundamental mechanism transforming intentions to actions	240
5.3.3	Applications of time mirror mechanism	241
5.3.4	Vision about the evolution of life	242
5.3.5	Could simple life forms be induced by intentional action?	247
5.4	How advanced civilization could study cosmos?	252
5.4.1	Why space travel is not a good idea?	253
5.4.2	Time mirror mechanism as an ideal tool for the study of the Universe	253
5.4.3	What aliens are?	253
5.4.4	Have more advanced civilizations performed genetic engineering at Earth?	255
5.4.5	Fermi paradox	256
5.4.6	Dark matter hierarchy as a solution of Fermi paradox?	257
5.5	What UFOs are?	259
5.5.1	UFOs as plasmoids?	259
5.5.2	UFOs made of copper and steel?	259
5.5.3	Are flying saucers necessarily living systems?	260
5.6	Figures and illustrations	266
A	Appendix	271
A-1	Basic properties of CP_2	271
A-1.1	CP_2 as a manifold	271
A-1.2	Metric and Kähler structures of CP_2	271
A-1.3	Spinors in CP_2	274
A-1.4	Geodesic submanifolds of CP_2	274
A-2	Identification of the electro-weak couplings	275
A-2.1	Discrete symmetries	278
A-3	Space-time surfaces with vanishing em, Z^0 , Kähler, or W fields	279
A-3.1	Em neutral space-times	279
A-3.2	Space-times with vanishing Z^0 or Kähler fields	281
A-3.3	Induced gauge fields for space-times for which CP_2 projection is a geodesic sphere	281
A-4	Second variation of the Kähler action	281
A-5	p-Adic numbers	284
A-6	Canonical correspondence between p-adic and real numbers	284

List of Figures

3.1	Variant of one-ring converter (figure 25 in [27]).	133
3.2	The general view of the converted and its platform (figure 26 in [27]).	133
3.3	Magnetic inserts could make possible magnetic cogwheel mechanism (figure 27 in [27]).	134
3.4	The development of the change of weight as function of rotation frequency (figure 28 in [27]).	135
3.5	Cusp catastrophe	148
4.1	Time mirror mechanism	228
4.2	a) The structure of bi-filar coils and the mechanical analog of RCL circuit as a harmonic oscillator. b) The reduction of the mass of the harmonic oscillator at the second half of the magnetic pulse implies acceleration and generation of negative energy photons in order to get energy.	229
4.3	A mechanism of energy production based on negative energy topological light rays and population inversion.	229
4.4	Constant voltage pulse (a) and the corresponding electric (b) and magnetic (c) pulses in the bi-filar coil.	229
4.5	Rational valued points x and $y = x + p^n$, which are close to each other p-adically, are far from each other in real sense.	230
4.6	The non-determinism of p-adic differential equations in the case of a free particle. a) In real case the initial position x_0 and and velocity v determine the orbit. b) In the p-adic case x_0 and v are piecewise constant functions of time and the orbit resembles that associated with Brown motion.	230
4.7	Rational numbers are common to both reals R and all p-adic number fields R_p , $p = 2, 3, \dots$. These number fields can be "glued" together along the rational numbers to form a book like structure. Rational numbers correspond to the rim of the book and different number fields to its pages.	230
5.1	Space-times can be regarded as 4-dimensional surfaces in 8-dimensional space $H = M_+^4 \times CP_2$ obtained by replacing points of future light cone of Minkowski space with CP_2	266
5.2	Material objects correspond to the sheets of the many-sheeted space-time. Note that sheets are extremely near to each other.	266
5.3	The space-time sheets condensed on larger space-time sheets having no join along boundaries bonds can be connected by join along boundaries bonds. This forces to generalize the notion of sub-system and makes possible sharing of mental images. . . .	267
5.4	Generalization of the number concept: real and p-adic number fields correspond to the pages of book and the rim of book corresponds to rational numbers common to all of them.	267
5.5	The transformation of p-adic space-time sheet to a real one in quantum jump correspond to the transformation of intention to action.	268
5.6	Quantum entangled systems lose their identify. Schrödinger cat entangled with the poisson bottle is neither living nor dead or is both simultaneously.	268
5.7	Arecibo message provides information about us.	269

5.8 Chilbolton crop formation of figure a) is made using the same format as Arecibo message and can be interpreted as providing information about the constructors of the formation. Figure b) is the counterpart of radio antenna used to generate the message. A possible interpretation is as magnetosphere which suggests that the conscious entity responsible for the generation of crop circles is entity magnetosphere, brain of Mother Gaia. . . . 269

5.9 Time mirror mechanism 270

A.1 The real norm induced by canonical identification from 2-adic norm. 286

0.1 Background

T(opological) G(eometro)D(ynamics) is one of the many attempts to find a unified description of basic interactions. The development of the basic ideas of TGD to a relatively stable form took time of about half decade [33]. The great challenge is to construct a mathematical theory around these physically very attractive ideas and I have devoted the last twenty-three years for the realization of this dream and this has resulted in seven online books [TGDview, TGDgeom, TGDquant, TGDnumber, TGDclass, TGDpad, TGDfree] about TGD and eight online books about TGD inspired theory of consciousness and of quantum biology [TGDconsc, TGDselforg, TGDware, TGDholo, TGDgeme, TGDeeg, TGDmagn, 15].

Quantum T(opological)D(ynamics) as a classical spinor geometry for infinite-dimensional configuration space, p-adic numbers and quantum TGD, and TGD inspired theory of consciousness have been for last decade of the second millenium the basic three strongly interacting threads in the tapestry of quantum TGD.

For few yeas ago the discussions with Tony Smith generated a fourth thread which deserves the name 'TGD as a generalized number theory'. The work with Riemann hypothesis made time ripe for realization that the notion of infinite primes could provide, not only a reformulation, but a deep generalization of quantum TGD. This led to a thorough and extremely fruitful revision of the basic views about what the final form and physical content of quantum TGD might be.

The fifth thread came with the realization that by quantum classical correspondence TGD predicts an infinite hierarchy of macroscopic quantum systems with increasing sizes, that it is not at all clear whether standard quantum mechanics can accommodate this hierarchy, and that a dynamical quantized Planck constant might be necessary and certainly possible in TGD framework. The identification of hierarchy of Planck constants whose values TGD "predicts" in terms of dark matter hierarchy would be natural. This also led to a solution of a long standing puzzle: what is the proper interpretation of the predicted fractal hierarchy of long ranged classical electro-weak and color gauge fields. Quantum classical correspondences allows only single answer: there is infinite hierarchy of p-adically scaled up variants of standard model physics and for each of them also dark hierarchy. Thus TGD Universe would be fractal in very abstract and deep sense.

TGD forces the generalization of physics to a quantum theory of consciousness, and represent TGD as a generalized number theory leads naturally to the emergence of p-adic physics as physics of cognitive representations. The seven online books [TGDview, TGDgeom, TGDquant, TGDnumber, TGDclass, TGDpad, TGDfree] about TGD and eight online books about TGD inspired theory of consciousness and of quantum biology [TGDconsc, TGDselforg, TGDware, TGDholo, TGDgeme, TGDeeg, TGDmagn, 15] are warmly recommended to the interested reader.

0.2 Basic Ideas of TGD

The basic physical picture behind TGD was formed as a fusion of two rather disparate approaches: namely TGD is as a Poincare invariant theory of gravitation and TGD as a generalization of the old-fashioned string model.

0.2.1 TGD as a Poincare invariant theory of gravitation

The first approach was born as an attempt to construct a Poincare invariant theory of gravitation. Space-time, rather than being an abstract manifold endowed with a pseudo-Riemannian structure, is regarded as a surface in the 8-dimensional space $H = M_+^4 \times CP_2$, where M_+^4 denotes the interior of the future light cone of the Minkowski space (to be referred as light cone in the sequel) and $CP_2 = SU(3)/U(2)$ is the complex projective space of two complex dimensions [2, 17, 18, 5]. The identification of the space-time as a submanifold [20, 21] of $M^4 \times CP_2$ leads to an exact Poincare invariance and solves the conceptual difficulties related to the definition of the energy-momentum in General Relativity [Misner-Thorne-Wheeler, Logunov *et al*]. The actual choice $H = M_+^4 \times CP_2$ implies the breaking of the Poincare invariance in the cosmological scales but only at the quantum level. It soon however turned out that submanifold geometry, being considerably richer in structure than the abstract manifold geometry, leads to a geometrization of all basic interactions. First, the geometrization of the elementary particle quantum numbers is achieved. The geometry of CP_2 explains

electro-weak and color quantum numbers. The different H-chiralities of H -spinors correspond to the conserved baryon and lepton numbers. Secondly, the geometrization of the field concept results. The projections of the CP_2 spinor connection, Killing vector fields of CP_2 and of H -metric to four-surface define classical electro-weak, color gauge fields and metric in X^4 .

0.2.2 TGD as a generalization of the hadronic string model

The second approach was based on the generalization of the mesonic string model describing mesons as strings with quarks attached to the ends of the string. In the 3-dimensional generalization 3-surfaces correspond to free particles and the boundaries of the 3- surface correspond to partons in the sense that the quantum numbers of the elementary particles reside on the boundaries. Various boundary topologies (number of handles) correspond to various fermion families so that one obtains an explanation for the known elementary particle quantum numbers. This approach leads also to a natural topological description of the particle reactions as topology changes: for instance, two-particle decay corresponds to a decay of a 3-surface to two disjoint 3-surfaces.

0.2.3 Fusion of the two approaches via a generalization of the space-time concept

The problem is that the two approaches seem to be mutually exclusive since the orbit of a particle like 3-surface defines 4-dimensional surface, which differs drastically from the topologically trivial macroscopic space-time of General Relativity. The unification of these approaches forces a considerable generalization of the conventional space-time concept. First, the topologically trivial 3-space of General Relativity is replaced with a "topological condensate" containing matter as particle like 3-surfaces "glued" to the topologically trivial background 3-space by connected sum operation. Secondly, the assumption about connectedness of the 3-space is given up. Besides the "topological condensate" there is "vapor phase" that is a "gas" of particle like 3-surfaces (counterpart of the "baby universes" of GRT) and the nonconservation of energy in GRT corresponds to the transfer of energy between the topological condensate and vapor phase.

0.3 The five threads in the development of quantum TGD

The development of TGD has involved four strongly interacting threads: physics as infinite-dimensional geometry; p-adic physics; TGD inspired theory of consciousness and TGD as a generalized number theory. In the following these five threads are briefly described.

0.3.1 Quantum TGD as configuration space spinor geometry

A turning point in the attempts to formulate a mathematical theory was reached after seven years from the birth of TGD. The great insight was "Do not quantize". The basic ingredients to the new approach have served as the basic philosophy for the attempt to construct Quantum TGD since then and are the following ones:

a) Quantum theory for extended particles is free(!), classical(!) field theory for a generalized Schrödinger amplitude in the configuration space CH consisting of all possible 3-surfaces in H . "All possible" means that surfaces with arbitrary many disjoint components and with arbitrary internal topology and also singular surfaces topologically intermediate between two different manifold topologies are included. Particle reactions are identified as topology changes [22, 23, 24]. For instance, the decay of a 3-surface to two 3-surfaces corresponds to the decay $A \rightarrow B + C$. Classically this corresponds to a path of configuration space leading from 1-particle sector to 2-particle sector. At quantum level this corresponds to the dispersion of the generalized Schrödinger amplitude localized to 1-particle sector to two-particle sector. All coupling constants should result as predictions of the theory since no nonlinearities are introduced.

b) Configuration space is endowed with the metric and spinor structure so that one can define various metric related differential operators, say Dirac operator, appearing in the field equations of the theory.

0.3.2 p-Adic TGD

The p-adic thread emerged for roughly ten years ago as a dim hunch that p-adic numbers might be important for TGD. Experimentation with p-adic numbers led to the notion of canonical identification mapping reals to p-adics and vice versa. The breakthrough came with the successful p-adic mass calculations using p-adic thermodynamics for Super-Virasoro representations with the super-Kac-Moody algebra associated with a Lie-group containing standard model gauge group. Although the details of the calculations have varied from year to year, it was clear that p-adic physics reduces not only the ratio of proton and Planck mass, the great mystery number of physics, but all elementary particle mass scales, to number theory if one assumes that primes near prime powers of two are in a physically favored position. Why this is the case, became one of the key puzzles and led to a number of arguments with a common gist: evolution is present already at the elementary particle level and the primes allowed by the p-adic length scale hypothesis are the fittest ones.

It became very soon clear that p-adic topology is not something emerging in Planck length scale as often believed, but that there is an infinite hierarchy of p-adic physics characterized by p-adic length scales varying to even cosmological length scales. The idea about the connection of p-adics with cognition motivated already the first attempts to understand the role of the p-adics and inspired 'Universe as Computer' vision but time was not ripe to develop this idea to anything concrete (p-adic numbers are however in a central role in TGD inspired theory of consciousness). It became however obvious that the p-adic length scale hierarchy somehow corresponds to a hierarchy of intelligences and that p-adic prime serves as a kind of intelligence quotient. Ironically, the almost obvious idea about p-adic regions as cognitive regions of space-time providing cognitive representations for real regions had to wait for almost a decade for the access into my consciousness.

There were many interpretational and technical questions crying for a definite answer. What is the relationship of p-adic non-determinism to the classical non-determinism of the basic field equations of TGD? Are the p-adic space-time region genuinely p-adic or does p-adic topology only serve as an effective topology? If p-adic physics is direct image of real physics, how the mapping relating them is constructed so that it respects various symmetries? Is the basic physics p-adic or real (also real TGD seems to be free of divergences) or both? If it is both, how should one glue the physics in different number field together to get *The Physics*? Should one perform p-adicization also at the level of the configuration space of 3-surfaces? Certainly the p-adicization at the level of super-conformal representation is necessary for the p-adic mass calculations. Perhaps the most basic and most irritating technical problem was how to precisely define p-adic definite integral which is a crucial element of any variational principle based formulation of the field equations. Here the frustration was not due to the lack of solution but due to the too large number of solutions to the problem, a clear symptom for the sad fact that clever inventions rather than real discoveries might be in question.

Despite these frustrating uncertainties, the number of the applications of the poorly defined p-adic physics grew steadily and the applications turned out to be relatively stable so that it was clear that the solution to these problems must exist. It became only gradually clear that the solution of the problems might require going down to a deeper level than that represented by reals and p-adics.

0.3.3 TGD as a generalization of physics to a theory consciousness

General coordinate invariance forces the identification of quantum jump as quantum jump between entire deterministic quantum histories rather than time=constant snapshots of single history. The new view about quantum jump forces a generalization of quantum measurement theory such that observer becomes part of the physical system. Thus a general theory of consciousness is unavoidable outcome. This theory is developed in detail in the books [TGDconsc, TGDselforg, TGDware, TGDholo, TGDgame, TGDeeg, TGDmagn, 15].

Quantum jump as a moment of consciousness

The identification of quantum jump between deterministic quantum histories (configuration space spinor fields) as a moment of consciousness defines microscopic theory of consciousness. Quantum jump involves the steps

$$\Psi_i \rightarrow U\Psi_i \rightarrow \Psi_f ,$$

where U is informational "time development" operator, which is unitary like the S-matrix characterizing the unitary time evolution of quantum mechanics. U is however only formally analogous to Schrödinger time evolution of infinite duration although there is *no* real time evolution involved. It is not however clear whether one should regard U-matrix and S-matrix as two different things or not: U -matrix is a completely universal object characterizing the dynamics of evolution by self-organization whereas S-matrix is a highly context dependent concept in wave mechanics and in quantum field theories where it at least formally represents unitary time translation operator at the limit of an infinitely long interaction time. The S-matrix understood in the spirit of superstring models is however something very different and could correspond to U-matrix.

The requirement that quantum jump corresponds to a measurement in the sense of quantum field theories implies that each quantum jump involves localization in zero modes which parameterize also the possible choices of the quantization axes. Thus the selection of the quantization axes performed by the Cartesian outsider becomes now a part of quantum theory. Together these requirements imply that the final states of quantum jump correspond to quantum superpositions of space-time surfaces which are macroscopically equivalent. Hence the world of conscious experience looks classical. At least formally quantum jump can be interpreted also as a quantum computation in which matrix U represents unitary quantum computation which is however not identifiable as unitary translation in time direction and cannot be 'engineered'.

The notion of self

The concept of self is absolutely essential for the understanding of the macroscopic and macro-temporal aspects of consciousness. Self corresponds to a subsystem able to remain un-entangled under the sequential informational 'time evolutions' U . Exactly vanishing entanglement is practically impossible in ordinary quantum mechanics and it might be that 'vanishing entanglement' in the condition for self-property should be replaced with 'subcritical entanglement'. On the other hand, if space-time decomposes into p-adic and real regions, and if entanglement between regions representing physics in different number fields vanishes, space-time indeed decomposes into selves in a natural manner.

It is assumed that the experiences of the self after the last 'wake-up' sum up to single average experience. This means that subjective memory is identifiable as conscious, immediate short term memory. Selves form an infinite hierarchy with the entire Universe at the top. Self can be also interpreted as mental images: our mental images are selves having mental images and also we represent mental images of a higher level self. A natural hypothesis is that self S experiences the experiences of its subselves as kind of abstracted experience: the experiences of subselves S_i are not experienced as such but represent kind of averages $\langle S_{ij} \rangle$ of sub-subselves S_{ij} . Entanglement between selves, most naturally realized by the formation of join along boundaries bonds between cognitive or material space-time sheets, provides a possible a mechanism for the fusion of selves to larger selves (for instance, the fusion of the mental images representing separate right and left visual fields to single visual field) and forms wholes from parts at the level of mental images.

Relationship to quantum measurement theory

The third basic element relates TGD inspired theory of consciousness to quantum measurement theory. The assumption that localization occurs in zero modes in each quantum jump implies that the world of conscious experience looks classical. It also implies the state function reduction of the standard quantum measurement theory as the following arguments demonstrate (it took incredibly long time to realize this almost obvious fact!).

a) The standard quantum measurement theory a la von Neumann involves the interaction of brain with the measurement apparatus. If this interaction corresponds to entanglement between microscopic degrees of freedom m with the macroscopic effectively classical degrees of freedom M characterizing the reading of the measurement apparatus coded to brain state, then the reduction of this entanglement in quantum jump reproduces standard quantum measurement theory provide the unitary time evolution operator U acts as flow in zero mode degrees of freedom and correlates completely some orthonormal basis of configuration space spinor fields in non-zero modes with the values of the zero modes. The flow property guarantees that the localization is consistent with unitarity: it also means 1-1 mapping of quantum state basis to classical variables (say, spin direction of the electron to its orbit in the external magnetic field).

b) Since zero modes represent classical information about the geometry of space-time surface (shape, size, classical Kähler field,...), they have interpretation as effectively classical degrees of freedom and are the TGD counterpart of the degrees of freedom M representing the reading of the measurement apparatus. The entanglement between quantum fluctuating non-zero modes and zero modes is the TGD counterpart for the $m - M$ entanglement. Therefore the localization in zero modes is equivalent with a quantum jump leading to a final state where the measurement apparatus gives a definite reading.

This simple prediction is of utmost theoretical importance since the black box of the quantum measurement theory is reduced to a fundamental quantum theory. This reduction is implied by the replacement of the notion of a point like particle with particle as a 3-surface. Also the infinite-dimensionality of the zero mode sector of the configuration space of 3-surfaces is absolutely essential. Therefore the reduction is a triumph for quantum TGD and favors TGD against string models.

Standard quantum measurement theory involves also the notion of state preparation which reduces to the notion of self measurement. Each localization in zero modes is followed by a cascade of self measurements leading to a product state. This process is obviously equivalent with the state preparation process. Self measurement is governed by the so called Negentropy Maximization Principle (NMP) stating that the information content of conscious experience is maximized. In the self measurement the density matrix of some subsystem of a given self localized in zero modes (after ordinary quantum measurement) is measured. The self measurement takes place for that subsystem of self for which the reduction of the entanglement entropy is maximal in the measurement. In p-adic context NMP can be regarded as the variational principle defining the dynamics of cognition. In real context self measurement could be seen as a repair mechanism allowing the system to fight against quantum thermalization by reducing the entanglement for the subsystem for which it is largest (fill the largest hole first in a leaking boat).

Selves self-organize

The fourth basic element is quantum theory of self-organization based on the identification of quantum jump as the basic step of self-organization [I1]. Quantum entanglement gives rise to the generation of long range order and the emergence of longer p-adic length scales corresponds to the emergence of larger and larger coherent dynamical units and generation of a slaving hierarchy. Energy (and quantum entanglement) feed implying entropy feed is a necessary prerequisite for quantum self-organization. Zero modes represent fundamental order parameters and localization in zero modes implies that the sequence of quantum jumps can be regarded as hopping in the zero modes so that Haken's classical theory of self organization applies almost as such. Spin glass analogy is a further important element: self-organization of self leads to some characteristic pattern selected by dissipation as some valley of the "energy" landscape.

Dissipation can be regarded as the ultimate Darwinian selector of both memes and genes. The mathematically ugly irreversible dissipative dynamics obtained by adding phenomenological dissipation terms to the reversible fundamental dynamical equations derivable from an action principle can be understood as a phenomenological description replacing in a well defined sense the series of reversible quantum histories with its envelope.

Classical non-determinism of Kähler action

The fifth basic element are the concepts of association sequence and cognitive space-time sheet. The huge vacuum degeneracy of the Kähler action suggests strongly that the absolute minimum space-time is not always unique. For instance, a sequence of bifurcations can occur so that a given space-time branch can be fixed only by selecting a finite number of 3-surfaces with time like(!) separations on the orbit of 3-surface. Quantum classical correspondence suggest an alternative formulation. Space-time surface decomposes into maximal deterministic regions and their temporal sequences have interpretation a space-time correlate for a sequence of quantum states defined by the initial (or final) states of quantum jumps. This is consistent with the fact that the variational principle selects preferred extremals of Kähler action as generalized Bohr orbits.

In the case that non-determinism is located to a finite time interval and is microscopic, this sequence of 3-surfaces has interpretation as a simulation of a classical history, a geometric correlate for contents of consciousness. When non-determinism has long lasting and macroscopic effect one can identify it as

volitional non-determinism associated with our choices. Association sequences relate closely with the cognitive space-time sheets defined as space-time sheets having finite time duration and psychological time can be identified as a temporal center of mass coordinate of the cognitive space-time sheet. The gradual drift of the cognitive space-time sheets to the direction of future force by the geometry of the future light cone explains the arrow of psychological time.

p-Adic physics as physics of cognition and intentionality

The sixth basic element adds a physical theory of cognition to this vision. TGD space-time decomposes into regions obeying real and p-adic topologies labelled by primes $p = 2, 3, 5, \dots$. p-Adic regions obey the same field equations as the real regions but are characterized by p-adic non-determinism since the functions having vanishing p-adic derivative are pseudo constants which are piecewise constant functions. Pseudo constants depend on a finite number of positive binary digits of arguments just like numerical predictions of any theory always involve decimal cutoff. This means that p-adic space-time regions are obtained by gluing together regions for which integration constants are genuine constants. The natural interpretation of the p-adic regions is as cognitive representations of real physics. The freedom of imagination is due to the p-adic non-determinism. p-Adic regions perform mimicry and make possible for the Universe to form cognitive representations about itself. p-Adic physics space-time sheets serve also as correlates for intentional action.

A more more precise formulation of this vision requires a generalization of the number concept obtained by fusing reals and p-adic number fields along common rationals (in the case of algebraic extensions among common algebraic numbers). This picture is discussed in [E1]. The application this notion at the level of the imbedding space implies that imbedding space has a book like structure with various variants of the imbedding space glued together along common rationals (algebraics). The implication is that genuinely p-adic numbers (non-rationals) are strictly infinite as real numbers so that most points of p-adic space-time sheets are at real infinity, outside the cosmos, and that the projection to the real imbedding space is discrete set of rationals (algebraics). Hence cognition and intentionality are almost completely outside the real cosmos and touch it at a discrete set of points only.

This view implies also that purely local p-adic physics codes for the p-adic fractality characterizing long range real physics and provides an explanation for p-adic length scale hypothesis stating that the primes $p \simeq 2^k$, k integer are especially interesting. It also explains the long range correlations and short term chaos characterizing intentional behavior and explains why the physical realizations of cognition are always discrete (say in the case of numerical computations). Furthermore, a concrete quantum model for how intentions are transformed to actions emerges.

The discrete real projections of p-adic space-time sheets serve also space-time correlate for a logical thought. It is very natural to assign to p-adic binary digits a p -valued logic but as such this kind of logic does not have any reasonable identification. p-Adic length scale hypothesis suggest that the $p = 2^k - n$ binary digits represent a Boolean logic B^k with k elementary statements (the points of the k -element set in the set theoretic realization) with n taboos which are constrained to be identically true.

0.3.4 TGD as a generalized number theory

Quantum T(opological)D(ynamics) as a classical spinor geometry for infinite-dimensional configuration space, p-adic numbers and quantum TGD, and TGD inspired theory of consciousness, have been for last ten years the basic three strongly interacting threads in the tapestry of quantum TGD. For few years ago the discussions with Tony Smith generated a fourth thread which deserves the name 'TGD as a generalized number theory'. It involves three separate threads: the fusion of real and various p-adic physics to a single coherent whole by requiring number theoretic universality discussed already, the formulation of quantum TGD in terms of hyper-counterparts of classical number fields identified as sub-spaces of complexified classical number fields with Minkowskian signature of the metric defined by the complexified inner product, and the notion of infinite prime.

The role of classical number fields

The vision about the physical role of the classical number fields relies on the notion of number theoretic compactification stating that space-time surfaces can be regarded as surfaces of either M^8 or $M^4 \times CP_2$.

As surfaces of M^8 identifiable as space of hyper-octonions they are hyper-quaternionic or co-hyper-quaternionic- and thus maximally associative or co-associative. This means that their tangent space is either hyper-quaternionic plane of M^8 or an orthogonal complement of such a plane. These surface can be mapped in natural manner to surfaces in $M^4 \times CP_2$ [E2] provided one can assign to each point of tangent space a hyper-complex plane $M^2(x) \subset M^4$. One can also speak about $M^8 - H$ duality.

This vision has very strong predictive power. It predicts that the extremals of Kähler action correspond to either hyper-quaternionic or co-hyper-quaternionic surfaces such that one can assign to tangent space at each point of space-time surface a hyper-complex plane $M^2(x) \subset M^4$. As a consequence, the M^4 projection of space-time surface at each point contains $M^2(x)$ and its orthogonal complement. These distributions are integrable implying that space-time surface allows dual slicings defined by string world sheets Y^2 and partonic 2-surfaces X^2 . The existence of this kind of slicing was earlier deduced from the study of extremals of Kähler action and christened as Hamilton-Jacobi structure. The physical interpretation of $M^2(x)$ is as the space of non-physical polarizations and the plane of local 4-momentum.

One can fairly say, that number theoretical compactification is responsible for most of the understanding of quantum TGD that has emerged during last years. This includes the realization of Equivalence Principle at space-time level, dual formulations of TGD as Minkowskian and Euclidian string model type theories, the precise identification of preferred extremals of Kähler action as extremals for which second variation vanishes (at least for deformations representing dynamical symmetries) and thus providing space-time correlate for quantum criticality, the notion of number theoretic braid implied by the basic dynamics of Kähler action and crucial for precise construction of quantum TGD as almost-topological QFT, the construction of configuration space metric and spinor structure in terms of second quantized induced spinor fields with modified Dirac action defined by Kähler action realizing automatically the notion of finite measurement resolution and a connection with inclusions of hyper-finite factors of type II_1 about which Clifford algebra of configuration space represents an example.

Infinite primes

The discovery of the hierarchy of infinite primes and their correspondence with a hierarchy defined by a repeatedly second quantized arithmetic quantum field theory gave a further boost for the speculations about TGD as a generalized number theory. The work with Riemann hypothesis led to further ideas.

After the realization that infinite primes can be mapped to polynomials representable as surfaces geometrically, it was clear how TGD might be formulated as a generalized number theory with infinite primes forming the bridge between classical and quantum such that real numbers, p-adic numbers, and various generalizations of p-adics emerge dynamically from algebraic physics as various completions of the algebraic extensions of rational (hyper-)quaternions and (hyper-)octonions. Complete algebraic, topological and dimensional democracy would characterize the theory.

What is especially satisfying is that p-adic and real regions of the space-time surface could emerge automatically as solutions of the field equations. In the space-time regions where the solutions of field equations give rise to in-admissible complex values of the imbedding space coordinates, p-adic solution can exist for some values of the p-adic prime. The characteristic non-determinism of the p-adic differential equations suggests strongly that p-adic regions correspond to 'mind stuff', the regions of space-time where cognitive representations reside. This interpretation implies that p-adic physics is physics of cognition. Since Nature is probably extremely brilliant simulator of Nature, the natural idea is to study the p-adic physics of the cognitive representations to derive information about the real physics. This view encouraged by TGD inspired theory of consciousness clarifies difficult interpretational issues and provides a clear interpretation for the predictions of p-adic physics.

0.3.5 Dynamical quantized Planck constant and dark matter hierarchy

By quantum classical correspondence space-time sheets can be identified as quantum coherence regions. Hence the fact that they have all possible size scales more or less unavoidably implies that Planck constant must be quantized and have arbitrarily large values. If one accepts this then also the idea about dark matter as a macroscopic quantum phase characterized by an arbitrarily large value of Planck constant emerges naturally as does also the interpretation for the long ranged classical electro-weak and color fields predicted by TGD. Rather seldom the evolution of ideas follows simple linear

logic, and this was the case also now. In any case, this vision represents the fifth, relatively new thread in the evolution of TGD and the ideas involved are still evolving.

Dark matter as large \hbar phase

D. Da Rocha and Laurent Nottale [50] have proposed that Schrödinger equation with Planck constant \hbar replaced with what might be called gravitational Planck constant $\hbar_{gr} = \frac{GmM}{v_0}$ ($\hbar = c = 1$). v_0 is a velocity parameter having the value $v_0 = 144.7 \pm .7$ km/s giving $v_0/c = 4.6 \times 10^{-4}$. This is rather near to the peak orbital velocity of stars in galactic halos. Also subharmonics and harmonics of v_0 seem to appear. The support for the hypothesis coming from empirical data is impressive.

Nottale and Da Rocha believe that their Schrödinger equation results from a fractal hydrodynamics. Many-sheeted space-time however suggests astrophysical systems are not only quantum systems at larger space-time sheets but correspond to a gigantic value of gravitational Planck constant. The gravitational (ordinary) Schrödinger equation would provide a solution of the black hole collapse (IR catastrophe) problem encountered at the classical level. The resolution of the problem inspired by TGD inspired theory of living matter is that it is the dark matter at larger space-time sheets which is quantum coherent in the required time scale [D6].

Already before learning about Nottale's paper I had proposed the possibility that Planck constant is quantized [E9] and the spectrum is given in terms of logarithms of Beraha numbers: the lowest Beraha number B_3 is completely exceptional in that it predicts infinite value of Planck constant. The inverse of the gravitational Planck constant could correspond a gravitational perturbation of this as $1/\hbar_{gr} = v_0/GMm$. The general philosophy would be that when the quantum system would become non-perturbative, a phase transition increasing the value of \hbar occurs to preserve the perturbative character and at the transition $n = 4 \rightarrow 3$ only the small perturbative correction to $1/\hbar(3) = 0$ remains. This would apply to QCD and to atoms with $Z > 137$ as well.

TGD predicts correctly the value of the parameter v_0 assuming that cosmic strings and their decay remnants are responsible for the dark matter. The harmonics of v_0 can be understood as corresponding to perturbations replacing cosmic strings with their n -branched coverings so that tension becomes n^2 -fold: much like the replacement of a closed orbit with an orbit closing only after n turns. $1/n$ -sub-harmonic would result when a magnetic flux tube split into n disjoint magnetic flux tubes. Also a model for the formation of planetary system as a condensation of ordinary matter around quantum coherent dark matter emerges [D6].

Dark matter as a source of long ranged weak and color fields

Long ranged classical electro-weak and color gauge fields are unavoidable in TGD framework. The smallness of the parity breaking effects in hadronic, nuclear, and atomic length scales does not however seem to allow long ranged electro-weak gauge fields. The problem disappears if long range classical electro-weak gauge fields are identified as space-time correlates for massless gauge fields created by dark matter. Also scaled up variants of ordinary electro-weak particle spectra are possible. The identification explains chiral selection in living matter and unbroken $U(2)_{ew}$ invariance and free color in bio length scales become characteristics of living matter and of bio-chemistry and bio-nuclear physics. An attractive solution of the matter antimatter asymmetry is based on the identification of also antimatter as dark matter.

p-Adic and dark matter hierarchies and hierarchy of moments of consciousness

Dark matter hierarchy assigned to a spectrum of Planck constant having arbitrarily large values brings additional elements to the TGD inspired theory of consciousness.

a) Macroscopic quantum coherence can be understood since a particle with a given mass can in principle appear as arbitrarily large scaled up copies (Compton length scales as \hbar). The phase transition to this kind of phase implies that space-time sheets of particles overlap and this makes possible macroscopic quantum coherence.

b) The space-time sheets with large Planck constant can be in thermal equilibrium with ordinary ones without the loss of quantum coherence. For instance, the cyclotron energy scale associated with EEG turns out to be above thermal energy at room temperature for the level of dark matter hierarchy corresponding to magnetic flux quanta of the Earth's magnetic field with the size scale of Earth and a successful quantitative model for EEG results [M3].

Dark matter hierarchy leads to detailed quantitative view about quantum biology with several testable predictions [M3]. The applications to living matter suggests that the basic hierarchy corresponds to a hierarchy of Planck constants coming as $\hbar(k) = \lambda^k(p)\hbar_0$, $\lambda \simeq 2^{11}$ for $p = 2^{127-1}$, $k = 0, 1, 2, \dots$ [M3]. Also integer valued sub-harmonics and integer valued sub-harmonics of λ might be possible. Each p-adic length scale corresponds to this kind of hierarchy and number theoretical arguments suggest a general formula for the allowed values of Planck constant λ depending logarithmically on p-adic prime [C6]. Also the value of \hbar_0 has spectrum characterized by Beraha numbers $B_n = 4\cos^2(\pi/n)$, $n \geq 3$, varying by a factor in the range $n > 3$ [C6]. It must be however emphasized that the relation of this picture to the model of quantized gravitational Planck constant \hbar_{gr} appearing in Nottale's model is not yet completely understood.

The general prediction is that Universe is a kind of inverted Mandelbrot fractal for which each bird's eye of view reveals new structures in long length and time scales representing scaled down copies of standard physics and their dark variants. These structures would correspond to higher levels in self hierarchy. This prediction is consistent with the belief that 75 per cent of matter in the universe is dark.

1. *Living matter and dark matter*

Living matter as ordinary matter quantum controlled by the dark matter hierarchy has turned out to be a particularly successful idea. The hypothesis has led to models for EEG predicting correctly the band structure and even individual resonance bands and also generalizing the notion of EEG [M3]. Also a generalization of the notion of genetic code emerges resolving the paradoxes related to the standard dogma [L2, M3]. A particularly fascinating implication is the possibility to identify great leaps in evolution as phase transitions in which new higher level of dark matter emerges [M3].

It seems safe to conclude that the dark matter hierarchy with levels labelled by the values of Planck constants explains the macroscopic and macro-temporal quantum coherence naturally. That this explanation is consistent with the explanation based on spin glass degeneracy is suggested by following observations. First, the argument supporting spin glass degeneracy as an explanation of the macro-temporal quantum coherence does not involve the value of \hbar at all. Secondly, the failure of the perturbation theory assumed to lead to the increase of Planck constant and formation of macroscopic quantum phases could be precisely due to the emergence of a large number of new degrees of freedom due to spin glass degeneracy. Thirdly, the phase transition increasing Planck constant has concrete topological interpretation in terms of many-sheeted space-time consistent with the spin glass degeneracy.

2. *Dark matter hierarchy and the notion of self*

The vision about dark matter hierarchy leads to a more refined view about self hierarchy and hierarchy of moments of consciousness [J6, M3]. The larger the value of Planck constant, the longer the subjectively experienced duration and the average geometric duration $T(k) \propto \lambda^k$ of the quantum jump.

Quantum jumps form also a hierarchy with respect to p-adic and dark hierarchies and the geometric durations of quantum jumps scale like \hbar . Dark matter hierarchy suggests also a slight modification of the notion of self. Each self involves a hierarchy of dark matter levels, and one is led to ask whether the highest level in this hierarchy corresponds to single quantum jump rather than a sequence of quantum jumps. The averaging of conscious experience over quantum jumps would occur only for sub-selves at lower levels of dark matter hierarchy and these mental images would be ordered, and single moment of consciousness would be experienced as a history of events. The quantum parallel dissipation at the lower levels would give rise to the experience of flow of time. For instance, hadron as a macro-temporal quantum system in the characteristic time scale of hadron is a dissipating system at quark and gluon level corresponding to shorter p-adic time scales. One can ask whether even entire life cycle could be regarded as a single quantum jump at the highest level so that consciousness would not be completely lost even during deep sleep. This would allow to understand why we seem to know directly that this biological body of mine existed yesterday.

The fact that we can remember phone numbers with 5 to 9 digits supports the view that self corresponds at the highest dark matter level to single moment of consciousness. Self would experience the average over the sequence of moments of consciousness associated with each sub-self but there would be no averaging over the separate mental images of this kind, be their parallel or serial. These mental images correspond to sub-selves having shorter wake-up periods than self and would be experienced as

being time ordered. Hence the digits in the phone number are experienced as separate mental images and ordered with respect to experienced time.

3. *The time span of long term memories as signature for the level of dark matter hierarchy*

The simplest dimensional estimate gives for the average increment τ of geometric time in quantum jump $\tau \sim 10^4 CP_2$ times so that $2^{127} - 1 \sim 10^{38}$ quantum jumps are experienced during secondary p-adic time scale $T_2(k = 127) \simeq 0.1$ seconds which is the duration of physiological moment and predicted to be fundamental time scale of human consciousness [L1]. A more refined guess is that $\tau_p = \sqrt{p}\tau$ gives the dependence of the duration of quantum jump on p-adic prime p . By multi-p-fractality predicted by TGD and explaining p-adic length scale hypothesis, one expects that at least $p = 2$ -adic level is also always present. For the higher levels of dark matter hierarchy τ_p is scaled up by \hbar/\hbar_0 . One can understand evolutionary leaps as the emergence of higher levels at the level of individual organism making possible intentionality and memory in the time scale defined τ [L2].

Higher levels of dark matter hierarchy provide a neat quantitative view about self hierarchy and its evolution. For instance, EEG time scales corresponds to $k = 4$ level of hierarchy and a time scale of .1 seconds [J6], and EEG frequencies correspond at this level dark photon energies above the thermal threshold so that thermal noise is not a problem anymore. Various levels of dark matter hierarchy would naturally correspond to higher levels in the hierarchy of consciousness and the typical duration of life cycle would give an idea about the level in question.

The level would determine also the time span of long term memories as discussed in [M3]. $k = 7$ would correspond to a duration of moment of conscious of order human lifetime which suggests that $k = 7$ corresponds to the highest dark matter level relevant to our consciousness whereas higher levels would in general correspond to transpersonal consciousness. $k = 5$ would correspond to time scale of short term memories measured in minutes and $k = 6$ to a time scale of memories measured in days.

The emergence of these levels must have meant evolutionary leap since long term memory is also accompanied by ability to anticipate future in the same time scale. This picture would suggest that the basic difference between us and our cousins is not at the level of genome as it is usually understood but at the level of the hierarchy of magnetic bodies [L2, M3]. In fact, higher levels of dark matter hierarchy motivate the introduction of the notions of super-genome and hyper-genome. The genomes of entire organ can join to form super-genome expressing genes coherently. Hyper-genomes would result from the fusion of genomes of different organisms and collective levels of consciousness would express themselves via hyper-genome and make possible social rules and moral.

0.4 Bird's eye of view about the topics of the book

The topics of this book could be called fringe physics involving claimed phenomena which do not have explanation in terms of standard physics and are usually regarded as non-existing solely on this ground and by the fact that the proposed theories rather rarely satisfy the strict conceptual and technical standards of mathematical physics.

Many-sheeted space-time with p-adic length scale hierarchy, the predicted dark matter hierarchy with levels partially characterized by quantized dynamical Planck constant, and the prediction of long ranged color and weak forces, alone predict a vast variety of new physics effects. Zero energy ontology predicts that energy can have both signs. The dual view about time predicts that classical signals can also propagate in reversed time direction at negative energy space-time sheets and a highly attractive identification for negative energy signals would be as generalizations of phase conjugate laser beams. This vision leads to a coherent vision about metabolism, memory, and biocontrol and it is natural to ask whether the reported anomalies might after all reflect genuinely new physics which is also behind the proposed phenomena explaining the mother of all anomalies, the behavior of living matter.

1. The first class of effects involves coin words like antigravity, strong gravity, and electrogravity. This motivates the discussion of possible anomalous effects related to long range weak fields and many-sheeted gravitation. The strange effects associated with rotating magnetic systems, such as the dependence of the direction of generated radial electric field and corresponding charge density on direction of rotation (large parity breaking) observed already by Faraday, spontaneous acceleration, over unity energy production, and generation of plasma phase, and magnetic flux walls, are reported repeatedly and TGD indeed leads to a many-sheeted model for this involving also the notions of magnetic body and dark matter.

2. Tesla has become a god like character in free energy circles. One basis of his experimental experience Tesla did not believe that Maxwell's theory was an exhaustive description of electromagnetism. He claimed that experimental findings related to pulsed systems require the assumption of what he called scalar waves not allowed by Maxwell's electrodynamics. TGD however allows scalar wave pulses propagating with light velocity. The dropping of particles to larger space-time sheets liberating metabolic energy, transformation of ordinary charged matter to dark matter and vice versa, dark photons, etc... might be needed to really explain Tesla's findings. Also phase conjugate, possibly dark, photons making possible communications with geometric past might be involved.
3. The reports about ufos represent a further application for TGD based view about Universe. The presence of infinite self hierarchy represented by dark matter hierarchy makes it almost obvious that higher civilizations are here, there, and everywhere, and that their relationship to us is like that of our brain to its neurons, so that the well-known Fermi paradox (Where are they all?) would disappear. Although the space travel as we understand it might be quite too primitive idea for the civilizations at higher levels of hierarchy one can still consider the possibility whether the ufos might be real objects and represent more advanced technology rather than plasmoid like life forms serving as mediums in telepathic communications.

The seven online books about TGD [TGDview, TGDgeom, TGDquant, TGDnumber, TGDclass, TGDpad, TGDfree] and eight online books about TGD inspired theory of consciousness and quantum biology [TGDconsc, TGDselforg, TGDware, TGDholo, TGDgeme, TGDeeg, TGDmagn, 15] are warmly recommended for the reader willing to get overall view about what is involved.

0.5 The contents of the book

0.5.1 Anomalies related to the classical Z^0 force and gravitation

TGD based concept of space-time predicts several new effects.

1. The dark matter associated with rotating macroscopic objects should generate Z^0 magnetic fields and this suggests that the behavior of rotating objects should exhibit anomalies. A special signature of effects of this kind is parity breaking caused by the parity breaking couplings of the classical Z^0 field to dark matter. The Z^0 electric fields generated by astrophysical bodies are predicted to be completely negligible as compared to gravitational fields but the topological light rays carrying Z^0 fields could induce interactions over astrophysical distances. Z^0 fields in length scale below cell size are predicted to be quite strong as compared to gravitation.
2. The mere rotation of a 3-surface carrying magnetic or Z^0 magnetic fields should induce electric or Z^0 electric fields whose divergence gives rise to vacuum charge density. Charge conservation suggests that this gauge flux must flow to a second space-time sheet carrying opposite net charge.
3. In TGD the time orientation of given space-time sheet need not be the standard one and this allows the possibility of negative classical energies. If this kind of space-time sheets are created, energy production with apparent efficiency greater than unity becomes possible. At the space-time sheets with negative time orientations classical fields should propagate from future to past making in principle possible to see to the geometric future of, say, astrophysical objects. Amazingly, the highly science fictive notion of negative energy space-time sheet finds support from the basic classical physics. The total energy associated with the topological field quanta emitted by particle a condensed to larger space-time sheets is the natural geometric correlate of potential energy. Potential energy can be negative only if one allows also negative energy space-time sheets.
4. A further TGD based element is related to the fact that 3-surface can be regarded as a generalization of point like particle. This means that 3-surface behaves like single coherent whole: in particular, classical fields oscillating coherently in arbitrary long length scales are possible and can give rise to an apparent propagation of effects with infinite velocity. The notion of pair creation from vacuum generalizes. For instance, pairs of space-time sheets with vanishing total classical energy can be created from vacuum.

1. *Some gravitational anomalies*

1. TGD predicts the possibility of anomalously large time dilation effects due to the warping of space-time surfaces, and the experimental findings of Russian physicist Chernobrov about anomalous changes in the rate of flow of time provide indirect support for this prediction.
2. There are quite puzzling observations related to the behavior of rotating stars. These observations are in a dramatic conflict with the standard wisdom about finite propagation velocity of signals and with the idea that classical fields propagate in future direction only. The possibility of space-time sheets with negative time orientation and classical fields propagating from geometric future to geometric past plus the possibility that 3-surfaces of even astrophysical size can behave like particle like objects, could explain these mysterious effects.

2. *Anomalies related to Z^0 force in astrophysical length scales*

1. Allais observed that the oscillation plane of Foucault pendulum changes during solar eclipse. NASA performed the same experiment during 1999 eclipse but the processing of the data is still going on. The presence of moon could cause a modification of dark Z^0 laser beams emitted by Sun as synchrotron radiation and modify the contribution of Z^0 electric field to Z^0 force experienced by dark matter component of the pendulum. The effect is predicted to be observed only in the shadow of Moon created by Sun. Allais has observed also 24 and 25 hour periodicities in the oscillation of Foucault pendulum can be understood in terms of Earth's modification and the lengthening of the period associated with the Moon's screening due to the rotational motion of Moon around Earth.
2. Shnoll has shown that the rate distributions for radio active decays and chemical and biochemical processes do not converge to single bell curve but to distributions which have several pronounced peaks. The shapes of the rate curves seem to be similar for widely different reactions (radio-active decays, chemical and biochemical processes) but they fluctuate with time and fluctuation periods correspond to various astrophysical periods: day, month, year,... These anomalies can be understood if astrophysical objects emit Z^0 topological light rays interacting with ordinary matter (recall that already nuclei involve dark matter component).
3. p-Adic fractality predicts that dark Z^0 force should become comparable with the gravitational force in cell length scale. Tests of the Newtonian form of gravitational force are recently carried out in length scales 100 μm . There are anomalously large differences related to the measured values of gravitational constant using Cavendish type experiments or their variants. In the classical Cavendish experiment Z^0 force is effectively eliminated so that most of these discrepancies could be caused by the redistribution of the gravitational flux between space-time sheets.

0.5.2 The notion of free energy and many-sheeted space-time

In this chapter a general vision about new energy technologies provided by the new ontology forced by TGD is discussed, some evidence for the new ontology is considered, and models explaining some "free energy" anomalies are discussed.

There are close connections to the basic mechanisms of energy metabolism in living matter in TGD Universe and one cannot avoid even reference to TGD inspired quantum theory of consciousness. The point is that so called time mirror mechanism defines a mechanism of remote metabolism as sucking of energy from remote energy storage, a mechanism of memory as communications with geometric past, and mechanism of intentional action initiating neural activity in geometric past. At the level of technology time mirror mechanism would define a mechanism of energy transfer, communication, and remote quantum control.

1. *The new ontology*

The ontology of TGD Universe involves several new elements. The notion of many-sheeted space-time means that each physical system corresponds to a space-time sheet, its own sub-universe in geometric sense, and glued to a larger space-time sheet and containing subsystems as smaller space-time sheets glued to it. Many-sheeted space-time leads to the notion of field body distinguishing

between TGD and Maxwell's electrodynamics. One can assign to each physical system a field body (or magnetic body) and in case of living matter it acts as intentional agent using biological body as a sensory receptor and motor instrument.

Zero energy ontology states that any physical system has a vanishing net energy so that everything is creatable from vacuum. Zero energy states decompose into positive and negative energy parts. The possibility of negative energy signals is one important implication and a considerable modification of thermodynamics is forced by the fact that different signs of energy correspond to different arrows of geometric time.

Negative energy signals propagating to the geometric past inspire a new vision about communications, energy technology, and remote control. The implications are especially important for the understanding of living matter where both time directions manifest themselves. In neuroscience a radically new view about memory based on the notion of 4-D brain emerges.

The hierarchy of Planck constants implies a generalization of the notions of imbedding space and space-time and macroscopic quantum coherence in all length and time scales at high enough levels of dark matter hierarchy assigned to the hierarchy of Planck constant. The consequences of this hypothesis are powerful: entire cosmos should be in a well-defined sense a living system with dark matter representing higher level conscious entities.

The original motivation for the p-adic physics were the highly successful calculations of elementary particle masses based on p-adic thermodynamics and conformal invariance. The only sensible interpretation of p-adic physics seems to be as physics of cognition and intentionality meaning that cognition is present even at elementary particle level. This implies a profound generalization of space-time concept implying that cognition and intentionality are literally cosmic phenomena but having experimentally measurable correlates in real physics.

2. The new view about energy

The basic idea is that quantum biology could teach us a lot about energy technology. The necessity to carry fuel is one of the drawback of standard energy technologies. Remote metabolism based on sucking of energy by sending negative energy signals to energy storage analogous to a population inverted laser defines what might be called quantum credit card. This is the basic metabolic mechanism of TGD inspired quantum biology. The mechanism could make sense also as an energy technology.

In biological systems the fuel serves as an energy storage and is recycled. Animal cells burn the fuel and plant cells reconstruct it using sunlight as an energy source. Similar recycling of the fuel could make it un-necessary to carry large amounts of fuel. The systems doing the recycling could be seen as primitive life forms and plasmoids are an excellent candidate in this respect. Fuel could be practically any quantum system with two or more states with different energies.

Large Planck constant phases would make it possible to communicate short wave length photons over long distances: say photons with energy of visible photon but having wavelength of EEG photon. This might help to achieve a lossless energy transfer. Topological light rays ("massless extremals") would be in a key role in making possible precisely targeted, dispersion-free and lossless energy and information transfer. They are ideal also for quantum control.

3. Evidence for the new ontology

There are surprisingly many well established anomalies supporting the new ontology and these anomalies have been a strong guiding line in attempts to construct a general theoretical framework.

1. There is a considerable support for the notion many-sheeted space-time quantified in terms of p-adic length scale hypothesis. One example is the radiation from interstellar dust having no generally accepted interpretation in terms of molecular transitions. The interpretation in terms of metabolic energy quanta liberated in dropping of electrons or protons to larger space-time sheets makes sense quantitatively.
2. The Bohr quantization of radii of planetary orbits and quantal effects of ELF em fields on vertebrate brain helped considerably to develop the ideas about the hierarchy of Planck constants. Later a lot of further anomalies have emerged supporting the quantization of Planck constant.
3. Living matter is a gigantic bundle of anomalies from the point of view of recent day physics and the notion of field body combined with p-adic length scale hypothesis allows to develop detailed models for how magnetic body controls biological body and receives sensory input from it. The

notion of field body leads also to a concrete model for pre-biotic life based on the notion of plasmoid involving magnetic body controlling plasma phase. Recently a considerable empirical support for this notion has emerged.

4. Podkletnov- and Modanese-Podkletnov effects

The explanation of Modanese-Podkletnov effect shares many common elements with the model of Podkletnov effect and actually led to the correct track allowing to eliminate competing models.

The "dropping" of electrons to the space-time sheets of topological light rays emitted by a critical system would be the key mechanism besides rotation induced charging. During the discharge of the capacitor (Modanese-Podkletnov effect) this mechanism would induce the motion of test penduli. In the case of a super-conductor making repeatedly a transition to a non-super-conducting state (Podkletnov effect) this mechanism would induce the motion of air above super conductor and apparent loss of weight of test particles. Biefeld-Brown effect associated with lifters and corona wind can be explained by the same mechanism as Modanese-Podkletnov effect. Podkletnov effect is enhanced by the em and Z^0 charging induced by rotation and thus involves also the em and Z^0 variants of Searl effect.

5. Over unity effects

Over-unity effects are the basic claim of free energy research community. TGD indeed allows temporary over-unity effects: the basic mechanism is the dropping of particles on larger space-time sheets liberating zero point kinetic energy appearing as a basic metabolic mechanism in TGD inspired theory of living systems. This mechanism does not allow a perpetuum mobile: the particles must be kicked back to the smaller space-time sheets and in the ordinary living matter solar radiation takes care of this. There are also anomalies associated with the dissociation of water and hydrogen molecules. The hydrino atom concept of Mills is also closely related to these anomalies and TGD based justification for the notion is discussed in this chapter.

0.5.3 About strange effects related to rotating magnetic systems

In this chapter the anomalies claimed to be associated with rotating magnetic system are discussed in TGD based conceptual framework.

1. The anomalies associated with rotating magnetic systems

In the beginning of the year 2002 I learned about strange effects related to rotating magnetic systems, and the model for these effects has evolved (and is still evolving) gradually during the year 2002 via trial and error process. Several new physics effects seem to be involved.

1. The rotating magnetic system develops em and Z^0 charges and experiences the classical em and Z^0 electric forces created by Earth so that the effective weight is reduced or increases (depending on the direction of rotation) as much as 35 per cent. The charging is due to the flow of electrons and possibly also neutrinos from the rolling magnets to the surrounding air induced by the radial electric and Z^0 electric fields generated by the Faraday effect inducing vacuum charge density (not possible in Maxwell's electrodynamics). The fact that critical frequencies are different for clockwise and counter clockwise spontaneous rotation implies that classical Z^0 force and neutrino currents must be present.
2. The spontaneous accelerating rotation above critical frequency can be understood as being to a Lorentz torque acting on the radial Ohmic em and Z^0 currents in rollers and roller ring. Above the critical frequency the Lorentz torque, which is proportional to rotation frequency, becomes larger than frictional torque, and spontaneous accelerating rotation becomes possible due to the positive feedback. Energetic constraints imply negative feed back and the modelling of this "back reaction" leads to a model of the system based on butterfly catastrophe in Thom's classification of elementary catastrophes and allowing also to understand the effect of the load. Rather precise estimates for the parameters result and allow to quantify the role of the classical Z^0 force.
3. The radial ohmic current of electrons leaking from the atomic space-time sheets of rollers to the space-time sheet of environment explains the presence of plasma around the system. The

ionization of the molecules is caused by the electrons from rollers gaining keV energy as they drop from atomic space-time sheets of rollers to the space-time sheets of the environment.

4. The zero point kinetic energy liberated in the dropping of electrons serves as the energy source making the system an energy source. For instance, the emitted photon carrying zero point kinetic energy can be absorbed by the atom in the uppermost layer. This allows also to transfer the angular momentum gained by the conduction electron current to the roller so that accelerated rotation results. A remote metabolism based on the emission of negative energy (phase conjugate) dark microwave photons absorbed by the dropping electrons is the simplest mechanism providing energy for the magnetic walls and for electrons in collective cyclotron states. Also the remote transfer of angular momentum and remote spontaneous magnetization can be considered.
5. The latest progress relates to the understanding of the role of material decomposition of the Searl device (layered Nd-nylon-Fe-Ti structure. The model the current flow equilibrium for the 4-layered cylindrical structure gives detailed quantitative picture about how charge accumulates in the interiors of layers and to the layer-layer boundaries emerges. The key finding is that the small electrical conductivity of air requires in the flow equilibrium that the electric field at the outer boundary of titanium layer is amplified by a factor of order 10^8 to a field which is by a factor of order 10^3 higher than the critical field inducing dielectric breakdown in air so that the simple model fails. The huge increase of the electric field requires an accumulation of positive charge at Ti-air boundary and explains why the air must be ionized but not its mechanism based on the dropping of electrons to larger space-time sheets.

The four-layered structure is used also for the stator: this can be understood if the magnetic field of stator also rotates as is suggested by the fact that its return flux goes through the rollers. The rotation of the stator magnetic field leads to a simple model for the classical behavior of the roller system as a dynamical equilibrium in which the electrostatic torque generated by the rotation of the stator and roller charge distributions induced by Lorentz torque on conduction electrons vanishes as rollers rotate with the same velocity as the charge distribution in the stator.

6. The formation of the magnetic walls means the emergence of long length scale fluctuations with coherence length much longer than the size of the system. Hence a quantum critical phenomenon seems to be in question and this could explain why the replication of the experimental findings has turned out to be so difficult. There are indeed many conditions to be satisfied. The distance between magnetic walls must correspond to the radius of the stator in resonance. This length scale also corresponds to the wavelength of dark microwave photons emitted in cyclotron transitions and the energy of these photons must also correspond to a zero point kinetic energy liberated as electron drops to larger space-time sheet. The requirement that liberated zero point kinetic energy in the dropping of electron corresponds to the ionization energy of titanium atom for $n = 3$ valence electron makes also the phenomenon quantum critical.

2. Other anomalies involving Searl effect

The functioning of Tewari's space-energy generator and N-machine of DePalma can be understood as being based on same principles as the functioning of Searl device. Also other anomalies associated with spinning systems could be understood along similar lines so that the model for Searl device seems to have caught something essential.

0.5.4 Did Tesla discover the mechanism changing the arrow of time?

Negative energy topological light (phase conjugate laser waves) rays provide the fundamental control mechanism in the TGD based model of living matter and appears in practically every mechanism of consciousness as a basic step. This is however not yet the whole story. One should also identify mechanisms allowing to control the generation of the negative energy topological light rays: direct transformation of p-adic MEs to negative energy MEs is probably not enough.

The solution to the problem came from an quite unexpected direction. It was the attempt to understand the physics behind the visions of Tesla which led to an identification of a very general

mechanism of this kind. I had already earlier discovered that Tesla's scalar wave pulses can be realized as solutions of field equations in TGD framework but the physical interpretation had remained obscure.

In this chapter the general vision allowing to understand the findings of Tesla and others relating to binary coils and Tesla transformers are discussed. The basic idea is that the rapid acceleration of charges induced by scalar wave pulses induces generation of negative energy topological light rays as time reversed counterpart of brehmstrahlung. The solutions of field equations describing Tesla's scalar wave pulses are discussed first. The new physics associated with binary coils is discussed and a detailed model for binary coil and transformer using binary coil as a primary is constructed using the experimental input provided generously by Tapio Tammi. Various strange findings of Tesla are discussed at a general level using the resulting over all picture. The chapter ends with the model for the causal anomalies observed in the tunnelling of photons through potential barriers.

0.5.5 Ufos, aliens, and the new physics

The TGD based view about space-time, time and consciousness allows also to develop ideas about UFOs and aliens, in particular about possible manners by which highly developed civilizations could receive information about remote parts of the Universe and to get contact with other civilizations.

Time mirror mechanism is a basic mechanism in TGD inspired theory of consciousness and it has also technological applications including instantaneous remote sensing of geometric past, communications with geometric past, and instantaneous remote utilization of energy, and perhaps even remote induction of simple life forms, about which simplest are perhaps plasmoids. The intelligent looking light balls reported repeatedly by UFO experiencers are indeed identifiable as plasmoids and quite recent experimental findings demonstrate that plasmoids satisfy the basic criteria justifying their identification as simple life forms.

The resulting vision about highly developed life forms and about how they could study the Cosmos allows to resolve Fermi paradox summarized by the simple question "Where are they all?", and reflecting in excellent manner our misguided view about life, consciousness, and physics.

TGD suggests also a mechanism making possible to reduce gravitational and inertial masses of space-ships so that they would behave like very light system as observations indeed suggest. Plasmoids could be living space-ships able to draw their energy from environment by the time mirror mechanism. It however seems that the highly developed civilizations would probably not see the trouble to travel to distant galaxies since it is un-necessary, and the finiteness of light velocity in any case would pose very strong limitations on what they could achieve in this manner.

Chilbolton and Crabwood crop circles can be interpreted as messages telling basic facts about the civilization responsible for their construction. Chilbolton message is constructed using the same format as Arecibo message and tells that both Earth, Mars, and Jupiter are colonized. These crop circles suggest strongly the existence of intra-terrestrial life and this inspired a model for pre-biotic evolution allowing also a model for the evolution of genetic code. The highly advanced civilization could be identified as either intelligent intra-terrestrials or as ourselves in the geometric future using a technology based on time mirror mechanism to construct crop circles and using less intelligent intra-terrestrial plasmoids to construct the crop circles. Sun is depicted to have a smaller size as in Arecibo message, and Crabwood message came one year and one day after the Chilbolton message: these hints allow to make estimate about the temporal distance of this civilization of the geometric future from us.

The "sacred geometry" of crop circles involving ratios of simple rational numbers, simple algebraic numbers (in particular Golden Mean), and π , could be an attempt to tell us about the crucial importance of rational numbers and finite-dimensional extensions of p-adic numbers for cognition. If entanglement probabilities belong to an extension of rationals defining a finite-dimensional extension of p-adic numbers, one can assign to entanglement a positive information measure as a number theoretic modification of Shannon's entropy, and the interpretation as bound state entanglement crucial for macro-temporal quantum coherence is possible.

Bibliography

Online books about TGD

- [1] M. Pitkänen (2006), *Topological Geometroynamics: Overview*.
http://tgd.wippiespace.com/public_html/tgdview/tgdview.html.
- [2] M. Pitkänen (2006), *Quantum Physics as Infinite-Dimensional Geometry*.
http://tgd.wippiespace.com/public_html/tgdgeom/tgdgeom.html.
- [3] M. Pitkänen (2006), *Physics in Many-Sheeted Space-Time*.
http://tgd.wippiespace.com/public_html/tgdclass/tgdclass.html.
- [4] M. Pitkänen (2006), *Quantum TGD*.
http://tgd.wippiespace.com/public_html/tgdquant/tgdquant.html.
- [5] M. Pitkänen (2006), *TGD as a Generalized Number Theory*.
http://tgd.wippiespace.com/public_html/tgdnumber/tgdnumber.html.
- [6] M. Pitkänen (2006), *p-Adic length Scale Hypothesis and Dark Matter Hierarchy*.
http://tgd.wippiespace.com/public_html/paddark/paddark.html.
- [7] M. Pitkänen (2006), *TGD and Fringe Physics*.
http://tgd.wippiespace.com/public_html/freenergy/freenergy.html.

Online books about TGD inspired theory of consciousness and quantum biology

- [8] M. Pitkänen (2006), *Bio-Systems as Self-Organizing Quantum Systems*.
http://tgd.wippiespace.com/public_html/bioselforg/bioselforg.html.
- [9] M. Pitkänen (2006), *Quantum Hardware of Living Matter*.
http://tgd.wippiespace.com/public_html/bioware/bioware.html.
- [10] M. Pitkänen (2006), *TGD Inspired Theory of Consciousness*.
http://tgd.wippiespace.com/public_html/tgdconsc/tgdconsc.html.
- [11] M. Pitkänen (2006), *Mathematical Aspects of Consciousness Theory*.
http://tgd.wippiespace.com/public_html/genememe/genememe.html.
- [12] M. Pitkänen (2006), *TGD and EEG*.
http://tgd.wippiespace.com/public_html/tgdeeg/tgdeeg/tgdeeg.html.
- [13] M. Pitkänen (2006), *Bio-Systems as Conscious Holograms*.
http://tgd.wippiespace.com/public_html/hologram/hologram.html.
- [14] M. Pitkänen (2006), *Magnetospheric Consciousness*.
http://tgd.wippiespace.com/public_html/magnconsc/magnconsc.html.
- [15] M. Pitkänen (2006), *Mathematical Aspects of Consciousness Theory*.
http://tgd.wippiespace.com/public_html/magnconsc/mathconsc.html.

References to the chapters of books

- [C6] The chapter *Was von Neumann Right After All* of [TGDquant].
http://tgd.wippiespace.com/public_html/tgdquant/tgdquant.html#vNeumann.
- [D6] The chapter *TGD and Astrophysics* of [TGDclass].
http://tgd.wippiespace.com/public_html/tgdclass/tgdclass.html#astro.
- [E1] The chapter *TGD as a Generalized Number Theory: p-Adicization Program* of [TGDnumber].
http://tgd.wippiespace.com/public_html/tgdnumber/tgdnumber.html#visiona.
- [E2] The chapter *TGD as a Generalized Number Theory: Quaternions, Octonions, and their Hyper Counterparts* of [TGDnumber].
http://tgd.wippiespace.com/public_html/tgdnumber/tgdnumber.html#visionb.
- [E3] The chapter *TGD as a Generalized Number Theory: Infinite Primes* of [TGDnumber].
http://tgd.wippiespace.com/public_html/tgdnumber/tgdnumber.html#visionc.
- [E9] The chapter *Topological Quantum Computation in TGD Universe* of [TGDnumber].
http://tgd.wippiespace.com/public_html/tgdnumber/tgdnumber.html#tqc.
- [I1] The chapter *Quantum Theory of Self-Organization* of [TGDselforg].
http://tgd.wippiespace.com/public_html/bioselforg/bioselforg.html#selforgac.
- [J6] The chapter *Coherent Dark Matter and Bio-Systems as Macroscopic Quantum Systems* of [TGDware].
http://tgd.wippiespace.com/public_html/bioware/bioware.html#darkbio.
- [L1] The chapter *Genes and Memes* of [TGDgame].
http://tgd.wippiespace.com/public_html/genememe/genememe.html#genememec.
- [L2] The chapter *Many-Sheeted DNA* of [TGDgame].
http://tgd.wippiespace.com/public_html/genememe/genememe.html#genecodec.
- [M3] The chapter *Dark Matter Hierarchy and Hierarchy of EEGs* of [TGDeeg].
http://tgd.wippiespace.com/public_html/tgdeeg/tgdeeg/tgdeeg.html#eegdark.

Mathematics related references

- [16] Eguchi, T., Gilkey, B., Hanson, J. (1980): Phys. Rep. 66, 6.
- [17] Hawking, S.,W. and Pope, C., N. (1978): *Generalized Spin Structures in Quantum Gravity*. Physics Letters Vol 73 B, no 1.
- [18] Gibbons, G., W., Pope, C., N. (1977): *CP₂ as gravitational instanton*. Commun. Math. Phys. 55, 53.
- [19] Pope, C., N. (1980): *Eigenfunctions and Spin^c Structures on CP₂* D.A.M.T.P. preprint.
- [20] Eisenhart (1964): *Riemannian Geometry*. Princeton University Press.
- [21] Spivak, M. (1970): *Differential Geometry I,II,III,IV*. Publish or Perish. Boston.
- [22] Milnor, J. (1965): *Topology form Differential Point of View*. The University Press of Virginia.
- [23] Thom, R. (1954): Commentarii Math. Helvet., 28, 17.
- [24] Wallace (1968): *Differential Topology*. W. A. Benjamin, New York.
- [25] Freed, D., S. (1985): *The Geometry of Loop Groups*(Thesis). Berkeley: University of California.
- [26] Helgason, S. (1962): *Differential Geometry and Symmetric Spaces*. Academic Press, New York.

- [27] Mickelson, J. (1989): *Current Algebras and Groups*. Plenum Press, New York.
- [28] Jackiw, R. (1983): in *Gauge Theories of Eighties*, Conference Proceedings, Äkäslompolo, Finland (1982) Lecture Notes in Physics, Springer Verlag.
- [29] Manes, J., L. (1986): *Anomalies in Quantum Field Theory and Differential Geometry* Ph.D. Thesis LBL-22304.
- [30] Faddeev, L., D. (1984): *Operator Anomaly for Gauss Law*. Phys. Lett. Vol 145 B, no 1, 2.
- [31] J. Esmonde and M. Ram Murty (1991), *Problems in Algebraic Number Theory*, Springer-Verlag, New York.
- [32] A. Robinson (1974), *Non-standard Analysis*, North-Holland, Amsterdam.

Physics related references

- [33] Pitkänen, M. (1983) International Journal of Theor. Phys. ,22, 575.
- [34] H. Mueller, *Global Scaling*,
<http://www.dr-nawrocki.de/globalscalingengl2.html> .
- [35] D. Da Roacha and L. Nottale (2003), *Gravitational Structure Formation in Scale Relativity*, astro-ph/0310036.

Chapter 1

Anomalies Related to the Classical Z^0 Force and Gravitation

1.1 Introduction

The topic of this chapter are new physics effects related to long ranged Z^0 force, more generally weak forces, and gravitation in TGD Universe. Before summarizing these effects it is useful to sum up the basic interpretation of long ranged weak fields as space-time correlates of dark matter.

1.1.1 TGD based view about dark matter

TGD suggests an explanation of dark matter as a macroscopically quantum coherent phase residing at larger space-time sheets [J6].

1. TGD suggests that \hbar is dynamical and possesses a spectrum expressible in terms of generalized Beraha numbers $B_r = 4\cos^2(\pi/r)$, where $r > 3$ is a rational number [C6, J6]. Just above $r = 3$ arbitrarily large values of \hbar and thus also macroscopic quantum phases are possible. The criterion for transition to large \hbar phase is the failure of perturbative expansion so that Mother Nature takes care of the problems of theoretician. A good guess is that the criticality condition reads as $Q_1 Q_2 \alpha \simeq 1$ where Q_i are gauge charges and α gauge coupling strength. This leads to universal properties of the large \hbar phase. For instance, \hbar is scaled in the transition to dark phase by a harmonic or subharmonic of parameter $1/v_0 \simeq 2^{11}$ which is essentially the ratio of CP_2 length scale and Planck length [D6, J6]. The criticality condition can be applied also to dark matter itself and entire hierarchy of dark matters is predicted corresponding to the spectrum of values of \hbar .
2. The particles of dark matter can also carry phase carry complex conformal weights but the net conformal weights for blocks of this kind of dark matter would be real. This implies macroscopic quantum coherence.
3. An infinite hierarchy of dark matters is predicted [F6]. The basic hierarchy corresponds to the values of \hbar coming as $\lambda^m \hbar(1, m)$, $\lambda = v_0/n$, $v_0 \simeq 2^{11}$. $\hbar(1, m)$ corresponds to the values of \hbar labelled by Beraha numbers B_m . Second hierarchy corresponds to particles labelled by selected integers characterizing the p-adic length scales of particles with which the particle interacts. Direct interactions occur only between the particles characterized by integers having common p-adic prime factors characterizing the p-adic length scales of bosons exchanged in the interaction. The algebraic extensions of p-adic numbers define an additional hierarchy. Also the notion of darkness must be refined by attributes partial and relative.
4. From the point of view of nuclear physics application of this hypothesis is to QCD. The prediction is that the electromagnetic Compton sizes of dark quarks are scaled from $L(107)$ to about $2^{11}L(107) = L(129) = 2L(127)$, which is larger than the p-adic electromagnetic size of electron! The classical scattering cross sections are not changed but changes the geometric sizes of dark quarks, hadrons, and nuclei. The original hypothesis that ordinary valence quarks are dark

whereas sea quarks correspond to ordinary value of \hbar is taken as a starting point. In accordance with the earlier model, nucleons in atomic nuclei are assumed to be accompanied by color bonds connecting exotic quark and anti-quark characterized p-adic length scale $L(127)$ with ordinary value of \hbar and having thus scaled down mass of order MeV. The strong binding would be due the color bonds having exotic quark and anti-quark at their ends.

5. Quantum classical correspondence suggests that classical long ranged electro-weak gauge fields serve as classical space-time correlates for dark electro-weak gauge bosons, which are massless below the appropriate weak length scale L_w . This hypothesis could explain the special properties of bio-matter, in particular the chiral selection as resulting from the coupling to dark Z^0 quanta. Long range weak forces present in TGD counterpart of Higgs=0 phase should allow to understand the differences between biochemistry and the chemistry of dead matter.
6. For ordinary condensed matter quarks and leptons Z^0 charge are screened in electro-weak length scale whereas in dark matter $k = 89$ electro-weak space-time sheet have suffered a phase transition to a p-adic topology with a larger value of k . Gaussian Mersennes, in particular those associated with $k = 113, 151, 157, 163, 167$ are excellent candidates in this respect. The particles of this exotic phase of matter would have complex conformal weights closely related to the zeros of Riemann Zeta. The simplest possibility is that they correspond to a single non-trivial zero of Zeta and there is infinite hierarchy of particles of this kind.

In dark matter phase weak gauge fluxes could be feeded to say $k = k_Z = 169$ space-time sheet corresponding to neutrino Compton length and having size of cell. For this scenario to make sense it is essential that p-adic thermodynamics predicts for dark quarks and leptons essentially the same masses as for their ordinary counterparts [F3].

1.1.2 New Physics effects related to the new space-time concept

TGD based concept of space-time predicts several new effects.

1. The dark matter associated with rotating macroscopic objects should generate Z^0 magnetic fields and this suggests that the behavior of rotating objects should exhibit anomalies. A special signature of effects of this kind is parity breaking caused by the parity breaking couplings of the classical Z^0 field to dark matter. The Z^0 electric fields generated by astrophysical bodies are predicted to be completely negligible as compared to gravitational fields but the topological light rays carrying Z^0 fields could induce interactions over astrophysical distances. Z^0 fields in length scale below cell size are predicted to be quite strong as compared to gravitation.
2. The mere rotation of a 3-surface carrying magnetic or Z^0 magnetic fields should induce electric or Z^0 electric fields whose divergence gives rise to vacuum charge density. Charge conservation suggests that this gauge flux must flow to a second space-time sheet carrying opposite net charge.
3. In TGD the time orientation of given space-time sheet need not be the standard one and this allows the possibility of negative classical energies. If this kind of space-time sheets are created, energy production with apparent efficiency greater than unity becomes possible by time mirror mechanism [G2]. At the space-time sheets with negative time orientations classical fields should propagate from future to past making in principle possible to see to the geometric future of, say, astrophysical objects. Amazingly, the highly science fictive notion of negative energy space-time sheet finds support from the basic classical physics. The total energy associated with the topological field quanta emitted by particle and condensed to larger space-time sheets is the natural geometric correlate of potential energy. Potential energy can be negative only if one allows also negative energy space-time sheets.
4. A further TGD based element is related to the fact that 3-surface can be regarded as a generalization of a point like particle. This means that 3-surface behaves like single coherent whole: in particular, classical fields oscillating coherently in arbitrary long length scales are possible and can give rise to an apparent propagation of effects with infinite velocity. The notion of pair creation from vacuum generalizes. For instance, pairs of space-time sheets with vanishing total classical energy can be created from vacuum.

1.1.3 Some gravitational anomalies

1. TGD predicts the possibility of anomalously large time dilation effects due to the warping of space-time surfaces, and the experimental findings of Russian physicist Chernobrov about anomalous changes in the rate of flow of time [62, 63] provide indirect support for this prediction.
2. There are quite puzzling observations related to the behavior of rotating stars [33, 42]. These observations are in a dramatic conflict with the standard wisdom about finite propagation velocity of signals and with the idea that classical fields propagate in future direction only. The possibility of space-time sheets with negative time orientation and classical fields propagating from geometric future to geometric past plus the possibility that 3-surfaces of even astrophysical size can behave like particle like objects, could explain these mysterious effects.

1.1.4 Anomalies related to Z^0 force in astrophysical length scales

Allais [17, 18, 19, 20] observed that the oscillation plane of paraconic pendulum changes during solar eclipse. NASA performed the same experiment during 1999 eclipse but the processing of the data is still going on. The presence of moon could cause a modification of dark Z^0 laser beams emitted by Sun as synchrotron radiation and modify the contribution of Z^0 electric field to Z^0 force experienced by dark matter component of the pendulum. The effect is predicted to be observed only in the shadow of Moon created by Sun. Allais has observed also 24 and 25 hour periodicities in the oscillation of Foucault pendulum can be understood in terms of Earth's modification and the lengthening of the period associated with the Moon's screening due to the rotational motion of Moon around Earth.

Shnoll [19] has demonstrated that the rate distributions for radio active decays and chemical and biochemical processes do not converge to single bell curve as suggested by quantum randomness plus standard model but to distributions which have several pronounced peaks. The shapes of the rate curves seem to be similar for widely different reactions (radio-active decays, chemical and biochemical processes) but they fluctuate with time and fluctuation periods correspond to various astrophysical periods: day, month, year,... These anomalies can be also understood if astrophysical objects emit Z^0 topological light rays interacting with ordinary matter (recall that already nuclei involve dark matter component).

p-Adic fractality predicts that dark Z^0 force should become comparable with the gravitational force in cell length scale. Tests of the Newtonian form of gravitational force are recently carried out in length scales 100 μm . There are anomalously large differences related to the measured values of gravitational constant using Cavendish type experiments or their variants. In the classical Cavendish experiment Z^0 force is effectively eliminated so that most of these discrepancies could be caused by the redistribution of the gravitational flux between space-time sheets.

1.1.5 Anomalies related to rotating systems

If ordinary condensed matter involves a dark matter component generating long range Z^0 fields, one expects that rotating systems generate Z^0 magnetic fields. Spinning systems represent a spectrum of anomalies involving parity breaking. Hence the natural guess is that long ranged weak magnetic fields might be an essential aspect of the phenomenon. Rotating magnetic systems (Searl device) [49], the N-machine of DePalma [38] and the space-energy generator of Tewari [39], Podkletnov effect [70], and Modanese-Podkletnov effect [22] represent examples about situations in which long range Z^0 forces seem to be of importance. Since also other key mechanisms are involved, the discussion of these effects is left to the chapter "The Notion of Free Energy and Many-Sheeted Space-Time Concept" [G2].

I have emphasized that this and the two next chapters reflect the development of ideas and are a collection of pages of a lab notebook rather than a final summary. After the revolution induced by the ideas about dark matter and interpretation of long ranged electro-weak and color gauge fields a dramatic convergence has however occurred: the latest updating reduced the number of pages roughly by a factor of two and most alternative new physics explanations for various effects could be dropped from consideration. To my humble opinion, also the continual cumulation of anomalies understood in TGD framework gives convincing support for the TGD view. In view of the potential technological implications it is highly regrettable that the academic community has missed the boat so completely. There is however some light at the end of tunnel. The number of people working

with competing theories of quantum gravitation and admitting that these approaches are in grave difficulties is steadily increasing.

1.2 The new view about inertial and gravitational energy

TGD predicts the possibility of negative energy space-time sheets and phase conjugate photons can be identified as negative energy photons. If photons with negative energies are allowed, it is difficult to deny the possibility of fermions with negative energies. The possibility of having both signs of energy suggests an elegant solution to the problem of matter-antimatter asymmetry and a powerful new energy technology.

1. The standard second quantization of Dirac spinors postulates that ground state is annihilated by annihilation operators for fermions and anti-fermions. One can construct explicitly the state annihilated by annihilation operators. Suppose that there is state which is not annihilated by any annihilation operator and apply the product of all annihilation operators to this state. Electrons and positrons represent holes in this sea and are created by applying creation operators. The states have positive energy with respect to the ground state. The aesthetic problem of this quantization is that ground state has an infinitely high negative energy.
2. In TGD framework one could change the role of creation and annihilation operators so that the ground state would be obtained by applying the product of all creation operators to vacuum. This state would have infinite positive energy. Fermions and anti-fermions would be holes in Dirac sea of positive energy and behave as negative energy quanta. One might expect that these two quantizations correspond to two different time orientations for the space-time surface.

1.2.1 Two manners to circumvent the infinite vacuum energy

The infinite vacuum energy is definitely something very unsatisfactory, and one should overcome this problem somehow. The most elegant and predictive variant of TGD inspired cosmology assumes that the net energy of the Universe vanishes so that the universe could have been created intentionally from vacuum (and be created again and again in each quantum jump). The vanishing of the total energy follows automatically if one poses the condition that the energy flow through the light cone boundary ($H = M_+^4 \times CP_2$) vanishes. This requires that also fermionic vacuum energies cancel each other. There are two manners to achieve the cancellation.

1. If positive and negative energy space-time sheets are always created in a pairwise manner their vacuum energies could compensate each other, at least so if some additional conditions are satisfied. The success of elementary particle physics requires that this mechanism is at work in elementary particle length scales.
2. Vacuum energies could also cancel each other for each space-time sheet separately. This is achieved if the roles of creation and annihilation operators for either fermions or anti-fermions are exchanged. This implies automatically matter antimatter asymmetry since either fermions or anti-fermions would have negative energies. This option could be realized in long length scales and explain the absence of antimatter from the Universe as absence of positive energy antimatter. It would thus seem that all four ground states are in principle possible and that the ground state characterizes the phase of matter.

1.2.2 Zero energy vacuum is matter-antimatter asymmetric

Consider now in more detail the latter option 2) assuming for definiteness that it is anti-fermions for which the roles of creation and annihilation operators are exchanged. The ground state is obtained by applying the product of all fermion annihilation operators and anti-fermion creation operators to vacuum. Fermions represent holes in a completely filled negative energy Dirac sea and have positive energy. Anti-fermions represent holes in positive energy Dirac sea and have thus negative energy. In this ground state annihilation of photon pair is possible only to a fermion with positive and anti-fermion with negative energy.

Obviously the state is matter-antimatter asymmetric since anti-fermions cannot appear as positive energy holes. Negative energy antimatter could be present but could have remained invisible. For instance, Pauli Exclusion Principle would make the scattering of negative energy anti-fermions impossible in the case that there are not sufficiently many holes in the sea. The same occurs for condensed matter electrons below the surface of the Fermi sphere. Even in the case that negative energy anti-fermions are present abundantly, they might have escaped detection. Due to the prevailing dogmas, no-one has tried to detect signatures for the scattering of negative energy anti-fermions or two photon annihilation to a pair of positive energy fermion and negative energy anti-fermion.

1.2.3 Creation of matter from vacuum by annihilation of laser waves and their phase conjugates?

The possibility of negative energy anti-fermions suggests a new energy technology. Photons and their phase conjugates with opposite energies could only annihilate to a pair of positive energy fermion and negative energy anti-fermion. Vacuum could effectively serve as an unlimited source of positive energy and make creation of matter from nothing literally possible. The idea could be tested by allowing laser beams and their phase conjugates to interact and by looking whether fermions pop out via two-photon annihilation. Fermion-anti-fermion pairs with arbitrarily large fermion masses could be generated by utilizing photons of arbitrarily low energy. The energies of the final state fermion is completely fixed from conservation laws so that it should be relatively easy to check whether the process really occurs. Generalized Feynman rules predict the cross section for the process and it should behave as $\sigma \propto \alpha^2/m^2$, where m is the mass of the fermion so that annihilation to electrons is the best candidate for study. Bio-systems might have already invented intentional generation of matter in this manner. Certainly the possible new energy technology should be applied with some caution in order to not to build a new quasar!

1.2.4 Re-interpretation of TGD inspired cosmology

The proposed hypothesis challenges the basic interpretation of the TGD based cosmology [D5, D4] is derived from the consistency with General Relativity. The basic interpretational problem of TGD inspired cosmology has been that Robertson-Walker cosmologies represent vacuum extremals of the Kähler action. Einstein's equations are used to define the energy density of the cosmology. This is admittedly somewhat ad hoc procedure but forced by the Equivalence Principle and positivity of inertial masses.

The possibility of negative inertial masses leads to a profoundly new kind of interpretation of cosmology based on the hypothesis that gravitational mass is the absolute value of the inertial mass.

1. Vacuum property of R-W cosmologies means that negative and positive inertial energy densities cancel each other in the cosmological length scales. Gravitational mass represents the absolute value of the inertial mass so that Einstein tensor corresponds to the difference of the positive energy momentum current associated with matter and the negative energy momentum current antimatter (in the phase in which anti-fermions have negative energies). These currents are indeed uniquely defined in TGD Universe. The basic equations of the standard cosmology survive as such. If gravitational mass had the sign of the inertial mass, there would be a repulsion between matter and antimatter and the basic equations for cosmology would be altered dramatically: this looks implausible.
2. The fact that Einstein tensor is a tensor quantity whereas inertial mass density is a component of a vector field, favors strongly the new interpretation. The strong non-conservation of gravitational mass during early cosmology is not anymore inconsistent with Poincare invariance. Although the explanation for the non-conservation of the inertial mass in terms of a mass transfer between different space-time sheet becomes obsolete, the models for asymptotic cosmology and asymptotic evolution of star still make sense. The interpretation in terms of the conservation of gravitational mass resulting from the separate conservation of matter and antimatter energy densities since the annihilation of matter and antimatter and the reverse of this process do not occur appreciably anymore.

3. The mysterious vacuum extremals quite generally represent matter-antimatter symmetric states whereas non-vacuum extremals are by definition matter-antimatter asymmetric with the density of Kähler field energy identifiable as the net inertial energy density. This gives very strong grasp to the interpretation and technological application of the theory. In particular, highly curved vacuum extremals represent high energy densities of matter and antimatter, and the generation of this kind of space-time sheets followed by a generation of Kähler fields represent a creation of matter and antimatter from vacuum followed by the emission of particles or anti particles inducing the Kähler field. This would make possible a genuine engineering of the Universe.

The new view changes dramatically the interpretation of the early periods of cosmology although the basic equations for the density of gravitational mass are not changed.

1. Since cosmic strings are not vacuum extremals, they could represent a phase in which fermions and positrons have the same sign of energy, that is the phase of standard quantum field theories. The creation of the Universe from vacuum would mean generation of cosmic strings of opposite time orientations from vacuum during the first moments of cosmology. I have used the notion of "wormhole magnetic field" about pairs of space-time sheets carrying magnetic fields in opposite directions and having opposite time orientations [J5]. This terminology would be appropriate also now.
2. The topological condensation of cosmic strings to the background space-time sheets would induce a phase transition in which positive energy antimatter falls into negative energy states by emitting the difference energy as ordinary particles of positive or negative energy depending on the sign of time orientation. This process would replace the decay of the ends of split cosmic strings to elementary particles as a source of ordinary matter. Since Kähler magnetic flux is conserved in the process of thickening of the flux tubes, the magnetic energy density per unit length for topologically condensed cosmic strings decreases like $1/S$ (S is the area of cross section) in the process, and they become gradually magnetic or Z^0 magnetic flux tubes serving as templates for various structures. The emitted particles topologically condense at the background space-time and possess vanishing average inertial energy density in the length scales where cosmology applies.

Critical cosmology naturally represents this phase transition, and the breaking of Lorentz symmetry can be interpreted as being caused by the seed of the phase transition located at $r = 0$. With the conventional interpretation for the Einstein tensor, the recent cosmology of course poses strong lower bounds on the sizes of these regions but with the new interpretation the separation of matter and antimatter corresponds to the breaking of the Cosmological Principle (Lorentz invariance) due to the presence of non-vanishing Kähler fields.

3. The obvious question is whether there is some scale in which the induced Kähler fields vanish or possibly an entire hierarchy of these scales corresponding to p-adic length scale hierarchy. The model for large voids involves a "big" cosmic string at the center of the void carrying a non-vanishing and very high density of Kähler magnetic energy and Kähler charge whereas the cosmic strings at the boundaries of void would carry opposite Kähler charge. Could these two kinds of cosmic strings represent remnants of a primordial pair of cosmic strings with opposite time orientation? If this were the case, there would be a genuine separation of matter and antimatter in the scale of large voids.
4. The option for which gravitational masses have both signs, looks at first attractive because the gravitational repulsion between particles having gravitational masses of opposite sign could automatically lead to the separation of matter and antimatter containing regions. On the other hand, an antiparticle surrounded by matter would experience vanishing average acceleration so that the vanishing of energy density could occur in relatively short length scales.

One might even try to explain the observed acceleration of cosmic expansion in terms of this repulsion. p-Adic fractality however suggests an explanation as an apparent acceleration due to the fact that the average density of gravitational mass at larger space-time sheets representing longer p-adic length scales is lower, and the expansion occurs faster due to the weakening of the gravitational force. The notion of fractal energy density is somewhat questionable for a conserved inertial energy density in the presence of isotropy but makes sense for the density of the gravitational energy.

1.3 Some gravitational anomalies

In this section some exotic gravitational effects predicted by TGD are discussed. An infinite family of warped imbeddings of say Schwarzschild metric predicts the possibility of anomalous time dilation much larger than ordinary gravitational time dilation. There is indeed evidence for this kind of phenomenon [62]. Second exotic effect would be antigravity effects due to the redistribution of the gravitational flux feeded by system to larger space-time sheets. A third dramatic effect would be signals propagating in the direction of geometric past as negative energy signals. There is empirical evidence also for this effect [43].

1.3.1 Anomalous time dilation effects due to warping as basic distinction between TGD and GRT

TGD predicts the possibility of large anomalous time dilation effects due to the warping of space-time surfaces, and the experimental findings of Russian physicist Chernobrov about anomalous changes in the rate of flow of time [62, 63] provide indirect support for this prediction.

Anomalous time dilation effect due to the warping

Consider first the ordinary gravitational time dilation predicted by GRT. For simplicity consider a stationary spherically symmetric metric $ds^2 = g_{tt}dt^2 - g_{rr}dr^2 - r^2d\Omega^2$ in spherical coordinates. The time dilation is characterized by the difference $\Delta = \sqrt{g_{tt}} - 1$. In the weak field approximation one has $g_{tt} = 1 + 2\Phi_{gr}$, where Φ_{gr} is gravitational potential. The ordinary time dilation is given by $\Delta = \sqrt{g_{tt}} - 1 \simeq 2\Phi_{gr}$. At the Earth's surface the gravitational potential of the Earth is about $\Phi_{gr} = GM/R_E \simeq 10^{-9}$.

Consider next the situation for space-time surfaces. There exists an infinite number of warped imbeddings of M^4 to $M^4 \times CP_2$ given by $s^k = s^k(m^0)$, which are metrically equivalent with the canonical imbedding with CP_2 coordinates constant. New M^4 time coordinate is related by a diffeomorphism to the standard one. By restricting the imbedding to $M^4 \times S^1$, where S^1 a geodesic circle with radius $R/2$ (using the chosen convention for the definition CP_2 radius), the time component of the induced metric is $g_{m^0m^0} = 1 - R^2\omega^2/4$. The identification of M^4 coordinates as the preferred natural standard coordinate frame allows to overcome the difficulties related to the identification of the preferred time coordinate in general relativity in the case the metric does not approach asymptotically flat metric. For this choice an anomalous time dilation $\sqrt{1 - R^2\omega^2/4}$ due to the warping results even when gravitational fields are absent. Moreover, the dilation can be large.

The study of the imbeddings of Schwarzschild metric as vacuum extremals [D3] demonstrates that this vacuum warping is also seen as the degeneracy of the imbeddings of stationary spherically symmetric metrics. Denote the coordinates of M^4_+ by (m^0, r_M, θ, ϕ) and those of X^4 by (t, r_M, θ, ϕ) . The expression for the Reissner-Nordström metric reads as

$$\begin{aligned} ds^2 &= A dt^2 - B dr_M^2 - r_M^2 d\Omega^2 , \\ A &= 1 - \frac{a}{r_M} - \frac{b}{r_M^2} , \quad B = \frac{1}{A} , \\ a &= 2GM , \quad b = G\pi q^2 . \end{aligned} \tag{1.3.1}$$

The imbedding is given by the expression

$$\begin{aligned} \Phi &= \omega_1 t + f(r_M) , \\ \Psi &= k\Phi = \omega_2 t + kf(r_M) , \\ m^0 &= \lambda t + h(r_M) , \\ \lambda &= \sqrt{1 + \frac{R^2\omega_1^2}{4} s_{\Phi\Phi}^{eff}(\infty)} , \quad k = \frac{\omega_2}{\omega_1} . \end{aligned} \tag{1.3.2}$$

The components of s^{eff} depend on vacuum extremal. For the imbeddings to $M^4 \times S^2_{II}$, where S^2_{II} is homologically trivial geodesic sphere s_{eff} reduces to the metric $ds^2 = R^2 d\Omega^2/4$ of standard S^2 .

The functions $f(r_M)$ and $h(r_M)$ are determined by the condition

$$\lambda \partial_{r_M} h = \frac{R^2}{4} s_{\Phi\Phi}^{eff} \omega_1 \partial_{r_M} f \quad (1.3.3)$$

resulting from the requirement $g_{tr_M} = 0$ and from the expression for $g_{r_M r_M} = -B$:

$$\begin{aligned} h &= \int dr_M \sqrt{Y} \ , \ Y = \frac{Y_1}{Y_2} \ , \\ Y_1 &= -B + 1 + \frac{R^2}{4} s_{\Theta\Theta}^{eff} \frac{(\partial_{r_M} u)^2}{(1-u^2)} \ , \\ Y_2 &= 1 - \frac{4\lambda^2}{R^2 \omega_1^2} \frac{s_{\Theta\Theta}^{eff}}{s_{\Phi\Phi}^{eff}} \ . \end{aligned} \quad (1.3.4)$$

The condition $g_{tt} = 1$ at infinite distance implies the condition

$$\lambda^2 - \frac{R^2 \omega_1^2}{4} s_{\Phi\Phi}^{eff}(\infty) = 1 \ . \quad (1.3.5)$$

This condition fixes only the ratio λ/ω_1 so that a one-parameter family of analogs of warped imbeddings results.

If m^0 is used as a time coordinate, anomalous time dilation is obtained also at $r_M \rightarrow \infty$ and is given by

$$\sqrt{g_{m^0 m^0}} = \frac{1}{\lambda} \ . \quad (1.3.6)$$

This time dilation is seen only if the clocks to be compared are at different space-time sheets. The anomalous time dilation can be quite large since the order of magnitude for the parameter ωR is naturally of order one for the imbeddings of R-N metrics [D3].

Mechanisms producing anomalous time dilation

Anomalous time dilation could result in many manners.

1. An adiabatic variation of the parameters λ and ω_1 of the space-time sheet containing the clock could be induced by some physical mechanism. For instance, X_c^4 could move "over" a large space-time sheet X^4 and gradually form $\#$ and $\#_B$ contacts with it. Topological light rays (MEs) define a good candidate for X^4 . The parameter values λ and ω could change quasi-continuously if X_c^4 gradually generates CP_2 sized wormhole contacts or join along boundaries bonds connecting it to X^4 . This process would not affect the gravitational flux feeded to X_c^4 .

For instance, if X^4 is at rest with respect to Earth, this motion would result from the rotation of Earth and the effect should appear periodically from day to day. If it is at rest with respect to Sun, the effect should appear once a year.

The generation of vacuum extremals X_{vac}^4 (not gravitational vacua), which is in principle possible even by intentional action since conservation laws are not broken, could induce anomalous time dilation by this mechanism.

2. A phase transition increasing the value of \hbar increases the size of the space-time sheet in the same proportion. This transition could quite well affect also the parameter λ . If this phase transition occurs for the space-time sheet X_c^4 at which the clock feeds its gravitational flux, this mechanism could provide a feasible manner to induce an anomalous time dilation.
3. The system containing the clock could suffer a temporary topological condensation to a smaller space-time sheet and thus feed its gravitational flux to this space-time sheet. This would require coherently occurring splitting of $\#$ contacts and their regeneration. It is not possible to say anything definite about the probability of this kind of process except that it does not look very feasible.

The findings of Chernobrov

The findings claimed by Russian researcher V. Chernobrov support anomalous time dilation effect [62, 63]. Chernobrov has studied anomalies in the rate of time flow defined operationally by comparing the readings of clocks enclosed inside a spherical volume with the readings of clocks outside this volume. The experimental apparatus involves a complex Russian doll like structure of electromagnets.

Chernobrov reports a slowing down of time by about 30 seconds per hour inside his experimental apparatus [62] so that the average dilation factor during hour would be about $\Delta = 1/120$. If the dilation is present all the time, the anomalous contribution to the gravitational potential would be by a factor $\sim 10^7$ larger than that of Earth's gravitational potential and huge gravitational perturbations would be required to produce this kind of effect.

The slowing of the time flow is reported to occur gradually whereas the increase for the rate of time flow is reported to occur discontinuously. Time dilation effects were observed in connection with the cycles of moon, diurnal fluctuations, and even the presence of operator.

Consider now the explanation of the basic qualitative findings of Chernobrov.

1. The gradual slowing of the time flow suggests that the parameter values of λ and ω change adiabatically. This favors option 1) since the formation of # contacts occurs with some finite rate.
2. Also the sudden increase of the rate of time flow is consistent with option 1) since the splitting of # contacts occurs immediately when the sheets X_c^4 and X^4 are not "over" each other.
3. The occurrence of the effect in connection with the cycles of moon, diurnal fluctuations, and in the presence of operator support this interpretation. The last observation would support the view that intentional generation of almost vacuum space-time sheets is indeed possible.

Vacuum extremals as means of generating time dilation effects intentionally?

Field equations allow a gigantic family of vacuum extremals: any 4-surface having CP_2 projection, which belongs to a 2-dimensional Legendre manifold with a vanishing induced Kähler form, is a vacuum extremal. Canonical transformations and diffeomorphisms of CP_2 produce new vacuum extremals. Vacuum extremals carry non-vanishing classical electro-weak and color fields which are reduced to some $U(1)$ subgroup of the full gauge group and also classical gravitational field. Although the vacuum extremals are not absolute minima, their small deformations could define such. These vacuum extremals, call them X_{vac}^4 for brevity, could be generated by intentional action. In the first quantum jump the p-adic variant of the vacuum extremal representing an intention to create X_{vac}^4 would appear and in some subsequent quantum jump it would be transformed to a real space-time sheet.

The creation of these almost vacuum extremals could generate time dilation effects. The material system would gradually generate CP_2 sized wormhole contacts and/or join along boundaries connecting its space-time sheet to X_{vac}^4 and this could change the values of the vacuum parameters λ, ω .

1.3.2 Anomalies related to spinning astrophysical objects

Kozyrev [31] has conducted astronomical observations using a receiving system of a new type. These observations have been replicated later by other groups [33, 48].

1. When a telescope was directed at a certain star, the detector positioned within the telescope registered the incoming signal even if the main mirror of the telescope was shielded by metal screens. This indicated that electromagnetic waves were accompanied by some waves not shielded by the metal screens.
2. When the telescope was directed to the true position, the signal became stronger. As if there had been almost instantaneous propagation of signal with velocity billions times greater than the velocity of light.
3. When the telescope was directed to a position symmetrical with respect to visible position, again signal was detected: the imaginative interpretation was that the signal came from future position of the star!

Leaving aside the objections of a typical sceptic and the question whether the effect is real or not, one can ask whether the concepts of many-sheeted space-time concept and classical Z^0 field could somehow give rise to this kind of effect in strong conflict with conventional wisdom.

1. Very light dark gluons and electro-weak bosons (extremely tiny CP_2 type vacuum extremals glued to macroscopic space-time sheet) could have the propagating classical color and weak gauge fields, in particular Z^0 field, as a space-time correlate. This field can be said to cause the effect in the detector.
2. The strong signal from the true position could have explanation in terms of a coherent classical Z^0 field of astronomical size. This kind of coherence is forced by the imbeddability requirement and was coined as topological field quantization in [D7]. One can intuitively understand it as follows. In TGD elementary particle is replaced with 3-surface, which can have arbitrarily large size and absolute minimization of Kähler action forces 3-surface to behave coherently like single particle (in case that it does not so, it decomposes into disjoint components!).

The results of Kozyrev are not the only evidence for this kind of behavior. Total eclipses of the Sun by the Moon reach maximum eclipse about 40 seconds before Sun's and Moon's gravitational forces on Earth align [50]. If gravity is a propagating force, this 3-body test implies that gravity propagates at least 20 times faster than light. The result is consistent with the assumption that the acceleration of Earth is towards the true instantaneous direction of the Sun now, rather than being parallel to the direction of the arriving solar photons now. TGD based explanation is that the changes of the classical gravitational field are not propagating effects but that the classical gravitational field behaves like single coherent whole (it could of course contain also small propagating part).

3. The signal in the symmetric position could come from geometric future. Only classical gauge fields can carry this kind of signal. One possibility is that classical fields generated by astronomical object propagate in both future and past. A more attractive possibility is that classical Z^0 field propagated along space-time sheet with negative time orientation: for negative time orientation the propagation is expected to occur backwards in time.

This picture is in accordance with the TGD based explanation for the poorly understood observations of Faraday, for the functioning of Searl machine [49], and for the claim that the efficiency of DePalma generator [38] and space energy generator of Tewari [39] could be apparently larger than one. Thus a general pattern behind the anomalies seems to emerge.

1. The basic idea is that space-time sheets with negative time orientation have negative sign of classical energy: this follows solely from the assumption that space-time is 4-surface.
2. The rotating 3-surface associated with the rotating conductor carries vacuum charge density and charge conservation requires the presence of a space-time sheet with opposite sign of charge density. If the time orientation of this space-time sheet is negative, it has negative classical energy and energy conservation requires that material space-time sheet has correspondingly larger energy, which in principle makes possible energy production with apparent efficiency larger than one. The actual mechanism of energy gain would be however time mirror mechanism. The system generates negative energy bosons (phase conjugate laser beams having topological light rays as space-time correlates) received by another system analogous to a population inverted laser. A phase transition like transition to the round state is thus induced and strong beam of positive energy bosons is emitted and received by the sender of the negative energy signal. This mechanism is discussed in detail in the chapter "The Notion of Free Energy and Many-Sheeted Space-Time Concept" [G2].
3. Stars are rapidly rotating objects carrying magnetic and Z^0 magnetic fields and somewhat like scaled up versions of Searl machine and this suggests that vacuum charge density and space-time sheet with negative time orientation are generated also in this case.

1.4 Is electro-gravity possible in TGD framework?

The interpretation of the classical gravitational fields has been one of the messy parts of TGD.

1. When I started to develop TGD, the only reasonable guess was that they really correspond to the measured gravitational fields. There is however an objection against this interpretation. First of all, only a very limited repertoire of space-time metrics can be imbedded as induced metrics in $H = M_+^4 \times CP_2$. Already rotating black-hole metrics are impossible to imbed and imbedding would require hundreds of imbedding space dimensions in the general case.
2. Much later it became clear that all elementary particles, with gravitons included, correspond to CP_2 type extremals which are the TGD counterparts of strings (TGD of course allows also cosmic strings). The exchange of these gravitons gives rise to the gravitational interactions. The space-time metric of Einstein's general relativity is only the effective metric associated with coherent states of gravitons. Thus the classical gravitational field, and also classical gauge fields, seem to be something completely new, not encountered in theories in which particles are point like objects or strings. This interpretation resolves nicely the objection related to the imbeddability constraints.
3. A further step of progress came when I learned about the work of R. Y. Chiao about superconductors as transducers and antennas for gravitational and electromagnetic radiation [64]. The realization was that the non-relativistic limit for gravitational fields allowing to interpret Riemann connection as a Maxwellian field provides surprisingly good understanding of the classical gravitation in TGD Universe and allows also a new model for Podkletnov effect. This work encouraged to take seriously the hypothesis that classical Kähler fields couples to classical gravitational field with a strength which is about $R^2/G \sim 10^7$ times stronger than ordinary gravitational coupling constant strength (R is CP_2 size). Skeptic would of course argue that the results represents a fatal internal inconsistency of the theory: CP_2 size must be given by Planck length. This however leads to non-sensible predictions. Now I agree with the skeptic.
4. Only the realization that all net quantum numbers, in particular inertial (Poincare) energy of the Universe vanish, and that gravitational momentum is difference of inertial momenta of positive and negative energy matter, led to the resolution of various mysteries revolving around the notion of energy and gravitational mass. In particular, the puzzle of too large gravitational constant finds a nice resolution. The gravitational constant deduced from Maxwellian approximation represents coupling to inertial rather than gravitational mass. If inertial mass is a fraction of about 10^{-7} about gravitational mass for the special kind of extremals studied, inconsistency disappears, and one can interpret the results as cancellation of net inertial energy density to accuracy of 10^{-7} for the extremals in question. Equivalence Principle in Einstein's form holds true only in the limit that matter consists dominantly of positive or negative energy matter or the interaction between two can be neglected and when gravitational mass is conserved. Generation of vacuum extremals provides a basic mechanism leading to the breaking of this assumption.

1.4.1 Classical gravitational fields for space-time surfaces for which CP_2 projection corresponds to a homologically non-trivial geodesic sphere

In the previous picture the genuinely classical gravitational fields represent a completely new form of gravitational interaction and it is obviously highly interesting to try to understand something about the character of this interaction.

1. The space-time surfaces representable as sub-manifolds of $M_+^4 \times S^2$, S^2 geodesic sphere of CP_2 , are excellent testing ground for ideas. There are two kinds of geodesic spheres: the first one is homologically trivial and corresponds to a vacuum extremal for which induced Kähler form vanishes. Of course, any Legendre manifold Y^2 of CP_2 is as good as S^2 and the canonical transformations of CP_2 give an infinite variety of these manifolds. The second S^2 one is homologically nontrivial and for this induced Kähler form is non-vanishing. In both cases induced Abelian gauge fields are present and color rotations act as symmetries mixing classical em and Z^0 fields.

2. An especially interesting solution ansatz for S^2 is stationary solution ansatz. Standard linear M^4 coordinates (m^0, m^i) are the proper coordinates for X^4 in this case. For this ansatz the phase angle Φ of S^2 complex coordinate is linear in the time coordinate so that the induced metric and gauge fields do not depend on M^4 time m^0 .

$$\Phi = \omega m^0 + f(m^i) \quad , \quad \Theta = \Theta(m^i) \quad .$$

By explicitly writing out the expressions for the components of the induced metric and gauge field involving time as index one has

$$g_{00} = 1 - (R^2/4)\sin^2(\Theta)\omega^2 \quad , \quad g_{0i} = (R^2/4)\sin^2(\Theta)\omega\partial_i f \quad . \quad (1.4.1)$$

$$F_{0i} = k\sin(\Theta)\omega\partial_i\Theta \quad .$$

Here k is some numerical constant of order unity depending on the imbedding (gauge field can be in any direction in the gauge algebra of electro-weak gauge group and only Kähler field is invariant in color rotations).

If the spatial gradients of CP_2 coordinates satisfy the conditions $|\nabla\Theta| \ll \omega$ and $|\nabla\Phi| \ll \omega$, the deviations of g_{ij} from the flat 3-metric are small as compared to the components $g_{0\alpha}$, and one has what can be identified as a non-relativistic limit of the theory. Also the components of the magnetic field are small in consistency with the notion that magnetic fields are of order $O(v/c)$ as compared to electric fields in the non-relativistic limit.

Of course, the solutions form an extremely restricted set: for instance, electric and magnetic field are orthogonal to each other. On the other hand, absolute minimization of Kähler action is expected to select very limited set of field configurations and highly symmetric ones with electric field dominating are the favored ones. The study of this limit is especially revealing concerning the interpretation of the classical gravitational fields.

3. In the non-relativistic limit Einstein's theory reduces effectively to a Maxwellian theory with $g_{00} \equiv \Phi_g$ taking the role of the scalar potential of the gravito-electric field and $g_{ti} \equiv A_i$ taking the role of the components of the vector potential. Christoffel symbols represent gravitoelectric and gravito-magnetic fields and the components $(G^{00}, G^{0i}) \equiv (J_g^0, J_g^i)$ of the Einstein tensor represent four current (charge density and 3-current). This interpretation provides a very attractive phenomenological manner to understand the non-relativistic limit of the theory. The natural interpretation is as a dimensional reduction in which the theory reduces to a 3-dimensional gravitational theory coupled to gravito-Maxwell field so that the energy momentum current (J_g^0, J_g^i) becomes a gauge current. If the interpretation is correct, then three-dimensional Einstein equations should be satisfied in the sense that G^{ij} can be interpreted as the canonical energy momentum tensor for the gravito-Maxwellian field. The fact that this tensor is quadratic in $\nabla\Theta$ is consistent with this.
4. One can calculate explicitly gravito-Maxwellian field and one finds

$$E_{g,i} = \nabla_i g_{00} = (R^2\omega^2/2)\cos(\Theta)\nabla_i\cos(\Theta) \quad , \quad (1.4.2)$$

$$B_{g,ij} = (R^2\omega/2)\cos(\Theta) [\nabla_i\cos(\Theta)\nabla_j f - (i \leftrightarrow j)] \quad .$$

One can write the components of gravito-Maxwell fields in terms of the gauge potential components alone by noticing that the gauge potential $(F_{\mu\nu} = \nabla_\nu A_\mu - \nabla_\mu A_\nu)$ for the ordinary $U(1)$ gauge field is given by

$$A_0 = [-\cos(\Theta_0) + \cos(\Theta)]\omega \quad , \quad A_i = [-\cos(\Theta_0) + \cos(\Theta)]\nabla_i f \quad . \quad (1.4.3)$$

Here $\cos(\Theta_0) = -1$ holds true for a potential which is well defined around the south pole of S^2 and $\cos(\Theta_0) = 1$ for a potential well-defined around the north pole (monopole field is in question). $\cos(\Theta_0) = 0$ holds true for a potential defined in the region outside the northern and southern poles. The gravito-Maxwell fields are given by the expression

$$\begin{aligned} E_{g,i} &= (R^2/2) [A_0 + \cos(\Theta_0)\omega] E_i \ , \\ B_{g,ij} &= (R^2/2) [A_0 + \cos(\Theta_0)\omega] B_{ij} \ . \end{aligned} \tag{1.4.4}$$

The beautiful result is that gravito-Maxwell fields is related to the Maxwell field with a proportionality factor expressible in terms of the scalar potential. This finding gives strong support to the ideas about electro-gravity stating that classical electromagnetic fields are accompanied by strong gravitational fields. Note however that this result involves the assumption about coherence. If coherence is absent classical gauge fields and gravitational field can reside at different space-time sheets.

1.4.2 TGD does not predict anomalously large coupling of gravitation to classical gauge fields

The explicit calculation of the components of the Einstein tensor in the non-relativistic approximation (charge density and 3-current associated with E_g and G_g) gives a very nice result. (G^{00}, G^{0i}) are proportional to the corresponding components of the canonical energy momentum tensor of the Maxwell field plus the interaction term with four current in case that E and B give rise to non-vanishing vacuum charge density and current: this is quite possible in TGD framework. A good guess is that the divergence of G^{ij} gives rise to the spatial components of the Maxwellian energy momentum tensor and that Maxwell-Einstein equations are identically satisfied.

The calculation of the Einstein tensor also demonstrates that under the assumption that Equivalence Principle holds true the value of the gravitational constant is given by

$$G_{cl} = R^2 g^2 = R^2 \times 4\pi \times \alpha \tag{1.4.5}$$

where $\alpha = g^2/4\pi$ represents the effective gauge coupling of the $U(1)$ gauge field in question. This coupling enters because the induced gauge potential is gA_μ rather than A_μ by definition so that energy momentum density is proportional to $1/g^2$. p-Adic mass calculations fix the value of R^2 from electron mass scale and also a reasonable value for the string tension of cosmic strings implies $R^2 \sim 10^8 G$. Hence the value of G_{cl} is roughly $G_{cl} \sim 10^7 G$ in electromagnetic case and seven orders of magnitude stronger than the gravitational coupling associated with the graviton exchange.

The resolution of the puzzling result is simple. G_{cl} does not represent the coupling to gravitational but to inertial mass and the gravitational energy is the difference of gravitational energies of positive and negative energy matter. For the vacuum extremals the density of inertial mass vanishes whereas for non-vacuum extremals corresponding to the homologically non-trivial geodesic sphere the density of inertial mass is a fraction of about 10^{-7} of the density of gravitational mass.

Although the result as such kills the idea about strong gravity associated with the classical gauge fields, the implications of the result that classical fields are related to gravitational field in a very simple manner could be non-trivial. If TGD indeed predicts correctly the gravitational coupling associated with the exchange of CP_2 type extremals, then classical gauge fields associated with the physical systems can give additional very strong contribution to the gravitational field generated by the body. If one assumes that the classical gauge fields have as their sources ordinary matter (purely vacuum charge densities are not excluded), highly charged objects are expected to exhibit gravitational anomalies. Not only electro-gravity but also Z^0 gravity are possible: any $U(1)$ gauge field can define vacuum gravity. There are two basic situations: non-vacuum situation in which Kähler form is the natural gauge field and identifiable as being associated with the $U(1)$ factor of electro-weak gauge group and vacuum situation in which gauge field in is $SU(2)_L$ algebra. In the latter case the extremization does not pose any limitations to the imbedding but absolute minimization is expected to select small deformations of some extremals.

Also the general solutions of the field equations representable as maps from M^4 to CP_2 give additional contribution to the gravitational interaction. In this case it is however not clear whether the Einstein tensor allows a solution of Einstein's equations for some simple system.

1.4.3 Gravito-Maxwell field associated with a dipole field

A little explicit calculation modelling the Maxwell field as a dipole field demonstrates that the gravitational field has quadrupole character and that the additional mass associated with the disk is positive. This involves two delicate facts. Dipole gauge potential $A_0 \propto \bar{p} \cdot \bar{r}/r^3$ vanishes at the equator. One has

$$A_0 = [\cos(\Theta) + \cos(\Theta_0)]\omega = \frac{1}{4\pi} \frac{\bar{p} \cdot \bar{r}}{r^3} . \quad (1.4.6)$$

Gravito-Maxwell field is obtained from the dipole field by multiplying it with A_0 -factor.

1. For $\cos(\theta_0) = 0$ one obtains

$$\bar{E}_g = \frac{R^2}{2} A_0 \times \bar{E} = \frac{R^2}{2} \frac{p^2}{16\pi^2} \cos(\theta) \times [\bar{e}_z - 3\cos(\theta)\bar{e}_r] \frac{1}{r^5} .$$

Note that θ refers to the angle variable of M^4 spherical coordinates. Since A_0 -factor vanishes at the equator and has opposite sign above and below equator, one obtains quadrupole type gravito-Maxwell field and it is easy to verify that it can be interpreted as attractive gravitational field generated by the super-conductor. Note that the sign of the gravito-Maxwell field does not depend on the sign of the dipole moment nor on the sign of the frequency ω . The field in question behaves as $1/r^5$ so that the gravitational anomaly is only felt in the region near to the non-rotating super-conductor.

2. For $\cos(\theta_0) = \pm 1$ on opposite sides of the hemisphere one has

$$A_0 = \cos(\Theta)\omega = \epsilon\omega + \frac{1}{4\pi} \frac{\bar{p} \cdot \bar{r}}{r^3} . \quad (1.4.7)$$

The requirement that the potential is imbeddable for $r > d$ ($\cos(\Theta) \leq 1$), where d characterizes the source region (super-conductor), implies

$$|\omega| \geq \omega_{min} = \frac{|p|}{4\pi d^2} . \quad (1.4.8)$$

In this case one has

$$\bar{E}_g = \frac{R^2}{2} \frac{p}{4\pi} \left[\epsilon\omega + \frac{p\cos(\theta)}{4\pi r^2} \right] \times [\bar{e}_z - 3\cos(\theta)\bar{e}_r] \frac{1}{r^3} . \quad (1.4.9)$$

For $r^2 \gg p/(4\pi\omega)$ $\cos(\Theta)$ is effective constant and the behavior of the gravito-Maxwell field is in a good approximation

$$\bar{E}_g \simeq \frac{R^2}{2} \frac{p}{4\pi} \epsilon\omega \times [\bar{e}_z - 3\cos(\theta)\bar{e}_r] \frac{1}{r^3} . \quad (1.4.10)$$

The gravito-Maxwell field decreases as $1/r^3$ asymptotically for all values of θ . What is remarkable that even in the nearby region not too near to north and south pole it is possible to have a

situation in which the constant term is much larger than the dipole term in the potential. The field changes sign at the equator: this is consistent with the fact that gravitational field cannot be a dipole field and expresses the fact that equator effectively acts as a charged sheet carrying gravito-Maxwell charge density. It must be emphasized that the singular behavior is actually due to the monopole character of the gauge field in turn reflecting itself in the monopole character of Riemann connection and thus also of the gravito-Maxwell scalar potential.

Order of magnitude estimate using the acceleration in Earth's gravitational field as a comparison standard is in order.

1. Consider first di-electric. Let the size of the system be d and dipole strength $p = \alpha N d^3$, $N = \epsilon N_n x a$, N_n is the density of nuclei, ϵN_n the density of polarizable charge and $x a$ the distance between polarized charges in nucleus expressed using atomic radius as a unit.

This gives the order of magnitude estimate

$$\frac{E_g c^2}{g} \sim \frac{\alpha^2}{2} \epsilon^2 x^2 \frac{R^2 a^2 c^2}{g L^5} N_n^2 d^6 . \quad (1.4.11)$$

2. In the case of conducting sphere of radius r with dipole moment $p \sim Q d$, $\sigma \sim \epsilon N_n x a d^2$, with $x a$ denoting the thickness of surface charge layer on obtains the following estimate:

$$\frac{E_g c^2}{g} \sim \frac{\alpha^2}{2} \epsilon^2 x^2 \frac{R^2 a^2 c^2}{g L^5} N_n^2 d^6 . \quad (1.4.12)$$

The orders of magnitude are same. For $L = 1$ m, $d = .1$ m, $a = 10^{-10}$ m, $N_n = \frac{10^{30}}{A}/\text{m}^3$, A atomic number and using $g = 10$ m²/s, $R \sim 10^{-30}$ m, one has $\frac{E_g c^2}{g} \sim 10^{-14} \epsilon^2 x^2 / A^2$. Hence the effect on the gravitational field is very weak.

1.5 Allais effect and TGD

1.5.1 Introduction

Allais effect [67, 23] is a fascinating gravitational anomaly associated with solar eclipses. It was discovered originally by M. Allais, a Nobelist in the field of economy, and has been reproduced in several experiments but not as a rule. The experimental arrangement uses so called paraconical pendulum, which differs from the Foucault pendulum in that the oscillation plane of the pendulum can rotate in certain limits so that the motion occurs effectively at the surface of sphere.

Experimental findings

Consider first a brief summary of the findings of Allais and others [23].

1. In the ideal situation (that is in the absence of any other forces than gravitation of Earth) paraconical pendulum should behave like a Foucault pendulum. The oscillation plane of the paraconical pendulum however begins to rotate.
2. Allais concludes from his experimental studies that the orbital plane approach always asymptotically to a limiting plane and the effect is only particularly spectacular during the eclipse. During solar eclipse the limiting plane contains the line connecting Earth, Moon, and Sun. Allais explains this in terms of what he calls the anisotropy of space.

3. Some experiments carried out during eclipse have reproduced the findings of Allais, some experiments not. In the experiment carried out by Jeverdan and collaborators in Romania it was found that the period of oscillation of the pendulum decreases by $\Delta f/f \simeq 5 \times 10^{-4}$ [67, 24] which happens to correspond to the constant $v_0 = 2^{-11}$ appearing in the formula of the gravitational Planck constant. It must be however emphasized that the overall magnitude of $\Delta f/f$ varies by five orders of magnitude. Even the sign of $\Delta f/f$ varies from experiment to experiment.
4. There is also quite recent finding by Popescu and Olenici, which they interpret as a quantization of the plane of oscillation of paraconical oscillator during solar eclipse [25].

TGD based models for Allais effect

I have already earlier proposed an explanation of the effect in terms of classical Z^0 force. If the Z^0 charge to mass ratio of pendulum varies and if Earth and Moon are Z^0 conductors, the resulting model is quite flexible and one might hope it could explain the high variation of the experimental results.

The rapid variation of the effect during the eclipse is however a problem for this approach and suggests that gravitational screening or some more general interference effect might be present. Gravitational screening alone cannot however explain Allais effect. Also the combination of gravitational screening and Z^0 force assuming Z^0 conducting structures causing screening fails to explain the discontinuous behavior when massive objects are collinear.

A model based on the idea that gravitational interaction is mediated by topological light rays (MEs) and that gravitons correspond to a gigantic value of the gravitational Planck constant however explains the Allais effect as an interference effect made possible by macroscopic quantum coherence in astrophysical length scales. Equivalence Principle fixes the model to a high degree and one ends up with an explicit formula for the anomalous gravitational acceleration and the general order of magnitude and the large variation of the frequency change as being due to the variation of the distance ratio $r_{S,P}/r_{M,P}$ ($S, M,$ and P refer to Sun, Moon, and pendulum respectively). One can say that the pendulum acts as an interferometer.

1.5.2 Could gravitational screening explain Allais effect

The basic idea of the screening model is that Moon absorbs some fraction of the gravitational momentum flow of Sun and in this manner partially screens the gravitational force of Sun in a disk like region having the size of Moon's cross subsection. The screening is expected to be strongest in the center of the disk. Screening model happens to explain the findings of Jevardan but fails in the general case. Despite this screening model serves as a useful exercise.

Constant external force as the cause of the effect

The conclusions of Allais motivate the assumption that quite generally there can be additional constant forces affecting the motion of the paraconical pendulum besides Earth's gravitation. This means the replacement $\vec{g} \rightarrow \vec{g} + \Delta\vec{g}$ of the acceleration g due to Earth's gravitation. $\Delta\vec{g}$ can depend on time.

The system obeys still the same simple equations of motion as in the initial situation, the only change being that the direction and magnitude of effective Earth's acceleration have changed so that the definition of vertical is modified. If $\Delta\vec{g}$ is not parallel to the oscillation plane in the original situation, a torque is induced and the oscillation plane begins to rotate. This picture requires that the friction in the rotational degree of freedom is considerably stronger than in oscillatory degree of freedom: unfortunately I do not know what the situation is.

The behavior of the system in absence of friction can be deduced from the conservation laws of energy and angular momentum in the direction of $\vec{g} + \Delta\vec{g}$. The explicit formulas are given by

$$\begin{aligned} E &= \frac{ml^2}{2} \left(\frac{d\Theta}{dt} \right)^2 + \sin^2(\Theta) \left(\frac{d\Phi}{dt} \right)^2 + mgl \cos(\Theta) \ , \\ L_z &= ml^2 \sin^2(\Theta) \frac{d\Phi}{dt} \ . \end{aligned} \tag{1.5.1}$$

and allow to integrate Θ and Φ from given initial values.

What causes the effect in normal situations?

The gravitational accelerations caused by Sun and Moon come first in mind as causes of the effect. Equivalence Principle implies that only relative accelerations causing analogs of tidal forces can be in question. In GRT picture these accelerations correspond to a geodesic deviation between the surface of Earth and its center. The general form of the tidal acceleration would thus be the difference of gravitational accelerations at these points:

$$\Delta\bar{g} = -2GM\left[\frac{\Delta\bar{r}}{r^3} - 3\frac{\bar{r} \cdot \Delta\bar{r}\bar{r}}{r^5}\right]. \quad (1.5.2)$$

Here \bar{r} denotes the relative position of the pendulum with respect to Sun or Moon. $\Delta\bar{r}$ denotes the position vector of the pendulum measured with respect to the center of Earth defining the geodesic deviation. The contribution in the direction of $\Delta\bar{r}$ does not affect the direction of the Earth's acceleration and therefore does not contribute to the torque. Second contribution corresponds to an acceleration in the direction of \bar{r} connecting the pendulum to Moon or Sun. The direction of this vector changes slowly.

This would suggest that in the normal situation the tidal effect of Moon causes gradually changing force $m\Delta\bar{g}$ creating a torque, which induces a rotation of the oscillation plane. Together with dissipation this leads to a situation in which the orbital plane contains the vector $\Delta\bar{g}$ so that no torque is experienced. The limiting oscillation plane should rotate with same period as Moon around Earth. Of course, if effect is due to some other force than gravitational forces of Sun and Earth, paraconical oscillator would provide a manner to make this force visible and quantify its effects.

What would happen during the solar eclipse?

During the solar eclipse something exceptional must happen in order to account for the size of effect. The finding of Allais that the limiting oscillation plane contains the line connecting Earth, Moon, and Sun implies that the anomalous acceleration $\Delta|g$ should be parallel to this line during the solar eclipse.

The simplest hypothesis is based on TGD based view about gravitational force as a flow of gravitational momentum in the radial direction.

1. For stationary states the field equations of TGD for vacuum extremals state that the gravitational momentum flow of this momentum. Newton's equations suggest that planets and moon absorb a fraction of gravitational momentum flow meeting them. The view that gravitation is mediated by gravitons which correspond to enormous values of gravitational Planck constant in turn supports Feynman diagrammatic view in which description as momentum exchange makes sense and is consistent with the idea about absorption. If Moon absorbs part of this momentum, the region of Earth screened by Moon receives reduced amount of gravitational momentum and the gravitational force of Sun on pendulum is reduced in the shadow.
2. Unless the Moon as a coherent whole acts as the absorber of gravitational four momentum, one expects that the screening depends on the distance travelled by the gravitational flux inside Moon. Hence the effect should be strongest in the center of the shadow and weaken as one approaches its boundaries.
3. The opening angle for the shadow cone is given in a good approximation by $\Delta\Theta = R_M/R_E$. Since the distances of Moon and Earth from Sun differ so little, the size of the screened region has same size as Moon. This corresponds roughly to a disk with radius $.27 \times R_E$.

The corresponding area is 7.3 per cent of total transverse area of Earth. If total absorption occurs in the entire area the total radial gravitational momentum received by Earth is in good approximation 92.7 per cent of normal during the eclipse and the natural question is whether this effective repulsive radial force increases the orbital radius of Earth during the eclipse.

More precisely, the deviation of the total amount of gravitational momentum absorbed during solar eclipse from its standard value is an integral of the flux of momentum over time:

$$\begin{aligned}\Delta P_{gr}^k &= \int \frac{\Delta P_{gr}^k}{dt}(S(t))dt , \\ \frac{\Delta P_{gr}^k}{dt}(S(t)) &= \int_{S(t)} J_{gr}^k(t)dS .\end{aligned}\quad (1.5.3)$$

This prediction could kill the model in classical form at least. If one takes seriously the quantum model for astrophysical systems predicting that planetary orbits correspond to Bohr orbits with gravitational Planck constant equal to GMm/v_0 , $v_0 = 2^{-11}$, there should be not effect on the orbital radius. The anomalous radial gravitational four-momentum could go to some other degrees of freedom at the surface of Earth.

4. The rotation of the oscillation plane is largest if the plane of oscillation in the initial situation is as orthogonal as possible to the line connecting Moon, Earth and Sun. The effect vanishes when this line is in the initial plane of oscillation. This testable prediction might explain why some experiments have failed to reproduce the effect.
5. The change of $|\bar{g}|$ to $|\bar{g} + \Delta\bar{g}|$ induces a change of oscillation frequency given by

$$\frac{\Delta f}{f} = \frac{\bar{g} \cdot \Delta\bar{g}}{g^2} = \frac{\Delta g}{g} \cos(\theta) . \quad (1.5.4)$$

If the gravitational force of the Sun is screened, one has $|\bar{g} + \Delta\bar{g}| > g$ and the oscillation frequency should increase. The upper bound for the effect corresponds to vertical direction is obtained from the gravitational acceleration of Sun at the surface of Earth:

$$\frac{|\Delta f|}{f} \leq \frac{\Delta g}{g} = \frac{v_E^2}{r_E} \simeq 6.0 \times 10^{-4} . \quad (1.5.5)$$

6. One should explain also the recent finding by Popescu and Olenici, which they interpret as a quantization of the plane of oscillation of paraconical oscillator during solar eclipse [25]. A possible TGD based explanation would be in terms of quantization of $\Delta\bar{g}$ and thus of the limiting oscillation plane. This quantization should reflect the quantization of the gravitational momentum flux receiving Earth. The flux would be reduced in a stepwise manner during the solar eclipse as the distance traversed by the flux through Moon increases and reduced in a similar manner after the maximum of the eclipse.

What kind of tidal effects are predicted?

If the model applies also in the case of Earth itself, new kind of tidal effects are predicted due to the screening of the gravitational effects of Sun and Moon inside Earth. At the night-side the paraconical pendulum should experience the gravitation of Sun as screened. Same would apply to the "night-side" of Earth with respect to Moon.

Consider first the differences of accelerations in the direction of the line connecting Earth to Sun/Moon: these effects are not essential for tidal effects. The estimate for the ratio for the orders of magnitudes of the these accelerations is given by

$$\frac{|\Delta\bar{g}_\perp(Moon)|}{|\Delta\bar{g}_\perp(Sun)|} = \frac{M_S}{M_M} \left(\frac{r_M}{r_E}\right)^3 \simeq 2.17 . \quad (1.5.6)$$

The order or magnitude follows from $r(Moon) = .0026$ AU and $M_M/M_S = 3.7 \times 10^{-8}$. These effects are of same order of magnitude and can be compensated by a variation of the pressure gradients of

atmosphere and sea water. The effects caused by Sun are two times stronger. These effects are of same order of magnitude and can be compensated by a variation of the pressure gradients of atmosphere and sea water.

The tangential accelerations are essential for tidal effects. They decompose as

$$\frac{1}{r^3} \left[\Delta\bar{r} - 3|\Delta\bar{r}|\cos(\Theta)\frac{\bar{r}}{r} \right] .$$

$\pi/4 \leq \Theta \leq \pi/2$ is the angle between $\Delta\bar{r}$ and \bar{r} . The above estimate for the ratio of the contributions of Sun and Moon holds true also now and the tidal effects caused by Sun are stronger by a factor of two.

Consider now the new tidal effects caused by the screening.

1. Tangential effects on day-side of Earth are not affected (night-time and night-side are of course different notions in the case of Moon and Sun). At the night-side screening is predicted to reduce tidal effects with a maximum reduction at the equator.
2. Second class of new effects relate to the change of the normal component of the forces and these effects would be compensated by pressure changes corresponding to the change of the effective gravitational acceleration. The night-day variation of the atmospheric and sea pressures would be considerably larger than in Newtonian model.

The intuitive expectation is that the screening is maximum when the gravitational momentum flux travels longest path in the Earth's interior. The maximal difference of radial accelerations associated with opposite sides of Earth along the line of sight to Moon/Sun provides a convenient manner to distinguish between Newtonian and TGD based models:

$$\begin{aligned} |\Delta\bar{g}_{\perp,N}| &= 4GM \times \frac{R_E}{r^3} , \\ |\Delta\bar{g}_{\perp,TGD}| &= 4GM \times \frac{1}{r^2} . \end{aligned} \quad (1.5.7)$$

The ratio of the effects predicted by TGD and Newtonian models would be

$$\begin{aligned} \frac{|\Delta\bar{g}_{\perp,TGD}|}{|\Delta\bar{g}_{\perp,N}|} &= \frac{r}{R_E} , \\ \frac{r_M}{R_E} &= 60.2 , \quad \frac{r_S}{R_E} = 2.34 \times 10^4 . \end{aligned} \quad (1.5.8)$$

The amplitude for the oscillatory variation of the pressure gradient caused by Sun would be

$$\Delta|\nabla p_S| = \frac{v_E^2}{r_E} \simeq 6.1 \times 10^{-4} g$$

and the pressure gradient would be reduced during night-time. The corresponding amplitude in the case of Moon is given by

$$\frac{\Delta|\nabla p_s|}{\Delta|\nabla p_M|} = \frac{M_S}{M_M} \times \left(\frac{r_M}{r_S}\right)^3 \simeq 2.17 .$$

$\Delta|\nabla p_M|$ is in a good approximation smaller by a factor of 1/2 and given by $\Delta|\nabla p_M| = 2.8 \times 10^{-4} g$. Thus the contributions are of same order of magnitude.

M_M/M_S	M_E/M_S	R_M/R_E	d_{E-S}/AU	d_{E-M}/AU
3.0×10^{-6}	3.69×10^{-8}	.273	1	.00257
R_E/d_{E-S}	R_E/d_{E-M}	g_S/g	g_M/g	
4.27×10^{-5}	01.7×10^{-7}	6.1×10^{-4}	2.8×10^{-4}	

Table 1. The table gives basic data relevant for tidal effects. The subscript E, S, M refers to Earth, Sun, Moon; R refers to radius; d_{X-Y} refers to the distance between X and Y g_S and g_M refer to

accelerations induced by Sun and Moon at Earth surface. $g = 9.8 \text{ m/s}^2$ refers to the acceleration of gravity at surface of Earth. One has also $M_S = 1.99 \times 10^{30} \text{ kg}$ and $AU = 1.49 \times 10^{11} \text{ m}$, $R_E = 6.34 \times 10^6 \text{ m}$.

One can imagine two simple qualitative killer predictions assuming maximal gravitational screening.

1. Solar eclipse should induce anomalous tidal effects induced by the screening in the shadow of the Moon.
2. The comparison of solar and moon eclipses might kill the scenario. The screening would imply that inside the shadow the tidal effects are of same order of magnitude at both sides of Earth for Sun-Earth-Moon configuration but weaker at night-side for Sun-Moon-Earth situation.

An interesting co-incidence

The value of $\Delta f/f = 5 \times 10^{-4}$ in experiment of Jeverdan is exactly equal to $v_0 = 2^{-11}$, which appears in the formula $\hbar_{gr} = GMm/v_0$ for the favored values of the gravitational Planck constant. The predictions are $\Delta f/f \leq \Delta p/p \simeq 3 \times 10^{-4}$. Powers of $1/v_0$ appear also as favored scalings of Planck constant in the TGD inspired quantum model of bio-systems based on dark matter [M3]. This co-incidence would suggest the quantization formula

$$\frac{g_E}{g_S} = \frac{M_S}{M_E} \times \frac{R_E^2}{r_E^2} = v_0 \quad (1.5.9)$$

for the ratio of the gravitational accelerations caused by Earth and Sun on an object at the surface of Earth.

It must be however admitted that the larger variation in the magnitude and even sign of the effect does not favor this kind of interpretation.

Summary of the predicted new effects

Let us sum up the basic predictions of the model assuming maximal gravitational screening.

1. The first prediction is the gradual increase of the oscillation frequency of the conical pendulum by $\Delta f/f \leq 3 \times 10^{-4}$ to maximum and back during night-time in case that the pendulum has vanishing Z^0 charge. Also a periodic variation of the frequency and a periodic rotation of the oscillation plane with period co-inciding with Moon's rotation period is predicted. Already Allais observed both 24 hour cycle and cycle which is slightly longer and due to the fact that Moon rates around Earth.
2. A paraconical pendulum with initial position, which corresponds to the resting position in the normal situation should begin to oscillate during solar eclipse. This effect is testable by fixing the pendulum to the resting position and releasing it during the eclipse. The amplitude of the oscillation corresponds to the angle between \bar{g} and $\bar{g} + \Delta\bar{g}$ given in a good approximation by

$$\sin[\Theta(\bar{g}, \bar{g} + \Delta\bar{g})] = \frac{\Delta g}{g} \sin[\Theta(\bar{g}, \Delta\bar{g})] . \quad (1.5.10)$$

An upper bound for the amplitude would be $\Theta \leq 3 \times 10^{-4}$, which corresponds to .015 degrees. Z^0 charge of the pendulum would modify this simple picture.

3. Gravitational screening should cause a reduction of tidal effects at the "night-side" of Moon/Sun. The reduction should be maximum at "midnight". This reduction together with the fact that the tidal effects of Moon and Sun at the day side are of same order of magnitude could explain some anomalies know to be associated with the tidal effects [29]. A further prediction is the day-night variation of the atmospheric and sea pressure gradients with amplitude which is for Sun $3 \times 10^{-4}g$ and for Moon $1.3 \times 10^{-3}g$.

To sum up, the predicted anomalous tidal effects and the explanation of the limiting oscillation plane in terms of stronger dissipation in rotational degree of freedom could kill the model assuming only gravitational screening.

Comparison with experimental results

The experimental results look mutually contradictory in the context provided by the model assuming only screening. Some experiments find no anomaly at all as one learns from [67]. There are also measurements supporting the existence of an effect but with varying sign and quite different orders of magnitude. Either the experimental determinations cannot be trusted or the model is too simple.

1. The *increase* (!) of the frequency observed by Jeverdan and collaborators reported in Wikipedia article [67] for Foucault pendulum is $\Delta f/f \simeq 5 \times 10^{-4}$ would support the model even quantitatively since this value is only by a factor 5/3 higher than the maximal effect allowed by the screening model. Unfortunately, I do not have an access to the paper of Jeverdan *et al* to find out the value of $\cos(\Theta)$ in the experimental arrangement and whether there is indeed a decrease of the period as claimed in Wikipedia article. In [28] two experiments supporting an effect $\Delta g/g = x \times 10^{-4}$, $x = 1.5$ or 2.6 but the sign of the effect is different in these experiments.
2. Allais reported an anomaly $\Delta g/g \sim 5 \times 10^{-6}$ during 1954 eclipse [27]. According to measurements by authors of [28] the period of oscillation increases and one has $\Delta g/g \sim 5 \times 10^{-6}$. Popescu and Olenici report a decrease of the oscillation period by $(\Delta g/g)\cos(\Theta) \simeq 1.4 \times 10^{-5}$.
3. In [39] a *reduction* of vertical gravitational acceleration $\Delta g/g = (7.0 \pm 2.7) \times 10^{-9}$ is reported: this is by a factor 10^{-5} smaller than the result of Jeverdan.
4. Small pressure waves with $\Delta p/p = 2 \times 10^{-5}$ are registered by some micro-barometers [27] and might relate to the effect since pressure gradient and gravitational acceleration should compensate each other. $\Delta g \cos(\Theta)/g$ would be about 7 per cent of its maximum value for Earth-Sun system in this case. The knowledge of the sign of pressure variation would tell whether effective gravitational force is screened or amplified by Moon.

1.5.3 Allais effect as evidence for large values of gravitational Planck constant?

One can represent rather general counter arguments against the models based on Z^0 conductivity and gravitational screening if one takes seriously the puzzling experimental findings concerning frequency change.

1. Allais effect identified as a rotation of oscillation plane seems to be established and seems to be present always and can be understood in terms of torque implying limiting oscillation plane.
2. During solar eclipses Allais effect however becomes much stronger. According to Olenici's experimental work the effect appears always when massive objects form collinear structures.
3. The behavior of the change of oscillation frequency seems puzzling. The sign of the frequency increment varies from experiment to experiment and its magnitude varies within five orders of magnitude.

What one can conclude about general pattern for $\Delta f/f$?

The above findings allow to make some important conclusions about the nature of Allais effect.

1. Some genuinely new dynamical effect should take place when the objects are collinear. If gravitational screening would cause the effect the frequency would always grow but this is not the case.
2. If stellar objects and also ring like dark matter structures possibly assignable to their orbits are Z^0 conductors, one obtains screening effect by polarization and for the ring like structure the resulting effectively 2-D dipole field behaves as $1/\rho^2$ so that there are hopes of obtaining large

screening effects and if the Z^0 charge of pendulum is allow to have both signs, one might hope of being to able to explain the effect. It is however difficult to understand why this effect should become so strong in the collinear case.

3. The apparent randomness of the frequency change suggests that interference effect made possible by the gigantic value of gravitational Planck constant is in question. On the other hand, the dependence of $\Delta g/g$ on pendulum suggests a breaking of Equivalence Principle. It however turns out that the variation of the distances of the pendulum to Sun and Moon can explain the experimental findings since the pendulum turns out to act as a sensitive gravitational interferometer. An apparent breaking of Equivalence Principle could result if the effect is partially caused by genuine gauge forces, say dark classical Z^0 force, which can have arbitrarily long range in TGD Universe.
4. If topological light rays (MEs) provide a microscopic description for gravitation and other gauge interactions one can envision these interactions in terms of MEs extending from Sun/Moon radially to pendulum system. What comes in mind that in a collinear configuration the signals along S-P MEs and M-P MEs superpose linearly so that amplitudes are summed and interference terms give rise to an anomalous effect with a very sensitive dependence on the difference of S-P and M-P distances and possible other parameters of the problem. One can imagine several detailed variants of the mechanism. It is possible that signal from Sun combines with a signal from Earth and propagates along Moon-Earth ME or that the interferences of these signals occurs at Earth and pendulum.
5. Interference suggests macroscopic quantum effect in astrophysical length scales and thus gravitational Planck constants given by $\hbar_{gr} = GMm/v_0$, where $v_0 = 2^{-11}$ is the favored value, should appear in the model. Since $\hbar_{gr} = GMm/v_0$ depends on both masses this could give also a sensitive dependence on mass of the pendulum. One expects that the anomalous force is proportional to \hbar_{gr} and is therefore gigantic as compared to the effect predicted for the ordinary value of Planck constant.

Model for interaction via gravitational MEs with large Planck constant

Restricting the consideration for simplicity only gravitational MEs, a concrete model for the situation would be as follows.

1. The picture based on topological light rays suggests that the gravitational force between two objects M and m has the following expression

$$\begin{aligned}
 F_{M,m} &= \frac{GMm}{r^2} = \int |S(\lambda, r)|^2 p(\lambda) d\lambda \\
 p(\lambda) &= \frac{\hbar_{gr}(M, m) 2\pi}{\lambda} , \quad \hbar_{gr} = \frac{GMm}{v_0(M, m)} .
 \end{aligned} \tag{1.5.11}$$

$p(\lambda)$ denotes the momentum of the gravitational wave propagating along ME. v_0 can depend on (M, m) pair. The interpretation is that $|S(\lambda, r)|^2$ gives the rate for the emission of gravitational waves propagating along ME connecting the masses, having wave length λ , and being absorbed by m at distance r .

2. Assume that $S(\lambda, r)$ has the decomposition

$$\begin{aligned}
 S(\lambda, r) &= R(\lambda) \exp[i\Phi(\lambda)] \frac{\exp[ik(\lambda)r]}{r} , \\
 \exp[ik(\lambda)r] &= \exp[ip(\lambda)r/\hbar_{gr}(M, m)] , \\
 R(\lambda) &= |S(\lambda, r)| .
 \end{aligned} \tag{1.5.12}$$

The phases $\exp(i\Phi(\lambda))$ might be interpreted in terms of scattering matrix. The simplest assumption is $\Phi(\lambda) = 0$ turns out to be consistent with the experimental findings. The substitution of this expression to the above formula gives the condition

$$\int |R(\lambda)|^2 \frac{d\lambda}{\lambda} = v_0 . \quad (1.5.13)$$

Consider now a model for the Allais effect based on this picture.

1. In the non-collinear case one obtains just the standard Newtonian prediction for the net forces caused by Sun and Moon on the pendulum since $Z_{S,P}$ and $Z_{M,P}$ correspond to non-parallel MEs and there is no interference.
2. In the collinear case the interference takes place. If interference occurs for identical momenta, the interfering wavelengths are related by the condition

$$p(\lambda_{S,P}) = p(\lambda_{M,P}) . \quad (1.5.14)$$

This gives

$$\frac{\lambda_{M,P}}{\lambda_{S,P}} = \frac{\hbar_{M,P}}{\hbar_{S,P}} = \frac{M_M v_0(S,P)}{M_S v_0(M,P)} . \quad (1.5.15)$$

3. The net gravitational force is given by

$$\begin{aligned} F_{gr} &= \int |Z(\lambda, r_{S,P}) + Z(\lambda/x, r_{M,P})|^2 p(\lambda) d\lambda \\ &= F_{gr}(S, P) + F_{gr}(M, P) + \Delta F_{gr} , \\ \Delta F_{gr} &= 2 \int \text{Re} [S(\lambda, r_{S,P}) \bar{S}(\lambda/x, r_{M,P})] \frac{\hbar_{gr}(S, P) 2\pi}{\lambda} d\lambda , \\ x &= \frac{\hbar_{S,P}}{\hbar_{M,P}} = \frac{M_S v_0(M, P)}{M_M v_0(S, P)} . \end{aligned} \quad (1.5.16)$$

Here $r_{M,P}$ is the distance between Moon and pendulum. The anomalous term ΔF_{gr} would be responsible for the Allais effect and change of the frequency of the oscillator.

4. The anomalous gravitational acceleration can be written explicitly as

$$\begin{aligned} \Delta a_{gr} &= 2 \frac{GM_S}{r_S r_M} \frac{1}{v_0(S, P)} \times I , \\ I &= \int R(\lambda) R(\lambda/x) \cos \left[\Phi(\lambda) - \Phi(\lambda/x) + 2\pi \frac{(y_S r_S - x y_M r_M)}{\lambda} \right] \frac{d\lambda}{\lambda} , \\ y_M &= \frac{r_{M,P}}{r_M} , \quad y_S = \frac{r_{S,P}}{r_S} . \end{aligned} \quad (1.5.17)$$

Here the parameter y_M (y_S) is used express the distance $r_{M,P}$ ($r_{S,P}$) between pendulum and Moon (Sun) in terms of the semi-major axis r_M (r_S) of Moon's (Earth's) orbit. The interference term is sensitive to the ratio $2\pi(y_S r_S - x y_M r_M)/\lambda$. For short wave lengths the integral is expected to not give a considerable contribution so that the main contribution should come from long wave lengths. The gigantic value of gravitational Planck constant and its dependence on the masses implies that the anomalous force has correct form and can also be large enough.

5. If one poses no boundary conditions on MEs the full continuum of wavelengths is allowed. For very long wave lengths the sign of the cosine terms oscillates so that the value of the integral is very sensitive to the values of various parameters appearing in it. This could explain random looking outcome of experiments measuring $\Delta f/f$. One can also consider the possibility that MEs satisfy periodic boundary conditions so that only wave lengths $\lambda_n = 2r_S/n$ are allowed: this implies $\sin(2\pi y_S r_S/\lambda) = 0$. Assuming this, one can write the magnitude of the anomalous gravitational acceleration as

$$\begin{aligned} \Delta a_{gr} &= 2 \frac{GM_S}{r_{S,P} r_{M,P}} \times \frac{1}{v_0(S,P)} \times I , \\ I &= \sum_{n=1}^{\infty} R\left(\frac{2r_{S,P}}{n}\right) R\left(\frac{2r_{S,P}}{nx}\right) (-1)^n \cos \left[\Phi(n) - \Phi(xn) + n\pi \frac{xy_M}{y_S} \frac{r_M}{r_S} \right] . \end{aligned} \quad (1.5.18)$$

If $R(\lambda)$ decreases as λ^k , $k > 0$, at short wavelengths, the dominating contribution corresponds to the lowest harmonics. In all terms except cosine terms one can approximate $r_{S,P}$ resp. $r_{M,P}$ with r_S resp. r_M .

6. The presence of the alternating sum gives hopes for explaining the strong dependence of the anomaly term on the experimental arrangement. The reason is that the value of xy_M/r_S appearing in the argument of cosine is rather large:

$$\frac{xy_M}{y_S} \frac{r_M}{r_S} = \frac{y_M}{y_S} \frac{M_S}{M_M} \frac{r_M}{r_S} \frac{v_0(M,P)}{v_0(S,P)} \simeq 6.95671837 \times 10^4 \times \frac{y_M}{y_S} \times \frac{v_0(M,P)}{v_0(S,P)} .$$

The values of cosine terms are very sensitive to the exact value of the factor $M_S r_M / M_M r_S$ and the above expression is probably not quite accurate value. As a consequence, the values and signs of the cosine terms are very sensitive to the values of y_M/y_S and $\frac{v_0(M,P)}{v_0(S,P)}$.

The value of y_M/y_S varies from experiment to experiment and this alone could explain the high variability of $\Delta f/f$. The experimental arrangement would act like interferometer measuring the distance ratio $r_{M,P}/r_{S,P}$. Hence it seems that the condition

$$\frac{v_0(S,P)}{v_0(M,P)} \neq \text{const.} \quad (1.5.19)$$

implying breaking of Equivalence Principle is not necessary to explain the variation of the sign of $\Delta f/f$ and one can assume $v_0(S,P) = v_0(M,P) \equiv v_0$. One can also assume $\Phi(n) = 0$.

Scaling law

The assumption of the scaling law

$$R(\lambda) = R_0 \left(\frac{\lambda}{\lambda_0} \right)^k \quad (1.5.20)$$

is very natural in light of conformal invariance and masslessness of gravitons and allows to make the model more explicit. With the choice $\lambda_0 = r_S$ the anomaly term can be expressed in the form

$$\begin{aligned} \Delta a_{gr} &\simeq \frac{GM_S}{r_S r_M} \frac{2^{2k+1}}{v_0} \left(\frac{M_M}{M_S} \right)^k R_0(S,P) R_0(M,P) \times \sum_{n=1}^{\infty} \frac{(-1)^n}{n^{2k}} \cos [\Phi(n) - \Phi(xn) + n\pi K] , \\ K &= x \times \frac{r_M}{r_S} \times \frac{y_M}{y_S} . \end{aligned} \quad (1.5.21)$$

The normalization condition of Eq. 3.3.42 reads in this case as

$$R_0^2 = v_0 \times \frac{1}{2\pi \sum_n (\frac{1}{n})^{2k+1}} = \frac{v_0}{\pi\zeta(2k+1)} . \quad (1.5.22)$$

Note the shorthand $v_0(S/M, P) = v_0$. The anomalous gravitational acceleration is given by

$$\begin{aligned} \Delta a_{gr} &= \sqrt{\frac{v_0(M, P)}{v_0(S, P)} \frac{GM_S}{r_S^2}} \times XY \times \sum_{n=1}^{\infty} \frac{(-1)^n}{n^{2k}} \cos[\Phi(n) - \Phi(xn) + n\pi K] , \\ X &= 2^{2k} \times \frac{r_S}{r_M} \times \left(\frac{M_M}{M_S}\right)^k , \\ Y &= \frac{1}{\pi \sum_n (\frac{1}{n})^{2k+1}} = \frac{1}{\pi\zeta(2k+1)} . \end{aligned} \quad (1.5.23)$$

It is clear that a reasonable order of magnitude for the effect can be obtained if k is small enough and that this is essentially due to the gigantic value of gravitational Planck constant.

The simplest model consistent with experimental findings assumes $v_0(M, P) = v_0(S, P)$ and $\Phi(n) = 0$ and gives

$$\begin{aligned} \frac{\Delta a_{gr}}{g \cos(\Theta)} &= \frac{GM_S}{r_S^2 g} \times XY \times \sum_{n=1}^{\infty} \frac{(-1)^n}{n^{2k}} \cos(n\pi K) , \\ X &= 2^{2k} \times \frac{r_S}{r_M} \times \left(\frac{M_M}{M_S}\right)^k , \\ Y &= \frac{1}{\pi \sum_n (\frac{1}{n})^{2k+1}} = \frac{1}{\pi\zeta(2k+1)} , \\ K &= x \times \frac{r_M}{r_S} \times \frac{y_M}{y_S} , \quad x = \frac{M_S}{M_M} . \end{aligned} \quad (1.5.24)$$

Numerical estimates

To get a numerical grasp to the situation one can use $M_S/M_M \simeq 2.71 \times 10^7$, $r_S/r_M \simeq 389.1$, and $(M_S r_M / M_M r_S) \simeq 1.74 \times 10^4$. The overall order of magnitude of the effect would be

$$\begin{aligned} \frac{\Delta g}{g} &\sim XY \times \frac{GM_S}{R_S^2 g} \cos(\Theta) , \\ \frac{GM_S}{R_S^2 g} &\simeq 6 \times 10^{-4} . \end{aligned} \quad (1.5.25)$$

The overall magnitude of the effect is determined by the factor XY .

1. For $k = 0$ the normalization factor is proportional to $1/\zeta(1)$ and diverges and it seems that this option cannot work.
2. The table below gives the predicted overall magnitudes of the effect for $k = 1, 2/2$ and $1/4$.

k	1	1/2	1/4
$\frac{\Delta g}{g \cos(\Theta)}$	1.1×10^{-9}	4.3×10^{-6}	1.97×10^{-4}

For $k = 1$ the effect is too small to explain even the findings of [39] since there is also a kinematic reduction factor coming from $\cos(\Theta)$. Therefore $k < 1$ suggesting fractal behavior is required. For $k = 1/2$ the effect is of same order of magnitude as observed by Allais. The alternating sum equals in a good approximation to -0.693 for $y_S/y_M = 1$ so that it is not possible to explain the finding $\Delta f/f \simeq 5 \times 10^{-4}$ of Jeverdan.

3. For $k = 1/4$ the expression for Δa_{gr} reads as

$$\frac{\Delta a_{gr}}{g \cos(\Theta)} \simeq 1.97 \times 10^{-4} \sum_{n=1}^{\infty} \frac{(-1)^n}{n^{1/2}} \cos(n\pi K) \quad ,$$

$$K = \frac{y_M}{y_S} u \quad , \quad u = \frac{M_S}{M_M} \frac{r_M}{r_S} \simeq 6.95671837 \times 10^4 \quad . \quad (1.5.26)$$

The sensitivity of cosine terms to the precise value of y_M/y_S gives good hopes of explaining the strong variation of $\Delta f/f$ and also the findings of Jeverdan. Numerical experimentation indeed shows that the sign of the cosine sum alternates and its value increases as y_M/y_S increases in the range [1, 2].

The eccentricities of the orbits of Moon *resp.* Earth are $e_M = .0549$ *resp.* $e_E = .017$. Denoting semimajor and semiminor axes by a and b one has $\Delta = (a-b)/a = 1 - \sqrt{1-e^2}$. $\Delta_M = 15 \times 10^{-4}$ *resp.* $\Delta_E = 1.4 \times 10^{-4}$ characterizes the variation of y_M *resp.* y_E due to the non-circularity of the orbits of Moon *resp.* Earth. The ratio $R_E/r_M = .0166$ characterizes the range of the variation $\Delta y_M = \Delta r_{M,P}/r_M \leq R_E/r_M$ due to the variation of the position of the laboratory. All these numbers are large enough to imply large variation of the argument of cosine term even for $n = 1$ and the variation due to the position at the surface of Earth is especially large.

The duration of full eclipse is of order 8 minutes which corresponds to angle $\phi = \pi/90$ and at equator roughly to a $\Delta y_N = (\sqrt{r_M^2 + R_E^2 \sin^2(\pi/90)} - r_M)/r_M \simeq (\pi/90)^2 R_E^2/2r_M^2 \simeq 1.7 \times 10^{-7}$. Thus the change of argument of $n = 1$ cosine term during full eclipse is of order $\Delta \Phi = .012\pi$ at equator. The duration of the eclipse itself is of order two 2 hours giving $\Delta y_M \simeq 3.4 \times 10^{-5}$ and the change $\Delta \Phi = 2.4\pi$ of the argument of $n = 1$ cosine term.

1.5.4 Could Z^0 force be present?

One can understand the experimental results without a breaking of Equivalence Principle if the pendulum acts as a quantum gravitational interferometer. One cannot exclude the possibility that there is also a dependence on pendulum. In this case one would have a breaking of Equivalence Principle, which could be tested using several penduli in the same experimental arrangement. The presence of Z^0 force could induce an apparent breaking of Equivalence Principle. The most plausible option is Z^0 MEs with large Planck constant. One can consider also an alternative purely classical option, which does not involve large values of Planck constant.

Could purely classical Z^0 force allow to understand the variation of $\Delta f/f$?

In the earlier model of the Allais effect (see Appendix) I proposed that the classical Z^0 force could be responsible for the effect. TGD indeed predicts that any object with gravitational mass must have non-vanishing em and Z^0 charges but leaves their magnitude and sign open.

1. If both Sun, Earth, and pendulum have Z^0 charges, one might even hope of understanding why the sign of the outcome of the experiment varies since the ratio of Z^0 charge to gravitational mass and even the sign of Z^0 charge of the pendulum might vary. Constant charge-to-mass ratio is of course the simplest hypothesis so that only an effective scaling of gravitational constant would be in question. A possible test is to use several penduli in the same experiment and find whether they give rise to same effect or not.
2. If Moon and Earth are Z^0 conductors, a Z^0 surface charge cancelling the tangential component of Z^0 force at the surface of Earth is generated and affects the vertical component of the force experienced by the pendulum. The vertical component of Z^0 force is $2F_Z \cos(\theta)$ and thus proportional to $\cos(\Theta)$ as also the effective screening force below the shadow of Moon during solar eclipse. When Sun is in a vertical direction, the induced dipole contribution doubles the radial Z^0 force near surface and the effect due to the gravitational screening would be maximal. For Sun in horizon there would be no Z^0 force and gravitational tidal effect of Sun would vanish in the first order so that over all anomalous effect would be smallest possible: for a full screening

$\Delta f/f \simeq \Delta g^2/4g^2 \simeq 4.5 \times 10^{-8}$ would be predicted. One might hope that the opposite sign of gravitational and Z^0 contributions could be enough to explain the varying sign of the overall effect.

3. It seems necessary to have a screening effect associated with gravitational force in order to understand the rapid variation of the effect during the eclipse. The fact that the maximum effect corresponds to a maximum gravitational screening suggests that it is present and determines the general scale of variation for the effect. If the maximal Z^0 charge of the pendulum is such that Z^0 force is of the same order of magnitude as the maximal screening of the gravitational force and of opposite sign (that is attractive), one could perhaps understand the varying sign of the effect but the effect would develop continuously and begin before the main eclipse. If the sign of Z^0 charge of pendulum can vary, there is no difficulty in explaining the varying sign of the effect. An interesting possibility is that Moon, Sun and Earth have dark matter halos so that also gravitational screening could begin before the eclipse. The real test for the effect would come from tidal effects unless one can guarantee that the pendulum is Z^0 neutral or its Z^0 charge/mass ratio is always the same.
4. As noticed also by Allais, Newtonian theory does not give a satisfactory account of the tidal forces and there is possibility that tides give a quantitative grasp on situation. If Earth is Z^0 conductor tidal effects should be determined mainly by the gravitational force and modified by its screening whereas Z^0 force would contribute mainly to the pressure waves accompanying the shadows of Moon and Sun. The sign and magnitude of pressure waves below Sun and Moon could give a quantitative grasp of Z^0 forces of Sun and Moon. Z^0 surface charge would have opposite signs at the opposite sides of Earth along the line connecting Earth to Moon *resp.* Sun and depending on sign of Z^0 force the screening and Z^0 force would tend to amplify or cancel the net anomalous effect on pressure.
5. A strong counter argument against the model based on Z^0 force is that collinear configurations are reached in continuous manner from non-collinear ones in the case of Z^0 force and the fact that gravitational screening does not conform with the varying sign of the discontinuous effect occurring during the eclipse. It would seem that the effect in question is more general than screening and perhaps more like quantum mechanical interference effect in astrophysical length scale.

Could Z^0 MEs with large Planck constant be present?

The previous line of arguments for gravitational MEs generalizes in a straightforward manner to the case of Z^0 force. Generalizing the expression for the gravitational Planck constant one has $\hbar_{Z^0} = g_Z^2 Q_Z(M) Q_Z(m) / v_0$. Assuming proportionality of Z^0 charge to gravitational mass one obtains formally similar expression for the Z^0 force as in previous case. If Q_Z/M ratio is constant, Equivalence Principle holds true for the effective gravitational interaction if the sign of Z^0 charge is fixed. The breaking of Equivalence Principle would come naturally from the non-constancy of the $v_0(S, P)/v_0(M, P)$ ratio also in the recent case. The variation of the sign of $\Delta f/f$ would be explained in a trivial manner by the variation of the sign of Z^0 charge of pendulum but this explanation is not favored by Occam's razor.

1.6 Dark Z^0 force in astrophysical length scales

The findings of Shnoll give support for the predicted importance of dark Z^0 force in astrophysical length scales.

1.6.1 The regularities in radio active decay rates linked to astrophysical cycles

Russian scientists have discovered regularities in the rates of radio active, chemical and biochemical processes linked to astrophysical periodicities. The observations of Shnoll and his collaborators summarizing work of forty years, were published for a couple years ago in a respected Russian science

journal [19], but have been greeted with silence in media. It took two years before I learned from the discovery (I am grateful for Prof. Adrian Klein for informing me about the work). This silence strengthens further my impression that theoretical physicists have concluded that superstrings provide the final truth about everything above and below Planck length scale, and have therefore decided to turn their back to the empirical science. Also the fact that the discovery of Shnoll and his collaborators is in strong a conflict with the basic dogma of reductionism which is a basic tenet of standard physics including superstring models, might explain the peculiar silence. Certainly, at the times of Einstein empirical discovery of this caliber would have been a major scientific event.

Dark Z^0 force as explanation of the observations

The observations of Shnoll and collaborators can be summarized by two statements.

1. The rate distributions for radio active decays and chemical and biochemical processes do not converge to single bell curve as suggested by quantum randomness plus standard model but to distributions which have several pronounced peaks.
2. The shapes of the rate curves seem to be similar to widely different reactions (radio-active decays, chemical and biochemical processes) but they fluctuate with time and fluctuation periods correspond to various astrophysical periods: day, month, year,...

The latter observation suggests strongly that there is an astrophysical factor, presumably some unidentified long range force, involved. In standard physics gravitational force is the only candidate but the effects caused by the gravitational force are quite too weak. In TGD situation is different and the observations of Shnoll provide an additional piece to the picture constructed during the last decade.

1. TGD predicts that all massive bodies necessarily generate long range Coulombic dark Z^0 force. This is mathematical necessity: only the strength of this force can vary. This interaction is instantaneous: entire system behaves like single coherent whole, a comparison with a biological organism might not be far fetched. This force is however extremely weak in astrophysical length scales. TGD predicts also "massless extremals" (MEs), which can also carry classical Z^0 fields. Classical signals propagating with light velocity over cosmic distances would be in question now. There is no attenuation since essentially a radiation propagating in a wave guide is in question. Since these signals propagate along their own space-time sheets, the interaction with the cosmic microwave background does not attenuate them. The absence of dispersion means that information is preserved during the propagation of the classical field. The nondeterminism of the light-like vacuum current associated with ME at a given point of ME allows arbitrary pulse shapes and makes MEs optimal for the coding of information. These and some other properties of MEs explain with MEs are in key role in TGD inspired theory of consciousness and life [K3].
2. p-Adic fractality suggests [F9] that the dark Z^0 charge of a macroscopic object per volume defined by the p-adic length scale is essentially same irrespective of its size. This means that small objects have the highest Z^0 charge per mass ratio and respond to the classical Z^0 fields most intensely. The objects in the meter scale still have Z^0 charge densities making possible small effects. For astrophysical objects like Earth Z^0 charge is so small that it has no appreciable effects on the motion of Earth in Z^0 field of Sun. Somewhat surprisingly, dark Z^0 force is predicted to become important already in nuclear physics length scale. Dark Z^0 force is expected to be especially important in the length scale range 10 nm-2.5 μ m containing the p-adic length scales of four Gaussian Mersennes.
3. Classical Z^0 force predicts variations in the rates of the radio active decays since it ultimately couples with exotic quarks of atomic nuclei at the long color bonds connecting different nucleons. This happens if the color bond is charged and thus also possesses weak gauge charge. Thus the coupling of matter to astrophysical Z^0 MEs could explain the observations of Shnoll and collaborators just as it explains the findings of Allais.

It has been already earlier found that the beta decay of tritium (neutron decays to proton+ electron+ antineutrino) exhibits anomaly when the energy of the neutrino is very small [F8].

Also this decay exhibits periodic variations with several periods: one of them is year. This inspired the assumption that Earth's orbit is surrounded by a dark neutrino belt which has density which is not constant along the orbit and causes the effects.

4. The fluctuation of also chemical and biochemical reaction rates with the astrophysical periods lends a strong support for the hypothesis that Z^0 force is a crucial element in chemical and biological systems. For instance, classical Z^0 force explains chirality selection which is a mystery in standard physics since huge parity breaking effect is in question [F9]. In TGD inspired theory of consciousness Z^0 force is in a key role: perhaps ZEG might be some day regarded as a basic carrier of information about contents of of consciousness besides EEG. The quantum physics behind hearing involves what I have used to call "cognitive neutrino pairs" and dark Z^0 force in the length scale of the cell membrane [M5]. Also dark neutrino super conductivity could define an important piece in the jigsaw of consciousness. Atoms and ions of condensed matter with anomalous weak charges can also behave as Z^0 super conductors and Z^0 magnetic cyclotron frequencies could represent important ZEG frequencies.
5. One must notice that also the spectrum for Planck constants could give a spectrum of rates due to the fact that higher order corrections to the decay rates depend on Planck constant assuming that lowest order term corresponds to \hbar^0 , the classical approximation.

Several rates and many-sheeted space-time

How to explain the fact that there are several average process rates leading to the replacement of bell curve with a many-peaked curve? One can imagine several explanations. The essential element of explanation is that classical Z^0 forces of both local and astrophysical origin affect the rates and that Z^0 field has different strengths in different parts of the system.

The first possibility is that the internal Z^0 forces vary in different parts of system. Second possibility is that external Z^0 force has effectively several strengths: this is quite possible in the many-sheeted space-time. The space-time sheets at which processes occur, can be 'glued' by topological sum operation to a larger space-time sheet. If this larger space-time sheet is not always the same, the external Z^0 force varies according to which sheet the topological condensation occurs on. This gives rise to many-peaked rate curve. This many-peaked structure would be universal and highly independent of a type of process studied. Besides the p-adic length scale $L(k = 169)$, which corresponds to the space-time sheet of neutrinos usually, the space-time sheets characterized by the p-adic length scales $L(k)$, $k = 151, 157, 163, 167$, varying between 10 nanometers and 2.6 micrometers, are especially interesting in this respect since they correspond to the counterparts of Mersenne primes for Gaussian primes (having the form $(1 + i)^k - 1$) and are predicted to be fundamental biological length scales. Note also that the "cognitive antineutrinos" are assumed to be associated with $k = 151$ space-time sheet in TGD inspired quantum model of hearing. Note that these four p-adic length scales might correlate directly with qualitatively different levels in the evolution of life.

Bio-control over cosmic distances?

What is interesting is that classical Z^0 force might make possible bio-control over cosmic distances. The p-adic length scales associated with Gaussian Mersennes are in length scale 10 nm-2.5 μm suggests that objects with cell size have the highest Z^0 charge per mass ratio. Coherently changing cosmic Z^0 fields could simultaneously induce effects on bio-matter in cosmic scales: erratic interpretation of these effects as signals would lead to a conclusion that signals have propagated with super-luminal velocity. Massless extremals (MEs) accompanied by classical Z^0 fields might make possible communication and control. Cell size objects (or possibly objects with sizes between cell membrane thickness and cell size) would serve as optimal receivers. One can also speculate with the possible connection between the ubiquitous $1/f$ noise and classical Z^0 fields associated with MEs of possibly cosmic size [I4, I5]. The work done to detect signals sent by extra-terrestrial civilizations has not yielded positive results hitherto. A possible explanation is that electromagnetic signals are not used for communication purposes by advanced civilizations. One can consider also the possibility that these signals are coded into classical Z^0 fields propagating along MEs and that the mysterious $1/f$ noise contains these signals.

1.6.2 Torsion fields or Z^0 fields

Torsion fields have been used to explain the anomalous effects related to spinning systems, in particular breaking of parity. In general relativity framework the coupling of torsion fields is quite too weak to explain these anomalies. Long ranged weak fields created by dark matter, in particular Z^0 field, can however explain these effects.

The concept of torsion field

The common denominator of most anomalous effects is the presence of spinning objects. This naturally led to the idea that the so called torsion field coupling to spin density could provide an explanation for the anomalous effects. In order to avoid confusion it is useful to notice that the concept of torsion has several meanings.

1. The concept of torsion and its connection with spin was introduced already by E. Cartan. It is possible to introduce torsion into Einstein's theory of gravitation as a dynamical pseudo vector field defined as the tensor dual for the antisymmetrized Christoffel symbols for nonmetric connection [51, 52, 53, 54, 55]. This however requires generalizing Einstein's theory of gravitation based on metric connection having vanishing torsion. It turns that spin-torsion interaction is practically a spin-spin contact interaction and that torsion fields do not propagate in this theory. The coupling between torsion and spin is extremely weak: about 27 orders of magnitude weaker than the constant of gravitational interactions. Also a large number of nonlinear torsion theories have appeared: for instance, the torsion theory of Shipov [20] in which the coupling constant of spin torsion interactions is of order $10^{-5} - 10^{-6}$. In TGD framework torsion in this sense is not possible since TGD relies on metric geometry.
2. Topological torsion can be defined as a topological current defined by the inner product $E \cdot B$ of electric and magnetic fields ("instanton density") proportional to the divergence of the axial vector density $T^\mu = \epsilon^{\mu\alpha\beta\gamma} A_\alpha F_{\beta\gamma}$ [57]. The integral of this quantity over a closed 3-surface is topological invariant of em field. Topological torsion is obviously not an independent dynamical degree of freedom. In TGD the vanishing of the invariant implies that E and B are nonorthogonal in the interior of the integration volume and this in turn means that classical Z^0 field accompanies em field and also that parity breaking occurs due to the axial couplings of Z^0 field to fermions. The reason for this is very simple: induced gauge field is Abelian only if the CP_2 projection of the space-time surface is 2-dimensional. This in turn automatically implies that E and B are orthogonal for all induced gauge fields so that instanton density vanishes. Thus torsion becomes a signature for the presence of classical Z^0 fields in TGD framework.

The effects attributed to torsion fields can be explained in terms of classical Z^0 fields

Various experimental methods to detect torsion fields and even communication methods based on the effects of torsion fields on matter are reported [42]. There is also a claims for evidence about nontrivial effects of torsion fields on living matter, admittedly some of them sound rather bizarre and must be taken with a big grain of salt. The experimental characteristics described in [42] are consistent with the identification of the torsion fields with classical Z^0 fields. Z^0 classical fields are indeed in key role in TGD inspired theory of consciousness. Therefore one should be open minded in judging the reality of the claimed effects of torsion on living matter.

1. Torsion fields are generated by classical spin. If material object spins in stationary manner, torsion field is static. Same is true for the Z^0 magnetic field. Also the description of [42] for the topology of the torsion field generated by spinning object resembles dipole magnetic field and nontrivial gyroscopic effects result when object spins in non-stationary manner. This is true also for Z^0 fields: nonstationary rotation generates by Faraday's induction law rotational Z^0 electric fields. In TGD large gravitational effects are possible since induced metric and classical gauge fields can both expressed in terms of CP_2 coordinates and the constraint of being imbeddable to $M_+^4 \times CP_2$ generates strong constraint forces.
2. According to [42], some materials are known to serve as shields against torsion fields. In the similar manner Z^0 diamagnets serve as shields against Z^0 magnetic fields. The shielding is

expected to occur in the space-time sheet labelled by the p-adic prime $p \simeq 2^k$, $k = 169$, which according to TGD inspired model of condensed matter, is neutrino super conductor of type I. Note that this space-time sheet corresponds to the space-time sheet of epithelial sheets consisting of two cell layers and is fundamental in TGD based theory of consciousness.

3. Torsion fields are predicted to be generated by any spinning material structure [42]. For Z^0 magnetic fields in condensed matter would occur if nuclei of condensed matter carry anomalous Z^0 charges due to the charging of color bonds having exotic quarks at their ends. The quarks would couple to scaled down copies of weak bosons with weak length scale of order atomic radius.
4. Spin polarization creates torsion fields [42] and torsion fields affect spin structure of matter. This is suggested to explain the "magnetization of water" [42], that is the effect of ordinary magnet on biological activity of distilled water, which is diamagnetic substance. As already noticed "torsion fields" are reported to have biological effects (for references see [42]). According to the model of [F9] water the anomalous properties of water are essentially to the dark nuclear Z^0 force and it would not be surprising if this kind of effects would occur.
5. One should have a good explanation for why classical Z^0 fields have not been observed until during last decades. That dark matter generates these fields, is certainly such an explanation.
6. Faraday's law of induction holds true for the classical Z^0 fields and effects revealing non-electromagnetic induction effect give support for the TGD based picture. One effect of this kind relates to a configuration involving two parallel conducting disks on top of each other [58]. The lower disk rotates. If the angular velocity of the lower disk is gradually increased, the disk above it begins to rotate in opposite direction so that friction cannot cause this effect.

A possible explanation is based on Faraday's induction law. When the rotation velocity increases, the static Z^0 magnetic field changes and gives rise to rotational Z^0 electric field, the flow lines of which circulate around the rotation axis. This in turn implies classical Z^0 Coulomb force on nuclei of the disk (assumed to have dark weak charge) accelerating them in opposite directions. The rotation of nucleons is perceived as macroscopic rotation. By the principle of least action the direction of rotation must be such that it generates Z^0 magnetic field in direction opposite to that of the original field and this means that upper disk begins to rotate in direction opposite to that of the lower disk. It is not clear whether torsion field picture could explain this effect.

7. The weight loss of a spinning gyroscope involves strong parity breaking effect and the parity breaking couplings of the classical Z^0 field readily explain the symmetry breaking. To explain the effect in picture based on torsion fields would require ad hoc assumptions about the coupling of torsion field to classical spin.

1.7 How to test the presence of the Z^0 force in micrometer-millimeter length scale range?

p-Adic fractality suggests that the density of dark Z^0 charge scales as $1/L_p^3$. The model for atomic nuclei predicts that the density of dark Z^0 charge is few units per atomic volume in condensed matter. This predicts that the Z^0 force is comparable to the gravitational force below length scale of order 2-20 μm .

In general, the values of G determined using Cavendish experiment have unexpectedly large range of variation although the accuracies of individual experiments are rather high. Variations of .01 – 1 per cent are present [39]. There is also Cavendish experiment performed by Kruse [40] determining gravitational constant using small rigidly connected metal spheres forming torsion pendulum. The measured value of the gravitational constant was found to be 89 per cent of the standard value! Since Z^0 force between small masses is effectively eliminated in classical Cavendish experiment, Z^0 force cannot explain these anomalies. TGD based explanation for discrepancies could be based on some other mechanism, perhaps on the redistribution of the gravitational flux of the big masses leading to effective change of the gravitational mass.

Wuppertal group [39] has determined gravitational constant by measuring the distance between two gravitational penduli. This experiment is sensitive to classical Z^0 force between the small test

masses and two variants of this experiment able to test the presence of the classical Z^0 force are discussed.

One can also consider much simpler experiment determining directly the effective gravitational force between two gravitational penduli. In the first stage of the experiment the distance from a fixed reference point to the gravitational pendulum is measured. Then second identical gravitational pendulum is introduced on the line connecting the reference point and the first pendulum and the distance is measured again. The difference of these distances allows to deduce the value of the effective gravitational constant.

1.7.1 Scaling law for dark Z^0 charges

p-Adic length scale hypothesis

p-Adic length scale hypothesis states that p-adic primes which correspond to with $p \simeq 2^k$, k power of prime are physically preferred ones. The table below gives the list of p-adic length scales relevant for condensed matter physics. Note that the length scales are determined only up to some numerical constant. The fixing of $L(151)$ to be the thickness of cell membrane about 10^{-8} meters is promising physically sensible manner to fix the overall scale factor uniquely.

k	127	131	137	139	149
$L_p/10^{-10}m$.020	.082	.65	1.3	42.0
k	151	157	163	167	169
$L_p/10^{-7}m$.083	.67	5.3	21	42
k	173	179	181	191	193
$L_p/10^{-3}m$.0017	.14	.28	8.9	17.8

Table 1. p-Adic length scales $L_p = 2^{k-127}L(127)$, $p \simeq 2^k$, $L(127) \equiv \frac{\pi\sqrt{5+Y}}{m_e}$, $Y = .0317$, k power of prime, possibly relevant to condensed matter physics.

Scaling hypothesis provides a quantitative model for the density of dark matter at various p-adic length scales and follows naturally from p-adic fractality hypothesis. Scaling hypothesis states that the net Z^0 charge to nuclear Z^0 charge ratio denoted by $1/\sqrt{\epsilon_Z(p)}$ scales as $1/L_p^3$, where L_p is the p-adic length scale associated with the massive object and related to the size of the massive object by some numerical coefficient not too far from one.

Modification of the effective gravitational constant

The scaling law for Z^0 charge implies definite prediction for the effective gravitational force between two sufficiently small objects. Z^0 repulsion leads to the reduction of the effective gravitational force between small test masses. The value of the effective gravitational constant for the interaction between small test particles is

$$G_{eff} = \left(1 - \frac{F_Z}{F_G}\right)G . \quad (1.7.1)$$

where F_Z and F_G denote Z^0 and gravitational forces between test masses. Define L_w , as the p-adic length scale associated with nuclear exotic weak bosons. According to [F8], one has $L_w = nL(113)/v_0 \simeq xnL(135)$, $x \in [1, 2]$. For $n = 1$ this length scale is in the range 1-2 Angstrom and for $n = 3$ in the range 3-6 Angstrom (this option seems to hold true in water and living matter).

Using this input one obtains an explicit formula for F_Z/F_G as

$$\begin{aligned} \frac{F_Z}{F_G} &= \alpha_Z Q_Z^2(n) \frac{1}{G m_p^2} \frac{N^2}{A^2} \left(\frac{L_w}{L_p}\right)^6 , \\ \alpha_Z Q_Z^2(n) &= \frac{\alpha_{em} Q_Z(n)^2}{\sin(\theta_W) \cos(\theta_W)} , \\ Q_Z(n) &= \frac{1}{4} + \sin^2(\theta_W) \simeq 1/2 , \\ \sin^2(\theta_W) &\simeq 0.23 . \end{aligned} \quad (1.7.2)$$

$Gm_p^2 \simeq 10^{-38}$ is the ratio of proton mass squared to Planck mass squared (units $\hbar = 1$, $c = 1$ are used). α_Z is Z^0 coupling constant strength, $\alpha \simeq 1/137$ is fine structure constant and θ_W denotes Weinberg angle, m_p is proton mass and A denotes mass per atomic volume a of atom or molecule in question. $N \times a^3/L^3(k)$ is the nuclear anomalous weak isospin per atomic volume using neutron's weak isospin $Q_Z(n)$ as a unit and assuming p-adic fractality. $0 \leq N \ll A$ is expected to hold true since nuclear anomalous charge corresponds to weakly charged color bonds carrying $N = \pm 2$ units of neutrino weak isospin. The dependence of the force ratio is very sensitive to L_p : a scaling by a factor of 2 implies a reduction by a factor 2^{-6} .

This gives an estimate for the length scale L_{cr} at which Z^0 -and gravitational forces have same strength.

$$L_{cr} = \left[\alpha_Z Q_Z^2(n) \frac{N^2}{A^2} \frac{1}{Gm_p^2} \right]^{1/6} L_w . \quad (1.7.3)$$

Numerical estimate gives

$$L_{cr} \simeq .07 \times \left(\frac{N}{A} \right)^{1/3} \times \frac{L_w}{L(139)} \text{ mm} . \quad (1.7.4)$$

Consider Fe ($A = 56$) as an example. For $N = 1$ (just an ad hoc assumption) and $n = 1$ giving $L_w = xL(135)$, the length scale in question would be $L_{cr} = 4.85x \mu\text{m}$ for so that cell length scale would be the critical length scale. For $n = 3$ one would have $L_{cr} = 14.5x \mu\text{m}$. By p-adic length scale hypothesis the nearest physically favored p-adic length scale above L_{cr} corresponds to $L(169) = 5 \mu\text{m}$ for $n = 1, x = 1$ and the nearest p-adic length scale below to $L(167) = 2.5 \mu\text{m}$ and corresponds to the largest Gaussian Mersenne in the sequence of Gaussian Mersennes $(1 + i)^k - 1$ labelled by $k = 151, 157, 163, 167$. Thus Gaussian Mersennes would correspond to length scales for which the dark weak force wins the gravitational force. The change of the sign of the effective gravitational coupling constant is so dramatic effect that it should certainly reveal the presence of the new force.

The critical length scale is not very sensitive to N/A . For water with $A = 18$ and $n = 3$ one would obtain using the same parameter values the result $L_{cr} = 21.2 \mu\text{m}$ which is slightly above $L(173) = 20 \mu\text{m}$.

Interestingly, there is a little bit more than rumor that Eötvös group [41] has found below 100 microns evidence for a deviation of the strength of gravitational force from the Newtonian prediction at 4 sigma confidence level. The group is still performing additional tests before publishing the result. The effect is weakening of gravitational force and could thus be explained in terms of dark Z^0 force. What is also interesting that M-theory inspired models tend to predict that gravitational force gets stronger at these distances [42].

1.7.2 How to directly test the presence of classical Z^0 force?

Standard Cavendish experiment [39] is based on the measurement of the torsion angle of a torsion pendulum. Small test masses m are connected by a bar and this structure hinges from the middle point of the bar by a thread. The introduction of the large masses located symmetrically with respect to the origin causes a torque and the value of the gravitational constant can be deduced from the value of the torsion angle. This experiment does not reveal the classical Z^0 force since small masses are connected by bar fixing their mutual distance and thus effectively eliminating classical Z^0 force.

To reveal the presence of the classical Z^0 force, one should use free gravitational penduli and measure precisely the distance between them in equilibrium position with and without external masses to see whether the classical Z^0 interaction between the small test masses is present. Wuppertal group [39] has applied this method to determine the value of gravitational constant. Thus it seems that the technology making possible to test TGD predictions might already exist.

One can consider two variants of the Wuppertal experiment [39].

1. Large masses are located symmetrically on the opposite sides of the plane of penduli on the line bisecting the line connecting the penduli. Therefore the net gravitational force caused by them is parallel to the axis connecting the small masses and tends to bring the small masses closer to each other.

2. Large masses are located on the line connecting small masses and the gravitational force tends to pull small masses apart from each other.

One can however consider much simpler experiment. In the initial situation there is only single pendulum and the distance from a fixed reference point to pendulum is measured. Then second identical pendulum is introduced on the axis connecting reference point and the first pendulum and the distance to the first pendulum is measured again. From the change of the distance the value of the effective gravitational constant is deduced. The sign of the distance increment tells also whether the force between the penduli is attractive or repulsive. A practical manner to perform the experiment is perhaps following.

1. Constraint the second pendulum to the configuration $\theta = -\pi$ so that the pendulum points upwards where its interaction with the first pendulum is much weaker than in equilibrium position.
2. Remove the constraint and allow the pendulum to go to the equilibrium position $\theta \simeq 0$.

Direct measurement of the classical Z^0 force

Let z-axis be in the direction of Earth's gravitational field. Let the two gravitational penduli have length l and mass m . Assume that the suspension points have transversal distance d . It is convenient to choose the coordinates in such a manner that penduli are at x-axis and that the x-coordinates for the points of suspension are $x = -d/2$ and $x = d/2$. In the first situation there is only one pendulum at $x = d/2$ and distance to it is measured from some point of x-axis with coordinate $X > d/2$. The second pendulum is introduced at $-d/2$ and the change of the distance of the first pendulum to a fixed reference point is measured.

The penduli are affected only by Earth's gravitational force and possibly also by classical Z^0 force which only renormalizes the effective gravitational coupling constant: $G \rightarrow XG$. The potential energy is thus given by

$$\begin{aligned} V &= -X \frac{Gm^2}{r_{12}} + mgl [\cos(\theta_1) + \cos(\theta_2)] \ , \\ r_{12} &= d + l(\sin(\theta_1) + \sin\theta_2) \ . \end{aligned} \quad (1.7.5)$$

θ_i denote the deviations of the penduli from the vertical direction defined by the direction of g . Equilibrium position corresponds to symmetric configuration $\theta_1 = \theta_2$ and the requirement that potential is minimum determines the values of θ_i . Since extremely small deviations from $\theta_i = 0$ are in question, one can linearize with respect to θ_i . The result is

$$\begin{aligned} \theta_1^0 &= \frac{XG_1}{1 + 4G_1 w} \ , \\ G_1 &= \frac{g_1}{g} = \frac{m}{M_E} \frac{R_E^2}{d^2} \ , \\ w &= \frac{l}{d} \ . \end{aligned} \quad (1.7.6)$$

If one can directly measure the distance of the first pendulum from a point of x-axis both in absence and presence of the second pendulum, it is possible to deduce the value of θ_1 from the relation

$$\Delta x = l\theta_1^0 \ ,$$

and from this to deduce the value of the parameter X . In excellent approximation θ_1 is given by

$$\theta_1 \simeq Xg_1/g = X \frac{R_E^2}{d^2} \frac{m}{M_E} \ .$$

Here $R_E \simeq 6.6 \times 10^6$ meters is the radius of Earth and $M_E \simeq 6 \times 10^{24}$ kg is the mass of Earth. For $d = .1$ meters and $m = 10^{-2}$ kg this gives $\theta_1 \sim 6 \times 10^{-9}$ radians. If one can make the length l of

the pendulum large, the value of Δx could perhaps be made so large that it becomes detectable. For $l = 1$ m the deviation would be 10^{-8} meters for $X = 1$. Note that the value of θ_1 does not depend on the mass of the pendulum.

If classical Z^0 force is present and obeys scaling law, the value of θ_1 can change its sign and, behaving as $1/L^6$ as a function of the size L of the test mass, can increase dramatically for very small test mass sizes. Also this could make the experiment feasible. The mere decrease of the distance would immediately tell that the net force is repulsive. One must however consider the possibility that the p-adic prime characterizing the pendulum is not determined by the size of the mass blob but by the size of the entire pendulum and could thus be much larger. In this case no dramatic effects are to be expected.

Introduction of the large masses

The initial situation of the experiment corresponds to the presence of two gravitational penduli on x-axis at points $x = -d/2$ and $x = d/2$. This situation was already treated. Larger masses M are introduced. There are two manners to introduce them.

1. Cm coordinates of the large masses are on the plane determined by penduli. The coordinates for their positions are either

$$\begin{aligned} (x, y, z) &= (x_1, 0, h) , \\ (x, y, z) &= (-x_1, 0, h) . \end{aligned} \tag{1.7.7}$$

2. Cm coordinates of the large masses are on y-axis and symmetrically related to the plane of the penduli

$$\begin{aligned} (x, y, z) &= (0, h, 0) , \\ (x, y, z) &= (0, -h, 0) . \end{aligned} \tag{1.7.8}$$

The distance of the large mass from nearby small mass is $r = \sqrt{h^2 + (x - d/2)^2}$ and the difference for x-coordinates of M and m is $r_x = x - d/2$. The parameters l, d, r_x and h characterize the geometry of the arrangement. Convenient dimensionless parameters are following

$$\begin{aligned} u \equiv \cos(\psi) &= \frac{r_x}{r} , \quad v \equiv \frac{l}{r} , \quad w = \frac{l}{d} , \\ r_x &= x - d/2 , \quad r = \sqrt{h^2 + (x - d/2)^2} . \end{aligned} \tag{1.7.9}$$

There are two parameters, G_1 and G_2 characterizing gravitational forces experienced by small mass m . G_1 characterizes the acceleration caused by second small mass m and G_2 characterizes the acceleration caused by the nearest big mass M . These parameters are given by

$$\begin{aligned} G_1 &= \frac{g_1}{g} = \frac{m}{M_E} \frac{R_E^2}{d^2} , \\ G_2 &= \frac{g_2}{g} = \frac{M}{M_E} \frac{R_E^2}{r^2} , \\ r &= \sqrt{h^2 + (x - d/2)^2} . \end{aligned} \tag{1.7.10}$$

The deviations of the gravitational force between small test masses caused by the classical Z^0 force could affect the measured value of G only if the gravitational force between the small is sufficiently large. The parameter which turns out to measure the importance of the gravitational force between small masses is given by

$$\begin{aligned}
p &\equiv \frac{G_1}{G_2 u}, \\
u &\equiv \frac{r_x}{r} \equiv \cos(\psi) .
\end{aligned} \tag{1.7.11}$$

Here ψ is the direction angle of the position of large mass M . It is convenient to characterize the effective gravitational force between small test particles by the parameter

$$X = \frac{G_{eff}(m, m)}{G} .$$

This reduction of gravitational force between small test masses causes change of the gravitational constant as given by Wuppertal experiment. The change is not necessarily large. The ratio

$$Y = \frac{G_{meas}}{G}$$

between the measured and actual gravitational constants is a convenient experimental parameter to describe the effect of Z^0 force. The intention is to derive the formulas relating to each other the parameters X and Y .

The two variants of the Wuppertal experiment

Consider now the situation when big masses are brought near the small masses in the two manners corresponding to two versions of the Wuppertal experiment. The potential energy V of the previous case is replaced with $V + V_{int}$, where V_{int} is ordinary gravitational potential energy to which Z^0 force does not contribute if the size of the test masses is large enough.

1. For the first variant of Wuppertal experiment one has

$$\begin{aligned}
V_{int} &= -\frac{GmM}{r_{1a}} - \frac{GmM}{r_{2a}} , \\
r_{1a} &= \sqrt{h^2 + (r_x - l \sin(\theta_1))^2} , \\
r_{1b} &= \sqrt{h^2 + (r_x - l \sin(\theta_2))^2} , \\
r_x &= x - d/2 .
\end{aligned} \tag{1.7.12}$$

The interaction energy of small mass with the second large mass is neglected for simplicity.

2. For the second variant of Wuppertal experiment one has

$$\begin{aligned}
V_{int} &= -\frac{GmM}{r_{1a}} - \frac{GmM}{r_{1b}} - \frac{GmM}{r_{2a}} - \frac{GmM}{r_{2b}} , \\
r_{1a} &= r_{1b} = \sqrt{h^2 + (r_x - l \sin(\theta_1))^2} , \\
r_{2a} &= r_{2b} \sqrt{h^2 + (r_x - l \sin(\theta_2))^2} , \\
r_x &= -d/2 .
\end{aligned} \tag{1.7.13}$$

$$r_x = -d/2 . \tag{1.7.14}$$

The new equilibrium position corresponds to $\theta_1 = \theta_2$ with

$$\theta_1^1 = \frac{XG_1 - kG_2u}{1 + 4XG_1w + kG_2f} , \quad f \equiv (1 - 3u^2)v , \tag{1.7.15}$$

$$u \equiv \cos(\psi) = \frac{r_x}{r} , \quad v \equiv \frac{l}{r} , \quad w = \frac{l}{d} .$$

The parameter k specifies the Wuppertal experiment. $k = 1$ for arrangement 1) in the approximation that force between small mass and second large mass can be neglected. $k = 2$ for the arrangement b) since gravitational force between small mass and large masses is doubled.

The change of the equilibrium position of pendulum when large masses are brought in, is characterized by the difference $\Delta\theta = \theta_1^1 - \theta_1^0$ and given by

$$\begin{aligned}\Delta\theta &= \theta_1^1 - \theta_1^0 \\ &= \frac{XG_1 - kG_2u}{1 + 4XG_1w + kG_2f} - \frac{XG_1}{1 + 4G_1w} .\end{aligned}\quad (1.7.16)$$

Note that version 2) of the Wuppertal experiment is obtained from version 1) by the replacements $G_2 \rightarrow 2G_2$ and $r_x = x - d/2 \rightarrow -d/2$.

How the measured value of G is affected by Z^0 force in Wuppertal experiments?

Consider now how the value of G is effected by the presence of the classical Z^0 force. If one does not take into account the presence of the Z^0 force, one obtains for $\Delta\theta$ the expression with G replaced by $G_{eff} = YG$:

$$\begin{aligned}\Delta\theta &= \theta_1^1 - \theta_1^0 \\ &= \frac{YG_1 - YkG_2u}{1 + 4YG_1w + YkG_2f} - \frac{YG_1}{1 + 4YG_1w} , \\ Y &= \frac{G_{meas}}{G} .\end{aligned}\quad (1.7.17)$$

One can solve Y in terms of X explicitly by equating the two expressions for $\Delta\theta$ from the resulting second order polynomial equation.

$$\begin{aligned}Y^2A_2 + YA_1 + A_0 &= 0 , \\ A_2 &= G_1kG_2 \left[4(wu + f) - \Delta\theta(4w\frac{G_1}{kG_2} + f) \right] , \\ A_1 &= kG_2 \left[u + \Delta\theta(4\frac{G_1w}{kG_2} + 4w + f) \right] , \\ A_0 &= \Delta\theta .\end{aligned}\quad (1.7.18)$$

Because of the numerical instabilities ($\Delta\theta$ is difference of two very nearly identical quantities which are sums over quantities with hugely different orders of magnitude it is however better to solve Y iteratively. One can write $\Delta\theta$ in the two forms

$$\begin{aligned}\Delta\theta(Y) &\simeq -kG_2u \left[\frac{Y}{1 + Y(B1 - kG_2f)} + Y^2 \frac{G_1}{(1 + YB_1)^2} \frac{f}{u} \right] , \\ \Delta\theta(X) &\simeq -kG_2u \left[\frac{1}{1 + X(B1 - kG_2f)} + \frac{G_1X}{(1 + XB_1)^2} \frac{f}{u} \right] .\end{aligned}\quad (1.7.19)$$

$\Delta\theta(Y) = \Delta\theta(X)$ gives equation for Y :

$$\begin{aligned}Y &= A(B + C + D) , \\ A &= 1 + Y(B1 - kG_2f) , \quad B = \frac{1}{1 + X(B1 - kG_2f)} , \quad C = \frac{G_1X}{(1 + XB_1)^2} \frac{f}{u} , \\ D &= -Y^2 \frac{G_1}{(1 + YB_1)^2} \frac{f}{u} , \quad B_1 = 4G_1w .\end{aligned}\quad (1.7.20)$$

One can solve this iteratively by substiting $Y(n)$ to the righthand side to obtain $Y(n + 1)$.

Numerical experimentation show that Y is rather stable against variations of X . Reduction of X makes Y larger than one in both cases. It seems that deviations of G from its standard value caused by classical Z^0 force are rather small.

1. For the variant 1) of the Wuppertal experiment, the calculation using $m = .005$ kg, $M = .10$ kg, $l = .3$ meters, $d = .001$ meters, $h = .5$ meters and $x = .1$ meters gives only 4.2 percent increase of the measured G for $X = -10^3$!
2. For the variant 2) of Wuppertal experiment with same parameter valued ($x = 0$), one obtains 6.5 per cent increase of the gravitational constant.

1.8 Appendix: Allais effect as manifestation of classical Z^0 force?

Although it seems now clear that Allais effect can be understood as gravitational effect, it makes sense to keep the earlier model explaining Allais effect as a manifestation of classical Z^0 force.

In 1954 Allais performed experiments in which he studied the behavior of paraconic pendulum by releasing the pendulum every 14 minutes and determining the normal of the plane of oscillation [17, 18, 19, 20]. Earth's rotation causes (apparent) rotation of this plane with velocity of .19 degrees per minute. The experiment happened to overlap 1954 solar eclipse. During the eclipse the pendulum took an unexpected turn, changing the angle θ defining the plane of oscillation by θ about 13.5 degrees. Allais repeated the experiments in 1959 and found similar result. The anisotropy of g implied by the result is about $\Delta g/g \simeq 3 \times 10^{-6}$, which looks very small as compared to the large value of θ . The explanation of apparent discrepancy is that Foucault pendulum amplifies very effectively small anisotropies for g for small values of oscillation amplitude and is therefore ideal for detecting these anomalies. During the last total eclipse August 11 1999 NASA repeated the experiment but the processing of the data is still going on. Allais observed also anomalies with periods of 24 and 25 hours in the behavior of oscillating paraconic pendulum.

1.8.1 Screening of dark Z^0 MEs emitted by Sun as an explanation of Allais effect?

In TGD framework one can imagine a possible explanation for the effect claimed by Allais in terms of classical Z^0 force and partial channelling of Z^0 electric gauge flux from "standard" space-time sheet to some other space-time sheets.

1. According to the TGD based models of atomic nuclei and condensed matter [F8, F9] a Foucault pendulum could have dark Z^0 charge. The modification of the Z^0 interaction of Foucault pendulum with Sun caused by the location of Moon between Sun and Earth could perhaps explain Allais effect. Dark neutrino cloud surrounding Sun is one possible source of Z^0 force. It seems that Z^0 Coulomb force, although present, is quite too weak. It is however possible that the interaction is mediated by Z^0 MEs, which carry Bose Einstein condensates of essentially massless dark Z^0 bosons behaving like laser beams so that the Z^0 field does not suffer $1/r^2$ decay. What would happen that the direction of the effective gravitational force on the surface of Earth changes due to Z^0 force of Sun so that also the direction of the plane of oscillation is changed. Since the effect becomes visible only during eclipse, screening of the Z^0 beam by absorption or is most probably involved but one cannot exclude the possibility that Moon acts amplifies the beam via induced emission.
2. If the Z^0 electric field of ME induces the effect the direction of force is orthogonal to the line connecting Earth to Sun. If the rotational motion of Sun causes the emission of Z^0 MEs and the resulting Z^0 field depends on the direction of Z^0 current of Sun in the same manner as in ordinary electrodynamics, the Z^0 electric field given by the time derivative of Z^0 vector potential is proportional to the Z^0 current at the surface of the emitting region and thus tangential to the plane of the orbit of Earth around Sun. Hence Z^0 electric field is in the orbital plane and induces a force which is tangential to Earth's surface and almost orthogonal to the Earth's gravitational field (the tilting of Earth's rotating axis induces small non-orthogonality). No effect is predicted if the rotation plane of the pendulum is in East-West direction and maximal effect results when the pendulum is in North-South direction.

3. The oscillation frequency of the pendulum and oscillation plane should exhibit day-night variation since also Earth modifies Z^0 beam and Earth's gravitational field are opposite at opposite sides of Earth. In fact, Allais has detected periodic variations with period of 24 and 25 hours in the behavior of the Foucault pendulum [19, 20]. 24 hour period would be naturally due to the modification of Z^0 beam by Earth and the 25 hour period could be due to the rotation of moon which means that the Sun at moon are at same line with a period which is slightly longer than 24 hours. Instead of 2π Earth must rotate the angle $2\pi + \Delta\Phi$, $\Delta\Phi \sim \frac{2\pi}{30} = 12$ degrees and thus the period is $T + \Delta T$, $\Delta T = \frac{12}{360} \times 24 = 4/5$ hours.

1.8.2 Quantitative picture

Consider now a more quantitative formulation of the model.

1. The force experienced by the pendulum is

$$\begin{aligned}\bar{F} &= [m\bar{g} + \bar{f}_Z]_{\perp} , \\ \bar{f}_Z &= \bar{f}_Z .\end{aligned}\tag{1.8.1}$$

where \bar{f}_Z refers to the net Z^0 force caused by Sun. The subscript ' \perp ' refers to the projection to the plane orthogonal to the direction of the pendulum.

2. If the screening caused by Moon by the absorption of Z^0 MEs, Moon effectively creates a shadow, whose size at the surface of Earth is essentially the shadow of Moon to Earth created by light from Sun. This means that effect is seen only during solar eclipse. The modification caused by Moon does not affect the direction of \bar{f}_Z , which is fixed completely by the geometry of the Z^0 beam and the proposed mechanism generating it. The modification can be parameterized using coefficient ϵ characterizing the reduction/increase of the magnitude of \bar{f}_Z :

$$\bar{f}_Z \rightarrow (1 - \epsilon)\bar{f}_Z .$$

For absorption ϵ is positive and negative for amplification.

3. Let \bar{t} denote the unit vector in the direction of the vector connecting the point of suspension for the pendulum and the point at which pendulum is released. Let \bar{n} denote the direction of \bar{F} . The normal for the plane of oscillation is given in the direction of $\bar{e} = \bar{n} \times \bar{t}$. When Moon is on the line of sight connecting Sun and Moon, the modification of \bar{f}_Z is largest. The change of the normal of the oscillation plane can be found from the change of the vector \bar{e} :

$$\begin{aligned}\bar{e} &\rightarrow \bar{e}_1 = \bar{e} + \Delta\bar{e} , \\ \Delta\bar{e} &= \Delta\bar{n} \times \bar{t} .\end{aligned}\tag{1.8.2}$$

$\Delta\bar{n}$ can be calculated from a detailed model for the screening of the Z^0 field of the neutrino cloud caused by the presence of the Moon. The value of the angle θ is given by

$$\sin(\theta) = \frac{|\bar{e}_1 \times \bar{e}|}{|\bar{e}_1||\bar{e}|} .\tag{1.8.3}$$

The upper bound for $\sin(\theta)$ is

$$|\sin(\theta)| \leq \frac{|\overline{\Delta g} \times \bar{t}|}{|\bar{g}||\bar{t}|} .\tag{1.8.4}$$

From this upper bound it is clear that if the release angle for pendulum is small so that the cross product $|\bar{g} \times \bar{t}|$ is small, gravitational anisotropy is amplified dramatically and Foucault pendulum is thus ideal method for detecting gravitational or other anomalies.

According to the experiments of Allais [19, 20] the following estimate holds true:

$$\frac{\epsilon f_Z}{mg} \simeq 3 \times 10^{-6} . \quad (1.8.5)$$

For MEs the \bar{f}_Z is approximately orthogonal to \bar{g} so that the strength of gravitational field effectively increases in the absence of screening. Since the change of the effective gravitational force of Earth is $-\epsilon f_Z(Sun)$, effective g is predicted to increase if ϵ is positive as it is for screening.

The value of the parameter ϵ can be estimated by studying the time dependence of $\delta g/g$ explaining the anomalous behavior of Foucault period with a period of 24 hours observed by Allais [19, 20]. The dependence of the size of the effect on the size and physical properties of the pendulum makes it possible to test further the model.

Bibliography

Online books about TGD

- [1] M. Pitkänen (2006), *Topological Geometro-dynamics: Overview*.
http://tgd.wippiespace.com/public_html/tgdview/tgdview.html.
- [2] M. Pitkänen (2006), *Quantum Physics as Infinite-Dimensional Geometry*.
http://tgd.wippiespace.com/public_html/tgdgeom/tgdgeom.html.
- [3] M. Pitkänen (2006), *Physics in Many-Sheeted Space-Time*.
http://tgd.wippiespace.com/public_html/tgdclass/tgdclass.html.
- [4] M. Pitkänen (2006), *Quantum TGD*.
http://tgd.wippiespace.com/public_html/tgdquant/tgdquant.html.
- [5] M. Pitkänen (2006), *TGD as a Generalized Number Theory*.
http://tgd.wippiespace.com/public_html/tgdnumber/tgdnumber.html.
- [6] M. Pitkänen (2006), *p-Adic length Scale Hypothesis and Dark Matter Hierarchy*.
http://tgd.wippiespace.com/public_html/paddark/paddark.html.
- [7] M. Pitkänen (2006), *TGD and Fringe Physics*.
http://tgd.wippiespace.com/public_html/freenergy/freenergy.html.

Online books about TGD inspired theory of consciousness and quantum biology

- [8] M. Pitkänen (2006), *Bio-Systems as Self-Organizing Quantum Systems*.
http://tgd.wippiespace.com/public_html/bioselforg/bioselforg.html.
- [9] M. Pitkänen (2006), *Quantum Hardware of Living Matter*.
http://tgd.wippiespace.com/public_html/bioware/bioware.html.
- [10] M. Pitkänen (2006), *TGD Inspired Theory of Consciousness*.
http://tgd.wippiespace.com/public_html/tgdconsc/tgdconsc.html.
- [11] M. Pitkänen (2006), *Mathematical Aspects of Consciousness Theory*.
http://tgd.wippiespace.com/public_html/genememe/genememe.html.
- [12] M. Pitkänen (2006), *TGD and EEG*.
http://tgd.wippiespace.com/public_html/tgdeeg/tgdeeg/tgdeeg.html.
- [13] M. Pitkänen (2006), *Bio-Systems as Conscious Holograms*.
http://tgd.wippiespace.com/public_html/hologram/hologram.html.
- [14] M. Pitkänen (2006), *Magnetospheric Consciousness*.
http://tgd.wippiespace.com/public_html/magnconsc/magnconsc.html.
- [15] M. Pitkänen (2006), *Mathematical Aspects of Consciousness Theory*.
http://tgd.wippiespace.com/public_html/magnconsc/mathconsc.html.

References to the chapters of books

- [C6] The chapter *Was von Neumann Right After All* of [TGDquant].
http://tgd.wippiespace.com/public_html/tgdquant/tgdquant.html#vNeumann.
- [D3] The chapter *The Relationship Between TGD and GRT* of [TGDclass].
http://tgd.wippiespace.com/public_html/tgdclass/tgdclass.html#tgdgrt.
- [D4] The chapter *Cosmic Strings* of [TGDclass].
http://tgd.wippiespace.com/public_html/tgdclass/tgdclass.html#cstrings. The chapter *Cosmic Strings* of [TGDclass].
http://tgd.wippiespace.com/public_html/tgdclass/tgdclass.html#cstrings.
- [D5] The chapter *TGD and Cosmology* of [TGDclass].
http://tgd.wippiespace.com/public_html/tgdclass/tgdclass.html#cosmo. The chapter *TGD and Cosmology* of [TGDclass].
http://tgd.wippiespace.com/public_html/tgdclass/tgdclass.html#cosmo.
- [D6] The chapter *TGD and Astrophysics* of [TGDclass].
http://tgd.wippiespace.com/public_html/tgdclass/tgdclass.html#astro. The chapter *TGD and Astrophysics* of [TGDclass].
http://tgd.wippiespace.com/public_html/tgdclass/tgdclass.html#astro.
- [D7] The chapter *Macroscopic Quantum Phenomena and CP₂ Geometry* of [TGDclass].
http://tgd.wippiespace.com/public_html/tgdclass/tgdclass.html#super.
- [F3] The chapter *p-Adic Particle Massivation: Hadron Masses* of [TGDpad].
http://tgd.wippiespace.com/public_html/paddark/paddark.html#padmass2. The chapter *p-Adic Particle Massivation: Hadron Masses* of [TGDpad].
http://tgd.wippiespace.com/public_html/paddark/paddark.html#padmass2.
- [F6] The chapter *Topological Condensation and Evaporation* of [TGDpad].
http://tgd.wippiespace.com/public_html/paddark/paddark.html#padaelem.
- [F8] The chapter *TGD and Nuclear Physics* of [TGDpad].
http://tgd.wippiespace.com/public_html/paddark/paddark.html#padnucl.
- [F9] The chapter *Dark Nuclear Physics and Living Matter* of [TGDpad].
http://tgd.wippiespace.com/public_html/paddark/paddark.html#exonuclear.
- [G2] The chapter *The Notion of Free Energy and Many-Sheeted Space-Time Concept* of [TGDfree].
http://tgd.wippiespace.com/public_html/freenergy/freenergy.html#freenergy.
- [I4] The chapter *Quantum Control and Coordination in Bio-systems: Part I* of [TGDselforg].
http://tgd.wippiespace.com/public_html/bioselforg/bioselforg.html#qcococI.
- [I5] The chapter *Quantum Control and Coordination in Bio-Systems: Part II* of [TGDselforg].
http://tgd.wippiespace.com/public_html/bioselforg/bioselforg.html#qcococII.
- [J5] The chapter *Wormhole Magnetic Fields* of [TGDware].
http://tgd.wippiespace.com/public_html/bioware/bioware.html#wormc.
- [J6] The chapter *Coherent Dark Matter and Bio-Systems as Macroscopic Quantum Systems* of [TGDware].
http://tgd.wippiespace.com/public_html/bioware/bioware.html#darkbio.
- [K3] The chapter *General Theory of Qualia* of [TGDholo].
http://tgd.wippiespace.com/public_html/hologram/hologram.html#qualia.
- [M3] The chapter *Dark Matter Hierarchy and Hierarchy of EEGs* of [TGDeeg].
http://tgd.wippiespace.com/public_html/tgdeeg/tgdeeg/tgdeeg.html#eegdark.
- [M5] The chapter *Quantum Model of EEG: Part II* of [TGDeeg].
http://tgd.wippiespace.com/public_html/tgdeeg/tgdeeg/tgdeeg.html#eegII.

References related to anomalies

- [16] Roshchin, V.V and Godin, S.M., *An Experimental Investigation of the Physical Effects in a Dynamic Magnetic System*, New Energy Technologies Issue #1 July-August 2001.
- [17] http://science.nasa.gov/newhome/headlines/ast12oct99_1.htm.
- [18] G. T. Gilles (1990), *American J. of Physics*, 58, 530 (review of work of Allais).
- [19] M. Allais (1959), *Should the Laws of Gravitation be modified?: Part I -Abnormalities in the Motion of a Paraconical Pendulum with Anisotropic Support*, *Aero/Space Engineering*, Sept 1959.
- [20] M. Allais (1959), *Should the Laws of Gravitation be modified?: Part II -Experiments in Connection with the Abnormalities the Motion of a Paraconical Pendulum with an Isotropic Support*, *Aero/Space Engineering*, Oct. 1959.
- [21] *Paraconical pendulum*, http://en.wikipedia.org/wiki/Paraconical_pendulum.
- [22] *Allais effect*, http://en.wikipedia.org/wiki/Allais_effect.
- [23] M. Allais (1959), *Should the Laws of Gravitation Be Reconsidered: Part I,II,III?*,
<http://home.t01.itscom.net/allais/blackprior/allais/lawgravit/lawgrav-one.pdf>
<http://home.t01.itscom.net/allais/blackprior/allais/lawgravit/lawgrav-two.pdf>.
 M. Allais, *The Allais effect and my experiments with the paraconical pendulum 1954-1960*.
<http://www.allais.info/alltrans/nasareport.pdf>.
- [24] G. T. Jeverdan, G. I. Rusu, and V. Antonescu, *Experiments using the Foucault pendulum during the solar eclipse of 15 February, 1961*, *Biblical Astronomer* 1 (55), 1820 (1981).
- [25] V. A. Popescu, D. Olenici (2007), *A confirmation of the Allais and Jeverdan-Rusu-Antonescu effects during the solar eclipse from 22 September 2006, and the quantization behavior of pendulum*.
<http://www.hessdalen.org/sse/program/Articol.pdf>.
- [26] Qian-Shen Wang *et al* (2000), *Precise measurement of gravity variations during a total solar eclipse*, *Phys. Rev. D*, vol. 62, 041101(R),
<http://home.t01.itscom.net/allais/blackprior/wang/wangetal.pdf>.
- [27] *French Nobel Laureate turns back clock: Marshall's global experiment, von Braun memories evoked during August 11 solar eclipse*,
http://science.nasa.gov/newhome/headlines/ast12oct99_1.htm.
- [28] I. Mihaila *et al* (2003), *A new confirmation of the Allais effect during the solar eclipse of 31 2003 May*.
<http://home.t01.itscom.net/allais/blackprior/mihaila/2003/mihaila2003.pdf>.
- [29] *Tides*, <http://en.wikipedia.org/wiki/Tides>.
- [30] Kozyrev N.A. "Prichinnaya ili nesimmetrichnaya mekhanika v lineinom priblizhenii.", Pulkovo, GAO AN SSSR, 1958, 90 p. (russian) ("Causal or asymmetrical mechanics in linear approximation.")
- [31] N.A. Kozyrev (1991) "Izbrannyye trudy.", Leningrad State University, 448 p. (russian) ("Selected works.")
- [32] Hayasaka H., Takeuchi S. (1989), *Anomalous weight reduction on a gyroscopes right rotation around the vertical axis of the earth*,
Phys. Rev. Lett., # 25, p.2701.
- [33] Lavrentiev M.M., Yeganova I.A., Medvedev V.G., Oleinik V.K., Fominykh S.F. "O skanirovanii zvyozdnogo neba datchikom Kozyreva."
Doklady Akademii Nauk SSSR, 1992, v.323, # 4. (russian) ("On the scanning of the star sky with Kozyrev's detector.")

- [34] Yu. V. Nachalov (1999) *Theoretical basis of experimental phenomena*
<http://www.amasci.com/freenrg/tors/tors3.html>.
- [35] Yu. V. Nachalov and A.N. Sokolov (1999) *Experimental investigation of new long-range interactions*
<http://www.amasci.com/freenrg/tors/doc17.html>.
- [36] B. DePalma (1995), *Notes on Faraday disc*.
<http://www.depalma.pair.com>.
- [37] P. Tewari, *Patent application for the space power generator of P. Tewari*.
<http://www.depalma.pair.com>.
- [38] E. Podkletnov and R. Nieminen (1992), *Physica C* 203 441. E. Podkletnov, "Weak gravitational shielding properties of composite bulk YBa₂Cu₃O_{7-x} super-conductor below 70 K under electromagnetic field", report MSU-chem 95, improved version (cond-mat/9701074).
- [39] R. Newman (1999), *Bicentenary of the Cavendish Experiment Conference*
<http://vishnu.nirvana.phys.psu.edu/mog/mog13/node11.html>.
- [40] U. E. Kruse, R. N. Tran (1995), *Cavendish experiment*,
<http://www.ccsr.uiuc.edu/~alfred/Ph101/Notes.htm/cavendish/index.html>.
- [41] E. G. Adelberger, B. R. Heckel, A. E. Nelson, *Tests of Gravitational Inverse-Square Law*.
<http://www.npl.washington.edu/eotwash/pdf/review.pdf>. For rumors about the weakening of the gravitational force below 100 μm distances see http://motls.blogspot.com/2005_06_01_motls_archive.html.
- [42] Nima Arkani-Hamed, Savas Dimopoulos, Gia Dvali (1998), *The Hierarchy Problem and New Dimensions at a Millimeter*, arXiv:hep-ph/9803315.
- [43] Baryshevsky V.G., Korennaya L.N.
Doklady AN BSSR, 1965, v.12, p.1 (russian).
- [44] Pokozaniev V.G., Skrotskii G.V. "Psevdomagnetizm."
Uspekhi fizicheskikh nauk, 1979, v.129, # 4. (russian).
- [45] Abragam A. "The principles of nuclear magnetism.", Clarendon press, Oxford, 1961.
- [46] Goldman M. "Spin temperature and nuclear magnetic resonance in solids.", Clarendon press, Oxford, 1970.
- [47] Krisch A.D. "The spin of proton."
Scientific American, may, 1979.
- [48] Akimov A.E., Kovalchuk G.U., Medvedev V.G., Oleinik V.K., Pugach A.F. "Predvaritelnyye rezultaty astronomicheskikh nabludenii po metodike N.A.Kozyreva.", Kiev, 1992, GAO AN Ukrainy, preprint # GAO-92-5R. (russian) ("Preliminary results of astronomical observations using N. A. Kozyrev's method.")
- [49] A. E. Akimov, *Torsion Technologies are XXI Age Technologies*, New Energy Technologies, Issue #1, July-August, 2001.
- [50] T. van Flandern (1998), *Phys. Lett. A*, vol. 250, no 1-3 p. 1-11.
- [51] Kibble T.W.B. // *J.Math.Phys.*, 1961, 2, p.212.
- [52] Sciama D.W.
Rev.Mod.Phys., 1964, 36, p.463.
- [53] Kopczynski W. "A non-singular Universe with torsion."
Phys.lett.A, 1972, # 39, p.219.

- [54] A. Trautman
Symp.Math., 1973, v.2, # 1, p.139.
- [55] Hehl F.W., Heyde P., Kerlick G.D., Nester J.M. "General relativity with spin and torsion: Foundations and prospects. //Rev.Mod.Phys., 1976, # 3, p.393.
- [56] Shipov G.I. "Teoriya fizicheskogo vakuuma.", Moscow, NT-Centr, 1993, 362 p. (russian) ("Theory of physical vacuum.")
- [57] R. M. Kiehn (199), *Electromagnetic waves in vacuum with torsion and spin*
<http://www22.pair.com/csd/pdf/helical6.pdf>.
- [58] H. Morgan (1998), *Aerospace and Electronic Systems*, January, p. 5-10.
- [59] S. E. Shnoll *et al* (1998), *Realization of discrete states during fluctuations in macroscopic processes*, Uspekhi Fisicheskikh Nauk, Vol. 41, No. 10, pp. 1025-1035.
- [60] D. Freed (2002), *A New Paradigm of time: part II*, Explore!, Vol. 11, No 5.
- [61] E. Podkletnov and G. Modanese (2002), *Investigation of high voltage discharges in low pressure gases through large ceramic super-conducting electrodes*,
<http://xxx.lanl.gov/abs/physics/0209051>.
- [62] V. Chernobrov (1996), *Experiments on the Change of Direction and Rate of Time Motion*, Proc. of III Int. Conf. On Problems of Space, Time, and Gravitation, Russian Academi of Sciences, St. Petersburg, Russia.
- [63] D. Reed (2003), *Conceptual Hurdles to New Millennium Physics*, Explore!, vol 12, No 1.
- [64] R. Y. Chiao (2002), *Super-conductors as transducers and antennas for gravitational and electromagnetic radiation*. arXiv:gr-gc/0204012v2 11 April.

Chapter 2

The Notion of Free Energy and Many-Sheeted Space-Time Concept

2.1 Introduction

In this chapter the T(opological) G(eometro)D(ynamics) based vision about new energy technologies is discussed. There are close connections to the basic mechanisms of energy metabolism in living matter in TGD Universe and one cannot avoid reference to TGD inspired quantum theory of consciousness.

2.1.1 Basic new elements of TGD ontology

The ontology of TGD Universe involves several new elements. The assumption that space-times are 4-surfaces in 8-dimensional imbedding space $M^4 \times CP_2$ leads to the notion of many-sheeted space-time meaning that each physical system can be said to correspond to space-time sheet, its own sub-universe in the geometric sense, and glued to a larger space-time sheet and containing subsystems as smaller space-time sheets glued to it. p-Adic length scale hypothesis quantifies this notion.

Many-sheeted space-time leads to the notion of field body [F9, N1, J7] distinguishing between TGD and Maxwell's electrodynamics. One can assign to each physical system a field body (or magnetic body) and in the case of living matter it acts as intentional agent using biological body as a sensory receptor and motor instrument. This profoundly changes the view about what we ourselves are.

Zero energy ontology [C2] states that any physical system has a vanishing net energy so that everything is creatable from vacuum. Zero energy states decompose into positive and negative energy parts and positive energy ontology results in certain limit in a good approximation. The possibility of negative energy signals is one important implication and a considerable modification of thermodynamics is forced by the fact that different signs of energy correspond to different arrows of geometric time.

Negative energy signals propagating to the geometric past inspire a new vision about communications and energy technology. The implications are especially important for the understanding of living matter where both time directions manifest themselves. In neuroscience a radically new view about memory based on the notion of 4-D brain emerges.

The hierarchy of Planck constants [A9] implies a generalization of the notions of imbedding space and space-time and macroscopic quantum coherence in all length and time scales at high enough levels of dark matter hierarchy assigned to the hierarchy of Planck constants. The consequences of this hypothesis are powerful: entire cosmos should be in a well-defined sense a living system with dark matter representing higher level conscious entities.

The original motivation for the p-adic physics [E1] were the highly successful calculations of elementary particle masses based on p-adic thermodynamics and conformal invariance [F3]. The model explained not only the ratio of proton and Planck masses but also masses of particles with an excellent accuracy. The only sensible interpretation of p-adic physics seems to be as physics of cognition and intentionality meaning that cognition is present even at elementary particle level.

The necessity to fuse p-adic physics corresponding to different primes p forces a generalization of the notion of number by gluing different number fields together along common rationals and al-

gebraics. This leads to a further generalization of the notions of imbedding space and space-time. The basic idea is that p-adic space-time sheets are representations for intentions and cognitions and their transformation to real ones in quantum jumps corresponds to the transformation of intention to action. Zero energy ontology is absolutely essential for this interpretation to make sense. p-Adic space-time sheets have literally infinite size in the real sense which means that cognition and intentionality are cosmic phenomena whereas cognitive representations defined by discrete intersections of real and p-adic space-time sheets obeying same algebraic equations have finite size.

2.1.2 Could living systems teach us something about energy technology?

One of the basic problems in energy technology is the necessity to carry fuel. This defines the most serious restriction to space travel.

Biological systems have resolved this problem by using sunlight as an energy source. The basic idea is very simple: solar radiation induces a dissociation of molecules to atoms which then re-associate and liberate metabolic energy. The hydrocarbons serving as fuel are recycled and there is a division of labor: animals cells burn the hydrocarbons to carbon dioxide and plants regenerate the hydrocarbons in photosynthesis.

Most of our energy technologies lack this kind of recycling. For instance, fuel in cars is burned to carbon dioxide and various wastes. If recycling were possible and if the density of potential energy sources in space were high enough, the amount of fuel would not depend on the distance travelled. This observation suggests self-organizing and perhaps in some primitive sense living technology and thus a connection with a fundamental problem of understanding how life has evolved. TGD provides a quantum model of both ordinary and pre-biotic life [L4, J7] and one can hope that this might help to develop a vision about "living" energy technology.

The recycling need not resolve completely the problems related to the fuel. The optimal solution would be "No fuel at all" with fuel serving only as an energy reserve. The system should be able to suck the energy from a system able to provide it. This is possible in TGD Universe [K6, J7]. Zero energy ontology implies that systems can get energy by sending negative energy signals to a system serving as an energy storage. Population inverted laser like system is the simplest system that one can imagine. Negative energy signals have interpretation as phase conjugate laser light. By the analog of stimulated emission negative energy quanta can also induce a cascade in population inverted laser like system so that system could send positive energy signal to the receiver. "Quantum credit card" is indeed the basic metabolic mechanism in TGD inspired quantum biology making possible instantaneous metabolic energy gain. The mechanism is also extremely flexible, which is a definite evolutionary advantage "in jungle".

The quantization of metabolic currencies is essential in living matter and this engineering principle is realized in TGD Universe at the fundamental level [J7]. The energies liberated in the dropping of particles to larger space-time sheets correspond to the increments of zero point kinetic energy (forgetting the interaction energy with matter) and by p-adic length scale hypothesis they are quantized. The basic metabolic energy currency of living matter, which is about .5 eV, corresponds to the dropping of proton from space-time sheet having atomic size scale.

One can also worry about how to transfer the positive quanta of radiation energy over large distances since also other systems than receiver could do it. Also negative energy signals intended to be amplified to much larger positive energy signals in population reverted laser might be absorbed during their travel. Here the quantization of Planck constant might come in rescue. For instance, if photons with energies equal to those of visible or UV photons or even of gamma rays, are transformed to dark photons with much longer wavelength, one can hope that only systems able to transform this radiation into ordinary photons can absorb it. It might well be that water, which is the basic element of living matter, is exceptional in the sense that it can induce the transformation to dark photons and back. The transformation of large Planck constant photons to ordinary ones makes also possible control of shorter length and time scales by much longer ones.

2.1.3 Various anomalies as support for the picture

There are surprisingly many well established anomalies supporting the new ontology and these anomalies have been a strong guiding line in attempts to construct a general theoretical framework.

1. There is a considerable support for many-sheeted space-time quantified by p-adic length scale hypothesis. Quite recently I learned about an anomalous radiation from interstellar dust having no generally accepted interpretation in terms of molecular transitions. The interpretation in terms of metabolic energy quanta liberated in dropping of electrons or protons to larger space-time sheets makes sense. A characteristic fractal spectrum involving period doubling is predicted.
2. The Bohr quantization of radii of planetary orbits [50, D6, D8] and quantal effects of ELF em fields on vertebrate brain [M3] helped considerably to develop the ideas about the hierarchy of Planck constants. Later a lot of further anomalies have emerged supporting the quantization of Planck constant. For instance, in gravitational sector Allais effect [67, D3] and accelerating cosmic expansion [D5] support the view about quantum coherence and quantum transitions in astrophysical and even cosmic scales [D6, D8]. Inflationary cosmology is replaced by quantum critical cosmology in TGD framework [D5].
3. Living matter is one gigantic bundle of anomalies of recent day physics and the notion of field body combined with p-adic length scale hypothesis allows to develop detailed models for how magnetic body controls biological body and receives sensory input from it [J7]. In particular, a successful model for EEG results [M3] and involves hierarchy of Planck constants in an essential manner. One can say that field body applies remote mental interactions to biological body and the so called paranormal phenomena [H9, H10] differ in no essential manner from those encountered in bio-control. The notion of field body leads also to a concrete model for pre-biotic life [L4] based on the notion of plasmoid involving magnetic body controlling plasma phase [N1, J7].
4. The so called "free energy" phenomena have as bad reputation as cold fusion and homeopathy among most physics professionals: ironically all these disputed anomalies seem to find a natural place in TGD based world order [G2, F9, K5], which suggest that theoreticians should take experimentalists much more seriously. Typically "free energy people" make claims about over-unity production of energy but more or less as a rule the results fail not been reproducible.

Over-unity effects are the basic claim of free energy community. TGD indeed allows temporary over-unity effects [G2]: the basic mechanism is dropping of particles on larger space-time sheets liberating zero point kinetic energy appearing as basic metabolic mechanism in TGD inspired theory of living systems. This mechanism does not allow a perpetuum mobile: the particles must be kicked back to smaller space-time sheets and in ordinary living matter solar radiation takes care of this. Rotating magnetic systems [49] define one especially interesting and complex case discussed thoroughly in [G1].

2.1.4 Free energy anomalies

The models for "free energy" phenomena developed much before the recent overall view summarized above had emerged. I know quite well that the reality of these phenomena is debatable and the poor quality of data makes models speculative. I however feel that these models might serve as good theoretical exercises.

1. Podkletnov- and Modanese-Podkletnov effects

The explanation of Modanese-Podkletnov effect [22] shares many common elements with the model of Podkletnov effect and actually led to the correct track allowing to eliminate competing models.

The "dropping" of electrons to the space-time sheets of topological light rays emitted by a critical system would be the key mechanism besides rotation induced charging. During discharge of the capacitor during discharge (Modanese-Podkletnov effect) this mechanism would induce the motion of test penduli. In the case of a super-conductor making repeatedly a transition to a non-superconducting state (Podkletnov effect) this mechanism would induce the motion of air above super conductor and apparent loss of weight of test particles. Biefeld-Brown effect associated with lifters and corona wind can be explained by the same mechanism as Modanese-Podkletnov effect. Podkletnov effect is enhanced by the em and Z^0 charging induced by rotation and thus involve also the em and Z^0 variants of Searl effect [G1].

5. Over unity effects

Over-unity effects are the basic claim of free energy research community. TGD indeed allows temporary over-unity effects: the basic mechanism is dropping of particles on larger space-time sheets liberating zero point kinetic energy appearing as basic metabolic mechanism in TGD inspired theory of living systems. This mechanism does not allow a perpetuum mobile: the particles must be kicked back to smaller space-time sheets and in ordinary living matter solar radiation takes care of this. There are also anomalies associated with the dissociation of water and hydrogen molecules. The hydrino atom concept of Mills is also closely related to these anomalies and TGD based justification for the notion is discussed in this chapter.

Since consciousness (memory and intentional action in particular), biology, and new views about energy, communication, and control are tightly related in TGD framework, I will discuss all these topics as a single coherent whole in the following in the hope of demonstrating the unifying power of this conceptualization.

2.2 Basic ontology of TGD

TGD leads to an ontology which is new in many respects. The notion of space-time generalizes in several manners. One ends up to the so called zero energy ontology, which means that negative energies are possible and all possible universes are creatable from vacuum. Planck constant, which in the standard quantum theory is a genuine constant, has a discrete spectrum of values and the values can be arbitrarily large [A9, J7]. This means that Universe is a macroscopic quantum system in all scales.

Dark matter could be identified as ordinary matter for which Planck constant differs from its ordinary value so that the interactions with ordinary matter differ in their character from ordinary interactions. Note that TGD predicts also new forms of matter completely dark with respect to electro-weak interactions [F4, D8].

Dark matter with a large Planck constant is in a key role in the TGD based model of living matter [TGDware]. Because the new ontology is so central from the point of view of TGD inspired theory of consciousness and living matter, I will represent the basic ideas of TGD using applications to quantum biology to concretize their implications.

2.2.1 T(opological) G(eometro)D(ynamics) very briefly

TGD is a unified theory of fundamental interactions which has developed during 28 years [TGDview] and at the same time expanded to a theory of consciousness providing a model of quantum biology. The key ideas of TGD are following.

1. TGD can be seen as a generalization of either hadronic string model or super-string model (M-theory). The 1-dimensional (1-D) strings moving in 10- or 11-dimensional space are replaced with 3-D surfaces moving in 8-D space. This means that the 2-D orbits of strings are replaced with 4-D surfaces identified as our 4-D space-time but in a widely generalized sense. A further assumption is that these 3-surfaces are "light-like". This assumption bringing in mind esoteric teachings has a purely geometric meaning, and makes it possible to generalize and extend the conformal symmetries responsible for the miraculous mathematical properties of super-string models. These symmetries are in a central role in the formulation of quantum TGD.

2. Another manner to end up with TGD is via a search for a modification of general relativity solving the so called energy problem of general relativity. In general relativity the notions of energy and momentum are not well-defined since the translational symmetries responsible for their existence are lost as space-time becomes curved. If one assumes that 4-dimensional space-time is a 4-D surface in a higher-D space obtained by replacing the points of the empty space-time of special relativity (Minkowski space) with certain internal space- call it S - having a very small size, the basic symmetries of Minkowski space become those of higher-D space and energy and momentum continue to be well-defined and one obtains a description of gravitation in terms of space-time curvature.

3. The surprise was that this leads to a unified theory for all known interactions - electromagnetic, weak, strong, and gravitational - if one chooses the space S suitably. The proper choice is $S = CP_2 = SU(3)/U(2)$, the complex projective space of 2 complex dimensions.

2.2.2 Many-sheeted space-time and the notion of field body

Many-sheeted space-time is one of the basic implications of TGD.

1. Both 3-space and 4-D space-time consists of sheets forming a hierarchical structure ordered with respect to the size of the sheet. Each sheet can be identified as a subsystem, which can correspond to any object of our nearby environment, astrophysical object, cell level system, atom, etc... My own body defines my own private space-time sheet. Quite generally, the topology of space-time codes for various physical structures.

2. Every system is accompanied by various kinds of fields such as electromagnetic and gravitational fields. These fields cannot be assigned to any particular subsystem in standard physics. In TGD the situation is different: one can assign to each system a "field body" consisting of field quanta. For instance, magnetic body consists of quanta of magnetic flux (tubes, sheets,...) realized as space-time sheets much larger than the system. One can also speak about field bodies which mediate interactions and connect different systems ("relative field bodies").

3. In TGD inspired theory of consciousness field body is the "intentional agent" which receives sensory information from the biological body and utilizes it as a motor instrument. The finding of Libet [19] that our sensory data has age which is a fraction of second could be understood in terms of time lapse resulting from the communication of sensory data to the magnetic body using EEG. From Uncertainty Principle one can conclude that in the case of EEG the size scale of magnetic body is of order of size of Earth. As a matter fact, magnetic body is predicted to have onion-like fractal structure and communications to various layers of the onion would take place using fractal variants of EEG. The existence of fractally scaled variants of some parts of EEG (alpha band and its harmonics in particular) is a testable prediction of the model.

4. What is also new and highly non-trivial is that field body and biological body are essentially four-dimensional structures. The brain and body of geometric past still exist as conscious entities having mental images which we experience as memories. Biological death means only the arrival of a particular wave of consciousness to the time-like boundary of a 4-D body. Consciousness at the level of 4-D body does not cease: our past lives.

5. Many-sheeted space-time leads also to a generalization of the notion of subsystem which in TGD inspired theory of consciousness corresponds to a subself experienced by self (system) as a mental image. What is new is the paradoxical sounding prediction that even in the case that two systems are unentangled, subsystems can entangle. Entanglement of subselves can be interpreted as giving rise to sharing and fusion of mental images giving rise to a kind of stereo consciousness (stereovision would be one example of this). Consciousness would not be completely private and there would exist a pool of shared and fused mental images making for instance possible to assign universal meaning to the symbols of language. This new view about entanglement was originally motivated by the observation that two space-time sheets condensed at larger space-time sheets can be connected by bonds while the larger space-time sheets can remain unconnected (see Figure 3). By quantum classical correspondence the bonding of the space-time sheets serves as a space-time correlate for entanglement. Much later (only a couple years ago) the generalization of quantum measurement theory by introducing the notion of finite measurement resolution allowed to mathematicize this concept [C6, A9]. Entanglement is always defined with respect to a resolution characterizing the system and the entanglement of subsystems is not visible in the resolution characterizing the system. The notions of quantum groups and non-commutative geometry emerge naturally in the description of finite measurement resolution.

2.2.3 The hierarchy of Planck constants and of dark matter

The hierarchy of Planck constants is a relatively new element of TGD. The idea emerged as I constructed a model of topological quantum computation [E9] and after learning about the work of Nottale [50] I realized that the notion is more or less forced by quantum classical correspondence implying that space-time sheets define regions of macroscopic quantum coherence and by the fact that they can have arbitrarily large size.

Physical motivations for introducing the hierarchy of Planck constants

There are several reasons to consider the possibility that Planck constant \hbar is actually not a constant but can have a set of quantized values which can be arbitrarily large.

1. One observation is the quantization of the radii of planetary orbits (also those of exo-planets) in the same manner as in the case of hydrogen atom [50]: now however the value of Planck constant is gigantic: $h/h_0 = GMm/v_0$, where M and m are the masses of Sun and planet, G is Newton's constant and v_0 is a dimensionless constant (in units $c = 1$), whose favored value is $v_0 = 2^{-11}$. Also other values are possible. In TGD based model [D6, D8] the gravitational Planck constant is assigned with the "relative field bodies" connecting Sun and planet and mediating gravitational interaction between them. The interpretation is that gravitational Planck constant is associated with dark matter, which is macroscopic quantum phase in astrophysical scales. Visible matter condensed around dark matter would reflect the quantal properties of dark matter.

2. Second motivation comes from the observed effects of ELF radiation on vertebrate brain [18], which can be both physiological and affect behavior. These effects appear at harmonics of cyclotron frequencies of biologically important ions (in particular Ca^{++} ion) in a magnetic field of $B = .2$ Gauss (the nominal value of Earth's magnetic field is .5 Gauss) and are very quantal. These frequencies are in EEG range (harmonics of 15 Hz for Calcium ion). Standard quantum mechanics does not allow quantal effects since the energy of EEG photons is extremely low and much below the thermal energy at body temperature. If the value of \hbar is large enough, the effects of ELF photons are not masked by thermal noise, and the effect can be understood [M3].

3. If EEG consists of photons with large Planck constant, one can understand the correlation of EEG with the state of brain and contents of consciousness [M3]. In particular, temperature ceases to be a restriction for life: for sufficiently large Planck constant even the interiors of planets and Sun could serve as seats of life of some kind. This kills a central counter argument against the claim of a Romanian group of physicists that since the plasmoids created in electric circuits possess some basic features assigned usually to life, they indeed represent primitive life forms [25].

4. The mathematization for the notion of Planck constant hierarchy [A9] involves a further generalization of the space-time concept discussed in the Appendix. The basic prediction is that Planck constant corresponds to a discrete subgroup of rotation group acting as the symmetries of the field body of the dark matter system. A hierarchy of favored values of Planck constant and symmetry groups emerges from simple number theoretic arguments. For instance, $h = nh_0$, $n = 5, 6$, correspond to the favored values of Planck constant. In this case the symmetry group would correspond to the symmetries of 5- and 6-cycles appearing in polycyclic aromatic hydrocarbons [36, 37] known to be important for life. Examples are the cycles appearing in DNA, in some aminoacids, in most hallucinogens except alcohol, and PAHs in the interstellar space [36, 37] believed to result via photosynthesis and believed to be predecessors of aminoacids and other bio-molecules.

5. The basic prediction is that large values of Planck constant correspond to discrete symmetries: typically discrete group of symmetries acting as rotations around a fixed symmetry axes. These symmetries acted as symmetries of dark field body. In the original view about generalized imbedding space (Appendix) these symmetries would be almost continuous symmetries for larger values of Planck constant. The breaking of these symmetries at the level of visible matter condensed around dark matter could lead to much smaller subgroups of these symmetry groups and structures analogous to those appearing in molecular physics could be the outcome. The further generalization of imbedding space (Appendix) allows also discrete symmetry groups Z_n for dark matter with small value of n and also genuinely three-dimensional symmetry groups (tetrahedral, octahedral, icosahedral, and octahedral). There is evidence for this kind of symmetries. For instance, there is a strange hexagonal structure appearing at the North pole of Saturn [43]. Planetary rings is second example and some of them even contain helical structures analogous to DNA double strand [44].

6. Large Planck constant photons at radio frequencies could interact strongly with living matter and it would become possible to communicate with living matter over very long distances. This mechanism would involve a de-coherence of large Planck constant photons to ordinary ones with same energy or a bundle of ordinary photons with much smaller energy. This brings in mind the recent discovery that the irradiation of salt water by radio waves at harmonics of frequency 13.4 Ghz makes it "burn" that is emit burning gases [68]. A possible explanation is that radio wave photons are transformed in water to photons of same frequency but much larger Planck constant and in de-coherence to ordinary photons with same energy become microwave photons which excite rotational excitations of NaCl (in equilibrium with Na^+ and Cl^- ions) and in this manner heat it just like microwave oven does [F9]. The required value of Planck constant would be by a factor $2^{10} = 1024$ larger than normal Planck constant. This value is one of the number theoretically simple values defined as ratios of integers defining polygons constructible using only ruler and compass [A9]. For

water molecules the needed value of Planck constant is obtained from the microwave oven frequency 2.45 GHz and would be with .1 per cent accuracy equal to $h/h_0 = n = 187 = 11 \times 17$: n does not belong to the set of number theoretically simple values of n but one cannot of course exclude it.

The notion of field body and dark matter

The conclusion would be that each physical system is accompanied by a field body with a fractal, onion-like, structure formed by field bodies. This leads to the following vision about the nature of living matter.

1. Each layer of the onion is characterized by the value of Planck constant telling its position in the hierarchy of dark matter.

2. At the surface of the onion the value of Planck constant is largest and in some sense defines the "IQ" of the system. At the level of molecules one expects rather low values of Planck constants. For instance, the magnetic body assignable to the ordinary EEG as has of order Earth size and the lifetime of human (say 70 years) would correspond to a layer with size of order light-life (70 light years). Even higher layers might be present: transpersonal states of consciousness would indeed naturally correspond to these layers.

Field body receives information from the biological body and quantum controls it.

1. In the case of ordinary living matter field body would naturally receive information from cell membranes, which are full of receptors monitoring the state of environment. This leads to the idea that cell membranes are Josephson junctions and that Josephson currents code this information and communicate it to some layer in the onion formed by magnetic bodies. Dark matter hierarchy suggests even the existence of fractally scaled up counterparts of cell membrane and the TGD based model of EEG relies on this assumption. What is encouraging that the model predicts correctly the decomposition of EEG into bands, in particular alpha band, explains why high arousal correspond to chaotic looking activity in beta band, and predicts also correctly the positions of narrow sub-bands in beta and theta bands [21]. The strange findings challenging pump-channel paradigm [24] (ionic currents seem to be quantal and same even for artificial membranes; currents continue to flow in absence of metabolism) support superconductivity hypothesis and suggest that ordinary Ohmic currents are only for the purposes of measuring the concentrations of various ions in cellular environment and that metabolic energy goes to the communications to the magnetic body using generalized EEG.

2. Magnetic body controls biological body through the genome. This inspires the hypothesis that magnetic flux sheets go through DNA strands and genes form what could be regarded as text lines at the page of book defined by the flux sheet. The quantization of magnetic flux with unit proportional to Planck constant implies that for large values of \hbar the flux sheets are very wide and can go through a large number of genomes. One ends up with the notion of super genome meaning that coherent collective gene expression becomes possible in the scale of organ and organism. Hyper genome would in turn fuse the super-genomes to a larger structure making possible coherent collective gene expression at the level of species and population [M3, L1]. This would bring to the theory of evolution completely new "synergetic aspect" and evolution would be much more than fight for survival.

3. The interaction between field body and biological body is essentially remote mental interaction so that paranormal phenomena would differ from normal biological basic interactions only in that field body uses external biological body to remote viewing or psychokinesis.

4. There are good reasons to assume that field bodies have developed magnetic immune systems to prevent the use of their private biological bodies by alien field bodies. Hypnosis would be example of this kind of possession by a foreign field body. This immune system can be compared to fire wall in computer world (assuming that we have created computers as our own images).

1. The height of the fire wall depends on individual. For very sensitive persons it is very low and these people are very sensitive to suggestions, hypnosis, spiritual experiences, and even encounters of ETs. Very high fire wall makes it impossible to receive even useful information and the fire wall of skeptic might be too high.

2. In the case of computers viruses and cookies are very simple programs making possible for an external computer to partially "possess" the computer via web. Their role is to serve as kind of mediums or couriers. In the case of field body viruses and cookies would correspond to very simple life forms to which immune system does not bite: plasmoids are natural candidates in this

respect. This would suggest that anomalous light phenomena ("UFOs") are actually plasmoids (unidentified moving processes rather than objects).

Plasmoids could quantum entangle the brains of the sensitive person to some conscious entity at some higher level of hierarchy and the person would fall in a trance like state able to share mental images of this entity. Patterns of magnetic pulses can be used to generate alternative states of consciousness [37] and the patterned motion of the magnetic body of plasmoids (kind of dance like motor expression!) consisting of flux tubes and sheets with respect to the observer could generate this kind of pulse patterns.

It has been observed that some moving light balls indeed involve magnetic pulses with maximal field strength of about .3 Gauss and typical strength which is 10 times weaker [64]. The prediction is that the durations of pulses should be inversely proportional to the velocity of motion of the light balls. Also the motion of a magnetometer with respect to living system might course similar pulses.

2.2.4 Zero energy ontology

In standard physics the sign of energy is positive. This leads to philosophical problems. The problematic question is what are the values of the conserved quantities of the universe (energy, em charge, quark and lepton number). An additional difficulty is caused by the fact that they are very naturally infinite in positive energy ontology. These questions cannot be answered with the framework of standard physics. On the other hand, TGD inspired cosmology led to a different interpretational problem: the density of non-conserved gravitational mass was non-vanishing as in standard cosmologies but the density of inertial energy vanishes [D5]. The construction of quantum TGD [C2, A1, A2] finally led to so called zero energy ontology which resolves this problem and also the problems due to the positive energy ontology.

1. All quantum states possess vanishing net values of conserved quantum numbers such as an energy. Or stating it otherwise: every physical state is creatable by intentional action from vacuum.
2. Zero energy states decompose into positive and negative energy states such that negative energy state is in the geometric future. If the temporal distance between positive and negative energy states is long as compared to the time scale of perception, the usual positive energy ontology works well. In the opposite case the zero energy state can be interpreted as a quantum fluctuation having no importance for the world as we perceive it.

Zero energy ontology and unification of the notions of S-matrix and density matrix

Zero energy ontology states that physical states have vanishing net conserved quantum numbers and states decompose into positive and negative energy state and that the latter one can be said to be located in the geometric future of the positive energy state at the time-like boundary of the space-time sheet representing the system. It is possible to speak about energy of the system if one identifies it as the average positive energy for the positive energy part of the system.

The matrix ("M-matrix") representing time-like entanglement coefficients between positive and negative energy states unifies the notions of S-matrix and density matrix since it can be regarded as a complex square root of density matrix expressible as a product of real squared of density matrix and unitary S-matrix. Essentially matrix valued Schrödinger amplitude is in question with S-matrix representing its "phase". An open question is how universal S-matrix is. The system can be also in thermal equilibrium so that thermodynamics becomes a genuine part of quantum theory and thermodynamical ensembles cease to be practical fictions of the theorist. In this case M-matrix represents a superposition of zero energy states for which positive energy state has thermal density matrix.

1. If the positive energy parts of zero energy states appearing in the superposition have only single value of energy, the notion of remote metabolism is certainly well-defined. Even in the case that the system is thermalized remote metabolism makes sense since average energy can be increased by remote metabolism. One can even imagine a statistical variant of the process in which the temperature increases.
2. The critical question is whether crossing symmetry prevails in the sense that the positive energy signal propagating to the geometric future is equivalent to a negative energy signal propagating to geometric past. The eigen modes of the modified Dirac operator appearing in the first principle

formulation of quantum TGD are characterized by the eigenvalues λ , which are complex. $|\lambda|^2$ has interpretation as a conformal weight mathematically analogous to a vacuum expectation value of Higgs field [B4].

Time mirror mechanism

Zero energy ontology gives justification for the time mirror mechanism which is the fundamental mechanism of TGD inspired model of quantum biology. To avoid confusion one must distinguish between two times: geometric and subjective time. The latter corresponds to a sequence of quantum jumps giving rise to the conscious sensation of flow of time [TGDconsc, K1, H5]. Geometric time corresponds to the time of physicist identified as the fourth space-time coordinate. These times are only loosely related and their identification is only approximate and makes sense only in some states of consciousness. Indeed, subjective time is irreversible and no subjective future exists whereas geometric time is reversible and both future and past exist.

1. Symbolic (declarative memories) can be understood as communications of some onion layer of magnetic body with the brain of the geometric past [H6]. A signal consisting of negative energy phase photons (identifiable as phase conjugate photons in nonlinear optics) with larger Planck constant represents a question to the brain of the geometric past which responds automatically by sending a positive energy signal to the magnetic body in the geometric future. Episodal memories which correspond to literal re-experiences result by time-like quantum entanglement for subsystems representing the mental images.
2. Time mirror mechanism makes possible to realize intentions by sending negative energy signals to the brain of the geometric past and inducing neural activity leading to a motor response in the brain of geometric future [H1, J7]. This kind of mechanism allows more or less instantaneous reaction and provides an evolutionary advantage in "jungle". The mechanism explains Libet's findings[20] that neural activity is initiated in brain already before the conscious decision. In the usual ontology the interpretation would be that free will is only apparent. In the recent context "before" refers to the geometric rather than subjective time, so that free will is possible and assigned to the quantum jump identified as a moment of consciousness. Dark matter hierarchy implies infinite hierarchy of moments of consciousness with moments of consciousness giving rise to the analog of dark matter hierarchy at the level of conscious entities.
3. The system can receive positive energy as a recoil energy by sending negative energy to a system of geometric past able to receive it. A system analogous to a population inverted laser having more particles in a state of higher energy, is ideal provider of energy. The resulting quantum credit card makes it possible to react very rapidly in situations encountered in "jungle". I have christened this mechanism remote metabolism and magnetic body could use it to suck metabolic energy from brain or body to its own purposes by sending phase conjugate dark (generalized) EEG photons to the biological body. In the case of declarative memories the excited state of the laser like system would naturally correspond to bit 1 and ground state to bit 0 [H6]. Metabolic energy would be needed to restore the mental image since the process of memory recall would tend to reduce the population of excited states. Note that remote metabolism would be tailor made for say space travel since there would be no need to carry the fuel: if "UFOs" exist they might apply this kind of energy technology.
4. Many-sheeted space-time provides a concrete realization of the laser like systems as many-sheeted lasers. The "dropping" of particles from smaller to larger space-time sheets liberates zero point kinetic energy [J7]. If the interaction energy with the matter at the space-time sheet can be neglected, p-adic length scale hypothesis makes precise predictions about the maximal liberated energies. The standard metabolic energy currency of about .5 eV of living matter corresponds to the dropping of proton from a space-time sheet of atomic size. Actually a fractal hierarchy of universal metabolic currencies is predicted and should be present already during the pre-biotic evolution so that the chemical storage of energy is not necessary for a primitive metabolism [L4]. The transitions corresponding to the dropping of particles should be visible in astrophysics and there are indeed exist three kinds of narrow bands of radiation in both visible and infrared range without identification in terms of known molecular transitions (see discussion below). The

energies of the photons in question are consistent with p-adic length scale hypothesis and allow an interpretation in terms of proposed transitions assuming that there is some binding energy with the matter at the smaller space-time sheet [39].

More detailed view about time mirror mechanism in zero energy ontology

The notion of negative energy signals and time mirror mechanism emerged before zero energy ontology. Since the mechanisms of remote metabolism, of memory, and of intentional action rely on time mirror mechanism, one should check that this mechanism is indeed consistent with zero energy ontology. Zero energy ontology could also yield new insights to these mechanisms.

1. Is zero energy ontology consistent with time mirror mechanism?

Energy conservation and geometric arrow of time poses strong conditions on the mechanism. If positive energy part of state sends negative energy signal, then negative energy part of state must send a compensating positive energy signal. Furthermore, positive (negative) energy signals propagate towards geometric future (past).

1. If only single space-time sheet is involved, either negative energy signal $S_-: X_-^4 \rightarrow Y_-^4$ or positive energy signal $S_+: X_+^4 \rightarrow Y_+^4$ is possible. The energy of both states is reduced in magnitude. For instance, this process tends to reduce destroy long term memories represented as bit sequences with bit represented by population inverted laser system.
2. Second possibility is that X^4 and Y^4 are disjoint and X^4 is in the geometric future of Y^4 .

The first possibility is $S_+: X_+^4 \rightarrow Y_+^4$ and negative energy signal $S_-: X_-^4 \rightarrow Y_-^4$: the energy of both X^4 and Y^4 is reduced in this case.

Second possibility is $S_-: X_+^4 \rightarrow Y_+^4$ and $S_+: Y_-^4 \rightarrow X_-^4$. X^4 would suck energy from Y^4 in the geometric past. This option could correspond to both remote metabolism, memory recall, and intentional action. The presence of topological light ray connecting two systems would be also a correlate for time-like quantum entanglement making possible sharing and fusion of mental images and creating a sensation about flow of time just like it creates sensation of depth in stereo vision by fusion of right and left visual fields. Depending on the sign of the energy of the signal one would have memory or precognition. Precognition would require use of metabolic energy and this might be one reason for why it is rather rare.

3. Suppose next that the zero energy space-time sheet, call it X^4 , is inside larger space-time sheet, call it Y^4 : $X^4 \subset Y^4$. In this case one can have $S_-: X_+^4 \rightarrow Y_+^4$ accompanied by $S_+: X_-^4 \rightarrow Y_-^4$. $X^4 \subset Y^4$ would suck energy from a larger system Y^4 . It is of course possible to replace signals with signals of opposite energy in opposite time direction.

A possible interpretation is as a metabolic charging of smaller space-time sheets by sucking energy from longer scales or by active pumping of energy to shorter scales. The transformation of long wavelength photons with large Planck constant to short wavelength photons with smaller Planck constant is an analogous process and might realize metabolic charging in biology. For instance, Sun-Earth system could correspond to Y^4 and biosphere to X^4 .

To sum up, zero energy ontology completes the picture in the sense that it also provides a process making possible metabolic charging.

2. Thermodynamical considerations

It is not at all obvious whether the proposed picture is consistent with the standard thermodynamics. The transfer of energy from long to shorter length scales making possible to gain metabolic energy and realize the mechanism of long term memory indeed seems a genuinely new element. This process resembles dissipation in the sense that energy is transferred from long to short length scales. In an approach to thermal equilibrium temperature gradients are however reduced whereas remote metabolism favors the active generation of "hot spots".

These considerations relate closely to the notions of entropy and syntropy by Italian mathematician Luigi Fantappie [26] assigned with the two arrows of time. I learned from the work of Fantappie in SSE conference held in Rörös from Antonella Vannini [27] and Ulisse Di Corpo [28]. The discovery of

Fantappie was that in living systems entropic processes seem to be accompanied by syntropic processes which seem to be finalistic. He assigned these processes to the advanced solutions of wave equations.

It would seem that entropy and syntropy do not relate directly to the notion of remote metabolism.

1. Syntropy growth would indeed be the mirror image of entropy growth associated with negative energy mirror image of positive energy dynamics. This dynamics could be seen as sequences of downwards scalings leading from long time scale to short time scale. This sequence would define time sequences proceeding in opposite directions of time for positive and negative energy parts of states. Thus entropy growth would be accompanied by syntropy growth.
2. Syntropy growth could be also seen as a consequence of generalized second law applying with respect to subjective time and growth of syntropy would be growth of entropy but manifesting itself at space-time level in reversed direction of geometric time. For instance, the spontaneous assembly of bio-molecules from their parts could be seen as a decay process in the reverse direction of geometric time controlled by phase conjugate control signals.
3. Remote metabolism as generation of "hot spots" does not seem to reduce to these notions and might represent a genuine breaking of standard thermodynamical view about the world.

One must also distinguish the notions of entropy and syntropy from the notion of number theoretic entanglement negentropy N assignable with quantum entanglement with algebraic entanglement probabilities [H2].

1. N is defined as the maximum of the p-adic entanglement negentropy $N(p)$ as a function of the p-adic prime p and thus assigns to an entangled system a unique prime p_{max} . $N(p)$ is obtained by replacing in the definition of the Shannon entropy the argument of logarithm with its p-adic norm. N is in general positive and thus defines a genuine measure of information.
2. The non-negative negentropy defined in this manner characterizes entanglement as a carrier of information rather than the state of either of systems and has nothing to do with the ordinary (non-positive) entropy characterizing the lack of knowledge about the state of either subsystem. Negentropy Maximization Principle [H2] favors the increase of the number theoretic negentropy and thus formation of entanglement quantum systems and generation of quantum coherence. Depending on the character of entanglement negentropic entanglement might be interpreted as a correlate for some conscious experience with positive content: say experience of understanding (time-like entanglement implying causal structure), of love (space-like entanglement), etc...

It is not obvious to me whether the remote metabolism as a manner to build hot spots and diversity could be reduced to NMP or whether it should be regarded as something completely independent.

2.2.5 p-Adic physics as physics of cognition and intentionality

p-Adic number fields are completions of rationals to a continuum as are also ordinary real numbers. In the case of real numbers one adds to the rationals algebraic numbers and transcendentals like e and π . In the case of p-adic numbers one adds numbers, which are infinite as real numbers. To every prime $p=2,3,5,7,\dots$ one can assign a p-adic number field and an infinite number of algebraic extensions analogous to complex numbers.

1. One can assign also to p-adic numbers a physics (what this physics is far from obvious). The basic motivation for p-adics in the case of TGD was that p-adic thermodynamics makes possible to understand elementary particle masses and reduces the fundamental mystery number defined by the ratio of Planck mass to proton mass to number theory [F1, F2, F3, F4, F5]. It took a long time to get convinced that p-adic physics can be interpreted as the physics of cognition and intentionality and that p-adic physics can be seen as a simulation of real physics.
2. The challenge is to "glue" real physics and various p-adic physics to single coherent whole. To achieve this it is necessary to generalize the notion of number by "gluing" together real numbers and various p-adic number fields by along common rationals (and possibly also common algebraics) [E1]. Also the notions of space, manifold, and space-time generalize. It becomes possible to speak about p-adic space-time sheets as correlates for intentions and cognitions [H8]:

this would be the geometric counterpart for the "mind stuff" of Descartes. Note however that space-time and quantum states are zombies: consciousness is in the quantum jump.

3. Rather remarkably, every p-adic space-time sheet has literally infinite size in the sense of the real topology. This means that cognition and intentionality are cosmic phenomena and cannot be localized to brain or even field body. The intersections of field bodies and p-adic space-time sheets consist of discrete sets of points and provide material representations for cognitions and intentions. The larger the size of field body (the larger the value of Planck constant), the larger the number of points in this intersection, and the better the cognitive representations and the more precise the intentional grasp on the material world. Thus the evolution of cognition involves growth of the largest Planck constant associated with the system characterizing also the time scale of long term memories and planned action.
4. The theory is testable. The p-adic topology should reflect itself as an effective p-adic topology of real space-time sheets serving as correlates for matter and p-adic continuity means p-adic fractality with characteristic long range correlations combined with local chaos in the real topology. The success of p-adic mass calculations supports this view and suggests that cognition and intentionality are present already in elementary particle scales. Also the successes of the applications to biology and even cosmology support the theory.
5. The essential ingredient of the theory is p-adic length scale hypothesis: primes which are near powers of two are physically preferred. In particular, prime powers of two and Mersenne primes $M_n = 2^n - 1$ and their complex analogs (Gaussian Mersennes) are especially favored. For instance, most important elementary particles correspond to Mersenne primes and a number theoretical miracle occurs in biologically important length scale range: in the length scale range between cell membrane thickness (10 nm) and size of cell nucleus (2.5 μm) there are as many as 4 Gaussian Mersennes [J7]!

2.3 Many-sheeted space-time, universal metabolic quanta, and plasmoids as primitive life forms

In this section evidence for many-sheeted space-time represented together with development of more concrete ideas about plasmoids as primitive life forms. Recall that might form the basis of new energy technology able to recycle the fuel.

2.3.1 Evidence for many-sheeted space-time

The dropping of particle to a larger space-time sheet liberates energy which is the difference of the energies of the particle at two space-time sheets. If the interaction energy of the particle with the matter at space-time sheet can be neglected the energy is just the difference of zero point kinetic energies. This energy depends on the details of the geometry of the space-time sheet. Assuming p-adic length scale hypothesis the general formula for the zero point kinetic energy can be written as

$$E(k) = x \times E_0(k) \quad , \quad E_0(k) = \frac{3}{2} \frac{\pi^2}{mL^2(k)} \quad .$$

Here x is a numerical factor taking into account the geometry of the space-time sheet and equals to $x = 1$ for cubic geometry.

The liberated zero point kinetic energy in the case that the particle drops to a space-time sheet labelled by $k_f = k + \Delta k$ with same value of x is

$$\Delta E(k, \Delta k) = x \times E_0(k) \times (1 - 2^{-\Delta k}) \quad .$$

The transitions are seen as discrete lines for some resolution $\Delta k \leq \Delta k_{max}$. At the limit $k \rightarrow \infty$ transitions give rise to a quasicontinuous band. The photon energy for $k \rightarrow \infty$ transition is same as the energy from $k - 1 \rightarrow k$ transition, which brings in additional option to the model building.

For a proton dropping from the atomic space-time sheet $k = 137$ to very large space-time sheet ($\Delta k \rightarrow \infty$) one has $\Delta E(k) = E(k) \sim x \times .5 \text{ eV}$. Since the ratio of electron and proton masses is

$m_p/m_e \simeq .94 \times 2^{11}$, the dropping of electron from space-time sheet $k_e = k_p + 11$ liberates zero point kinetic energy which is by a factor .9196 smaller. For $k_p = 137$ one would have $k_e = 148$. This energy corresponds to the metabolic energy currency of living systems and the idea is that the differences of zero point kinetic energies define universal metabolic energy currencies present already in the metabolism of pre-biotic systems. In the following fit electron's zero point kinetic energy will be taken to be $E_0(148) = .5$ eV so that for proton the zero point kinetic energy would be $E_0(137) = .544$ eV.

The hypothesis predicts the existence of anomalous lines in the spectrum of infrared photons. Also fractally scaled up and scaled down variants of these lines obtained by scaling by powers of 2 are predicted. The wavelength corresponding to .5 eV photon would be $\lambda = 2.48 \mu\text{m}$. These lines should be detectable both in laboratory and astrophysical systems and might even serve as a signature for a primitive metabolism. One can also consider dropping of Cooper pairs in which case zero point kinetic energy is scaled down by a factor of 1/2.

Interestingly, the spectrum of diffuse interstellar medium exhibits three poorly understood structures [33]: Unidentified Infrared Bands (UIBs), Diffuse Interstellar Bands (DIBs) [34], and Extended Red Emission (ERE) [35] allowing an interpretation in terms of dropping of protons or electrons (or their Cooper pairs) to larger space-time sheets. The model also suggests the interpretation of bio-photons in terms of generalizes EREs.

Unidentified Infrared Bands

Unidentified infrared bands (UIBs) contain strong bands at $\lambda = 3.3, 6.2, 11.3$ microns [33]. The best fit for the values of k and Δk assuming dropping of either electron or proton are given by the following table. The last row of the table gives the ratio of predicted photon energy to the energy characterizing the band and assuming $x = 1$ and $E_0(148, e) = .5$ eV. Discrepancies are below 8 per cent. Also the dropping of protonic Cooper pair from $k = 137$ space-time sheet could reproduce the line $\Delta E = .2$ eV. The fit is quite satisfactory although there is of course the uncertainty related to the geometric parameter x .

$\lambda/\mu\text{m}$	$E/.5\text{eV}$	k	Δk	$\Delta E(k, \Delta k)/E$	p/e
330	.7515	137	$\sim \infty$	1.002	e
620	.4000	138	3	1.067	e
1130	.2195	139	3	0.878	e
1130	.2195	139+11=150	3	1.076	p

Table 1. Table gives the best fit for UIBs assuming that they result from dropping of proton or electron to a larger space-time sheet and one has $E_0(148, e) = .5$ eV. The fourth column the table gives the ratio of predicted photon energy to the energy characterizing the band and assuming $x = 1$. e/p tells whether electron or proton is in question.

According to [33], UIBs are detected along a large number of interstellar sight-lines covering a wide range of excitation conditions. Recent laboratory IR spectra of neutral and positively charged poly-cyclic aromatic hydrocarbons (PAHs) has been successfully used by Allamandola [37] to model the observed UIBs. It is believed that PAHs are produced in reactions involving photosynthesis and are regarded as predecessors of biotic life [36]. This would conform with the presence of metabolic energy quanta.

DNA sugar bone, some aminoacids, and various hallucinogens involve 5- and 6-cycles and the proposal is that these cycles involve free electron pairs, which possess Planck constant $\hbar = n\hbar_0$, $n = 5, 6$. These free electron pairs would explain the anomalous conductivity of DNA and would be an essential characteristic of living matter. The emergence of $n = 5, 6$ levels could be seen as the first step in the pre-biotic evolution.

Diffuse Interstellar Bands

There are diffuse interstellar bands (DIBs) at wavelengths 578.0 and 579.7 nanometers and also at 628.4, 661.4 and 443.0 nm. The 443.0 nm DIB is particularly broad at about 1.2 nm across - typical intrinsic stellar absorption features are 0.1 nm [33]. The following table proposes a possible identifi-

cation of these lines in terms of differences of zero point kinetic energies. Also now the best fit has errors below 7 per cent.

λ/nm	$E/.5eV$	k	Δk	$\Delta E(k, \Delta k)/E$	p/e
628.4	3.947	$135 = 3^3 \times 5$	$\sim \infty$	0.987	e
661.4	3.750	$135 + 11 = 2 \times 73$	3	0.985	p
443.0	5.598	$134 = 2 \times 67$	2	0.933	e
578.0	4.291	$135 + 11 = 2 \times 73$	$\sim \infty$	0.986	p
579.7	4.278	$135 + 11 = 2 \times 73$	$\sim \infty$	0.984	p

Table 2. Table gives the best fit for DIBs assuming that they result from dropping of proton or electron to a larger space-time sheet. Notations are same as in the previous table.

The peak wavelengths in chlorophyll and photosynthesis are around 650 nm and 450 nm and would correspond to second and third row of the table.

The Extended Red Emission

The Extended Red Emission (ERE) [33, 35] is a broad unstructured emission band with width about 80 nm and located between 540 and 900 nm. The large variety of peak wavelength of the band is its characteristic feature. In majority of cases the peak is observed in the range 650-750 nm but also the range 610-750 nm appears. ERE has been observed in a wide variety of dusty astronomical environments. The necessary conditions for its appearance is illumination by UV photons with energies $E \geq 7.25$ eV from source with $T \geq 10^4$ K. The position of the peak depends on the distance from the source [35].

According to [33] the current interpretation attributes ERE to a luminescence originating from some dust component of the ISM, powered by UV/visible photons. Various carbonaceous compounds seem to provide a good fit to the observational constraints. However, the real nature of ERE is still unknown since most candidates seem to be unable to simultaneously match the spectral distribution of ERE and the required photon conversion efficiency.

1. Consider first the band 650-750 nm appearing in the majority of cases. The most natural interpretation is that the lower end of the band corresponds to the zero point kinetic energy of electron at $k = 135 + 11 = 146 = 2 \times 73$ space-time sheet. This would mean that the lines would accumulate near 650 nm and obey the period doubling formula

$$\frac{\lambda(k) - \lambda(\infty)}{\lambda(\infty)} = \frac{2^{-k}}{1 - 2^{-k}} .$$

By the estimate of Table 2 the lower end should correspond to $\lambda = 628.4$ nm with a correction factor $x < 1$ reducing the zero point kinetic energy. The reduction would be smaller than 4 per cent. $\Delta k = 3$ transition would correspond to 744 nm quite near to the upper end of the band. For $\Delta k = 2$ transition one has $\lambda = 867$ nm not too far from the upper end 900 nm. $\Delta k = 1$ corresponds to 1.3 μm .

2. For proton with $k = 135 = 146$ the energy band would shift by the factor $2^{11}m_e/m_p \simeq 1.0874$ giving the range (598,690) nm.
3. The variation for the position of the peak can be understood if the charged particles at the smaller space-time sheet can have excess energy liberated in the dropping to the larger space-time sheet. This excess energy would determine the position of the lower end of the band in the range (540, 650) nm.
4. One should also understand the role of UV photons with energy larger than 7.25 eV. For proton the energy would be 8.76 eV. For electron the energy would be 8.76 eV. UV photon with energy $E \geq 8$ eV could kick electrons from large space-time sheets to $k = 144 = 146 - 2$ space-time sheet where they have zero point kinetic energy of 8 eV plus possible additional energy (for proton the energy would be 8.76 eV). One possibility is that these electrons drop first to $k = 145$ by the emission of ~ 4 eV UV photon and then to $k = 144$ by the emission ~ 2 eV photon

corresponding to 650 nm line. The further dropping to larger space-time sheets would produce besides this line also the lines with longer wavelengths in the band.

The energy of UV photons brings in mind the bond energy 7.36 eV of N_2 molecule and the possibility of metabolic mechanism using UV light as metabolic energy and based on the dissociation of N_2 followed by re-association liberating metabolic energy kicking protons or electrons to a smaller space-time sheet. For the $k \rightarrow k + 3$ transition of electron the energy would be 7 eV which suggests that this transition defines important metabolic energy quantum for living interstellar dust using dissociation and its reversal as basic metabolic mechanism.

2.3.2 Laboratory evidence for plasmoids as life forms

Accepting the notion of magnetic body one is naturally led to the idea about plasmoids as primitive life forms quantum controlled by the dark matter at the magnetic body of the plasma ball. Magnetic body itself would contain Bose-Einstein condensates of ions and electrons and could be seen as a quantum plasmoid. Plasmoids would be very simple systems able to recycled metabolism and therefore highly interesting from the point of new energy technologies. Magnetic body of the plasmoid could also be responsible for a continual feed of charge keeping plasma ball charged (DNA strands are negatively charged in bio-matter).

From dust to dust

The article *From Plasma crystals and helical structures towards inorganic living matter* of Tsytoovich *et al* in August issue of New Journal of Physics provides new empirical support for plasmoids as living life forms. The results of the article suggest that interstellar dust could behave like living matter in some respects: it could even have variant of genetic code. This is a really shattering finding and with single blow destroys the standard dogma about life as something purely chemical. It should also give also some headaches for those influential colleagues who have decided that it is necessary to accept the anthropic principle. Here is little popularization of the result.

SCIENTISTS have discovered that inorganic material can take on the characteristics of living organisms in space, a development that could transform views of alien life.

An international panel from the Russian Academy of Sciences, the Max Planck institute in Germany and the University of Sydney found that galactic dust could form spontaneously into helixes and double helixes and that the inorganic creations had memory and the power to reproduce themselves.

A similar rethinking of prospective alien life is being undertaken by the National Research Council, an advisory body to the US government. It says Nasa should start a search for what it describes as weird life" - organisms that lack DNA or other molecules found in life on Earth.

The new research, to be published this week in the New Journal of Physics, found nonorganic dust, when held in the form of plasma in zero gravity, formed the helical structures found in DNA. The particles are held together by electromagnetic forces that the scientists say could contain a code comparable to the genetic information held in organic matter. It appeared that this code could be transferred to the next generation.

Professor Greg Morfill, of the Max Planck institute of extra-terrestrial physics, said: Going by our current narrow definitions of what life is, it qualifies.

The question now is to see if it can evolve to become intelligent. Its a little bit like science fiction at the moment. The potential level of complexity we are looking at is of an amoeba or a plant.

I do not believe that the systems we are talking about are life as we know it. We need to define the criteria for what we think of as life much more clearly."

It may be that science is starting to study territory already explored by science fiction. The television series The X-Files, for example, has featured life in the form of a silicon-based parasitic spore.

The Max Planck experiments were conducted in zero gravity conditions in Germany and on the International Space Station 200 miles above earth.

The findings have provoked speculation that the helix could be a common structure that underpins all life, organic and nonorganic.

To sum up the essentials, plasma phase is involved and the dust life is able to construct analogs of DNA double helices and this has been achieved also in laboratory. "From dust to dust" seems to have a very deep side meaning!

Here is a more quantitative summary of the results reported in [61].

1. The scale of the dust balls seems to be few micrometers. It is essential that the system is open in the sense that there is both metabolic energy feed and continual feed of plasma to negatively charged dust particles to preserve their charges. Authors speak about effective "gravitational" instability as a mechanism leading to the formation of the helices and identify effective gravitational coupling (the formula contains a trivial typo) as a function of charge and mass of the particle plus dimensionless parameter characterizing the modification of Debye model implied by the fact that dust particles are not electrically closed systems. Authors give a long list of life-like properties possessed by the helical structures.
2. Helical structures are generated spontaneously and possess negative charges. The repulsion of the helical structures transforms to attraction at some critical distance interval due to the fact that the large electrostatic self energy depends on the distance between helices and this makes possible double helices (authors speak about over-screening in the formal model). Similar mechanism might work also in the case of ordinary DNA double helices whose stability is poorly understood since also in this case the large negative charge could be preserved by continual feed of charge.
3. The twist angle of the helix makes bifurcations as a function of radius of helix and the values of twist angle could define the letters of genetic code. Also a mechanism for how the twist angle is communicated to neighboring helix is proposed. Also dust vortices are observed and might be those which one can occasionally observe during hot summer days.
4. Authors do not mention magnetic fields but my guess is that the helical structures reflect directly the geometry of the helical magnetic flux tubes, and that dark electron pairs with large Planck constant at these tubes might be the quantal aspect of the system. These currents might relate closely to the plasma current, which charges the dust particles. Also DNA, which is insulator, is known to be able to act as conductor, and here the free electron pairs associated with aromatic rings having $\hbar = n \times \hbar_0$, $n = 5$ or 6 , could make conduction possible since their Compton size would be n -fold.

Elephant trunks in astrophysics

TGD Universe is fractal and this means that the visible structures are formed around magnetic flux quanta containing dark matter with large \hbar appear in all length scales and have geometric patterns reflecting the exact discrete symmetries of dark matter acting as rotational symmetries of the field body and at the level of visible matter giving rise to broken symmetries typical for molecular structures. The helical structures found from the rings of some planets could be one example of fractal life.

For some time ago I learned about "elephant trunks" found by Hubble (I am grateful for Miika Väisälä telling about the trunks and for giving references to the papers about the finding). They appear in very wide range of length scales: at least from 1000 au to 1 pc. They are found in close connection with molecular clouds and HII regions excite by one or more young hot stars (a "metabolic connection" with the above mentioned unidentified bands and lines and PAHs present only if there is also UV source present does not look like a bad guess). In general the trunks are

Another important finding supporting TGD view about Universe which might be seen as a fractally scaled variant of above helices. pointing like fingers to the hot stars. Here is abstract of the paper by P. Carlquist, G. F. Gahm, and H. Kristen [38].

Using the 2.6 m Nordic Optical Telescope we have observed a large number of elephant trunks in several regions. Here, we present a small selection of this material consisting of a few large, well-developed trunks, and some smaller ones. We find that: (i) the well-developed trunks are made up of dark filaments and knots which show evidence of twisted structures, (ii) the trunks are connected with essentially two filamentary legs running in V-shape, and (iii) all trunks have the maximum extinction in their heads. We advance a theory of twisted elephant trunks which is based on the presence of magnetic flux ropes in molecular clouds where hot OB stars are formed. If the rope contains a local condensation it may adopt a V-shape as the region around the hot stars expands. If, in addition, the magnetic field in the rope is sufficiently twisted, the rope may form a double helix at the apex of the V. The double helix is identified with the twisted elephant trunks. In order to illustrate the mechanisms behind the double helix we have constructed a mechanical analogy model of the magnetic flux rope in which the rope has been replaced by a bundle of elastic strings loaded by a weight. Experiments with

the model clearly show that part of the bundle will transform into a double helix when the twist of the bundle is sufficiently large. We have also worked out a simple theoretical model of a mass-loaded magnetic flux rope. Numerical calculations show that a double helix will indeed form when the twist of the rope exceeds a certain critical limit. Numerical model calculations are applied to both the analogy model experiments and one of the well-developed elephant trunks. On the basis of our model we also suggest a new interpretation of the so called EGGs.

The double helix mechanism is quite general, and should be active also in other suitable environments. One such environment may be the shell of supernova remnants. Another example is the expanding bubble outlined by the North Celestial Pole Loop.

For fractally thinking physicist consisting mostly of dark matter with large Planck constant this does not leave many options: life and even intelligent life is everywhere and in all length scales. This provides also a new view about Fermi paradox: see the article [65], which summarizes also the essentials of TGD, TGD based ontology, and TGD based quantum biology.

2.3.3 Universal metabolic quanta

The basic prediction following from the p-adic length scales hypothesis is that universal metabolic energy quanta come as octaves of p-adic energy scale. The natural expectation is that the evolution of life has proceeded from high to low energy quanta and that also the high energy quanta might be seen even at the level of organic life.

Could UV photons have some metabolic role?

The correlation between UV photons and ERE brings in mind the vision that high temperature plasmoids are primitive life-forms possibly having universal metabolic energy quanta in UV range. One can imagine that the development of chemical energy storage mechanisms has made it possible to use visible light from Sun as a source of metabolic energy and get rid of UV quanta having disastrous biological effects. Ozone layer shields out most of UV light and also air absorbs the UV light below wavelength 200 nm, which justifies the term vacuum UV (VUV) for this range.

Δk	1	2	≥ 3	∞
$\Delta E(144, \Delta k)/eV$	4	6	≥ 7	8
λ/nm	310(UVB)	207(UVB)	≤ 177 (VUV)	155 (VUV)

Table 3. The lines corresponding to the dropping of electron from $k = 144$ space time sheet defining a candidate for UV light inducing generation of ERE in the interstellar dust.

From Table 3 one finds that $\Delta k > 2$ electronic transitions cascading to 8 eV (155 nm by period doubling) belong to vacuum UV (VUV) absorbed by air. The lines 310 nm and 207 nm corresponding to $\Delta k = 1$ and $\Delta k = 2$ could however define frequency windows since these lines need not correspond to any atomic or molecular electronic transitions.

In the solar photosphere the temperature is about 5800 K, roughly half of the minimum temperature 10^4 K needed to generate the UV radiation inducing ERE in interstellar dust. Solar corona however has temperature of about 10^6 K, which corresponds to a thermal energy of order 100 eV and the UV radiation from corona at above mentioned discrete frequencies resulting in dropping of electrons could serve as a metabolic energy source for pre-biotics in the interstellar space. This raises obvious questions. Should the stellar sources inducing ERE possess also corona? Could 4 eV and 6 eV UV photons from the solar corona serve as a source of metabolic energy for some primitive organisms like blue algae?

A simple model for the metabolism of plasmoids

Extended Red Emissions (EREs) are associated with the interstellar dust in presence of UV light with energies above 7.25 eV and source with temperature not below 10^4 K (maximum of wave length distribution of black body radiation corresponds to the energy 4.97 eV at this temperature). This suggests that plasmoids using UV photons as metabolic energy are involved.

1. Since the bond energies of molecules vary in few eV range and their formation typically liberates photons in UV range, the natural hypothesis is that the metabolic cycle is based on the formation of some molecule liberating UV photon kicking electron/proton to a smaller space-time sheet. UV photons from energy source would in turn induce dissociation of the molecule and thus drive the process. The process as a whole would involve several p-adic length scales and several metabolic currencies.
2. This situation is of course encountered also in the ordinary biology but with highly developed sharing of labor. Biosphere would burn hydrocarbons in animal cells with carbon dioxide as the eventual outcome. Carbon dioxide would in turn be used by plants to regenerate the hydrocarbons. Note that in the recent day technology the loop is open: hydrocarbons are burned but there is no process regenerating them: perhaps photons with large Planck constant might some day used to regenerate the fuel and give rise to "living" and perhaps tidier technology.
3. It is believed that complex organic molecules like amino-acids can form in the interstellar dust and the spontaneous formation of aminoacids is known to be possible in the interstellar ice under UV radiation. Hence at least N_2 and perhaps also CO can be expected to be present. The table below gives dissociation energies of some simple molecules.

Molecule	H ₂	O ₂	N ₂	CO	NO
E_D/eV	4.48	5.08	7.37	11.11	5.2

i) N_2 has bond energy 7.37 eV is slightly above the UV threshold 7.26 eV for ERE, which strongly suggests that N_2 is one of the molecules involved with the metabolism of interstellar plasmoids.

ii) If ice is present then carbon monoxide CO would be an excellent candidate for a metabolic molecule since its bond energy is as high as 11.11 eV. The exceptionally large bond energy would naturally relate to the fact that carbon and oxygen are the key molecules of life.

Anomalous light phenomena as plasmoids

TGD suggests that anomalous light phenomena (ALPs, or light balls, or UFOs depending on one's tastes and assumptions) are identifiable as plasmoids behaving as primitive life forms. In the conference held in Rörös Björn Gitle-Hauge told about the determination of the spectrum of visible light emitted by some light balls observed in Hessdalen [63] ("Hessdalen phenomenon" is the term used).

1. The spectrum is a band in the interval 500-600 nm whereas the typical ERE [35] is concentrated in the interval 650-750 nm. The peak is in the interval 540-900 nm, the width of the band is also now 100 nm, and there are no sharp peaks. Therefore the interpretation as ERE can be considered.
2. Because Hessdalen is an old mining district, authors propose that the light ball could consist of burning dust containing some metals. Author proposes that the burning of Titanium and Scandium (encountered only in Scandinavia) might provide the energy for the light ball. Sc reacts vigorously with acids and air (burning in oxygen gives Sc_2O_3 as end product). Ti burns in oxygen and is the only element that burns in nitrogen. Ti is used in fireworks since it produces spectacular fires.

Author notices that the emission lines of N^+ , Al^{++} , *resp.* Sc^+ at 528.02 nm, 528.2 nm, *resp.* 528.576 nm might contribute to the band. This might be the case but the explanation of the band solely in terms of molecular transitions is not favored by its smoothness.

3. The bond energies of TiO and TiN are 6.9 eV and 5.23 eV so that the radiation resulting in their formation is in UV range and could provide part of the metabolic energy. I do not know about bond energy of Scandium oxide.
4. TiO_2 is known to catalyze photolysis in the presence of UV light [31, 30], which in turn is basic step in photosynthesis [29], the basic step of which in TGD Universe would be the kicking of electrons/protons to smaller space-time sheets. Therefore the UV photons liberated in the formation of molecules containing Ti could catalyze photosynthesis like process.

2.3.4 Life as a symbiosis of plasmoids and biological life

If evolution has discovered something it usually keeps it so that plasmoids and UV metabolism should be still there. This suggests that plasmoids are still in ionosphere. What could this mean? There also are other questions and I am grateful for Sampo Vesterinen for some of them. The key questions are perhaps the following ones. Do plasmoids and biological life forms live in symbiosis in some sense? If this is the case, what plasmoids can give to us and what we can give to plasmoids?

1. *Magnetic bodies as quantum plasmoids and plasmoids in magnetosphere*

One must make clear what one means with plasmoid. One can consider a plasma made of ordinary visible matter and also large \hbar quantum plasma at magnetic bodies in a form of Bose-Einstein condensates of charged particles. The symbiosis of plasmoids and biomatter could correspond to the symbiosis of magnetic body and biological body.

One can imagine also the possibility that visible matter plasmoids and bio-matter are in symbiosis via the mediation of magnetic bodies. Note that DNA strands are negatively charged so that there is a resemblance with a plasma like state. One aspect of symbiosis would be that magnetic body would feed charged particles to DNA.

2. *Some basic facts about magnetosphere*

Magnetosphere would be a natural environment for plasmoid population. If one restricts plasmoids to visible matter, then ionosphere, plasma sphere and plasma sheet are the most interesting objects of interest.

1. The temperature in the highest F layer of the ionosphere (extending from 150 km to 1500 km depending on source) is about 1200-1300 K: the photon energy is about .6-.65 eV at the maximum wavelength of thermal distribution. Hence F layer plasmoids might receive metabolic energy in the form of .5 eV metabolic energy quanta via thermal photons. Self-organization occurs in transition layers and especially interesting is the transition region 85-300 km from mesosphere to ionosphere at which temperature increases 300 K to about 1200 K.
2. Inner magnetosphere is a toruslike structure whose extension varies between $4R_E$ (day side) and $8R_E$ (night side) and shielded from solar wind. In the inner magnetosphere the typical density is about 1 ion per cubic centimeter. Inner magnetosphere is bounded by a transition layer of thickness of $\sim R$ (magneto-pause). In this region the density of the ions drops rapidly.

Inner magnetosphere contains plasma sphere whose radius varies in the range $2R_E - 4R_E$ at day side and $2R_E - 6R_E$ at night side. Plasma has a ionospheric origin. The density of the cold plasma consisting mainly of protons sphere varies in the range $10 - 10^3$ ions/cm³, whereas the temperature is $\sim 5 \times 10^3$ K, which corresponds to metabolic energy quantum of .5 eV. Note however that the energy of photon at maximum of thermal distribution is about 2.5 eV which suggests 2 eV metabolic quantum.

The cold, dense plasma of plasma sphere is frozen around magnetic flux lines which co-rotate with Earth. In TGD framework this means that flux tubes co-rotate and thus change shape. In the equatorial plane the density of the plasma sphere drops sharply down to ~ 1 ion/cm³ at $r = 4R$. This transition region is known as a plasma pause. During magnetic storms the outer radius decreases since the pressure of the solar wind compresses the plasma sphere. The day-night variation of the shape of the plasma sphere is rather small. Within this region the magnetic field has in a reasonable approximation dipole shape with radiation belts forming an exception.

The surface temperature of Sun is 6×10^3 K. This temperature is roughly half of the minimum temperature 10^4 K needed for EREs from interstellar dust [35]. This corresponds to photon energy of 3 eV at the maximum of thermal distribution and cannot induce dissociation of N_2 and other simple diatomic molecules. There is also solar corona but its temperature is about 10^6 K (10^2 eV) so that the flux of thermal photons at UV energies is very low.

Taking seriously the finding that $T \geq 10^4$ K for source is necessary for EREs, one might ask whether the plasmoids at the day side are able to receive enough metabolic energy from UV radiation of Sun. If course, there is no need to assume that dissociation of N_2 molecules is key element in metabolic mechanism. The temperatures in both F layer and plasma sphere allow

kicking of protons and electrons to smaller space-time sheets and this might save the situation. Hence metabolism is not a problem for the plasmoids except perhaps during night-time when the plasma cools down somewhat.

3. The plasma sheet [32, N1] at the night side of Earth dark is the most prominent feature of the outer magnetosphere. It has a thickness about Earth radius R_E and extends beyond Moon's orbit (with radius $10^3 R_E$). The average densities of charged particles are very low and same order of magnitude as in plasma sphere: about .4-2 per cm^3 for both protons and electrons and correlates with solar wind density.

The temperature is very high: the thermal energy of electrons is in keV range and ionic temperatures are even higher. The high temperature is due to the leakage of matter from solar wind. Note that up to the distance $d \sim 10^2 R_E$ equator region of outer magnetosphere at the night side of Earth experiences a continual solar eclipse so that this region does not receive radiation energy from Sun: the high temperature of plasma sheet solves this metabolic problem.

The presence of keV photons would destroy molecules at plasma sheet and induce a high degree of ionization so that plasmoid life must be based on ions and electrons. The energy needed to kick an electron to an atomic space-time sheet is about keV from $m_e/m_p \sim 2^{-11}$: hence the dropping of electrons from atomic space-time sheets would be the natural metabolic mechanism for plasmoid life at plasma sheet.

One of the original motivations for the plasmoid hypothesis was the strange finding that plasma sheet at the equator at the dark side of Earth is highly self-organized structure and the velocity distributions of electrons present patterns like "flowers", "eyes", "butterflies" [N1].

3. *What plasmoids could give to us and what we could give to plasmoids?*

An attractive general motivation for the symbiosis would be that magnetic bodies would give us ability to think and we would give them ability to sense.

1. The model of cognitive representations relies on the intersections of magnetic bodies with corresponding p-adic space-time sheets possessing literally infinite size in the real sense. The larger the magnetic body, the better the representations. Magnetic bodies could thus provide us with cognitive representations and an interesting question is whether and how this relates to the strange self-organization patterns at plasma sheet.
2. We could provide for magnetic bodies sensory input and serve as their motor instruments. These magnetic bodies might be also associated with plasma sheet and the plasmoids of ionosphere and plasma sphere and could also use plasmoids of visible matter as a sensory receptors and perhaps even primitive motor instruments.

One can imagine also more concrete motivations for the symbiosis.

1. Plasmoids in the day-side ionosphere could shield biosphere from UV light by "eating" the incoming UV light. Magnetic bodies could also feed negative electronic charge from the plasmoids of magnetosphere to DNA double strands.
2. Plasmoids are not in a need of metabolic energy unless it happens that the temperature in F layer cools too much during night time from $T \sim 0.12$ eV. One might imagine that plasmoids suck metabolic energy from the biosphere during sleep (say brains which remain active): this would be a possible explanation for why we sleep. One can even imagine that during sleep magnetospheric collective levels of consciousness take command and life forms in the biosphere entangle to form kind of stereo consciousness providing a collective view what is to be human, member of species, or a part of biosphere.

4. *About the interpretation of bio-photons?*

Also the wave lengths of bio-photons are in the range of visible photons. Their spectrum is claimed to be featureless, which would suggest that identification in terms of photons resulting in dropping of electrons and protons to larger space-time sheets might not make sense. The variation of

the geometric shape of space-time sheets, the possibility of surplus energy, and the clustering of the transition lines around the lower end of wave length spectrum might however give rise to effectively featureless spectrum.

Suppose that bio-photons correspond to superposition of ERE bands and thus reflect the presence of UV energy feed. Unless biological body is not able to generate the needed UV photons, they must arrive from Sun. Bio-photons or their dark counterparts with much longer wavelengths could indeed live at the flux quanta of the magnetic bodies and observed visible bio-photons could represent some kind of leakage.

5. *Gariaev's experiments*

Gariaev's experiments [44] involved the irradiation of DNA using visible laser light with photon energy 1.9595 eV. The irradiation induced emission of radio waves with same polarization with frequencies above kHz. Radio waves induced growth of potatoes. A possible interpretation is that 2 eV photons kicked electrons to a smaller space-time sheet and thus gave metabolic energy to DNA. The radio waves possibly resulting in the dropping of electrons back to the larger space-time sheets could have consisted of dark photons with same or smaller energy and could have been used as a metabolic energy by the potatoes. That the dropping can occur to several space-time sheets would explain why several radio wave frequencies were observed. The prediction would be sum of period doubling spectra discussed earlier since sequences of droppings are possible. The radio-wave signal would result from the de-coherence of dark radio-wave photons to a bundle of ordinary radio-wave photons.

6. *Earth's interior as a living system?*

For years ago I developed in detail the working hypothesis that entire magnetosphere is a living system. Even Earth's interior (and also solar surface) could contain plasmoid life [L4, N1]. The temperature below the mantle of Earth does not differ too much from the surface temperature of Sun and metabolic energy could come from the radioactive decays from the interior of Earth. There would be UV shielding by Earth: UV light has energies above 3.1 eV whereas the temperature at the mantle-core boundary is 4300 K which corresponds to energy 2.2 eV energy at the maximum of the thermal distribution. Metabolic energy quantum of 2 eV would be highly suggestive and might be directly used to kick protons and electrons to smaller space-time sheet.

The metabolism would not probably involve energy quantum of .5 eV. Magnetic flux tubes could also mediate metabolic energy from the biosphere and possibly also ionosphere and the plasmoid life in question could be at an evolutionary level not tolerating UV light and involve molecules in essential manner.

2.4 Podletnov effect and Modanese-Podkletnov effect

The name of Podkletnov is associated with two effects for which the simplest explanation seems to be based on the same idea. The older experiment [70] reports a few per cent reduction of strength of Earth's gravitational field above rotating and levitating super-conductor subjected to 1 MHz AC current generated magnetic field. Schnurer [71] reports a similar effect in rotating super-conductor during a phase transition from super-conducting to non-super-conducting phase.

In Modanese-Podkletnov effect [22] the electric discharges of a capacitor for which the second plate is super-conductor are reported to generate a pulse of unidentified radiation inducing the oscillation of test penduli. What is strange that the beam of radiation does not seem to be attenuated.

I have considered several alternative explanations for the Podkletnov effect but only after having realized the correct interpretation of predicted long ranged electro-weak and color gauge fields in terms of dark matter hierarchy it became obvious that the common denominator of these experiments is phase transition like phenomenon, either (possibly) repeated transition from super-conducting to super-conducting state or dielectric discharge of the super-conductor. This leads to a unique model implying also a close connection with Searl device.

2.4.1 Modanese-Podkletnov effect

Recently I learned from Hans-Poul Veldhuyzen van Zanten that E. Podkletnov and G. Modanese have constructed a device [22] in which a super-conducting ceramic cathode and a copper anode cause

electrical discharges in low pressure gases, at temperatures between 50 and 70 K. The voltage used is 2000 kV. Peak currents are of order 10^4 A. Cathode and anode have radii of 10 cm and their distance varies between 15 and 40 cm. There is also a magnetic field of .9 Tesla present inside the cylindrical chamber to concentrate the discharge to a smaller area. In discharges at voltage above 500 kV two new phenomena were observed. First, discharge does not look like a spark but like a flat, glowing discharge originating from the whole surface of the super-conductor. Secondly, a radiation pulse is emitted at the discharge which propagates orthogonally to the cathode, towards the anode and beyond it, in a collimated beam, apparently without an attention. Radiation pulse carries away an energy of 10^{-3} J at least. It is concluded that the radiation in question cannot be ordinary electromagnetic radiation.

The anomalous radiation was measured using various penduli at the line connecting the centers of cathode and electrode and hanging from a cotton string inside glass cylinders under vacuum. The radii of spheres were 10-25 mm and located at distances 6 m and 150 m from the installation. Various materials for the spheres were used: metal, glass, ceramics, wood, rubber, plastic. It was found that the impact on pendulum did not depend on the material but only on the mass of the pendulum which was in the range 10-50 g. Pendulum did not show any signs of heating. Measurements of the impulse taken at close distance (3-6 m) and large distance (150 m) gave identical results. The pulses were not absorbed by the media or at least, the losses of energy were negligible. The force beam does not seem to diverge and its borders are clear-cut and the width of the beam is that of the super-conducting emitter. If the pulse propagates in air, some energy should be depleted from it and lead to the weakening of the pulse. The observations of the air in the path of pulse only show that brief forward and backward movement of particles occurs.

The radiation appears to propagate through brick walls and metal plates without a noticeable absorption but this is not due to weak coupling with matter. Ordinary electromagnetic radiation cannot be in question. The assumptions that the radiation satisfies $E = cp$ dispersion relation and that the pulse given to the penduli is due to the absorption of energy and momentum of radiation leads to a contradiction. For a pendulum of 18.5 g, the kinetic energy of the pendulum was of the order of 10^{-4} J whereas the momentum was of the order of 10^{-3} kg m/s. If this momentum had to be imparted from the beam, its total energy should be larger than the total energy available in the discharge, 10^6 J in maximum. The conclusion made in [22] is that the radiation does not obey the dispersion relation of massless particles. On the other hand, if the net energy and momentum of the pendulum correspond to the total energy and momentum for quanta of radiation absorbed by the pendulum, the quanta must be tachyonic since one has $E = 10^{-4} J \ll pc = 3 \times 10^5$ J, which suggests that absorption is not the mechanism. Also the fact that radiation does not weaken with distance with a detectable manner suggests the same.

The force is proportional to the mass of the pendulum sphere but the interpretation as a gravitational force is excluded already because of the strength of the effect. Equivalence Principle states also that the gravitational force depends only on the gravitational mass of the particle, not its particular state. The force is also repulsive.

Consider now a TGD based explanation for the effect.

1. The radiation could correspond to a massless extremal (ME, 'topological light ray') or TGD counterpart of the longitudinal scalar waves of Tesla. The classical field involved could be either electromagnetic or Z^0 type. MEs represent classical completely collimated radiation propagating with light velocity with pulse shape being arbitrary and preserved. Tesla wave represents longitudinal pulse of electric or Z^0 electric) field propagating with light velocity. At least Z^0 type and perhaps also em MEs and scalar waves do not care about Faraday cages: the classical radiation is simply at another space-time sheet. This fits with the observation that the pulse of radiation goes through various obstacles without absorption.
2. Electromagnetic Tesla's scalar waves are favored because their emission could be interpreted as a decay of the electric field of the capacitor by the emission of scalar waves carrying away pieces of space-time containing a constant electric field with intensity equal to the local intensity of the electric field between the capacitor plates. For the scalar wave pulses the quantization of the electric flux analogous to that of magnetic flux suggests that the condition

$$eVL = eEL^2 = n \times 2\pi \quad ,$$

n integer, is satisfied ($\hbar = c = 1$), so that the length of the scalar wave pulse would be $L = \sqrt{n2\pi/eE}$. For an electric field having a magnitude of order $E \sim 10^4 \text{ kV/m}$ (a voltage of 10^4 kV over a distance of 10 cm) and for $n = 1$ the scalar wave pulse would have a length of about one micrometer.

3. What might cause the repulsive force proportional to the mass of the object? $E = pc$ relationship does not hold for the energy transfer: rather momentum is much larger than this would allow. Thus an absorption of massless quanta is certainly not in question. Rather, the relationship suggests an ordinary non-relativistic dispersion relation between kinetic energy and momentum for a massive particle. The total mass of these particles is from numbers $\Delta E = 10^{-4} \text{ J}$ and $\Delta p = 10^{-3} \text{ kgm/s}$ equals to about 50 grams. The actual mass mentioned in the example was 18.5 grams. This makes perfect sense since only order of magnitude estimate is in question.
4. Many-sheeted space-time suggests a different explanation for the effect consistent with $E = cp$ relationship. The effect would be actually a special case of anomalies which are very abundant and explained by the many-sheeted space-time concept.
 - i) The space-time sheet of the pulse would act as a temporary bridge between two space-time sheets, say an atomic space-time sheet of the test object and a super-conducting magnetic flux tube of the Earth's magnetic field or its dark counterpart [M3]. Some particles from the atomic space-time sheets of the test object leak along this bridge to a larger space-time sheet or vice versa. The presence of the leaking particles at the bridge would make it temporarily massive and stop the motion of ME/scalar wave pulse for a moment. Since absorption does not occur considerably this should occur only temporarily. In case of the scalar wave pulse the longitudinal electric field would define a force field and induce ionic currents of opposite sign between the space-time sheets.
 - ii) If the particles leak to the direction of the emitter first, as is natural since the join along boundaries bonds are first formed to this direction, then effective repulsive force results as a recoil effect by conservation of total momentum holding in many-sheeted space-time but not for single space-time sheet anymore. Recoil momentum is indeed non-vanishing since the zero point kinetic energy of particles at atomic space-time sheets is non-vanishing and is transformed to the kinetic energy of the particles at the larger space-time sheet. An order of magnitude estimate is obtained by assuming that the 'dropping' particles are electrons, and that the zero point kinetic energy is $E = \pi^2/2m_e L^2 \simeq 1 \text{ keV}$ resulting, when the size L of the atomic space-time sheet is one Angstrom. This gives for the fraction ϵ of electrons in the pendulum transferred to the beam space-time sheet the estimate $\epsilon \simeq 1.8 \times 10^{-10}$.
 - iii) If the probability for leakage is same for all particles independent of the material, the recoil momentum of the object resulting from the leakage of particle to another space-time sheet is proportional to the mass of the object as observed.

A possible test for this effect is following one. The object should lose some mass via the leakage, at least temporarily. The loss of mass is predicted to be small, a fraction of order 10^{-13} about the mass of the pendulum. One could also look whether the pendulum becomes charged in the process. The leakage of the super-conducting ions from the magnetic flux tubes of say Earth to the atomic space-time sheets is a fundamental mechanism of breaking of super-conductivity in TGD universe. The quantum theory of bio-systems relies on this mechanism as well as TGD based explanations for certain free energy phenomena like Brown gas [K6]. The 'miraculous' appearance of ions or atoms to system originally not containing them by supra current leakage from magnetic flux tube space-time sheets (say) is the basic testable prediction.

2.4.2 Podkletnov effect

Podkletnov discovered his effect while working in Tampere University. The report created quite a furor forcing Podkletnov to leave Finland. The responsible leaders of Tampere University even claimed that they had never heard of Podkletnov. To me this episode was an excellent lesson about the silliness of academic decision making in a small country like Finland lacking academic decision makers possessing genuine competence and was later followed later by much personal lessons. Although the effect has not been replicated, NASA got interested in the effect and has been financing the work.

Observations

The observations of Podkletnov *et al* [70] are summarized nicely in [72].

1. The effect is observed with double layered toroidal disks, which are high T_c super-conductors. The lower layer is in non-super-conducting state whereas the upper layer is in super-conducting state. Super conductivity is essential for the effect. Two-layered structure is known to be essential prerequisite for the effect: for single super-conducting disk the effect is not observed.
2. The disk is levitating in a vertical magnetic field B created by AC currents in solenoids along the rim of the super-conductor with frequencies of order MHz. Disk also rotates with a rotation velocity of 5000 rpm. Rotation velocities correspond to velocities of order 10 m/s at the boundaries of the disk. The effect of the addition of non-rotating radial magnets to the rim of the rotating disk creating a vertical magnetic field B_R rotating with respect to the superconductor is also studied.
3. Effective shielding of the gravitational field of Earth by about one per cent is reported. g is reduced in a cylindrical region above the disk but not below it. The best shielding is achieved with frequencies of order 1 MHz. The effect disappears shortly after the turning off of the AC current but not instantaneously. Periodic time variation seems to be essential for the effect, which seems to be largest when heating of the super-conductor is largest. The weight loss is reported to be .05 per cent near rim and .3 per cent at center. The presence of the rotating magnetic field B_R enhances the effect to 2.1 per cent in the center.

What Schnurer [71] observed was a slight reduction (or order one per cent) of the weight of the test mass above super-conducting disk levitating in a static magnetic field. High temperature super conductor was used also now but it did not possess two-layered structure. Super-conducting disk was not rotating. The effect was observed only during the super-conducting to non-super-conducting phase transition.

TGD based explanation of Podkletnov effect

The common denominator of these experiments is the occurrence of a phase transition like phenomenon, either repeatedly or just once. Since long range correlations are generated in criticality, one might wonder whether topological a Bose-Einstein condensate of very light dark gauge bosons might be generated and have topological light rays (MEs) or scalar wave pulses as a space-time correlate. MEs/scalar wave pulses should carry long range weak (in particular Z^0) and color gauge fields.

Faraday effect and the model model of rotating magnetic systems provide valuable clues. In Faraday effect rotating magnet develops a radial electric field carrying vacuum charge density (not naturally allowed by Maxwell's theory), which in turn induces a radial ohmic current charging the magnet charging it.

That rotation is needed in Podkletnov experiment suggests that dark magnetic fields (em, weak, or color) induced by the rotation of the dark matter are an essential prerequisite for the effect to occur. Note that the rotation of the AC magnetic field created by the coils generates only radial AC Ohmic current which cannot make the disk charged.

1. If the Z^0 magnetic field created by rotation induces Z^0 magnetization of dark matter, the resulting Z^0 magnetic field can be regarded as rotating, and would induce a continual Z^0 charging of magnet followed by eventual Z^0 dielectric breakdown. The objection is that the range of Z^0 fields is characterized by appropriate p-adic length scale and that the density of Z^0 charges scales by p-adic fractality as $1/L^3(k)$ so that effects become very weak above cell length scale. The option avoiding this objection is based on the magnetization associated with the dark em charge of nuclei assignable to charged color bonds [F8].
2. The two-layered structure of the super-conductor could make the system analogous to capacitor playing same role as the capacitor in Modanese-Podkletnov effect. MEs, or perhaps more plausibly scalar wave pulses (for the detailed TGD based model of scalar wave pulses see [18]), could be generated when an analog of di-electric breakdown occurs in the vertical direction during the transition(s) to non-super-conducting phase. MEs/scalar wave pulses generated in

the discharges would generate the apparent antigravity effect by the same mechanism as in the case of Modanese-Podkletnov effect. The reported flow of the air upwards would be also due to this effect and essentially identical with corona wind. The di-electric breakdown is predicted to occur in the vertical direction and the emission only in this direction explains why the effect is not observed below the rotating disk.

3. The enhancement of the effect by the addition of the rotating magnetic field B_R can be also understood. B_R generates an ordinary Ohmic current continually charging the resulting magnet as in the case of Searl device and also now the phase transition could induce di-electric breakdowns accompanied by scalar wave pulses or MEs.

2.4.3 Biefeld-Brown effect, lifters, corona wind, and Modanese-Podkletnov effect

The so called lifters (see the free energy home page of Jean Louis Naudin [29]) might one day symbolize the deepness of the crisis of recent day reductionistic physics. M-theory cosmologists are studying what possibly happened before big bang (they can say very little about what happened after the big bang). At the same time school boys are doing new experimental physics by building and studying lifters. Perhaps experimental physics is experiencing a new renaissance outside academic Big Science suffering of intellectual paralysis. Of course, this process is made possible only by the internet allowing to circumvent the censorship of the academic bullies. Lifters rely on Biefeld-Brown effect, which is poorly understood in standard physics context. Since high voltages, corona discharges and corona wind are involved, the obvious guess is that Modanese-Podkletnov effect is involved with lifter mechanism. This indeed might be the case although the first guess for the lifter mechanism turned out to be wrong.

Biefeld-Brown effect

Also Biefeld-Brown effect allows explanation as a recoil effect in many-sheeted space-time. For long time ago T. T. Brown observed [30, 31, 32] that when capacitor plates are loaded with opposite charges by coupling the capacitor to a voltage source, it jumps to the direction of the second plate. The magnitude of the effect depends on the voltage and begins to decrease above some critical voltage and eventually changes its sign. What is strange is that neither energy nor momentum conservation do not seem to hold true if one assumes that only electric energy is liberated: momentum and energy simply seem to appear from nowhere.

The physics of Biefeld-Brown effect is not understood. Thus one might think that an equipment which can be build by school boys would have been built by some physicist long ago. Also one might imagine that some theoretical physicist might have written an article or even two about the phenomenon during this half century which led to TOEs (Theories Of Everything, often regarded as the end of physics!). The fact is that there is only a quite recent article by Thomas Bahler and Chris Fazi of US Army Laboratory about the phenomenon [33]. These researchers checked that the phenomenon is real, and by doing a little calculation demonstrated that the standard physics explanation in terms of ionic wind predicts roughly 10^5 times too small an effect.

A possible explanation is in terms of a recoil effect in many-sheeted space-time. When the voltage is coupled on, the ions with opposite charges rush to the capacitor plates. By their inertia some of them leak to larger space-time sheets (the mechanism of auroras and breakdown of super-conductivity could be essentially the same [J1, J2, J3]). The difference of the binding energies is liberated as additional kinetic energy and momentum of the dropped ion and the recoil momentum is obtained from the elementary text book formulas $E_f = E_i + \Delta E$, $E = p^2/2m$ as

$$\Delta p = -p_i \left(\sqrt{1 + \frac{\Delta E}{E_i}} - 1 \right) ,$$

where ΔE denotes the difference in zero point kinetic energies for a charged particle of mass m and subscripts i and f refer to initial and final states of the charged particle. These recoil momenta are absorbed by the entire system and give rise to a recoil effect if the recoil momenta from the plates do not exactly compensate each other. This is not expected to happen since the positive and negative charge carriers have widely different momenta due to the widely different masses and different velocities.

For definiteness assume that there are only electrons and ions of single type; that they drop to single space-time sheet only; and that capacitor plates have opposite charges during loading so that ionic and electronic currents are of opposite sign at the capacitor plates during loading. Under these assumptions the ratio of the momenta is

$$\frac{p_i(e)}{p_i(I)} = \frac{m_e n_I}{m_I n_e},$$

where $n(e)$ ($n(I)$) refers to the density of the electrons (ions). Combining this with the previous equation, one has

$$\frac{\Delta p(e)}{\Delta p(I)} = -\frac{m_e n_I}{m_I n_e} \left(\frac{\sqrt{1 + \frac{\Delta E(e)}{E_i(e)}} - 1}{\sqrt{1 + \frac{\Delta E(I)}{E_i(I)}} - 1} \right).$$

When several ions are present, one must construct a more elaborate model. Also an effect tending to change the mutual distance of the plates is predicted.

The effect is proportional to the charge of the capacitor plate and thus to the voltage but depends on voltage in nonlinear manner. Since the recoil momenta due to electrons and ions depend on nonlinear manner on voltage. The change of the sign of the effect when voltage increases should be due to the fact that the velocities gained by ions and electrons depend on the voltage in different manners. The electronic band structure of the conductor could play an important role in the effect.

This mechanism is obviously ideal mechanism of locomotion in living matter and it would be surprising if bio-systems would not have invented it.

What lifters are?

Lifter (see the free energy home page of Jean Louis Naudin [29]) has an extremely simple structure: asymmetric pair of oppositely charged electrodes. The first electrode could be a planar foil and second electrode just a conducting wire somehow fixed to the larger electrode using some insulating material. When this capacitor is charged to a voltage about 30 kV it lifts to air. The force is in the direction of the smaller electrode. The presence of a small discharge current between the electrodes could be essential for the effect.

The Biefeld-Brown effect [30, 31, 32] might be behind the lifter effect. The proposed model [K6] for the Biefeld-Brown effect is based on the leakage of the ions from the space-time sheets of the capacitor plates to a larger space-time sheet resulting in a recoil effect. This kind of effect can occur during the charging of the capacitor since there are ionic currents running to the plates. The different masses for ions of opposite charge would cause the effect even in the case that capacitor plates are identical. In this case the direction of the force would depend on the sign of the voltage. Brown reported that there is a correlation of the effect with the sign of the charge but that the motion is always in the direction of the smaller electrode.

On the other hand, the lifter experiments have shown that the sign of the voltage does not have a detectable effect. The effect is possible also for a constant voltage. Some of the ions of the leakage current flowing between the plates through the di-electric could leak to a larger space-time sheet as they enter the second electrode but this would predict the dependence of the effect on the sign of voltage.

The obvious question is whether the mechanism explaining the finding of Modanese and Podkletnov [22] described in previous section might also be involved the lifter effect, and thus provide a further support for the view that either MEs or, more probably, the scalar waves of Tesla, discovered for a century ago and completely neglected by the academic physicists, are involved. Also the so called corona wind, which has been used for centuries for entertainment purposes and explained fluently as an amusing curiosity caused by ionic wind could involve MEs or Tesla's scalar waves.

What causes the lifter effect?

Juha Hartikka [34] has constructed a lifter consisting of two equilateral triangles on top of each other. The upper triangle consists of a copper wire with radius $r(\text{small}) = .03$ mm, and the low triangle of straws with an aluminium folio around them, and having radius $r(\text{big}) = 1.5$ mm. The length of

the side of the triangle is $L = 2.11$ cm (this not of significance now), and the distance between the electrodes is $D = 2.4$ cm. The total mass of the system is .854 g. The contribution of the copper wire to the mass is $M(\text{small}) = .45$ g in the approximation that the density is one atom per Angstrom³ so that the masses of the electrodes are roughly the same.

The most important general findings are following. There is a considerable power expenditure, up to 8 Watts. According to the standard physics expectation this power would be needed to maintain the airflow and to the motion of the lifter. Corona discharge at the wire electrode accompanies the effect, and when corona flow appears at the larger electrode, the effect gets weaker. This suggests a recoil effect appearing only, when the corona discharge is present. Critical voltage is required and sharp edges help to achieve this. The effect is also accompanied by a generation of sounds. The thin electrode is also oscillating in an irregular manner and is curved outside as if experiencing an upwards directed recoil force. Also radio wave emission has been detected.

What could cause the lifter effect?

1. The scalar waves of Tesla could cause the motion of the air by the Modanese-Podkletnov effect. If they cause also the motion of the lifter, both electrodes must emit scalar waves and the small electrode must experience a stronger force. The correlation with the corona discharge however suggests that there is no emission of the scalar waves from the larger electrode, and that the presence of the emission weakens the effect. This would suggest that only the motion of air can be due to the scalar waves.
2. Could the recoil effect be due to the emission of Tesla's scalar waves, when corona discharge is present? In this case the effect would not depend on the sign of the voltage. If the scalar wave pulses leave the lifter with light velocity, the requirement that the gravitational force mg is compensated by the recoil momentum feed, would give $mg = W/c$. For $m \sim 1$ g this would require a power feed $W \sim 10^6$ W. W is found to be below 8 W in the experiments of Juha Hartikka [34]. Therefore this option is definitely excluded.
3. If one substitutes sound velocity $v \simeq 10^{-6}c$ for c ,

$$mg = \frac{W}{v} ,$$

one obtains $W \sim 3$ Watts for $m = 1$ g for the needed power feed and this is below the total power feed. Sound wave emission has been observed. Could the recoil effect be associated with the sparks responsible for the plasma discharge? The sparks would be lightning like exploding plasma regions generated by the ionizing charge flow and generating spherical shock waves during their travel. These shock waves in turn kick the smaller electrode. Since the number of ions in the plasma discharge is much larger than the net charge, there is no dependence on the sign of the voltage.

Does this option make sense? $W = 1$ Watts corresponds to a power of 120 decibels (the formula $P = 10 \times \log_{10}(W/W_0)$, $W_0 = 10^{-12}$ Watt, gives the power in decibels). The power from Walkman radio to single ear can be as high as 80 decibels. The power to single ear in this case would be a fraction of roughly $S/4\pi r^2$ of total power, where r is the distance from the corona discharge and S is the active receptor area of ear. $S = cm^2$ and $r = 1$ m would give factor of order 10^{-5} so that the power to single ear would be something like 70 decibels which sounds too high.

4. The independence of the effect on the sign of the voltage does not support the idea that the recoil would be due to the ions leaving the wire. One can however consider the possibility that the sparks are small plasmoid like structures analogous to ball lightnings. They would emanate from the plasma cloud surrounding the wire electrode and give rise to the recoil effect. The relatively large mass of the plasmoid helps to maximize the strength of the recoil effect. The numbers of the positive and negative ions in the spark would be much larger than the net charge so that there would be no dependence on the sign of the voltage. This option differs from the option 3) for which sparks are not objects travelling through the air but tracks caused by the ions leaking to the larger electrode.

This alternative is encouraged by the crucial role of the plasmoid like structures in TGD inspired theory of consciousness [M1]. Plasmoid like structures are often accompanied by microwave radiation and Juha Hartikka has indeed detected also the presence of radio wave noise in his experiments [34]. The emission of the scalar wave pulses would accompany the emission of plasmoids. Note that also in the experiments of Modanese and Podkletnov a coherent leakage current from super conductor having perhaps plasmoid interpretation is observed [22].

Plasmoids correspond to many-sheeted structures involving super-conducting magnetic flux tubes and atomic space-time sheets with a transfer of ions between various space-time sheets giving rise to and induced by the electromagnetic radiation. The frequency of photons involved corresponds to the difference of the zero point kinetic energies at the space-time sheets involved. For instance, corona glow and radio waves could result in this manner. A considerable part of the leakage current could flow as a supra current, and the recoil effect would result, when a blob of ions from the plasma layer around the thin electrode drops from the atomic space-time sheets to the magnetic flux tubes. This model would actually modify the original model for the Biefeld-Brown effect by replacing ions with blobs of plasma. The same mechanism could also explain why ball lightnings are so stable, that is why their dissipation rate is so low.

General model for the emission of scalar waves

Consider a situation in which one has a planar electrode and a wire electrode above it, both square-shaped, and such that the wires of the wire electrode are parallel to the sides of the planar electrode. One could allow the electrodes to have different sizes.

1. Modanese and Podkletnov study a full discharge at low temperature from a super-conducting electrode whereas now only a small leakage current appears. One can assume that MEs or the TGD counterparts of the Tesla scalar wave pulses are only above the threshold value E_{cr} of the electric field above which also corona discharge occurs. MEs/scalar wave pulses are expected to have a much smaller transversal size since the leakage current is not coherent in the length scale of entire electrodes. The power spent by the system would go to the emission of the scalar waves and to the energy dissipated by the plasma discharge, and the power needed to maintain the motion of air and electrodes could be much higher than this power. This obviously provides a crucial test for the model.
2. One could interpret the scalar wave pulse as a quantum of constant electric field analogous to magnetic flux quantum and escaping the system with light velocity. The power goes to the re-building of the electric field. This argument favours scalar wave pulses instead of MEs. In the case of scalar wave pulses the quantization of the electric flux analogous to that of magnetic flux suggests that the condition $L = \sqrt{n2\pi/eE}$, n integer, is satisfied ($\hbar = c = 1$). For an electric field having a magnitude of order $E \sim kV/m$ (a voltage of 10 kV over a distance of 10 cm) and for $n = 1$ scalar wave pulse would have a length of 9 micrometers. The emission of this quantum would accompany the generation of the plasmoid like structure and Modanese effect could be the mechanism giving rise to the leakage of the ions to the magnetic flux tubes of the plasmoid.
3. If the pulses propagate past any object, temporary bridges between the atomic space-time sheet of the object and some larger space-time sheet are formed, and the ions or atoms from the object leak to the latter. This creates a recoil effect giving rise to a repulsive force. In the case of scalar wave pulses the temporary bridge would carry electric field, which could induce ionic currents of opposite sign between the space-time sheets. In this case the effect could depend on the sign of the voltage unless the leaking matter is dominantly neutral. For MEs there would be no such dependence. It would seem that MEs/scalar waves must spend some time in the state in which they act as bridges but must continue their travel after the delay: otherwise absorption would occur. The delay could be due to the fact that the particles moving along the ME/scalar wave bridge make it temporarily a massive particle so that its motion slows down and almost stops for a while.
4. Also the molecules of the air suffer the same effect and this might be the fundamental cause of the corona wind in neutral air. According to the observations of Juha Hartikka [34], the air between the electrodes is indeed set into fan like motion from the wire electrode to planar electrode and

the flow is non-vanishing also at the surface of the bigger electrode. This downwards flow could indeed be due to the scalar waves emitted from the corona discharge initiated from the wire electrode and affecting also neutral air molecules. The direction of the airflow and its velocity should not depend strongly on the sign of the voltage. One could test whether the effect obeys the same regularities as the effect found by Modanese and Podkletnov. For instance, air-flow should become stronger, when the strength of the electric field at the small electrode increases, and depend only weakly of at all on the distance between the electrodes. If the effect occurs for large distances between planar and wire electrodes, ionic wind as an explanation of the effect can be excluded. Any sharp edge or corner would generate the air flow effect.

5. Since scalar waves seem to be emitted only from the wire electrode where plasma discharge occurs, one can conclude that Modanese- Podkletnov effect can only reduce the lifter effect by direct force to the larger electrode and by the force caused by the airflow.

The simplest assumption is that scalar wave pulses are emitted in the direction of the field lines at the surface of the electrode when plasma discharges occur. Above the threshold the intensity of the scalar wave pulse beam is most naturally proportional to $E^2 - E_{cr}^2$, where E_{cr} is the field value above which the corona discharge begins and E is the field at the surface of the electrode. For a planar electrode this means that the beam of the scalar wave pulses is in the vertical direction and has a constant intensity. For the wire electrode the intensity is inversely proportional to the radial distance from the wire.

In the vicinity of the wire electrode the radial field is very strong and at the surface has the magnitude $E = \sigma_w(\phi)$, where $\sigma(\phi)$ is surface charge density, which depends on the azimuthal angle ϕ in the plane orthogonal to the wire, ϕ can be chosen to be zero in the direction pointing to the planar electrode. The intensity of the scalar wave pulses created by the small electrode is in the radial direction and given by

$$I(\phi) = k(E^2 - E_{cr}^2)(\phi) \times \frac{r_w}{\rho} .$$

The intensity is stronger in directions pointing to the larger electrode. The force experienced by a small test object of mass m is given by

$$F = mI$$

and is in the direction of the scalar wave beam. A test for the hypothesis is whether the local direction of air flow is determined by the directions of field lines at the surface of the electrode or whether the air flow tends to be in the direction of the local electric field.

2.5 New hydrogen technologies and new physics

The anomalies related to energy technologies involving the burning of hydrogen to oxygen are known for decades. In fact, the anomaly related to the thermal dissociation of hydrogen was discovered by the Nobel chemist Irving Langmuir for century ago. For some reason these anomalies are not payed any attention in standard chemistry.

2.5.1 Anomalies related to the dissociation of water and hydrogen molecules

The burning of hydrogen to water liberates energy. Because the process does not seem to produce chemical pollution, hydrogen provides one of the most promising energy sources. The basic problem is that the storage and transport of hydrogen is very expensive. A possible solution to the problem is to produce the hydrogen by the dissociation of water at the location where the energy is used. If this goal is achieved, an outcome is an energy source able to compete with other energy sources most of which will be depleted in any case.

The theoretical problem related to various methods producing hydrogen by dissociation of water is in the nutshell that the dissociation of water requires less energy than one might think knowing the bond energies of O-H bonds [82, 84]. Concerning the basic goal this is of course not a problem. Also the energy needed to dissociate hydrogen thermally is smaller than the binding energy of the hydrogen molecule. This was observed already by Nobel chemist Langmuir for century ago [81]. For

some reason this observation has not received the recognition it would have deserved. Energy flows to the system in both situations and one should understand the origin of this energy.

The zero point kinetic energy of vacuum (ZPE) [85] has been proposed as a solution to the problem. Unfortunately, ZPE theories are not very well defined and far from practically applicable. My intention in the following is to find whether the new physics predicted by TGD might allow to understand the origin of the above mentioned anomalies.

A good guideline is the observation that very many free energy systems involve sharp pulse sequences. Often bi-filar coils invented by Tesla [18] are involved. The liberation of the zero point kinetic energy when particles drop to a larger space-time sheet is a universal liberation of mechanism of energy justifying the notion of free energy. The time mirror mechanism makes possible the control of this process. Either the system needing the energy or controlling the liberation of energy generates negative energy topological light rays accompanied by negative energy photons (generated by a light like vacuum 4-current possibly associated with the topological light ray). Scalar wave pulses could in turn make possible higher level control by inducing the generation of negative energy topological light rays and photons as time reversed version of brehmstrahlung when charged particles are accelerated in the strong electric field of the scalar wave pulse without dissipation.

These ingredients lead to a concrete model for how the origin of the energy liberated in the dissociation of water and to a proposal how this method could be made more effective. If the proposed explanation is correct, the dissociation of water molecules could be induced also by the irradiation of water by phase conjugate laser light, whose frequencies could be fine tuned to correspond to the needed frequencies. This could mean considerable energy savings.

In the following the model explaining the anomalies related to the dissociation of water and hydrogen is discussed. Also a TGD based justification for the notion of hydrino-atom introduced by Randell Mills [86] is proposed.

2.5.2 The anomalies associated with the dissociation of water molecules

In the sequel the general ideas about time mirror mechanism and many-sheeted lasers is applied to the anomalies observed in the dissociation of water.

Constraints on the model of anomalies found in the electrolysis and plasma electrolysis of water

The general theory leaves a lot of freedom for the building of a detailed model. There are however several facts, which provide constraints on the imagination.

1. In plasma electrolysis a pulsed electronic current is an essential part of the process. The natural guess is that the dropping of electrons to larger space-time sheets could excite O-H bonds or O and H atoms to higher energy states. This could happen during the dissociation of the water molecule or already before it. Prof. Kanarev has proposed that the O-H bonds of water molecule are indeed excited before the process. Kanarev has also suggested a separate mechanism in which two electrons join to the water molecule during the dissociation. This mechanism is not needed if the sole role of the electronic current is excitation of the O-H bonds.
2. In very many free energy phenomena a pulsed voltage/current seem to induce the generation of negative energy topological light rays (photons). They in turn would serve as a control signal inducing the generation of positive energy topological light rays (photons) as population inverted many-sheeted laser returns to the ground state. The mechanism generating the phase transition is the same as in the induced emission. This would support the model of Prof. Kanarev: the positive energy photons (analogous to laser beam) would excite the O-H bonds or O and H atoms of the water molecules. Electrons have both thermal and ordered kinetic energy. This means that the energy liberated in the dropping process varies and that the liberated energy can be larger than the zero point kinetic energy. An energy continuum results and makes it possible to excite O and H atoms having a sharply defined transition energies. One can also imagine that so called seesaw mechanism is at work. Negative energy topological light rays would be created in a transition which is the reversal for that producing positive energy topological light rays. Fine tuning would be automatic now. This mechanism might be a central part of bio-control.

3. If the amplification of negative energy signal is based on the mechanism of induced emission, the particles involved must be bosons. Only the Cooper pairs of electrons come into consideration now. In the case of fermions one might think that the dropping of fermions from a given space-time sheet creates free vacancies and makes possible the dropping of fermions to this space-time sheet from smaller space-time sheets. This could induce kind of a chain reaction proceeding from long to short p-adic length scales.
4. The second option is that water molecule emits negative energy photons when it dissociates so that the oxygen and hydrogen atoms of O-H bonds are excited to a higher energy state. This option does not allow to understand the role of the pulse current serving as external controller of the process.

Zero point kinetic energies

If the kinetic energy of the dropping electrons can be neglected, the spectrum for the energy quanta liberated in the dropping process is universal since zero point kinetic energies are fixed by p-adic length scale hypothesis apart from a numerical factor near unity characterizing the shape of the space-time sheet. The formula for the zero point kinetic energy in the non-relativistic case reads as

$$\begin{aligned}
 E_0(k) &= n \times \frac{\pi^2}{2mL(k)^2} , \\
 L(k) &= 2^{(k-151)/2} \times L(151) , \quad L(151) \simeq 10 \text{ nm} .
 \end{aligned}
 \tag{2.5.1}$$

Here m denotes the mass of the particle and n is a numerical constant near one.

Atomic space-time sheet $k = 137$ corresponds in the case of proton to an energy of about .4 eV, which is the basic energy currency of metabolism. This inspires the idea that the basic function of the ADP-ATP system is to drive protons from larger space-time sheets to the atomic space-time sheets by utilizing the chemically stored energy. From this space-time sheet they drop back to the larger space-time sheets liberating the zero point kinetic energy $E_p(137) \simeq .4 \text{ eV}$. An entire hierarchy of metabolic currencies is actually predicted [K6, K1].

Also electrons and their Cooper pairs can drop to larger space-time sheets and in this case the liberated zero point kinetic energy is larger by a factor $m_p/m_e \simeq 2^{11}$. The zero point kinetic energy at $k = 137$ space-time sheet $\sim .4 - .5 \text{ eV}$ is a convenient unit, in terms of which one can express the zero point kinetic energies of proton, electron, electronic and protonic Cooper pair.

$$\begin{aligned}
 E_p(k) &= 2^{137-k} \times .5 \text{ eV} , \\
 E_{2p}(k) &= 2^{137-k-1} \times .5 \text{ eV} , \\
 E_e(k) &= 2^{148-k} \times .5 \text{ eV} , \\
 E_{2e}(k) &= 2^{147-k} \times .5 \text{ eV} .
 \end{aligned}
 \tag{2.5.2}$$

Here the nominal value of .5 eV for $E_p(137)$ is used.

Consistency conditions

A natural consistency condition is that the thermal de Broglie wave length $\lambda_{dB} = \pi/\sqrt{2MT}$, where M denotes the mass of the heaviest particle at particular space-time sheet, is of the same order of magnitude as the p-adic length scale characterizing the size scale for the space-time sheet from which the particle drops.

$$\lambda_{dB} = \frac{\pi}{\sqrt{2MT}} \sim L(k) .
 \tag{2.5.3}$$

On the other hand, super conductivity requires that thermal energy is smaller than the zero point kinetic energy defining the basic energy unit. This gives the condition

$$\lambda_{dB} > L(k) . \quad (2.5.4)$$

Here one must however require that there is no allowed p-adic length scale between λ_{dB} and $L(k)$. What "allowed" means is quite not obvious. The first extreme corresponds to the situation in which all values of the integer k are possible so that p-adic length scales come in half octaves and that all n-ary p-adic length scales are possible. The second extreme corresponds to the situation in which k is prime. At least secondary p-adic length scales (k is two times prime) are allowed, and the model of EEG suggests that all values of k are possible but that those values which correspond to highest cognitive level are the most important ones (every prime factor k_i in the decomposition of k to a product of primes defines a k_i -bit cognitive code[M4]).

Experimental data

The experimental values for the reduction of the binding energy of water allow to estimate the integer k characterizing the space-time sheets from which electrons or their Cooper pairs drop.

1. In the ordinary electrolysis the energy needed to dissociate O-H bond has been found to be only 1/3 of the binding energy $E_w \sim 10$ eV of the water molecule. The reduction of the binding energy is $\Delta E_w \simeq 6.66$ eV.
2. In the plasma electrolysis of Prof. Kanarev the energy needed to dissociate water molecule is only $\sim .5$ eV and the effective reduction of the binding energy is as high as $\Delta E_B \sim 9.5$ eV.

A rough approximation for the energy needed would be 8 eV in both cases. This energy is $2^4 = 16$ higher than the zero point kinetic energy of proton at $k = 137$ space-time sheet. In plasma electrolysis the temperature is in the interval $.5 \times 10^4$ - 10^4 C and around 10^3 C in the ordinary electrolysis.

The four options

One can distinguish between four different models depending on what the reaction mechanism is and whether the energy is donated by electron or electronic Cooper pair.

1. The energy is donated to O-H bond. The ratio r is predicted to be $r = 3.33$ and $r = 4.75$ corresponding to ordinary and plasma electrolysis. The rough estimate is $r = 4$.
2. The energy is donated to the entire water molecule. In this case the ratio of the donated energy to the zero point kinetic energy is $r = 6.66$ in the usual electrolysis and $r = 9.5$ in plasma electrolysis. The rough estimate is $r = 8$.

Furthermore, one can distinguish between two cases according to whether the energy is donated by i) electronic Cooper pairs or ii) electrons. The first option is supported by quantum coherence implying that reaction rate would be proportional to the square of the number of the dropped electronic Cooper pairs. Also the mechanism of the induced emission works for Cooper pairs unlike in the electronic case. It is however better to keep mind open for both options at this stage.

Analysis and conclusions

The following represents the analysis of the four options.

a) Energy is used to excite only single O-H bond.

i) For electronic Cooper pairs the condition $r = 4$ gives $k = 142 = 2 \times 71$ corresponding to the secondary p-adic length scale $L(2, 71) = .56$ nm. The estimate for the thermal de-Broglie wave length in plasma electrolysis is $.7 - 1$ nm. In the ordinary electrolysis de-Broglie wavelength is roughly 2 times longer. In both cases the thermal de Broglie wavelength is longer than the p-adic length scale so that the necessary condition for super-conductivity is satisfied.

ii) In the electronic case the condition $r = 4$ gives for the p-adic length scale the estimate $k = 143 = 11 \times 13 \simeq .8$ nm. This length scale corresponds to the prime $p \simeq 2^{13}$ and would represent a very

low information content unlike $k = 142$, which corresponds to rather large prime $p \simeq 2^{71}$. The ratio $\lambda_{dB}/L(k)$ is same as in the first case.

b) The energy is used to excite the entire water molecule.

i) In the case of electronic Cooper pairs the condition $r = 8$ gives $k = 141 = 3 \times 47$ corresponding to the tertiary p-adic length scale $L(3, 47) \simeq .4$ nm.

ii) In the case of electrons one has $k = 142 = 2 \times 71$.

In both cases the ratio $\lambda_{dB}/L(k)$ grows by a factor $\sqrt{2}$ from the value in the preceding case so that the resulting model is poorer.

As a summary one can state the following.

1. The ratio of the thermal de-Broglie wave length to the p-adic length scale is same for both electron and Cooper pair options since the p-adic length scales are $L(k)$ for electron and $L(k-1)$ for the Cooper pair and differ by a factor of $\sqrt{2}$ from each other.
2. For all options de Broglie wavelength in the case of ordinary electrolysis is at least by a factor of two too large and this forces to question the de Broglie wave length criterion. Of course, one can think that the production of positive energy photons generates temporary hot spots so that de Broglie conditions holds true after all.
3. The dropping of two electronic Cooper pairs per water molecule from $k = 2 \times 71$ space-time sheet is the most promising option, since in this case the mechanism of induced emission is possible and a satisfactory consistency with de Broglie criterion is achieved. The secondary p-adic length scale is also very natural.

Could phase transition to dark matter reduce the energy of OH bonds

An alternative explanation for the findings of Kanarev is that the *energy scale* of some OH bonds is reduced by some new physics mechanism. No excitation would thus be involved. Dark matter hierarchy [A9] provides a candidate for this kind of mechanism.

There is evidence for the occurrence of cold nuclear reactions in Kanarev's plasma electrolysis using KOH and NaOH in water environment [83]. The TGD based model [F9] assuming the presence of dark analogs of Li nuclei modelled as nuclear strings and also longer nuclei obtained by fusing Li nuclear strings can explain the presence of the observed nuclei in the Fe cathode as resulting in cold nuclear reactions. The model is consistent with the TGD based description of cold fusion observed in deuterium systems [F9], and provides also a possible solution to the so called lithium problem of cosmology [52] and $H_{1.5}O$ anomaly of water [53, 54, 55, 56].

$H_{1.5}O$ anomaly suggests that $1/4$ of protons of water are dark in atto-second time scale [F9] and one can imagine that both protons of water molecule can become dark under conditions defined by plasma electrolysis. Also the atomic space-time sheets and electron associated with OH bonds could become dark. The model of cold fusion assumes that the nuclear space-time sheets of Li nuclei become dark in plasma electrolysis so that also their size is scaled up. The phase transition of Li to its dark variant (there would be some kinetic equilibrium) could explain why the abundance of Li predicted by standard Big Bang cosmology is by a factor of 2.5 higher than the measured abundance.

Atomic binding energies transform as $1/\hbar^2$ and are scaled down. If the energy of hydrogen bond transforms like Coulombic interaction energy as given by the perturbative calculation, it is scaled down as $1/\hbar$ since the length of the bond scales up like \hbar . Effectively $\alpha_{em} \propto 1/\hbar$ is replaced by its scaled down value. For $\hbar \rightarrow 2^4 \hbar_0$ the energy would scale from 8 eV to .5 eV and the standard metabolic energy quantum could induce the splitting of the dark OH bond. If 2^4 is the scale factor of \hbar for dark nuclear space-time sheets, their size would be of order 10^{-3} meters. A scaling up to the size of even atomic size is considered in [F9].

The fact that the energy of hydrogen bonds [58] is typically around .5 eV forces to ask what distinguishes hydrogen bond from dark OH bond. Could it be that the two bonds are one and the same thing so that dark OH bonds would form standard part of the standard chemistry and molecular biology? In hydrogen bond same hydrogen would be shared by the oxygen atoms of the neighboring atoms. For the first O the bond would be ordinary OH bond and for the second O its dark variant with scaled down Coulomb energy. In plasma electrolysis both bonds would become dark. The variation of the hydrogen bond energy could reflect the variation of the scaling factor of \hbar . The concentration of the spectrum of bond energies on integer multiples of fundamental energy scale - or even better, on

powers of 2 - would provide support for the identification. There is evidence for two kinds of hydrogen bonds with bond energies in ratio 1:2 [60, 59]: the TGD based model is discussed in [F9]. The energy needed to transform the bond to dark bond could come from remote metabolism from the dropping of dark protons from a dark variant of some sub-atomic space-time sheet with size not smaller than the size of the atomic space-time sheet to a larger space-time sheet.

2.5.3 The anomaly related to the thermal dissociation of molecular hydrogen

Already the Nobel-chemist Langmuir found, that thermal dissociation in a temperature range extending up to the temperature of $T = 2200$ K, led to a much higher dissociation rate than one might expect on basis of thermodynamical considerations. The binding energy of the hydrogen molecule is 4.52 eV. If one requires that the ratio of the dissociated molecules to that of non-dissociated molecules is given as by the Boltzmann exponent $\exp(-E_b/kT)$, a discrepancy of order 10^8 results. If one assumes that the effective binding energy is $\simeq .44$ eV, a correct result is obtained.

This suggests that also now the dissociating hydrogen molecule receives energy from some source and that the energy is ~ 4 eV. Dissociation mechanism could be based either on the self-excitation of the hydrogen molecule by the emission of negative energy photons. Also some other system could emit negative energy photons and induce a cascade of positive energy photons. One has two options.

1. The dropping of an electronic Cooper pair from $k = 142 = 2 \times 71$ space-time sheet is involved as in the case of the optimal mechanism for the dissociation of water.
2. The dropping of an electron from $k = 143$ space-time sheet is an alternative option.

2.5.4 Hydrino atoms, anyons, and fractional quantization in many-sheeted space-time

The so called hydrino atom concept of Randell Mills [86] represents one of the notions related to free energy research not taken seriously by the community of university physicists. What is claimed that hydrogen atom can exist as scaled down variants for which binding energies are much higher than usually due to the large Coulombic energy. The claim is that the quantum number n having integer values $n = 0, 1, 2, 3, \dots$ and characterizing partially the energy levels of the hydrogen atom can have also inverse integer values $n = 1/2, 1/3, \dots$. The claim of Mills is that the laboratory BlackLight Inc. led by him can produce a plasma state in which transitions to these exotic bound states can occur and liberate as a by-product usable energy.

The National Aeronautic and Space Administration has dispatched mechanical engineering professor Anthony Marchese from Rowan University to BlackLight's labs in Cranbury, NJ, to investigate whether energy plasmas-hot, charged gases- produced by Mills might be harnessed for a new generation of rockets. Marchese reported back to his sponsor, the NASA Institute for Advanced Concepts, that indeed the plasma was so far unexplainably energetic. An article about the findings of Mills and collaborators have been accepted for publication in Journal of Applied Physics so that there are reasons to take seriously the experimental findings of Mills and collaborators even if one does not take seriously the theoretical explanations.

The question to be addressed in the following is whether the many-sheeted space-time concept could allow to understand the claimed $n \rightarrow 1/n$ generalization of the Bohr's quantization rules claimed by Mills or a generalization of this rule consistent with the experimental findings of Mills. In the following I discuss three arguments allowing to understand the scaled up energy spectra claimed by Mills. These arguments are not independent and do not exclude each other.

p-Adic quantization and fractional spectrum

p-Adic integers $n = \sum n_k p^k, k \geq 0$, can have infinite values as real integers. If one requires that p-adic integer has a binary expansion which is periodic, only p-adic integers, which correspond to rationals are possible: $n \rightarrow q = r/s$, where s is not divisible by p . The expansion of $1/s$ in powers of p indeed gives rise to an infinite (in real sense) p-adic integer.

One might argue that all rational values of the principal quantum number n of hydrogen atom are actually possible, which would mean that the spectrum is effectively continuous as in classical physics.

What quantum physics would bring in would be the selection of integers from other rational numbers so that effectively one would have integer spectrum under the usual experimental conditions.

Fractional valued quantum numbers and controlled transition to chaos

Bohr's quantization rules apply to completely integrable systems for which complete separation of variables occurs so that one effectively has a set of one-dimensional systems performing motion on circle or line. One can quantize the motion separately in each dynamical degree of freedom characterized by a cyclic coordinate q_i and the corresponding canonical momentum p_i . If q_i is a circle coordinate, one can use the basic quantization rule

$$\oint p_i dq_i = n_i \hbar ,$$

Here the integral is over a full cycle of the periodic motion. If q_i corresponds to a motion on line, no quantization rule is applied.

Primes are known to appear, when one attempts to quantize chaotic systems and effectively p-adic physics might be closely related to the approach to the chaos implied by the classical non-determinism of the Kähler action. This suggests that fractional quantization might emerge in a system for which the interactions with the environment destroy the simple periodic motion, which is the prerequisite for the application of Bohr's quantization rules.

So, an interesting question is what occurs when the motion is slightly perturbed. Do orbits become non-closed or do they close after N cycles so that the transition to the chaos corresponds to the sequence $N = 1 \rightarrow 2 \rightarrow 3 \rightarrow \dots$. Period doubling leading to chaos represents just this kind of series of perturbations with $N = 2^k$, $k = 1, 2, \dots$. In TGD universe, where orbits could correspond to space-time sheets themselves, this kind of ordered transition to chaos could be realized in contrast to what one might expect in standard physics.

The natural guess would be that one must replace the quantization condition with

$$\oint p_i dq_i = \frac{n_i}{N} \hbar ,$$

where the integration is over the previous cycle, which has become $1/N$:th cycle. In the case of hydrogen atom this would give rise to a fractional angular momenta m and fractional principal quantum number n , and the spectrum would contain the spectrum claimed by Mills.

One could argue that all rational numbers, for which the denominator is not divisible by the prime p characterizing the atomic space-time sheet, represent possible values of the principal quantum number n . The most natural estimate for p is $p \simeq 2^{137}$ (that fine structure constant is in a good approximation $\alpha = 1/137$ might express cosmic sense of humor). The requirement that the rest energy of the electron stays positive, gives the condition $N < 1/\alpha \simeq 137$. Quantum physics favors finite integers because of their finite binary expansion and in the usual experimental situation only integer spectrum would be possible. As the system grows more complex, also the values $1/n$ and m/n of the principal quantum number would become possible.

Fractional quantization and controlled transition to chaos at space-time level

In TGD all quantum level concepts should have space-time correlates. In particular, Bohr's quantization rules have exact counterparts TGD and are implied by the absolute minimization of Kähler action. Also the proposed transition to chaos by the generation of orbits which close only after N cycles should have a natural space-time correlate.

I have already earlier proposed that the orbits of electrons in atoms could be more than a fictive concept and have concrete 3-surfaces as their representatives. One might say that electrons would move along quantum tracks. This is consistent with the general vision that space-time surface provides symbolic representation for all quantum physics concepts. This means that the electronic space-time sheet having size of order electron Compton length would be topologically condensed at representing the classical orbit of electron. In TGD universe all quantum phenomena should have classical space-time correlates and also the quantum resolution of the well known infrared catastrophe (electron slows down by emitting brehmstrahlung and falls into the nucleus) should have a space-time correlate.

Closing the electron inside a closed tubular structure representing its path would clearly prevent the infrared catastrophe.

In the first approximation the ordinary orbit of electron would be replaced by a torus like tube along the classical orbit within which the electron wave function is concentrated. For $N > 1$ the torus would run around N times before closing. The transformation of closed orbital 3-space sheets to orbital 3-space sheets closing after N cycles occurs very naturally at the level of space-time sheets. The closure must occur for some value of N since otherwise the resulting orbital 3-surface would be extremely irregular, have infinite volume, and could carry infinite classical field energy. It is natural to expect that the transition occurs by the sequence $N = 1 \rightarrow 2 \rightarrow 3 \dots$ or some sub-sequence of it. One can image that in high temperature plasma the interactions with the external world might indeed replace the simple periodic Bohr orbitals with orbitals which would close only after N cycles.

1. Fractional Bohr quantization

In fractional Bohr quantization the angular momentum component would be quantized in units of \hbar/N rather than \hbar .

$$\oint p_\phi d\phi = \frac{m}{N} \hbar ,$$

This phenomenon could also provide the space-time correlate for anyons having fractional angular momentum and giving rise to fractional quantum Hall effect. The quantization condition for the radial variable would be also replaced by a more general quantization condition

$$\oint p_r dr = \frac{n}{N} \hbar.$$

This would give as a special case the quantization rule proposed by Mills. Quite generally, the spectrum of hydrogen atom would be scaled up by N^2 , $N = 2, 3, 4, \dots$ or some subsequence of this sequence.

2. Constraints on the orbital 3-surface

The picture based on formal Bohr rules is too simplistic and might be even wrong. In particular, one can ask is the value of N same for both radial and angular degrees of freedom. A more detailed consideration indeed shows that naive fractional Bohr quantization need not be correct approach.

A more concrete space-time picture results, when one takes into account the requirement that the Coulomb force experienced by electron corresponds to intuitive expectations.

1. The electric gauge flux must flow to the orbital surface somehow, either through wormhole contacts or through join along bonds connecting the orbital surface to the boundaries of holes in atomic space-time sheet. The latter option looks more natural. If only part of the flux flows to the orbital surface, also orbital surface suffers Coulomb force. The failure for the imbeddability of the electric field is expected to cause the generation of holes in the 3-space.
2. The average Coulombic force at various sheets of the multiple-sheeted orbital surface must be same.

By applying these constraints one ends up to two simple prototype realizations for the multiply-sheeted orbital surface, which could be called neo-classical and non-classical. Also the hybrid of these options is possible.

3. The neo-classical option allows fractional quantization of magnetic quantum number m .

For neo-classical option the $1/N$ -periods of the orbit corresponds to slightly different radii. The Compton length of electron, about 10^{-12} meters determines the thickness of the orbital sheet. Since the natural scale of the atomic resolution is Bohr radius $a_0 \simeq 10^{-10}$ meters, it is possible to have roughly $N = 100$ without too strong effects on the force experienced by electron. $N = 137$ would follow from the requirement that the rest mass of electron stays positive and is natural because $p \simeq 2^k$, $k = 137$ defines the p-adic length scale of the atomic space-time sheet.

The electric gauge flux would flow to the orbital 3-surface and back from it. This option is nearest to the one suggested by classical physics intuition and one can indeed imagine that the perturbations caused by the interaction with environment have this kind of effect.

Bohr quantization argument would suggest fractional quantization of both m and n . One can however argue that the radial and angular degrees of freedom separate in a good approximation at the level of Schrödinger equation, and that one obtains fractional quantization for the magnetic quantum number m but not for the principal quantum number n . Thus this option would not produce the desired N^2 -scaling of the energy spectrum but would allow to understand anyon physics at space-time level.

4. *The non-classical option allows fractional quantization of the radial quantum number n .*

The multiply-sheeted orbit could be also analogous to a Riemann surface associated with a multiple valued complex function $z^{1/N}$. That is the various sheets are at the top of each other: this option does not have any classical mechanics counterpart so that the attribute "non-classical" is well-motivated. This requires that there are $N - 1$ folds in the radial direction so that the structure is like a carpet folded back for some length, then continuing in the initial direction, folded back ... There is no obvious upper bound for the value of N .

In those parts of the multiple fold rug, where the electric field is oriented inwards, electron suffers a repulsive force and cannot form stable states at these sheets. Situation is clearly same as in catastrophe theory, where these parts of the cusp catastrophe represent maxima of potential as a function of the external parameters. How the interaction with the environment folds the rug might be understood in terms of catastrophe theory.

If the orbital 3-surface is rotationally symmetric, Schrödinger equation allows a complete decoupling between radial and rotational degrees of freedom. In this case one would have fractional quantization for the principal quantum number n only but not for the magnetic quantum number m . The cautious conclusion is that the experimental arrangement of Mills indeed demonstrates a new physics effect which does not have any classical mechanics counterpart.

One can combine radial and angular fractional quantizations in various manners.

1. Radially N_r -fold orbital surface closes after N_ϕ rotations. In this case these degrees of freedom separate completely.
2. A given radial fold is glued after each rotation to a different radial fold. In the general case the fractional quantizations of the radial and angular degrees of freedom can still correspond to different integers N_r and $N_\phi < N_r$ such that $N_\phi > 1$ divides N_r . If one has $N_r = p$, p prime, only $N_\phi = N_r = p$ is possible.

2.5.5 An explanation of findings of Mills in terms of quantized Planck constant

The recent view about quantization of Planck constants allows to understand the findings of Mills elegantly.

Quantization of Planck constants and the generalization of the notion of imbedding space

The recent geometric interpretation for the quantization of Planck constants is based on Jones inclusions of hyper-finite factors of type II_1 [A9].

1. Different values of Planck constant correspond to imbedding space metrics involving scalings of M^4 resp. CP_2 parts of the metric deduced from the requirement that distances scale as $\hbar(M^4)$ resp. $\hbar(CP_2)$. Denoting the Planck constants by $\hbar(M^4) = n_a \hbar_0$ and $\hbar(CP_2) = n_b \hbar_0$, one has that covariant metric of M^4 is proportional to n_b^2 and covariant metric of CP_2 to n_a^2 . In Kähler action only the effective Planck constant $\hbar_{eff}/\hbar_0 = \hbar(M^4)/\hbar(CP_2)$ appears and by quantum classical correspondence same is true for Schrödinger equation. Elementary particle mass spectrum is also invariant. Same applies to gravitational constant. The alternative assumption that M^4 Planck constant is proportional to n_b would imply invariance of Schrödinger equation but would not allow to explain Bohr quantization of planetary orbits and would to certain degree trivialize the theory (to be honest I believed to this option for some time and it produced a lot of confusion).
2. M^4 and CP_2 Planck constants do not fully characterize a given sector $M^4_\pm \times CP_2$. Rather, the scaling factors of Planck constant given by the integer n characterizing the quantum phase

$q = \exp(i\pi/n)$ corresponds to the order of the maximal cyclic subgroup for the group $G \subset SU(2)$ characterizing the Jones inclusion $\mathcal{N} \subset \mathcal{M}$ of hyper-finite factors realized as subalgebras of the Clifford algebra of the "world of the classical worlds". This means that subfactor \mathcal{N} gives rise to G -invariant configuration space spinors having interpretation as G -invariant fermionic states.

3. $G_b \subset SU(2) \subset SU(3)$ defines a covering of M_+^4 by CP_2 points and $G_a \subset SU(2) \subset SL(2, C)$ covering of CP_2 by M_+^4 points with fixed points defining orbifold singularities. Different sectors are glued together along CP_2 if G_b is same for them and along M_+^4 if G_a is same for them. The degrees of freedom lost by G -invariance in fermionic degrees of freedom are gained back since the discrete degrees of freedom provided by covering allow many-particle states formed from single particle states realized in G group algebra. Among other things these many-particle states make possible the notion of N-atom.
4. Phases with different values of scalings of M^4 and CP_2 Planck constants behave like dark matter with respect to each other in the sense that they do not have direct interactions except at criticality corresponding to a leakage between different sectors of imbedding space glued together along M^4 or CP_2 factors. In large $\hbar(M^4)$ phases various quantum time and length scales are scaled up which means macroscopic and macro-temporal quantum coherence. In particular, quantum energies associated with classical frequencies are scaled up by a factor n_a/n_b which is of special relevance for cyclotron energies and phonon energies (superconductivity). For large $\hbar(CP_2)$ the value of \hbar_{eff} is small: this leads to interesting physics: in particular the binding energy scale of hydrogen atom increases by the factor n_b/n_a^2 .

Explanation for the findings of Mills

Also the small values of $\hbar_{eff} = n_a/n_b$ are interesting since in this case hydrogen atom binding energy scale increases by factor $(n_b/n_a)^2$ as Planck constant decreases (this conforms with the interpretation about approach to chaos in systems like plasmas). The assumption $n_b/n_a = k = 2, 3, \dots$ predicts exactly the binding energies reported of Mills. Also the fact that for $n_b/n_a > 137$ the binding energy becomes larger than electron rest mass remaining invariant in the phase transition implies trivially the upper bound $k \leq 137$.

More generally, this picture leads to the notion of N-atom. The space-time sheets can be regarded as $N(G_b)$ -fold coverings of M^4 by CP_2 points related by subgroup $G_b \subset SU(2) \subset SU(3)$ (color group) and this means that one can put one hydrogen atom to each sheet of the covering (analogous to multi-sheeted Riemann surface). The signature for N-atom would be scaled up binding energy spectrum whereas vibrational energies would be scaled downwards.

Another kind of N-atom results for $n_a/n_b > 1$. This N-atom would be like N-molecule having discrete spatial symmetry characterized by $G_a \subset SO(3)$: for large values of n_a the symmetry would consist of planar rotations and reflections with number-theoretically preferred values of n_a corresponding to Fermat polygons constructible using only ruler and compass. The only genuinely 3-D symmetry groups would correspond to tetrahedral and icosahedral symmetries which are encountered in the structure of water. Icosahedral and dual dodecahedral structures are very abundant in living matter.

In this case energies $E = hf$ associated with classical frequencies are scaled up by factor $n_a/n_b > 1$ so that the vibrational modes need not be masked by the thermal noise. Note that also the quantum energies associated with cyclotron and plasma frequency are scaled up. For $n_a/n_b = n$ integer, one can ask whether the vibrational dark photons emitted by dark atoms could decay to n ordinary photons having ordinary vibrational energy. The signature would be the appearance of a compound such as water in places where it is not thermally stable.

2.5.6 Could q-Laguerre equation relate to the claimed fractionation of the principal quantum number for hydrogen atom?

In [F9] a semiclassical model based on dark matter and hierarchy of Planck constants is developed for the fractionized principal quantum number n claimed by Mills [86] to have at least the values $n = 1/k$, $k = 2, 3, 4, 5, 6, 7, 10$. This model can explain the claimed fractionization of the principal quantum number n for hydrogen atom [86] in terms of single electron transitions for all cases. The original model could not cope with $n = 1/2$: the basic reason is that Jones inclusions are characterized by quantum

phases $q = \exp(i\pi/n)$, $n > 2$. Since quantum deformation of the standard quantum mechanism is involved, this motivated an attempt to understand the claimed fractionization in terms of q-analog of hydrogen atom. The safest interpretation for them would be as states which can exist in ordinary imbedding space (and also in other branches). The natural guess would be that they can occur as intermediate states in the phase transition changing $n_b/n_a = 1$ to $k = 2, 3, \dots$

The Laguerre polynomials appearing in the solution of Schrödinger equation for hydrogen atom possess quantum variant, so called q-Laguerre polynomials [17], and one might hope that they would allow to realize this semiclassical picture at the level of solutions of appropriately modified Schrödinger equation and perhaps also resolve the difficulty associated with $n = 1/2$. Unfortunately, the polynomials discussed in [17] correspond to $0 < q \leq 1$ rather than complex values of $q = \exp(i\pi/m)$ on circle and the extrapolation of the formulas for energy eigenvalues gives complex energies.

q-Laguerre equation for $q = \exp(i\pi/m)$

The most obvious modification of the Laguerre equation for S -wave sates (which are the most interesting by semiclassical argument) in the complex case is based on the replacement

$$\begin{aligned} \partial_x &\rightarrow \frac{1}{2}(\partial_x^q + \partial_x^{\bar{q}}) \\ \partial_x^q f &= \frac{f(qx) - f(x)}{(q-1)x} , \\ q &= \exp(i\pi/m) \end{aligned} \quad (2.5.5)$$

to guarantee hermiticity. When applied to the Laguerre equation

$$x \frac{d^2 L_n}{dx^2} + (1-x) \frac{dL_n}{dx} = nL_n , \quad (2.5.6)$$

and expanding L_n into Taylor series

$$L_n(x) = \sum_{n \geq 0} l_n x^n , \quad (2.5.7)$$

one obtains difference equation

$$\begin{aligned} a_{n+1} l_{n+1} + b_n l_n &= 0 , \\ a_{n+1} &= \frac{1}{4R_1^2} [R_{2n+1} - R_{2n} + 2R_{n+1}R_1 + 3R_1] + \frac{1}{2R_1} [R_{n+1} + R_1] \\ b_n &= \frac{R_n}{2R_1} - n^q + \frac{1}{2} , \\ R_n &= 2\cos[(n-1)\pi/m] - 2\cos[n\pi/m] . \end{aligned} \quad (2.5.8)$$

Here n^q is the fractionized principal quantum number determining the energy of the q-hydrogen atom. One cannot pose the difference equation on l_0 since this together with the absence of negative powers of x would imply the vanishing of the entire solution. This is natural since for first order difference equations lowest term in the series should be chosen freely.

Polynomial solutions of q-Laguerre equation

The condition that the solution reduces to a polynomial reads as

$$b_n = 0 \quad (2.5.9)$$

and gives

$$n^{(q)} = \frac{1}{2} + \frac{R_n}{2R_1} , \quad (2.5.10)$$

For $n = 1$ one has $n^{(q)} = 1$ so that the ground state energy is not affected. At the limit $N \rightarrow \infty$ one obtains $n^{(q)} \rightarrow n$ so that spectrum reduces to that for hydrogen atom. The periodicity $R_{n+2Nk} = R_n$ reflects the corresponding periodicity of the difference equation which suggests that only the values $n \leq 2m - 1$ belong to the spectrum. Spectrum is actually symmetric with respect to the middle point $[N/2]$ which suggests that only $n < [m/2]$ corresponds to the physical spectrum. An analogous phenomenon occurs for representations of quantum groups. When m increases the spectrum approaches integer valued spectrum and one has $n > 1$ so that no fractionization in the desired sense occurs for polynomial solutions.

Non-polynomial solutions of q-Laquerre equation

One might hope that non-polynomial solutions associated with some fractional values of $n^{(q)}$ near to those claimed by Mills might be possible. Since the coefficients a_n and b_n are periodic, one can express the solution ansatz as

$$\begin{aligned} L_n(x) &= P_a^{2m}(x) \sum_k a^k x^{2mk} = P_a^{2m}(x) \frac{1}{1 - ax^{2m}} , \\ P_a^{2m}(x) &= \sum_{k=0}^{2m-1} l_k x^k , \\ a &= \frac{l_{2m}}{l_0} , \end{aligned} \quad (2.5.11)$$

This solution behaves as $1/x$ asymptotically but has pole at $x_\infty = (1/a)^{1/2m}$ for $a > 0$. The expression for $l_{2m}/l_0 = a$ is

$$a = \prod_{k=1}^{2m} \frac{b_{2m-k}}{a_{2m-k+1}} . \quad (2.5.12)$$

This can be written more explicitly as

$$\begin{aligned} a &= (2R_1)^{2m} \prod_{k=1}^{2m} X_k , \\ X_k &= \frac{R_{2m-k} + (-2n^{(q)} + 1)R_1}{R_{4m-2k+1} - R_{4m-2k} + 4R_{2m-k+1}R_1 + 2R_1^2 + 3R_1} , \\ R_n &= 2\cos[(n-1)\pi/m] - 2\cos[n\pi/m] . \end{aligned} \quad (2.5.13)$$

This formula is a specialization of a more general formula for $n = 2m$ and resulting ratios l_n/l_0 can be used to construct P_a^{2m} with normalization $P_a^{2m}(0) = 1$.

Results of numerical calculations

Numerical calculations demonstrate following.

1. For odd values of m one has $a < 0$ so that a a continuous spectrum of energies seems to result without any further conditions.
2. For even values of m a has a positive sign so that a pole results.

For even value of m it could happen that the polynomial $P_a^{2m}(x)$ has a compensating zero at x_∞ so that the solution would become square integrable. The condition for reads explicitly

$$P_a^{2m}\left(\left(\frac{1}{a}\right)^{\frac{1}{2m}}\right) = 0 . \quad (2.5.14)$$

If $P_a^{2m}(x)$ has zeros there are hopes of finding energy eigen values satisfying the required conditions. Laguerre polynomials and also q-Laguerre polynomials must possess maximal number of real zeros by their orthogonality implied by the hermiticity of the difference equation defining them. This suggests that also $P_a^{2m}(x)$ possesses them if a does not deviate too much from zero. Numerical calculations demonstrate that this is the case for $n^q < 1$.

For ordinary Laguerre polynomials the naive estimate for the position of the most distant zero in the units used is larger than n but not too much so. The naive expectation is that L_{2m} has largest zero somewhat above $x = 2m$ and that same holds true a small deformation of L_{2m} considered now since the value of the parameter a is indeed very small for $n^q < 1$. The ratio $x_\infty/2m$ is below .2 for $m \leq 10$ so that this argument gives good hopes about zeros of desired kind.

One can check directly whether x_∞ is near to zero for the experimentally suggested candidates for n^q . The table below summarizes the results of numerical calculations.

1. The table gives the exact eigenvalues $1/n^q$ with a 4-decimal accuracy and corresponding approximations $1/n^q \simeq k$ for $k = 3, \dots, 10$. For a given value of m only single eigenvalue $n^q < 1$ exists. If the observed anomalous spectral lines correspond to single electron transitions, the values of m for them must be different. The value of m for which $n^q \simeq 1/k$ approximation is optimal is given with boldface. The value of k increases as m increases. The lowest value of m allowing the desired kind of zero of P^{2m} is $m = 18$ and for $k \in \{3, 10\}$ the allowed values are in range 18, ..., 38.
2. $n^q = 1/2$ does not appear as an approximate eigenvalue so that for even values of m quantum calculation produces same disappointing result as the classical argument. Below it will be however found that $n^q = 1/2$ is a universal eigenvalue for odd values of m .

m	$1/n^q \simeq$	$1/n^q$	m	$1/n^q \simeq$	$1/n^q$
18	3	2.7568	30	8	7.5762
20	4	3.6748	32	8	8.3086
22	5	4.5103	34	9	9.0342
24	5	5.3062	36	10	9.7529
26	6	6.0781	38	10	10.4668
28	7	6.8330			

Table 1. The table gives the approximations $1/n^q \simeq 1/k$ and corresponding exact values $1/n^q$ in the range $k = 3, \dots, 10$ for which $P_a^{2m}(x_\infty)$ is nearest to zero. The corresponding values of $m = 2k$ vary in the range, $k = 18, \dots, 38$. For odd values of m the value of the parameter a is negative so that there is no pole. Boldface marks for the best approximation by $1/n^q \simeq k$.

How to obtain $n^q = 1/2$ state?

For odd values of m the quantization recipe fails and physical intuition tells that there must be some manner to carry out quantization also now. The following observations give a hunch about be the desired condition.

1. For the representations of quantum groups only the first m spins are realized. This suggests that there should exist a symmetry relating the coefficients l_n and l_{n+m} and implying $n^q = 1/2$ for odd values of m . This symmetry would remove also the double degeneracy associated with the almost integer eigenvalues of n^q . Also other fractional states are expected on basis of physical intuition.

2. For $n^q) = 1/2$ the recursion formula for the coefficients l_n involves only the coefficients R_m .
3. The coefficients R_k have symmetries $R_k = R_{k+2m}$ and $R_{k+m} = -R_m$.

There is indeed this kind of symmetry. From the formula

$$\begin{aligned} \frac{l_n}{l_0} &= (2R_1)^n \prod_{k=1}^n X_k , \\ X_k &= \frac{R_{n-k} + (-2n^q) + 1)R_1}{[R_{2n-2k+1} - R_{n-2k} + 4R_{n-k+1}R_1 + 2R_1^2 + 3R_1]} \end{aligned} \quad (2.5.15)$$

one finds that for $n^q) = 1/2$ the formula giving l_{n+m} in terms of l_n changes sign when n increases by one unit

$$\begin{aligned} A_{n+1} &= (-1)^m A_n , \\ A_n &= \prod_{k=1}^m \frac{b_{n+m-k}}{a_{n+m-k+1}} = \prod_{k=1}^m (2R_1)^m \prod_{k=1}^m X_{k+n} . \end{aligned} \quad (2.5.16)$$

The change of sign is essentially due to the symmetries $a_{n+m} = -a_n$ and $b_{n+m} = b_n$. This means that the action of translations on A_n in the space of indices n are represented by group Z_2 .

This symmetry implies $a = l_{2m}/l_0 = -(l_m)(l_0)^2$ so that for $n^q) = 1/2$ the polynomial in question has a special form

$$\begin{aligned} P_a^{2m} &= P_a^m(1 - Ax^m) , \\ A &= A_0 . \end{aligned} \quad (2.5.17)$$

The relationship $a = -A^2$ implies that the solution reduces to a form containing the product of m^{th} (rather than $(2m)^{th}$) order polynomial with a geometric series in x^m (rather than x^{2m}):

$$L_{1/2}(x) = \frac{P_a^m(x)}{1 + Ax^m} . \quad (2.5.18)$$

Hence the n first terms indeed determine the solution completely. For even values of m one obtains similar result for $n^q) = 1/2$ but now A is negative so that the solution is excluded. This result also motivates the hypothesis that for the counterparts of ordinary solutions of Laguerre equation sum (even m) or difference (odd m) of solutions corresponding to n and $2m - n$ must be formed to remove the non-physical degeneracy.

This argument does not exclude the possibility that there are also other fractional values of n allowing this kind of symmetry. The condition for symmetry would read as

$$\begin{aligned} \prod_{k=1}^m (R_k + \epsilon R_1) &= \prod_{k=1}^m (R_k - \epsilon R_1) , \\ \epsilon &= (2n^q) - 1 . \end{aligned} \quad (2.5.19)$$

The condition states that the odd part of the polynomial in question vanishes. Both ϵ and $-\epsilon$ solutions so that $n^q)$ and $1 - n^q)$ are solutions. If one requires that the condition holds true for all values of m then the comparison of constant terms in these polynomials allows to conclude that $\epsilon = 0$ is the only universal solution. Since ϵ is free parameter, it is clear that the m :th order polynomial in question has at most m solutions which could correspond to other fractionized eigenvalues expected to be present on basis of physical intuition.

This picture generalizes also to the case of even n so that also now solutions of the form of Eq. 2.5.18 are possible. In this case the condition is

$$\prod_{k=1}^m (R_k + \epsilon R_1) = - \prod_{k=1}^m (R_k - \epsilon R_1) . \quad (2.5.20)$$

Obviously $\epsilon = 0$ and thus $n = 1/2$ fails to be a solution to the eigenvalue equation in this case. Also now one has the spectral symmetry $n_{\pm} = 1/2 \pm \epsilon$.

The symmetry $R_n = (-1)^m R_{n+m-1} = (-1)^m R_{n-m-1} = (-1)^m R_{m-n+1}$ can be applied to show that the polynomials associated with ϵ and $-\epsilon$ contain both the terms $R_n - \epsilon$ and $R_n + \epsilon$ as factors except for odd m for $n = (m+1)/2$. Hence the values of n can be written for even values of m as

$$n^q(n) = \frac{1}{2} \pm \frac{R_n}{2R_1} , \quad n = 1, \dots, \frac{m}{2} , \quad (2.5.21)$$

and for odd values of m as

$$\begin{aligned} n_{\pm}^q(n) &= \frac{1}{2} \pm \frac{R_n}{2R_1} , \quad n = 1, \dots, \frac{m+1}{2} - 1 , \\ n^q &= 1/2 . \end{aligned} \quad (2.5.22)$$

Plus sign obviously corresponds to the solutions which reduce to polynomials and to $n^q \simeq n$ for large m . The explicit expression for n^q reads as

$$n_{\pm}^q(n) = \frac{1}{2} \pm \frac{(\sin^2(\pi(n-1)/2m) - \sin^2(\pi n/2m))}{2\sin^2(\pi/2m)} . \quad (2.5.23)$$

At the limit of large m one has

$$n_{+}^q(n) \simeq n , \quad n_{-}^q(n) \simeq 1 - n . \quad (2.5.24)$$

so that the fractionization $n \simeq 1/k$ claimed by Mills is not obtained at this limit. The minimum for $|n^q|$ satisfies $|n^q| < 1$ and its smallest value $|n^q| = .7071$ corresponds to $m = 4$. Thus these zeros cannot correspond to $n^q \simeq 1/k$ yielded by the numerical computation for even values of m based on the requirement that the zero of P^{2m} cancels the pole of the geometric series.

Some comments

Some closing comments are in order.

1. An open question is whether there are also zeros $|n^q| > 1$ satisfying $P_a^{2m}((1/a)^{1/2m}) = 0$ for even values of m .
2. The treatment above is not completely general since only s-waves are discussed. The generalization is however a rather trivial replacement $(1-x)d/dx \rightarrow (l+1-x)d/dx$ in the Laguerre equation to get associated Laguerre equation. This modifies only the formula for a_{n+1} in the recursion for l_n so that expression for n^q , which depends on b_n 's only, is not affected. Also the product of numerators in the formula for the parameter $a = l_{2m}/l_0$ remains invariant so that the general spectrum has the spectral symmetry $n^q \rightarrow 1 - n^q$. The only change to the spectrum occurs for even values of m and is due to the dependence of $x_{\infty} = (1/a)^{1/2m}$ on l and can be understood in the semiclassical picture. It might happen that the value of l is modified to its q counterpart corresponding to q-Legendre functions.

3. The model could partially explain the findings of Mills and $n^a) \simeq 1/k$ for $k > 2$ also fixes the value of corresponding m to a very high degree so that one would have direct experimental contact with generalized imbedding space, spectrum of Planck constants, and dark matter. The fact that the fractionization is only approximately correct suggests that the states in question could be possible for all sectors of imbedding space appear as intermediate states into sectors in which the spectrum of hydrogen atom is scaled by $n_b/n_a = k = 2, 3, \dots$
4. The obvious question is whether q-counterparts of angular momentum eigenstates ($idf_m/d\phi = mf_m$) are needed and whether they make sense. The basic idea of construction is that the phase transition changing \hbar does not involve any other modifications except fractionization of angular momentum eigenvalues and momentum eigenvalues having purely geometric origin. One can however ask whether it is possible to identify q-plane waves as ordinary plane waves. Using the definition $L_z = 1/2(\partial_u^q + \partial_{\bar{u}}^q)$, $u = \exp(i\phi)$, one obtains $f_n = \exp(in\phi)$ and eigenvalues as $n^a) = R_n/R_1 \rightarrow n$ for $m \rightarrow \infty$. Similar construction applies in the case of momentum components.

2.5.7 Free energy from atomic hydrogen

The anomalies reported by free energy researchers such as over unity energy production in devices involving repeated formation and dissociation of H_2 molecules based on the original discovery of Nobelist Irwing Langmuir [81] (see for instance [80]) suggest that part of H atoms might end up to dark matter phase liberating energy.

An especially interesting device tested and described in detail by Naudin [80] is MAHG (Möller's Atomic Hydrogen Generator). The system behaves as an over-unity device producing energy from atomic hydrogen by a repeated dissociation and recombination of hydrogen atoms. MAHG tube contains a vacuum tube filled with hydrogen at 0.1 atm and cooled by water. The main part of the MAHG is a tungsten filament (0.25 mm diameter) placed in the center. Dissociation requires a heating of the tungsten filament to a temperature of about 2000 K.

A possible explanation of over-unity effect is inspired by the model of water as a partially dark matter in which one fourth of hydrogen atoms are in a dark phase forming linear super-nuclei with the distance between protons connected by color bonds being few Angstroms [F9]. The over-unity energy production could be due to a gradual transformation of hydrogen to dark hydrogen in the same state as in water. This transformation would compete with recombination and be responsible for the over unity energy production even if the liberated energy is smaller than in recombination since the resulting dark hydrogen would not dissociate anymore. The process could not continue indefinitely since the amount of ordinary hydrogen would be gradually reduced.

Also the dropping of some hydrogen atoms to larger space-time sheets accompanied by liberation of zero point kinetic energy of order .5 eV could be involved and have similar implications since the heating (thermal energy is about .2 eV) is not quite enough to kick all dropped protons back to the atomic space-time sheets.

2.6 Appendix: A generalization of the notion of imbedding space inspired by hierarchy of Planck constants

The hypothesis that Planck constant is quantized having in principle all possible rational values but with some preferred values implying algebraically simple quantum phases has been one of the main ideas of TGD during last years. The mathematical realization of this idea leads to a profound generalization of the notion of imbedding space obtained by gluing together infinite number of copies of imbedding space along common 4-dimensional intersection. The hope was that this generalization could explain charge fractionization but this does not seem to be the case. This problem led to a further generalization of the imbedding space and this is what I want to discussed below.

2.6.1 The original view about generalized imbedding space

The original generalization of imbedding space was basically following. Take imbedding space $H = M^4 \times CP_2$. Choose submanifold $M^2 \times S^2$, where S^2 is homologically non-trivial geodesic sub-manifold

of CP_2 . The motivation is that for a given choice of Cartan algebra of Poincare algebra (translations in time direction and spin quantization axis plus rotations in plane orthogonal to this plane plus color hypercharge and isospin) this sub-manifold remains invariant under the transformations leaving the quantization axes invariant.

Form spaces $\hat{M}^4 = M^4 \setminus M^2$ and $\hat{CP}_2 = CP_2 \setminus S^2$ and their Cartesian product. Both spaces have a hole of co-dimension 2 so that the first homotopy group is Z . From these spaces one can construct an infinite hierarchy of factor spaces \hat{M}^4/G_a and \hat{CP}_2/G_b , where G_a is a discrete group of $SU(2)$ leaving quantization axis invariant. In case of Minkowski factor this means that the group in question acts essentially as a combination reflection and to rotations around quantization axes of angular momentum. The generalized imbedding space is obtained by gluing all these spaces together along $M^2 \times S^2$.

The hypothesis is that Planck constant is given by the ratio $\hbar/\hbar_0 = (n_a/n_b)$, where n_i is the order of maximal cyclic subgroups of G_i . The hypothesis states also that the covariant metric of the Minkowski factor is scaled by the factor $(n_a/n_b)^2$. One must take care of this in the gluing procedure. One can assign to the field bodies describing both self interactions and interactions between physical systems definite sector of generalized imbedding space characterized partially by the Planck constant. The phase transitions changing Planck constant correspond to tunnelling between different sectors of the imbedding space.

2.6.2 Fractionization of quantum numbers is not possible if only factor spaces are allowed

The original idea was that the proposed modification of the imbedding space could explain naturally phenomena like quantum Hall effect involving fractionization of quantum numbers like spin and charge. This does not however seem to be the case. $G_a \times G_b$ implies just the opposite if these quantum numbers are assigned with the symmetries of the imbedding space. For instance, quantization unit for orbital angular momentum becomes n_a where Z_{n_a} is the maximal cyclic subgroup of G_a .

One can however imagine of obtaining fractionization at the level of imbedding space for space-time sheets, which are analogous to multi-sheeted Riemann surfaces (say Riemann surfaces associated with $z^{1/n}$ since the rotation by 2π understood as a homotopy of M^4 lifted to the space-time sheet is a non-closed curve. Continuity requirement indeed allows fractionization of the orbital quantum numbers and color in this kind of situation.

2.6.3 Both covering spaces and factor spaces are possible

The observation above stimulates the question whether it might be possible in some sense to replace H or its factors by their multiple coverings.

1. This is certainly not possible for M^4 , CP_2 , or H since their fundamental groups are trivial. On the other hand, the fixing of quantization axes implies a selection of the sub-space $H_4 = M^2 \times S^2 \subset M^4 \times CP_2$, where S^2 is a geodesic sphere of CP_2 . $\hat{M}^4 = M^4 \setminus M^2$ and $\hat{CP}_2 = CP_2 \setminus S^2$ have fundamental group Z since the codimension of the excluded sub-manifold is equal to two and homotopically the situation is like that for a punctured plane. The exclusion of these sub-manifolds defined by the choice of quantization axes could naturally give rise to the desired situation.
2. H_4 represents a straight cosmic string. Quantum field theory phase corresponds to Jones inclusions with Jones index $\mathcal{M} : \mathcal{N} < 4$. Stringy phase would by previous arguments correspond to $\mathcal{M} : \mathcal{N} = 4$. Also these Jones inclusions are labelled by finite subgroups of $SO(3)$ and thus by Z_n identified as a maximal Abelian subgroup.

One can argue that cosmic strings are not allowed in QFT phase. This would encourage the replacement $\hat{M}^4 \times \hat{CP}_2$ implying that surfaces in $M^4 \times S^2$ and $M^2 \times CP_2$ are not allowed. In particular, cosmic strings and CP_2 type extremals with M^4 projection in M^2 and thus light-like geodesic without zitterbewegung essential for massivation are forbidden. This brings in mind instability of Higgs=0 phase.

3. The covering spaces in question would correspond to the Cartesian products $\hat{M}^4_{n_a} \times \hat{CP}_2_{n_b}$ of the covering spaces of \hat{M}^4 and \hat{CP}_2 by Z_{n_a} and Z_{n_b} with fundamental group is $Z_{n_a} \times$

Z_{n_b} . One can also consider extension by replacing M^2 and S^2 with its orbit under G_a (say tetrahedral, octahedral, or icosahedral group). The resulting space will be denoted by $\hat{M}^4 \hat{\times} G_a$ resp. $\hat{C}P_2 \hat{\times} G_b$.

4. One expects the discrete subgroups of $SU(2)$ emerge naturally in this framework if one allows the action of these groups on the singular sub-manifolds M^2 or S^2 . This would replace the singular manifold with a set of its rotated copies in the case that the subgroups have genuinely 3-dimensional action (the subgroups which corresponds to exceptional groups in the ADE correspondence). For instance, in the case of M^2 the quantization axes for angular momentum would be replaced by the set of quantization axes going through the vertices of tetrahedron, octahedron, or icosahedron. This would bring non-commutative homotopy groups into the picture in a natural manner.

Also the orbifolds $\hat{M}^4/G_a \times \hat{C}P_2/G_b$ can be allowed as also the spaces $\hat{M}^4/G_a \times (\hat{C}P_2 \hat{\times} G_b)$ and $(\hat{M}^4 \hat{\times} G_a) \times \hat{C}P_2/G_b$. Hence the previous framework would generalize considerably by the allowance of both coset spaces and covering spaces.

2.6.4 Do factor spaces and coverings correspond to the two kinds of Jones inclusions?

What could be the interpretation of these two kinds of spaces?

1. Jones inclusions appear in two varieties corresponding to $\mathcal{M} : \mathcal{N} < 4$ and $\mathcal{M} : \mathcal{N} = 4$ and one can assign a hierarchy of subgroups of $SU(2)$ with both of them. In particular, their maximal Abelian subgroups Z_n label these inclusions. The interpretation of Z_n as invariance group is natural for $\mathcal{M} : \mathcal{N} < 4$ and it naturally corresponds to the coset spaces. For $\mathcal{M} : \mathcal{N} = 4$ the interpretation of Z_n has remained open. Obviously the interpretation of Z_n as the homology group defining covering would be natural.
2. $\mathcal{M} : \mathcal{N} = 4$ should correspond to the allowance of cosmic strings and other analogous objects. Does the introduction of the covering spaces bring in cosmic strings in some controlled manner? Formally the subgroup of $SU(2)$ defining the inclusion is $SU(2)$ would mean that states are $SU(2)$ singlets which is something non-physical. For covering spaces one would however obtain the degrees of freedom associated with the discrete fiber and the degrees of freedom in question would not disappear completely and would be characterized by the discrete subgroup of $SU(2)$.

For anyons the non-trivial homotopy of plane brings in non-trivial connection with a flat curvature and the non-trivial dynamics of topological QFTs. Also now one might expect similar non-trivial contribution to appear in the spinor connection of $\hat{M}^2 \hat{\times} G_a$ and $\hat{C}P_2 \hat{\times} G_b$. In conformal field theory models non-trivial monodromy would correspond to the presence of punctures in plane.

3. For factor spaces the unit for quantum numbers like orbital angular momentum is multiplied by n_a resp. n_b and for coverings it is divided by this number. These two kind of spaces are in a well defined sense obtained by multiplying and dividing the factors of \hat{H} by G_a resp. G_b and multiplication and division are expected to relate to Jones inclusions with $\mathcal{M} : \mathcal{N} < 4$ and $\mathcal{M} : \mathcal{N} = 4$, which both are labelled by a subset of discrete subgroups of $SU(2)$.
4. The discrete subgroups of $SU(2)$ with fixed quantization axes possess a well defined multiplication with product defined as the group generated by forming all possible products of group elements as elements of $SU(2)$. This product is commutative and all elements are idempotent and thus analogous to projectors. Trivial group G_1 , two-element group G_2 consisting of reflection and identity, the cyclic groups Z_p , p prime, and tetrahedral, octahedral, and icosahedral groups are the generators of this algebra.

By commutativity one can regard this algebra as an 11-dimensional module having natural numbers as coefficients ("rig"). The trivial group G_1 , two-element group G_2 generated by reflection, and tetrahedral, octahedral, and icosahedral groups define 5 generating elements for this algebra. The products of groups other than trivial group define 10 units for this algebra so that there are 11 units altogether. The groups Z_p generate a structure analogous to natural numbers acting as

analog of coefficients of this structure. Clearly, one has effectively 11-dimensional commutative algebra in 1-1 correspondence with the 11-dimensional "half-lattice" N^{11} (N denotes natural numbers). Leaving away reflections, one obtains N^7 . The projector representation suggests a connection with Jones inclusions. An interesting question concerns the possible Jones inclusions assignable to the subgroups containing infinitely many elements. Reader has of course already asked whether dimensions 11, 7 and their difference 4 might relate somehow to the mathematical structures of M-theory with 7 compactified dimensions.

5. How do the Planck constants associated with factors and coverings relate? One might argue that Planck constant defines a homomorphism respecting the multiplication and division (when possible) by G_i . If so, then Planck constant in units of \hbar_0 would be equal to n_a/n_b for $\hat{H}/G_a \times G_b$ option and n_b/n_a for $\hat{H} \hat{t}imes(G_a \times G_b)$ with obvious formulas for hybrid cases. This option would put M^4 and CP_2 in a very symmetric role and allow much more flexibility in the identification of symmetries associated with large Planck constant phases.

2.6.5 Fractional Quantum Hall effect

The generalization of the imbedding space allows to understand fractional quantum Hall effect [49]. The formula for the quantized Hall conductance is given by

$$\begin{aligned} \sigma &= \nu \times \frac{e^2}{h} , \\ \nu &= \frac{n}{m} . \end{aligned} \tag{2.6.1}$$

Series of fractions in $\nu = 1/3, 2/5, 3/7, 4/9, 5/11, 6/13, 7/15, \dots, 2/3, 3/5, 4/7, 5/9, 6/11, 7/13, \dots, 5/3, 8/5, 11/7, 14/9, \dots, 1/5, 2/9, 3/13, \dots, 2/7, 3/11, \dots, 1/7, \dots$ with odd denominator have been observed as are also $\nu = 1/2$ and $\nu = 5/2$ states with even denominator [49].

The model of Laughlin [47, 48] cannot explain all aspects of FQHE. The best existing model proposed originally by Jain is based on composite fermions resulting as bound states of electron and even number of magnetic flux quanta [50]. Electrons remain integer charged but due to the effective magnetic field electrons appear to have fractional charges. Composite fermion picture predicts all the observed fractions and also their relative intensities and the order in which they appear as the quality of sample improves.

In [E9] I have proposed a possible TGD based model of FQHE not involving hierarchy of Planck constants. The generalization of the notion of imbedding space suggests also the possibility to interpret these states in terms of fractionized charge and electron number.

1. The easiest manner to understand the observed fractions is by assuming that both M^4 and CP_2 correspond to covering spaces so that both spin and electric charge and fermion number are quantized. With this assumption the expression for the Planck constant becomes $\hbar/\hbar_0 = n_b/n_a$ and charge and spin units are equal to $1/n_b$ and $1/n_a$ respectively. This gives $\nu = nn_a/n_b^2$. The values $m = 2, 3, 5, 7, \dots$ are observed. Planck constant can have arbitrarily large values. There are general arguments stating that also spin is fractionized in FQHE and for $n_a = kn_b$ required by the observed values of ν charge fractionization occurs in units of k/n_b and forces also spin fractionization. For factor space option in M^4 degrees of freedom one would have $\nu = n/n_a n_b^2$.
2. The appearance of $n_b = 2$ would suggest that also Z_2 appears as the homotopy group of the covering space: filling fraction $1/2$ corresponds in the composite fermion model and also experimentally to the limit of zero magnetic field [50]. Also $\nu = 5/2$ has been observed [51].
3. A possible problematic aspect of the TGD based model is the experimental absence of even values of n_b except $n_b = 2$. A possible explanation is that by some symmetry condition possibly related to fermionic statistics kn/n_b must reduce to a rational with an odd denominator for $n_b > 2$. In other words, one has $k \propto 2^r$, where 2^r the largest power of 2 divisor of n_b smaller than n_b .

4. Large values of n_b emerge as B increases. This can be understood from flux quantization. One has $eBS = n\hbar = n(n_b/n_a)\hbar_0$. The interpretation is that each of the n_b sheets contributes n/n_a units to the flux. As B increases also the flux increases for a fixed value of n_a and area S . Note that the value of magnetic field in given sheet is not affected so that the build-up of multiple covering seems to keep magnetic field strength below critical value. For $n_a = kn_b$ one obtains $eBS/\hbar_0 = n/k$ so that a fractionization of magnetic flux results and each sheet contributes $1/kn_b$ units to the flux. $\nu = 1/2$ corresponds to $k = 1, n_b = 2$ and to non-vanishing magnetic flux unlike in the case of composite fermion model.
5. The understanding of the thermal stability is not trivial. The original FQHE was observed in 80 mK temperature corresponding roughly to a thermal energy of $T \sim 10^{-5}$ eV. For graphene the effect is observed at room temperature. Cyclotron energy for electron is (from $f_e = 6 \times 10^5$ Hz at $B = .2$ Gauss) of order thermal energy at room temperature in a magnetic field varying in the range 1-10 Tesla. This raises the question why the original FQHE requires so low temperature. The magnetic energy of a flux tube of length L is by flux quantization roughly $e^2B^2S \sim E_c(e)m_eL$ ($\hbar_0 = c = 1$) and exceeds cyclotron roughly by a factor L/L_e , L_e electron Compton length so that thermal stability of magnetic flux quanta is not the explanation. A possible explanation is that since FQHE involves several values of Planck constant, it is quantum critical phenomenon and is characterized by a critical temperature. The differences of the energies associated with the phase with ordinary Planck constant and phases with different Planck constant would characterize the transition temperature.

Bibliography

Online books about TGD

- [1] M. Pitkänen (2006), *Topological Geometroynamics: Overview*.
http://tgd.wippiespace.com/public_html/tgdview/tgdview.html.
- [2] M. Pitkänen (2006), *Quantum Physics as Infinite-Dimensional Geometry*.
http://tgd.wippiespace.com/public_html/tgdgeom/tgdgeom.html.
- [3] M. Pitkänen (2006), *Physics in Many-Sheeted Space-Time*.
http://tgd.wippiespace.com/public_html/tgdclass/tgdclass.html.
- [4] M. Pitkänen (2006), *Quantum TGD*.
http://tgd.wippiespace.com/public_html/tgdquant/tgdquant.html.
- [5] M. Pitkänen (2006), *TGD as a Generalized Number Theory*.
http://tgd.wippiespace.com/public_html/tgdnumber/tgdnumber.html.
- [6] M. Pitkänen (2006), *p-Adic length Scale Hypothesis and Dark Matter Hierarchy*.
http://tgd.wippiespace.com/public_html/paddark/paddark.html.
- [7] M. Pitkänen (2006), *TGD and Fringe Physics*.
http://tgd.wippiespace.com/public_html/freenergy/freenergy.html.

Online books about TGD inspired theory of consciousness and quantum biology

- [8] M. Pitkänen (2006), *Bio-Systems as Self-Organizing Quantum Systems*.
http://tgd.wippiespace.com/public_html/bioselforg/bioselforg.html.
- [9] M. Pitkänen (2006), *Quantum Hardware of Living Matter*.
http://tgd.wippiespace.com/public_html/bioware/bioware.html.
- [10] M. Pitkänen (2006), *TGD Inspired Theory of Consciousness*.
http://tgd.wippiespace.com/public_html/tgdconsc/tgdconsc.html.
- [11] M. Pitkänen (2006), *Mathematical Aspects of Consciousness Theory*.
http://tgd.wippiespace.com/public_html/genememe/genememe.html.
- [12] M. Pitkänen (2006), *TGD and EEG*.
http://tgd.wippiespace.com/public_html/tgdeeg/tgdeeg/tgdeeg.html.
- [13] M. Pitkänen (2006), *Bio-Systems as Conscious Holograms*.
http://tgd.wippiespace.com/public_html/hologram/hologram.html.
- [14] M. Pitkänen (2006), *Magnetospheric Consciousness*.
http://tgd.wippiespace.com/public_html/magnconsc/magnconsc.html.
- [15] M. Pitkänen (2006), *Mathematical Aspects of Consciousness Theory*.
http://tgd.wippiespace.com/public_html/magnconsc/mathconsc.html.

References to the chapters of books

- [A1] The chapter *An Overview about the Evolution of Quantum TGD* of [TGDview].
http://tgd.wippiespace.com/public_html/tgdview/tgdview.html#evoI.
- [A2] The chapter *An Overview about Quantum TGD* of [TGDview].
http://tgd.wippiespace.com/public_html/tgdview/tgdview.html#evoII.
- [A8] The chapter *Was von Neumann Right After All* of [TGDquant].
http://tgd.wippiespace.com/public_html/tgdview/tgdview.html#vNeumann.
- [A9] The chapter *Does TGD Predict the Spectrum of Planck Constants?* of [TGDview].
http://tgd.wippiespace.com/public_html/tgdview/tgdview.html#Planck.
- [B4] The chapter *Configuration Space Spinor Structure* of [TGDgeom].
http://tgd.wippiespace.com/public_html/tgdgeom/tgdgeom.html#cspin.
- [C1] The chapter *Construction of Quantum Theory: Symmetries* of [TGDquant].
http://tgd.wippiespace.com/public_html/tgdquant/tgdquant.html#quthe.
- [C2] The chapter *Construction of Quantum Theory: S-matrix* of [TGDquant].
http://tgd.wippiespace.com/public_html/tgdquant/tgdquant.html#towards.
- [D4] The chapter *The Relationship Between TGD and GRT* of [TGDclass].
http://tgd.wippiespace.com/public_html/tgdclass/tgdclass.html#tgdgrt.
- [D5] The chapter *Cosmic Strings* of [TGDclass].
http://tgd.wippiespace.com/public_html/tgdclass/tgdclass.html#cstrings.
- [D6] The chapter *TGD and Cosmology* of [TGDclass].
http://tgd.wippiespace.com/public_html/tgdclass/tgdclass.html#cosmo.
- [D7] The chapter *TGD and Astrophysics* of [TGDclass].
http://tgd.wippiespace.com/public_html/tgdclass/tgdclass.html#astro.
- [D8] The chapter *Quantum Astrophysics* of [TGDclass].
http://tgd.wippiespace.com/public_html/tgdclass/tgdclass.html#qastro.
- [E1] The chapter *TGD as a Generalized Number Theory: p-Adicization Program* of [TGDnumber].
http://tgd.wippiespace.com/public_html/tgdnumber/tgdnumber.html#visiona.
- [F1] The chapter *Elementary Particle Vacuum Functionals* of [TGDpad].
http://tgd.wippiespace.com/public_html/paddark/paddark.html#elvafu.
- [F2] The chapter *Massless States and Particle Massivation* of [TGDpad].
http://tgd.wippiespace.com/public_html/paddark/paddark.html#mless.
- [F3] The chapter *p-Adic Particle Massivation: Elementary particle Masses* of [TGDpad].
http://tgd.wippiespace.com/public_html/paddark/paddark.html#padmass2.
- [F4] The chapter *p-Adic Particle Massivation: Hadron Masses* of [TGDpad].
http://tgd.wippiespace.com/public_html/paddark/paddark.html#padmass3.
- [F5] The chapter *p-Adic Particle Massivation: New Physics* of [TGDpad].
http://tgd.wippiespace.com/public_html/paddark/paddark.html#padmass4.
- [F8] The chapter *TGD and Nuclear Physics* of [TGDpad].
http://tgd.wippiespace.com/public_html/paddark/paddark.html#padnucl.
- [F9] The chapter *Nuclear String Physics* of [TGDpad].
http://tgd.wippiespace.com/public_html/paddark/paddark.html#nuclstring.
- [F10] The chapter *Dark Nuclear Physics and Condensed Matter* of [TGDpad].
http://tgd.wippiespace.com/public_html/paddark/paddark.html#exonuclear.

- [G1] The chapter *About Strange Effects Related to Rotating Magnetic Systems* of [TGDfree].
http://tgd.wippiespace.com/public_html/freenergy/freenergy.html#Faraday.
- [G2] The chapter *The Notion of Free Energy and Many-Sheeted Space-Time Concept* of [TGDfree].
http://tgd.wippiespace.com/public_html/freenergy/freenergy.html#freenergy.
- [G4] The chapter *Did Tesla Discover the Mechanism Changing the Arrow of Time?* of [TGDfree].
http://tgd.wippiespace.com/public_html/freenergy/freenergy.html#tesla.
- [H1] The chapter *Matter, Mind, Quantum* of [TGDconsc].
http://tgd.wippiespace.com/public_html/tgdconsc/tgdconsc.html#conscic.
- [H2] The chapter *Negentropy Maximization Principle* of [TGDconsc].
http://tgd.wippiespace.com/public_html/tgdconsc/tgdconsc.html#nmpc.
- [H5] The chapter *New Developments in TGD and Their Implications for TGD Inspired Theory of Consciousness*
http://tgd.wippiespace.com/public_html/tgdconsc/tgdconsc.html#conscupdate.
- [H6] The chapter *Quantum Model of Memory* of [TGDconsc].
http://tgd.wippiespace.com/public_html/tgdconsc/tgdconsc.html#memoryc.
- [H8] The chapter *p-Adic Physics as Physics of Cognition and Intention* of [TGDconsc].
http://tgd.wippiespace.com/public_html/tgdconsc/tgdconsc.html#cognic.
- [H9] The chapter *Quantum Model for Paranormal Phenomena*
of [TGDconsc].
http://tgd.wippiespace.com/public_html/tgdconsc/tgdconsc.html#parac.
- [H10] The chapter *TGD Based Model for OBEs* of [TGDconsc].
http://tgd.wippiespace.com/public_html/tgdconsc/tgdconsc.html#OBE.
- [J1] The chapter *Bio-Systems as Super-Conductors: part I* of [TGDware].
http://tgd.wippiespace.com/public_html/bioware/bioware.html#superc1.
- [J2] The chapter *Bio-Systems as Super-Conductors: part II* of [TGDware].
http://tgd.wippiespace.com/public_html/bioware/bioware.html#superc2.
- [J3] The chapter *Bio-Systems as Super-Conductors: part III* of [TGDware].
http://tgd.wippiespace.com/public_html/bioware/bioware.html#superc3.
- [J7] The chapter *About the New Physics Behind Qualia* of [TGDware].
http://tgd.wippiespace.com/public_html/bioware/bioware.html#newphys.
- [K1] The chapter *Time, Spacetime and Consciousness* of [TGDholo].
http://tgd.wippiespace.com/public_html/hologram/hologram.html#time.
- [K5] The chapter *Homeopathy in Many-Sheeted Space-Time* of [TGDholo].
http://tgd.wippiespace.com/public_html/hologram/hologram.html#homeoc.
- [K6] The chapter *Macroscopic Quantum Coherence and Quantum Metabolism as Different Sides of the Same Coin* of [TGDholo].
http://tgd.wippiespace.com/public_html/hologram/hologram.html#metab.
- [L1] The chapter *Genes and Memes* of [TGDgeme].
http://tgd.wippiespace.com/public_html/genememe/genememe.html#genememec.
- [M1] The chapter *Magnetic Sensory Canvas Hypothesis* of [TGDeeg].
http://tgd.wippiespace.com/public_html/tgdeeg/tgdeeg/tgdeeg.html#mec.
- [M3] The chapter *Dark Matter Hierarchy and Hierarchy of EEGs* of [TGDeeg].
http://tgd.wippiespace.com/public_html/tgdeeg/tgdeeg/tgdeeg.html#eegdark.

- [M4] The chapter *Quantum Model for EEG: Part I* of [TGDeeg].
http://tgd.wippiespace.com/public_html/tgdeeg/tgdeeg/tgdeeg.html#eegI.
- [N1] The chapter *Magnetospheric Sensory Representations* of [TGDmagn].
http://tgd.wippiespace.com/public_html/magnconsc/magnconsc.html#srepres.
- [N4] The chapter *Pre-Biotic Evolution in Many-Sheeted Space-Time* of [TGDmagn].
http://tgd.wippiespace.com/public_html/magnconsc/magnconsc.html#prebio.
- [O3] The chapter *Topological Quantum Computation in TGD Universe* of [15].
http://tgd.wippiespace.com/public_html/mathconsc/mathconsc.html#tqc.

Mathematics related references

- [16] E. C. Zeeman (ed.)(1977), *Catastrophe Theory*, Addison-Wessley Publishing Company.
- [17] D. S. Moak (1981), *The q-analogue of the Laguerre polynomials*, J. Math. Anal. Appl. 81 20 - 47.

Brain science

- [18] Blackman, C. F., Benane, S. G., Kinney, L. S., House, D. E., and Joines, W. T., (1982), "Effects of ELF fields on calcium-ion efflux from brain tissue, in vitro", Radiat. Res. 92:510-520.
- [19] B. Libet, E. W. Wright Jr., B. Feinstein, and D. K. Pearl (1979), "Subjective referral of the timing for a conscious sensory experience", Brain, 102, 193-224.
- [20] Libet, B., Gleason, C.A., Wright, E.W., Pearl, D.K. (1983). Time of conscious intention to act in relation to onset of cerebral activity (readiness-potential). The unconscious initiation of a freely voluntary act. Brain. 106 (3):623642.
- [21] P. L. Nunez (2000), *Toward a Quantitative Description of Large Scale Neocortical Dynamic Function and EEG*, Behavioral and Brain Sciences, 23, (3): XX. <http://www.bbsonline.org/documents/a/00/00/05/08/>.
- [22] http://en.wikipedia.org/wiki/Michael_Persinger.

Biology

- [23] *Nannobacteria*, <http://en.wikipedia.org/wiki/Nannobacteria>.
- [24] G. Pollack (2000), *Cells, Gels and the Engines of Life*, Ebner and Sons.
<http://www.cellsandgels.com/> .
- [25] P. P. Gariaev *et al*(2002), *The spectroscopy of bio-photons in non-local genetic regulation*, Journal of Non-Locality and Remote Mental Interactions, Vol 1, Nr 3.
<http://www.emergentmind.org/gariaevI3.htm>.
- [26] L. Fantappie (1942), *Teoria Unitaria del Mondo Fisico e Biologico*, Di Renzo Editore, Roma, 1991.
- [27] A. Vannini(2007), *Advanced Waves, Retrocausality, and Consciousness* in *The 7th European SSE Meeting August 17-19, 2007, Rörös, Norway. Proceedings*. <http://www.scientificexploration.org/>.
- [28] U. Di Corpo (2007), *The conflict between entropy and syntropy: the vital needs model* in *The 7th European SSE Meeting August 17-19, 2007, Rörös, Norway. Proceedings*. <http://www.scientificexploration.org/>.

- [29] *Photosynthesis*, <http://en.wikipedia.org/wiki/Photosynthesis>.
- [30] *Photolysis*, <http://en.wikipedia.org/wiki/Photolysis>.
- [31] *Photocatalysis*, <http://en.wikipedia.org/wiki/Photocatalysis>.

Astrophysics

- [32] *Plasma sheet and PSBL*,
http://www oulu.fi/~spaceweb/textbook/plasma_sheet.html.
- [33] *Interstellar Dust as Agent and Subject of Galactic Evolution*,
http://www.ricercaitaliana.it/prin/dettaglio_completo_prin_en-2005022470.htm.
- [34] *Diffuse interstellar bands*,
http://en.wikipedia.org/wiki/Diffuse_interstellar_band.
- [35] Uma P. Vijh (2004), *Extended Red Emission*, http://ardbeg.astro.utoledo.edu/~karen/baglunch/vijh_abl_spr04.pdf.
- [36] *From the stars to the thought*,
<http://www.brunonic.org/Nicolaus/fromthearstot.htm>.
- [37] L. J. Allamandola, M. P. Bernstein, S.A. Sandford (1997), in *Astronomical and biochemical origins and the search for life in the universe*, Ed. CB Cosmovici, S. Bowyer, D. Wertheimer, pp. 23-47, Editrice Compositori, Bologna.
- [38] P. Carlquist, G. F. Gahm, and H. Kristen (2003), *Theory of twisted trunks*,
<http://www.aanda.org/articles/aa/abs/2003/20/aa3289/aa3289.html>.
- [39] http://en.wikipedia.org/wiki/Diffuse_interstellar_band and <http://www.brunonic.org/Nicolaus/fromthearstot.htm>.
- [40] http://en.wikipedia.org/wiki/Dark_matter.
- [41] http://en.wikipedia.org/wiki/Cosmological_constant.
- [42] <http://en.wikipedia.org/wiki/Nottale>.
- [43] <http://en.wikipedia.org/wiki/Saturn>.
- [44] http://en.wikipedia.org/wiki/Rings_of_Saturn.
- [45] *Exoplanets*, <http://en.wikipedia.org/wiki/Exoplanets>.
- [46] *Mars*, <http://en.wikipedia.org/wiki/ALH84001>.
- [47] F. Wilzek (1990), *Fractional Statistics and Anyon Super-Conductivity*, World Scientific.
R. B. Laughlin (1990), Phys. Rev. Lett. 50, 1395.
- [48] R. B. Laughlin (1983), Phys. Rev. Lett. 50, 1395.
- [49] *Fractional quantum Hall Effect*, http://en.wikipedia.org/wiki/Fractional_quantum_Hall_effect.
Fractional Quantum Hall Effect, <http://www.warwick.ac.uk/~phsbm/fqhe.htm>.
- [50] J.K. Jain(1989), Phys. Rev. Lett. 63, 199.
- [51] J. B. Miller *et al*(2007), *Fractional Quantum Hall effect in a quantum point contact at filling fraction 5/2*, arXiv:cond-mat/0703161v2.
- [52] C. Charbonnel and F. Primas (2005), *The lithium content of the Galactic Halo stars*,
astro-ph/0505247.
http://www.arxiv.org/PS_cache/astro-ph/pdf/0505/0505247v2.pdf.

Anomalies

- [53] M. Chaplin (2005), *Water Structure and Behavior*,
<http://www.lsbu.ac.uk/water/index.html>.
 For 41 anomalies see <http://www.lsbu.ac.uk/water/anmlies.html>.
 For the icosahedral clustering see <http://www.lsbu.ac.uk/water/clusters.html>.
- [54] J. K. Borchardt(2003), *The chemical formula H₂O - a misnomer*, The Alchemist 8 Aug (2003).
- [55] R. A. Cowley (2004), *Neutron-scattering experiments and quantum entanglement*, Physica B 350 (2004) 243-245.
- [56] R. Moreh, R. C. Block, Y. Danon, and M. Neumann (2005), *Search for anomalous scattering of keV neutrons from H₂O-D₂O mixtures*, Phys. Rev. Lett. 94, 185301.
- [57] E. Lozneau and M. Sanduloviciu (2003), "Minimal-cell system created in laboratory by self-organization", Chaos, Solitons & Fractals, Volume 18, Issue 2, October, p. 335. See also "Plasma blobs hint at new form of life", New Scientist vol. 179 issue 2413 - 20 September 2003, page 16.
- [58] *Hydrogen bonds*, http://en.wikipedia.org/wiki/Hydrogen_bond.
- [59] R. Matthews (1997), *Wacky Water*, New Scientist 154 (2087):4043, 21 June.
- [60] J-C. Li and D.K. Ross (1993), *Evidence of Two Kinds of Hydrogen Bonds in Ices*. J-C. Li and D.K. Ross, Nature, 365, 327-329.
- [61] B. Tsytoovich *et al* (2007), *From Plasma crystals and helical structures towards inorganic living matter*, New Journal of Physics, August issue.
<http://www.iop.org/EJ/abstract/1367-2630/9/8/263>.
- [62] <http://www.timesonline.co.uk/tol/news/uk/article2241753.ece>.
- [63] Björn Gitle-Hauge (2007), *Optical spectrum analysis of the Hessdalen phenomenon* in "The 7th European SSE Meeting, August 17-19, 2007, Røros, Norway. Proceedings".
- [64] "The Toppenish Field Study. A Technical Review and Update". The 7:th European SSE Meeting August 17-19, 2007, Rros, Norway.
- [65] M. Pitkänen (2007), *TGD based solution of Fermi paradox*,
<http://www.physics.helsinki.fi/~matpitka/articles/fermieng.pdf>.
- [66] S. E. Shnoll et al (1998), *Realization of discrete states during fluctuations in macroscopic processes*, Uspekhi Fisicheskikh Nauk, Vol. 41, No. 10, pp. 1025-1035.
- [67] *Allais effect*, http://en.wikipedia.org/wiki/Allais_effect.
- [68] <http://www.youtube.com/watch?v=h6vSxR6UKFM>.
- [69] N. Tesla(1894), *Coil for Electromagnets*, US Patent No. 512,340. The patent of the bi-filar coil can be found at <http://www.tfcbooks.com/patents/coil.htm>.
 A brief summary of Tesla's vision can be found at <http://solair.eunet.yu/~velimir/works/teslaint.htm>.
- [70] E. Podkletnov and R. Nieminen (1992), Physica C 203 441. E. Podkletnov, "Weak gravitational shielding properties of composite bulk YBa₂Cu₃O_{7-x} super-conductor below 70 K under electromagnetic field", report MSU-chem 95, improved version (cond-mat/9701074).
- [71] J. Schnurer (1999) *Demonstration of transient weak gravitational shielding by a YBCO LEVHEX at the super-conducting transition*.
<http://www.gravity.org/exp.htm>.
- [72] G. Modanese (1996), *On the theoretical interpration of E. Podkletnov's experiment*, <http://www.gravity.org/ont.html> .

- [73] E. Podkletnov and G. Modanese (2002), *Investigation of high voltage discharges in low pressure gases through large ceramic super-conducting electrodes*,
<http://xxx.lanl.gov/abs/physics/0209051>.
- [74] Marc Bean , *Thomas Townsend Brown*,
<http://www.virtualtheater.com/ttbrown-01.html>.
- [75] Gaston Burrige (1994), *Townsend Brown and his antigravity discs*.
<http://www.spiritweb.com/Spirit/anti-gravity.html>.
- [76] Mason Rose (1952) , "*The Flying Saucer*". *The Application of the Biefield-Brown Effect to the Solution of the Problems of Space Navigation*. Published in Science and Invention, August 1929.
<http://www.soteria.com/brown/docs/rose.htm>.
- [77] T. B. Bahler and G. Fazi (2002) *Force on an Asymmetric Capacitor*,
http://membres.lycos.fr/jlnlabs/ar1_fac/index.html.
- [78] The homepage of Juha Hartikka contains information about free energy devices and also reports about his own experiments with lifters.
<http://energy.innoplaza.net>.
- [79] J.-L. Naudin *The Quest for Over-Unity*. The page contains material about over-unity devices, in particular magnetic motors. <http://jnaudin.free.fr/>.
- [80] J. Naudin (2005), *Free Energy Atomic Hydrogen: the MAHG project*,
<http://jlnlabs.imars.com/mahg/tests/index.htm>.
- [81] I. Langmuir (1915), em *The Dissociation of Hydrogen Into Atoms*, *Journal of American Chemical Society* 37, 417.
- [82] P. Kanarev (2002) *Water is New Source of Energy*, Krasnodar.
- [83] *Cold fusion by plasma electrolysis of water*, Ph. M., Kanarev and T. Mizuno (2002),
<http://www.guns.connect.fi/innoplaza/energy/story/Kanarev/codlfusion/>.
- [84] S. Meyer (1996) *Water Fuel Cell*, International News Release, Issue No. 11A-Rv.
S. Meyer (1990) *Method for Production of A Fuel Gas*, US Patent 4,936,961.
- [85] H. Puthoff (1987), *Ground State of Hydrogen as a Zero-Point Fuctuation Determined State*, *Phys. Rev. D* 35, 10.
- [86] R. Mills *et al*(2003), *Spectroscopic and NMR identification of novel hybrid ions in fractional quantum energy states formed by an exothermic reaction of atomic hydrogen with certain catalysts*.
<http://www.blacklightpower.com/techpapers.html> .
- [87] Roshchin, V.V and Godin, S.M., *An Experimental Investigation of the Physical Effects in a Dynamic Magnetic System*, *New Energy Technologies Issue #1 July-August 2001*.

Chapter 3

About Strange Effects Related to Rotating Magnetic Systems

3.1 Introduction

The basic hypothesis of Topological Geometrostatics (TGD) is that space-time is representable as a 4-surface in 8-dimensional space $M^4 \times CP_2$. The notion of many-sheeted space-time forced by this hypothesis implies numerous new physics effects.

The first prediction is the possibility of gravitational anomalies. For instance, the space-time sheet of system can feed the gravitational flux to several larger space-time sheets and when the distribution of the fluxes is non-standard, anomalous gravitational behavior results. Note that the change of gravitational mass alone without a change in the distribution of gravitational flux between different space-time sheets does not imply effects as long as the idealization as a test particle makes sense. The most recent view about coupling constant evolution [C4] however strongly suggests that gravitons correspond to the largest non-super-astrophysical Mersenne prime $M_{127} = 2^{127} - 1$ assignable also to electron. Therefore gravitational interactions would be mediated along these space-time sheets and the space-time sheets carrying gravitational fields would be universal and this kind of anomalies would not be possible.

TGD predicts also the possibility of negative energy space-time sheets having non-standard time orientation. The implications are numerous. Negative energy topological light rays are expected to be accompanied by negative energy photons identifiable as phase conjugate photons. The generalization of four-wave mechanism involving generalization of standing waves emerges and provides a mechanism of remote metabolism in which system sucks energy from environment by sending negative energy particles such as phase conjugate photons. The geometric time reversal of second law is a signature of the process and the decay of system looks like self-assembly from the point of view of observer with standard arrow of geometric time. Generalized four-wave mechanism provides also a model over unity energy production and classical communications to the geometric past. In TGD inspired theory of consciousness and bio-matter this mechanism is central and underlies the models of metabolism, intentional action, and long term memory.

The phase conjugate hypothesis generalizes to the case of fermions and leads to the hypothesis that fermions and anti-fermions have opposite sign of energy. This guarantees that fermionic vacuum energy which otherwise diverges is vanishing. This inspires the hypothesis that the total quantum numbers of the Universe vanish. The assumption is consistent with the crossing symmetry of elementary particle physics and makes sense macroscopically if gravitational energy is identified as the difference of inertial energies of positive and negative energy matter. Vacuum extremals can be interpreted as space-time surfaces with vanishing inertial energy but non-vanishing gravitational energy density given by Einstein's equations. The resulting cosmology is maximally predictive. Note that the generation of vacuum extremals in general increases the gravitational mass of the system and this effect could be taken as a signature of the effect. The instability of the vacuum extremals against generation of inertial mass by sending either positive or negative inertial energy to environment implies a change of inertial mass of associated system which could also serve as a signature of the effect.

The geometrization of the classical gauge fields in turn predicts the existence of long range color

and electro-weak gauge fields, in particular classical Z^0 field, which gives rise to macroscopic effects resembling those assigned usually with torsion fields. These fields are assignable to dark matter hierarchy rather than ordinary matter.

The prediction that the Planck constants associated with M^4 and CP_2 degrees freedom are quantized as integer multiples of the ordinary Planck constant in "anyonic" phases is a further prediction [A9]. The interpretation of dark matter as a hierarchy of macroscopic quantum phases of this kind is highly attractive.

In this chapter various anomalies claimed by free energy researchers are discussed in this conceptual framework.

3.1.1 Anomalies associated with rotating magnetic systems

In the beginning of the year 2002 I learned about strange effects related to rotating magnetic systems, and the model for these effects has evolved (and is still evolving) gradually during the year 2002 via trial and error process. Several new physics effects seem to be involved.

Loss of effective weight

If the rotating magnetic system involves dark matter component as suggested by the considerations of [F8] and [F9], develops em and Z^0 charges and experiences the classical em and Z^0 electric forces created by Earth so that the effective weight is reduced or increases (depending on the direction of rotation) as much as 35 per cent. The charging is due to the flow of electrons and possibly also exotic neutrinos from the rolling magnets to the surrounding air induced by the radial electric and Z^0 electric fields generated by the Faraday effect inducing vacuum charge density (not possible in Maxwell's electrodynamics). The fact that critical frequencies are different for clockwise and counter clockwise spontaneous rotation implies that classical Z^0 force and dark (possibly neutrino) currents must be present.

Spontaneous accelerating rotation

The first guess is that only the magnetic fields of rollers rotate and the spontaneous accelerating rotation above critical frequency could be understood as being due to a Lorentz torque acting on the radial Ohmic em and Z^0 currents in rollers and roller ring. This of course requires that this angular momentum is somehow transferred to the angular momentum of rollers.

Later it became clear that Lorentz torque might be only a control tool forcing electrons in rotating motion. If also the magnetic field of the stator rotate as one might expect if its return flux flows through the rollers, also the stator would contain a radial current and a flow equilibrium in which radial current flows from the stator to rollers could establish itself. It would induce opposite charges to the stator and rollers. Since electron charge distributions rotate and are not expected to possess a full rotational symmetry, an electrostatic torque is generated and vanishes if rollers rotate with the same velocity as electrons in the stator. This situation is still completely classical and requires an external force to compensate for the dissipative losses.

Above the critical frequency the torque, which is proportional to rotation frequency, becomes larger than frictional torque, and spontaneous accelerating rotation becomes possible due to the positive feedback.

The radial ohmic current of electrons leaking from the atomic space-time sheets of rollers to the space-time sheet of environment explains the presence of plasma around the system. The ionization of the molecules is caused by the electrons from rollers gaining keV energy as they drop from atomic space-time sheets of rollers to the space-time sheets of the environment. Energetic constraints imply negative feed back and the modelling of this "back reaction" leads to a model of the system based on butterfly catastrophe in Thom's classification of elementary catastrophes and allowing also to understand the effect of the load. Rather precise estimates for the parameters result and allow to quantify the role of classical Z^0 force.

The mechanism transforming the torque on conduction electrons of the radial ohmic current to the torque on roller and providing the kinetic energy for for the roller relies on the absorption of the photon emitted in this process by a lattice atom which is Ti atom in the experiments of Searl. The energetics comes out correctly.

The material composition of the Searl device

Searl device has rather complex layered structure consisting of cylindrical layers of neodymium, nylon, iron, and titanium. This structure was not taken into account in the earlier model. A breakthrough in the understanding of this aspect came through the experimentation of Samuli Penttinen with simpler systems giving negative results and from his proposal that the non-magnetic nylon layer could serve as a charge reservoir or play some other important function.

This led to a construction of a detailed model for the current flow equilibrium for the 4-layered cylindrical structure with this material structure and to the study of the boundary conditions at the layer-layer boundaries. A rather detailed quantitative picture about how charge accumulates in the interiors of layers and to the layer-layer boundaries emerges. Perhaps the most important realization was that the small electrical conductivity of air requires in the flow equilibrium that the electric field at the outer boundary of titanium layer is amplified by a factor of order 10^8 to a field which is by a factor of order 10^3 higher than the critical field inducing dielectric breakdown in air so that the simple model fails. The huge increase of the electric field requires an accumulation of positive charge at Ti-air boundary and explains why the air must be ionized but not its mechanism based on the dropping of electrons to larger space-time sheets.

The question whether also the magnetic field associated with the stator rotates is raised by the observation that the flux of the stator magnetic field returns back along the rollers. If this magnetic field does not rotate the magnetic flux tubes get twisted as in the case of the solar magnetic field and the analog of the solar sunspot cycle should result. If the magnetic field of the stator rotates this does not happen. Also stator becomes an active component of the system and one can motivate its 4-layered structure.

The Lorentz force on the radial ohmic current forces the distribution of the conduction electrons to rotate. In the small air gap between stator and roller the radial electronic current from the stator can flow to the roller. This flow provides stator and rollers with opposite charges and generates electrostatic force between them and also breaks the full rotational symmetry of the rotating charge distributions in stator and rollers. Hence one expects that in the dynamical equilibrium rollers rotate with the same velocity as stator charge distribution and that the net electrostatic torque vanishes. This classical picture explains the classical behavior of the system but not the spontaneous acceleration of the rollers. Especially interesting phenomena are expected to occur in the air gap between stator and roller, one such phenomenon being a formation of dark variants of ordinary atoms, so called N-atoms [F9, J6].

Energetics behind the formation of the magnetic walls

Also the energetics behind the formation of magnetic walls should be understood. The magnetic walls could carry also Bose-Einstein condensates of Cooper pairs of dark electrons with electrons in collective cyclotron state with a net angular momentum. A remote metabolism based on the emission of negative energy (phase conjugate) dark microwave photons absorbed by the dropping electrons is the simplest that one can imagine. The large value of Planck constant would make the energies of microwave photons equal to the liberated zero point kinetic energy. This conforms with the cooling of the air around the system. Also a mechanism of remote spontaneous magnetization based on magnetostatic waves can be considered and would lead the formation of magnetic walls as a remote spontaneous magnetization of $J = 2$ electron Cooper pairs at the space-time sheets of magnetic walls.

Why the replication of the experiments is so difficult and how to optimize the Searl device?

The formation of the magnetic walls means the emergence of long length scale fluctuations with coherence length much longer than the size of the system. Hence a quantum critical phenomenon seems to be in question and this could explain why the replication of the experimental findings has turned out to be so difficult. There are indeed many conditions to be satisfied. The distance between magnetic walls must correspond to the radius of the stator in resonance. This length scale also corresponds to the wavelength of dark microwave photons emitted in cyclotron transitions and the energy of these photons must also correspond to a zero point kinetic energy liberated as electron drops to larger space-time sheet.

The fact that continual di-electric breakdown is involved means second kind of criticality and the requirement that liberated zero point kinetic energy in the dropping of electron corresponds to the ionization energy of titanium atom for $n = 3$ valence electron makes also the phenomenon quantum critical.

These considerations suggest some ideas concerning optimization and possible variants of the Searl device. Perhaps a more important manner to optimize is based on the condition of quantum criticality some of whose aspects are now understood. Hall effect for the radial Ohmic current plays a key role in generating torque and this raises the question whether quantum Hall effect at low temperatures involving increases of conductivity by 13 orders of magnitude could maximize the torque.

3.1.2 Possible other similar systems

There are anomalies related to the behavior of rotating gyroscopes [43, 40] suggesting that rotating gyroscope can lose part of its weight. There are a claims about energy production with apparent efficiency larger than unity [38, 39] by machines which contain rotating magnets. The explanation would be based on the basic mechanism explaining the functioning of Searl device. Radial ohmic current charges the systems and generates usable electrostatic energy. The flow of ohmic current in term involves time mirror mechanism involving the emission of phase conjugate photons received by the magnetic walls generated by the rotating system, which contain dark matter.

3.2 Summary about the New Physics effects predicted by TGD

The basic new physics effects predicted by TGD relate to the many-sheeted character of space-time, to the new view about the relationship between gravitational and inertial energy, to the possibility of negative inertial energies and reversal of geometric arrow of time, and to the classical long range electro-weak and color fields.

3.2.1 The new view about the relationship between gravitational and inertial energy

At the level of quantum physics negative energy photons would correspond to a system quantized in such a manner that both bosonic and fermionic annihilation and creation operators have changed their roles. Negative energy photons and fermions do not correspond to (non-existing) "anti-photons" and anti-fermions. Using the terminology of Dirac's bra-ket formalism: negative energy systems are like bras if positive energy photons are kets. Kets and bras correspond to Hilbert space and linear functionals defined in it. The space of bras is actually not equivalent with that of kets but in a well defined sense a more general concept. This conforms with the role of negative energy space-time sheets in TGD inspired theory of consciousness. One can distinguish between ordinary phase of matter and phase conjugate phase. In ordinary phase matter has positive energy and antimatter negative energy. In phase conjugate matter the roles of matter and antimatter have changed.

In quantum field theories time reversal transforms creation operators for fermions to creation operators for anti-fermions. Vacuum state is not changed. Time reversal in TGD sense would transform ket vacuum to bra vacuum so that the earlier creation operators annihilate the new vacuum state and genuine negative energy states result. This would suggest that negative energy states are something genuinely new and a genuine outcome of the many-sheeted space-time concept allowing either bra and ket type vacuum at a given space-time sheet. It has become that this view explains elegantly r matter-antimatter asymmetry whose origin is one of the deepest problems of cosmology.

The new view leads also to an elegant understanding of the problematic issues related to the relationship between inertial and gravitational energy [D3, D5, D4]. TGD predicts and exact conservation of inertial and the most elegant and economic theory results when the net inertial energy of Universe vanishes. This view is certainly consistent with the crossing symmetry of elementary particle physics allowing to interpret particle reactions as a creation of states with vanishing net quantum numbers from vacuum, with outgoing particles representing negative energy states.

The non-conservation of gravitational energy is an empirical fact in cosmological scales and the identification of the gravitational energy as the difference of positive inertial energy of matter and

negative inertial energy of antimatter implies that gravitational energy density is non-vanishing and non-conserved. This resolves also the puzzle caused by the prediction that net inertial energy density vanishes in TGD inspired cosmology.

This picture leads to a rather detailed view about cosmology. The so called cosmic strings, which gradually transform to magnetic flux tubes with increasing thickness (and weaker magnetic field strength), are the key players of TGD inspired cosmology in all length scales. Magnetic factors have the same role also in TGD inspired biology. Since matter and phase conjugate matter correspond to a different direction of the arrow of geometric time, one can say that phase conjugate matter, which is mostly inside negative energy cosmic strings and magnetic flux tubes, obeys the second law of thermodynamics in a time reversed direction in geometric sense. Entropy increases but the process proceeds towards geometric past so that the resulting decay looks like self assembly from the point of view of an observer consisting of positive energy matter. Cosmic evolution would a homeostasis in which two opposite tendencies tending to increase and reduce entropy are competing. Second law in the standard form would apply only to the positive energy half of the Universe so that Universe would not be approaching heat death as the usual belief goes.

The vanishing of the inertial mass of a system leads to rather dramatic effects if positive energy and negative energy systems can form bound states, since this kind of system would be "feather light" although it still has non-vanishing gravitational mass. Even tiniest force could kick this kind of system to motion. If positive and negative energy systems do not form bound state they behave like their own independent subsystems and Equivalence Principle is satisfied in a good approximation. The formation of bound states of positive and negative inertial energy systems could provide a road to a new energy technology and perhaps even allow to create matter from vacuum by space-time engineering by generating vacuum extremals which represent space-time sheets with vanishing density of inertial energy.

3.2.2 Generalized four-wave mechanism as a basic mechanism of remote metabolism

Generalized four-wave mechanism provides a concrete realization for the more general time mirror mechanism underlying remote metabolism and many other mechanism important for the functioning of the living matter in TGD Universe. Generalized four-wave mechanism also provides a connection with the existing physics of phase conjugate waves.

Time mirror mechanism

Time mirror mechanism could make possible new technologies such as instantaneous remote energy utilization, instantaneous active remote sensing, and instantaneous communications over arbitrarily long distances. Time mirror mechanism is an essential element in the models of remote metabolism, long term memory, intentional generation of motor actions, sensory perception, and remote mental interactions. What happens that negative energy topological light rays propagating to the direction of the geometric past are reflected back in time direction and return as positive energy topological light rays (photons could accompany the rays).

This apparently paradoxical sounding language makes sense since the experienced time corresponds to a sequence of quantum jumps recreating space-time surface again and again and the correspondence between these times follows from quantum-classical correspondence: the contents of conscious experience in the essentially four-dimensional classical universe are dominated by contributions, which are sharply localized with respect to the geometric time. This creates the illusion that the classical universe is 3-dimensional. It is essential that the field equations determining the space-time surfaces as field analogs of Bohr orbits are not fully deterministic. Only this makes it possible for the classical dynamics to mimic the non-deterministic quantum dynamics.

Negative energy topological light rays can induce the dropping of ions from atomic to larger space-time sheets. The liberated zero point kinetic energy means that the system can act as an over-unity energy source. Negative energy topological light rays, presumably having phase conjugate laser waves as standard physics counterparts, would be accompanied by negative energy photons and these would induce the dropping of charged particles to larger space-time sheets without emission of photons. The experiments of Feinberg, in particular the experiment in which a chicken was irradiated by phase conjugate laser waves, demonstrate that the system was transparent to phase conjugate laser waves

at visible lengths. Indeed, if the phase conjugate photons have negative energies above the thermal energy, say at energies corresponding to visible wave lengths, there is no excited atomic system able to absorb negative energy photons inducing the return to the ground state.

The pairs of atomic and larger space-time sheets can act as many-sheeted population inverted lasers with frequencies which are universal constants of nature, and defined as differences of zero point energies whose values are predicted by the p-adic length scale hypothesis. If the intensity of the negative energy photons is above some critical value, the particles in the excited state of the many-sheeted population inverted laser drop to the ground state in a cascade like manner (the probability of dropping of charged particle is proportional to the number of charged particles already present at larger space-time sheet and thus to the intensity and duration of negative energy topological light ray irradiation). The time reflection thus involves an amplification and negative energy photons serve only the role of controller. The system becomes over-unity energy source making possible remote energy utilization.

Four-wave interaction and time mirror mechanism

Four-wave interaction is the basic mechanism producing phase conjugate laser waves, and TGD approach leads to a generalization of this mechanism [K4]. Four-wave interaction becomes the basic mechanism of intentional action and is behind the basic biological and brain functions like (actually remote) metabolism and long term memory. The findings of Tiller [38] about physical correlates of intentional action find a nice explanation in this framework.

There are several open questions about four-wave interaction. Could four-wave interaction or its generalization provide a deeper understanding of the scaling law of homeopathy stating that low and high frequencies appear in pairs [K5]? Could the basic function of probe and conjugate beams be the amplification of the standing wave interference pattern by remote metabolism? Does the standing wave formed by the reference beams serve as a kind of standardized hologram? Is it possible to generalize the notion of hologram in order to get rid of the reference beams?

The standing wave interference pattern represents a synchronous oscillation of the entire system and would be an excellent physical correlate for the ability of living organisms to act as coherent wholes. The standing wave resulting as the interference pattern of waves propagating in opposite directions would serve kind of a standardized hologram parameterized by the wavelength λ_h . The interference pattern can be also kicked into a motion by Lorentz boost, and the propagation velocity of the interference pattern is an additional characteristic of the pattern.

Probe and phase conjugate beams in four-wave interaction could in turn be interpreted in terms of remote metabolism. System sends negative energy topological light rays (or massless extremals, MEs) to the geometric past and receives as a response positive energy MEs, and amplification can occur in this process so that negative energy signal serves only a role of control signal. Its generation would utilize the energy provided by the remote metabolism. The emission of negative energy ME would switch on the positive energy laser of the geometric past generating probe beam. The energy source could be system in its geometric past or some system in the environment.

Standing wave is basic element of the mechanism and its generation would require energy obtained by emitting phase conjugate photons. Standing wave need not result only as an interference of classical em wave propagating in opposite directions, but could correspond to any standing wave. Plasma resonances are an especially interesting candidate for a standing wave since plasma frequency does not depend on wave vector at all in lowest approximation. This means that there is no dispersion and the pattern formed by plasma waves is oscillatory. I have indeed proposed that this kind of plasma wave patterns are in key role in living matter. Besides electromagnetic plasma wave patterns also classical Z^0 plasma waves are possible if nuclei possess anomalous Z^0 charges as suggested in [F8, F9]. The plasma wave pattern would get the energy of its self-organization by sending (say) negative energy photons.

One can imagine a metabolic hierarchy which is obtained by a time reversal from the dissipation hierarchy for which energy from long length scales gradually dissipates to short length scales. The dissipation of the energy of a hydrodynamic vortex by the gradual decay to smaller vortices is a basic example of this process. Now this kind of process would be replaced by a self-assembly starting from the most energetic level and involve radiation of phase conjugate waves with decreasing frequency scales. The lowest level would correspond to ordinary metabolic mechanism, magneto-static waves could be at the next level and the counterparts of magneto-static waves for Cooper pairs at magnetic

flux tubes could be also present and correspond to very low frequencies.

In living matter metabolic energy feed corresponds to the "pumping" and drives protons back to the atomic space-time sheets, and the same would be true now. This hints to a somewhat pessimistic conclusion from the point of view of over unity enthusiast: if the system gains its energy by dropping its own protons to larger space-time sheets, it cannot work for too long. This might relate to the continually occurring optimistic reports about free energy production followed by silence. The point of over unit technology would not be however tapping endlessly energy about vacuum but the possibility of remote metabolism which could make un-necessary for system to carry energy storages with itself and allow extreme flexibility and instantaneous generation of energy when needed.

3.2.3 The classical Z^0 fields as TGD counterpart for torsion fields

TGD predicts the existence of classical long ranged fields identified in terms as space-time correlates of scaled down copies of ordinary weak bosons [F9] identifiable as various forms of dark matter. Already low energy hadrons and nuclei involve dark forms of valence quarks and nuclei also exotic quarks with masses in MeV range. Exotic quarks couple to light variants of weak bosons with weak length scale L_w of order atomic length scale. Nuclei can develop anomalous weak isospin. Entire hierarchy of scaled down variants of weak bosons is unavoidable prediction of TGD if one takes quantum classical correspondence seriously. This means that under certain circumstances also Z^0 electric fields can cause detectable effects. For instance, the TGD based explanations of the tritium beta decay anomaly [18] and the anomalous variation of the radio active decay rates [19] involve the interaction of small sized objects with weak fields.

Even local Z^0 neutrality of condensed matter, which could be due to dark neutrino screening, does not exclude the possibility of Z^0 magnetic fields. Thus rotating macroscopic objects could generate Z^0 magnetic fields and the claimed properties of the torsion fields [20, 21] are very much like those of Z^0 magnetic fields. In particular, also classical Z^0 field has parity breaking axial coupling to elementary particles, and large parity breaking effects are predicted (chiral selection in living matter has explanation along these lines).

The generation of classical Z^0 magnetic field might be involved with the large parity breaking observed in the experiments of Roshchin and Godin [49] (the critical rotation velocities were different for clockwise and counterclockwise rotations). Note however that also the sign of vacuum charge density involves parity breaking effect irrespective whether em or Z^0 field is in question. It is however clear that the radial electric fields generated by rotation can only serve as a seed for the em and Z^0 charging of the roller system inducing the effective loss of weight in the Earth's em and Z^0 fields. What happens is that radial ohmic currents of electrons and neutrinos are created and this leads to the em and Z^0 charging of the system and therefore to the effective loss of weight in the em and Z^0 electric fields of Earth. It is also possible that flux structures carry combination of magnetic and Z^0 magnetic fields and the strange shell like magnetic field structures could be accompanied also by Z^0 magnetic fields.

3.2.4 Gravitational anomalies and many-sheeted space-time

TGD space-time is many-sheeted surface in $H = M_+^4 \times CP_2$, which can be regarded as the future light-cone of Minkowski space with points replaced with CP_2 having size about 10^4 Planck lengths. One can visualize the space-time sheets as almost parallel pieces of plane glued together by wormhole contacts and also connected by join along boundaries bonds¹. The distance between the sheets is of order CP_2 radius. This makes possible anti-gravitation like effects since a macroscopic object (itself a space-time sheet containing hierarchy of smaller space-time sheets glued to it) can feed its gravitational flux to several space-time sheets. A modification of the standard distribution of gravitational flux between various space-time sheets could produce gravitational anomalies at a given space-time sheet, in particular modify the effective gravitational mass.

What about the effects of redistribution on gravitational flux on the motion of the system?

1. Newtonian intuition would suggest that the gravitational force experienced by the object is replaced with

¹For illustrations see my home page <http://www.physics.helsinki.fi/~matpitka/illua.html>.

$$F_{gr} = \sum_i \frac{M_i}{M} F_{gr,i} , \quad (3.2.1)$$

where the summation over space-time sheets is understood. This means that the simple Newtonian picture fails and the determination of the gravitational constant can give varying values.

2. In relativistic picture the motion in absence of external forces occurs along geodesic lines or rather, tubes made out of them. The distribution of gravitational fluxes would mean a fractal superposition of geodesic motions in different length scales. As far as the motion of given space-time sheet X^3 as seen from imbedding space level is considered, the largest space-time sheet receiving gravitational flux determines the rough pattern of motion and smaller space-time sheets add smaller details to it. The redistribution of gravitational gauge fluxes can only affect the initial values of three-momenta at a given space-time sheet X_i^4 .

The original hypothesis was that the redistribution of gravitational flux could dominate the change of weight as it is manifested in the motion of the system according to Newtonian intuition in rotating magnetic systems. It however turned out that the generation of em and Z^0 charges and interaction with the Earth's corresponding fields explain dominant part of the weight change and also the spontaneous acceleration.

3.2.5 Questions related to the vacuum charge densities associated with rotating systems

The experiments of Faraday related to a rotation of cylindrical magnet with conductor disk attached rigidly on its top, are not well known to average physicist [39]. The outcome these experiments was that radial electric field is generated between the rim and axis of the rotating conducting disk. This effect does not follow from Faraday's law of induction and is not satisfactorily understood in Maxwell's electrodynamics and it is somewhat surprising that Faraday's experiment has not received more attention.

A mere rotation of a 3-surface carrying magnetic field generates vacuum charge density

One can understand the generation of the radial electric field in Faraday's experiment by assuming that the rotation of the rotating system corresponds geometrically to a rotating 3-surface carrying magnetic field. The induction of the potential difference could be regarded as a direct evidence for 3-space as 3-surface concept! The mere rotation of 3-surface very probably does not give rise to absolute minimum of Kähler action but it could be that the actual absolute minimum is obtained as a small deformation of the orbit of rotating 3-surface.

One reason why for the presence of the radial electric field is that it guarantees stability of the rotating condensed matter in conducting disk.

1. Assume that rotating Faraday disk generates vacuum charge density the sign of which depends on the direction of rotation. The reason for the generation of the electric field could be the stability of the condensed matter: rotating nuclei suffer magnetic force $ev \times B$ and the Coulombic force created by the radial electric field cancels this force.
2. Charge density can be calculated as divergence of the radial electric field compensating magnetic Lorentz force. The required electric field has the magnitude

$$E = \omega Br , \quad (3.2.2)$$

where r is radial cylindrical coordinate. The corresponding charge density is given by

$$n_V = \frac{\omega B}{e} . \quad (3.2.3)$$

[The units $\hbar = c = 1$ are used].

3. It seems that the required charge density n_V cannot be due to a re-arrangement of the density of the conduction electrons since in this case there would be large parity breaking differentiating between two rotation directions. Thus some kind of vacuum polarization effect must be in question. In standard physics vacuum polarization effects are purely local and its is difficult to see how one could generate macroscopic polarization effects. In TGD however point like particles are replaced by 3-surfaces and vacuum polarization could thus generate new space-time sheet.

Does charge conservation require that new space-time sheet is created when vacuum charge density is generated

In TGD particles are not point like but correspond to 3-surfaces so that vacuum polarization typically leads to a generation of double-sheeted space-time surfaces carrying opposite classical quantum numbers such as charge and energy. Charge conservation requires that the two space-time sheets carry opposite charge densities. Since the distance of the space-time sheets in CP_2 direction is of order CP_2 length about 10^4 Planck lengths, the generation of the new space-time sheet with opposite charge density can be indeed regarded as a local vacuum polarization mechanism.

Besides vacuum bubble interpretation also energetic considerations suggest that the new space-time sheet has negative time orientation since only in this case the creation of the new space-time sheet does not cost energy. It however increases the energy of the material space-time sheet and this might gives clue to the understanding of what is involved with the explanation of over unity devices involving rotating magnetic systems. Needless to say, the instability of the vacuum against generation of negative energy space-time sheet in principle could make possible generation of entire galaxies from vacuum: human kind or our followers might some day take the role of God!

Does the generation of vacuum charge density relate to the generation of # contacts

Vacuum charge density at given space-time sheet could be realized in several manners.

1. The field equations associated with the absolute minimization of Kähler action allow vacuum charge densities unlike vacuum Maxwell equations. The reason is that primary dynamical variables are not the Maxwell gauge potentials defined by the induced Kähler form but imbedding space $(H = M_+^4 \times CP_2)$ coordinates in terms of which the induced Kähler form defining classical Maxwell field, is expressible. Electromagnetic field is superposition of Kähler field and certain component of CP_2 spinor curvature. In the approximation that gravitational effects are neglected, field equations reduce to empty space Maxwell's equations locally and it is not clear whether rotating 3-surface suitable deformed could correspond to a solution of field equations. Charge conservation requires that opposite charge density is realized to the space-time sheet at which the space-time sheet of the rotating cylinder feeds its gauge fluxes via wormholes. This space-time sheet could be also material space-time sheet having positive time orientation so that the generation of the gauge fields would require energy.
2. Charge density could be also understood as resulting from the wormhole throats feeding electric flux between two space-time sheets: the two throats have opposite gauge fluxes behaving effectively as classical charges by Gauss's Law. The basic rule of the game is that wormhole contacts are reside on the boundaries of the space-time sheets and can give rise to effective surface charge densities only. Wormhole contacts at boundaries are certainly present and feed gauge fluxes between space-time sheets. Thus charge density in the interior cannot correspond to wormhole contacts if this rule is OK. Wormhole contacts correspond at quantum level parton pairs. Partons are assignable to the light-like 3-D causal horizons associated with wormhole contacts [F6]. If the time orientations of the space-time sheets are of opposite sign these parton pairs can have vanishing net inertial energy. The density of these parton pairs could serve as a

correlate for vacuum charge density. It should be noticed that around $\#$ contacts modelled as CP_2 type extremals the CP_2 projection of space-time surface is necessarily $D \geq 3$ -dimensional so that vacuum extremals cannot be in question.

3. The splitting of the wormhole contacts is possible and can give rise to fermions carrying there electroweak quantum numbers on the resulting boundaries of the holes of a split wormhole contact. For instance, electron-positron pairs could be created. It seems most natural to assume that resulting fermion pairs are ordinary fermions and electron-positron pairs are the simplest possibility. One can of course question the assumption that electrons are 'ordinary'. For closed space-time sheets this is certainly not the case but now new space-time sheet has boundaries and is much like material space-time sheet but possibly having finite time duration. Therefore a reasonable *working hypothesis* is that electrons and positrons created in this manner behave like ordinary electrons and positrons except that the sign of energy is different at the new space-time sheet. It is quite possible that the rotating 3-surface, which is the first guess for the space-time surface describing rotating system, is not imbeddable globally and that the failure of the imbeddability at 3-dimensional surfaces gives rise to boundary components with size of order CP_2 size and identifiable as elementary particles.

3.3 About strange effects related to rotating magnetic systems

The inspiration for writing this section (rewritten for many times when I am writing this) came from the publication of Godin and Roshchin in Russian journal *New Energy Technologies* [49], which A. V. Frolov kindly sent to me. The article gives very valuable quantitative information about the anomalies related to the rotating magnetic systems.

A tentative conclusion about the strong parity breaking effects involved is that classical Z^0 force must play an important role in the effect, and perhaps give a dominating contribution to the effect. The rotating magnetic system develops vacuum em and Z^0 charges by a mechanism discovered already by Faraday and not consistent with Maxwell's theory. This charge turns out to be too small to induce effective weight change. The radial em and Z^0 electric fields however induce radial ohmic electron and exotic neutrino currents and the leakage of corresponding charges from the system. The resulting charges couple to the Earth's electric and Z^0 electric fields. The sign of the em (unlike Z^0) force depends on the direction of rotation and this explains parity breaking effect. The generation of charge explains the plasma phase and the resulting Lorentz force explains the mechanical stability of the rollers in Searl's original device against a centrifugal acceleration. The Lorentz torque experienced by the ohmic currents implies spontaneous accelerated rotation above a critical frequency determined from the condition that the Lorentz torque proportional to frequency is larger than the friction torque.

An alternative explanation for the spontaneous rotation would be in terms of the reduction of inertial mass of the rotating magnetic system, which combined with angular momentum conservation would explain elegantly the spontaneous accelerated rotation of the system as a pirouette effect. Also the redistribution of the gravitational flux of the system between larger space-time sheets must be assumed. The required generation of gravitational mass from vacuum is measured in kilograms and seem to be unrealistically high.

This argument does not exclude the generation of gravitational mass from vacuum in smaller amounts. The generation of inherently unstable vacuum extremals self-organizing to positive and negative energy space-time sheets might be involved. Therefore one must consider seriously the possibility that positive and negative energy inertial energy is created from vacuum in amounts determined by the density of magnetic energy associated with the strange magnetic walls accompanying the system. Interestingly, for vacuum extremals Z^0 and em field are proportional to each other: $Z^0 \simeq -8\gamma$ so that it might be possible to understand also the generation of classical Z^0 fields and Z^0 magnetization of the system.

The new view about energy has led to a variant of the generalized four-wave mechanism based on magnetostatic waves as a manner to suck energy from environment. This mechanism could provide the kinetic energy for the accelerated magnetic system.

3.3.1 The experiment, the observed effects, and their interpretation in TGD framework

It is convenient to start with a brief description of experiment, observed effects, and their interpretation in TGD framework.

The experiment

The experiments of Roshchin and Godin [49, 27] involve a magnetic system consisting of ring like stator magnet and rotor consisting of 23 cylindrical magnets (rollers) in ring along the rim of the stator and free to roll along the rim. The outer radius of stator was .5 m. The air gap between stator and roller surfaces was $\delta = 1$ mm. According to [27], the ratio of the radius or roller to stator radius was taken to be an integer N not smaller than 12 in order to make possible magnetostatic resonance.

The entire system rested on a platform carried by springs so that the possible changes in the weight of the system could be deduced from the change of the equilibrium position. The weight of the system with the platform included was 350 kg.

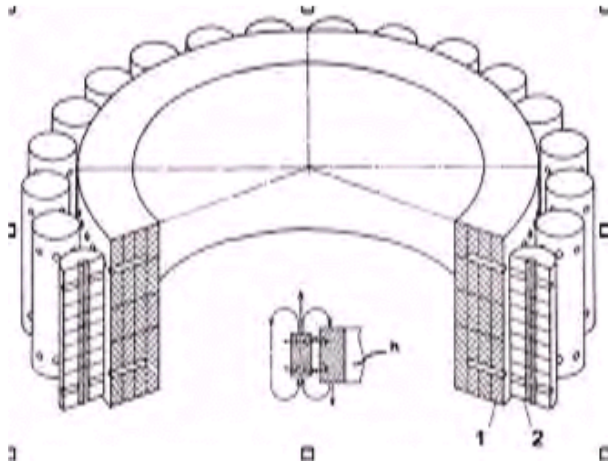

Figure 3.1: Variant of one-ring converter (figure 25 in [27]).

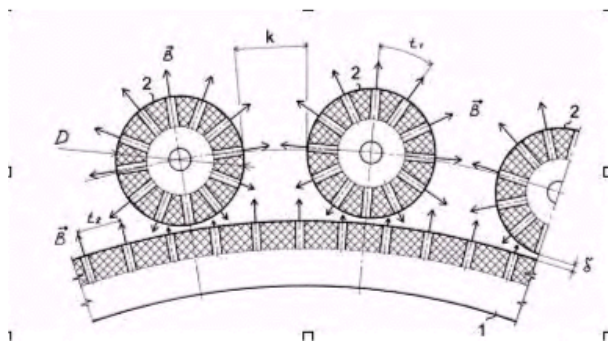

Figure 3.2: The general view of the converted and its platform (figure 26 in [27]).

The roller and stator carry magnetic fields which are in opposite directions. Both consist of segments which are rare earth magnets (neodymium): the total amounts of neodymium used to construct stator and rotor magnets were 110 and 115 kg. The strength of the residual induction was 1 Tesla. The magnetic field was not precisely vertical since cross-magnetic inserts having a flux vector of 1.2

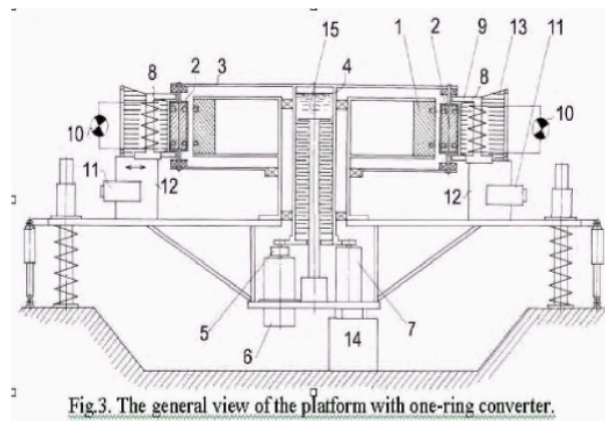

Figure 3.3: Magnetic inserts could make possible magnetic cogwheel mechanism (figure 27 in [27]).

Tesla orthogonal to the primary magnetization vector were added on both the stator and rollers. The distance between roller and stator inserts was same and there were 12 inserts per roller (and hence $N \times 12 \geq 12^2$ inserts for stator). The natural guess is that the function of the resulting periodic gradients in magnetization helps to make the stator and rotor magnets to a kind of magnetic cogwheels forcing smaller magnets to roll rather than only rotate without translational motion since slipping would generate a torque. More details about the magnetic structure of the stator and roller magnets can be found in [27].

The system contained arrangement allowing to arrange a high voltage of 20 kV between stator and rotor with plus pole corresponding to stator. This voltage is much higher than the voltage caused by the rotation measured in volts.

The observed effects

Several strange effects were observed and it seems that TGD based model is now sufficiently well understood to explain them. Figure 1 (figure 28 of [27]) representing the relative weight loss $\Delta G/G_0$ for *clockwise* rotation as a function of rotation frequency f gives a good overall view about the situation.

1. In the initial situation rotor magnets were rotated using electric motor. Above some critical clockwise rotation velocity the system started to lose weight. The displacement meter started to detect the change of weight at 200 rpm. The gradient $\frac{d(\Delta G/G_0)}{df}$ satisfied everywhere the condition

$$\frac{d(\Delta G/G_0)}{df} > 0 ,$$

and below 550 Hz the it was increasing as the inspection of the graphical representation of [27] shows. At 550 rpm the system starts to accelerate spontaneously and the electric motor was decoupled. At 550 rpm the weight loss is 30 per cent and in the interval 30-31 per cent the rotation speed accelerates to about 600 rpm. The gradient of the weight loss $\Delta G/G_0$ as function of rotation frequency f became very small at 550 rpm.

For the reasons of mechanical stability a gradually increasing load is coupled to system so that the angular acceleration is reduced and the curve for $\Delta G/G_0$ as function of f develops a shoulder. The replacement of continual acceleration with a shoulder is basically due to the load. The maximum weight loss was 35 per cent and reached at about 600 rpm above which the experimentation was not possible due to the problems with the mechanical stability. The load was increased in units of 1 kW up to 7 kW. A load larger than 7 kW results in a gradual decrease

of the rotation speed and an exit from the self-sustained mode. Note that mass equivalent for the generation of energy with the rate of 7 kW is 7.8×10^{-13} kg/s.

The coupling of 20 kV voltage affects the diagram characterizing the rotation velocity as a function of weight loss by increasing the value of rotation velocity for a given weight loss as also the coupling of load does. In the presence of voltage with output power 7 kW the rotation frequency begins to decrease at the maximum weight loss of 35 per cent from 600 rpm whereas the effective weight remains constant down to 400 rpm.

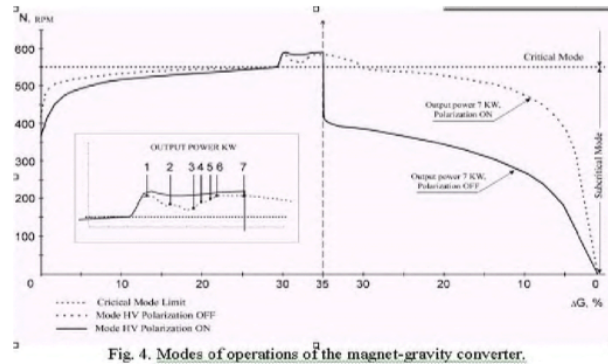

Fig. 4. Modes of operations of the magnet-gravity converter.

Figure 3.4: The development of the change of weight as function of rotation frequency (figure 28 in [27]).

- There is a strong parity breaking involved. Depending on whether the direction of rotation is clockwise or counter clockwise weight is reduced or increases. The critical mode appears around 550 rpm for a clockwise rotation and around 600 rpm for a counter clockwise rotation. Searl has reported also the modification of radioactive decay rates in the vicinity of the Searl device. The presence of classical Z^0 (and possibly W) besides em force could explain this kind of effects. It must be noted that already the generation of the radial vacuum electric field in the roller magnet means spontaneous parity breaking. The mere electromagnetic charging of the rollers in the Earth's electric field cannot however explain the different critical rotation frequencies for the two rotation directions.
- During the self-sustained mode a cooling of the environment in the vicinity of the magnetic system is observed. A stable fall of the common temperature 22 C of laboratory by 6-8 degrees was observed. This suggests violation of the second law. The sucking of energy from environment by a phase conjugate mechanism could be involved. That phase conjugate waves are involved was proposed also in the article of Dr. Paul la Violette [28]. Phase conjugate microwaves generated by magnetostatic waves are the best candidate for the generalized standing waves (actually rotating around stator magnet). The reason is that for sufficiently long wavelengths the dispersion relation does not depend on wavelength so that arbitrary wave pattern repeats itself periodically with a frequency which is expressible in terms of Larmor frequencies of electron in the fields defined by the magnetization and by the external field (now the field of roller inside stator).
- In a dark room corona discharges are observed around the converter rotor as a blue-pink glowing luminescence and a characteristics ozone smell. The cloud of ionization covers the area of a stator and rotor and has therefore a toroidal shape. Also a series of horizontal yellowish-white luminescent bands spaced along the height of the roller surface and separated from one other by about a roller radius were observed. This suggest a high voltage electron discharge from the surface of the roller magnets. It was however not accompanied by sounds characteristic of arc discharge, which suggests an emission coming from a larger surface rather from a point source. The plasma could be due to the electromagnetic charging of the the rollers. Roller system would consequently experience the force caused by the Earth's em and Z^0 electric fields implying the

effective loss of weight. The radial electric field generated by Faraday effect in rotating systems could induce an Ohmic current leading to a partial leakage of the charge to the space-time sheets of environment: part of charge would flow to larger space-time sheets associated with the rollers and would only induce a many-sheeted polarization of the roller system.

The luminescence resembles high voltage microwave induced luminescence observed prior to the point of electrical breakdown. Microwave radiation associated with the self-organizing magnetostatic waves might be in question. For electrons in a field of 1 Tesla the frequency of these waves is around Larmor frequency $f_L \simeq 12$ GHz and corresponds to a wavelength of about 2.5 cm. The ionization of the air suggested by the presence of blue light perhaps identifiable as electronic excitation line of ionized N_2 molecule, requires the presence of electrons with energies of order keV.

5. Concentric magnetic walls with a reduction of temperature inside them begin to appear at 200 rpm. The strength of magnetic field depends approximately linearly on the rotation speed and increases up to .05 Tesla. The maximal temperature drop is 8 C. The walls are separated by a distance of about .5 m which is the radius of the stator and the thickness of the wall is about 5-6 cm.

Intriguingly, the Larmor frequency for the maximal .05 Tesla magnetic field associated with walls corresponds to .6 GHz and wavelength of .5 meters, the radius of the stator. Hence this magnetic field strength might relate to a microwave resonance at cyclotron frequency and with a wavelength equal the radius of the stator, and somehow providing the energy needed by the system accelerating spontaneously. Lowest cyclotron transitions and spin flip transitions inside magnetic walls would have this frequency naturally and the magnetic walls would appear at the nodes of the waves.

The direction of the magnetic field inside the walls coincides with the direction of the magnetic field created by rollers and is same as the direction of the return flux of the magnetic field of stator+roller system. The interpretation as a spontaneous magnetization associated with the Cooper pairs forming a Bose-Einstein condensate at the space-time sheet of the magnetic wall allows to understand the spontaneous acceleration of the rollers. Remote metabolism in which phase conjugate microwaves induce spontaneous magnetization liberating energy takes care of energetics. The rollers generate angular momentum by transforming the electronic spin and angular momentum to the angular momentum of the roller and compensate the lost spin by spin flips accompanied by a remote spontaneous magnetization of the magnetic walls to achieve angular momentum conservation. Also the rotation of electrons in the magnetic fields of the rollers could be effective generator of recoil angular momentum.

The thickness of the magnetic walls about 5-6 cm is somewhat larger than the roller radius 3.7 cm and twice the wavelength 2.5 cm of the microwaves possibly generated by self-organizing magneto-static waves at Larmor frequency and rotating around the stator. The Larmor frequency associated with magnetic walls when spontaneous rotation starts corresponds to a wavelength of .5 m which brings in mind resonance mechanism. The generalized four-wave mechanism involving microwaves at both 2.5 cm and .5 m wavelengths strongly suggests itself as a mechanism making possible the spontaneous acceleration. Magnetostatic waves generated in stator are good candidates for a building block of the mechanism.

The minimal model explaining the effects

The basic question is whether both the reduction of the inertial mass, increase of effective gravitational mass, and classical em and Z^0 forces are needed. The minimal model involves only the classical em and Z^0 forces.

1. The fact that the sign of the weight change depends on the direction of rotation suggests a large parity breaking effect. Already the mechanism generating radial electric field induces spontaneous parity breaking and ordinary charging and Earth's electric field might explain the effect. The effect has however a slightly different dependence on rotation frequency for two rotation directions and this requires the presence of also Z^0 field. The presence of the repulsion or attraction due to the classical em and Z^0 electric fields of Earth on the rotator having em and

Z^0 charges increasing with rotation frequency f is a good candidate for the explanation of the strong parity breaking. These forces would be induced by the radial em and Z^0 electric fields induced by the rotating Z^0 magnetic field created by the spinning rollers and inducing in turn radial ohmic currents of electrons and neutrinos from rollers and hence em and Z^0 charging of the system. The basic test of the model is to look how electric in the vertical direction affects the behavior of the system.

2. The spontaneous acceleration might rely on a variant of so called ball bearing motor mechanism [28]. The radial current of Z^0 charge due to Z^0 Faraday effect flowing through the space-time sheet containing Z^0 magnetic field of the roller ring suffers a Lorentz torque in the magnetic and Z^0 magnetic fields. Similar em torque appear in the space-time sheets of rollers. When the rotation velocity is so high that the resulting torque proportional to rotation frequency is larger than the frictional torque, the system starts to accelerate. Together with Faraday effect this leads to a positive feedback loop. This mechanism explains also the different critical angular velocities for clockwise and counter clockwise directions of rotation and provides the most economical model for the Searl effect.

3.3.2 The electric fields associated with rotating magnetic fields

The radial electric fields associated with rotating magnets were discovered already by Faraday. The direction of field depends on the direction of rotation and field gives rise to charge density. This means strong parity breaking effect difficult to understand in standard physics framework. Also classical Z^0 fields are involved and the idea that the radial Z^0 electric field generates neutrino flow to larger space-time sheets and thus a net density of Z^0 charge turns out to be key element in the model of Searl device.

Are the rotating magnetic systems consistent with Maxwell's equations?

Faraday's observation that rotating magnetic generates radial electric field $E = \omega\rho B$ is only marginally consistent with Maxwell's equations due the presence of a charge density which changes sign when the direction of rotation is changed. In TGD these fields are possible.

TGD allows purely geometric vacuum charge densities with no elementary particles acting as charge carriers. In particular, if ones 'kicks' a 3-surface containing a constant magnetic field into a rotational motion, vacuum charge density results. This is seen by considering a simple model for the imbedding of a magnetic field $B_z(\rho)$ as an induced gauge field in $M_+^4 \times S^2$, where S^2 is a geodesic sphere of CP_2 . In spherical coordinates $(\cos(\Theta), \Phi)$ for S^2 the electromagnetic component of CP_2 spinor connection is

$$A_\Phi = \cos(\Theta) \quad (3.3.1)$$

apart from a multiplicative numerical constant. The induced em gauge potential is

$$A_\mu = A_\Phi \partial_\mu \Phi \quad (3.3.2)$$

as a projection of the component of the spinor connection to the space-time surface. In cylindrical coordinates (t, z, ρ, ϕ) for M_+^4 one has for the imbedding of magnetic field as an induced gauge field

$$\cos(\Theta) = f(\rho) \ , \quad \Phi = n\phi \ , \quad B_z(\rho) = \partial_\rho A_\Phi = \partial_\rho f n \ , \quad (3.3.3)$$

where n is integer. Note that the imbedding necessarily fails at some critical radius since $\cos(\Theta)$ cannot be larger than one: this is nothing but topological field quantization of magnetic field to flux tubes.

When the magnetic 3-surface is 'kicked' to a rotating motion one has

$$\cos(\Theta) = f(\rho) \ , \quad \Phi = n(\phi - \omega t) \ , \quad (3.3.4)$$

and an electric field

$$E_\rho = \partial_\rho A_t = -\omega\rho B \quad (3.3.5)$$

is generated.

The condition $E_\rho = vB = \omega\rho B$, which can be interpreted as the vanishing of the net Lorentz force locally, gives rise to a vacuum charge density

$$\rho_{vac} = \nabla \cdot \vec{E} = -\omega B \quad (\text{in units } \hbar = c = 1) \quad (3.3.6)$$

The sign of the vacuum charge density depends on the direction of rotation. This means a large parity breaking effect. It is very difficult to understand how the sign of the charge density could depend on the direction of rotation if charge carriers were ordinary elementary particles. Thus this effect, observed already by Faraday, seems to be in conflict with Maxwell's theory and to support TGD.

Charge conservation requires that the radial electric gauge flux of vacuum goes somewhere at the boundary of the magnet space-time sheet. The only possibility is that a new space-time sheet is generated parallel to the magnet space-time sheet (unless it exists already). The electric flux runs through wormhole contacts or join along boundaries bonds to this space-time sheet and back in radial direction at the second space-time sheet. If this space-time sheet has negative time orientation (guaranteeing that the sign of the electric field as tensor component F_{0r} changes), it has also negative energy, and energy conservation requires that the rotating system gets positive compensating energy.

The fields associated with the rolling magnets

At theoretical level the situation in the case of magnets rolling along the rim of stator ring does not differ essentially from the simpler case if one neglects the effects caused by absolute minimization of Kähler action. One can also apply the description below to the calculation of both em and Z^0 fields. Z^0 electric fields are present only in a system perform rolling motion. In the following only the electromagnetic case is discussed.

The rolling magnet is described by a space-time sheet containing an axial magnetic field and characterized by the mapping of M_+^4 to S^2 , where S^2 is a geodesic sphere of CP_2 . M_+^4 has local cylindrical space-time coordinates (t, z, ρ, ϕ) and S^2 spherical coordinates $(u = \cos(\Theta), \Phi)$.

1. A stationary system non-rotating cylindrical magnet corresponds to the surface

$$u = f(\rho), \quad \Phi = n\phi \quad .$$

In this case the magnetic field is of form

$$B = n\partial_\rho u \quad .$$

For a set of parallel magnets one must find imbedding for the superposition of the magnetic fields and the expression generalizes to

$$B = \frac{\partial(u, \Phi)}{\partial(\rho, \phi)} \quad ,$$

which is just the Jacobian for the mapping from x-y-plane to S^2 defined by the matrix of partial derivatives.

2. The rotating, but not rolling magnet, is obtained by the replacement

$$t \rightarrow t, \rho \rightarrow \rho, \phi \rightarrow \phi - \frac{\omega}{n}t = \hat{\phi} \quad .$$

The magnetic and electric fields are obtained by a standard tensor transformation formula for antisymmetric space-time tensors and one has in the case of single magnet

$$B = \frac{\partial(u, \Phi)}{\partial(\rho, \hat{\phi})} , \quad E = B \frac{\partial(\rho, \hat{\phi})}{\partial(\rho, t)} = \frac{\omega}{n} B .$$

3. The rolling magnetic system is obtained from the stationary one by kicking the space-time sheet to a rolling motion

$$u = f(\hat{\rho}), \quad \Phi = n\hat{\phi} ,$$

where one has

$$\rho \rightarrow \hat{\rho} = \sqrt{(x - x(t))^2 + (y - y(t))^2} , \quad \phi \rightarrow \hat{\phi} = \arctan\left(\frac{(y - y(t))}{(x - x(t))}\right) - \frac{\omega}{n} t .$$

The motion of the center of mass of roller along a ring of radius R is given by

$$(x(t), y(t)) = R \times (\cos(\Omega t), \sin(\Omega t)) .$$

In the rolling coordinate system there is only magnetic field $\hat{B}(\hat{\rho}, \hat{\phi}) \equiv \hat{B}$ present, and one can obtain the magnetic and electric fields in stationary system by tensor transformation formulas:

$$B(\rho, \phi) = \hat{B} \frac{\partial(\hat{\rho}, \hat{\phi})}{\partial(\rho, \phi)} ,$$

$$E(\rho, \phi) = \hat{B} \frac{\partial(\hat{\rho}, \hat{\phi})}{\partial(t, \phi)} ,$$

For $\Omega = m\omega$, m integer, the electric and magnetic fields are period with respect to time with frequency ω and one can expect resonance effects.

3.3.3 A classical model for the weight change and spontaneous acceleration involving only em and Z^0 fields and Faraday effect

The assumption about the reduction of inertial mass by one per cent needed to explain the spontaneous acceleration seems hard to take seriously, and one must ask whether less exotic mechanisms generating the spontaneous acceleration could be imagined.

In the article of LaViolette [28] a modification of the so called ball-bearing motor effect combined with the Faraday effect is discussed as a positive feedback mechanism leading to the angular acceleration of the system. Ball bearing motor contains an inner conducting cylinder able to rotate and coupled to the wall of the outer cylinder by ball bearings, which do not slide with respect to the inner cylinder. When a radial voltage gradient exists between the cylinders, a radial current j flows through the bearings and Lorentz force

$$F = \int_{bb} j \times B dV \sim IBV_{bb}$$

acting on bearing in a tangential direction is generated and creates a torque $\tau = F(R + r)$, where R and r are the radii of the inner and outer cylinder (subscript bb refers to ball bearing in the formula). The current keeps the cylinder in a rotating motion if given an initial torque.

The idea described in [28] is that one can regard the rotating rollers as a single rotating ring and that Faraday effect generates also now a radial electric field $E = v \times B$ through the ring. The estimate for the corresponding maximum voltage through the roller is

$$V = \pi B f ((R + r)^2 - R^2) .$$

For $f_{max} = 23 \times 10$ Hz, $R = .5$ m and $r = .07$ m, and $B = 1$ Tesla this gives $V = 2$ Volts. Using the estimate $R = 460 \mu\text{Ohm}$ for the resistance of the roller, one finds that the current is about $I = 4300$ A. Using the previous formula one can make an order of magnitude estimate for the resulting torque

on single roller as $\tau \sim IBrR \sim 140$ Nm. The sign of the torque changes with the direction of rotation and conforms with the fact that angular acceleration is observed for both directions of rotation.

On the other hand, from the observed angular acceleration during the spontaneous acceleration one obtains the estimate for the torque suffered by single roller:

$$\tau \sim M_r r^2 2\pi \frac{\Delta f}{\Delta t} ,$$

where one has $\Delta f \sim 45$ rpm and $\Delta t \simeq 5$ sec. For the roller mass $M_r \sim 100$ kg/23 this gives $\tau \sim .45$ Nm, which is by two orders of magnitude smaller than the first estimate. Something goes wrong.

One can indeed criticize the model. The assumption that all the angular momentum gained by the electron current is transferred to the roller is probably wrong. The extreme situation is that the current flows out freely through the boundaries of the roller and roller itself receives no angular momentum. A more serious objection is following. The net radial current associated with single spinning but non-rolling roller vanishes: why shouldn't the radial electric field of the roller simply rotate around the stator so that no radial electric field would be generated?

A general model for the observed change of the effective weight change below critical velocity

A general model for the effective weight change relies on the following assumptions (in the following the units $\hbar = c = 1$ are used).

1. There are classical em and Z^0 forces present due to the approximately constant radial em and Z^0 electric fields of Earth besides the elastic force of springs with elastic constant k .
2. The inertial mass and gravitational masses of the system can change.
3. The gravitational acceleration due to the Earth's gravitational field can suffer a reduction $g \rightarrow \epsilon g$, $\epsilon \leq 1$ due to the redistribution of the gravitational flux between space-time sheets.

1. General parametrization of the model

The following set of equations represents a parametrization for this picture.

1. The em and Z^0 forces experienced by unit em and Z^0 charge per given

$$F_{em} = eE_{em} , \quad F_Z = g_Z E_Z .$$

Here g_Z corresponds to Z^0 coupling constant strength α_Z is related to the fine structure constant $\alpha_{em} = e^2/4\pi$ by

$$\alpha_Z = \frac{g_Z^2}{4\pi} = \frac{\alpha_{em}}{\sin(\theta_W)\cos(\theta_W)} , \quad \alpha_{em} \simeq \frac{1}{137} , \quad \sin^2(\theta_W) \simeq .23 . \quad (3.3.7)$$

is Z^0 coupling strength.

2. At the equilibrium height h the acceleration a vanishes, and one has

$$a = -\epsilon(f)g + \frac{Q_Z(f)g_Z E_Z + Q_{em}(f)eE_{em}}{m(f, \pm)} + \frac{kh}{m(f, \pm)} = 0 . \quad (3.3.8)$$

It is assumed that inertial mass can change in the process so that one has $m = m(f, \pm)$. This gives for the equilibrium height h the expression

$$h(f, \pm) = \epsilon(f) \frac{m(f, \pm)g}{k} \pm \frac{Q_Z(f, \pm)g_Z E_Z + Q_{em}(f, \pm)eE_{em}}{k} . \quad (3.3.9)$$

$Q_{Z/em}(f, \pm)$ refers to the absolute value of the Z^0/em charge.

If one erratically (at least in TGD Universe) assumes that only ordinary gravitational force is present, one would have

$$\begin{aligned} \frac{\Delta[m_{eff}(f, \pm)]}{m_0} &= \frac{k\Delta h(f, \pm)}{m_0 g} \\ &= \left[\epsilon(f) \frac{m(f)}{m_0} - 1 \right] \mp \frac{Q_Z(f, \pm)g_Z E_Z + Q_{em}(f, \pm)eE_{em}}{m_0 g} , \end{aligned} \quad (3.3.10)$$

2. *What information one can deduce from the graph of rotation frequency as function of relative weight change?*

Consider now what conclusions one can make from the graph of the rotation frequency f as function of relative weight change $\Delta G/G_0$ depicted in figure 1.

1. The fact that the spontaneous acceleration starts at the same value of effective weight change for both directions of rotation supports the view that the change of inertial mass is negligible, at least below the critical rotation frequency. If there is no redistribution of the gravitational flux neither below the critical frequency, one has

$$m(f, \pm) = m_0 \text{ and } \epsilon(f) = 1 \text{ for } f < f_{cr}(\pm) . \quad (3.3.11)$$

2. Below the critical mass change of ∓ 30 per cent the situation is completely symmetric in both cases unless the functions $Q_{Z/em}(f, +)$ and $Q_{Z/em}(f, -)$ are different: this cannot be the case since the critical frequencies are different. The fact that the values of critical weight changes are same means that the value of the absolute magnitude of $em+Z^0$ force are in the role of the critical quantity. On basis of the behavior of the these functions below the critical frequency, it seems safe to assume that they can be regarded as almost constant above $f_{cr}(\pm)$.
3. The observed graph of rotation frequency f as a function of $\Delta G/G$ has a step around f_{cr} which develops to a shoulder: frequency grows first rapidly whereas the weight change remains practically constant. The development of shoulder is due to the addition of a load taking the energy otherwise available for a spontaneous acceleration and generating a torque. The simplest explanation for the spontaneous acceleration involves only classical em and Z^0 Faraday effect and generalization of the ball bearing motor effect.

TGD variant of ball bearing effect

The Lorentz torque giving rise to ball bearing effect involves two contributions. The first contribution corresponds to a radial electron current moving in a radial electric field associated with rollers. Second contribution becomes from Z^0 current induced by the radial Z^0 electric field associated with the space-time sheet of the roller ring. This current consists of electrons and neutrinos. Electronic part experiences both the magnetic field of roller and Z^0 magnetic field of the roller ring.

1. *The Lorentz torque associated with the roller*

Also the electrons of the radial Ohmic current of the roller experience in magnetic field of the roller a torque in the axial direction. If the angular momentum of the roller is conserved, an opposite

torque affecting the roller itself should be generated. If the electronic current changes its direction from radial to slightly non-radial in the magnetic field (essentially Hall effect), the electrons leaking out from the roller leave it non-radially and carry out net torque so that compensating torque affects the roller system. When electrons do not leak out but are reflected back at the atomic space-time sheets the resulting current experiences torque which tends to cancel the torque. If a reflection of the current at the boundary occurs to larger space-time sheet this does not occur and a net torque results. It is convenient to introduce a parameter, call it ϵ , to characterize what part of electronic torque gives rise to a torque acting on the roller.

Using Ohm's law, one can write the torque in the form

$$\tau_{em} = \epsilon \int_{roller} j \times B dV = \epsilon \sigma_e \omega B^2 \times \frac{2\pi}{3} (r_o^3 - r_i^3) h . \quad (3.3.12)$$

where r_o and r_i are the inner radii and h the weight of the roller. ϵ is the factor telling which part of the electric torque is transformed to a torque affecting on the roller. ω refers to the rotation frequency of the roller.

If the only contribution to the torque is electromagnetic, one cannot understand the asymmetry with respect to the direction of rotation. The radial Z^0 electric field is proportional to ω^2 since Z^0 magnetic field is generated by rotation and proportional to ω and this would explain the asymmetry. The fact that em contribution must dominate in torque gives a rough estimate

$$\epsilon \sim \frac{1}{5}$$

by using a direct estimate of torque from the observation angular acceleration during the period when spontaneous acceleration occurs freely.

2. The Lorentz torque associated with the roller ring

In TGD framework the roller ring as a single system would correspond to a larger space-time sheet and the magnetic fields of rollers are not at this space-time sheet. The spinning rollers however create a Z^0 magnetic field at the space-time sheet of the roller ring and the rotation of the rollers around the stator generates a radial Z^0 electric field via Z^0 Faraday effect. If electrons feed their Z^0 electric flux to this space-time sheet, they experience the classical Z^0 force, the torque due to both magnetic and Z^0 magnetic fields as well as the ordinary dissipation. Same applies to neutrinos. If the currents in question are not able to leak out freely from the roller space-time sheet, some fraction of the torque on current carriers acts on the roller itself and induces a spontaneous acceleration. The neutrino contribution to the radial current could dominate since $Q_Z(e)$ is roughly 1/50 times smaller than $Q_Z(\nu)$.

The predicted torque can be written as

$$\begin{aligned} \tau_Z &= (\epsilon_e F_e + \epsilon_\nu F_\nu) \times r , \\ F_e &= \sigma_e \int_{roller} \frac{Q_Z(e) g_Z}{e} E_Z \times [B + Q_Z(e) B_Z] dV \\ F_\nu &= \sigma_\nu \int_{roller} Q_Z(\nu) E_Z \times Q_Z(\nu) B_Z dV . \end{aligned} \quad (3.3.13)$$

Here one has $E_Z = v \times B_Z$ and r denotes position vector from the origin of stator. The parameters $\epsilon_e < 1$ and $\epsilon_\nu < 1$ characterize the fraction of the torque on current carriers transmitted to a torque acting on the roller.

The sign of the em contribution depends on the direction of rotation whereas Z^0 contribution is of the same sign since already B_Z is proportional to the rotation velocity. Since spontaneous angular acceleration starts at different critical frequencies, τ_{em} must dominate over τ_Z , which is however present and for which the em Lorentz force acting on electron must dominate.

Electron's Z^0 coupling is by a factor $\sim 1/50$ weaker than em coupling. For $B_Z \simeq .4$ Tesla to be deduced from the model for magnetic walls the em Lorentz force dominates and gives a contribution which is of same sign for both directions of rotation. For $\epsilon_e = \epsilon$ the ratio of electromagnetic torque deduced above and Z^0 Lorentz torque would be very roughly of order

$$\frac{\tau_Z}{\tau_{em}} \sim Q_Z(e) \times \frac{r}{R} \simeq .08 .$$

where $r/R \simeq .1$ has been used. This is consistent with the difference $(f_{cr,+} - f_{cr,-})/f_{cr,+} \simeq 1/11$.

Neutrino current gives a contribution changing sign with the rotation direction and thus cannot give the dominant part to the Z^0 torque. This gives

$$\epsilon_\nu \leq \epsilon_e \frac{\sigma_e}{\sigma_\nu} \frac{Q_Z(e)eB}{Q_Z(\nu)g_Z B_Z} .$$

If neutrino conductivity scales as $\sigma_\nu/\sigma_e \simeq m_e/m_\nu \sim 5 \times 10^6$ then the estimate $\epsilon_\nu \sim 10^{-9}$ follows for $g_Z B_Z \simeq .4$ Tesla. Experimental data do not allow to deduce whether exotic neutrino current is present or not.

The voltage of $U = 20$ kV between stator and the electrodes at the outer rims of the rollers has an observable effect of order few per cent on the rotation velocity. If this situation is comparable to the discussed one, one must have

$$\epsilon_e < \frac{10^{-7}}{x} ,$$

where x is the fraction of voltage U over the roller. It is not clear from [27] whether the voltage is over distance r ($x = 1$) or $R + r$ ($x = 1/11$). This estimate is quite different order of magnitude as the estimate for $\epsilon_e \sim 1/5$ characterizing the Lorentz torque generated by the radial current in the roller. This suggests that the two situations are quite different.

This is indeed the case: the point is that both the stator and rollers are surrounded by a copper foil which acts as a Faraday cage meaning that the voltage at the surface of the foil is constant and the electric field created by 20 kV voltage does not penetrate inside. The rollers and stator behave effectively like electrodes of a capacitor.

The model for positive feedback neglecting "back reaction"

It is good to start with a model neglecting the negative feedback due to energetic constraints and indicated by the fact that 7 kW load leads to a slowing down of the system. Hence only positive feedback is present and can be modelled explicitly.

The first observation is that friction implies the presence of a torque which can be modelled in the lowest approximation as being proportional to the rotation frequency ω :

$$\tau_{fr} = Ik\omega . \quad (3.3.14)$$

Note that ω is 23 times the rotation frequency Ω of the roller and $230 \times 2\pi$ Hz for $\Omega = 10 \times 2\pi$ Hz. Assuming that the induced Z^0 magnetic field is proportional to ω , the angular acceleration can be parameterized as

$$\frac{d\omega}{dt} = \frac{\tau}{I} = P_3(\omega) = a\omega + b(\omega^2 + \frac{1}{\omega_{cr}}\omega^3) - k\omega . \quad (3.3.15)$$

Here the term $a\omega$ corresponds to a purely electromagnetic torque resulting from the radial ohmic current inside roller, the term proportional to b to the two Z^0 magnetic contributions, whereas the term $k\omega$ corresponds to the friction. Z^0 term dominates for $\omega \gg \omega_{cr}$. One can pose as a convention the conditions

$$b \geq 0 , \quad \omega_{cr} \geq 0 . \quad (3.3.16)$$

1. Qualitative behavior of the system

The qualitative behavior of the system can be deduced from quite general arguments generalizing in a straightforward manner to the more realistic case.

1. The equilibrium points (stable or unstable) correspond to the zeros

$$P_3(\omega) = \omega \left[a - k + b \left(\omega + \frac{1}{\omega_{cr}} \omega^2 \right) \right] = 0 \quad (3.3.17)$$

of the third order polynomial appearing at right hand side of Eq. 3.3.15 representing vanishing net torque.

2. The first zero is $\omega = 0$: for $a - k > 0$ this zero is unstable since Lorentz torque wins friction torque in linear approximation and the system begins to accelerate. According to Searl, his own device indeed starts to spontaneously accelerate and would thus correspond to this situation. For $a - k < 0$ friction torque wins and the system comes to rest unless the initial rotation frequency is above critical frequency. The device of Godin and Roschin corresponds to this situation. Searl's device requires that the friction is reduced sufficiently and the magnetic field is strong enough. The use of electromagnets instead of ferromagnets might allow to achieve this situation. The increase of electrical conductivity has the same effect. What is interesting is that quantum Hall effect involves increases of conductivity by thirteen orders of magnitude as the strength of the magnetic field is varied. The explanation is in terms of fusion of the magnetic flux tubes to walls at certain critical field strengths: along these current can run freely without sticking around single flux tube. Whether something similar might occur now in low temperatures in radial direction, is an interesting open question.
3. The two other zeros correspond to the roots of the second order polynomial appearing in the above equation.
- i) If the roots are real, they correspond to two critical frequencies ω_{\pm} . Suppose that the roots are of different sign: $\omega_+ > 0$ and $\omega_- < 0$. This requires $a - k < 0$. The system studied by Godin and Roschin corresponds to this kind of situation. If $|\omega| \leq |\omega_{\pm}|$ holds true the system decelerates to $\omega = 0$. The rotation with frequency ω_{\pm} does not represent a stable situation and a slight increase of the frequency above $|\omega_{\pm}|$ implies a spontaneous acceleration without limit, which represents an unrealistic feature of the model.
- ii) Roots can be also of same sign: this requires $a - k > 0$. In this case a spontaneous acceleration without limit occurs always for the other rotation direction. For the other direction it occurs without limit only above the root with a larger magnitude. In the region between ω_+ and ω_- deceleration occurs until the smaller root is achieved. Below the smaller root the system accelerates to the smaller root. Hence the rotation with the smaller rotation frequency represents a stable situation.
- iii) If the roots are complex, the system accelerates without limit for both directions of rotation. The reason is that $a - k > 0$ is necessary to achieve this situation.

2. Quantitative analysis

Consider now the quantitative analysis of the model neglecting the "back reaction". The roots of the second order polynomial correspond to an unstable motion with a constant rotational velocity and are given by

$$\omega^2 + \omega_{cr}\omega + \frac{(a-k)\omega_{cr}}{b} = 0 \quad (3.3.18)$$

This gives

$$\begin{aligned} \omega_{\pm} &= -\frac{B}{2} \pm \frac{1}{2}D \quad , \\ D &= \sqrt{B^2 - 4C} \quad , \quad B = \omega_{cr} \quad , \quad C = \frac{(a-k)\omega_{cr}}{b} \quad . \end{aligned} \quad (3.3.19)$$

There are three different cases depending on whether the discriminant $D = B^2 - 4C$ is positive or negative or zero.

$D > 0$ case

This situation corresponds to

$$a - k < \frac{b\omega_{cr}}{4} . \quad (3.3.20)$$

and means that critical frequencies ω_{\pm} are real.

Solving the differential equation in this case gives

$$\frac{\omega}{\omega(0)} \times \left[\frac{\omega - \omega_+}{\omega(0) - \omega_+} \right]^{\frac{\omega_-}{D}} \times \left[\frac{\omega - \omega_-}{\omega(0) - \omega_-} \right]^{-\frac{\omega_+}{D}} = e^{(a-k)t} . \quad (3.3.21)$$

One can distinguish between two different cases corresponding to the sign of $a - k$.

1. For $a - k < 0$ ω_+ and ω_- have different sign. The magnitude of the critical frequency is different for the two different directions of rotation as observed in the experiment of Godin and Roschin and this is due to the torque suffered by Z^0 ohmic electron current $j = \sigma_e E_Z$ in the ordinary magnetic field.

For $|\omega(0)/\omega_{\pm}| < 1$ the system decelerates to $\omega = 0$. For $|\omega(0)/\omega_{\pm}| > 1$ $|\omega|$ becomes infinite in a finite time at the limit

$$t \rightarrow t_{\infty} = \frac{1}{b(a-k)} \log \left[\frac{(\omega(0) - \omega_+)}{\omega(0)} \times \left(\frac{\omega(0) - \omega_-}{\omega(0) - \omega_+} \right)^{-\frac{\omega_-}{\omega_+ - \omega_-}} \right] \quad (3.3.22)$$

The spontaneous acceleration without limit occurs for both clockwise and counter clockwise rotation but the values of the parameter t_{∞} are slightly different:

$$t_{\infty,+} - t_{\infty,-} = \log \left[\frac{1-x}{1+x} \right] \frac{1}{b(a-k)} , \quad x = \frac{\omega_+}{|\omega(0)|} . \quad (3.3.23)$$

2. For $a - k > 0$ the roots are of same sign and smaller frequency corresponds to a stable situation to which system either accelerates or decelerates. The larger rotation frequency is unstable and an acceleration without limit occurs above it. In this kind of stationary situation friction and Lorentz torque compensate each other. For other rotation direction spontaneous acceleration without limit occurs always. This situation could correspond to Searl's device.

$D < 0$ case

This situation corresponds to

$$a - k > \frac{b\omega_{cr}}{4} . \quad (3.3.24)$$

It can occur only for $a - k > 0$. In this case the roots ω_{\pm} are complex, and one can express the solution in the form

$$\begin{aligned} \frac{1}{x} \times (X + Y) &= e^{(a-k)t} , \\ X &= \log \left[\frac{\omega}{\omega(0)} \times \left(\frac{\omega^2(0) + \omega(0)\omega_{cr} + x}{\omega^2 + \omega\omega_{cr} + x} \right)^{1/2} \right] \\ Y &= -(|\frac{D}{4}|)^{3/2} \times \left[\arctan \left[\frac{\omega + \omega_{cr}}{|\frac{D}{4}|} \right] - \arctan \left[\frac{\omega(0) + \omega_{cr}}{|\frac{D}{4}|} \right] \right] \\ x &= \frac{(a-k)\omega_{cr}}{b} , \quad D = \omega_{cr}^2 - 4x < 0 . \end{aligned} \quad (3.3.25)$$

A spontaneous acceleration without limit occurs always and $\omega = \infty$ is achieved in a finite time

$$\begin{aligned}
 t_\infty &= \log \left[\frac{1}{x} (X(\infty) + Y(\infty)) \right] , \\
 X(\infty) &= \log \left[\frac{(\omega^2(0) + \omega(0)\omega_{cr} + x)^{1/2}}{\omega(0)} \right] \\
 Y(\infty) &= -\left(\left|\frac{D}{4}\right|\right)^{3/2} \times \left[\frac{\pi}{2} - \arctan \left[\frac{\omega(0) + \omega_{cr}}{\left|\frac{D}{4}\right|} \right] \right]
 \end{aligned} \tag{3.3.26}$$

$D = 0$ case

For $D = 0$ one has $\omega_+ = \omega_-$ and an exponential acceleration without limit results:

$$\omega = \omega(0)e^{(a-k)t} . \tag{3.3.27}$$

The model discussed is certainly unrealistic. In particular, the prediction that infinite value of ω is reached in a finite time interval is non-sensible.

The model taking into account the "back reaction"

The model just described is an idealization.

1. Fast rotation would induce so strong a centrifugal force that it would overcome the mechanical constraints and the radial Lorentz force experienced by the rollers in the magnetic field of the stator. Acceleration to an infinite velocity in a finite time would require a infinitely high power feed at the limit and the effectiveness of the remote metabolism poses a restriction here. Godin and Roschin found that the load above which the system starts to decelerate is $P_{max} = 7$ kW. From this one can estimate the maximum power feed from remote metabolism to the accelerating system using the condition

$$P_{max} = I\omega_{max} \frac{d\omega}{dt} = I\omega_{max} \left[(a-k)\omega_{max} + b(\omega_{max}^2 + \frac{1}{\omega_{cr}}\omega_{max}^3) \right] \tag{3.3.28}$$

2. The negative feedback resulting from the finite efficiency of metabolism can be modelled by adding to the equation of motion negative feedback term, a kind of analog of "radiation reaction" for linear motion. The simplest guess is that the negative feedback term is proportional to the time derivative of the angular acceleration:

$$\begin{aligned}
 \tau_{fb} &= -t_0 \frac{d^2\omega}{dt} = t_0 \frac{d(\frac{d\omega}{dt})}{d\omega} \frac{d\omega}{dt} = -t_0 P_3(\omega) \frac{dP_3}{d\omega} . \\
 P_3(\omega) &= (a-k)\omega + b(\omega^2 + \frac{1}{\omega_{cr}}\omega^3) .
 \end{aligned} \tag{3.3.29}$$

The net angular acceleration can be written as

$$\frac{d\omega}{dt} = P_3(\omega) \left[1 - t_0 \frac{dP_3}{d\omega} \right] = P_3(\omega) \left[1 - (a-k)t_0 - 2bt_0\omega - \frac{3bt_0}{\omega_{cr}}\omega^2 \right] . \tag{3.3.30}$$

3. During spontaneous acceleration a load increasing in steps of 1 kW is added to the system. The simplest model for the load is as a friction term. The assumption that the torque describing the presence of load is of the form

$$\tau_L = -Ik_L\omega . \quad (3.3.31)$$

means only a modification of the friction coefficient k : $k \rightarrow k - k_L$. The power used by the load is given by

$$P_L = \tau_L\omega = Ik_L\omega^2 . \quad (3.3.32)$$

Applying this equation to the stationary situation $\omega = \omega_{1\pm}$ one can deduce the value of k_L .

$$k_L = \frac{P_L}{I\omega_{1\pm}^2} . \quad (3.3.33)$$

The resulting equations of motion are integrable. Besides the roots of $P_3(\omega)$ defining stable or unstable orbits for which the angular acceleration vanishes, the roots of $dP_2/d\omega$ define additional orbits of this kind when real. The roots are given by

$$\omega_{1\pm} = \frac{\omega_{cr}}{3} \left[\pm \sqrt{1 + 3 \times \frac{k + k_L - a + \frac{1}{t_0}}{\omega_{cr}b}} - 1 \right] \quad (3.3.34)$$

For

$$k + k_L - a \geq \frac{\omega_{cr}b}{3} - \frac{1}{t_0}$$

(in particular for $k + k_L - a > 0$) the roots are real and represent stable orbits stabilized by the negative feedback and representing asymptotic situation in the case that the system starts to spontaneously accelerate above $|\omega| > |\omega_{\pm}|$. For sufficiently small values of t_0 the condition for stable orbit is satisfied always. This condition guarantees also the physically natural condition $|\omega_{1\pm}| \geq |\omega_{\pm}|$. Also for $a - k > 0$ one expects that t_0 is for purely physical reasons so small that roots are real so that stable orbits result.

More explicitly, the equations of motions read

$$\begin{aligned} \int \frac{d\omega}{P_5(\omega)} &= \omega_{cr}t , \\ P_5(\omega) &= \frac{3b^2t_0}{a\omega_{cr}^2} \omega(\omega - \omega_+)(\omega - \omega_-)(\omega - \omega_{1+})(\omega - \omega_{1-}) \equiv A^{-1} \prod_{k=1}^5 \frac{\omega - \omega_k}{\omega_{cr}} , \\ A &= \frac{a}{3b^2\omega_{cr}^3t_0} , \end{aligned} \quad (3.3.35)$$

and give

$$\begin{aligned} A \times \log \left[\prod_{k=1}^5 \left[\frac{\omega - \omega_k}{\omega(0) - \omega_k} \right]^{c_k} \right] &= \omega_{cr}t , \\ c_k &= \prod_{l \neq k} \frac{\omega_{cr}}{\omega_k - \omega_l} . \end{aligned} \quad (3.3.36)$$

Note that one has $\sum_k c_k = 0$, which implies that the argument of logarithm approaches constant for large values of ω . Depending on the initial conditions and the sign of $k - a$ the system approaches the limit $t \rightarrow \infty$ either $\omega = \omega_{1\pm}$ or $\omega = 0$.

Catastrophe theoretic model for the dynamics of Searl device

Rene Thom's great achievement was the topological classification of different very rapid, almost discontinuous, catastrophic changes appearing in potential flow dynamics [52]. The value of the catastrophe theory is that it gives an overall view of the dynamics of a complex non-linear system. The form of equations of motion is precisely the canonical form of equations to which catastrophe theory applies as such.

The dynamics of the system can be regarded as a potential flow with the torque derived from a potential function $V(\omega)$. Taking "back reaction" into account one has

$$\begin{aligned} \frac{d\omega}{dt} &= \frac{dV(\omega)}{d\omega} , \\ V(\omega) &= \int P_3(\omega)d\omega - t_0 \frac{P_3^2}{2} , \\ P_3(\omega) &= (a - k - k_L)\omega + b\left(\omega^2 + \frac{1}{\omega_{cr}}\omega^3\right) , \\ \int P_3(\omega)d\omega &= \frac{1}{2}(a - k - k_L)\omega^2 + \frac{1}{3}b\omega^3 + \frac{1}{4}\frac{b}{\omega_{cr}}\omega^4 . \end{aligned} \quad (3.3.37)$$

The limit when the back reaction is not taken into account corresponds to the limit $t_0 = 0$. In this case the potential function is fourth order polynomial in ω and corresponds to the cusp catastrophe. In the general case the potential function is sixth order polynomial in ω so that the dynamics of the model corresponds to the butterfly catastrophe. Cusp and butterfly and swallowtail represent basic catastrophes with one behavior variable in Thom's topological classification of catastrophes [52].

1. Cusp catastrophe as a model for the system without back reaction

In order to understand the character of the butterfly catastrophe it is good to start from the cusp catastrophe which describes sudden changes in a bistable system described by a potential having the canonical form

$$V(x) = \frac{x^4}{4} - ax - b\frac{x^2}{2} .$$

There is one behavior variable x and two control parameters a, b . The system allows in the generic case three equilibrium points as roots of $dV/dx = 0$. Two of them are stable and one unstable. The illustration of the cusp catastrophe is provided by the figure 3.3.3.



Figure 3.5: Cusp catastrophe

Searl device without back-reaction would be described by the dual of the dual cusp catastrophe allowing one stable point and at most two unstable points for given values of the parameters corresponding.

The potential function $V(\omega)$ is not quite the same form as for the canonical form of the cusp catastrophe but can be transformed to it by a linear change of the behavior variable.

1. Introduce first the dimensionless variables

$$\omega \rightarrow \hat{\omega} \frac{\omega}{\omega_{cr}} , \quad t \rightarrow T = b\omega_{cr}t , \quad (3.3.38)$$

transforming the potential to a dimensionless function of a dimensionless argument

$$\begin{aligned} \frac{d\hat{\omega}}{dT} &= \frac{d\hat{V}(\hat{\omega})}{d\hat{\omega}} , \\ \hat{V}(\hat{\omega}) &= \frac{V}{b\omega_{cr}^3} = \frac{1}{2}(\hat{a} - \hat{k})\hat{\omega}^2 + \frac{1}{3}\hat{\omega}^3 + \frac{1}{4}\hat{\omega}^4 , \\ \hat{a} &= \frac{a}{b\omega_{cr}} , \quad \hat{k} = \frac{k + k_L}{b\omega_{cr}} . \end{aligned} \quad (3.3.39)$$

2. This form differs from standard form only by the fact that also $\hat{\omega}^3$ term is present and the absolute value of $\hat{\omega}$ appears in the linear term. By performing the transformation

$$\hat{\omega} \rightarrow \Omega = \hat{\omega} + 1 \quad (3.3.40)$$

this term disappears and one obtains

$$\begin{aligned} \frac{d\Omega}{dT} &= \frac{dW(\Omega)}{d\Omega} , \\ W(\Omega) &= \frac{1}{2}(\hat{a} - \hat{k})(\Omega - 1)^2 + \frac{1}{3}(\Omega - 1)^3 + \frac{1}{4}(\Omega - 1)^4 , \\ &= -A\Omega - \frac{B}{2}\Omega^2 + \frac{1}{4}\Omega^4 + \text{constant} , \\ A &= \frac{a - k - k_L}{\omega_{cr}} , \quad B = -1 - \frac{a - k - k_L}{\omega_{cr}} . \end{aligned} \quad (3.3.41)$$

This is the canonical form of the cusp catastrophe potential. In the canonical representation of the cusp catastrophe Ω is referred to as a state variable whereas A and B as control variables. A is called the normal factor and corresponds now to the external load. Its variation over a critical value in the region $B > 0$ induces a rapid catastrophic reduction of Ω . B is known as the splitting factor and corresponds now to the variable $a - k$: the catastrophe can occur only in the region $B > 0$ where the fold appears: in recent case this corresponds to the condition

$$\frac{a - k - k_L}{\omega_{cr}} < -1 . \quad (3.3.42)$$

$a - k - k_L$ is indeed negative in the experiment of Godin and Roschin.

2. Butterfly catastrophe as a model for the system with back reaction

Butterfly catastrophe has one behavior variable, which is now ω , and 4 control parameters so that the graph of the function $dV/d\omega = 0$ represents a four-dimensional surface in the 5-dimensional space spanned by ω and control parameters. Butterfly catastrophe models a situation in which there are at most three stable equilibrium points instead of two as in the case of cusp catastrophe. A typical application is a qualitative model for the sudden changes in the distribution of opinions (hawks, doves

present already for the cusp plus liberals). In the case considered the three stable situations correspond for $k + k_L - a > 0$ to $\omega = 0$ and $\omega = \omega_{1\pm}$ whereas the roots ω_{\pm} corresponds to unstable intermediate situations.

The canonical form of the potential for butterfly catastrophe is

$$V(x) = \frac{x^6}{6} - ax - b\frac{x^2}{2} - c\frac{x^3}{3} - d\frac{x^4}{4} \quad (3.3.43)$$

and one ends up to this form by performing a scaling and shift of ω in the same manner as in the case of cusp. The projections of the bifurcation set of the butterfly catastrophe to (a, b) plane for some values of parameters c and d are given in figure 16 of [52]. The most concrete representation is in terms of the behavior of the graph of a potential as a function of control parameters for which maxima correspond to unstable and minima to stable equilibria. Catastrophes correspond in this representation transformation of real roots to complex roots or vice versa.

The model predicts that in the experiment of Godin and Roschin the system should end up to a stable situation even without load (unless the system becomes mechanically unstable). The experiments of Godin and Roschin [27] demonstrate the slowing down of the system for the maximal critical load 7 kW (see figure 1) and from the maximal rotation velocity of 600 rpm. The interpretation is that the addition of the load reduces the value of $\omega_{1\pm}$ to value below 600 rpm. Slowing down is caused by the fact that the stable orbit $\omega = \omega_{1\pm}$ becomes unstable due to a fusion of the maximum ω_{\pm} and minimum $\omega_{1\pm}$ of the potential so that two real roots disappear and only 3 real roots remain and the system begins to slow down to the stable root $\omega = 0$ (possibly stabilized by the load).

The condition $\omega_{1\pm} = \omega_{\pm}$ reads as

$$\frac{1}{3} \left[\pm \sqrt{1 + 3 \times \frac{k + k_L - a + \frac{1}{t_0}}{\omega_{cr} b}} - 1 \right] = \frac{1}{2} \left[\pm \sqrt{1 + 4 \frac{k + k_L - a}{\omega_{cr} b}} - 1 \right] , \quad (3.3.44)$$

and allows to relate the parameter k_L characterizing the load to other parameters.

Time evolution of the em charge of the roller

The model predicts how the electromagnetic charge of the roller evolves in time. Suppose that the outflow of the electronic charge is proportional to the overall strength of the electric field generated by the electromagnetic Faraday effect as the the assumption that a radial Ohmic current $j = \sigma E$ is generated inside the roller. This assumption is the only one possible in single-sheeted space-time, and in TGD framework it means that the ohmic current does not flow back to the larger, non-atomic space-time sheets associated with the roller. It will be found that the assumption is unrealistic.

1. Differential equations for the charge of the roller

Since the electric field generated by em Faraday effect is proportional to ω , the general form for the differential equation governing the time development of the net em charge of the roller is

$$\frac{dQ_{em}}{dt} = a\omega(t) . \quad (3.3.45)$$

Note that ω corresponds to the rotation velocity of the roller having maximum value of about $230 \times 2\pi$ Hz.

One can solve this differential equation by transforming it to a differential equation with respect to ω giving

$$\frac{dQ_{em}}{d\omega} = a\omega \times \left(\frac{d\omega}{dt}\right)^{-1} . \quad (3.3.46)$$

a is dimensionless constant. At velocities much below the critical velocity, where external torque τ dominates, one has

$$\frac{dQ_{em}}{d\omega} = aI \frac{\omega}{\tau(t)} . \quad (3.3.47)$$

For instance, for constant torque Q_{em} would increase as ω^2 . This kind of behavior is consistent with the observed accelerating growth of the weight change (proportional to Q_{em} as a function of frequency.

Above the critical velocity one can write

$$\frac{dQ_{em}}{d\omega} = a \frac{\omega}{P(\omega)} , \quad (3.3.48)$$

where one has

$$\begin{aligned} P(\omega) &= P_3(\omega) , \text{ or} \\ P(\omega) &= P_3(\omega) \left(1 - t_0 \frac{dP_3(\omega)}{d\omega}\right) \end{aligned} \quad (3.3.49)$$

depending on whether one takes into account "back reaction" or not.

1. *Em charge for a system without "back reaction"*

For the system without "back reaction" em charge remains finite:

$$\begin{aligned} Q_{em}(\omega) &= Q_{em}(\omega(0)) + \frac{a}{b} \frac{\omega_{cr}}{\sqrt{D}} \times \log \left[\frac{(\omega - \omega_+)}{(\omega - \omega_-)} \times \frac{(\omega(0) - \omega_-)}{(\omega(0) - \omega_+)} \right] , \\ D &= \omega_+ - \omega_- = \sqrt{B^2 - 4C} . \end{aligned} \quad (3.3.50)$$

Consider first the case when the roots are real ($D > 0$). For large values of ω the charge grows with a logarithmic rate as a function of ω and approaches to a constant value. This behavior is consistent with the observed slowing down of the weight loss above critical rotation frequency. When the roots are complex ($D < 0$), one can cast the expression for the charge in the form

$$\begin{aligned} Q_{em}(\omega) &= Q_{em}(\omega(0)) + \frac{a}{b} \frac{\omega_{cr}}{\sqrt{|D|}} \times [\phi(\omega) - \phi(\omega(0))] , \\ \phi(\omega) &= 2 \times \arctan \left[\frac{\sqrt{|D|}}{2\omega - \omega_{cr}} \right] . \end{aligned} \quad (3.3.51)$$

A analogous formula applies in the case of Z^0 charge: now however Z^0 electric field is of same sign for both directions of rotation and this means that the sign of the weight change is same for both directions of rotation. This excludes Z^0 force as the dominant contributor to the effective change of weight.

3. *Em charge for a system with "back reaction"*

Above the critical rotation frequency the model taking into account the back reaction gives

$$\begin{aligned} \frac{dQ_{em}}{d\omega} &= \frac{a\omega_{cr}^2}{3b^2 t_0} \frac{1}{(\omega - \omega_+)(\omega - \omega_-)(\omega - \omega_{1+})(\omega - \omega_{1-})} \equiv A \prod_k \frac{\omega_{cr}}{\omega - \omega_k} , \\ A &= \frac{a}{3b^2 \omega_{cr}^2 t_0} . \end{aligned} \quad (3.3.52)$$

Integration gives

$$Q_{em}(\omega) = Q_{em}(\omega(0)) + A \times \log \left[\prod_k \left(\frac{\omega - \omega_k}{\omega(0) - \omega_k} \right)^{c_k} \right],$$

$$c_k = \prod_{l \neq k} \frac{\omega_{cr}}{\omega_k - \omega_l}. \quad (3.3.53)$$

Note that one has $\sum_k c_k = 0$. When the system approaches $\omega_{1\pm}$ the value of the charge becomes infinite which is an unrealistic prediction. The prediction however suggests that the loss of effective weight could overcome gravitational force.

During the spontaneous acceleration the system should approach to constant rotation velocity $\omega_{1\pm}$ fixed by the value of the load. $d\omega/dt = 0$ at $\omega_{1\pm}$ implies that $dQ/d\omega$ is infinite and the curve representing ω as function of $\Delta G/G_0$ should become horizontal. This indeed holds true in a good approximation.

4. Many-sheetedness is needed

The model cannot be correct as such. The failure of the model in both cases is that the predicted magnitude for the maximal charge outflow is by several orders of magnitudes higher than needed to explain the weight loss. The net rate of charging given by the difference of the radial currents at the outer and inner surfaces would be

$$\frac{dQ}{dt} = \sigma\pi [E(r_{out})r_{out}^2 - E(r_{in})r_{in}^2] = \sigma\pi\omega B [r_{out}^3 - r_{in}^3]. \quad (3.3.54)$$

The voltage over the individual roller ring due to Faraday effect is about .55 V for the maximum rotation frequency of about 230 Hz of the roller. From the estimate 460 μOhm for the resistance of the roller one can deduce the value of σ of neodymium as $\sigma \sim 10^3 \text{ Ohm}^{-1}\text{m}^{-1}$, the radial current would be roughly 2000 A. This current generates a net positive charge of $10^{21}e$ per second in the roller, and means a generation of 10^{-6} elementary charges per nucleon per second.

A convenient reference of comparison is provided by the ratio of $eE/m_p g$ of the electromagnetic force caused by Earth to the gravitational force in the case of proton. For the upper bound $E = 10^4$ V/m for the Earth's radial electric field at the surface of Earth the ratio is about 10^{11} and 10^9 for the lower limit of $E = 10^2$ V/m. If the em charge of the roller generated by Ohmic electron currents flowing out in the radial electric field created by Faraday effect is responsible for the change of the weight then the em charge generated per nucleon during second should be of order 10^{-10} . This fraction is by a factor 10^4 smaller than the charge implied by the Faraday effect assuming that all Ohmic current leaks out. Many-sheeted space-time concept suggests that the charge returns back to larger space-time sheets associated with the roller so that the net charge of the roller increases much slower than in single sheeted space-time. The simplest manner to model this kind of behavior is to assume that only a fraction $\epsilon \sim 10^{-4}$ of the Ohmic current leaks out from the system.

5. The effect of 20 kV voltage

For a clockwise rotation and in the presence of 20 kV voltage with output power 7 kW the rotation frequency begins to decrease at the maximum weight loss of 35 per cent from 600 rpm. The effective weight remains constant down to 400 rpm. Without voltage this is not the case. A possible interpretation consistent with the model for the em charging is that the value of em charge becomes maximal and is not appreciably affected by the reduction of the rotation velocity reducing the vacuum electric and Z^0 electric fields. This should relate somehow to the presence of the conducting copper folio around the rollers and stator carrying opposite surface charges. The presence of the folio and voltage would not allow the electrons dispersed in the environment of the rollers to readily flow back to the rollers.

The 20 kV voltage and possible accompanying Z^0 voltage would take care that the rollers remain em and Z^0 charged even when the radial electric fields generated by the rotation weaken. The gradual increase of the load in units of 1 kW reduces rotation speed in absence of 20 kV voltage but not appreciably in its presence.

Estimates for the parameters of the model

The crucial question is whether the parameters that are zero in the absence of the classical Z^0 force are large enough to allow the catastrophe theoretic interpretation. The following estimates demonstrate that this is the case if the rollers behave as Z^0 paramagnets in the sense that the small Z^0 magnetic field H_Z created by the rotational motion generates much stronger neutrino Z^0 magnetization M_Z . The parameter μ_Z defined by the condition $B_Z = H_Z + M_Z = \mu_Z H_Z$ is of order 10^{11} and this is basically due to the smallness of the neutrino mass ($m_\nu \sim 2 \times 10^{-7} m_e$).

A convenient manner to characterize the situation is to compare the ratios τ_i/I , where $i = 1, 2, 3$ refers to the component of the torque proportional to ω^i . Since the "back reaction" term does not dominate, it is enough to perform the estimates by neglecting its presence.

The moment of inertia of the roller with respect to the rotation axis is given by

$$\begin{aligned} I &= \rho_m \int \rho^2 dV = \frac{\pi}{2} \rho_m r_o^4 h (1 - x^4) , \\ x &= \frac{r_i}{r_o} \simeq 0 . \end{aligned} \quad (3.3.55)$$

Here $r_o = 3.7$ cm and $r_i = .5$ cm denote the outer and inner radii of the roller and h its height. In the following the approximation $x \simeq 0$ is used to simplify the formulas.

Consider now various contributions to the torque.

1. The purely electromagnetic contribution to the torque corresponds to the linear term in ω and is given by

$$\frac{\tau_{em}}{I} = \frac{\sigma}{\rho_m} B^2 \omega . \quad (3.3.56)$$

Note that the purely electromagnetic acceleration does not depend on the scale of the system.

2. The Z^0 Lorentz force experienced by purely electromagnetic part of electronic Ohmic current and em Lorentz force experienced by Z^0 part of electronic Ohmic current contribute torques $\tau_{em,Z}$ and $\tau_{Z,em}$ proportional to ω^2 in the approximation that Z^0 magnetic field is proportional to ω . The basic formulas are

$$\begin{aligned} \tau_{em,Z} &= \int (j_{em} \times B_Z) \times r dV , \\ \tau_{Z,em} &= \int (j_Z \times B) \times r dV , \\ j_{em} &= \sigma v \times B , \quad j_Z = \frac{g_Z Q_Z(e) \sigma}{e} v \times B_Z \end{aligned} \quad (3.3.57)$$

The Z^0 magnetizing field H_Z is created by Z^0 current

$$j_Z = n_Z \langle Q_Z \rangle g_Z v , \quad v = \omega \rho, \quad (3.3.58)$$

where n_Z is the density of average Z^0 charge $\langle Q_Z \rangle$. $H - Z$ can be deduced from $\nabla \times H_Z = j_Z$. To estimate numerically the ratios it is convenient to express n_Z as

$$n_Z = \frac{\epsilon}{a^3} ,$$

where $a = 10^{-10}$ meters defines atomic size scale. $\epsilon = 1$ would correspond to a Z^0 charge $\langle Q_Z \rangle$ per atomic volume.

Assuming Z^0 paramagnetism this gives

$$\begin{aligned} B_Z &= \mu_Z H_Z , \\ H_Z &= n_Z \langle Q_Z \rangle g_Z \omega \frac{\rho^2}{2} . \end{aligned} \quad (3.3.59)$$

Using the approximation

$$E_Z \simeq \Omega(R + r_o) B_Z = \frac{\omega}{23} \times \mu_Z H_Z \quad (3.3.60)$$

for the Z^0 electric field, one can derive the expressions for the ratios $\tau_{em,Z}/\tau_{em}$ and $\tau_{Z,em}/\tau_{em}$ at reference rotation frequency ω_0 , which can be taken to be $\omega_0 = 2\pi \times 230$ Hz. This gives

$$\begin{aligned} \frac{\tau_{em,Z}(\omega_0)}{\tau_{em}(\omega_0)} &= \frac{1}{3} \times x \times X , , \\ \frac{\tau_{Z,em}(\omega_0)}{\tau_{em,Z}(\omega_0)} &= \frac{R + r_o}{r_o} \frac{6}{5 \times 23} \simeq \frac{66}{135} , \\ x &= \frac{Q_Z(e) g_Z^2}{e} , \quad X = \mu_Z \epsilon \langle Q_Z \rangle \frac{\omega_0 r_o^2}{B a^3} . \end{aligned} \quad (3.3.61)$$

The power of the parameter

$$X = \frac{2B_Z(r_o)}{g_Z B}$$

characterizes the relative magnitudes of different powers of ω in τ . X is proportional to the parameter $\omega_0 r_o^2$, which suggests that the critical rotation frequency scales as

$$\omega_0 \propto \frac{1}{r_o^2}$$

in the scaling of the system whereas Larmor frequency would scale as $1/r_o$. This holds true if friction force is proportional to the mass of the system so that $k \propto 1/r_o^2$ holds true.

3. The electronic ω^3 contribution $\tau_{Z,Z}$ can be derived from the general formula

$$\begin{aligned} \tau_{Z,Z} &= \int (j_Z \times B_Z) \times r dV , \\ j_Z &= \frac{g_Z Q_Z(e) \sigma}{e} \times (v \times B_Z) . \end{aligned} \quad (3.3.62)$$

Also neutrinos could contribute to Ohmic Z^0 current. The fact that the critical frequencies differ by about 10 per cent for the two rotation directions means that ω^2 term must be comparable to ω^3 term. This means that the possible contribution of neutrinos cannot be much larger than the electronic contribution.

The ratios $\tau_{Z,Z}/\tau_{em}$ and $\tau_{Z,Z}/\tau_{em,Z}$ are given by

$$\begin{aligned} \frac{\tau_{Z,Z}(\omega_0)}{\tau_{em}(\omega_0)} &= \frac{1}{23 \times 7} \times \frac{R + r_o}{r_o} \times x \times X^2 , \\ \frac{t_{Z,Z}(\omega_0)}{\tau_{em,Z}(\omega_0)} &= \frac{5}{7} \times X . \end{aligned} \quad (3.3.63)$$

Consider now quantitative estimates.

1. Since the parity breaking given by ω^2 term is of order 10 per cent, the order of magnitude estimate

$$X \sim 10$$

follows and gives

$$\mu_Z \epsilon \langle Q_Z \rangle \sim 10 \frac{Ba^3}{\omega_0 r_0^2} ,$$

$$B_Z(r_0) \sim 5g_Z B .$$

Not surprisingly, the induced Z^0 magnetic field B_Z must be of the same order of magnitude as the ordinary magnetic field. Together with

$$x = \frac{Q_Z(e)g_Z^2}{e} \simeq 10^{-2}$$

this means that third order term is of order ten per cent from the linear term when the "back reaction" is not taken into account.

2. For $\mu_Z = 1$ the requirement $X \sim 10$ would give $\epsilon \sim 10^{-3}$. This is certainly an unrealistic value of Z^0 charge density since even very small strengths of the Earth's Z^0 electric field would give to large changes of effective weight. The theory of paramagnetism generalizes in a straightforward manner to the case of Z^0 paramagnetism due to the unpaired neutrino spins. Z^0 magnetization density and μ_Z in the thermal equilibrium are given by

$$\begin{aligned} M_Z &= n_\nu \tanh\left(\frac{\mu_{\nu,Z} H_Z}{T}\right) \times \mu_{\nu,Z} \simeq n_\nu \times \frac{\mu_{\nu,Z} H_Z}{T} \times \mu_{\nu,Z} , \\ \mu_Z &\simeq n_\nu \times \frac{\mu_{\nu,Z}}{T} \times \mu_{\nu,Z} , \\ \mu_{\nu,Z} &= \frac{g_Z Q_Z(\nu)}{2m_\nu} . \end{aligned} \tag{3.3.64}$$

The linear approximation holds true for $\mu_{\nu,Z} H_Z Z/T \ll 1$. From the previous estimate one has $B_Z \sim B$, which gives $\mu_{\nu,Z} H_Z/T \sim 10^{-3}$ at the room temperature. n_ν denotes the density of unpaired neutrino spins: the first guess is that there is roughly one unpaired neutrino spin per atomic volume. This would give $\mu_Z \sim 10^{11}$ and $\epsilon = 10^{-13}$. The estimate looks rather reasonable and the presence of unpaired neutrino spins might relate to the Z^0 charging of the rollers.

The condition that Z^0 charge can cause appreciable effects

One can also estimate also the amount of Z^0 charge needed to generate a weight change comparable to the electromagnetic weight change. One can deduce an expression for the Z^0 charge per nucleon (neutron or proton) by expressing the total mass as $m_0 = Nm_p$:

$$\frac{Q_Z}{N} = Q_Z(p) \frac{\Delta G}{G_0} \frac{m_p g}{g_Z Q_Z(p) E_Z} . \tag{3.3.65}$$

At the right side appears the ratio of the gravitational force to classical Z^0 force experienced by proton.

A reasonable looking lower bound for Q_Z follows from the requirement that the Z^0 electric force experienced by proton in the Earth's magnetic field is not stronger than the electric force so that one would have the constraint

$$\frac{g_Z Q_Z(p) E_Z}{m_p g} < 10^{11} .$$

The proton's Z^0 charge is $Q_Z(p) \sim 1/50$. From this a lower bound for the Z^0 charge per nucleon follows

$$\frac{Q_Z(f_{cr})}{N} = \frac{\Delta G_{cr}}{G_0} \frac{m_p g}{g_Z E_Z} > .30 \times 5 \times 10^{-10} = 1.5 \times 10^{-10} . \quad (3.3.66)$$

Roughly every tenth billionth neutron would be unscreened. The result seems rather reasonable.

To my best knowledge in the construction of Searl the rollers were not constrained in any manner to the system. The requirement that the centrifugal acceleration does not throw the rollers away gives an additional constraint to the theory. Em force or directed radially inwards could explain the stability. The stability condition reads as $mv^2/R \leq QvB$ and gives

$$\frac{Q}{N} \geq \frac{m_p f}{2\pi B} . \quad (3.3.67)$$

For $B = 1$ Tesla and $f = 10$ Hz this gives $Q/N \geq 5.6 \times 10^{-11}$. A possible interpretation for the plasma around the rotor is as electrons flown out of the rollers.

Explanation of the coronal discharge

The presence of the coronal discharge with the characteristic ozone smell around the rotor in the experiments of Roshchin and Godin [49] has pink-blue color. This suggests that the light results from atomic or molecular transitions. Gas discharge tubes and so called sprites and elves associated with certain type of lightnings exhibit also red and blue light (see [22] and TGD based model of this phenomenon in [H4]). In the case of sprites red and blue light results from the electronic excitations of N_2 molecules and blue light from the collisions of electrons or N_2 molecules exciting N_2^+ ions. Similar mechanism could be at work also now. N_2 molecules and N_2^+ ions would be ions of the surrounding air and one should understand the origin of electrons.

Unfortunately, it is quite not completely clear from [27] whether the luminescence was present only when 20 kV voltage was present. In this case one could understand the phenomenon as a dielectric breakdown. In the case that the luminescence was present also in the absence of 20 kV potential the explanation of the phenomenon should relate to the outflow of electrons from the rollers as Ohmic currents.

One can imagine several candidates for the explanation of this phenomenon and the situation is still somewhat unsettled.

1. The first and wrong guess is that the acceleration of charged particles in the radial electric field generated by the rotation alone gives them enough energy so that they can ionize the air. The energy gained by an electron moving freely in the radial electric field is $\Delta E = eB\omega\rho^2/2$. For $B = 1$ Tesla, $\rho = .1$ meters and $\omega = 20\pi/s$ this gives energy which is about .6 eV, which cannot cause ionization. When friction is taken into account, the estimate for the average kinetic energy gained between two successive collisions is $\Delta E = eEl$, where $l = 1/n\sigma$ is the free path of the charged particle in the magnet. From the estimates $\sigma \sim 10^{-20} m^2$ (geometric cross section for atom), $n_0 = 10^{30}/m^3$ for the order of magnitude of the density of the condensed matter, it is clear that the energy is quite too low to cause ionization.
2. The leakage of the electrons of the Ohmic current to the space-time sheets of environment involves dropping from atomic space-time sheets to larger space-time sheets. In this process they would liberate their zero point kinetic energy. This process would also occur only during the rapid acceleration. For an electron the dropping from the atomic space-time sheet this energy is about 1 keV so that X rays are liberated. These X rays would ionize the air and generate highly energetic electrons, which in turn make collisions with N_2 molecules and N_2^+ ions and generate electronic excitations producing the pink-blue glow. For ions the zero point kinetic

energies are below .5 eV (proton's zero point kinetic energy). This process is indeed expected to occur near the boundaries of the rolling magnets.

This process allows also the following interpretation. The time reversal involves phase conjugates of microwaves and perhaps also radiation at other wavelengths. Phase conjugate waves correspond to photons with negative energy. Therefore one might see the emission of X ray as a process in which negative energy X ray is emitted from the region containing the luminous plasma and absorbed by the electron dropping to the larger space-time sheet. The time reversed process could start already from the excitation of the molecules of air by the emission of negative energy photons and end with the emission of negative energy X ray inducing the dropping of the ion to the magnetic flux tube. This picture would conform with the claimed absorption of energy from the environment in the rotating magnetic system and the decrease of entropy. TGD indeed predicts that the second law of thermodynamics holds true only above p-adic time scale characterizing the system and that below p-adic time scale the arrow of the geometric time can change (that p-adic numbers are not well ordered conforms with this). Even the spontaneous acceleration of the rolling magnets could be interpreted as a dissipative slowing down in an appropriate time scale.

3. Godin and Roschin [27] compare the phenomenon to a high voltage microwave induced dielectric breakdown. The transversal electric fields associated with the topological light rays serving as correlates for the negative energy microwave photons emitted by the magnetostatic wave pattern could define the high voltage making possible the acceleration of electrons to kilovolt energy range so that they can ionize the surrounding air. The appearance of yellowish-white luminescent bands with distance of about roller radius 3.7 cm along the height of the roller surface have been reported and might relate to the dependence of the magnetostatic wave patterns on the vertical coordinate. The variation might relate to the local variation of the magnetostatic resonance frequency caused by the non-isotropic character of the magnetization in the vertical direction in turn causing the variation of dominant microwave frequency and the associated transversal voltage.

Critical question: Could Lorentz torque serve only as a control mechanism?

Year of two after the construction of the model above I learned that the Lorentz torque might serve as a relatively weak control action only. The point is that the magnetic field of the stator rotates with that of rollers and the fact that the magnetic flux in the rollers could correspond to the return flux of the stator magnetic field suggests this. In this kind of situation a radial current is established also in the stator. The radial ohmic currents in the stator and rollers are directed inwards/outwards or vice versa in this kind of situation so that the radial current from stator can flow to rollers. A flow equilibrium could result providing rollers and stator with opposite charges.

Lorentz torque forces the electrons to a rotational motion in both stator and rollers. If the distributions of the electronic charge density is not fully rotationally symmetric this implies an electrostatic torque which could force the rollers to a rotational motion. In this kind of situation Lorentz force would serve in the role of control knob inducing much stronger torque. The catastrophe theoretic model discussed above could still serve as a satisfactory model for the situation although originally constructed assuming that only roller magnetic fields rotate. Later a detailed model for the flow equilibrium is discussed allowing to gain some insights about the significance of the material composition of the system.

3.3.4 The role of the material composition of the system

The proposed model is certainly far from a complete description.

1. The description does not distinguish between Searl device and a much simpler rotating cylindrical magnet.
2. No consideration is given to the materials used in the device.
3. It has been also assumed that the radial ohmic current flows freely in and out from the roller. This need not be the case so that only a polarization implying no effective weight loss could occur.

The elegant experiments carried out by Samuli Penttinen (personal communications) with simpler systems involving essentially rotating cylindrical magnets has given important clues about the additional features that might be essential for the functioning of the Searl device and its modifications. Samuli also realized that the nylon layers used in the rotating magnets could serve as charge reservoirs and this could be important for the functioning of the system.

Polarization viz. net charging

The experiments with rotating magnets demonstrated that the weight loss does not occur in systems involving only single rotating magnet or several of them on top of each other. This can be understood if the system only polarizes: the radial ohmic current would gradually generate constant charge density inside the system and a compensating surface charges at the outer (and possible inner) surfaces of the rotating magnet (say cylindrical shell). What is required is net charging and flow equilibrium in which di-electric breakdown (indicated by the ozone smell) occurs continually.

Material composition of the system

Both the stator and rollers have a four-layered Titanium-iron-nylon-neodymium structure (titanium being the outermost layer) in the device of Russians. Both iron and titanium are magnetic materials and good conductors. It is however not clear why just iron and titanium should be used besides neodymium and nylon.

Consider next the possible function of the nylon layer which does not carry magnetic field.

1. Cylindrical layers made of nylon are known to be capable of developing very high polarization charges in an external electric field. Also high friction charges are generated in structures consisting of nylon.
2. Cylindrical nylon layers start to rotate if the electric field is created by oppositely charged charge-carrying structures parallel to plane orthogonal to the axis of the cylinder and at opposite sides of the cylinder and not tangential to the cylinder. The rotation is due to the net torque generated by the Coulomb interaction between induced charges and the opposite charges carried by the structures is non-vanishing. In the device of Godin and Roschin it is difficult to imagine that torque could be generated by electrostatic forces.
3. Searl believed that nylon layer serves as a kind of control gate guaranteeing continual flow of electric charge in radial direction from neodymium magnet instead of a pulsed flow. Pulsed flow might be interpreted in terms of a generation of high polarization surface charge followed by a dielectric breakdown reducing the charge to a small value after which it takes time to get back to the criticality. In flow equilibrium nylon layer would receive the radial ohmic current from neodymium and transfer it to iron. By its properties nylon could serve as a high capacity charge reservoir so that the dielectric breakdown at the surface of the roller would not lead to a dramatic reduction of the net charge and a continual criticality could be achieved.
4. Nylon is an organic material and one cannot exclude the possibility that this might be crucial for the functioning of the device. For instance, plasmoids are generated in microwave oven if one burns organic material such as match in the oven. It might be just the organic character of nylon which allows dropping of electrons to larger space-time sheets in the di-electric breakdown.

Quantum criticality

It is known that the experiments are difficult to replicate. A possible explanation is that the phenomenon is quantum critical and occurs in a narrow range of physical parameters. Quantum criticality would most naturally correspond to a criticality against dielectric breakdown involving dropping of electrons to the larger space-time sheets making possible over unity energy production. The radial ohmic current and net positive charge stabilized by nylon layer would guarantee that this situation prevails. Critical fluctuations have typically a coherence length and the generation of magnetic walls could be interpreted as critical fluctuations.

Model for flow equilibrium

In order to get a quantitative picture it is good examine explicitly what happens in flow equilibrium.

1. The conditions characterizing flow equilibrium

Assume that layers contain rotating magnetic field. As will be found, this does not necessarily require that the layer rotates. In flow equilibrium current from layer below equals to the current to layer above so that one has the conditions

$$j_{air,-} = j_{Ti,+} \quad j_{Ti,-} = j_{Fe,+} \quad j_{Fe,-} = j_{nylon,+} \quad j_{nylon,-} = j_{neod,+} \quad . \quad (3.3.68)$$

Here the subscript $+/-$ refers to the outer/inner boundary of the layer.

2. Charges in the interiors of layers and corresponding electric fields

The values of the charges generated inside the layers and the surface charges at their boundaries can be deduced from flow equilibrium conditions.

1. In equilibrium the electric field inside given layer is the sum of the rotationally generated component $E_{Fara} = \omega \rho \times B$ and the static component $E_{stat} = \lambda_{below}/\rho$ generated by the net charge in the layers below:

$$E = E_{stat} + E_{Fara} \quad . \quad (3.3.69)$$

The net static electric field due to the positive charge density generated by Faraday effect is always outwards directed and does not depend on the direction of rotation unlike the direction of E_{Fara} .

2. The positive charge per unit length in the interior is given by by

$$\lambda(t) = \int \nabla \cdot j_{Ohm} = 2\sigma_{layer} S_{layer} B \int \omega(t) dt \quad , \quad (3.3.70)$$

where $S(layer)$ is the area of the layer. For the net field $\sigma_{layer} S_{layer}$ is replaced by sum over the contributions of layers below it.

The static electric field created by a given layer is

$$E_{stat} = \frac{2}{\epsilon_0} \sigma_{layer} S_{layer} \times \frac{2B \int \omega dt}{\rho} \quad . \quad (3.3.71)$$

The charge and the field increases without limit in absence of dielectric breakdowns. Note that the ratios of static electric fields are given by the ratios of quantities $\sigma_{layer} S_{layer}$ of various layers. From the table below it is clear that iron neodymium) layer contains the highest (lowest) charge and generates the strongest (weakest) field.

This formula dictates the charges of the magnetic layers but says nothing about the charge of the nylon layer expected to act as a charge reservoir. Assuming that nylon layer contains a constant charge density, the situation is mathematically similar to that for magnetic layers but the prediction of the value of charge density in flow equilibrium would require a model predicting the maximal charge stored by the nylon layer.

3. Charges at the boundaries of layers

In flow equilibrium the ohmic current flowing from layer below equals to the ohmic current entering to the layer above. This gives

$$E_{above,-} = \frac{\sigma_{below}}{\sigma_{above}} E_{below,+} . \quad (3.3.72)$$

The subscript $+/-$ refers to the top/bottom of the layer.

The difference of the normal components of electric fields determines the density of the surface charge ρ_s accumulating at the boundary between the layers

$$\rho_s = \rho_s = \frac{E_{above,-} - E_{below,+}}{\epsilon_0} = \frac{\sigma_{below}}{\sigma_{above}} \frac{E_{below,+}}{\epsilon_0} . \quad (3.3.73)$$

The ratio of fields E_+ and E_- in a given layer is given by

$$\begin{aligned} \frac{E_+}{E_-} &= \frac{E_{stat,+} + E_{Fara,+}}{E_{stat,-} + E_{Fara,-}} \\ &= \frac{E_{stat,-} \frac{R_-}{R_+} + E_{Fara,-} \frac{R_+}{R_-}}{E_{stat,-} + E_{Fara,-}} . \end{aligned} \quad (3.3.74)$$

At the limit when the static charge of the layer is very large E_{Fara} can be neglected and one has

$$\frac{E_-}{E_+} \simeq \frac{R_+}{R_-} . \quad (3.3.75)$$

Integer ratios are obtained in the layered geometries considered.

4. Concrete application of the boundary conditions

These general conditions can be applied to deduce what happens in the flow equilibrium.

1. The conductivities of neodymium, nylon, iron, and titanium are given by the table below

material	neodymium	nylon	iron	titanium	air
$\sigma/10^{-6}\Omega m$	1.6	$(.1 - 5) \times 10^{-6}$	10	2.4	1.5×10^{-8}

2. In the flow equilibrium an electric field at neodymium-nylon boundary at radius $\rho = R_1$ satisfies the condition $E_{nylon,-}/E_{neod,+} = \sigma_{neod}/\sigma_{nylon}$, which is in the range $(0.32 - 16) \times 10^6$ so that the boundary layer contains very strong positive surface charge amplifying the net positive charge of the neodymium layer.
3. In nylon the ohmic radial current is conserved so that the static electric field in nylon decreases as $1/\rho$. Hence in nylon-iron layer at radius R_2 one has

$$\frac{E_{iron,-}}{E_{nylon,+}} = \frac{\sigma_{nylon}}{\sigma_{iron}} , \quad (3.3.76)$$

which is in the range $(.1 - 5) \times 10^{-7}$ so that a negative surface charge is generated at this layer whose magnitude is by a factor

$$\frac{\sigma_{neod}}{\sigma_{iron}} \frac{R_2}{R_1} \quad (3.3.77)$$

larger than the positive surface charge in layer below. $E_{iron,-}$ can be expressed in terms of $E_{neod,+}$.

$$E_{iron,-} = \frac{\sigma_{neod} R_1}{\sigma_{iron} R_2} E_{neod,+} \quad (3.3.78)$$

Obviously nylon layer is strongly polarized and carries very strong electric field.

4. In titanium-iron boundary one obtains

$$\begin{aligned} E_{Ti,-} &= \frac{\sigma_{iron}}{\sigma_{Ti}} E_{iron,+} \simeq 4.3 E_{iron,+} = \frac{\sigma_{iron} R_1}{\sigma_{Ti} R_2} E_{iron,-} \\ &= \frac{\sigma_{neod} R_1}{\sigma_{Ti} R_2} E_{neod,+} \end{aligned} \quad (3.3.79)$$

so that a positive charge density is generated. The ohmic current from iron is by a factor larger about 4.3 than the ohmic current entering to titanium so that a negative charge density should indeed accumulate at the iron-titanium boundary layer.

5. In titanium-air boundary the application of the continuity conditions together with the fact that the conductivity of air is about $1.5 \times 10^{-8}/Ohmm$ implies that the electric field in air is by a factor of order 10^8 stronger than in titanium layer so that a very strong positive surface charge should be generated. This positive surface charge might relate to the ionization of air caused by the electron current by the proposed mechanism. Thus it would seem that the most important boundary is titanium-air boundary.

Of course, the application of the conditions in this boundary layer might be too strong an idealization since the following estimate suggests that dielectric breakdown occurs. The Faraday field $E = vB = 2\pi fBR$ at the surface of the system containing rotating magnetic field has for $f = 10$ Hz, $R = .1$ m, $B = 1$ Tesla, the magnitude 2π V/m. This would mean that the electric field in air would be $2\pi \times 10^5$ kV/m. The electric field needed for the dielectric breakdown in air is $E \sim 3 \times 10^3$ kV/m so that the breakdown should occur for the roller system much before the maximum field strength is achieved and the proper description should be based on the notion of continual di-electric breakdown.

Two views about the functioning of the system

The magnetic fields in stator and rollers are in opposite direction. Thus the magnetic flux tubes from the stator should return back along rollers and the flux quanta associated with layers made of particular element could correspond to each other. In this kind of situation one might think that the rotation of the magnetic fields associated with the rollers forces also the magnetic field of the stator to rotate. Otherwise a twisting of the magnetic flux tubes analogous to that occurring at the convection zone of Sun occurs and a periodic process analogous to the formation of sunspots should occur as flux tubes eventually untwist.

The problem is that if the magnetic field of the roller rotates both with respect to stator- and roller axis, a twisting around roller axis still occurs. The only way out seems to be the assumption that the magnetic field associated with the roller resides at two space-time sheets.

1. The first magnetic component rotates only with respect to the stator axis and corresponds to the return flux of the stator.
2. Second component rotates with respect to the roller axis and its return flux flows along the magnetic walls and one would have also an explanation for the appearance of the magnetic walls as a return flux of a magnetic field created by dropped electrons possessing angular momentum. The electrons from the surface of the stator at almost-contact points with the rollers (at least here) would drop to the magnetic flux tubes carrying the magnetic field rotating with the roller.

Hence the formation of magnetic walls would be forced by the dropping process. The first guess would be that the gradual buildup of the walls could mean that the part of the return flux of rollers flowing through stator transforms gradually to a return flux through walls and thus minimizes the losses due to the eddy currents generated by the rotation of the return flux of rollers through stator. The return flux is however parallel to that in rollers so that the guess is wrong.

There are thus two options depending on whether stator magnetic field rotates or not.

1. Magnetic field in the stator does not rotate

Assume first that the magnetic field in the stator does not rotate.

1. Rotating magnetic layers develop a constant density of positive interior charge with a constant rate $d\rho/dt = \sigma\omega B$ by the radial ohmic current. This charge is compensated by a negative surface charge gradually cumulating to the surface of the magnetic layer unless the radial current flows to the nylon layer as in the case of Neodymium. The iron layer above the nylon layer can suck electrons from nylon.
2. The negative charge at the outer surface of a rotating roller induces an opposite polarization charge at the stator surface in the immediate vicinity of the rotating roller. A flow of electrons to the stator can occur in the resulting strong electric field so that the stator develops a negative net charge and roller a positive net charge. The charge flow between roller and stator could involve a dielectric breakdown with dropped electrons at the large space-time sheet carrying the current.
3. Stator-roller polarization does not yet lead to the effective weight loss in the Earth's electric field. This is achieved if di-electric breakdown starts to occur along the entire roller surface and induces a net charging of the stator-roller system and a negative ionization of the air. Di-electric breakdown would start to occur as the roller develops a critical positive charge. Nylon layer would guarantee that a dielectric breakdown occurs continually at the entire roller surface and the charge of the roller would have a constant value in the flow equilibrium.

2. Magnetic field in the stator rotates

If the magnetic field of the stator co-rotates, a radial current is generated also in the stator and the previous general picture applies to it. The overall radial scale of the stator is larger so that the charging rates for the magnetic layers in the stator would be higher since the areas of layers are larger. Note that the flow equilibrium at the inner surface of the stator (air-Nd boundary) would also give also non-trivial condition. An alternative option would be that a positive surface charge is generated at the inner surface.

There would be two different radial currents if magnetic field has two components at separate space-time sheets. The radial current associated with a space-time sheet rotating with stator would flow inside rollers in the radial direction with respect to rollers apart from a rotation induced by Lorentz force. The radial electronic current flowing at the space-time sheet rotating with the stator would flow inwards and would consist of dropped electrons.

These currents make possible the generation of opposite charges for the roller and stator system and electrostatic forces could guarantee the stability of the rotation of rollers against centrifugal acceleration. In fact, a very rough order of magnitude estimate for the magnetic and centripetal forces demonstrates that the orders of magnitude for the magnetic and kinetic energies of the roller should be same. Magnetic energy is however smaller by several orders of magnitude for reasonable parameter values.

Electrostatic force could induce a torque if the rotational symmetry is broken.

1. The Lorentz torque on the radial ohmic currents causes the rotation of the radial electrons around the stator and rollers in the same direction and could serve in the role of a switch inducing possibly much stronger electrostatic torque.
2. The flow of the electronic charge from the stator to roller at almost-contact points and stator-roller electrostatic interaction would induce a breaking of the rotational symmetry for the rotating charge distributions.

3. One can imagine a situation in which the roller and its electronic charge distribution rotate with the same velocity as the rotationally non-symmetric charge distribution in the stator so that the distribution of Coulomb forces and torques between charge distributions does not change and net force and torque vanish in equilibrium. The deviations from equilibrium by acceleration or slowing down would generate torque.
4. It must be however emphasized that this situation is purely classical. Rotation continues as long as one feeds rotational energy to the system to compensate for the dissipative effects. The spontaneous acceleration of the system is something very different and its energetics requires new physics.
5. In flow equilibrium there must be an electron flow from the hollow air volume inside the stator to the air volumes inside rollers and the expectation is that a closed current circuit is formed in the flow equilibrium. This mechanism would guarantee that the positive charges associated with various magnetic layers do not grow without limit. The system however loses electrons as they drop to the space-time sheet carrying the magnetic flux rotating with respect to the roller axis if the system accelerates spontaneously and the system develops a positive "visible" charge: this charge cannot grow indefinitely. One might hope that the diffusion of electrons from air could compensate for the losses so that the system could effectively act as a perpetuum mobile for some time.

More precise view about the dropping of electrons

The notion of many-sheeted space-time gets quite strong empirical support from the recent findings that nuclear reaction rates depend on the electronic environment and are highest in conductors [31, 32]. The formula explaining the enhancement of the reaction rates is based on the idea that projectile nucleus is accelerated in the Coulomb field of the electronic plasma cloud surrounding the nucleus and causing Debye screening [29, 30]. The model is however in a direct conflict with atomic physics which does not allow the description of atomic electrons below atomic radius using classical thermodynamics.

TGD reproduces the empirically verified formula for the enhancement of the reaction rates by assuming a variant of Trojan horse mechanism according to which the projectile nucleus arrives the target nucleus along a space-time sheet associated with conduction electrons and in this manner overcomes Coulomb barrier [F8]. The assumption that thermal excitations kick the projectile nucleus to the space-time sheet of the conduction electrons produces same formulas as Debye model. There is no need to ad hoc "de-quantization" of atomic physics although one must generalize it to many-sheeted space-time.

This model gives also highly welcome constraints to the model for how electrons are dropped to larger space-time sheets in rotating magnetic systems.

1. The assumption that the conduction electrons drop from "conduction space-time sheets" would explain why the magnets used must be conductors. It would however force to challenge the simple model which assumes that electrons are essentially free. The problem is that Coulombic binding energy with nuclei dominates over the kinetic energy for conduction bands. This means that in the dropping to the space-time sheet of the environment at which Coulomb interaction energy is absent, the energy of the electron would increase so that the process would require energy!
2. The most obvious resolution of the problem would be that the radial electronic current does not correspond to electrons in the ordinary conduction band but to free electrons not feeling the Coulomb attraction of the nuclei. The size of the space-time sheets in question should be atomic, that is correspond to the p-adic length scale $L(k = 137) \simeq .8$ Angstrom. Note that these sheets would be connected by thin join along boundaries bonds to a larger connected structure to make possible the flow of the current. The first thing to come in mind is that This structure directly corresponds to the atomic lattice.

This makes sense if the atomic nuclei feed their electric gauge fluxes to space-time sheets smaller than atomic space-time sheets. The Bohr radius for $n = 3$ electron orbital for Fe with $Z = 26$ is $n^2 a_0 / Z \sim .18$ Angstroms to be compared with the p-adic length scale $L(k = 131) \simeq .1$ Angstrom, so that $L(131)$ is the natural guess for the p-adic length scale associated with bound electrons.

For instance, bound atomic electrons could reside at $k = 131$ space-time sheet, conduction electrons at $k = 134 = 2 \times 67$ space time sheet ($p = 67$ is prime), and free electrons of the radial ohmic current at $k = 137$ space-time sheets receiving no electric gauge flux (electronic and nuclear fluxes compensate each other in this length scale precisely).

This picture leads to an additional condition for the model: the material used must be such that free electrons are possible at $k = 137$ space-time sheets. It also predicts that Searl device ceases to work when the free electrons have been depleted from atomic space-time sheets.

3.3.5 Magnetic fields associated with the Searl device

The magnetic fields associated with the Searl device are highly interesting. The topological quantization of the rotating magnetic and Z^0 magnetic fields might have interesting effects. The magnetic walls are not identifiable in terms of the return flux of the magnetic field of stator+roller system and their proper interpretation should be decisive for the understanding of the functioning of the system.

Magnetic fields generated by the rotating system

The magnetic field associated with the rollers rotates. Also the Earth's magnetic field is associated with a rotating system. Magnetosphere decomposes into a rotating inner magnetosphere and non-rotating outer magnetosphere. The ionic current due to the ions frozen to the magnetic flux tubes is a signature for whether the magnetic field is rotating and means in case of the inner magnetosphere the presence of ring currents. The radial electric field $E = v \times B$ is in the case of the Earth's magnetosphere of order .02 V/m and much weaker than the radial electric field of about $10^2 - 10^4$ V/cm.

This raises the question whether the rotating magnetic and Z^0 magnetic fields associated with the Searl's machine decomposes into a rotating inner magnetosphere consisting of flux tubes and the non-rotating outer magnetosphere consisting of magnetic walls. As discussed in the Appendix, the $DCP_2 \rightarrow 3$ phase transition in which the dimension of the CP_2 projection of the space-time sheets carrying magnetic field increases two to three, implies a qualitative change in the structure of the magnetic field, and might also relate to the generation of the magnetic walls.

In many-sheeted space-time it is not obvious that the magnetic fields of rollers and stator sum up coherently inside the rollers and stator. The generation of magnetostatic waves requires coherent summation and it seems natural to assume that coherent summation occurs inside stator. For rollers coherent summation is not consistent with the idea that rotation corresponds to the rotation of the vector potential defining the magnetic field.

What is the interpretation of the magnetic walls?

As already discussed, the experiments of Godin and Roschin involve also strange magnetic walls and accompanying thermal effects begin to appear at about $f = 200$ rpm at which also the effective weight change becomes detectable. The thickness of walls is about 5 cm and the distance between the walls is about .5 m which corresponds to the outer radius of the stator ring. The height of the walls is at least 12 m and the field intensity stays essentially constant up to 15 m and then weakens rapidly. The maximum value for the magnetic field strength is .05 Tesla at $f = f_{cr} = 600$ Hz. The direction of the magnetic field inside the magnetic walls is upwards. Since the stator magnetic field is directed downwards and its flux dominates over the flux of the roller fields, one could interpret magnetic walls in terms of the return flux of a topologically quantized dipole magnetic field created by the stator-rotor system.

The following observations are crucial hints concerning the formulation of the quantum level model for the spontaneous acceleration of the rollers.

1. For electron possessing only spin angular momentum the Larmor frequency $\omega_L = geB/2m_e$, $g \simeq 2$, associated with a magnetic field of 1 Tesla field corresponds to a wavelength of 2.5 cm, one half of the thickness of the magnetic walls. What looks mysterious is why the thickness of magnetic walls should be twice the Larmor wavelength.
2. The Larmor frequency for the maximal .05 Tesla magnetic field associated with walls corresponds to .6 GHz and wavelength of .5 meters, the radius of the stator. This strongly suggests that some kind of resonance mechanism is involved.

In TGD framework the strange magnetic field structures are identifiable as topological field quanta of the magnetic field somehow generated by the rotating magnetic system. Magnetic walls are present only in the rotating system so that they cannot be solely due to the dipole fields of a non-rotating system.

1. The first identification would be magnetic fields resulting in a spontaneous magnetization of a Bose-Einstein condensate of Cooper pairs of electrons associated with the space-time sheets of the magnetic walls.
2. An alternative identification would be as the flux quanta of both Z^0 and em magnetic fields associated with the rolling cylinders. For vacuum extremals Z^0 field is approximately 8 times stronger than magnetic field and of opposite sign. This would suggest that the return flux of topologically quantized Z^0 magnetic field created by the rotating rollers is in question. The predicted maximal value of Z^0 magnetic field would be about .4 Tesla for vacuum extremals.

One can discriminate between the two proposals by using the fact that the temperature is lower inside magnetic walls.

1. For vacuum extremals the magnetic energy density vanishes inside magnetic walls so that no temperature change should occur. Hence the identification in terms of Z^0 -em magnetic walls does not seem to work.
2. One could try to understand the lowering of the temperature inside the magnetic flux structures in the following manner. In ordinary hydrodynamics the condition $p + \rho v^2/2 = p_0$, where p_0 is pressure in the region where flow velocity vanishes, holds true by energy conservation along flow lines. In magneto-hydrostatics the corresponding condition reads as

$$p + \frac{B^2}{2} = p_0 = nT_0, \quad (\hbar = c = 1) . \quad (3.3.80)$$

Here p_0 and T_0 denote the pressure and temperature outside the magnetic flux tubes and the equation $p = nT$ for ideal gas has been used. The equation implies a lowering of the temperature:

$$\frac{\Delta T}{T} = -\frac{B^2}{2p_0} .$$

For a magnetic field strength of order .05 Tesla and pressure of one atmosphere (10^5 N/m^2) the estimate for the reduction is $\Delta T/T \simeq 10^{-2}$, which is one half of the reported reduction of temperature $\Delta T/T \simeq 6 \text{ K}/295 \text{ K} = .02$. The failure by a factor of two might signal the transfer of thermal energy to the roller system. For spontaneous magnetization the density of magnetic energy need not be even positive so that the thermal energy would be completely transferred to the rotating system. In any case, the order of magnitude is sensible and does not favor the presence of Z^0 magnetic field.

3.3.6 Remote energy and angular momentum transfer in rotating magnetic systems

The classical model for the spontaneous acceleration does not explain how the Lorentz torque on electron current is transformed to a torque on rollers. Neither does it explain the origin of the magnetic energy of magnetic walls.

What should one understand?

The mechanism forcing the rotor magnets to roll without slipping is easy to understand. As mentioned already earlier, the periodic deviation of the direction of magnetization from vertical with the same period for the rollers and stator makes the magnets magnetic cogwheels. This guarantees that the rollers roll rather than only rotate since the resulting magnetic torque makes slipping impossible.

The energetics behind the formation of magnetic walls and spontaneous acceleration is however far from clear. Also the generation of angular momentum of the roller should be understood.

1. The formation of magnetic walls requires energy and also the possible Bose-Einstein condensates in possible excited cyclotron energy states require also energy and one should understand the origin of this energy.
2. The proposed classical model for the spontaneous acceleration does not say anything about the detailed mechanisms for how the torque on ohmic current is transformed to a torque on the roller. If the oppositely directed magnetic fields of the stator and roller rotate in the same direction, the flow of electrons from stator to rollers at almost-contact points could break the rotational symmetry and Lorentz torque could serve as a switch inducing electrostatic torque vanishing when rollers rotate with same velocity as charge distributions in dynamical equilibrium. This model explains the rotation of the rollers if one feeds to the system rotational energy compensating for dissipative losses but does not say anything about spontaneously occurring acceleration which requires a mechanism generating an additional torque.
3. Remote metabolism or remote utilization of energy by sending negative energy phase conjugate photons to a suitable target able to absorb them is basic mechanism in TGD inspired theory of consciousness and of quantum biology and could be at work now. This mechanism could also make possible remote transfer of angular momentum.

How the Lorentz torque on ohmic current is transformed to a torque on the roller?

The proposed classical mechanism assumes that the Lorentz torque on the ohmic current is somehow transformed to a torque on the roller. The classical realization would be by the symmetry breaking mechanism already discussed leading to a situation in which rollers rotate with a constant velocity if rotational energy is feeded to compensate for the dissipative effects. For quantum level mechanism leading to the spontaneous acceleration the transfer of the electronic angular momentum to the roller would most naturally occur as the conduction electrons with net angular momentum drop to a larger space-time sheet and give their angular momentum to the roller. If the dropping is radiationless meaning that the liberated zero point kinetic energy is received by the roller, the mechanism also provides the energy needed by the accelerating motion of the roller.

The mechanism would be analogous to the mechanism in which scattered lattice electron gives part of its momentum and energy to the lattice. The first guess is that the liberated photon with energy $E \leq E_{max} = .94$ keV is absorbed by a titanium atom in the roller. If the electron drops from $k = 137$ to $k = 139$ the liberated zero point kinetic energy is from the proportionality $E_0 \propto 1/L(k)^2 \propto 2^{-k}$ given by $3E_{max}/4 \simeq .705$ eV. The nuclear charge of Ti is $Z = 22$ and electronic configuration is $3d^2 4s^2$. The binding energy is for the ground state $E(Ti, 1) \simeq 22^2 E_H = 6.5824$ keV and for $n = 3$ state $E(Ti, 3) \simeq E_{Ti}(1)/9 = .731$ keV, which is rather near to the zero point kinetic energy liberated in the dropping of conduction electron from $k = 137$ to $k = 139$ space-time sheet.

For Fe one has $Z = 26$ and the ionization energy from $n = 3$ state is 1.021 keV in the same approximation so that also iron could be considered as the outermost layer. Nd has $Z = 60$ and electronic configuration $4f^4 6s^2$ and the energy of photon emitted in $n = 4 \rightarrow 5$ transition is 1.1 keV, which seems somewhat too high. If this picture is correct then also the choice of the material in the utmost layer would be one aspect of quantum criticality and allow to understand why it is so difficult to replicate the experiments.

How the magnetic walls suck energy from the rotating magnetic system

The model is too speculative to allow any strong conclusion about whether the energy is transferred from the rotating system to the magnetic walls of vice versa. It however seems the the most elegant option is that the rotating system provides the energy for the formation of magnetic walls and for the rotation of electrons in the magnetic fields in question.

The transfer of energy could be from the rotating magnetic system to the magnetic walls if the liberated energy is due the dropping of electrons to larger space-time sheets at the boundary of the rotating system and also at the boundary of stator in the case that the corresponding magnetic field rotates. This would explain also the lowering of the temperature in the vicinity of the the system.

A straightforward estimate assuming $N = 30$ magnetic walls with height $h = 15$ m (this is only the lower bound for the height) gives for the net magnetic energy of the walls the estimate $E \sim 10^4$ kJ, which corresponds to the observed maximum power feed of 7 kW for a time interval of 10^3 seconds.

After the walls are established the dark electrons or their Cooper pairs rotating in the magnetic field of the walls would receive their energy and angular momentum by time mirror mechanism from the rotating magnetic system.

The most plausible mechanism for the formation of magnetic walls and generation of rotating Bose-Einstein condensates of dark charged particles at the walls is based on remote metabolism. The simplest option is that Cooper pairs of dark electrons at the magnetic walls suck the energy by emitting phase conjugate photons. The dropping of electrons of Ohmic currents to the space-time sheets of the environment liberating energy in keV range should serve as the primary source of energy: this would naturally occur during the di-electric breakdown.

At first it seems difficult to understand how the negative energy microwave photons from the magnetic walls could transform to negative keV photons inducing radiationless dropping of electron to a larger space-time sheet. The large value of $\hbar = n\hbar_0$, n integer [A9], suggests a solution to the problem. If one has $n = E(drop)/E(micro)$, the energy of the phase conjugate dark microwave photon equals to that inducing the dropping of the electron. What would happen is that the dark microwave photon transforms to an ordinary photon without change in energy but a reduction in wavelength.

For $E(drop) = 1$ keV and $E(micro) = .25 \times 10^{-4}$ eV corresponding to a microwave wavelength $\lambda = 5$ cm one obtains $n = 5 \times 2^{23}$ with 4 per cent accuracy. For $\lambda = .5$ m corresponding to the distance between the magnetic walls $n = 3 \times 2^{27}$ equals to $E(drop)/E(micro)$ with .1 per cent accuracy so that this option is definitely favored. Both integers define Fermat polygon (a polygon constructible using only ruler and compass) and these integers are number theoretically preferred [A9].

Since the wavelength in question should correspond to a size scale of a rotating magnetic system to achieve resonance, the quantization of \hbar and zero point kinetic energy would mean that the effect occurs only for special choices of the scales of the system. This kind of criticality would help to understand why it is so difficult to reproduce the effect and conforms with the intuitive ideas of Searl about the importance of the quantization of length scales characterizing the system.

Obviously it would be very natural for the Larmor wavelength of the magnetic field associated with the walls to correspond to the radius of the stator equal to the distance $d = .5$ m between magnetic walls. In this situation one could interpret the microwave radiation as cyclotron radiation. The original estimates based on the association of $f_c = 300$ Hz to the Earth's magnetic field $B_E = .5$ Gauss indeed led to the estimate $\lambda = .5$ m. Unfortunately, the calculations contained a systematic error since $f_c(p) = 300$ Hz corresponds to .2 Gauss: the estimate for the wavelength would become thus $\lambda = .2$ m.

The discovery of this error forced to reinterpret the effects of ELF radiation on vertebrate brain as being due to cyclotron transitions in dark magnetic field $B_d = 2B_E/5 = .2$ Gauss accompanying the Earth's magnetic field. If one assumes that magnetic walls carrying maximal ordinary magnetic field $B = .05$ Tesla are accompanied by dark magnetic walls satisfying $B_d = 2B/5$, one obtains $\lambda = .5$ m instead of .2 m. As a matter fact, this is not the first time when a calculational error seems to have a beneficial deeper purpose!

Possible other mechanisms for the remote energy and angular momentum transfer

The proposal that rotating magnetic field could receive its energy and angular momentum from the magnetic walls by time mirror mechanism turned out to be short lived. One can however imagine several mechanisms of remote energy and angular momentum transfer from rotating magnetic system to the magnetic walls besides the one already discussed, and also a mechanism of remote spontaneous magnetization emerges naturally.

1. Remote spontaneous magnetization of Bose-Einstein condensates of Cooper pairs associated with the magnetic walls could feed energy and angular momentum from rollers to walls and possibly also vice versa. Also collective cyclotron states with non-vanishing net angular momentum could be formed via this kind of angular momentum transfer. An essential element would be the conservation of energy and angular momentum and transformation of electron spin and possibly orbital angular momentum due to the rotation in the magnetic field of the wall to the angular momentum of roller.

The remote spontaneous magnetization could compensate a partial loss of roller magnetization and would be achieved by generating phase conjugate microwaves at Larmor frequency corresponding to a magnetic field of $B = .05$ Tesla with wavelength of .2 meters. The dark magnetic

field associated with the living matter in the model for the effects of ELF em fields on vertebrate brain relates to the Earth's magnetic field via the relationship $B_d = 2B_E/5$. If the dark magnetic field relates to observed maximal magnetic field by the same scaling factor, the wave length is .5 meters and corresponds to the radius of the stator magnet. If the phase conjugate microwave photons are dark with large \hbar this requires that these photons de-cohere to N ordinary phase conjugate microwave photons absorbed by the stator or rotor magnet. This looks like self assembly to single dark negative energy photon when looked in the normal direction of geometric time.

2. The generalized four-wave mechanism allows much more general standing waves than the usual theory and plasma oscillations and magnetostatic waves are ideal in this respect since their dispersion relation is such that plasma frequency does not depend on wave vector at all. Magnetostatic waves in the stator are good candidates for generating the microwave photons at wavelengths of .5 m responsible for standing wave with magnetic walls at its nodes and for spin flips inside the magnetic walls. The Larmor frequency of electron in the rollers would correspond to a wavelength equal to the thickness of the magnetic walls and the microwaves resulting in spin flips in roller magnets could be responsible for the generation of magnetic walls.
3. The Larmor frequency for the maximal .02 Tesla dark magnetic field associated with walls at critical frequency corresponds to .76 GHz and wavelength of .5 meters, the radius of the stator. Hence this magnetic field strength might relate to a microwave resonance at cyclotron frequency and with a wavelength equal the radius of the stator, and somehow providing the angular momentum needed by the system starting to accelerate spontaneously when the resonance condition for wavelength is satisfied. Lowest cyclotron transitions and spin flip transitions inside magnetic walls would have this frequency naturally and the magnetic walls would appear at the nodes of the waves.
4. What comes in mind is the presence of Bose-Einstein condensate of electronic Cooper pairs with spin $J = 2$ created above the critical frequency at the space-time sheets representing magnetic walls and possessing angular momentum opposite to the angular momentum gained by the rollers spontaneously.
 - i) The spin flips inside rollers transform part of electronic spin to the angular momentum of the roller and tend to change roller magnetization. By the stability of the spontaneously magnetized state, the effect of spin flips on magnetization of the roller is compensated by the reversals of the spin flips.
 - ii) The compensating spin flips in the roller at the Larmor frequency $f_L = 12$ GHz are accompanied by transverse magnetostatic waves in the stator. The frequency corresponds to the factor

$$\epsilon = \Phi - 1 = \frac{\sqrt{5} - 1}{2}$$

for the magnetic field $H = \epsilon M_0$ of roller inside stator. What is interesting is that Golden Mean appears. Only those regions of the stator, where this condition is satisfied contribute significantly to the spin flips and an optimal distance between rollers and stator is crucial for the mechanism to work. The spin flips are mediated by the emission of microwave photons at 12 GHz frequency.

It is interesting that Golden Mean appears also in another manner in the system. The ratio of the thickness d of the dark magnetic walls (twice the wavelength of 12 GHz microwaves) to the radius R of the stator equals to $1/10$ in a good approximation. These lengths correspond to phase increments of 2π and $2\pi/10$ for the corresponding waves. The phase increment of $2\pi/10$ relates directly to the Golden Mean by $\cos(2\pi/10) = \frac{4-\Phi}{2}$.

- iii) The change in the magnetization of the stator is compensated by spin flips and generation of orbital motion of electrons inside dark magnetic walls and now the frequency in question is .6 GHz corresponding to the wavelength .5 m. This explains why spontaneous acceleration starts at critical frequency. The correct prediction is that the magnetization directions of the rollers and magnetic walls must be same.

The Bose-Einstein condensates of Cooper pairs play a central role in the TGD inspired theory of living matter and are made possible by the many-sheeted space-time concept. Spontaneous magnetization of spin $J = 2$ Cooper pairs of electrons at the space-time sheets of the magnetic walls liberating rotational angular momentum could represent the precise mechanism of spontaneous acceleration. The emission of phase conjugate microwave photons at wavelength of .5 meters by the magnetostatic waves rotating in the stator magnet could induce the spontaneous magnetization, which corresponds to a lower energy than the non-magnetized phase.

3.3.7 Connection with the dark matter hierarchy

The discovery of years 2004-2005 was that in TGD Universe Planck constant \hbar could be dynamical and quantized and that TGD in principle predicts the spectrum of Planck constant allowing also a well-educated guess of its spectrum. A further proposal is that for a given p-adic prime there could be hierarchy of Planck constants with arbitrarily large values. These ideas have meant breakthrough in interpretational issues of TGD, and as I write this I am still working through the TGD inspired theory of living matter and consciousness armed with this new understanding.

Basic vision about dark matter hierarchy

I will not repeat the basic ideas related to the dark matter hierarchy since they are discussed thoroughly in previous chapters. Suffice it to say that the levels of dark matter hierarchy are partially characterized by a non-negative integer k_d characterizing the value of \hbar as $\hbar(k_d) = \lambda^{k_d} \hbar_0$, $\lambda \simeq 2^{11}$. Also more general values of λ are possible and λ is predicted to be integer valued [A9] with integer values $\lambda = n_F$ corresponding to Fermat polygons defined as n-polygons constructible using only ruler and compass being favored. For these values of n the quantum phase $q = \exp(i\pi/n)$ is expressible in terms of square roots of rationals. The integers n_F are expressible as products $n_F = 2^k \prod_i F_{s_i}$, where $F_s = 2^{2^s} + 1$ is Fermat prime and appears at most once in the product. $s = 0, 1, 2, 3, 4$ gives the lowest Fermat primes 3, 5, 17, 257, $2^{16} + 1$.

Large \hbar phase means that de Broglie and Compton wave lengths as well as corresponding time scales are multiplied by a factor λ^{k_d} . If particle densities are not reduced in the phase transition to the dark matter phase, the quantum sizes of particles, which correspond to sizes of space-time sheets, become so large that particles overlap. The standard criterion implies that macroscopic quantum phases become possible.

The situation in which phases k_d and $k_d + 1$ compete has interpretation in terms of quantum criticality. Poincare invariance implies that four-momentum and spin are not changed in the phase transition $\hbar \rightarrow \lambda\hbar$. This means that spin is fractionized by $1/\lambda$ factor making possible fractional spins if $\lambda\hbar$ is used as a unit. The concrete interpretation of large \hbar phases at space-time level is following. What happens that space-time sheet becomes analogous to a λ -sheeted Riemann surface defining λ -fold covering of M^4 locally. At space-time level the transition to quantum criticality would thus correspond to a single step in the transition to chaos, not by period doubling but by λ -pling (and more generally, period -pling by a harmonic or subharmonic of λ).

An important application is the quantum model for high T_c super-conductivity [J1, J2, J3]. This model predicts the basic length scales of cell (cell membrane thickness of $L(151) = 10$ nm, the thickness $L(149) = 5$ nm of single lipid layer of the cell membrane, and the over all size of cell like structure involved as $L \leq L(173) = 20 \mu$). The emerging model of bio-system as high T_c superconductor is discussed in [J1, J2, J3]. The basic prediction is that fractally scaled up variants of the cell nucleus with size scales λ^{k_d} should be fundamental for understanding of not only living matter but perhaps also the em and Z^0 interactions at the level of magnetosphere.

The energy of the cyclotron states behaves as λ^{k_d} for given B . Bose-Einstein condensates associated with cyclotron states in Earth's magnetic field $B_E = .5$ Gauss would be fundamental for bio-control and for $k_d = 4$ all ions satisfying $A \leq 223Z$ have cyclotron energy scale above the thermal threshold 86 meV at room temperature. Cyclotron frequencies are in EEG range and most bosonic ions have cyclotron frequencies in alpha band around 10 Hz. Electron cyclotron states satisfy the thermal stability criterion at room temperature even for $k_d = 3$ for B_E . For $k_d = 4$ the size of magnetic flux quanta is about 10 Earth radii so that dark matter hierarchy provides a justification for the notion of magnetic body.

Magnetic walls as reservoirs of dark energy and angular momentum?

This general picture suggests that the magnetic walls associated with the rotating magnetic system contain dark matter Bose-Einstein condensates in cyclotron states having angular momentum and that the spontaneous acceleration of the system is forced by angular momentum conservation as this Bose-Einstein condensate is formed. Since the maximal value of magnetic field is $2^{10}B_E = .05$ Tesla, cyclotron states of electron Cooper pairs are thermally stable at room temperature even for $k_d = 2$. Magnetic walls would be the counterparts of cell membranes and $k_d = 2$ for $\lambda = 2^{11}$ predicts them to have thickness of $\lambda^2 L(151) = 4$ cm whereas the experimental value is ~ 5 cm. The upper bound for the size of system consisting of magnetic walls, analogous to endoplasmic membranes inside cell, would be $\lambda^2 L(173) = 80$ m.

Magnetic walls could serve as angular momentum and energy storages if the Bose-Einstein condensation occurs to a cyclotron state carrying angular momentum. The accelerating rotating system could suck energy and angular momentum from this reservoir by time mirror mechanism which means sending of negative energy phase conjugate photons absorbed by the Bose-Einstein condensate. Note however that the accelerated rotation can be explained in terms of Lorentz torque suffered by the radial ohmic currents.

In the model of living matter $k_d = 4$ bosonic ions at magnetic flux tubes are in a key role and the cyclotron frequencies of most bosonic ions belong to alpha band around 10 Hz. It becomes possible to explain the not only the band structure of EEG but also the narrow sub-bands correctly [J3, M3]. 10 Hz frequency is the rotation frequency of rotating magnetic system and this suggests that also $k_d = 4$ for which cell membrane thickness is scaled up to about 160 km and cell size to about 10 Earth radii is involved.

Also Z^0 magnetic walls could be involved

The large parity breaking observed in rotating magnetic systems suggests that also long ranged weak fields are involved with the dynamics of Searl device. Hence one can ask whether also weakly charged dark matter could be involved. Exotic ions having both weak and em charges result when some nuclear color bonds having quark q and antiquark \bar{q} at their ends become charged $u\bar{d}$ or $d\bar{u}$ type color bonds, are possible and might be of relevance for living matter [F8, F9]. These exotic ions couple to $k_d = 1$ dark variants of $k = 113$ exotic weak bosons. These couplings would be essential for the understanding the chiral selection in living matter.

By the general considerations of [F9, J3] weak dark length scales and em dark scales correspond to each other via $k_d^W = k_d^{em} + 2$ implying $k_d^W = 4$ for rotating magnetic systems. Hence Z^0 cyclotron energies which are apart from numerical factor identical with corresponding em energies would be thermally stable at room temperature for $g_Z B_Z = eB_E$. The weak length scale deduced by scaling the Compton length of ordinary intermediate boson with $k = 89$ to $k = 113$ gives $L_W(113, k_d = 2) = .2$ μm . For $k_d = 4$ one has $L_W(113, 4) = .8$ meters, not too far from the distance .5 m between magnetic walls.

These observations suggest that the decomposition $2 + 2 = 4$ cm defining the analog of decomposition of cell membrane to lipid layers corresponds to decomposition to two 2 cm thick walls containing neutrino Cooper pair condensates with opposite angular momenta and generating Z^0 magnetic field $g_Z B_Z = eB_E$ inside the .5 meter thick wall. These walls could contain Bose-Einstein condensates of exotic O_2 and N_2 ions thermally stable at room temperature. Interestingly, for exotic O_2^+ ions the Z^0 cyclotron frequency would be in a good approximation equal to 10 Hz.

Is dark matter formed in the air between stator-roller interface?

If stator magnetic field rotates, the situation becomes especially interesting in the small air gap between roller and stator since the electron currents coming from the stator could be transferred to the roller and since very high positive surface charge densities could result in the air gap.

Dark matter identified as a phase with a large value of Planck constant [A9] is in a fundamental role in the TGD based model of living matter [J6, F9, M3]. The formation of large magnetic flux quanta suggests quantum criticality implying a large value of Planck constant so that one can wonder whether some form of dark matter could be formed in this region.

An especially interesting candidate for dark matter corresponds to a phase with a large value of $\hbar = N\hbar_0$ and dark space-time sheets define N -fold coverings of Minkowski space factor of the

imbedding space $H = M^4 \times CP_2$ [A9]. The so called N-atoms, in particular N-hydrogen atoms, discussed in [J6, F9] correspond to N-fold coverings and can contain up to N electrons in same state since each sheet of the covering can contain electron with same quantum numbers. It is possible that only valence electrons end up to this state. TGD based model for hydrogen bond and bio-catalysis is as a dark N-atom with maximum number $n = N = 2^{11} = 2048$ of electrons in identical state. Active sites where hydrogen bonds can be formed in turn correspond to $n < N$ and the formation of the bond means a fusion of "half hydrogen bonds" with k and $N - k$ dark electrons.

The formation of N-atoms requires a high density of electrons. The air in the rotor-stator interface where electron currents running in opposite directions meet could indeed lead to high enough densities of electrons which could form dark N-atoms with the atoms of the ionized air.

3.3.8 Discussion

Searl machine seems to be unique in the sense that physical constraints pose strong limitations on the possible scaling of the system. The effects exhibited by Searl machine might be important for the functioning of the living matter and even in systems like tornadoes.

About the basic construction and its modifications

The basic construction deserves some comments.

1. Optimization

According to the proposed dynamical model of the Searl machine, the optimal situation corresponds to a rotation starting spontaneously at rest or almost at rest. This requires that the purely electromagnetic Lorentz torque wins the friction torque. The minimization of friction torque and the maximization of magnetic field strength could help here. Electromagnets might allow to achieve field strengths considerably above 1 Tesla.

Since Lorentz torque is proportional to conductivity, the maximization of conductivity provides a promising approach to the optimization of the effect. The Lorentz torque is generated by Hall effect. Quantum Hall effect (QHE) is studied in temperatures for which thermal energy is of order of electron's Larmor energy $E_e = eB/2m_e \simeq 1$ K for $B = 1$ Tesla. QHE involves an enormous increase of the conductivity (up to 13 orders of magnitude!) at certain critical value ranges of the magnetic field in the range of field strengths varying from 1 Tesla to 30 Tesla (see the figure 1.2 of [35]).

This raises the hope that QHE might allow to build small spontaneously accelerating magnetic systems with enormous Lorentz torque as compared to that observed at high temperatures. The dynamics of topologically rotating magnetic field of rotor would play a key role since the increases of the conductivity would in TGD Universe relate to the formation of magnetic walls [E9]. By the quantization of the magnetic flux the increase of the magnetic field strength means on one hand the reduction of the flux tube radius and the increase of the number of flux tubes on the other hand, and can lead to a partial fusion of the flux tubes at certain critical field strengths giving rise to highly conducting magnetic walls. If these walls are formed in the radial direction, large radial electron current becomes possible.

Quantum criticality is a prerequisite for the existence of the effects and hence also crucial for the optimization. In particular, the size scales of the system are important since the dark microwave photons from the magnetic flux walls must have wavelength of order system size in order to achieve a resonant absorption. This wavelength corresponds also to the separation between magnetic walls. The energy of dark microwave photons must correspond to the increment of the zero point kinetic energy of dropped electron, and the fact that only certain values of quantized Planck constant seem to be favored, poses additional constraints. Furthermore, the ionization energy of valence electron of the atom in the uppermost layer must correspond to the increment of the zero point kinetic energy of electron poses conditions on the selection of the material.

2. Testing

For testing purposes modular structure of rollers and stator allowing to vary the geometric parameters would be highly desirable. The use of electromagnets would allow to test the effect of field strength. In particular, one could see whether the thickness of magnetic walls corresponds to twice the wavelength defined by the Larmor frequency of electron. The use of vertical electric field would

allow to test whether it is indeed electric field of Earth which is responsible for the dominant part of the effective weight change.

The rotation of rollers should generate also Z^0 magnetic field. Radio active decay rates are reported to change near the Searl effect generator. Long range classical Z^0 field affects weak interactions and thus also the radio active decay rates. Effects are similar to the effects caused by a classical background em field and give rise to corrections, which are of order $\alpha_Z Z^2/m_\nu^4$, where Z is essentially Z^0 field strength at the position of the decaying nucleus. If classical Z^0 field has strength at least of order $1/L(169)^2$, $L(169) \simeq 5$ micrometers, the effect is significant. What happens that in a Feynman diagram describing the decay of d quark to u quark by the emission of virtual W boson decaying to electron and neutrino, the neutrino interacts with the classical Z^0 field in the final state. Recall that classical Z^0 field explains also the dependence of the effect on the direction of rotation although also the spontaneous parity breaking caused by the generation of the radial electric field could also explain this effect. The systematic study of the radio active decay rates obviously provides a clear-cut test for whether classical Z^0 fields and even W fields are present.

3. *Is it possible to scale down the magnetic system?*

The construction used in the experiments of Godin and Roschin is rather massive and one might ask whether it is possible to use constructions having a smaller size.

The scaling should respect both length scale ratios and frequency ratios. Furthermore the length scale associated with the Larmor frequency of electron should be scaled also. This means that the scaling of dimension down by a factor x requires a scaling of a magnetic field by a factor $1/x$. Already Russians use rare Earth magnet Neodymium [28] with a magnetic field of 1 Tesla which seems to be maximal field allowed by condensed matter properties. This seems to exclude the scaling downwards.

The critical frequency for the clockwise (counter clockwise) rotation is 9 (10) Hz. The no-new-physics explanation is as the frequency above which magnetic torque becomes larger than the friction torque and spontaneous acceleration becomes possible. In TGD based model for brain ELF frequencies in EEG range play a fundamental role and one cannot exclude that also now phase conjugate ELF waves are involved and the criticality also in this sense holds true. An imaginative explanation for the known experimenter dependence of the Searl effect and over unity phenomena in general would be that part of the energy is sucked from the brain or body of the experimenter having strong desire that the device works!

Be it as it may, 10 Hz is a fundamental p-adic frequency serving as clock in living matter as well as a resonance frequency for oscillations inside the cavity defined by the ionosphere (not the same as Schumann frequency). Furthermore, Z^0 cyclotron frequencies vary in the range 9 – 10 Hz in Earth's Z^0 magnetic field estimated to be 16 times weaker than the ordinary magnetic field of Earth. One cannot exclude the possibility that the phenomenon involves ELF fields in an essential manner and therefore length scales of order Earth size defined by the corresponding wave lengths. This would also fix the frequency scale to that used in the experiments of Russians and only fine tuning could be considered.

Rollers have radius of about 3.7 cm and one could of course imagine of modifying the stator by replacing it by a smaller structure. Russians do not give justification for why the ratio R/r of the radii of the stator and rollers should be integer not smaller than 12 by the requirement of a magnetostatic resonance. Already for $R = r$ 6 rollers are possible and for $R = 2r$ 9 rollers are possible. This might provide a possibility of downwards scaling.

4. *Could one simplify the basic system?*

The natural question is whether one could simplify Searl device. There are indeed several variants of rotating magnetic systems claimed to be over unity systems (Jean- Louis Naudin's homepage [29] contains a lot of material about these devices). The simplest possible device of this kind would involve only rotor and stator disks which lay in parallel over each other and have same symmetry axis. Magnetization would be orthogonal to the disks and the use of several stator disks would help to achieve more intense magnetic field inside rotor disk. Rotor disk could also reside between stator disks. In this case only purely electromagnetic Lorentz force would be present and if Lorentz torque is large enough to win the friction torque the system should start to rotate spontaneously. No directional asymmetry would be present since the Z^0 magnetic field created by the rotor disk is not rotating Z^0 . A working device of this kind is indeed claimed to exist and the rotation is indeed reported to start spontaneously [36]. The company Perendev Power Developments Inc. of the inventor Michael

J. Brady is reported to have started manufacturing of a unit producing a power of 20 kW.

Searl effect and bio-control

The model of Searl effect is based on essentially the same mechanisms as applied in the quantum models for homeostasis and remote mental interactions [K5, K6].

Strong parity breaking implied by the Z^0 magnetization and the crucial role of neutrinos is the first common aspect. In living matter the key mechanism is the remote quantum entanglement having as a space-time correlate low frequency MEs, and self-organization induced by the high frequency MEs by inducing bridges between, say, magnetic flux tubes and atomic space-time sheets. In particular, the notion of magnetic body is of absolute essential for the model and has astrophysical size. In the case of Searl machine magnetic walls play the role of the magnetic body. This inspires the questions whether living matter utilize Searl effect routinely so that the model for the generation of magnetic walls might be applied also to model the generation of the magnetic body in living matter.

I have proposed in [H9] that time reversal is the basic mechanism of healing. The biological programs simply run backwards to the point, where the error occurred, and a new trial is made. De-differentiation is the counterpart of this mechanism at the cellular level. Stem cells are indeed increasingly used for healing purposes, leucemia being one example of this. The model of Priore's machine [24, 25] is based on this idea and involves phase conjugates of microwaves perhaps inducing time reversal mode of molecular machines at DNA level and thus leading to the correction of the genetic error responsible for the cancer. Irradiation by phase conjugate microwaves at critical frequencies might induce the time reversed mode and thus provide a possible general healing mechanism affecting directly the DNA level.

These observations suggest that various molecular machines such as $F_0 - F_1$ machine responsible for the metabolism (and its variants suggests by the many-sheeted space-time concept) might at least in their time reversed mode induce time reversals of biological programs and thus healing. The generation of negative energy MEs would induce bound state entanglement and the liberated binding energy would compensate the lack of the metabolic energy feed during the time reversed mode. They could also induce anti-gravitational effects, which together with the macroscopic quantum coherence induced by negative energy MEs, could be an essential aspect of the locomotion of the living organism. Molecules, which have temporarily got partially rid of effective weight would be ideal for the catalysis in the many-sheeted space-time..

One can thus ask whether some molecular machines are actually Searl machines, at least in their time reversed mode. For instance, the $F_0 - F_1$ machine driving protons to atomic space-time sheet from (presumably) magnetic flux tubes of Earth, is much like a power plant containing a rotating shaft. In time reversed mode, in which it acts like a motor, the shaft might have reduced weight. The parity breaking effect induced by the classical Z^0 force would also favor second direction for rotation, this is obviously essential in order to achieve a synchronous action.

A further interesting aspect is that the presence of ELF waves at 10 Hz defining a fundamental bio-rhythm implied by rotation means that the interaction with the body and brain of the experimenter might interfere with the experiment. The importance of the experimenter's intention would conform with the finding that free energy effects are not fully re-producible. This only adds to the fascination of these effects if one is ready to give up the reductionist and materialistic dogmas and accept the possibility of remote mental interactions. Of course, the possibility of this remote mental interaction in bodily length scales would be absolutely essential for the possibility to realize intention by using molecular machines.

Could tornadoes involve Searl effect?

For a rotating vortex in water or air an analogous mechanism might work and so that the rotating vortex would begin to accelerate. Elastic force is essential in the previous example and in case of water or air pressure should provide its counterpart. One might think that the water or air in the vortex expands upwards since the gravitational force pressing the liquid downwards is reduced and pressure remains the same unless temperature is changed. Tornadoes might involve this mechanism. Usually the reduction of the pressure in the core of the tornado is believed to cause its destructive effects but the reduction of the effective gravitational force due to the Z^0 and em charging might

be also involved. The observed light phenomena associated with tornadoes support the presence of plasma phase due to the Faraday effect forcing the flow of electrons from the interior of vortex.

Hydrodynamical vortices contain typically smaller vortices and one might consider the possibility that the tornado contains at its outer boundary smaller mini tornadoes playing the role of rollers whereas the central vortex would give rise to a non-rotating Z^0 magnetic field and would act as a stator. Z^0 magneto-static waves in air would replace magneto-static waves as a mechanism of remote metabolism. Larmor frequency would be now the Larmor frequency of neutrinos in the Z^0 magnetic field generated by the tornado. Since neutrino mass is about 5×10^6 times smaller than electron charge, quite high frequencies are possible. The generation of vacuum extremals would guarantee the coupling of Z^0 fields to em fields and therefore the generation of negative energy photons crucial for the remote metabolism. As noticed, the tornadoes can be accompanied also by emission of visible light. Perhaps this is both due to the remote metabolism and the presence of plasma resulting in the rotation of a magnetized structure. The temperatures of air can be as low as -80 C in the space above tornadoes [49], which also suggests the presence of time mirror mechanism of energy metabolism and reversal of geometric arrow of time.

It should be noticed (thanks for Juha Hartikka for proposing this), that one could understand Podkletnov effect if a part of the volume above the rotating super-conductor belongs to the space-time sheet of the rotating super-conductor. Matter at this space-time sheet would lose part of its gravitational mass. The resulting incomplete cancellation of the pressure gradient and gravitational force would also explain why the air above the system started to flow upwards.

3.4 Effects related to Searl effect

N-machine of dePalma and and space-energy generator of Tewari represent situations in which the basic mechanisms underlying Searl effect seem to be involved. Also anomalies associated with spinning systems such as gyroscopes could have explanation in terms of Searl effect.

3.4.1 N-machine of DePalma and space-energy generator of Tewari

The experiments of Faraday related to a rotation of cylindrical magnet with conductor disk attached rigidly on its top, are not well known to average physicist [39]. The outcome these experiments was that radial electric field is generated between the rim and axis of the rotating conducting disk. This effect does not follow from Faraday's law of induction and is not satisfactorily understood in Maxwell's electrodynamics and it is somewhat surprising that Faraday's experiment has not received more attention.

DePalma [38] has repeated the experiments of Faraday and he claims that so called N-machine (DePalma generator), which is basically conducting disk attached rigidly to a cylindrical magnet and rotated using external power input, transforms mechanical energy to electric energy with efficiency larger than one (out put power is larger than input power!). Perpetuum mobile is not in question: rather, the claim is that there is some unknown form of energy, which is transformed to electric energy. Indian physicist Tewari [39] has replicated DePalma's results and constructed what he calls space power generator: N-machines are fabricated commercially in Japan.

Consider now the possible working principle behind N-machine (De Palma generator) [38]. space energy generator of Tewari [39].

When one extracts electric energy from a system consisting of a rotating magnet with conductor disk attached to it, the electric field tends to dissipate. The possibility to generate new vacuum charge however compensates this energy and the ratio of output power to input power can quite well be larger than one.

The model of N-machine and space-energy generator relies on simple observations about rotating magnetic systems. The radial ohmic current induced by the radial electric field having non-vanishing vacuum charge density implies a continual charging of the system. This implies that system gains high Coulombic energy and eventually di-electric breakdown occurs. The simplest manner to extract energy from the system is to connect the system with ground via a load so that the charge can flow through it and di-electric breakdown is avoided.

The energy needed for the charging must come from somewhere and the model for Searl device suggests that the energy is extracted from magnetic walls containing dark matter by sending negative

energy phase conjugate (dark) photons absorbed by the dark particles in the wall. The dropping of charges to larger space-time sheets liberating zero point kinetic energy could be the ultimate source of energy. The process cannot continue indefinitely in the absence of energy feed kicking the charges back. In living matter the solar energy feed would take care of this.

One could of course ask whether the generation of negative energy space-time sheets could provide a manner to generate energy indefinitely. Probably this is not the case, since it is essential the negative energy space-time sheets represents phase conjugate bosons which are absorbed by some system. The absorption occurs with a large rate if the absorbing system is analogous to a population inverted laser and cannot thus continue indefinitely unless there is continual external energy feed, such as solar radiation, regenerating the population inversion. What this mechanism however makes possible is nonlocal utilization of energy. For instance, there is no need for a rocket to carry its fuel since the generation of phase conjugate radiation interacting very weakly with positive energy matter would make possible remote use of energy.

3.4.2 Some anomalies related to the behavior of spinning systems

The discussion of the anomalies related to spinning bodies described in [41, 42] turned out to have extremely fruitful impact to the challenge of anchoring the concept of the classical Z^0 field to experimental reality. These anomalies have also a close connection with those exhibited in the behavior Searl device.

Anomalies in spin-spin interaction of spin polarized nuclei

As a result of various experimental and theoretical studies [44, 45, 46, 47] spin-spin interaction of spin polarized nuclei with spin polarized nuclear targets and distant correlations of nuclear spin states were discovered and investigated. These interactions were called "pseudo-magnetism" and the clear understanding of the underlying mechanism was lacking. Since TGD predicts that nuclei can have anomalous Z^0 charges giving rise to interactions in the weak length scale L_w of order atomic length scale [F8], the identification of pseudo-magnetism as a manifestation of classical Z^0 magnetism suggests itself since TGD.

There are well established effects described in the article by Krisch in New Scientist 1979 [48] and related to the scattering of protons on protons, which according to [41, 42] are hard to understand in the standard physics framework. The hard inelastic large angle scattering rate for parallel spins is roughly by a factor 4 larger than the rate for antiparallel spins.

A possible explanation is based on classical magnetic and Z^0 magnetic fields, which are in good approximation dipole fields. These fields would be present if the topological condensation of also proton involves the formation of quark pair corresponding to sea quark/antiquark with p-adic length scale $L(107)$ and exotic anti-quark/quark with length scale $L(127)$ so that also topologically condensed proton, or better to say "H nucleus", is accompanied by color and electro-weak field body represented by a (possibly branched) loop (structure) of size of order atomic radius.

Exotic quark and antiquark would have opposite spins and would be connected by magnetic and Z^0 magnetic flux tubes defining their magnetic bodies. Parallel spins give rise to magnetic dipole moments and parallel/opposite magnetic moments attract/repel each other when on same line. The interaction would be due to the *genuinely* classical magnetic and Z^0 magnetic flux tube structures connecting exotic quark and its anti-quark. This implies that large angle scatterings in which quarks scatter from each other, are more probable for parallel configuration of spins than for antiparallel configuration. If this explanation has some correlation with reality, these effects could be seen as a direct signature of topological condensation implying the formation of parton pairs associated with # contacts and also as an empirical support for the notion field body.

Anomalies in the motion of spinning gyroscopes

There are large number of reports about anomalous effects related to gyroscopes and gyroscopic systems. Variations of the weight of the gyroscope depending on the angular velocity and direction of spinning are reported [38, 43, 40]. According to [42] the effect is achieved only when gyroscope is subjected to a non-stationary rotation: on the other hand the experiment of [40] seems to be based on

the spinning of gyroscope without nutation. In TGD context non-stationarity means that Z^0 magnetic field is not static anymore and induces Z^0 electric field by Faraday's law.

Consider as an example the experiment of [40]. A rotating gyroscope with the direction of angular velocity same or opposite to that of local gravitational field is studied. The reduction of the weight is reported to be a fraction of about 10^{-5} of the total weight and present for right handed rotation only.

The model for Searl effect could explain this effect although the fact that gyroscope is not magnetized means that the model cannot be identical with that for Searl device.

1. The correlation with the direction of angular velocity is observed also in the case of Searl device and serves as a signature of the importance of classical Z^0 magnetism. The range of Z^0 force is given by the p-adic length scale of dark weak bosons involved. p-Adic fractality suggests that the density of dark Z^0 charge (and also other dark charges) scales as $1/L^3(k)$ so that above cell length scale the effects due to the dark weak interaction are expected to be weaker than those assignable to gravitation [G1]. Hence Z^0 magnetism need not give rise to the dominant effect.
2. The dark version of the ordinary nuclear magnetism due to the net spin associated with exotic quarks pairs at the ends of color bonds connecting nucleons [F8] could however give rise to long ranged magnetism. In the recent case it could be the dominant effect inducing dark em charging of the device and apparent antigravity effect in the Earth's electric field.

3.5 Project Flyaway and Searl effect

Marcus Hollingshead has developed a very interesting antigravity device. Unfortunately, there is no published reports about the device, and my information derives only from the email discussions in Antigravity discussion group [37]. There has been also a heated debate about the claims of Hollingshead. I am grateful for Adrian Panait for generously providing this information. Also the information received from Tim Ventura was very useful. In the following I try to understand the device on basis of TGD based model for the Searl machine and the so called time mirror mechanism playing a key role in TGD inspired theory of consciousness and of bio-matter.

3.5.1 Description of the device

First a brief description of the device as I have understood by reading the emails. It must be emphasized that these descriptions are highly informal and the only reason that I take them seriously is that the claimed effects resemble those assigned with Searl device.

1. The device consists of six toroidal electromagnets. There is a pair of toroids along each coordinate axes at the opposite sides of the origin and linked around origin. Somewhat like figure eights along each coordinate axis: toroids are however disjoint and free to spin around their own symmetry axis (like a bicycle wheel).
2. The toroids have a steel core surrounded by a "bi-filar" winding carrying alternating currents. According to Marcus Hollingshead: "One winding is pulsed +ve/-ve the other -ve/+ve offset by 90° ". Neither the frequency of the pulsing nor the duration of the pulse are reported but one might guess that the time scale is longer than the time scale defined by $\tau = 2\pi\sqrt{LC}$, where L is the inductance of the second half of the bi-filar coil and C the capacitance of the entire bi-filar coil. What is clear that the pulsing generates alternating magnetic field inside the toroid.
3. Along the inner surface of each toroid there are 12 smaller toroids in the plane tangential to the toroidal surface. These toroids are also pulsed. The details about how the pulsing depends on the position with respect to rp are not provided.
4. At the origin there is a charged ball, called reference point (rp). The sign of the charge is relevant for the functioning of the system.
5. During the functioning of the device the large toroids spin around and above the rotation frequency of about 70 Hz weight loss and other effects are reported to appear. The system is reported to loose part of its inertia. During the functioning of the device the temperature in

rp and its surroundings is lowered to about 100 Kelvins. The system repulses objects around the system if held at a fixed position. Also the loss of the reflected light from rp occurs and a spherical vacuum of diameter 2.2 meters is generated. The device is contained by a cube of side of length shorter than 1 meter so that the size of the vacuum region is larger than the size of the device.

3.5.2 About the bi-filar coils

The characteristic feature of bi-filar coils is that the current returns from the end of the coil and flows through the coil again but rotates in opposite direction. In a stationary situation the ohmic currents flowing in opposite directions around the toroid create magnetic fields cancelling each other in a good approximation. In the recent situation one has however square pulses and for long enough square pulses the magnetic field is present as a transient phenomenon at the beginning and the end of the pulse.

Circuit equations give a good grasp on the situation. In circuit equations inductance corresponds to mass, resistance to a friction force proportional to velocity, and inverse capacitance to a harmonic force. Current corresponds to the position coordinate of the oscillator. Bi-filar coil can be compared to a mechanical system whose mass increases from zero to a maximum value (current has propagated to half way along the coil), drops back to zero in time reversed manner, remains zero for a period determined by the duration of the long enough pulse, and then again raises to maximum and drops back to zero. The increase and reduction of the mass occur with a constant rate in the ideal situation.

If the duration of the pulse is long as compared to the time constant $\tau = 1/f = 2\pi\sqrt{LC}$ of the circuit, the situation is adiabatic except in the beginning and the end of the pulse. This means that during the initial and final transients the frequency $\omega = 1/\sqrt{LC}$ of the circuit decreases slowly from a very large value to minimum and increases then back until adiabatic approximation fails. During the middle period when inductance vanishes the system is characterized by its resistance and capacitance and the current decays exponentially with the time constant $\tau = RC$. It is plausible that a radiation in a wide range of frequencies is generated during the transients since the mechanical counterpart of the system is harmonic oscillator whose frequency is varied slowly.

A detailed model for what happens discussed in [K1] predicts that $\tau = RC$ gives an upper cutoff for the frequencies emitted (as one expects on basis of the fact that the cutoff must relate to dissipation and second law). TGD however suggests that the generation of negative energy topological light rays leads to a reduction of the resistance since charge carriers are dropped to larger space-time sheets via the emission of negative energy photons. This raises the upper cut-off frequency and even visible light might be emitted.

During the transients the magnetic field which increases (decreases) linearly as a function of time at the first (second) half of the pulse, and generates a rotational electric field in the direction of the wire of the winding. At the middle of the coil the constant electric field along coil changes its direction. For long enough pulses the rotational electric field drops to zero during the periods when the entire coil is filled by the ohmic current. The displacement current caused by the discontinuous change of the rotational electric field could induce a sharp magnetic pulse in the direction of the toroid's axis unless vacuum currents possible in TGD Universe (see below) compensate it.

Sharp unipolar pulses appear again and again in various free energy technologies inspired by Tesla's discoveries. This forces ask what is so special in sharp unipolar pulses. If one accepts the time mirror mechanism as a manner to amplify negative energy signal to a much stronger positive energy signal, the question transforms to a question how sharp unipolar pulses are able to generate negative energy topological light rays.

The answer comes from the observation that the generation of negative energy topological light rays breaks the second law of thermodynamics in some relevant length and time scale. On the other hand, TGD forces a more precise formulation of the second law. Second law at a space-time sheet characterized by a given p-adic prime and having thus size given by the corresponding primary or possibly n-ary p-adic length scale holds true only above the corresponding p-adic time scale. Thus if one is able to generate field patterns having a duration shorter than the p-adic time scale in question, breaking of the second law results. In particular, negative energy topological light rays are generated.

In the case of a unipolar pulse the transients at the end points of the pulse are time reversals of each other since electric field grows/decreases at the end points. The transients at the endpoints of the pulse in turn decompose into two parts corresponding to a growing magnetic flux followed by its

time reversal. For electric field transients in a good approximation correspond to a rotational electric field which is constant inside the wires followed by its negative when half of the coil is filled by the current. Thus the relevant p-adic time scale must be longer than the transient time in the beginning of the pulse. Two different p-adic time scales might be involved.

What is essential is that charge carriers are accelerated or decelerated during the sharp electric pulses. Deceleration involves a loss of energy by the emission of brehmstrahlung as positive energy photons and acceleration a gain of energy by the emission of negative energy photons. The mechanism works in the case of any pulsed system.

1. In the case of ordinary coils the emission of negative energy photons occurs during the acceleration of the charge carriers at the initial transient of the voltage pulse giving rise to constant electric field. If the duration of the pulse is long enough, charges dissipate their energy and also the second transient at the end of the pulse gives rise to similar emission of negative energy photons.
2. In case of a bi-filar coil the emission of negative energy photons occurs also during the second half of the magnetic pulse when system is in accelerating phase. Therefore there are two time scales involved corresponding to magnetic and electric pulses.

The emission of negative energy photons could involve generation of standing magnetostatic waves in the core of the bifilar coil caused by the currents flowing in opposite directions. The wavelength of the standing wave would correspond to the distance between the wires of the bifilar coil. This suggest that basically same mechanism of remote metabolism is involved as in the case of Searl machine. It is not clear what the intensity of the magnetic fields involved is. The scaling law of homeopathy relates in the case of Searl device 230 Hz frequency to 12 GHz Larmor frequency. Something like this is expected also now.

3.5.3 Trying to explain the claimed effects

It is of interest to compare the system to Searl's machine (as I understand it in TGD framework) in order to understand what might be involved. From the highly informal reports (which forces to take the claims with a big grain of salt) one can deduce that all new physics effects involved with the Searl machine are claimed to occur also now.

1. The reduction of the inertial mass.
2. Classical long ranged Z^0 Coulombic force implying as the repulsive force towards objects when the vehicle is not allowed to move.
3. Breaking of the second law of thermodynamic and the reversal of the arrow of geometric in p-adic time scale relevant for the functioning of the system. This is manifested as the lowering of the temperature of rp and the generation of vacuum around the vehicle and by the disappearance of the reflected light.

Remote metabolism and lowering of the temperature near rp

The presence of the negative energy photons explains the strange effects associated with the central region.

1. Central region is reported to darken and also a sudden lowering of the temperature is detected. This could be simply due to the fact that negative energy photons act as kind of dark light. Atoms emitting light are de-excited by the absorption of negative energy photons without any emission so that the emission of light is reduced. The absorption of the negative energy photons also cools the system. In the same manner as positive energy photons heat the system, negative energy photons cool it.
2. The absence of the reflected light from central region is a further strange phenomenon. The first explanation of the absence of reflected light is based on the fact that reflection involves an elastic scattering of the photons of the incoming light beam. This can be regarded as an absorption

of the incoming photon followed by re-emission. If negative energy photons are present, the charged particle can return to the ground state by absorbing negative energy photon instead of emitting a positive energy photon. In the language of Feynman diagrams, the outgoing photon is a negative energy photon received from an external source so that no positive energy photon appears in the final state. One could also say that ordinary reflection is replaced with a reflection in time direction.

One can imagine also an alternative explanation for the loss of the reflected light. During the irradiation of rp the photons topologically condense on the space-time sheet of rp. Because there are only few bridges which allow the photons to escape back to the space-time sheet of the environment, the photons fail to find the way out of rp space-time sheet. The loss of the light reflected from rp reminds somewhat of what happens near black-holes although gravitational field has nothing to do with the phenomenon. Now only a "partial" mini-black-hole is in question and the radius of the hole is much larger than the radius of black-hole horizon of rp so that the classical gravitational force has nothing to do with the phenomenon.

In the case of Marcus device the spinning bi-filar coils would serve as sources of negative energy topological light rays identifiable as correlates of phase conjugate laser waves. Also now standing magneto-static waves caused by the currents flowing in opposite directions and having periodicity defined by the distance between the bi-filar wires would be involved. They could be accompanied by negative energy photons. Also negative energy scalar pulses are possible. The adiabatic variation of the time constant of the bi-filar coil indeed generates a wide spectrum of photons. Also bio-photons appear with a constant frequency independent intensity over visible frequency range at least and might be generated by a similar square wave mechanism.

In the biological applications (see the books [J4, M1] topological light rays are typically parallel to magnetic flux tubes acting effectively as wave guides. The model of EEG leads to the idea that also negative energy magnetic flux tubes possible. This encourages to think that magnetic flux tubes are involved also now. In particular, negative energy magnetic flux tubes acting as wave guides for negative energy topological light rays could be present.

Could the dropping of charges to larger space-time sheets produce large recoil effects?

It is not plausible that the net momentum of even positive energy photons could explain the motion of the Marcus device. The reason is that the ratio $pc/E = 1$ of momentum and energy for photons is too small. For non-relativistic particles the ratio is $pc/E_{kin} = \sqrt{2mc^2/E_{kin}} \gg 1$. Thus the dropping of ions to larger space-time sheets induced by the bridges formed by the topological light rays could generate large recoil effects.

Modanese and Podkletnov have found that a radiation pulse, which does not allow an interpretation as an ordinary em radiation, is generated in the discharge of a capacitor for which the second plate is a super-conductor [22]. Furthermore, this radiation pulse kicks test penduli in motion at large distances and this effect does not weaken with distance which means that it cannot be based on the absorption of radiation. If topological light rays serve only as a control switches making possible for the charges to leak from atomic space-time sheets to larger ones, this kind of effect becomes possible since the leakage causes a recoil effect kicking the test pendulum.

Thus it would seem that the negative energy topological light rays generated by the bi-filar could induce the dropping of charges at rp to larger space-time sheets, say magnetic flux tubes of the Earth's magnetic field or the magnetic field generated by the system itself. This could generate a large recoil effect in the case that the effects of different toroids do not compensate each other and cause the motion of the device.

The model explains why the ball in the origin must be charged. It is only charged particles which couple to electromagnetic topological light rays and photons and thus can be driven by the transversal electric field of the topological light ray from the atomic or some larger space-time sheets to the magnetic flux tubes of Earth or some other space-time sheets as they receive negative energy MEs compensating the zero point kinetic energy.

Also low frequency MEs are involved. For neutral particles the interaction with the microwave MEs generated by the large toroid (most of microwave MEs comes from the region of toroid nearest to rp) acting as bridges between the two space-time sheets does not cause significant leakage to the large space-time sheets.

Weight loss and loss of inertia

Also now the strong charging of the system (both em and Z^0 charges could be generated and this process could be induced also now by the radial electric field associated with the rotating magnetic fields. In the recent case microwaves with wavelengths corresponding to the size of rp are required. This suggests that the function of the oscillating current inside large and small toroids is to generate negative energy MEs (also microwave MEs) carrying phase conjugate maser beams of photons. This process provides automatically some kinetic energy and momentum for the large toroid so that the spinning velocity can be varied to control the direction of motion for the system.

In the case of Searl's machine also the ELF frequency associated with the rotation plays the role of critical frequency and also now the spinning frequency (above 70 Hz) is claimed to be significant. The loss of inertia is claimed to be strongest at 70 Hz rotation frequency. In the case of Searl machine the original idea was that a genuine reduction of inertial mass occurs during spontaneous acceleration (pirouette effect) but this idea seems highly implausible in light of the later developments.

What causes the vacuum around rp?

The first explanation for the vacuum around rp is that the absorption of negative energy photons induces the dropping of charged particles to larger space-time sheets so that they effectively disappear from the system.

The second explanation for the generation of vacuum is as being due to the repulsive classical Z^0 force. All atomic nuclei are completely ionized Z^0 ions and neutrons give the dominating contribution to the Z^0 charge (proton's Z^0 charge is by a factor 1/50 smaller than neutron's Z^0 charge and of opposite sign). Since the ratio N/A of the neutron number $N = A - Z$ to the mass number A does not vary much for the heavier nuclei, the Z^0 force behaves in a reasonable approximation like a strong gravitational force.

Since all nuclei are completely ionized Z^0 ions, whose classical Z^0 field is seen and screened (not completely) by neutrinos in length scales longer than cell size, the spinning of the large toroid generates Z^0 magnetic field orthogonal to the plane of the toroid. This field induces spontaneous Z^0 magnetization inside the small toroids. Since small toroids are rotating with a velocity orthogonal to this field, Z^0 electric field which is directed radially from the center of the large toroid by the same mechanism as the rotating cylindrical magnet generates a radial electromagnetic field.

The rotating Z^0 magnetic field generates a classical Z^0 electric field $E_Z = v \times B_Z$ (generalized Faraday effect) having non-vanishing Z^0 vacuum charge as its source. This vacuum charge, if it has same sign as the Z^0 charge of Earth and objects around it, implies repulsion and strengthens the antigravity effect (of course, a real antigravity effect is not in question). Z^0 Faraday effect suggests a more plausible explanation: the vacuum electric field associated with toroids induces exotic neutrino current which creates a net Z^0 charge inside the rotating toroid and opposite Z^0 charge in its immediate vicinity. The sign of the Z^0 electric field does not depend on the direction of spinning since the field is proportional to the square of the spinning velocity and either a reduction or increase of neutrino screening occurs in environment. If reduction is in question, the resulting the Z^0 Coulombic repulsion tends to drive atomic nuclei out. Protons/electrons have much smaller Z^0 charge than heavier nuclei, and the sign of the charge is different from that of neutron/neutrino. Therefore protons should be attracted by the rotating toroid system and electrons repelled. Obviously this is a testable hypothesis.

The claimed "beam field" effects could be explained in terms of the classical Z^0 force. The condensed matter neutrinos screening the nuclear Z^0 charge of the condensed matter and thus stabilizing it, are extremely light (mass estimates are around .1 eV). Hence neutrinos move very quickly in the external Z^0 force and could generate temporary charge non-equilibrium so that the screening fails locally much like electrons in conductor end up to the surface of the conductor and generate charge non-equilibrium. The failure of the screening could induce dramatic effects such as an explosion of the condensed matter and molecular instability. This could explain the claimed knocking of a hole through a thin sheet of copper by the "beam field". In fact, the screening of Z^0 force by neutrinos plays a key role in TGD based model of condensed matter and molecular chemistry. Molecules more complex than AH_n where A is an atom heavier than hydrogen and H is hydrogen atom (hydrogen has a vanishing Z^0 charge and electron's and protons Z^0 charges are small) are not stable in vacuum. This has deep implications concerning the understanding of the pre-biotic evolution.

I am grateful for Alexander V. Frolov for providing me information about the work related to New Energy Technologies carried out in Russia, in particular the work of Roschin and Godin. I am grateful for email exchanges and discussions with Tapio Tammi, Jari Aaltonen, Juha Hartikka, and Jukka Kinnunen who have also generously provided material relating to the free energy research, in particular the findings about phase conjugation and various variants of Searl device. The discussions with Esa Maunu stimulated the ideas leading to the recent model of the Searl effect based on Faraday effect. The experimental work of Samuli Penttinen has quite recently led to an improved understanding of the role of concrete material composition of the Searl effect and his observation that nylon layers might serve as charge reservoirs has been very valuable.

3.6 Appendix

3.6.1 Miscellaneous considerations

Are the magnetostatic waves generated by the stator involved with remote metabolism?

The classical model for accelerating formation is based on the spontaneous acceleration occurring when Lorentz torque exceeds critical frictional torque. One can however consider also non-classical models as independent models or possible underlying microscopic mechanisms of the classical mechanism.

Since the air in the vicinity of the rotor is cooled the remote metabolism a based on generalized four-wave action with standing wave replaced by magneto-static wave rotating around the stator ring suggests itself as one possible mechanism making it possible to suck the rotational energy from environment. Magneto-static waves [26] have been indeed assigned with over-unity effects. Magneto-static waves correspond to spin precession and involve the interaction with magnetic field and classical magnetic interaction whereas magnons are waves which involve purely quantum mechanical exchange interaction between neighboring spins.

If magnetic walls have large value of \hbar the cyclotron energy scale is much larger than the Larmor energy. This would require that the negative energy dark photons from magnetic walls decohere into a bundle of microwave photons in reversed time direction. In ordinary description this would be interpreted as a self assembly of ordinary phase conjugate microwave photons to dark microwave photons with much higher energy.

1. Magnetostatic waves and remote metabolism

From the point of view of four-wave interaction magneto-static waves would serve as an analog of standing waves generating "reference beam" and its phase conjugate. According to [26], magneto-static waves are generated surprisingly easily and the generation requires much less energy than the generation of ordinary electromagnetic waves: this might relate to the ability of these waves to "take care of itself" by sucking energy from the environment.

The existence of phase conjugate magnetostatic waves is an experimental fact and shown to lead to about 10^4 -fold amplification of the signal wave [34]. The experiment involves a pumping microwave, the signal wave, and a phase conjugate wave, and the frequencies satisfy $\omega_p = \omega_s + \omega_{pc}$, where p refers to pumping microwave, s to magnetostatic wave representing signal, and pc to the phase conjugate magnetostatic wave. In the recent case a variant of this process in which magnetostatic wave itself acts as a pumping wave generating an amplified magnetostatic wave at a slightly higher frequency and a phase conjugate microwave at the Larmor frequency associated with $B = .05$ Tesla. The discrete change of the Larmor frequency for stator could correspond to a change of the quantized magnetic flux by one unit: this makes sense if the transversal area of the flux quantum is about 200 nm. In the case of rollers spin flip transitions would generate microwaves at frequency of about $f_L = .6$ GHz if the net magnetic field inside the roller is 0.5 Tesla and would correlate strongly with the formation of magnetic walls. Four wave mechanism suggests that a standing microwave is generated and magnetic walls are created at its nodes. In the case that only the spins of the electrons of $J = 2$ Cooper pairs are flipped, the spin flip frequency equals to the Larmor frequency of electron.

Bifilar coils in which currents running in opposite directions produces nearly vanishing magnetic field, are known to have biological effects [33] in particular, they are known to stimulate cell growth. A possible explanation is that the currents running in opposite directions induce magnetostatic wave inside the coil making possible remote metabolism by the generalized four-wave mechanism. Cells

would suck energy from the bifilar in turn sucking energy from environment. One could say that bifilar coil would represent a lower level in the nutrition chain.

Searl has reported that the effect disappears, when the system is irradiated with radio waves of same wavelength as used in the fabrication of magnets, which must be of the order of the radius of the rotor. If the frequency of microwaves corresponds to magnetostatic frequency for electrons, their effect could be due the destruction of the coherence of the magnetostatic wave patterns so that they cannot suck the rotational kinetic energy from the environment.

2. Magnetostatic waves generated by stator

Magnetostatic waves do not actually propagate since in a good approximation the frequency does not depend on wave vector in the approximation that exchange interaction can be neglected: this is the case at the limit of long wave lengths. Hence complex time-periodic spatial patterns oscillatory mathematically completely analogous to plasma wave patterns are created. This of utmost importance since repeatedly recurring patterns are ideal for sustained representation of (conscious) information. Thus magnetostatic waves could be seen as magnetic analogs of plasmoids, which in TGD inspired theory of living matter are regarded as primitive life forms. Magnetostatic waves could be important also in living matter. The basic metabolic machinery is indeed analogous to electric power plant involving a rotating shaft and this machinery could be seen as a nano-scale Searl machine.

The allowed frequencies of magneto-static waves depend on boundary conditions (dispersion relations are derived by considering suitable continuity conditions at boundaries [26]). The frequencies depend only on the external field H and on magnetization M besides geometric parameters. The dispersion relation for plane waves depends on the direction of the propagation relative to the direction of the magnetic field [26]:

$$\omega = \sqrt{\omega_H(\omega_H + \omega_M \sin^2(\theta))} . \quad (3.6.1)$$

Here θ is the angle between the magnetic field and direction of propagation. Using the units $\mu_0 = \epsilon_0 = 1, c = 1, \omega_0$ resp. ω_M are obtained from Larmor frequency by replacing B with the magnetizing (external) field H resp. induced magnetization M . Hence one has $\omega_0 + \omega_M = \omega_L$. In the general case the frequency is in the range $\omega_H \leq \omega \leq \sqrt{\omega_H(\omega_H + \omega_M)}$. $\omega_H = geH/2m$ is Larmor (spin flip) frequency of electron in the case that unpaired electrons are responsible for the magnetism. $\omega_M = geM/2m$ is the Larmor frequency in the induced magnetization field. For Earth's magnetic field of nominal value $.5 \times 10^{-4}$ Tesla one would have $\omega_B \simeq .6$ MHz.

In the recent case M corresponds to the background magnetization of the stator magnet and H to the sum of rotating approximately dipolar magnetic fields generated by rollers inside the stator ring: can express H as ϵM_0 , where ϵ depends on the position around roller ring and M_0 corresponds to the magnetization of roller (1 Tesla) in absence of H : note that H induces changes of M_0 in ferromagnets. The geometry is cylindrical but since $\theta = \pi/2$ holds true for the waves moving around the stator ring, a good guess is that $\omega = \omega_L$ holds true. A band of frequencies results since H varies in some range determined by the distance of the roller rings. This deviation is also due to the fabrication. Unfortunately, it is not quite clear from the article of Godin and Roschin whether stator magnetization is parallel or antiparallel to the rotor magnetization. If they are parallel then the frequencies are below $\omega_L = 12$ GHz. Otherwise above it.

The frequency of the magneto-static wave in stator would be determined by the magnetic field strength and due the variation in the direction and magnitude of the magnetic field would be in a band below or above 12 GHz. The rate for the change of the external magnetic field strength H created by the rotating rollers should be lower than that defined by Larmor frequency for this picture to make sense. This is obviously the case since electronic Larmor frequency is for a field strength of Tesla around 12 GHz whereas rotation frequency is around 10 Hz. This would correspond to wavelength of 3.5 cm. This is of the same order of magnitude as the width 5-6 cm of the observed magnetic walls so that there is a satisfactory consistency taking into account that the frequency of magneto-static waves varies.

The magnetic field generated by the stator inside rollers is time independent apart from the effect created by the magnetic inserts, and it is not clear whether magnetostatic waves are appreciably generated in this case.

Could one understand the critical rotation frequency from the scaling law of homeopathy?

According to TGD inspired theory of consciousness, living systems possess besides the material body also a magnetic body having astrophysical size scale, and sensory representations are realized at the magnetic body using essentially remote mental interactions based on quantum entanglement and self-organization induced by microwaves [M1, N1]. The mechanism involves bound state entanglement having as a space-time correlate MEs at EEG frequencies. Of special importance are the frequencies in alpha band, in particular Schumann frequency of about 7.8 Hz associated with the lowest cavity resonance of Earth's magnetic field, are especially interesting. 10 Hz frequency is also fundamental one since it corresponds to the p-adic time scale $T_2(127)$ defining the fundamental time scale in living matter: the average alpha frequency is 10 Hz. It also corresponds to the resonance frequency for the oscillations in ionospheric cavity with the property that the fields are almost constant in radial direction.

What makes the situation so interesting is that the critical rotation frequency has also an interpretation in terms of rotation frequency above which the torque produced by the ball bearing motor effect is larger than the torque of friction. Searl device might fail to function only because the friction torque has too large value!

In TGD inspired theory of living matter the basic mechanisms of homeostasis and remote mental interactions involve low frequency MEs (short hand for "massless extremals", topological light rays) serving as space-time correlates for bound quantum entanglement even in astrophysical length scales, and high frequency MEs propagating inside low frequency MEs like massless particles. High frequency MEs induce bridges between super-conducting magnetic flux tubes (or some other space-time sheets) and atomic space-time sheets (or some other space-time sheets), which in turn make possible the leakage of supra currents and their dissipation at the atomic space-time sheets giving rise to self organization.

The scaling law of homeopathy discussed in [K5] states that high frequency MEs and low frequency MEs accompany each other, and that their frequencies are in certain preferred ratios $f_{low}/f_{high} = v/c$, whose values can be understood in TGD framework. These ratios also correspond to some characteristic velocities v of the system, say EEG wave phase velocities. Low frequency is cyclotron transition frequency $f_c = ZeB/2\pi m$ of ion at a magnetic flux tubes of (say) Earth's magnetic field and high frequency corresponds to the zero point kinetic energy $E_0(k) \simeq \pi^2/2mL(k)^2$ of ion liberated, when the ion drops from some space-time sheet to a much larger space-time sheet such as the magnetic flux tube of Earth. Both cyclotron energy and the zero point kinetic energy scale as $1/L^2(k) \propto 2^{-k}$ as a function of p-adic length scale and are inversely proportional to the mass of ion so that the ratio f_{low}/f_{high} does not depend on the mass of the charged particle.

For the proton the zero point kinetic energy .5 eV for the atomic space-time sheet $k = 137$ and corresponds to the basic energy quantum of metabolism in living matter.

1. For $k = 137$ one has $f_{high}/f_{low} = 2 \times 10^{11}$ for $B = .5$ Gauss.
2. For $k = 149$, which corresponds to the p-adic length scale of 5 nm, one half of the cell membrane thickness, one has $f_{high}/f_{low} = 10^8/2$ and the corresponding velocity is about $v = 6$ m/s which is quite near to the velocity of alpha waves in brain. Note that the velocity depends on the local value of the Earth's magnetic field.
3. For $k = 151$, which corresponds to the p-adic length scale of 10 nm, the cell membrane thickness, one has $f_{high}/f_{low} = 10^8/8$ and the corresponding velocity is about $v = 24$ m/s.

The frequencies f_l of the low frequency MEs naturally correspond to the frequencies associated with the rotating magnetic system. The first frequency is the frequency f_{rot} of rotation for the ring of magnets and 10 Hz typically. The second frequency is the frequency of the oscillating magnetic and electric fields equal to $f_{field} = N \times f_{rot}$, where N is the number of rolling magnets, $N = 23$ in the experiments considered so that one has $f_{field} = 230$ Hz. Scaling law predicts that these frequencies give rise to microwave frequencies, which ought to manifest themselves in the field patterns associated with the system.

It is an interesting exercise to look whether the scaling law of homeopathy is consistent with various frequencies, scales, and velocities appearing in the system.

For the rotation velocity of 600 rpm, the rotation frequency of the ring system is about 10 Hz. The rotation velocity of the ring of magnets is 5.74 m/s at outer radius quite near to the 6 m/s of

alpha waves and the velocity predicted by the scaling law for $k = 149$ in Earth's magnetic field. From $f_{high}(k = 149)/f_{low} = 10^8/2$ the wavelength of high frequency waves predicted by the scaling law is .6 m and defines the outer radius 57.4 cm of the ring magnet system in a good approximation. The value of f_{high} is .5 GHz and corresponds to microwave range.

The field pattern generated by the 23 rolling magnets oscillates with the frequency of $23 \times 10 = 230$ Hz in this case. For $f_{low} = 230$ Hz one has $f_{high} = 23/2$ GHz which is rather near to the upper bound of 12 GHz for the magnetostatic resonance frequency and corresponds to the wavelength $\lambda_{high} = 2.6$ cm, somewhat smaller than the diameter $d = 3.7$ cm of the rolling magnets and the rough estimate 4 cm for the periodicity of the wavy magnetic field lines.

The problem with this estimate is that the local value of the Earth's magnetic field affects the estimate for f_{high} . One can however estimate f_{high} also directly from the zero point kinetic energy at $k = 149$ space-time sheet by using .5 eV for proton at $k = 137$ space-time sheet and scaling by 2^{137-k} . For a protonic Cooper pair dropping from $k = 149$ to $k = 151$ space-time sheet one has $\Delta E_0 = (1 - 1/4) \times 2^{137-149} \times .5$ eV and $\lambda = 2.67$ cm, which is quite near to the estimate obtained using the scaling law.

Other mechanisms of remote metabolism?

The fact that critical frequency is in 9-10 Hz range forces however to consider the possibility that topological light rays at these frequencies fundamental for the functioning of living matter are involved and spontaneous acceleration is accompanied by the emergence of a new source of energy. The energy quantum of metabolism in living matter is in the range .4-.5 eV and corresponds to the zero point kinetic energy when proton drops from atomic space-time sheet ($k = 137$) to a larger space-time sheet. This energy corresponds also to the Z^0 plasma frequency of water. Since 10 Hz frequency defines a fundamental bio rhythm, the question whether this ELF frequency might somehow induce the counterpart of biological metabolism so that the large value of energy quantum would make possible the spontaneous acceleration. Perhaps the generation of Z^0 plasmoids, which are nearly vacuum extremals coupling the classical Z^0 fields and em fields and generating negative energy photons with energies about .5 eV and absorbed by protons dropping to larger space-time sheets, could provide the new source of energy. These negative energy photons could propagate through the wave guides provided by 10 Hz topological light rays. In this case the remote metabolism could occur in the length scale defined by the wave length of 10 Hz photon, roughly the circumference of Earth. This would make possible spontaneous acceleration.

As already found, the scaling law of homeopathy assigns the Larmor frequency of the magnetic system to the frequency 230 Hz. This would suggest that the new source of metabolic energy is realized as enhanced emission of the phase conjugate microwaves. According to the model for the scaling law of homeopathy the microwave MEs ("massless extremals" or topological light rays) would travel to the source of energy as particle like structures inside ELF MEs corresponding to 230 Hz frequency and serving as wave guides. The energy would be sucked from a considerably larger region since the wavelength of 230 Hz waves is 1300 km.

The scaling law of homeopathy in its original very restricted form ($f_l/f_h = 2^{10^{11}}$) would assign to $f_L = 207$ Hz the frequency $f_h = .46 \times 10^{14}$ Hz whereas which the frequency associated with the .4 eV energy quantum of metabolism in living matter is about 10^{14} Hz. Unfortunately, there is a discrepancy by a factor of $\sim 1/2$. One could of course consider the possibility that the dropping of electron Cooper pairs from the space-time sheet $k = 149$ corresponding to the length scale of lipid layer of cell membrane (5 nm) provides the energy. In this case one cannot however assign Z^0 plasma frequency with the process. An interesting question is whether the doubling of the rotation velocity (prevented by the loss of mechanical stability in the experiment of Russians) could excite the ordinary metabolism.

3.6.2 Some general facts about classical solutions of field equations

General considerations

The vanishing of Lorentz 4-force for the induced Kähler field means that the vacuum 4-currents are in a mechanical equilibrium. Lorentz 4-force vanishes for all known solutions of field equations which inspires the hypothesis that all extremals or at least the absolute minima of Kähler action satisfy the condition. The vanishing of the Lorentz 4-force in turn implies local conservation of the ordinary

energy momentum tensor. The corresponding condition is implied by Einstein's equations in General Relativity. The hypothesis would mean that the solutions of field equations are what might be called generalized Beltrami fields. The condition implies that vacuum currents can be non-vanishing only provided the dimension D_{CP_2} of the CP_2 projection of the space-time surface is less than four so that in the regions with $D_{CP_2} = 4$, Maxwell's vacuum equations are satisfied.

The hypothesis that Kähler current is proportional to a product of an arbitrary function ψ of CP_2 coordinates and of the instanton current generalizes Beltrami condition and reduces to it when electric field vanishes. Kähler current has vanishing divergence for $D_{CP_2} < 4$, and Lorentz 4-force indeed vanishes. The remaining task would be the explicit construction of the imbeddings of these fields and the demonstration that field equations can be satisfied.

Under additional conditions magnetic field reduces to what is known as Beltrami field. Beltrami fields are known to be extremely complex but highly organized structures. The natural conjecture is that topologically quantized many-sheeted magnetic and Z^0 magnetic Beltrami fields and their generalizations serve as templates for the helical molecules populating living matter, and explain both chirality selection, the complex linking and knotting of DNA and protein molecules, and even the extremely complex and self-organized dynamics of biological systems at the molecular level.

Field equations can be reduced to algebraic conditions stating that energy momentum tensor and second fundamental form have no common components (this occurs also for minimal surfaces in string models) and only the conditions stating that Kähler current vanishes, is light-like, or proportional to instanton current, remain and define the remaining field equations. The conditions guaranteeing topologization to instanton current can be solved explicitly. Solutions can be found also in the more general case when Kähler current is not proportional to instanton current. On basis of these findings there are strong reasons to believe that classical TGD is exactly solvable.

Absolute minimization of Kähler action and second law of thermodynamics

By quantum classical correspondence the non-deterministic space-time dynamics should mimic the dissipative dynamics of the quantum jump sequence. Beltrami fields appear in physical applications as asymptotic self organization patterns for which Lorentz force and dissipation vanish. This suggests that absolute minima of Kähler action correspond to space-time sheets which asymptotically satisfy generalized Beltrami conditions so that one can indeed assign to the final (rather than initial!) 3-surface a unique 4-surface apart from effects related to non-determinism. Absolute minimization abstracted to purely algebraic generalized Beltrami conditions would make sense also in the p-adic context. Also the equivalence of absolute minimization with the second law strongly suggests itself. Of course, one must keep mind open for the possibility that it is the second law of thermodynamics which replaces absolute minimization as the fundamental principle.

The dimension of CP_2 projection as classifier for the fundamental phases of matter

The dimension D_{CP_2} of CP_2 projection of the space-time sheet encountered already in p-adic mass calculations classifies the fundamental phases of matter. For $D_{CP_2} = 4$ empty space Maxwell equations hold true. This phase is chaotic and analogous to de-magnetized phase. $D_{CP_2} = 2$ phase is analogous to ferromagnetic phase: highly ordered and relatively simple. $D_{CP_2} = 3$ is the analog of spin glass and liquid crystal phases, extremely complex but highly organized by the properties of the generalized Beltrami fields. This phase is the boundary between chaos and order and corresponds to life emerging in the interaction of magnetic bodies with bio-matter. It is possible only in a finite temperature interval (note however the p-adic hierarchy of critical temperatures) and characterized by chirality just like life.

Could the strange effects in rotating magnetic systems relate to $D_{CP_2} = 2 \rightarrow 3$ phase transition?

The general picture could have non-trivial implications also in the case of rotating magnetic systems.

1. A non-vanishing vacuum Kähler charge density is generated when a constant magnetic field is put into rotation. The non-vanishing charge density is not consistent with the vanishing of the Kähler 4-current and requires a 3-dimensional CP_2 projection and topologization of the Kähler

current. Beltrami condition cannot hold true exactly for the rotating system. The conclusion is that rotation induces a phase transition $D_{CP_2} = 2 \rightarrow 3$.

2. This could help to understand various strange effects related to the rotating magnetic systems. For instance, the increase of the dimension of CP_2 projection could generate join along boundaries contacts and wormhole contacts leading to the transfer of charge between different space-time sheets. The possibly resulting flow of gravitational flux to larger space-time sheets might help to explain the claimed antigravity effects.
3. The phase transition implies a qualitative change in the structure of the magnetic fields and could thus explain the generation of magnetic walls observed in the rotating magnetic system. What is fascinating that $D_{CP_2} = 3$ phase corresponds to the living matter in the proposed classification. This would conform with the idea that the ADP-ATP machinery responsible for the metabolism is a molecular Searl machine. Hence the strange effects observed in rotating magnetic systems might reveal the fundamentals of the dead \rightarrow alive phase transition.

3.6.3 Could spontaneous acceleration be due to the change of inertial mass?

The first model for the reduction of inertial mass was based on the reduction of inertial mass inducing pirouette effect. This mechanism could explain the spontaneous acceleration if one accepts the new view about the relationship between gravitational and inertial energy (the earlier model was based on strict form of Equivalence Principle). The reduction of the inertial mass alone cannot explain the strong parity breaking effects, and the observed fast increase of the weight change with the rotation velocity and classical Z^0 and em forces are needed. Applying Occam's razor one could conclude that classical em and Z^0 forces are all that is needed and the possible gravitational and inertial effects are quite too weak to explain the effects. It is however possible that the generation of gravitational and inertial energy from vacuum occurs in much smaller quantities and the resulting model could serve as a general model for these effects in different contexts.

The reduction of inertial mass and pirouette effect

If the angular momentum of the rotor can be assumed to be conserved, one can understand the rapid angular acceleration as a pirouette effect caused by the reduced inertial mass causing the reduction of moment of inertia. For the clockwise rotation direction the net change of the weight is about 1 per cent in the range 550 – 600 rpm and starts from mass reduction of 30 per cent, which would mean 3.5 kg change of inertial mass, which would be a rather dramatic effect.

This crazy sounding prediction might be killed by simple experimental tests (note however that inertial mass could be invisible in the case that it resides at non-standard space-time sheets). One cannot deny that the hypothesis about the reduction of the inertial mass is on somewhat shaky grounds since it relies basically on the pirouette mechanism and has so dramatic implications. The simplest assumption is that similar process occurs also for the counter clockwise rotation.

The conservation of angular momentum gives

$$L = I\omega = \text{constant} . \quad (3.6.2)$$

Here I denotes the moment of inertia. I is proportional to mass and thus decreases. Denoting by $m = xm_0$ the reduced mass one has $I = xI_0$. Therefore the rotation frequency f must be inversely proportional to the mass:

$$\frac{f}{f_0} = \frac{m_0}{m} . \quad (3.6.3)$$

where m refers to inertial mass. Now the moment of inertia decreases because the mass is reduced: usually the system gets thinner in the direction defined by the axis of rotation.

In the absence of other effects the predicted dependence of $\Delta m/m_0$ on f above critical rotation frequency $f_{cr}(\pm)$ in the region of rapid acceleration would be

$$\frac{|\Delta m|}{m_0} = 1 - \frac{f_{cr}(\pm)}{f} . \quad (3.6.4)$$

Below f_{cr} there would be no effect. The reduction of effective weight however begins already at $f_0 \sim 200$ rpm so that other effects must be involved. Classical Z^0 force is the most natural candidate responsible for these effects.

A parametrization for the changes of inertial mass and redistribution of gravitational flux

Assume that there is change of inertial mass and redistribution of gravitational flux above the critical frequency. The dependence of the inertial mass on frequency can be parameterized in the linear approximation as

$$m(f) = m_0 \frac{f_{cr}(\pm)}{f} \text{ for } f \geq f_{cr}(\pm) . \quad (3.6.5)$$

The general formula 3.3.10 gives for the fractional change of the effective weight

$$\begin{aligned} \frac{\Delta[m_{eff}(f, \pm)]}{m_0} &= \theta(f - f_{cr}(\pm)) \left[\epsilon(f) \frac{f_{cr}(\pm)}{f} - 1 \right] \\ &\mp \frac{Q_Z(f, \pm)g_Z E_Z + Q_{em}(f, \pm)eE_{em}}{m_0 g} \end{aligned} \quad (3.6.6)$$

in the proposed parametrization.

1. The possibly occurring reduction of the inertial mass occurs freely at least during the step, which corresponds to $\Delta G/G \simeq .01$ per $\Delta f = 50$ rpm giving slope $d(\Delta G/G)/df \sim .1/f_{cr}$. For $\epsilon(f) = 1$ the slope would be $1/f_{cr}$ and 10 times larger so that also the redistribution of gravitational flux should also be present and its change must together with the inertial mass must almost compensate for the growth of weight caused by the increase of Z^0 charge. This would require that $d\epsilon/df \sim 1.3$ at $f = f_{cr}$. This would mean that the fraction of the gravitational flux feeded to the space-time sheet carrying the Earth's gravitational field must increase.
2. The gravitational mass of the system must increase at least by the same amount as the inertial mass is reduced in the process. Since positive and negative inertial energy matter can be generated, the change of gravitational mass can be larger than the change of the inertial mass. If the resulting new gravitational flux is feeded to the space-time sheet carrying the gravitational field of Earth the standard distribution of gravitational flux changes in the desired manner. One expects that the distribution of the gravitational flux returns to the normal later.

Remark: In [27] it is stated that in the area 550 rpm a force against the direction of the gravitational vector is created. Figure 1 however implies just the opposite of this interpretation since the reduction of the weight slows down. Also the statement that the weight of the device quickly changes at 550 rpm is in conflict with figure 1.

3. The simplest parametrization for the redistribution of the gravitational flux for clockwise rotation is

$$\epsilon(f) = 1 + k \times \frac{f - f_{cr}(+)}{f_{cr}(+)} , \quad k \simeq 1.3 . \quad (3.6.7)$$

in the range $\Delta G/G \in [30 - 31]$ per cent. Of course, the effects should be present also above this range if the reduction of inertial mass is the explanation of the spontaneous acceleration. The process might be regarded as a phase transition and the conjecture of the authors of [27] is that this is the case and that similar phase transitions could occur also at higher rotation velocities.

The phase transition would create a vacuum extremal having a gravitational mass and would be followed by a continuous flow of positive inertial mass from the magnetic system. The slow down of the rapid spontaneous acceleration would be due to the coupling of the load so that angular momentum conservation would not hold true anymore. Thus the reduction of the inertial mass would not be anymore visible as an acceleration.

A similar parametrization works also in the counter clockwise situation and the simplest assumption is the same phase transition occurs and the parametrization is identical. The reduction of inertial mass causes acceleration but the growth of gravitational mass compensates this effect to the weight and only steepens increase the rate of mass change due to the Z^0 force. Indeed, in [27] it is stated that in area 600 rpm a force in the direction of the gravitational force of Earth is created.

Could the generation of self-organizing vacuum extremals induce a reduction of inertial mass and increase of the gravitational mass?

Vacuum extremals correspond to regions of space-time where induce Kähler field vanish, are vacua with respect to the density of inertial energy. In vacuum regions em and Z^0 fields are non-vanishing in general and Z^0/γ ratio satisfies $Z^0/\gamma = 4/\sin^2(\theta_W) \simeq 8$. Thus there is a coupling between classical Z^0 em fields which might be of importance. The presence of classical Z^0 magnetic and electric fields inducing strong parity breaking effects would conform with the observed dependence of the effect on the direction of rotation serving as a direct signature of parity breaking effect.

Vacuum regions are not gravitational vacua and the generation of these kind of regions could give rise to a creation of matter and antimatter whose inertial energies would have opposite sign and cancel each other. Einstein's equations tell the density of gravitational four momentum generated in the process and if highly curved space-time sheets are created, creation of considerable amounts matter is unavoidable. This kind of regions could contain quite considerable density of positive and negative energy matter, say as photons and their phase conjugates and perhaps even positive energy electrons and negative energy positrons.

Vacuum regions are non-deterministic and un-stable against phase transitions changing the topology of the space-time sheet as well as generation of inertial energy. The inherent instability of vacuum means that they would gradually self-organize to non-vacua by emitting negative energy matter, in particular phase conjugate photons, and thus develop a net positive inertial energy. The behavior of these systems would have a definite evolutionary aspect, which suggests that the creation of vacuum regions is the quintessence of life. System is living as long as it can create these regions and utilize the energy sucked by these regions as they self-organize to positive energy states by sending negative energy into the environment. Plasmoids are excellent candidates for regions evolving from inertial vacuum. Plasmoids indeed seem to be primitive life forms.

The changes the gravitational and inertial masses of the system would be a signature of this process. Gravitational/inertial anomalies have been repeatedly reported to accompany over unity effects. The vacuum extremal is unstable and stabilizes by generating negative net inertial mass. This is achieved by a flow of a fraction of positive energy matter out of the system. A plausible looking idea is that gravitational energy might be created from vacuum in the energy scale which corresponds to the magnetic energy density associated with the magnetic walls: this would make roughly 10^{-4} eV per atomic volume which corresponds to the frequency of 10 GHz microwaves associated with magneto-static waves. In this case the effects on inertial and gravitational masses are of course completely negligible and visible only as remote metabolism.

The assumption that the changes of inertial mass and redistribution of gravitational mass are responsible for the effective weight change requires that matter is created from vacuum in macroscopic amounts. If 1 kg of both positive energy electrons and negative energy positrons are created in a volume of 1 cubic meter, roughly 1 electron per atomic volume would be created and it seems that Coulomb repulsion does not allow so dense a plasma. Needless to say, the laboratory scale big bang creating kilograms of matter from vacuum would mean a technological revolution. Of course, so high a density of matter created from vacuum looks highly implausible. The hypothesis can be killed by comparing this density to the density of plasma phase just outside the system. Of course, positive energy matter could also flow also to larger space-time sheets and remain invisible.

I am grateful for Alexander V. Frolov for providing me information about the work related to New Energy Technologies carried out in Russia, in particular the work of Roschin and Godin. I am grateful for email exchanges and discussions with Tapio Tammi, Jari Aaltonen, Juha Hartikka, and Jukka Kinnunen who have also generously provided material relating to the free energy research, in particular the findings about phase conjugation and various variants of Searl device. The discussions with Esa Maunu stimulated the ideas leading to the recent model of the Searl effect based on Faraday effect.

Bibliography

Online books about TGD

- [1] M. Pitkänen (2006), *Topological Geometro-dynamics: Overview*.
http://tgd.wippiespace.com/public_html/tgdview/tgdview.html.
- [2] M. Pitkänen (2006), *Quantum Physics as Infinite-Dimensional Geometry*.
http://tgd.wippiespace.com/public_html/tgdgeom/tgdgeom.html.
- [3] M. Pitkänen (2006), *Physics in Many-Sheeted Space-Time*.
http://tgd.wippiespace.com/public_html/tgdclass/tgdclass.html.
- [4] M. Pitkänen (2006), *Quantum TGD*.
http://tgd.wippiespace.com/public_html/tgdquant/tgdquant.html.
- [5] M. Pitkänen (2006), *TGD as a Generalized Number Theory*.
http://tgd.wippiespace.com/public_html/tgdnumber/tgdnumber.html.
- [6] M. Pitkänen (2006), *p-Adic length Scale Hypothesis and Dark Matter Hierarchy*.
http://tgd.wippiespace.com/public_html/paddark/paddark.html.
- [7] M. Pitkänen (2006), *TGD and Fringe Physics*.
http://tgd.wippiespace.com/public_html/freenergy/freenergy.html.

Online books about TGD inspired theory of consciousness and quantum biology

- [8] M. Pitkänen (2006), *Bio-Systems as Self-Organizing Quantum Systems*.
http://tgd.wippiespace.com/public_html/bioselforg/bioselforg.html.
- [9] M. Pitkänen (2006), *Quantum Hardware of Living Matter*.
http://tgd.wippiespace.com/public_html/bioware/bioware.html.
- [10] M. Pitkänen (2006), *TGD Inspired Theory of Consciousness*.
http://tgd.wippiespace.com/public_html/tgdconsc/tgdconsc.html.
- [11] M. Pitkänen (2006), *Mathematical Aspects of Consciousness Theory*.
http://tgd.wippiespace.com/public_html/genememe/genememe.html.
- [12] M. Pitkänen (2006), *TGD and EEG*.
http://tgd.wippiespace.com/public_html/tgdeeg/tgdeeg/tgdeeg.html.
- [13] M. Pitkänen (2006), *Bio-Systems as Conscious Holograms*.
http://tgd.wippiespace.com/public_html/hologram/hologram.html.
- [14] M. Pitkänen (2006), *Magnetospheric Consciousness*.
http://tgd.wippiespace.com/public_html/magnconsc/magnconsc.html.
- [15] M. Pitkänen (2006), *Mathematical Aspects of Consciousness Theory*.
http://tgd.wippiespace.com/public_html/magnconsc/mathconsc.html.

References to the chapters of books

- [A9] The chapter *Does TGD Predict the Spectrum of Planck Constants?* of [TGDview].
http://tgd.wippiespace.com/public_html/tgdview/tgdview.html#Planck.
- [C4] The chapter *Is it Possible to Understand Coupling Constant Evolution at Space-Time Level?* of [TGDquant].
http://tgd.wippiespace.com/public_html/tgdquant/tgdquant.html#rgflow.
- [C6] The chapter *Was von Neumann Right After All* of [TGDquant].
http://tgd.wippiespace.com/public_html/tgdquant/tgdquant.html#vNeumann.
- [D3] The chapter *The Relationship Between TGD and GRT* of [TGDclass].
http://tgd.wippiespace.com/public_html/tgdclass/tgdclass.html#tgdgrt.
- [D4] The chapter *Cosmic Strings* of [TGDclass].
http://tgd.wippiespace.com/public_html/tgdclass/tgdclass.html#cstrings.
- [D5] The chapter *TGD and Cosmology* of [TGDclass].
http://tgd.wippiespace.com/public_html/tgdclass/tgdclass.html#cosmo.
- [E9] The chapter *Topological Quantum Computation in TGD Universe* of [TGDnumber].
http://tgd.wippiespace.com/public_html/tgdnumber/tgdnumber.html#tqc.
- [F6] The chapter *Topological Condensation and Evaporation* of [TGDpad].
http://tgd.wippiespace.com/public_html/paddark/paddark.html#padaelem.
- [F8] The chapter *TGD and Nuclear Physics* of [TGDpad].
http://tgd.wippiespace.com/public_html/paddark/paddark.html#padnucl.
- [F9] The chapter *Dark Nuclear Physics and Living Matter* of [TGDpad].
http://tgd.wippiespace.com/public_html/paddark/paddark.html#exonuclear.
- [G1] The chapter *Anomalies Related to the Classical Z^0 Force and Gravitation* of [TGDfree].
http://tgd.wippiespace.com/public_html/freenergy/freenergy.html#Zanom.
- [H2] The chapter *Negentropy Maximization Principle* of [TGDconsc].
http://tgd.wippiespace.com/public_html/tgdconsc/tgdconsc.html#nmpc.
- [H4] The chapter *Quantum Model for Sensory Representations*
of [TGDconsc].
http://tgd.wippiespace.com/public_html/tgdconsc/tgdconsc.html#expc.
- [H9] The chapter *Quantum Model for Paranormal Phenomena*
of [TGDconsc].
http://tgd.wippiespace.com/public_html/tgdconsc/tgdconsc.html#parac.
- [J1] The chapter *Bio-Systems as Super-Conductors: part I* of [TGDware].
http://tgd.wippiespace.com/public_html/bioware/bioware.html#superc1.
- [J2] The chapter *Bio-Systems as Super-Conductors: part II* of [TGDware].
http://tgd.wippiespace.com/public_html/bioware/bioware.html#superc2.
- [J3] The chapter *Bio-Systems as Super-Conductors: part III* of [TGDware].
http://tgd.wippiespace.com/public_html/bioware/bioware.html#superc3.
- [J4] The chapter *Quantum Antenna Hypothesis* of [TGDware].
http://tgd.wippiespace.com/public_html/bioware/bioware.html#tubuc.
- [J6] The chapter *Coherent Dark Matter and Bio-Systems as Macroscopic Quantum Systems* of [TGDware].
http://tgd.wippiespace.com/public_html/bioware/bioware.html#darkbio.

- [K1] The chapter *Time, Spacetime and Consciousness* of [TGDholo].
http://tgd.wippiespace.com/public_html/hologram/hologram.html#time.
- [K4] The chapter *Bio-Systems as Conscious Holograms* of [TGDholo].
http://tgd.wippiespace.com/public_html/hologram/hologram.html#hologram.
- [K5] The chapter *Homeopathy in Many-Sheeted Space-Time* of [TGDholo].
http://tgd.wippiespace.com/public_html/hologram/hologram.html#homeoc.
- [K6] The chapter *Macroscopic Quantum Coherence and Quantum Metabolism as Different Sides of the Same Coin* of [TGDholo].
http://tgd.wippiespace.com/public_html/hologram/hologram.html#metab.
- [M1] The chapter *Magnetic Sensory Canvas Hypothesis* of [TGDeeg].
http://tgd.wippiespace.com/public_html/tgdeeg/tgdeeg/tgdeeg.html#mec.
- [M3] The chapter *Dark Matter Hierarchy and Hierarchy of EEGs* of [TGDeeg].
http://tgd.wippiespace.com/public_html/tgdeeg/tgdeeg/tgdeeg.html#eegdark.
- [M4] The chapter *Quantum Model for EEG: Part I* of [TGDeeg].
http://tgd.wippiespace.com/public_html/tgdeeg/tgdeeg/tgdeeg.html#eegI.
- [M5] The chapter *Quantum Model of EEG: Part II* of [TGDeeg].
http://tgd.wippiespace.com/public_html/tgdeeg/tgdeeg/tgdeeg.html#eegII.
- [N1] The chapter *Magnetospheric Sensory Representations* of [TGDmagn].
http://tgd.wippiespace.com/public_html/magnconsc/magnconsc.html#srepres.

References related to anomalies

- [16] W. A. Tiller, W. E. Dibble Jr., and M. J. Kohane(2001), *Conscious Acts of Creation: the Emergence of a New Physics*, p.17.
 Pavior Publishing. <http://www.pavior.com/>.
- [17] Roshchin, V.V and Godin, S.M., *An Experimental Investigation of the Physical Effects in a Dynamic Magnetic System*, New Energy Technologies Issue #1 July-August 2001.
- [18] V. M. Lobashev *et al*, in *Neutrino 96* (Ed. K. Enqvist, K. Huitu, J. Maalampi). World Scientific, Singapore, 1996.
- [19] S. E. Shnoll *et al* (1998), *Realization of discrete states during fluctuations in macroscopic processes*, Uspekhi Fisicheskikh Nauk, Vol. 41, No. 10, pp. 1025-1035.
- [20] Shipov G.I. "Teoriya fizicheskogo vakuuma.", Moscow, NT-Centr, 1993, 362 p. (russian) ("Theory of physical vacuum.")
- [21] A. E. Akimov, *Torsion Technologies are XXI Age Technologies*, New Energy Technologies, Issue #1, July-August, 2001.
- [22] E. R. Williams (2001), *Sprites, Elves, and Glow Discharge Tubes*, feature article of *Physics to Day*, vol. 52, No 11.
- [23] J. Searl (2001), *The Searl effect generator and the levity disc*, in conference proceedings *Neu Wasserstofftechnologien un Raumantriebe*, Jupiter Verlag. There are also other articles related to Searl effect, in particular the articles of S. M. Godin and V. V. Roschin and of P. LaViolette.
- [24] J. B. Bateman (1978), *A Biologically Active Combination of Modulated Magnetic and Microwave Fields: the Priore Machine*, in "Office of Naval Research," London Report R-5- 78, Aug. 1978
- [25] T. E. Bearden (1988), chapters 'Extraordinary Physics' and 'Extraordinary Biology' in *Aids: Biological Warfare*. Tesla Book Company, P. O.Box 1649, Greenville, TX 75401, See also the html article *The Priore Machine and Phase Conjugation* at the homepage of Bearden: <http://www.cheniere.org/priore/index.html> .

- [26] D. D. Stancil (1993), *Theory of Magnetostatic Waves*. Springer Verlag.
- [27] V. V. Roschin and S. M. Godin (2001), *Generator with Energy Conversion and Anti-Gravity Effects*, Neue Wasserstofftechnologien un Raumantriebe, Vortäge der Kongresses vom 23.-24. Juni, Weinfelden. Jupiter Verlag.
- [28] P. LaViolette (2001), *How the Searl Effect Works: an Analysis of the Magnetic Energy Converter*, Neue Wasserstofftechnologien un Raumantriebe, Vortäge der Kongresses vom 23.-24. Juni, Weinfelden. Jupiter Verlag.
- [29] H. J. Assenbaum, K. Langanke and C. Rolfs (1987), Z. Phys. A 327, 461.
- [30] C. Rolfs and W. S. Rodney (1988), *Cauldrons in the Cosmos* (Chicago, IL: University of Chicago Press).
- [31] C. Rolfs *et al* (2006), *High-Z electron screening, the cases $^{50}\text{V}(p,n)^{50}\text{Cr}$ and $^{176}\text{Lu}(p,n)$* , J. Phys. G: Nuclear. Part Phys. 32 489. Eur. Phys. J. A 28, 251-252.
- [32] C. Rolfs *et al* (2006), *First hints on a change of the ^{22}Na β decay half-life in the metal Pd*, Eur. Phys. J. A 28, 251.
- [33] G. Rein (1998), *Biological Effects of Quantum Fields and Their Role in the Natural Healing Process*, Frontier Perspectives, Vol 7: 16-23.
- [34] G. A Melkov *et al*(2001), *Phase Conjugation of Linear and Nonlinear Signals of Magnetostatic Waves*, Material Science Forum. Vols. 373-276, pp. 785-790, Trans Tech Publications, Switzerland.
- [35] S. M. Girvin (1999), *Quantum Hall Effect, Novel Excitations and Broken Symmetries*, cond-mat/9907002.
- [36] S. D. Allan (2004), *Perendev is Tooling Up for Magnetic Motor Mass Production in Europe*, Pure Energy Systems News, <http://pesn.com/2004/06/30/6900029PerendevPowerMagneticMotor/>.
The page contains a short description of a magnetic device consisting of parallel stators disks and rotor disk claimed to start to rotate spontaneously.
- [37] The device of Marcus Hollingshead is discussed in *Antigravity discussion group*, <http://groups.yahoo.com/group/Antigravity/?yguid=74088422>.
- [38] B. DePalma (1995), *Notes on Faraday disc*.
<http://www.depalma.pair.com>.
- [39] P. Tewari, *Patent application for the space power generator of P. Tewari*.
<http://www.depalma.pair.com>.
- [40] Hayasaka H., Takeuchi S. (1989), *Anomalous weight reduction on a gyroscopes right rotation around the vertical axis of the earth*, Phys. Rev. Lett., # 25, p.2701.
- [41] Yu. V. Nachalov (1999) *Theoretical basis of experimental phenomena*
<http://www.amasci.com/freenrg/tors/tors3.html>.
- [42] Yu. V. Nachalov and A.N. Sokolov (1999) *Experimental investigation of new long-range interactions*
<http://www.amasci.com/freenrg/tors/doc17.html>.
- [43] Kozyrev N.A. "Prichinnaya ili nesimmetrichnaya mekhanika v lineinom priblizhenii.", Pulkovo, GAO AN SSSR, 1958, 90 p. (russian) ("Causal or asymmetrical mechanics in linear approximation.")
- [44] Baryshevsky V.G., Korennaya L.N.
Doklady AN BSSR, 1965, v.12, p.1 (russian).

- [45] Pokozaniev V.G., Skrotskii G.V. "Pseudomagnetizm." Uspekhi fizicheskikh nauk, 1979, v.129, # 4. (russian).
- [46] Abragam A. "The principles of nuclear magnetism.", Clarendon press, Oxford, 1961.
- [47] Goldman M. "Spin temperature and nuclear magnetic resonance in solids.", Clarendon press, Oxford, 1970.
- [48] Krisch A.D. "The spin of proton." Scientific American, may, 1979.
- [49] Shoucheng Ouyang and Yi Lin (2006), *On spinning of matters and some important studies absent in contemporary science*, Scientific Inquiry, vol. 7, No 1, June, pp. 55.62
<http://www.iigss.net/Scientific-Inquiry/OuYangI.pdf>.
- [50] E. Podkletnov and G. Modanese (2002), *Investigation of high voltage discharges in low pressure gases through large ceramic super-conducting electrodes*,
<http://xxx.lanl.gov/abs/physics/0209051>.
- [51] J.-L. Naudin *The Quest for Over-Unity*. The page contains material about over-unity devices, in particular magnetic motors. <http://jnaudin.free.fr/>.

Mathematics related references

- [52] E. C. Zeeman (ed.)(1977), *Catastrophe Theory*, Addison-Wessley Publishing Company.

Chapter 4

Did Tesla Discover the Mechanism Changing the Arrow of Time?

4.1 Introduction

After having made the inventions providing much of the basis technology for the modern electricity based society, Tesla used the rest of his life to study the strange phenomena related to sharp electric pulses. Tesla became convinced that pulse like rays carrying longitudinal electric fields exists although Maxwell's theory does not allow them. Needless to say, Tesla's findings were not taken seriously by the scientific establishment. On the other hand, for the developers of so called free energy technologies Tesla has remained a magic figure. To me it has gradually become clear that it might be possible to formulate the visions of Tesla using the language of modern physics.

The final breakthrough came with a discovery of a mechanism generating what I have used to call negative energy topological light rays having phase conjugate laser waves as physical counterparts. Negative energy topological light rays provide the fundamental control mechanism in the TGD based model of living matter and appear in practically every mechanism of consciousness as a basic step. This is however not yet the whole story. One should also identify mechanisms allowing to control the generation of the negative energy topological light rays: direct transformation of p-adic MEs to negative energy MEs is probably not enough. The solution to the problem came from a quite unexpected direction. It was the attempt to understand the physics behind the visions of Tesla which led to an identification of a very general mechanism of this kind.

Phase conjugate laser waves break second law of thermodynamics and this is possible in TGD Universe below the p-adic time scale characterizing the system. Therefore short pulses are ideal for this purpose. Depending on the situation, electric pulses in electric circuits typically force the charge carriers to accelerate or decelerate. During deceleration positive energy photons are emitted as brehmstrahlung whereas during acceleration charges emit negative energy photons in order to receive energy. Thus generation of pulses provides a mechanism to generate negative energy topological rays which in turn serve for various control purposes. TGD indeed predicts the existence of scalar wave pulses propagating in vacuum with light velocity and carrying longitudinal electric fields.

One can understand the basic findings of Tesla at qualitative level in TGD framework and there are strong reasons to believe that Tesla was right after all. This of course raises the question how it is possible that the scientific community with all its technology remained silent about the findings of Tesla for an entire century. Experimentalists must have made occasional encounters with the phenomena reported by Tesla. Are modern experimentalists conditioned to take theorists quite too seriously?

In this chapter the general vision allowing to understand the findings of Tesla and others relating to binary coils and Tesla transformers are discussed. The solutions describing Tesla's scalar wave pulses are discussed. The new physics associated with binary coils is discussed in detail and a detailed model for binary coil and transformer using binary coil as a primary is constructed using the experimental input provided generously by Tapio Tammi. The findings of Tesla are discussed at general level using the resulting over all picture. The chapter ends with the model for the causal anomalies observed in the tunnelling of photons through potential barriers.

4.2 Discussion of the basic ideas and concepts

4.2.1 Do negative energy space-time sheets have counterparts in quantum field theory?

Negative energy topological light rays seem to correspond to phase conjugate laser waves. In particular, the experiments of Feinberg [19] are consistent with the transparency of matter for phase conjugate laser beams with photon energies above thermal energy. In optics phase conjugation requires optically non-linear system [16]. For instance, in usual hologram the matter is optically non-linear in the sense that dielectric constant depends on the external electric field so that the electromagnetic radiation induces a change of the refraction coefficient which in turn codes for the hologram.

The dynamics of classical fields is indeed extremely nonlinear in TGD: the topological field quantization is one of the most dramatic outcomes of this non-linearity. Whether the phenomenological models for phase conjugate waves and for their generation are enough in TGD framework is an open question. The mechanism based for the generation of negative energy topological light rays based on short pulses to be discussed in this section does not seem to reduce to the framework of non-linear optics.

There are also questions of principle involved.

Is phase conjugation properly understood in quantum field theories?

At the level of quantum physics negative energy photons would correspond to a system quantized in such a manner that both bosonic and fermionic annihilation and creation operators have changed their roles. Negative energy photons and fermions do not correspond to (non-existing) "anti-photons" and anti-fermions. Using the terminology of Dirac's bra-ket formalism: negative energy systems are like bras if positive energy photons are kets. Kets and bras correspond to Hilbert space and linear functionals defined in it. The space of bras is actually not equivalent with that of kets but in a well defined sense a more general concept. This conforms with the role of negative energy space-time sheets in TGD inspired theory of consciousness.

In quantum field theories time reversal transforms creation operators for fermions to creation operators for anti-fermions. Vacuum state is not changed. Time reversal in TGD sense would transform ket vacuum to bra vacuum so that the earlier creation operators annihilate the new vacuum state and genuine negative energy states result. This would suggest that negative energy states are something genuinely new and a genuine outcome of the many-sheeted space-time concept allowing either bra and ket type vacuum at a given space-time sheet. This difference might relate to matter-antimatter asymmetry whose origin is one of the deepest problems of cosmology. Perhaps dynamics favors space-time sheets containing negative energy matter instead of antimatter.

Phase conjugation and irreversibility

One interesting aspect associated with negative energy topological light rays is that they seem to be irreversible systems. On the other hand, phase conjugation can be used to eliminate perturbations on signal caused by thermal noise since the evolution proceeds from perturbed to non-perturbed signal. This could be seen as an objection against TGD based interpretation stating that topological light rays are essentially non-dissipative structures of classical physics.

The objection can be circumvented. Classical-quantum correspondence implies that space-time physics mimics also the dissipative aspects of quantum dynamics defined by quantum jump sequences. The classical non-determinism of the basic variational principle makes this possible. Classical fields are non-dissipative structures are even able to represent information about dissipation, analogous to a written text telling a story about growth, flourishing, and decay. In fact, in TGD framework space-time itself provides symbolic classical representations for quantum jump sequences determining the subjective, experienced reality. The implications of this representative aspect for biology are highly non-trivial. For instance, phase conjugate waves could provide a fundamental mechanism of healing and error correction.

Matter-antimatter asymmetry, phase conjugation for fermions, and new energy technology

If photons with negative energies are allowed, it is difficult to deny the possibility of fermions with negative energies. The possibility of having both signs of energy suggests an elegant solution to the problem of matter-antimatter asymmetry and a powerful new energy technology.

1. The standard second quantization of Dirac spinors postulates that ground state is annihilated by annihilation operators for fermions and anti-fermions. One can construct explicitly the state annihilated by annihilation operators. Suppose that there is state which is not annihilated by any annihilation operator and apply the product of all annihilation operators to this state. Electrons and positrons represent holes in this sea and are created by applying creation operators. The states have positive energy with respect to the ground state. The aesthetic problem of this quantization is that ground state has an infinitely high negative energy.
2. In TGD framework one could change the role of creation and annihilation operators so that the ground state would be obtained by applying the product of all creation operators to vacuum. This state would have infinite positive energy. Fermions and anti-fermions would be holes in Dirac sea of positive energy and behave as negative energy quanta. One might expect that these two quantizations correspond to two different time orientations for the space-time surface.

1. Two manners to circumvent the infinite vacuum energy

The infinite vacuum energy is definitely something very unsatisfactory, and one should overcome this problem somehow. The most elegant and predictive variant of TGD inspired cosmology assumes that the net energy of the Universe vanishes so that the universe could have been created intentionally from vacuum (and be created again and again in each quantum jump). The vanishing of the total energy follows automatically if one poses the condition that the energy flow through the light cone boundary ($H = M_+^4 \times CP_2$) vanishes. This requires that also fermionic vacuum energies cancel each other. There are two manners to achieve the cancellation.

1. If positive and negative energy space-time sheets are always created in a pairwise manner their vacuum energies could compensate each other, at least so if some additional conditions are satisfied. The success of elementary particle physics requires that this mechanism is at work in elementary particle length scales.
2. Vacuum energies could also cancel each other for each space-time sheet separately. This is achieved if the roles of creation and annihilation operators for either fermions or anti-fermions are exchanged. This implies automatically matter antimatter asymmetry since either fermions or anti-fermions would have negative energies. This option could be realized in long length scales and explain the absence of antimatter from the Universe as absence of positive energy antimatter. It would thus seem that all four ground states states are in principle possible and that the ground state characterizes the phase of matter.

2. Zero energy vacuum is matter-antimatter asymmetric

Consider now in more detail the latter option 2) assuming for definiteness that it is anti-fermions for which the roles of creation and annihilation operators are exchanged. The ground state is obtained by applying the product of all fermion annihilation operators and anti-fermion creation operators to vacuum. Fermions represent holes in a completely filled negative energy Dirac sea and have positive energy. Anti-fermions represent holes in positive energy Dirac sea and have thus negative energy. In this ground state annihilation of photon pair is possible only to a fermion with positive and anti-fermion with negative energy.

Obviously the state is matter-antimatter asymmetric since anti-fermions cannot appear as positive energy holes. Negative energy antimatter could be present but could have remained invisible. For instance, Pauli Exclusion Principle would make the scattering of negative energy anti-fermions impossible in the case that there are not sufficiently many holes in the sea. The same occurs for condensed matter electrons below the surface of the Fermi sphere. Even in the case that negative energy anti-fermions are present abundantly, they might have escaped detection. Due to the prevailing dogmas,

no-one has tried to detect signatures for the scattering of negative energy anti-fermions or two photon annihilation to a pair of positive energy fermion and negative energy anti-fermion.

3. *Creation of matter from vacuum by annihilation of laser waves and their phase conjugates?*

The possibility of negative energy anti-fermions suggests a new energy technology. Photons and their phase conjugates with opposite energies could only annihilate to a pair of positive energy fermion and negative energy anti-fermion. Vacuum could effectively serve as an unlimited source of positive energy and make creation of matter from nothing literally possible. The idea could be tested by allowing laser beams and their phase conjugates to interact and by looking whether fermions pop out via two-photon annihilation. Fermion-anti-fermion pairs with arbitrarily large fermion masses could be generated by utilizing photons of arbitrarily low energy. The energies of the final state fermion is completely fixed from conservation laws so that it should be relatively easy to check whether the process really occurs. Generalized Feynman rules predict the cross section for the process and it should behave as $\sigma \propto \alpha^2/m^2$, where m is the mass of the fermion so that annihilation to electrons is the best candidate for study. Bio-systems might have already invented intentional generation of matter in this manner. Certainly the possible new energy technology should be applied with some caution in order to not to build a new quasar!

4.2.2 Is the TGD view about phase conjugate waves consistent with the existent wisdom?

A priori it is not obvious that the TGD based identification of phase conjugate waves as negative energy photons/topological light rays is consistent with what is known about phase conjugate waves. The best manner to check this is to translate the standard physics description of the basic mechanisms producing phase conjugate waves to the language of TGD. This should also provide new insights about how self-organization by the emission of negative energy photons proceeds in non-linear media.

Basic mechanism producing phase conjugate waves

There are two basic mechanisms producing phase conjugate waves. The physics believed to be behind these mechanisms is summarized in an enjoyable manner in the book of D. M. Pepper [16], and in the review article of V. V. Shunov and B. Ya. Zeldovich [17], who are pioneers of optical phase conjugation. The mechanisms rely on four-wave mixing and stimulated Brillouin scattering. Both mechanisms can be modelled using the notion of a dynamical hologram. In TGD framework dynamical hologram can be regarded as a spontaneously generated self-organizing hologram resulting by the emission of negative energy photons. The reference laser beam is quite generally pulsed. This raises the question whether the phase conjugate photons are produced by negative energy scalar wave pulses inducing negative energy "acceleration radiation" as the (em- or Z^0 -) charged particles are accelerated at the space-time sheets representing scalar wave pulses.

1. *Four-wave mixing*

Consider first four-wave mixing. The basic observation is that already in the case of ordinary hologram a phase conjugate beam is generated when the reference beam irradiating the hologram has a direction opposite to that of the original reference beam. The idea is to replace the static hologram with a dynamic hologram by utilizing reference beams moving in opposite directions simultaneously besides the probe beam coming from the object, so that the beams used to construct and read the hologram are simultaneously present. Either reference beam can be thought of as being scattered from the interference pattern created by the other beams and producing the phase conjugate wave. The resulting phase conjugate wave moves in a direction opposite to the probe beam, just as in the case of the ordinary hologram. The dynamic hologram is created in the non-linear medium whose properties are affected by the interference pattern formed by the beams.

TGD description would be that the interference of the three beams induces self-organization of the non-linear medium to a higher energy state representing the dynamic hologram and that this occurs by the emission of the phase conjugate wave having negative energy. This means the breaking of the second law of thermodynamics. The phase conjugate waves are dissipative structures but the dissipation takes place in a reversed direction of geometric time. To be precise, classical fields can

be seen as symbolic representations for the dissipation at quantum level and possible by the non-determinism of Kähler action. This explains the strange features of phase conjugate waves.

2. Stimulated Brillouin scattering

Stimulated Brillouin scattering was first discovered to produce phase conjugate waves [17] by Boris Ya. Zeldovich and his colleagues, the Russian pioneers of optical phase conjugation. Only single incoming reference beam is used and the secondary reference beam in the opposite direction appears spontaneously. In this case three-wave scattering without probe beam is in question and interference pattern is solely due to the interference of the reference beams. The dynamical hologram is realized as an acoustic wave pattern from which either reference beam can be said to scatter. The phase conjugate wave is generated only above a critical power feed for the incoming beam. The incoming beam can be distorted in the directions transversal to the primary beam by allowing it to traverse an inhomogeneous glass plate. The resulting phase conjugate beam traverses back through the inhomogeneous glass plate and turns out to be free of any distortions. Obviously this demonstrates the occurrence of the time reversal.

The standard description for what happens runs as follows.

1. The process is initiated by the scattering of photons from thermal phonons in the direction of the primary reference beam and reversing thus their direction. By energy conservation the frequency difference for the two light beams corresponds to the frequency of the acoustic wave: $\Delta\omega/\omega = v/c$, where v is the sound velocity.
2. Acoustic wave generates a periodic longitudinal density gradient such that the zones of low and high density are at a distance of *half* wave length: this follows from the fact that the scattered phonons receive *twice* the momentum of photon. In this kind of situation total reflection occurs from each layer and this amplifies the secondary light beam which in turn amplifies the sound wave. A more familiar example of total reflection is the reflection of light on water having oil layer at its surface. The varying thickness of this layer gives rise to a rainbow like appearance of the scattered light. Also a phase conjugate beam is created in the process.

In TGD framework situation can be seen as a self-organization process in which the self-organizing acoustic wave gains energy by emitting negative energy photons: obviously an over unity energy production breaking the second law of thermodynamics is in question. One could even say that non-linear medium builds a primitive sensory representation of the interference pattern.

1. At the first step the photons of the primary reference beam are scattered and generate a weak secondary reference beam in an opposite direction. The resulting interference pattern in turn excites a weak acoustic wave.
2. The acoustic wave amplifies itself when phonons emit pairs of positive and negative energy photons with energies $E_1 > 0$ and $E_2 < 0$ such that the sum of their energies corresponds to the energy E_{ph} gained by the phonon: $E_1 - |E_2| = E_{ph}$. The rate of this process is proportional to the numbers N_+ and N_- of positive and negative energy photons already present in the state: the mechanism of induced emission is at work. Positive energy photons amplify the induced reference beam and negative energy photons amplify the phase conjugate wave. Also in this case one can say that the non-linear medium builds up spontaneously a dynamical hologram about the interference pattern.

Over unity effects and error correction

The emission of negative energy photons makes possible over unity effects claimed by free energy enthusiasts. Over unity effects need not be in conflict with the standard wisdom that phase conjugate waves utilize the energy of pumping laser or probe beam. In the case of stimulated Brillouin scattering the negative energy photons are received by the population inverted lasers producing the reference beam with the consequence that particles drop to the ground state without emission of positive energy photons. In the case of 4-wave mixing the negative energy photons could be received by the laser producing the probe beam. An interesting possibility is that negative energy beams could be produced also in the direction of reference beam and pump energy from the corresponding lasers.

Error correction of a signal defines a variant of the time mirror mechanism. In this case positive and negative energy signals are actually at different sides of the time mirror. The positive energy photons of the signal to be corrected annihilate with the negative energy photons of the phase conjugate signal which comes from the geometric future and is a temporal mirror image of the positive energy signal. The pulsed phase conjugate mirror would be an analog a sequence of ordinary mirrors. Pulses create a temporal sequence of time mirrors most naturally located at the ends of pulses so that positive energy photons from N :th pulse annihilate with the negative energy photons from $N + 1$:th pulse.

TGD based description for the interference of reference beams

It is interesting to find whether TGD allows the field pattern resulting as a superposition of reference beams moving in opposite direction as a solution of field equations. Topological light rays do not allow this kind of field patterns. As a special case this field pattern corresponds to a transversal standing wave of form $\cos(\omega t) \times \cos(\omega z)$ (using units $c = 1$). Waves for which the interference pattern moves (say in the case of stimulated Brillouin scattering), result when the frequencies are different. These field patterns are obtained as Lorentz transforms of the standing wave pattern.

Since the Kähler current vanishes for this kind of waves the field equations state that the contraction of the energy momentum tensor with the second fundamental form vanishes. It will be found that the field equations reduce to massless wave equation in the approximation that classical gravitational effects are negligible. It is however not clear whether this kind of solution is possible as genuinely asymptotic self-organization pattern having a precisely vanishing Kähler current.

The solution ansatz is based on the assumption that the CP_2 projection belongs to the homologically non-trivial geodesic sphere S^2 of CP_2 . Let the standard spherical coordinates of S^2 be $(U \equiv \cos(\theta), \Phi)$. Let M^4 coordinates be (t, z, x, y) . The task is to imbed the electric field representing a standing wave and having components

$$E_i = \epsilon_i \times \cos(\omega t) \times \cos(\omega z) , \quad (4.2.1)$$

as a four-surface to $X^4 \subset M_+^4 \times S^2$. The polarization vector ϵ_i lies in the (x, y) -plane.

The 4-vector potential associated with this field is

$$A_\mu = \frac{\epsilon_\mu}{\omega} \times \sin(\omega t) \times \cos(\omega z) . \quad (4.2.2)$$

Note that the scalar potential $\phi = A_t$ vanishes. The induced Kähler gauge potential is of form

$$A_\mu = U \partial_\mu \Phi , \quad (4.2.3)$$

and from this the simplest ansatz (fixed only apart from a canonical transformation of CP_2) reproducing A_μ is

$$U = a \times \sin(\omega t) \times \cos(\omega z) , \quad \Phi = b \times \epsilon_\mu x^\mu , \quad ab = \frac{1}{\omega} . \quad (4.2.4)$$

In the approximation that the induced metric is flat, action density vanishes, and the energy momentum tensor has only the longitudinal components T^{tt} and T^{zz} and is proportional to the flat metric. Field equations reduce to massless wave equation in longitudinal degrees of freedom: $D^2 u = 0$ and $D^2 \Phi = 0$, $D = \partial_t^2 - \partial_z^2$. For the proposed solution ansatz they are satisfied identically.

The fact that solution has a 2-dimensional CP_2 projection means that it represents a self-organization pattern with dissipation only due to the possible non-vanishing of the Kähler 4-current and characterized by the strength of classical gravitational interaction. Classical gravitation might imply a non-vanishing Kähler four-current.

4.2.3 Pulses, Tesla transformers, and binary coils

The function of quite a many free energy systems involve sharp pulse sequences. Often the bi-filar coil invented by Tesla [18] are used. Also Caduceus coil having also binary structure is utilized. Together with general TGD based vision this leads to a theoretical picture allowing to understand the visions of Tesla theoretically.

The vision briefly

A very concise summary of the model goes as follows.

1. The basic prediction of TGD are negative energy topological light rays propagating backwards in geometric time. They can be accompanied by self-generated negative energy photons since in general case topological light rays carry light like vacuum 4-current. The interpretation as counterparts of phase conjugate laser waves [16] seems to make sense. A sequence of pulses carrying a constant electric field forces current carriers to accelerate repeatedly provided the frequency of the pulses is sufficiently low for charged to come at rest. A decelerating system emits its energy as positive energy photons whereas the accelerating system might receive its energy by emitting negative energy photons if deceleration and acceleration are genuine time reversals of each other.
2. Negative energy photons are absorbed by any system which contains (possibly many-sheeted) population inverted lasers with appropriate excitation energy when bosonic particles return to their ground states. If sufficiently many bosonic particles return to the ground state, a phase transition return to the ground state occurs and is analogous to induced emission. Large number of positive energy photons are generated and a weak negative energy control signal is amplified to much stronger positive energy signal. The resulting energy is identifiable as "free energy".

The generation of negative energy photons breaks second law. In TGD Universe second law however holds true at a given p-adic length scale only in time scales longer than the corresponding p-adic time scale. This means that field patterns having a duration below the relevant p-adic time scale can appear as negative energy topological light rays. Sharp electric pulses carrying a constant electric field are ideal in this respect.

Suppose that electric pulses are feeded into a binary coil for which the loops of the primary and secondary coils are on top of each other and very near to each other. Electric pulses induce currents in the primary coil. Due to the large mutual inductance between loops of the primary and secondary coils composing the binary coil, the current generated by the pulse in the primary loop is transmitted inductively to the nearby second loop, which in turn generates a positive feedback to primary. Thus the current is amplified and the propagation of the electric pulse induces a propagation of large rapidly varying currents in coils rotating in opposite direction so that the magnetic flux inside the binary coil is small. First of all, this means that the sequence of electric pulses induces a currents through the two components of the binary coil by effectively reducing the inductance of the coil. Secondly, the amplification of the current means amplified acceleration of the current carriers optimal for the generation of negative energy photons as time reversed brehmstrahlung.

There are good reasons to expect that living matter has discovered the analogs of binary coils long before humans, even before Tesla. Binary structures, such as DNA double strand and cell membrane consisting of two lipid layers, are good candidates for the counterparts of binary coils and might play key control in the bio-control by serving as generators of negative energy photons in turn controlling the generation of positive energy photons.

Do electric pulses generate scalar wave pulses?

Interesting questions are related to the behavior of the electric field inside ordinary coils, binary coils, and in particular bi-filar coils. It seems that the expressive power of Maxwell's theory might not be enough here. It seems that the electric pulses propagating in any circuit could correspond to TGD counterparts of Tesla's scalar wave pulses.

1. The unipolar electric field is discontinuous at the ends of an ideal square pulse. In Maxwell's equations the rotor of the magnetic field equates to the sum of the current term j and the

displacement current $\partial E/\partial t$. Either an infinitely sharp induction peak is allowed in the magnetic field or the displacement current must be compensated by the current term. In realistic case there is short rising time during which electric field increases.

2. In Maxwell's electrodynamics a very high (ideally infinitely strong instantaneous) ohmic current would be needed to compensate the displacement current. This seems implausible. In TGD however vacuum charges and currents are possible. The electric square pulse is analogous to a moving capacitor and the charges of the capacitor plates correspond to vacuum charges. At the level of space-time geometry the plates would correspond to propagating edges of the 3-surface. The induced electric field E_{rot} would induce a current pulse, whose direction would change in the middle of the magnetic pulse.
3. TGD indeed predicts the existence of scalar wave pulses [G1]. These pulses represent electric flux quanta, 3-surfaces inside which there is an almost constant longitudinal electric field. A capacitor moving with the velocity of light would be the analogy. These solutions are not possible in Maxwell's theory. Because also the pulses moving in circuits are very similar, there is a temptation to identify them as scalar wave pulses. In this case the effective propagation velocity is reduced below light velocity by the interaction with matter. Intuitively, the particles topologically condensed in the region of 3-surface representing the pulse make it massive and slow down the effective speed of propagation.
4. The first guess that a scalar wave pulse of duration τ results when a voltage in circuit is switched on for time τ , does not make sense since the pulse could last for an arbitrarily long time and have arbitrarily long length. Experimental study of a pulsed system involving a FET serving as a switch and a capacitor in parallel suggests that a positive energy scalar wave pulse results in switching on and has a duration equal to the rising time τ_r of the voltage. Negative energy scalar wave pulse moving into geometric past results in the switching off of the voltage. In switching on the capacitor absorbs a negative energy scalar wave pulse coming from geometric future and is neutralized. In the similar manner the capacitor in future re-charges by absorbing positive energy pulse from the geometric past.
5. An interesting question is whether scalar wave pulses propagating through (say) bi-filar coil could increase its capacitance dramatically by providing primary and secondary coils with opposite vacuum charges. If scalar wave pulse collects also ordinary charge on its "plates" when it moves through the system, it could become a dynamical capacitor, and transform also the system through which it traverses to a capacitor. The experimentation with bi-filar coil indeed forces to conclude that its capacitance can be much larger than expected on basis of geometric arguments.
6. One might imagine that the scalar wave pulses could leak out of the system. For instance, this might happen if the second end of the coil is free. Tesla indeed reported a production of scalar wave pulses using a transformer whose primary coil was fed by a sequence of unipolar pulses. These pulses were amplified in a secondary coil in whose second end was free. Abnormally high voltage amplification with no current in secondary coil was reported [35].
7. If the propagation velocity of the scalar wave pulse is light velocity, the time T would be the time taken by the pulse to propagate through the first half of the bi-filar coil: $T = Z/v$, where Z is the length of the wire in the bi-filar coil and $v = c$ is light velocity. For $v = c$ T would be 3.3 ns if the length of the wire is 1 meter. The interaction with the matter induces inertial effects and is expected to reduce the effective propagation velocity of the scalar wave pulse representing the electric pulse to $v < c$.

Could electric pulses in circuits correspond to separate space-time sheets?

Scalar wave pulses could correspond directly to the space-time sheets of electric flux quanta moving with light velocity predicted by TGD [G1] rather than being regions of constant electric field at the space-time sheet of wire. These flux quanta would move along wire and have join along boundaries contacts connecting the space-time sheet of the flux quantum with the boundaries of small co-moving holes associated with the circuit's space-time sheet. Charged particles could flow to the flux quantum along these bridges at the first end of the electric flux quantum, accelerate there practically without

dissipation, and flow possibly also back at the second end of the flux quantum. The direction of the flow would be determined by the sign of the charge. This would allow anomalous acceleration of the current carriers making it possible to emit negative energy photons up to energies determined by the voltage difference associated with the flux quantum. The lowering of the effective propagation velocity would be a genuine quantum effect based on the same mechanism as the lowering of the effect phase velocity of topological light rays.

The energies of the "acceleration radiation" would be quantized since the quanta would have frequencies $f_n = n/T_p$, where T_p is the duration of the scalar wave pulse. The duration of the scalar wave pulse should correspond to a natural time scale associated with the generation of the scalar wave pulse. For instance, if the scalar wave pulse is generated when a voltage in a circuit is rapidly switched on, the scalar wave pulse would naturally correspond to the rising time τ_r of the voltage. This quantization is a unique signature of the negative energy radiation.

Scalar wave pulse is like a moving capacitor and should be attracted or repelled by a real charged capacitor depending on the sign of its polarization. Therefore scalar wave pulse could be reflected from a heavily charged capacitor and begin to move forth and back around the loop connecting the plates of the capacitor in a circuit. The pulse could even move between capacitor plates forth and back. If binary coil is coupled between the capacitor the pulse should move forth and back through it. If scalar wave pulses correspond to separate space-time sheets they can leak out of the system. The open ends of the secondary coils used by Tesla in his transformers might be the places where the leakage occurs. The emission of a new kind of radiation observed by Modanese and Pokletnov [22] to accompany the discharge of a capacitor for which the negatively charged plate was super-conducting might represent the emission of scalar wave pulses [G1].

Scalar wave pulses as producers of phase conjugate waves and time mirror mechanism

Tesla transformers use ordinary coils as primary coils and an open coil as a secondary coil. On basis of his experimental work Tesla claimed that Tesla transformers allow an anomalously high voltage amplification. Strangely, Tesla found no current in the secondary coil but the transformers induced charging of various metallic objects in large regions surrounding the transformer. This effect was able to penetrate even through Faraday cage.

The bi-filar coils discovered by Tesla [18], which are feeded by sharp unipolar electric pulses carrying constant electric field and analogous to moving capacitors, occur repeatedly in various free energy devices. Caduceus coil is second binary coil appearing very often. This would suggest that coils with a binary structure somehow produce phase conjugate laser waves (negative energy topological light rays accompanied by negative energy photons). These in turn would induce the dropping of bosonic charged particles to larger space-time sheets as a phenomenon analogous to induced emission when the intensity of negative energy photons is above some threshold. The challenge is to understand how square pulses propagating both in ordinary and binary coils manage to produce phase conjugated light.

What is so special in the unipolar electric pulses circulating in binary coils? If one wants to produce negative energy photons, one must break the second law of thermodynamics. TGD predicts that in a given n-ary p-adic length scale $L(n, k)$ (size of the space-time sheet) this is possible below the n-ary p-adic time scale $T(n, k) = L(n, k)/c$. One must only produce pulses having duration shorter than the p-adic time scale $T(n, k)$. The sharp electric pulses are excellent candidates for this kind of pulses since they accelerate the current carriers and during this period they can emit negative energy photons as "acceleration radiation" with quantized frequencies $f_n = n/T_p$, T_p the duration of the scalar wave pulse. If the pulses correspond to their own space-time sheets dissipation is negligible and the intensity of acceleration radiation is maximal.

An especially interesting situation arises when the energies of the negative photons radiated by the charged particles accelerated inside the scalar wave pulse correspond to the increment of a zero point kinetic energy for some charged particle when it drops to a larger space-time sheet. In this case the negative energy radiation could make possible time mirror mechanism by generating a cascade like dropping of charged particles and an amplified emission of positive energy photons. This hypothesis is testable by choosing suitably the value of the rising time τ_r .

There are natural time scales associated with pulsed binary coils. One class of important frequencies would correspond to harmonic multiples for the frequency $f = 1/\tau_p$, the duration of electric pulse. Second time scale corresponds to the frequency defined by the duration of the scalar wave pulse and

is assumed to correspond to the rising time τ_r of the electric pulse. A second important time scale is the time interval between the pulses which must be so long that the charges have time to come at rest. One expects that this time scale is of the order of $\tau = L/R$, where L and R characterize the primary of the binary coil. A third important time scale is the duration of the magnetic pulses generated in the pulsed binary coil. Besides these time scales important time scales are the time scales determined by the basic parameters L, C, R of the primary (secondary) of the binary coil.

As far as I know, Tesla used ordinary coils in his transformers and observed anomalous voltage amplification and other strange effects. If the time interval between voltage pulses is so long that the charges dissipate their energy, charges are indeed accelerated in a constant electric field and the emission of negative energy photons should occur. Hence also ordinary pulsed coil, perhaps when used as the primary of the Tesla transformer, could allow the exotic effects due to the generation of negative energy photons. In particular, if this process leads to the phase transitions increasing the conductivity of the wire then the current in the primary coil increases and therefore also the current in the secondary coil increases beyond the value predicted by Maxwell's theory.

Bio-systems and unipolar pulses

One might think that besides Tesla also bio-systems might have invented the sharp pulses as a manner to break second law temporarily and produce negative energy topological light rays crucial for all basic mechanisms in TGD based quantum biology and theory of consciousness. Perhaps one function of nerve pulse is to produce phase conjugate waves and perhaps nerve pulse can be switched on by a scalar wave pulse reducing the membrane potential below the critical value.

This suggests the existence of biological variants of binary coils. Bio-systems are full of binary structures such as DNA double strand and cell membrane (consisting of two lipid layers). It is tempting to think that DNA double strand is a variant of bi-filar coil in which scalar wave pulses propagate along strand (associated with say gene) and return along the conjugate strand. Also now the effective inductance of the system would grow from zero to some maximum value and return back to zero and phase conjugate light would be generated. As a matter fact, the TGD based model for bio-photons lead to the hypothesis that the strand/conjugate strand generates positive/negative energy MEs and that these MEs move in opposite directions along strands [K6].

4.2.4 Could negative energy photons induce the transition to effective superconductivity?

The generation of negative energy photons involves temporary breakdown of the second law. Therefore the minimization of the resistance of the relevant part of the circuit, say binary coil, should be favorable for the effect.

TGD based new physics might provide a possible mechanism reducing the resistance. If part of the current carrying electrons of the bi-filar coil drops down to the larger space-time sheets, where they propagate as Cooper pairs, the resistance of the system is reduced. The research group led by Hafedh Abdelmeik has found that the electric conductivity of axon grows by a factor of order 10 below a certain critical temperature, which is in the range 30-40 C of physiological temperatures [23]. The TGD based model [24, M4] explains the findings correctly at quantitative level.

A variant of this mechanism might be at work also in the case of electric circuits if appropriate conditions are satisfied.

1. The model for the realization of intentionality and motor activity [K1] relies on a process, which proceeds from long to short time and length scales, much like a desire for some action in an organization proceeds from boss to the bosses at lower level. In the same manner a hierarchy of phase transitions could proceed from longer to shorter length and time scales and reduce the resistance and increase the upper limit for the energy of negative energy photons.
2. The pulses propagating in the binary coil could produce already in the normal situation a sufficient amount of negative energy photons at low frequencies to induce a phase transition increasing the conductivity. The growth of the intensity of the negative energy photons emitted at higher frequencies could in turn induce a similar phase transition in a shorter p-adic length scale and corresponding to higher zero point kinetic energy. At every stage the negative energy photons could first cool the system so that the phase transition occurs more easily. The dropped

Cooper pairs would in turn increase the portion of the supra current flowing at the ground state space-time sheet and thus conductivity.

4.3 The scalar waves of Tesla in TGD framework

The scalar waves or so called non-Hertzian waves of Nikola Tesla belong to the fringe region of science. Many proponents of free energy believe that scalar waves might provide a basis for a new energy and communication technologies. Tesla himself was isolated from the official science and found no place in text books because his hypothesis about scalar waves did not fit within the framework of the Maxwell's electrodynamics. Personally I justified my personal prejudices against scalar waves by the observation that the formulations for the notion of scalar waves that I had seen seemed to be in a conflict with the cherished gauge invariance of gauge theories. The discussions with a Finnish free energy enthusiast Juha Hartikka however led me to reconsider the status of the scalar waves.

4.3.1 The properties of the scalar waves

Perhaps the most important properties of the scalar waves are following.

1. Scalar waves involve some kind of oscillatory process in the direction of the propagation of the wave. The analogy with sound waves suggests that the oscillation could relate to charge density, or more generally to 4-current in the direction of the wave. Even massless extremals (MEs), which are essentially topological light rays, involve vacuum current and vacuum charge density which oscillates in the direction of propagation.
2. Scalar waves are believed to carry electric field in the direction of the wave motion so that the identification of MEs as scalar waves is not possible. The presence of only electric field means that scalar wave is characterized solely by the scalar potential. This kind of solution is excluded by the gauge invariance and linearity of Maxwell's electrodynamics in vacuum.

4.3.2 Could nonlinearity of TGD allow scalar waves?

One is led to ask whether the nonlinearity of TGD might allow existence for scalar waves.

1. In TGD based electrodynamics CP_2 coordinates are the primary dynamical degrees of freedom gauge fields being secondary dynamical variables induced from the spinor curvature of CP_2 . Field equations are extremely nonlinear allowing among other things vacuum 4-currents (even Faraday's unipolar generator involves vacuum charge density changing its sign when the direction of rotation of magnet changes its sign). This gives hopes about finding solutions of field equations with the properties assigned to the hypothetical scalar waves.
2. Interestingly, in TGD framework the canonical symmetries of CP_2 are dynamical symmetries and act as isometries of the configuration space of 3-surfaces. Canonical transformations act formally as $U(1)$ gauge transformations but, rather than being gauge symmetries, they are dynamical generating new physical configurations and are partially responsible for the quantum spin glass degeneracy of the TGD universe. As a matter fact, also diffeomorphisms of M^4 act as dynamical symmetries in the lowest order.
3. Magnetic flux tubes represent fundamental solutions of field equations and the simplest magnetic flux tubes can be characterized as maps from a region of a 2-dimensional Euclidian hyperplane E^2 of Minkowski space to a geodesic sphere S^2 of CP_2 .
4. Electric-magnetic duality is a fundamental symmetry of the configuration space geometry. Therefore there should exist solutions dual to the magnetic flux tubes carrying only electric fields and perhaps allowing interpretation as waves. These solutions would be characterized by a map from a region of the Minkowskian hyperplane M^2 of Minkowski space to S^2 . This kind solution ansatz makes sense since it formally provides the solutions of a field theory from M^2 to S^2 .

4.3.3 Lowest order solution ansatz

One can write the field equations explicitly. They are however extremely nonlinear and without physical intuition one cannot say much about the solution spectrum of these equations. One can however make simplifying assumptions to get grasp to the problem.

i) The effect of classical gravitation can be assumed to be extremely weak except possibly at some singular regions associated with the solutions.

ii) In Maxwellian theory without sources gauge current vanishes identically. This would suggest that it is good to start from a zeroth order solution ansatz with this property so that the non-vanishing of the vacuum current would be solely due to gravitational effects. It deserves to be noticed that Tesla proposed also that non-Hertzian radiation fields involve a kind of radiation charge.

In principle, one can imbed a portion of any solution of Maxwell's equations in empty space as a space-time sheet (note the occurrence of the topological quantization) using M^4 coordinates as preferred coordinates. Field equations are satisfied in the lowest order in R^2 . The canonical symmetries of CP_2 act as dynamical symmetries for these solution ansätze and one obtains infinite degeneracy of the space-time surfaces representing the same Kähler field.

iii) Constant electric field represents the simplest field configuration one can imagine. Therefore it is reasonable to start with this kind of solution ansatz and to look whether gravitational corrections affect the solution and bring in the wave aspect.

iv) Since wave motion is hoped to result, it is useful to choose the space-time coordinates in an appropriate manner. Light-like coordinates (x^+, x^-, x, y) of M^4 are thus very natural. They are defined by the conditions

$$t = (x^+ + x^-)/2 \quad , \quad z = (x^+ - x^-)/2 \quad ,$$

with (t, x, y, z) referring to the linear Minkowski coordinates such that t is time coordinate. In these coordinates the line element of M^2 has the form $ds^2 = -2dx^+dx^-$ so that one has $g_{+-} = -1$.

v) Using the spherical coordinates $(u = \cos(\Theta), \Phi)$ for the geodesic sphere S^2 of CP_2 , the zeroth order solution ansatz has the following form:

$$u \equiv u_0 = \omega_1 x^+ \quad , \quad \Phi \equiv \Phi_0 = \omega_2 x^- \quad . \quad (4.3.1)$$

Since electromagnetic, Z^0 and color fields are proportional to Kähler form for the solution type considered, one can restrict the consideration to the induced Kähler form. Denoting the Kähler form of CP_2 by J_{kl} , by noticing that S^2 Kähler form is given by $J_{u\Phi} = 1$ (forgetting the precise normalization factor), and using the expressions $[s_{uu} = R^2/(1-u^2), s_{\Phi\Phi} = R^2(1-u^2)]$ for the metric of S^2 , one can write the induced line element and the non-vanishing component of the induced Kähler form as

$$\begin{aligned} ds^2 &= -2dx^+dx^- + \frac{R^2\omega_1^2}{1-u^2}(dx^+)^2 + R^2\omega_2^2(1-u^2)(dx^-)^2 - dx^2 - dy^2 \quad , \\ J_{+-} &= \partial_+ u \partial_- \Phi = \omega_1 \omega_2 \quad , \\ J^{+-} &= \frac{\omega_1 \omega_2}{\det(g)} \quad . \end{aligned} \quad (4.3.2)$$

Since the determinant of the induced metric is constant, J^{+-} describes constant electric field and that Kähler current j^α is vanishes. This means that Maxwell's equations hold true in the zeroth order approximation as required.

Apart from the normalization factors the energy momentum tensor in the longitudinal degrees of freedom is given by

$$T^{\alpha\beta}(long) = g^{\alpha\beta} L/4 \quad ,$$

In the transversal degrees of freedom similar expression but with opposite sign holds true. Here L is Kähler action which is essentially electric energy density and constant.

In M^4 degrees of freedom the field equations express conservation of the energy momentum currents and are satisfied to order R^2 since the action is constant. These equations imply that action density

is constant. This forces to ask whether all perturbatively constructible solutions represent a constant Kähler electric field locally.

In CP_2 degrees of freedom field equations involve a sum of two terms: the first term involves the contraction of the energy momentum tensor with the second fundamental form whereas the second term involves Kähler current. Since Kähler current vanishes, the latter term vanishes and one can say that field equations are satisfied in zeroth order approximation (the term involving energy momentum tensor is proportional to CP_2 length squared and thus small). For exactly vanishing vacuum current the field equations would reduce to the equations for a minimal surface:

$$g^{\alpha\beta} D_\beta \partial_\alpha h^k = 0 \quad , \quad (4.3.3)$$

where the imbedding space coordinates h^k corresponds to u and Φ now. The same equations result also in M^4 degrees of freedom by requiring that the terms of order R^2 in the equation for the energy momentum conservation vanish.

This equation is not satisfied exactly as is easy to see. The non-vanishing components of the trace of the second fundamental form are given by

$$\begin{aligned} g^{\alpha\beta} D_\beta \partial_\alpha u &= -\{\Phi_\Phi^u\} \omega_2^2 \times [1 - g^{++} \omega_1^2 R^2 / (1 - u^2)] \quad , \\ g^{\alpha\beta} D_\beta \partial_\alpha \Phi &= -\{u_\Phi^\Phi\} \omega_1 \omega_2 \times [1 - g^{--} \omega_2^2 R^2 (1 - u^2)] \quad . \end{aligned} \quad (4.3.4)$$

Here $\{\beta_\gamma^\alpha\}$ denote the components of the Riemann connection for sphere. It is seen that the connection term gives contributions which vanish only at $u = 0$ which corresponds to the equator of the geodesic sphere S^2 . At poles the minimal surface condition fails to be satisfied.

4.3.4 First order corrections to the solution ansatz

To take into account gravitational corrections one must modify the solution ansatz in such a manner that x^- does not appear in the field equations at all: this guarantees that field equations reduce to ordinary differential equations. The modification is following:

$$u = u_0 + u_1(x^+) \quad , \quad \Phi = \Phi_0 + \Phi_1(x^+) \quad . \quad (4.3.5)$$

The modification affects the electric field and vacuum current and allows the compensation of the terms resulting from the contractions of the energy momentum tensor and vacuum current. The modification means that wave equations are still satisfied for u and Φ . Note that second fundamental form does not contain second derivative terms in the lowest order approximation.

The derivation of the differential equations for u_1 and Φ_1 is completely straightforward but requires some patience with numerical factors (reader should check sign factors and numerical factors).

1. Calculate the the current contraction term

$$j^\alpha [J_r^k \partial_\alpha h^r - J_\alpha^\mu \partial_\mu h^k]$$

and energy momentum tensor contraction term

$$T^{\alpha\beta} D_\beta \partial_\alpha h^k$$

and equate these terms. Effective two-dimensionality makes the explicit calculations relatively simple.

2. The equations for u and Φ in terms of j^\pm read as

$$j^-(1 - u_0^2) + j^+ \epsilon_1 \epsilon_2 = \{\Phi_\Phi^u\} \frac{K \epsilon_2^2}{2} \equiv X_1 \quad ,$$

$$j^+ \frac{1}{(1 - u_0^2)} j^- \epsilon_2^2 = -2\{u_\Phi^\Phi\} K \epsilon_1 \epsilon_2 \equiv X_2 \quad ,$$

Here the notations $\epsilon_i = \omega_i R$ and $K = \omega_1 \omega_2^2$ are used. Linear second order differential equations are in question with the right side serving as an inhomogeneity term.

3. One can solve j^+ and j^- from these equations to get

$$\begin{pmatrix} j^+ \\ j^- \end{pmatrix} = \frac{1}{\epsilon_1 \epsilon_2^3 - 1} \times \begin{pmatrix} \epsilon_2^2 & -(1 - u_0^2) \\ -1/(1 - u_0^2) & \epsilon_1 \epsilon_2 \end{pmatrix} \times \begin{pmatrix} X_1 \\ X_2 \end{pmatrix} \equiv \begin{pmatrix} Y_1 \\ Y_2 \end{pmatrix}$$

From this form one can see that j^- becomes singular at $u_0 = \pm 1$ as $1/(1 - u_0^2)$ which means that light-like vacuum current is generated. The physical interpretation is that vacuum charge density at these points which correspond to the boundaries of the solution acting as the source of the vacuum electric field is in question.

4. One can calculate j^\pm by calculating the covariant divergence of the induce Kähler field in the lowest non-trivial order. The calculation gives the following expression

$$\begin{pmatrix} j^+ \\ j^- \end{pmatrix} = \omega_1 \begin{pmatrix} u_0 \partial_+^2 u_1 + \epsilon_1 \epsilon_2 (1 - u_0^2) \partial_+^2 \Phi_1 \\ \omega_1 \epsilon_2 \partial_+^2 u_1 - \epsilon_1 (1 - u_0^2) \partial_+^2 \Phi_1 \end{pmatrix}$$

5. For u_1 one finds the equation

$$\begin{aligned} \partial_+^2 u_1 + \epsilon_1 \epsilon_2^2 \omega_1 u_0 \partial_+ u_1 &= \frac{1}{\omega_1} \times (Y_1 + \epsilon_1 Y_2) \\ &= \frac{\omega_2^2}{2} \frac{\epsilon_1}{\epsilon_1 \epsilon_2^3 - 1} \times u_0 \times \left[-\epsilon_2^4 (1 - u_0^2) + \epsilon_1 \epsilon_2 (-2 + \epsilon_1) - \epsilon_1^3 \epsilon_2 \frac{1}{1 - u_0^2} \right]. \end{aligned} \quad (4.3.6)$$

This equation reduces to a first order differential equation for u_1 and one can solve it by variation of integration constants. The singularity at $u = \pm 1$ implies a logarithmic singularity of the derivative

$$\partial_+ u_1 \sim \log(1 - u_0^2)$$

but u remains finite as it should.

6. One can integrate Φ_1 from the second order inhomogenous and linear equation

$$\begin{aligned} \partial_2^+ \Phi_1 &= \frac{1}{\epsilon_1 \epsilon_2 (1 - u_0^2)} [j^- - \omega_2 \partial_+^2 u_1], \\ j^- &= \frac{\omega_1 \omega_2^2 \epsilon_1 \epsilon_2}{2(\epsilon_1 \epsilon_2^3 - 1)} \times u_0 \times \left[1 - \frac{2\epsilon_1^2}{1 - u_0^2} \right], \end{aligned} \quad (4.3.7)$$

once the solution for u_1 is known. Note that the most singular part corresponds to $u_0/(1 - u_0^2)^2$ type term and one obtains logarithmic singularity also now.

4.3.5 Properties of the solution ansatz

The form of the differential equations for the first order corrections allows to conclude that the North and South poles of the geodesic sphere S^2 (the points $u_0 = \pm 1$) correspond to singularities of the solution. Both the components of the induced metric and the induced Kähler form become singular at these points. This means that classical gravitation becomes important near these points. These points correspond in the lowest order approximation to the lines $x^+ = \pm 1/\omega_1 \equiv T$ plus possibly the lines obtained by continuing the solution by assuming that $x^- = \text{constant}$ lines define a motion identifiable constant rotation along the big circle from $\theta = 0$ ($x_+ = T$) to $\theta = \pi$ ($x_+ = -T$) continuing in the same manner to $\theta = 0$ at ($x = 2T$) and so on. Therefore gravitational effects induce a periodical behavior of the solution such that gravitational effects become strong at $x^+ = (2n + 1)T$.

In the next order electric field is not constant anymore and vacuum current is generated. The contravariant component of electric field, being proportional to $1/\partial_+ u$ near singularity, vanishes at the singularity whereas the tangential component j^- of the vacuum current diverges. The vacuum current should generate coherent photons.

By a straightforward calculation one finds that the curvature scalar behaves as $R \propto 1/(1 - u_0^2)$ at the singularities so that the energy density of vacuum becomes singular and could generate a coherent state of gravitons. Since Einstein tensor vanishes identically in two-dimensional case, the longitudinal components G^{++} , G^{--} and G^{+-} of Einstein tensor vanish. The components of Einstein tensor in transverse degrees of freedom are given by $G^{\alpha\beta} = -g^{\alpha\beta} R/2$. Therefore the energy momentum tensor defined by Einstein's equations would involve only space-like momentum currents. The singularity is amplified by the fact that field energy couples to the classical gravitation with coupling which is 10^8 times stronger than the ordinary gravitational coupling. The singularity might relate to the claimed gravitational anomalies associated with the scalar waves.

As already found, Einstein tensor and gauge current have no components in the direction of x^+ . Energy-momentum tensor behaves as $1/\det(g)^{3/2}$ at the end points of the interval $[-T, T]$ and thus vanishes. Therefore conservation laws allow to restrict the solution into the x^+ interval $(-T, T)$. This restricted solution defines geometrically a particle like structure moving in x^- direction but with fields moving in x^+ direction so that one would have rather exotic kind of particle-wave dualism. In accordance with the quantum-classical correspondence, one could interpret this as classical space-time representation of the particle wave duality and the solution would be a particular example of topological field quantization. Tesla stated that this non-Hertzian waves did not weaken with distance. This is indeed the case if one interprets the signal as a finite piece of space-time moving with light velocity.

4.3.6 More general solutions representing electric field of constant action density are possible

The solution ansatz just discussed represents a constant electric field in a region of space-time moving with light velocity in the direction of x^- coordinate. Also ordinary constant electric field is a possible solution and is constructed iteratively in an essentially identical manner by starting from the solution ansatz

$$u = kz \quad , \quad \Phi = \omega t \quad . \quad (4.3.8)$$

Also now Kähler current vanishes in the lowest order and action density is constant so that lowest order field equations are satisfied. Higher order corrections are obtained using the ansatz $u_1 = u_1(z)$, $\Phi = \Phi_1(z)$. Minimal surface condition gives now essentially same kind of expressions for u_1 and Φ_1 . Also now the singularities where gravitational interaction becomes strong are at $u = \pm 1$ and one can select the solution to represent a membrane like structure with thickness $L = 2/k$.

Cell membrane space-time sheets are good candidates for the realization of this kind of solutions. If so, one might expect that classical gravitational effects become important at the boundaries of the cell membrane. More generally, bio-systems are electrets and the proposed solution type might provide a fundamental model for bio-electrets. In particular, electro-gravitational effects due to the energy of the classical electric field might be of importance.

This observation relates interestingly to the sol-gel phase transitions occurring inside cell. In these transitions large scale bound states of water molecules are formed and could make possible macro-temporally quantum coherent systems able to perform quantum computations in time scales of order say .1 seconds. These bound states would be characterized by spin glass degeneracy broken only by the classical gravitation and spin glass degeneracy would make these bound states long lived. In the case of the proposed solution ansätze spin glass degeneracy corresponds to the canonical symmetries of CP_2 generating new solutions representing constant electric field.

Also M^4 diffeomorphisms are symmetries of the field equations broken only by the classical gravitation. Approximate diffeomorphism invariance means that one obtains solutions for which the lines of electric flux are curved and only the action density stays constant. In the case of magnetic flux tubes this symmetry makes possible curved magnetic flux tubes. Both electric fields and the magnetic flux tubes are fundamental for the TGD based model of living matter and relate deeply to the

electric-magnetic duality symmetry and to the quantum criticality predicting that magnetic and electric space-time regions having opposite signs of Kähler action play a role similar to the ice and water regions at critical point of water, are important physically.

4.3.7 Support for Tesla's scalar waves/classical Z^0 MEs

Recently I learned from Hans-Poul Veldhuyzen van Zanten that E. Podkletnov and G. Modanese have constructed a device [22] in which a super-conducting ceramic cathode and a copper anode cause electrical discharges in low pressure gases, at temperatures between 50 and 70 K. The voltage used is 2000 kV. Peak currents are of order 10^4 A. Cathode and anode have radii of 10 cm and their distance varies between 15 and 40 cm. There is also a magnetic field of .9 Tesla present inside the cylindrical chamber to concentrate the discharge to a smaller area. In discharges at voltage above 500 kV two new phenomena were observed. First, discharge does not look like a spark but like a flat, glowing discharge originating from the whole surface of the super-conductor. Secondly, a radiation pulse is emitted at the discharge which propagates orthogonally to the cathode, towards the anode and beyond it, in a collimated beam, apparently without an attention. Radiation pulse carries away an energy of 10^{-3} J at least. It is concluded that the radiation in question cannot be ordinary electromagnetic radiation.

The anomalous radiation was measured using various penduli at the line connecting the centers of cathode and electrode and hanging from a cotton string inside glass cylinders under vacuum. The radii of spheres were 10-25 mm and located at distances 6 m and 150 m from the installation. Various materials for the spheres were used: metal, glass, ceramics, wood, rubber, plastic. It was found that the impact on pendulum did not depend on the material but only on the mass of the pendulum which was in the range 10-50 g. Pendulum did not show any signs of heating. Measurements of the impulse taken at close distance (3-6 m) and large distance (150 m) gave identical results. The pulses were not absorbed by the media or at least, the losses of energy were negligible. The force beam does not seem to diverge and its borders are clear-cut and the width of the beam is that of the super-conducting emitter. If the pulse propagates in air, some energy should be depleted from it and lead to the weakening of the pulse. The observations of the air in the path of pulse only show that brief forward and backward movement of particles occurs.

The radiation appears to propagate through brick walls and metal plates without a noticeable absorption but this is not due to weak coupling with matter. Ordinary electromagnetic radiation cannot be in question. The assumptions that the radiation satisfies $E = cp$ dispersion relation and that the pulse given to the penduli is due to the absorption of energy and momentum of radiation leads to a contradiction. For a pendulum of 18.5 g, the kinetic energy of the pendulum was of the order of 10^{-4} J whereas the momentum was of the order of 10^{-3} kg m/s. If this momentum had to be imparted from the beam, its total energy should be larger than the total energy available in the discharge, 10^6 J in maximum. The conclusion made in [22] is that the radiation does not obey the dispersion relation of massless particles. On the other hand, if the net energy and momentum of the pendulum correspond to the total energy and momentum for quanta of radiation absorbed by the pendulum, the quanta must be tachyonic since one has $E = 10^{-4} J \ll pc = 3 \times 10^5$ J, which suggests that absorption is not the mechanism. Also the fact that radiation does not weaken with distance with a detectable manner suggests the same.

The force is proportional to the mass of the pendulum sphere but the interpretation as a gravitational force is excluded already because of the strength of the effect. Equivalence Principle states also that the gravitational force depends only on the gravitational mass of the particle, not its particular state. The force is also repulsive.

Consider now a TGD based explanation for the effect.

1. The radiation could correspond to a massless extremal (ME, 'topological light ray') or TGD counterpart of the longitudinal scalar waves of Tesla. The classical field involved could be either electromagnetic or Z^0 type. MEs represent classical completely collimated radiation propagating with light velocity with pulse shape being arbitrary and preserved. Tesla wave represents longitudinal pulse of electric or Z^0 electric) field propagating with light velocity. At least Z^0 type and perhaps also em MEs and scalar waves do not care about Faraday cages: the classical radiation is simply at another space-time sheet. This fits with the observation that the pulse of radiation goes through various obstacles without absorption.

2. Electromagnetic Tesla's scalar waves are favored because their emission could be interpreted as a decay of the electric field of the capacitor by the emission of scalar waves carrying away pieces of space-time containing a constant electric field with intensity equal to the local intensity of the electric field between the capacitor plates. For the scalar wave pulses the quantization of the electric flux analogous to that of magnetic flux suggests that the condition

$$eVL = eEL^2 = n \times 2\pi \quad ,$$

n integer, is satisfied ($\hbar = c = 1$), so that the length of the scalar wave pulse would be $L = \sqrt{n2\pi/eE}$. For an electric field having a magnitude of order $E \sim 10^4 \text{ kV/m}$ (a voltage of 10^4 kV over a distance of 10 cm) and for $n = 1$ the scalar wave pulse would have a length of about one micrometer.

3. What might cause the repulsive force proportional to the mass of the object? $E = pc$ relationship does not hold for the energy transfer: rather momentum is much larger than this would allow. Thus an absorption of massless quanta is certainly not in question. Rather, the relationship suggests an ordinary non-relativistic dispersion relation between kinetic energy and momentum for a massive particle. The total mass of these particles is from numbers $\Delta E = 10^{-4} \text{ J}$ and $\Delta p = 10^{-3} \text{ kgm/s}$ equals to about 50 grams. The actual mass mentioned in the example was 18.5 grams. This makes perfect sense since only order of magnitude estimate is in question.
4. Many-sheeted space-time suggests a different explanation for the effect consistent with $E = cp$ relationship. The effect would be actually a special case of anomalies which are very abundant and explained by the many-sheeted space-time concept.

i) The space-time sheet of the pulse would act as a temporary bridge between two space-time sheets, say an atomic space-time sheet of the test object and a super-conducting magnetic flux tube of the Earth's magnetic field. Some particles from the atomic space-time sheets of the test object leak along this bridge to a larger space-time sheet or vice versa. The presence of the leaking particles at the bridge would make it temporarily massive and stop the motion of ME/scalar wave pulse for a moment. Since absorption does not occur considerably this should occur only temporarily. In case of the scalar wave pulse the longitudinal electric field would define a force field and induce ionic currents of opposite sign between the space-time sheets.

ii) If the particles leak to the direction of the emitter first, as is natural since the join along boundaries bonds are first formed to this direction, then effective repulsive force results as a recoil effect by conservation of total momentum holding in many-sheeted space-time but not for single space-time sheet anymore. Recoil momentum is indeed non-vanishing since the zero point kinetic energy of particles at atomic space-time sheets is non-vanishing and is transformed to the kinetic energy of the particles at the larger space-time sheet. An order of magnitude estimate is obtained by assuming that the 'dropping' particles are electrons, and that the zero point kinetic energy is $E = \pi^2/2m_e L^2 \simeq 1 \text{ keV}$ resulting, when the size L of the atomic space-time sheet is one Angstrom. This gives for the fraction ϵ of electrons in the pendulum transferred to the beam space-time sheet the estimate $\epsilon \simeq 1.8 \times 10^{-10}$.

iii) If the probability for leakage is same for all particles independent of the material, the recoil momentum of the object resulting from the leakage of particle to another space-time sheet is proportional to the mass of the object as observed.

A possible test for this effect is following one. The object should lose some mass via the leakage, at least temporarily. The loss of mass is predicted to be small, a fraction of order 10^{-13} about the mass of the pendulum. One could also look whether the pendulum becomes charged in the process. The leakage of the super-conducting ions from the magnetic flux tubes of say Earth to the atomic space-time sheets is a fundamental mechanism of breaking of super-conductivity in TGD universe. The quantum theory of bio-systems relies on this mechanism as well as TGD based explanations for certain free energy phenomena like Brown gas [K6]). The 'miraculous' appearance of ions or atoms to system originally not containing them by supra current leakage from magnetic flux tube space-time sheets (say) is the basic testable prediction.

4.4 Does the model explain the basic observations of Tesla?

The basic vision of Tesla was that the sharp pulses involve physics not understood in the framework of Maxwell's theory. Tesla ended up with this vision on basis of certain empirical findings and it is interesting to find whether these observations could be understood in the proposed conceptual framework. In other words, could time reversal and the breaking of the second law below the p-adic time scales explain these findings.

4.4.1 Switching the current on as a time reversal for switching the current off

The basic observation of Tesla was that a sudden switching on of the current circuit produced strange phenomena. Besides sparks and light arcs strong charges were induced in the metal objects in environment. Physiological effects like electric shocks, pressure, sensations of heat, etc.. appeared. Also energy seemed to be liberated. The effects propagated through Faraday cage.

This kind of findings inspired Tesla to develop a technics to produce series of sharp pulses. In the system developed by Tesla, a magnet was repeatedly posed between the capacitor plates between which current was flowing to turn off the current for a moment. The outcome was a fast method for producing sharp current pulses. Tesla developed devices utilizing sharp pulses such as bi-filar coils and transformers, which produced much higher voltage in the secondary coil than one might have expected on basis of Maxwell's theory. The second end of the secondary coil was in freely in air and no current was observed at the end of the coil.

What was the source of these effects? The chapter "Rosetta Stone" in the book of Vassilatou [35] contains a statement which gives a hint: when the current was switched on, the current carriers behaved as if they had collided with a wall and stopped for a moment. This sounds paradoxical since it is what one might expect to happen when the current is switched off so that resistance suddenly increases. Now just the opposite happened.

A possible solution to the paradox is provided by the reversal of geometric time. If the switching on of the current is time reversal of the switching off, the initial situation could be that the system is in a state resulting after closing off of the circuit and it might contain very high charge densities. The resulting high electric fields could even induce the evaporation of the wire. This would mean that the second law of thermodynamics would enter the game and the process would not proceed in the desired manner. In fact, it is not necessary to assume even this as following argument demonstrates.

Time reversal allows to understand what happens in the case that the time reversed process proceeds.

1. When the current is switched off, charge carriers decelerate and emit their energy as positive energy photons. When the current is switched on, charges accelerate and get their energy by emitting negative energy photons. If the system starts from a situation in which charges have "collided with a wall" the amount of energy needed is especially high. This is however not necessary.
2. Condensed matter like water or biological matter are full of population inverted many-sheeted lasers. At certain resonance frequencies corresponding to the differences of the zero point kinetic energies negative energy photons induce phase transitions discharging the population inversion of the many-sheeted laser. From certain space-time sheets charged "drop" to large space-time sheets, say magnetic flux tubes. A cascade of positive energy photons is liberated and manifests itself as "free energy".
3. The metallic (for instance) objects receiving negative energy photons lose net charge to the large space-time sheets and generate a net charge of opposite sign so that a high voltage with respect to the environment is generated. This indeed was found by Tesla to occur, and the charge definitely did not originate from the circuit generating the effect. This in fact led Tesla to postulate that ether carrying the charges was emitted in the process. Process can occur in a wide region since negative energy photons of sufficiently high energy do not respect Faraday cage. The reason is that there is not system able to absorb them and thus drop to a lower energy state. The net charge is developed because the negative energy topological light rays act as "bridges" along which the charge can move between space-time sheets. Since there is an

electric field in the direction of the bridges, the charges move only in second direction fixed by the sign of the charge.

4. Switching on of the current acts as a control process which switches much larger process in environment using negative energy photons. Basically the process is due to the inherent instability of the many-sheeted space-time. What happens is analogous to a transition from a bottom of potential well in a fractal spin glass energy landscape to a bottom of a deeper potential well. The process leads to a gradual transfer of matter to larger space-time sheets and cooling. The generation of larger space-time sheets means evolution of consciousness since the p-adic prime characterizing the space-time sheets identifiable as a kind of intelligence quotient grows in the process.
5. In order to maximize the intensity of negative energy photons and get as dramatic effect as possible, the parameters characterizing the pulse series can be optimized. The basic idea is that the system is rapidly shaken. This generates accelerations of opposite sign and the system is decelerated and accelerated in a fast tempo. There is however a limitation coming from the fact that charge carriers must have enough time to return to rest. We use instinctively this trick when we try to wake up a person who has lost consciousness.

4.4.2 Do scalar wave pulses appear also outside electric circuits?

The transients at the ends of voltage pulses correspond to a constant electric field propagating as scalar wave pulses with light velocity when the inertial quantum effects caused by the coupling with matter can be neglected. TGD allows solutions of field equations describing free scalar wave pulses with longitudinal electric field. Both positive and negative energy pulses are possible. The interesting question is whether the findings of Tesla necessitate the emission of free scalar wave pulses.

1. On basis of foregoing considerations it would seem that Tesla's scalar wave pulses outside the pulsed circuits are not necessary if one wants to understand the findings of Tesla. Of course, they could be involved.
2. In the chapter "Rosetta Stone" of the book of Vassilatou [35] there is a summary of the properties of the electro-radiative event (ERE) observed by Tesla. It seems that one could understand them as effects induced by the emission of negative energy photons.

In particular, ERE leaves wires and other circuit elements in a direction orthogonal to them. This favors strongly the interpretation in terms of topological light rays identifiable as TGD counterparts of ordinary radiation. In TGD topological light rays are however carriers of light like vacuum(!) 4-currents so that they generate coherent photons and can also carry Bose-Einstein condensates of parallel photons. The filament like light emitting structures orthogonal to metal coils could thus correspond to topological light rays. If they carry negative energy they should also generate coherent photons with negative energies.

3. Scalar wave pulses should leave an open wire in a direction parallel to the wire. The open secondary coil of Tesla transformer is a good candidate in this respect. From a capacitor the pulses should leave in a direction orthogonal to the capacitor plate and might reduce the voltage of the capacitor by carrying quanta of electric flux which are very much like small capacitors themselves moving with a light velocity.

4.4.3 Why the radiation observed by Tesla was so difficult to detect using photography?

In the chapter "Rosetta Stone" of his book [35] Vassilatou tells that although the radiation emitted by the Tesla's circuits was perceived both visually and experienced as physiological effects it was very difficult to detect it instrumentally, for instance by photographing: long deposit times were required.

The explanation for this might be very simple. Body and especially retina are full of population inverted many-sheeted lasers which can amplify a weak signal of negative energy photons to a much stronger signal consisting of positive energy photons. Ordinary photographic film very probably is not able to do this.

This idea is supported also by the TGD based model for sensory receptors [K3]. In TGD Universe sensory organs are the carriers of primary qualia like color, and one can say that brain only writes the sensory music to notes. Since brain processes the sensory input in a selective manner, a back projection from brain to sensory organs making virtual sensory experiences possible must be present. Negative energy photons provide the most elegant manner to realize this mechanism since bio-matter is transparent to them unless there are many-sheeted lasers tuned to the wavelength in question.

Photo receptors indeed contain a lot of mitochondria serving as energy plants of the cell and mitochondria are known to generate visible light which is not a mere side product of metabolism [26]. This suggests that the signal consisting of negative energy photons is amplified to a positive energy visual signal in retina. This would occur during dreaming and explain rapid eye movements. The mechanism would make it possible to see using negative energy photons and even seeing even through physical objects using phase conjugated photons as the findings of Feinberg demonstrate [16]. A camera using negative energy photons is a possible technological application. The camera would make it possible to take images through walls.

4.4.4 How Tesla transformer manages to yield so high voltage amplification?

Tesla reported that his transformers have an anomalously high voltage amplification. There are two cases to be considered corresponding to pulsed ordinary and bi-filar primary coils. In both cases it might be possible to understand Tesla's findings.

1. In the case of the ordinary coil the repeated acceleration of charges induced by electric pulses generates magnetic pulses inducing in turn voltage over the secondary coil. This is what also Maxwell's theory predicts. The emission of negative energy photons inducing the increase of conductivity and an anomalous amplification of the primary current would however mean that also the voltage induced in the secondary coil is anomalously high.
2. Only the net current flowing in the pulsed bi-filar coil induces electromotive force in the secondary coil. Thus the magnetic pulses should become much sharper than in the case of the ordinary coil. Already this implies that the induced voltage along the secondary coil, being proportional to the time derivative of the magnetic flux, is very high during the short pulse. The currents induced by the electric pulse in the bi-filar coil increase also rapidly the resonance mechanism and eventually more or less compensate each other. The increase of conductivity is a further amplification mechanism possibly involved. By using a several primary bi-filar coils arranged around circle and having suitable phase lag, one could perhaps arrange a permanent anomalously large inductive effect.

4.4.5 Why no current was observed in the secondaries of Tesla transformers?

Tesla did not detect the emission of charge carriers from the open ends of the secondary coils of his transformers. What one would expect is that the voltage along the secondary generates a flow of charge carriers which are stuck to the open end and that part of them leaks out. Two factors are involved.

1. There was no current at atomic dissipative space-time sheets if the charge carriers are dropped to larger space-time sheets: perhaps at the flux tubes of the magnetic fields generated in the process or at the magnetic flux tubes of the Earth's magnetic field or its dark counterpart [M3]. An interesting possibility is that closed magnetic super conducting circuits involving primary and secondary coils are formed. The magnetic flux tubes could carry the charges also to environment and negative energy topological light rays might help to transfer the charge to the metallic objects in the environment.
2. Electric pulses corresponds to a Tesla scalar wave pulses so that the surface charges associated with the ends of the pulse correspond to vacuum charges and vacuum currents. Therefore no ordinary charge carriers were associated with them.

4.5 Super-luminal velocities, massless extremals, and quantum jumps between quantum histories

Super-luminal light velocities have been observed during the last half decade in various systems [37]. The first evidence came from the experiments of Chiao and Steinberg [36] and the experiment of Nimtz and collaborators [38]. In the latter experiment Mozart's Symphony #40 was transduced using microwaves with a super-luminal velocity equal to $4.7c$. What makes this experiment especially interesting is that it challenges the assumption about c as the maximal signal velocity and Nimtz indeed believes that signal propagation with super-luminal velocities is possible. Variants of these experiments have been later repeated using microwaves and laser light and super-luminal velocities as high as $300c$ have been observed [39]. Also evidence for two different tunnelling times [40] corresponding to the lateral displacement and angular deflection of the beam has been found.

To my opinion, these strange effects are a genuine challenge for the theories having Lorentz invariance as a basic symmetry. In TGD framework super-luminality has a surprisingly simple phenomenological description in terms of quantum jump between quantum histories concept and massless extremals (MEs) providing a 'Bohr orbit' model for the quantized gauge fields. These concepts provide also a first principle quantum description for dissipation and self-organization [I1]. MEs are in a key role in TGD based model of consciousness and living matter [M2, K3, M5]. The strange causal anomalies of neuroscience [27, 28] and the observations of Radin and Bierman [42] provide support for the notion. The model for the propagation with effective super-luminal velocity provides especially clean evidence for the importance of MEs and allows to build a more detailed view about MEs. Super-luminal effects also encourage to take seriously the exotic energy- and communication technologies suggested by TGD.

4.5.1 General model for super-luminal velocities

Consider first the general model for the super-luminal velocities in TGD framework.

Massless extremals as Bohr orbit representation of em field

In TGD framework self-organization occurs by quantum jumps between quantum histories. Quantum histories have as their geometric correlates classical space-time surfaces with topological field quanta represented by space-time sheets and carrying classical gauge field configurations providing 'Bohr orbit' type representation for quantum fields. The 'Bohr orbits' associated with photons correspond to the so called massless extremals (MEs) carrying superposition of the harmonics $f_n = n f_1$ of the fundamental frequency f_1 determined by the length L of ME ($f_1 = c/L$). The light-like vacuum current associated with ME generates coherent photons and ME also carries a Bose-Einstein condensate of collinear photons at these frequencies. Assuming that these photons are detected, a nice understanding of the relationship between descriptions based on classical fields and photons results. What is important is that both aspects are necessary for the proper understanding of the phenomena involved.

The interaction of the space-time surface representing photon beam with medium breaks it into MEs

The effect involves the interaction of the photon beam with the medium idealized as a potential barrier and by a model for the dispersion boiling down to a frequency dependent dielectric constant and magnetic permeability. This interaction involves dissipation which means in TGD framework self-organization involving a sequence of quantum jumps between quantum histories. The intuitive view is that coherence is lost so that individual components of the classical em field propagate without interfering. Geometrically this means that medium induces the decomposition of the classical em field represented by single space-time sheet X_e^4 associated with photon beam state to separate space-time sheets represented as MEs which are analogous to virtual photons. One can visualize the effect of the medium to the space-time surface representing the em field as a collision inducing the breaking of this surface into pieces represented by MEs analogous to virtual photons.

The drift of ME towards geometric past induces the increase of the effective light velocity

The classical 4-dimensional(!) field configuration associated with ME changes in each quantum jump. Depending on whether the average shift occurring in the quantum jump is forwards or backwards in time, a reduction or increase of the effective light velocity results. If MEs correspond to space-time sheets of finite geometrottemporal duration (which is not same as the duration defined by the number of quantum jumps during which ME exists), this shift of the field configuration could simply result from the drift of ME to the direction of the geometric future or past. Super-luminality would mean that the direction of the arrow of the geometric time changes locally.

The reversed time arrow means that MEs carrying negative classical energies are generated in the experiment. The negative energy MEs would drift to the direction of the geometric past and give rise to effective super-luminality whereas positive energy MEs would drift to the direction of the geometric future and induce the effective reduction of the light velocity observed in the normal situation. Only effective sub-/super-luminality is in question since light velocity is c for each ME in the sequence. In TGD inspired theory of consciousness this mechanism is fundamental for the understanding of EEG: the velocity $v \sim 10$ m/s identified usually as phase velocity of EEG waves correspond to the drift velocity of ELF MEs in TGD framework [M2].

Rather paradoxically, it is possible to have a situation in which after sufficiently many quantum jumps the classical field leaves the medium before it entered it in the space-time surface associated with the first quantum jump. Note however that for the space-time surface associated with the last quantum jump classical signal entered the medium before it left it.

Doppler shift provides a test distinguishing between genuine super-luminality and effective super-luminality and perhaps also between TGD view and standard dispersion model based on the assumption that propagation velocity in medium depends on frequency. The prediction is that c rather than $v > c$ should appear in the formula of the Doppler shift.

Interference of photon beams described in terms of MEs

The basic question is how should one describe in TGD framework the combination of beams to form single beam giving rise to interference effects? To answer this question one must keep in mind the basic philosophy: it is classical gauge fields associated with MEs which provide the fundamental description of the phenomenon and photons provide only a diagnostic tool allowing to measure the strengths of the classical fields associated with MEs.

The fusion of photon beams is the reverse of the process causing de-coherence and thus describable as a fusion of MEs to the space-time sheet X_e^4 representing the em field outside medium. Positive/negative energy ME is a geometrical analog of a virtual particle emitted by X_e^4 and travelling forwards/backwards in time to be eventually absorbed.

The fusion of photon beams is the reverse of the process causing de-coherence and thus describable as a fusion of MEs to the space-time sheet X_e^4 representing the em field outside medium. Positive/negative energy ME is a geometrical analog of a virtual particle emitted by X_e^4 and travelling forwards/backwards in time to be eventually absorbed.

Concerning the precise geometric meaning of the fusion there one can consider two options:

1. Fusion corresponds to the formation of topological sum in which case ME and X_e^4 are parallel space-time sheets having distance of order CP_2 size. The interference of the classical gauge fields is not possible in this case since they reside on different space-time sheets.
2. Fusion corresponds to the formation of join along boundaries bonds between boundaries of ME and X_e^4 . The classical fields associated with ME interfere with those associated with X_e^4 when they enter into X_e^4 . Hence this option is strongly favored.

In case 2) the resulting structure is a 4-dimensional variant of a typical string diagram with each ME representing a loop carrying photons with basic frequency and its harmonics. These loops also interact with the medium and interaction is also induced by the formation of join along boundaries bonds. In each quantum jump the positive/negative energy virtual ME shifts forwards/backwards in geometric time: this is very much like motion of MEs along the 3-dimensional boundary of X_e^4 . In normal dispersive media positive energy MEs leading to the reduction of the light velocity dominate.

This rather surreal picture suggests that virtual MEs are like living creatures creeping along the boundary of X_e^4 to the direction of past or future: this brings in mind proteins creeping in a similar

manner along microtubular surface. In fact, MEs are identified as carriers of life forms in TGD inspired theory of living systems [K3]: the reason is that they carry so called exotic p-adic Super Virasoro representations providing MEs with enormous information storage and representation capacities.

Do the photons associated with negative energy MEs have positive or negative energies?

Classical-quantum correspondence suggests strongly that the photons generated by the negative energy MEs have negative energies. It is quite possible that negative energy photons could be regarded as counterparts of negative energy on mass shell photons appearing in the Hamiltonian formalism and assigned with annihilation operators. On space-time sheets with negative time orientation they do not annihilate vacuum and generate genuine many particle states. These on mass shell states have however finite spatiotemporal extend. When the plane wave restricted to a finite space-time volume is developed into Fourier series in entire Minkowski space, the series contains also off mass shell components: this suggests an obvious connection with the virtual particle concept used in Feynman diagrammatics.

If negative energy photons are generated, the absorption of these photons on the positive energy space-time sheets could result as transitions of the excited states of atoms to ground state without photon emission and would be analogous to higher order processes induced by the exchange of negative energy virtual photons. In the similar manner emission of negative energy photons would lead from ground state to an excited state. The creation of pairs MEs with opposite time orientations, and thus also classical energies, accompanied by positive/negative energy photons provides mechanisms of amplification and population inversion. Population inversion can occur through the emission of negative energy photons whereas as amplification involves emission of positive energy photons in a state with an inverted population. Amplification/generation of population inversion presumably involves BE condensation of positive/negative energy photons on positive/negative energy MEs and a generation of positive/negative energy BE condensate.

Since the transmission time is measured by interference effects, it is basically classical field which is measured by the rate of photons it produces. More concretely and using standard terminology, the incoming photon beam is split to a part going through the optical barrier and a part which travels in the free space, and these beams are combined together in such a position that destructive or constructive interference occurs [37]. Hence the experimental arrangements used do not provide answer to the question whether negative energy photons are present or not.

Rather interestingly, the experimental arrangement yielding super-luminal velocity of $300c$ [39] is a slight modification of an arrangement yielding amplification. In a normal situation first beam generates population inversion and second beam with a precisely defined wavelength is amplified. In the super-luminal situation the wavelength of the second beam differs slightly from the value yielding amplification and only super-luminality results.

The following interpretation of the results might make sense.

1. In the situation giving rise to amplification the transitions to ground state generate photons which suffer Bose-Einstein condensation to the ME representing second beam.
2. In the super-luminal situation population reversal seems to be amplified by a mechanism generating Bose-Einstein condensate of negative energy photons emitted in the transitions from the ground state to the excited state.
3. A recoil effect, which is slightly different for the atomic transition and its reversal due to the different rest masses of the atom in the ground state and excited states, explains why the super-luminality occurs for a slightly different photon wavelength than amplification. The rest mass of the atom is given by $Mc^2 - E_i$, where E_i , $i = 1, 2$ is the binding energy of atom in ground state and excited state. A little calculation using energy and momentum conservation for the emission of positive/negative energy photon shows that the fractional difference of photon wavelengths is in a good approximation

$$\frac{\Delta\lambda}{\lambda} = -\frac{\Delta E}{E} = \frac{1}{2}\left(\frac{E}{Mc^2}\right)^2 . \tag{4.5.1}$$

If this interpretation is correct, then the only conclusion seems to be that beam amplification represents a laboratory realization of the TGD based exotic mechanism of energy production.

4.5.2 Quantitative model

In the following the hypothesis that super-luminality is associated with a tunnelling through an optical barrier [37] is criticized, a very brief summary of the basic tunnelling time models is given, and TGD based model of super-luminality based on the hypothesis that self-organization is involved.

Is super-luminality really associated with optical tunnelling?

In standard quantum mechanics the transmission of photons in the experimental situations involving super-luminality is modelled as a tunnelling through optical barrier and tunnelling time is in the role of the basic parameter. This approach is however plagued by several difficulties basically due to the highly phenomenological description of the dissipative effects.

1. Dispersive medium allows a handful of different velocities corresponding to phase -, group -, energy-, signal- and front velocities. The problem is to decide which of these velocities, if any, corresponds to the velocity of photon. In TGD framework this problem does not appear since the description relies solely on the classical fields associated with MEs.
2. The treatment of the situation as tunnelling can be questioned if self-organization is involved since tunnelling is essentially an effect associated with single solution of Schrödinger equation. In TGD approach the phenomenon is not treated as tunnelling but as self-organization phenomenon.

Depending on the identification of the velocity of photon, several theories for the tunnelling time result [41].

1. In Wigner's theory [41] group velocity is identified as the photon velocity and several experiments support the view that effective group velocity determines the transmission time [37]. What one calculates is the time for the peak of a wave packet to emerge from the exit face of the tunnel barrier relative to the time the peak of the induced wave packet arrives at the entrance face. TGD view is consistent with this identification as long as one can assume that the phenomenological description of self-organization by quantum jumps using classical field equations with complex dielectric constant is a good approximation.
2. Buttiker-Landauer time is based on semiclassical model [41]. Since the phenomenon is modelled as a tunnelling phenomenon, wave vector and velocity are purely imaginary inside the medium so that one must use absolute value. To my opinion, this feature makes this approach highly questionable although it seems obvious to me that the emergence of the imaginary time signals for the presence of two times: the geometric time and the subjectively experienced time defined by the sequence of quantum jumps in TGD.

Model for the drift of ME in time direction

Consider now a simple TGD based model for the reduction/increase of the effective light velocity and estimation of the effective light velocity.

1. In single quantum jump the average increase of psychological time defined as the center of mass temporal coordinate for the cognitive space-time sheet representing conscious observer is assumed to be given by

$$\tau = \tau_{CP_2} \simeq 10^{-39} \text{ sec} .$$

The phrase 'cognitive space-time sheet' sounds strange in present context but means only that space-time sheet has finite geometro-temporal duration. This hypothesis applies to quantum jumps of any self-organizing system in particular MEs, which are basic building blocks of living matter in TGD inspired theory of consciousness. The estimate for τ relies on dimensional analysis

and is assumed to hold true for space-time sheets which have suffered topological condensation to the interior of a larger space-time sheet by topological sum contacts. This however is not the case now since MEs suffer 3-dimensional topological condensation on the boundary of X_e^4 representing em field outside the medium (the formation of join along boundaries bonds is nothing but topological condensation for boundaries).

2. If ME is glued by join along boundaries bonds to the boundary of X_e^4 , the average increment of geometric time in quantum jump, call it τ_B , is not necessarily equal τ and one has

$$\tau_B = p\tau . \quad (4.5.2)$$

Here p represents a numerical factor depending on the properties of the cognitive space-time sheet and on the properties of the boundary of X_e^4 . Unless n is constant, cognitive space-time sheets drift along the 3-dimensional boundary of X_e^4 with different velocities. Situation can be also complicated by the fact that ME need not be all the time in the self-organizing self-state and it could be that the drifting does not occur otherwise: this obviously implies the variation of the effective values of τ_B and p .

Consider now how the reduction/increase of the effective light velocity results in this picture.

1. Suppose that the classical field configuration is shifted in time direction by average time interval

$$\Delta t = p\tau .$$

in single quantum jump. For $p > 0$ ($p < 0$) the shift is to the direction of the geometric future (past). If ME shifts as such without any change in the field configuration and is all the time in the self-organizing state, then $p = 1$ corresponds to the simplest situation in which all cognitive space-time sheets drift with the same velocity to the direction of future. During the self-organization process initiated at time t_0 and having lasted for a time $T = t - t_0$, the net temporal shift of the field configuration, is

$$\Delta T = pT = p(t - t_0) . \quad (4.5.3)$$

The resulting temporal shift of the field configuration $\Psi(x, t)$ is

$$\Psi(x, t) \rightarrow \Psi(x, t - \Delta T) = \Psi(x, t - p(t - t_0)) .$$

2. In particular, the effectively 2-dimensional field configuration

$$\Psi(x - ct)$$

associated with ME and propagating with light velocity, is replaced with the field configuration

$$\Psi(x - c(t - pT)) = \Psi(x - c(1 - p)t + pct_0) . \quad (4.5.4)$$

The effective propagation velocity is thus

$$v = c(1 - p) , \quad (4.5.5)$$

and is indeed super-luminal for $p < 0$. Also phase shift determined by the parameter pct_0 occurs.

Relationship of the effective light velocity with the parameters describing dispersive media

Experimental data as well as the fact that classical fields associated with MEs provide a basic description of the process, encourage the identification of the effective light velocity v as group velocity

$$v = c_g = \frac{d\omega}{dk} . \quad (4.5.6)$$

From the relationships

$$\omega(k) = kc_1 , \quad c_1 = Kc , \quad K = \sqrt{\frac{\epsilon_0\mu_0}{\epsilon(\omega)\mu(\omega)}} , \quad (4.5.7)$$

one has

$$\begin{aligned} v &= c_1 + \omega \frac{dc_1}{d\omega} , \\ 1 + p &= K + \omega \frac{dK}{d\omega} . \end{aligned} \quad (4.5.8)$$

Thus one can relate the parameter p to the parameters ϵ and μ characterizing the dispersive medium phenomenologically.

The fact that several super-luminal velocities are observed [37], means that the negative energy MEs generated in the experiment drift with widely different different average velocities to the geometric past. The possibility of several drift velocities could relate to the fact that the dispersion relation $\omega = kc_1(\omega)$ allows several solutions for a given wave vector. Since also sub-luminal effective transmission velocities depend on frequency, also the positive energy MEs having different lengths and therefore different fundamental frequencies drift with different average velocities to the direction of geometric future. The appearance of several super-luminal light velocities suggests that there are several simultaneous self-organization processes and that the value of p depends on the asymptotic pattern of the self-organization process.

The observation of several super-luminal velocities is consistent with the assumption that the temporal drift rate along the boundaries of X_e^4 , as opposed to the drift rate along the interior of X_e^4 , is not constant and can vary by at least two orders of magnitude. An alternative possibility is that MEs spend only part of time in quantum self-organizing 'self-state' (being thus p-adically unentangled) in which they drift. The possibility of velocities as high as $v = 300c$ [39] would mean that for lower super-luminal velocities, say $v = 1.8c$, ME drifts along boundary for less than one percent of time.

4.5.3 Possible technological implications

The significance of the super-luminal velocities is that they provide empirical support for those predictions of quantum TGD, which are in deepest conflict with the standard physics views and predict the possibility of new, rather science fictive technologies.

1. The mere assumption that space-time is many-sheeted 4-surface, implies the possibility of negative time orientations and negative energies. This suggests the possibility of generating energy from vacuum by simply generating pairs of space-time sheets with opposite energies. For instance, the generation of MEs with opposite momenta could be in a fundamental role in biology and make possible coherent motion. MEs carry also so called exotic representations of Super Virasoro algebra giving rise to exotic ultra light particles and these particles are in a key role in TGD based model of life.
2. The possibility of classical communications backwards in time are suggested strongly and would be realized by MEs with negative time orientation. Quantum communications forwards/backwards in time would correspond to the drift of positive/negative energy MEs forwards/backwards in geometric time and the explanation of super-luminality involves this assumption. These communications are nothing but conscious life moving forwards/backwards in geometric time (perhaps one could speak of life and anti-life!). the basic difference between classical and quantum

communications would be that message is replaced by a conscious messenger in quantum communications. Combination of the communications into geometric past and future would make possible apparent super-luminal communications. Incredible as it sounds, also communications with the civilizations of the geometric past and future become in principle possible.

The explanation of both the ordinary reduction of the effective propagation velocity of light and super-luminality in terms of MEs, together with the explanation of the amplification mechanism associated with the experimental arrangement used by Wang, means that these experiments provide clear empirical evidence for the generation of MEs (as well as photons) with both negative and opposite energies having finite time duration and drifting quantum jump by quantum jump into geometric future or past. These properties are indeed crucial for the prerequisites of new energy and information technologies.

Acknowledgements

I want to thank Dennis Bayne for turning my attention to the super-luminal light velocities and for generously providing material about the effect. I am also grateful for Ron Blue for sending the article of R. Y. Chiao about gravitational effects related to super-conductors. I am grateful for Tapio Tammi, Jari Aaltonen, Juha Hartikka, and Jukka Kinnunen for generously providing material relating to the free energy research and for providing the needed gentle pressure forcing to take free energy research seriously enough. In particular, the concrete results from the experimentation with bi-filar coils provided by Tapio Tammi have been of utmost importance for developing the model for the bi-filar coil from first rather unrealistic ideas to a model consistent with basic facts. Juha's experimental work with lifters and discussions with Juha have been of considerable help in developing detailed models for lifters and rotating magnetic systems.

Bibliography

Online books about TGD

- [1] M. Pitkänen (2006), *Topological Geometrostatics: Overview*.
http://tgd.wippiespace.com/public_html/tgdview/tgdview.html.
- [2] M. Pitkänen (2006), *Quantum Physics as Infinite-Dimensional Geometry*.
http://tgd.wippiespace.com/public_html/tgdgeom/tgdgeom.html.
- [3] M. Pitkänen (2006), *Physics in Many-Sheeted Space-Time*.
http://tgd.wippiespace.com/public_html/tgdclass/tgdclass.html.
- [4] M. Pitkänen (2006), *Quantum TGD*.
http://tgd.wippiespace.com/public_html/tgdquant/tgdquant.html.
- [5] M. Pitkänen (2006), *TGD as a Generalized Number Theory*.
http://tgd.wippiespace.com/public_html/tgdnumber/tgdnumber.html.
- [6] M. Pitkänen (2006), *p-Adic length Scale Hypothesis and Dark Matter Hierarchy*.
http://tgd.wippiespace.com/public_html/paddark/paddark.html.
- [7] M. Pitkänen (2006), *TGD and Fringe Physics*.
http://tgd.wippiespace.com/public_html/freenergy/freenergy.html.

Online books about TGD inspired theory of consciousness and quantum biology

- [8] M. Pitkänen (2006), *Bio-Systems as Self-Organizing Quantum Systems*.
http://tgd.wippiespace.com/public_html/bioselforg/bioselforg.html.
- [9] M. Pitkänen (2006), *Quantum Hardware of Living Matter*.
http://tgd.wippiespace.com/public_html/bioware/bioware.html.
- [10] M. Pitkänen (2006), *TGD Inspired Theory of Consciousness*.
http://tgd.wippiespace.com/public_html/tgdconsc/tgdconsc.html.
- [11] M. Pitkänen (2006), *Mathematical Aspects of Consciousness Theory*.
http://tgd.wippiespace.com/public_html/genememe/genememe.html.
- [12] M. Pitkänen (2006), *TGD and EEG*.
http://tgd.wippiespace.com/public_html/tgdeeg/tgdeeg/tgdeeg.html.
- [13] M. Pitkänen (2006), *Bio-Systems as Conscious Holograms*.
http://tgd.wippiespace.com/public_html/hologram/hologram.html.
- [14] M. Pitkänen (2006), *Magnetospheric Consciousness*.
http://tgd.wippiespace.com/public_html/magnconsc/magnconsc.html.
- [15] M. Pitkänen (2006), *Mathematical Aspects of Consciousness Theory*.
http://tgd.wippiespace.com/public_html/magnconsc/mathconsc.html.

References to the chapters of books

- [G1] The chapter *Anomalies Related to the Classical Z^0 Force and Gravitation* of [TGDfree].
http://tgd.wippiespace.com/public_html/freenergy/freenergy.html#Zanom.
- [I1] The chapter *Quantum Theory of Self-Organization* of [TGDselforg].
http://tgd.wippiespace.com/public_html/bioselforg/bioselforg.html#selforgac.
- [K1] The chapter *Time, Spacetime and Consciousness* of [TGDholo].
http://tgd.wippiespace.com/public_html/hologram/hologram.html#time.
- [K3] The chapter *General Theory of Qualia* of [TGDholo].
http://tgd.wippiespace.com/public_html/hologram/hologram.html#qualia.
- [K6] The chapter *Macroscopic Quantum Coherence and Quantum Metabolism as Different Sides of the Same Coin* of [TGDholo].
http://tgd.wippiespace.com/public_html/hologram/hologram.html#metab.
- [L4] The chapter *Pre-Biotic Evolution in Many-Sheeted Space-Time* of [TGDgame].
http://tgd.wippiespace.com/public_html/genememe/genememe.html#prebio.
- [M2] The chapter *Quantum Model for Nerve Pulse* of [TGDeeg].
http://tgd.wippiespace.com/public_html/tgdeeg/tgdeeg/tgdeeg.html#pulse.
- [M3] The chapter *Dark Matter Hierarchy and Hierarchy of EEGs* of [TGDeeg].
http://tgd.wippiespace.com/public_html/tgdeeg/tgdeeg/tgdeeg.html#eegdark.
- [M4] The chapter *Quantum Model for EEG: Part I* of [TGDeeg].
http://tgd.wippiespace.com/public_html/tgdeeg/tgdeeg/tgdeeg.html#eegI.
- [M5] The chapter *Quantum Model of EEG: Part II* of [TGDeeg].
http://tgd.wippiespace.com/public_html/tgdeeg/tgdeeg/tgdeeg.html#eegII.

Articles about TGD

- [16] The articles at my homepage at http://tgd.wippiespace.com/public_html/newarticles.html.
- [17] M. Pitkänen (2003), *Macro-temporal quantum coherence, quantum spin glass degeneracy, and number theoretic information concept* and *Bio-systems as conscious holograms*, Journal of nonlocality and remote mental interactions, issue 2.
 M. Pitkänen (2003), *Time, Space-Time, and Consciousness, Quantum Model for Sensory Receptor*, and *Quantum Model for Nerve Pulse, EEG, and ZEG*. Journal of nonlocality and remote mental interactions, issue 3.
<http://www.emergentmind.org/journal.htm>.

Physics related references

- [18] N. Tesla(1894), *Coil for Electromagnets*, US Patent No. 512,340. The patent of bifilar coil of Tesla can be found at <http://www.tfcbooks.com/patents/coil.htm>.
 A short summary of Tesla's visions can be found at <http://solair.eunet.yu/~velimir/works/teslaint.htm>.
- [19] <http://www.usc.edu/dept/ee/People/Faculty/feinberg.html>.
- [20] D. M. Pepper (1982), *Nonlinear Optical Phase Conjugation*, in *Optical Engineering*, vol. 21, no. 2, March/April.
<http://www.usc.edu/dept/ee/People/Faculty/feinberg.html>.

- [21] V. V. Shkunov and B. Ya. Zeldowich (1985), *Optical Phase Conjugation*, Scientific American, December issue.
- [22] E. Podkletnov and G. Modanese (2002), *Investigation of high voltage discharges in low pressure gases through large ceramic super-conducting electrodes*, <http://xxx.lanl.gov/abs/physics/0209051>.

Life science related references

- [23] H. Abdelmeik, S. Amara, A. M'Chirgui, M. Ben Salem, M. Sakly (2003) *Impact of evolution on the electrical properties of sciatic nerves: super-conductivity-like*. Journal of Physical & Chemical News (in press).
- [24] H. Abdelmeik, M. Pitkänen *et al* (2003), *Changes in electrical properties of frog sciatic nerves at low temperature: superconductor-like behaviour* (article is written in collaboration with Hafedh Abdelmeik and his group). http://tgd.wippiespace.com/public_html/articles/hafpaper.pdf.
- [25] P. Gariaev *et al* (2000), *The DNA-wave biocomputer*, International Journal of Computing Anticipatory Systems. Ed. Daniel Dubois, Published by CHAOS, Vol. 10, 2001.
- [26] G. Albrecht-Buehler (2000), *Reversible excitation light-induced enhancement of fluorescence of live mammalian mitochondria*. FASEB J..
See also the web article *Are mitochondria capable of generating light pulses?*, <http://www.basic.northwestern.edu/g-buehler/relief.htm>.
- [27] B. Libet, E. W. Wright Jr., B. Feinstein, and D. K. Pearl (1979), *Subjective referral of the timing for a conscious sensory experience*, Brain, 102, 193-224.
- [28] L. Deeke, B. Götzinger and H. H. Kornhuber (1976), *Voluntary finger movements in man: cerebral potentials and theory*, Biol. Cybernetics, 23, 99.

References related to anomalies

- [29] JLN Homepage (Jean Louis Naudin). <http://jnaudin.free.fr/html/lifters.htm>.
- [30] Marc Bean , *Thomas Townsend Brown*, <http://www.virtualtheater.com/ttbrown-01.html>.
- [31] Gaston Burrigde (1994), *Townsend Brown and his antigravity discs*. <http://www.spiritweb.com/Spirit/anti-gravity.html>.
- [32] Mason Rose (1952) , "The Flying Saucer". *The Application of the Biefeld-Brown Effect to the Solution of the Problems of Space Navigation*. Published in Science and Invention, August 1929. <http://www.soteria.com/brown/docs/rose.htm>.
- [33] T. B. Bahler and G. Fazi (2002) *Force on an Asymmetric Capacitor*, http://membres.lycos.fr/jlnlabs/ar1_fac/index.html .
- [34] The homepage of Juha Hartikka contains information about free energy devices and also reports about his own experiments with lifters. <http://energy.innoplaza.net>.
- [35] G. Vassilatos (1996), *Secrets of Cold War Technology: Project HAARP and Beyond*, Borderland Sciences.
- [36] A. M. Steinberg and R. Y. Chiao (1995), *Sub-femtosecond determination of transmission delay times for a dielectric mirror (photonic bandgap) as a function of angle of incidence*, quant-ph/9501013.

- [37] R. Y. Chiao (1998), *Tunnelling Times and Super-luminality: a Tutorial*. Dept. of Physics, Univ. of California, Berkeley, CA 94720-7300, U.S.A. Noverber 6.
- [38] G. Nimtz *et al* (1994), *J. Phys*, I 4, 565.
- [39] L. Wang (2000), *Nature*, July 20.
- [40] Oh. Balcou and L. Durtriaux (1997), *Phys. Rev. Lett.* 78, 851.
- [41] R. Y. Chiao and A. M. Steinberg (1997), in *Progress in Optics XXXVII*, E. Wolf, ed., (Elsevier, Amsterdam), p. 345.

Remote mental interactions, etc...

- [42] D. J. Bierman and D. I. Radin (1997), *Anomalous Anticipatory Response on Randomized Future Conditions*, *Perceptual and Motor Skills*, 84, pp. 689-690.

4.6 Figures and illustrations

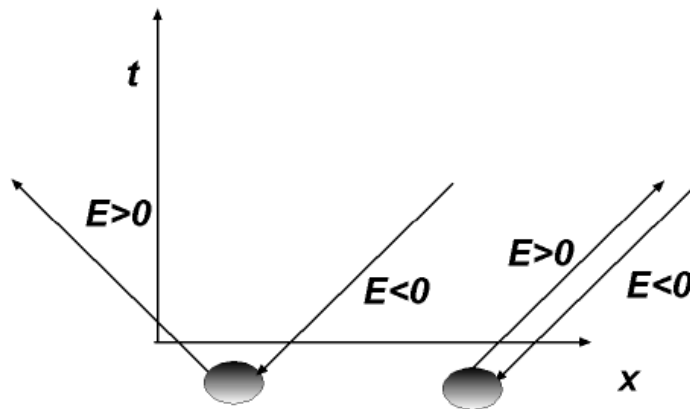

Figure 4.1: Time mirror mechanism

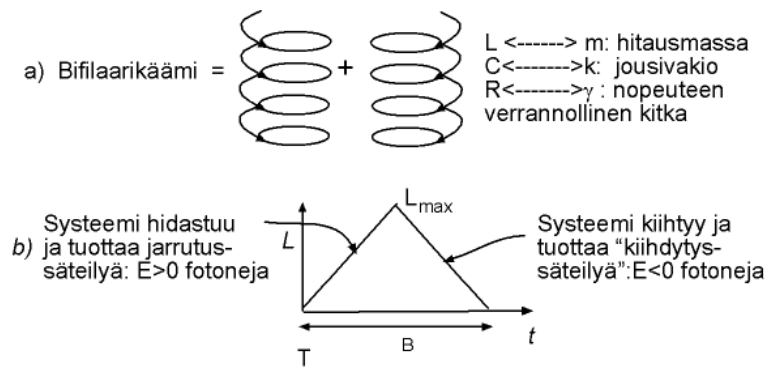

Figure 4.2: a) The structure of bi-filar coils and the mechanical analog of RCL circuit as a harmonic oscillator. b) The reduction of the mass of the harmonic oscillator at the second half of the magnetic pulse implies acceleration and generation of negative energy photons in order to get energy.

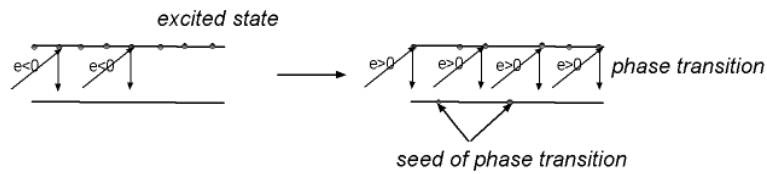

Figure 4.3: A mechanism of energy production based on negative energy topological light rays and population inversion.

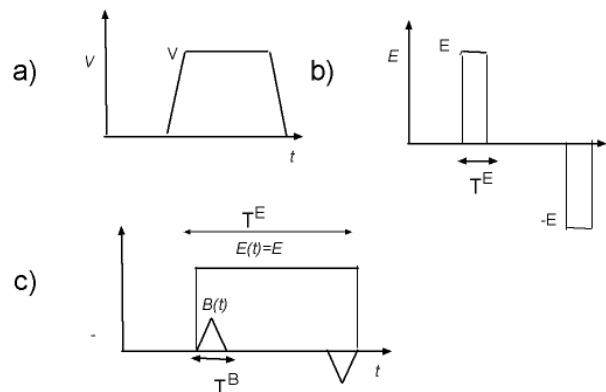

Figure 4.4: Constant voltage pulse (a) and the corresponding electric (b) and magnetic (c) pulses in the bi-filar coil.

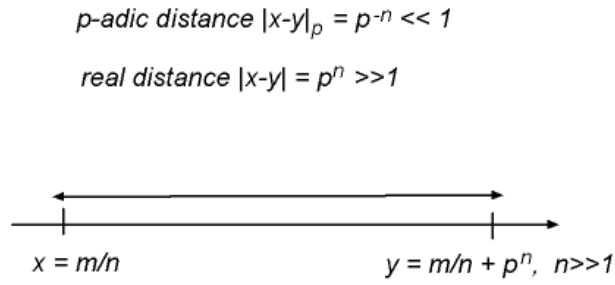

Figure 4.5: Rational valued points x and $y = x + p^n$, which are close to each other p -adically, are far from each other in real sense.

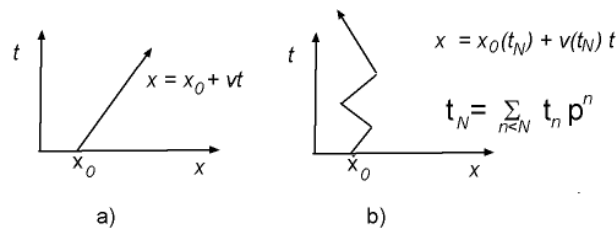

Figure 4.6: The non-determinism of p -adic differential equations in the case of a free particle. a) In real case the initial position x_0 and and velocity v determine the orbit. b) In the p -adic case x_0 and v are piecewise constant functions of time and the orbit resembles that associated with Brown motion.

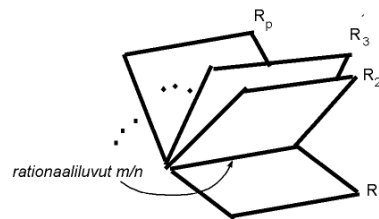

Figure 4.7: Rational numbers are common to both reals R and all p -adic number fields $R_p, p = 2, 3, \dots$. These number fields can be "glued" together along the rational numbers to form a book like structure. Rational numbers correspond to the rim of the book and different number fields to its pages.

Chapter 5

Ufos, Aliens, and the New Physics

5.1 Introduction

My personal interest in UFOs and extraterrestrials was stimulated by a TV document for almost decade ago claiming that the locations of UFO observations seem to correlate with lines of tectonic activity. Michael Persinger's work about UFO experiences was also very stimulating. The realization that crop circles are probably not hoax led to a development of rather unconventional ideas about life forms possibly responsible for the generation of crop circles.

What are UFOs? What are aliens? The attempt to answer these basic questions requires an answer to a more general question: What is life. During the last decade I have developed rather a elaborate theory of consciousness and applied it to the modelling of living matter as a macroscopic quantum system. The new view about space-time, time and consciousness allows also to develop ideas about UFOs and aliens, in particular about possible manners by which highly developed civilizations could receive information about remote parts of the Universe and to get contact with other civilizations.

In this chapter, which is actually slightly modified popular article, I try first to summarize the TGD based view about consciousness and living systems. The basic notions are many-sheeted space-time, topological quantization and magnetic body, p-adic physics as physics of intentionality and cognition, and basic ideas of TGD inspired theory of consciousness. Time mirror mechanism is a basic mechanism in TGD inspired theory of consciousness and it has also technological applications including instantaneous remote sensing of geometric past, communications with geometric past, and instantaneous remote utilization of energy, and perhaps even remote induction of simple life forms, about which simplest are perhaps plasmoids. The intelligent looking light balls reported repeatedly by UFO experiencers are indeed identifiable as plasmoids and quite recent experimental findings demonstrate that plasmoids satisfy the basic criteria justifying their identification as simple life forms.

TGD suggests also a mechanism making possible to reduce gravitational and inertial masses of space-ships so that they would behave like very light system as observations indeed suggest. Plasmoids could be living space-ships able to draw their energy from environment by the time mirror mechanism. It however seems that the highly developed civilizations would probably not see the trouble to travel to distant galaxies since it is un-necessary, and the finiteness of light velocity in any case would pose very strong limitations on what they could achieve in this manner.

Chilbolton and Crabwood crop circles can be interpreted as messages telling basic facts about the civilization responsible for their construction. Chilbolton message is constructed using the same format as Arecibo message and tells that both Earth, Mars, and Jupiter are colonized. These crop circles might be interpreted as hints about the existence of intra-terrestrial/planetary life and this inspired a model for pre-biotic evolution allowing also a model for the evolution of genetic code. The highly advanced civilization could be identified as either intelligent intra-planetary or as ourselves in the geometric future using a technology based on time mirror mechanism to construct crop circles and using less intelligent intra-terrestrial plasmoids to construct the crop circles. Sun is depicted to have a smaller size as in Arecibo message, and Crabwood message came one year and one day after the Chilbolton message: these hints allow to make estimate about the temporal distance of this civilization of the geometric future from us.

The hypothesis about hierarchy of macroscopic quantum phases characterized by arbitrarily large

values of Planck constant [J6, F9, M3] resolved the long standing problem of interpreting properly the predicted long ranged classical weak and color fields, and induced a great leap forward in the evolution of TGD based view about consciousness and life [L4]. Especially fascinating possibility is the existence of life forms consisting of what I call dark N-atoms and N-molecules surviving at the hot temperatures of planetary interiors and solar surface [N3, L4]. This progress has motivated the insertion of some comments relating to dark matter hierarchy also in this chapter.

5.2 Basic vision

The four online books about about TGD [TGDview, TGDgeom, TGDquant, TGDnumber, TGDclass, TGDpad, TGDfree] and TGD inspired theory of consciousness [TGDconsc, TGDselforg, TGDware, TGDholo, TGDgeme, TGDeeg, TGDmagn, 15] at my home page provide comprehensive (and unavoidably a little bit out of date) summary of TGD and TGD inspired theory of consciousness. The online journal JNLRMI [30, 31] contains several articles about TGD inspired theory of consciousness and quantum biology and its applications to remote mental interactions. Here a brief summary of what might be called basic principles is given.

5.2.1 Quantum-classical correspondence

The fundamental meta-level guiding principle is quantum-classical correspondence (classical physics is an exact part of quantum TGD). The principle states that all quantum aspects of the theory, which means also various aspects of consciousness such as volition, cognition, and intentionality, should have space-time correlates. Real space-time sheets provide kind of symbolic representations whereas p-adic space-time sheets provide correlates for cognition and intentions. All that we can symbolically communicate about conscious experience relies on quantal space-time engineering to build these representations. What makes possible to have even space-time correlates of quantum jumps and quantum jump sequences classical non-determinism of the basic variational principle determining the dynamics of space-time sheets and inherent determinism of p-adic variants of field equations.

5.2.2 Classical physics as exact part of quantum theory

In TGD Universe space-times are 4-surfaces in the 8-dimensional space $H = M_+^4 \times CP_2$ obtained by replacing the points of Minkowski space future light cone with 4-dimensional compact space CP_2 having extremely small size of order 10^{-30} meters (see Fig. 5.6). Classical physics corresponds to the dynamics of space-time surfaces determined by the absolute minimization of so called Kähler action. This dynamics have several unconventional features basically due to the possibility to interpret the Kähler action as a Maxwell action expressible in terms of the induced metric defining classical gravitational field and induced Kähler form defining a non-linear Maxwell field not as such identifiable as electromagnetic field however.

Topological field quantization and the notion of many-sheeted space-time

Quantum classical correspondence is very powerful principle. For instance, absolute minimization of Kähler action serving as the basic variational principle can be interpreted as a space-time representation for the second law of thermodynamics. Hence the solutions of field equations correspond asymptotically to self-organization patterns for which dissipation represented by Lorentz 4-force vanishes. This provides the physical intuition which has led to a discovery of extremely general solution families of field equations. It might even be that the classical field equations determining space-time surfaces are exactly solvable. The study of field equations leads to general classification of the phases of matter and simple topological criterion differentiates between living and "dead" matter [D1, I5].

1. Topological field quantization

The compactness of CP_2 implies the notions of many-sheeted space-time and field quantization. Topological field quantization means that various classical field configurations decompose into topological field quanta. Space-time becomes many-sheeted (see Fig. 5.6). One can see space-time as a gigantic Feynman diagram with lines thickened to 4-surfaces. Absolute minimization of Kähler action implies that only selected field configurations analogous to Bohr's orbits are realized physically so

that quantum-classical correspondence becomes very predictive. An interpretation as a 4-D quantum hologram is a further very useful picture [K2] but will not be discussed in this chapter in any detail. One implication of many-sheetedness is the possibility of macroscopic quantum coherence.

Topological field quantization implies that the field patterns associated with material objects form extremely complex topological structures which can be said to belong to the material objects. The notion of field body, in particular magnetic body, typically much larger than the material system, differentiates between TGD and Maxwell's electrodynamics, and has turned out to be of fundamental importance in the TGD inspired theory of consciousness. One can say that field body provides an abstract representation of the material body.

Space-time sheets topologically condense to larger space-time sheets by wormhole contacts which have Euclidian signature of metric. This implies causal horizon at which the signature of the induced metric changes from Minkowskian to Euclidian. This forces to modify the notion of sub-system. What is new is that two systems represented by space-time sheets can be unentangled although their subsystems bound state entangle with the mediation of the join along boundaries bonds connecting the boundaries of sub-system space-time sheets (see Fig. 5.6). This is not allowed by the notion of subsystem in ordinary quantum mechanics. This notion in turn implies the central concept of fusion and sharing of mental images by entanglement making possible telepathic communications of mental images over arbitrarily long distances.

The possibility of negative energies

A further prediction derives from the fact that space-time is 4-surface rather than an abstract manifold. Energy momentum tensor of general relativity is replaced by a collection of conserved energy and momentum currents, which are 4-vector fields. This makes the notions of energy and momentum precisely defined but also implies that the sign of energy and momentum depend on the time-orientation of the space-time sheet. Negative energies become therefore possible somewhat like in the lines of a Feynman diagram. Negative energy topological light rays have phase conjugate laser waves [16, 17] as the most plausible standard physics counterparts, and play a fundamental role in quantum metabolism as a kind of quantum credit card [K6]. They generate also time like entanglement which corresponds to a formation of new kind of bound states.

Negative energies might be possible even for ordinary particles and could mean dramatic deviation from the standard quantum theory. The roles of annihilation and creation operators have changed for negative energy space-time sheets. This would mean that operator combinations involving both annihilation and creation operators would generate states involving positive and negative energy space-time sheets. One can even imagine that an intentional action could create states with vanishing net quantum numbers and that positive and negative energy particles could be separated from each other.

Phase conjugate waves [16, 17] discovered by Zeldovich and his colleagues at seventies in Russia are counter parts of negative energy photons. They represent signals propagating to the geometric past and it is possible to understand their strange properties if one assumes that they have negative energies. Kozyrev was probably the first one to observe phase conjugate waves from distance astrophysical and propagating towards geometric past [42]. Sadly, standard physicists are not yet mature to realize how far reaching this discovery is or not to even take it seriously.

TGD Universe is quantum spin glass

Since Kähler action is Maxwell action with Maxwell field and induced metric expressed in terms of $M_+^4 \times CP_2$ coordinates, the gauge invariance of Maxwell action as a symmetry of the vacuum extremals (this implies is a gigantic vacuum degeneracy) but not of non-vacuum extremals. Gauge symmetry related space-time surfaces are not physically equivalent and gauge degeneracy transforms to a huge spin glass degeneracy. Spin glass degeneracy provides a universal mechanism of macro-temporal quantum coherence and predicts degrees of freedom called zero modes not possible in quantum field theories describing particles as point-like objects. Zero modes are identifiable as effectively classical variables characterizing the size and shape of the 3-surface as well as the induced Kähler field.

Long range classical weak and color fields

Geometrization of classical fields means that various classical fields are expressible in terms of imbedding space-coordinates and are thus not primary dynamical variables. This predicts the presence of

long ranged weak and color (gluon) fields not possible in standard physics context.

The proper interpretation of these fields has been the most difficult challenge that I have encountered during the development of TGD. So difficult that it took not less than 24 years before I was mature to realize that these fields can be assigned to a fractal hierarchy of copies of standard model physics, in particular the physics based on different value of Planck constant and having interpretation in terms of dark matter hierarchy. A good metaphor for the TGD universe is as an inverted Mandelbrot fractal so that the increase (rather than decrease) of the resolution scale reveals endlessly new and larger structures due to the scaled up variants of standard physics not possible to see in shorter length scales.

The exotic weak and color forces appear already in atomic length scales and force to modify the view about nuclear physics and condensed matter physics [F8, F9]. The charge entanglement induced by W MEs defines the most promising candidate for the general mechanism for how magnetic bodies perform quantum control of biological bodies: for instance, the model of nerve pulse generation represents an application of this mechanism [M2]. Chiral selection in living matter can be seen as a direct evidence for the exotic weak forces operating at the level of dark matter [L4]. Classical color force in turn is the backbone in the model of color vision [K3]: colors correspond to increments of color quantum numbers in this model.

5.2.3 p-Adic physics as physics of cognition and intentionality

p-Adic number fields R_p , one for each prime p , and real numbers R are completions of rational numbers. p-Adic numbers differ from real numbers in that notions of distance, nearness, and continuity are completely different. p-Adic field equations are also inherently non-deterministic. For these reasons p-Adic numbers are excellent candidates for modelling of space-time correlates of cognition and intention.

p-Adic numbers

Like real numbers, p-adic numbers can be regarded as completions of the rational numbers $q = r/s$ (r and s integers) to a larger number field allowing the generalization of differential calculus. Each prime p defines a p-adic number field allowing the counterparts of the usual arithmetic operations. A basic difference between real and p-adic numbers is that the notions of distance are quite different. Any rational can be written as $q = p^k \times r/s$ where r and s are not divisible by p . The p-adic norm in R_p (analogous to absolute value in real context) is $|q|_p = p^{-k}$. In particular for $q = p^k$ the norm is p^{-k} and approaches zero when k becomes infinite. Real norm would become infinite at this limit. Therefore p-adically infinitesimal corresponds to infinite in the real sense.

p-Adic numbers allow the generalization of the differential calculus. The basic rules of the p-adic differential calculus are the same as those of the ordinary differential calculus. There is however one important new element: the set of the functions having vanishing p-adic derivative consists of so called pseudo constants which are piecewise constant function. In the real case only constant functions have vanishing derivative. This implies that p-adic differential equations are non-deterministic. This non-determinism is identified as a counterpart of the non-determinism of cognition, imagination, and intentionality.

p-Adic length scales and p-adic cognitive codes

Parallel space-time sheets with distance about 10^4 Planck lengths form a hierarchy. Each material object (...atom, molecule, ..., cell,...) corresponds to this kind of space-time sheet. The p-adic primes $p \simeq 2^k$, k prime or power of prime, characterize the size scales of the space-time sheets in the hierarchy. The p-adic length scale $L(k)$ can be expressed in terms of cell membrane thickness as

$$L(k) = 2^{(k-151)/2} \times L(151) \quad , \quad (5.2.1)$$

$L(151) \simeq 10$ nm. These are so called primary p-adic length scales but there are also n-ary p-adic length scales related by a scaling of power of \sqrt{p} to the primary p-adic length scale. Quite recent model for photosynthesis [K6] gives additional support for the importance of also n-ary p-adic length scales $L(n, k) = 2^{(n-1)k/2} L(k)$ so that the relevant p-adic length scales would come as half-octaves in a good approximation but prime and power of prime values of k would be especially important.

p-Adic length scale hypothesis allows to quantify the notion of many-sheeted space-time and make rich spectrum of predictions such as p-adic frequencies $f(k) = c/L(k)$ and corresponding energies.

p-Adic cognitive are realized as bit sequences defined by field patterns such that duration of codeword is $T(n, k) = L(n, k)/c$ and the number k_1 of bits is a factor of k . For prime values of k the number of bits is maximal, which is one reason for why they are in special position. Genetic code correspond to $k_1 = 6$ and memetic code to $k_1 = 126$ [L1]. These cognitive codes would be universal and especially interesting concerning communications with extraterrestrial civilizations since they correspond to precisely defined frequencies.

Generalization of number concept

The basic ingredient is the new view about numbers: real and p-adic number fields are glued together like pages of a book along common rationals representing the rim of the book (see Fig. 5.6). This generalizes to the extensions of p-adic number fields and the outcome is a complex fractal book like structure containing books within books. This holds true also for manifolds and one ends up to the view about many-sheeted space-time realized as 4-surface in 8-D generalized imbedding space and containing both real and p-adic space-time sheets. The latter are interpreted as correlates for thoughts and intentions. The transformation of intention to action corresponds to a quantum jump in which p-adic space-time sheet is replaced with a real one (see Fig. 5.6).

p-Adically infinitesimal is infinite in real sense

One implication is that the rationals having short distance p-adically are very far away in real sense. This implies that p-adically short temporal and spatial distances correspond to long real distances and that the evolution of cognition proceeds from long to short temporal and spatial scales whereas material evolution proceeds from short to long scales. First a rough sketch is generated and then smaller and smaller details are added gradually. Together with the non-determinism of p-adic field equations this explains the long range temporal correlations (ability to realize rough plans) and apparent local randomness of intentional behavior.

The fact that p-adically infinitesimal distances correspond to infinite distances in real sense means that continuous p-adic spacetime sheets have a literally infinite size. Thus cognitive body is of infinite size and our thoughts have infinite size in real sense. This turns upside down the usual view about brain as seat of thoughts and forces a new view about conscious existence. Particular biological life cycle is like turning attention to a particular biological body serving as motor instrument and sensory receptor. After biological death the attention turns to some other biological body perhaps in some other galaxy. This allows also a fresh look to what one means by extraterrestrial and aliens.

p-Adic fractal statistics as a signature of intentionality

The failure of the real statistics and its replacement by p-adic fractal statistics for time series defined by varying number N of measurements performed during a fixed time interval T allows very general tests for whether the system is intentional and what is the p-adic prime p characterizing the "intelligence quotient" of the system. The replacement of $\log(p_n)$ in the formula $S = -\sum_n p_n \log(p_n)$ of Shannon entropy with the logarithm of the p-adic norm $|p_n|_p$ of the rational valued probability allows to define a hierarchy of number theoretic information measures which can have both negative and positive values and one can assign to rational valued probabilities a unique p-adic entropy S_p as maximally negative entropy and identify it as information associated with the entanglement. This kind of entanglement is naturally interpreted as bound state entanglement.

5.2.4 The core ideas of TGD inspired theory of consciousness and quantum biology

The following ideas of TGD inspired theory of consciousness and of quantum biology are the most relevant ones for what will follow.

Quantum jump as moment of consciousness and the notion of self

”Everything is conscious and consciousness can be only lost” is the briefest manner to summarize TGD inspired theory of consciousness. Quantum jump as a moment of consciousness and the notion of self are key concepts of the theory besides quantum mechanical concepts like entanglement (see Fig. 5.6) and bound state (electron and proton in hydrogen atom provide the basic example of bound state. Generation of bound state quantum entanglement with environment means that the system loses its consciousness.

Moment of consciousness corresponds to single quantum jump, which has a complex anatomy not discussed here. Self is a system able to avoid bound state entanglement with environment and can be formally seen as an ensemble of quantum jumps. The contents of consciousness of self are defined by the averaged increments of quantum numbers and zero modes (sensory and geometric qualia). Moments of consciousness can be said to be the counterparts of elementary particles and selves the counterparts of many-particle states, both bound and free.

The selves formed by macro-temporal quantum coherence are in turn the counterparts of atoms, molecules and larger structures. Macro-temporal quantum coherence effectively binds a sequence of quantum jumps to a single quantum jump as far as conscious experience is considered. The idea that conscious experience is about changes amplified to macroscopic quantum phase transitions, is the key philosophical guideline in the construction of various models, such as the model of qualia, the capacitor model of sensory receptor, the model of cognitive representations, and declarative memories.

Selves can have sub-selves and self experiences them as mental images. The TGD based notion of sub-system allows sub-selves to entangle and this corresponds to the fusion of mental images: this occurs for instance in stereovision. In the case that the systems in question represents a mental image, entanglement means fusion and sharing of mental images. The implication is that the contents of our consciousness is not so private than we have accustomed to think. For instance, shared mental images could be behind the development of moral rules and be crucial for the existence of society.

Macro-temporal quantum coherence

Macro-temporal quantum coherence is second consequence of the spin glass degeneracy [K2]. It is essentially due to the formation of bound states and has as a topological correlate the formation of join along boundaries bonds connecting the boundaries of the component systems. During macro-temporal coherence quantum jumps integrate effectively to single long-lasting quantum jump and one can say that system is in a state of oneness, eternal now, outside time. Macro-temporal quantum coherence makes possible stable non-entropic mental images. Negative energy topological light rays (MEs) are one particular mechanism making possible macro-temporal quantum coherence via the formation of bound states, and remote metabolism and sharing of mental images are other facets of this mechanism.

Space-time as a 4-dimensional living organism

p-Adic physics as physics of intentionality and cognition is a further key idea of TGD inspired theory of consciousness. p-Adic space-time sheets as correlates for intentions and p-adic-to-real transformations of them as correlates for the transformation of intentions to actions allow deeper understanding of also psychological time as a front of p-adic-to-real transition propagating to the direction of the geometric future. Negative energy MEs are absolutely essential for the understanding of how precisely targeted intentionality is realized.

Entire 4-dimensional space-time can be said to be living and self-organizing structure which changes in each quantum jump. This means that our geometric future and past contain civilizations and in principle we could communicate with ourselves of geometric future. Even our own biological bodies can be lived through many times although one must assume that there is a kind of ”dead time” during which large changes in the immediate geometric past are not possible: for instance, a different decision in the geometric youth could suddenly and profoundly change our life in geometric now.

Dark matter hierarchy, sensory representations, motor action, and metabolism

Dark matter hierarchy forces a profound reconsideration of brain metabolism and allows to develop a detailed model for how magnetic bodies use biological bodies as sensory receptors and motor instru-

ments [M3] leading among other things to a generalization of the notion of genome.

For ordinary quantum mechanics photons at EEG frequencies correspond to ridiculously small energies. Dark matter hierarchy is accompanied by a hierarchy of EEGs and its generalizations with the scalings of frequencies predicted to come in powers of $\lambda \simeq 2^{11}$ [M3]. For $k_{em} = 4$ the energies of EEG photons are above thermal threshold at room temperature for $f \geq 1$ Hz, and 5 Hz frequency corresponds to 86 meV energy.

The fact that arbitrarily small frequencies can correspond to energies above thermal threshold at higher levels of dark matter hierarchy implies that photons with arbitrarily low frequencies can have sizable physical effects on matter. This conforms with the findings about the effects of ELF em fields on living matter [M3], and these effects allow to develop a rather detailed model for EEG and identify the parts of EEG correlating with communications of sensory data to the magnetic body and with quantum control performed by the magnetic body [M3].

The implication is that the transfer of energy between magnetic bodies and biological body could be major factor in metabolism. The question is whether the magnetic bodies provide metabolic energy for brain or utilize the metabolic energy provided by brain or both. Time mirror mechanism as a mechanism of intentional action would predict that magnetic body uses the metabolic resources of brain during intentional action. Together with the strange findings about ionic currents through cell membrane suggesting that ionic channels and pumps are actually ionic receptors and the ionic currents through them are only small samples about the net currents, this vision leads to a profoundly new view about brain metabolism.

5.3 TGD based view about life

The notions of many-sheeted space-time, magnetic body, p-adic physics as physics of intention and cognition, time mirror mechanism as a tool to realized intentional action, and classical Z^0 force, are the basic elements of TGD inspired view about life.

5.3.1 The notion of magnetic body

The magnetic field associated with any material system is topologically quantized, and one can speak about magnetic body since one can assign given magnetic flux tube to a definite material system.

Magnetic body as an intentional agent

An attractive idea is that the relationship of the magnetic body to the material system is to some degree that of the manual to an electronic instrument. Magnetic body would thus allow to realize both sensory and abstract symbolic representations about the material body. Magnetic body would in this case serve as a kind of computer screen at which the data items processes in say brain are communicated either classically (positive energy MEs) or by sharing of mental images (negative energy MEs).

Magnetic body is also an active intentional agent: motor actions are controlled from magnetic body and proceed as cascade like processes from long to short length and time scales as quantum communications of desires at various levels of hierarchy of magnetic bodies. Communication occurs backwards in geometric time by negative energy MEs. Motor action as a response to these desires occurs by classical communications by positive energy MEs and as neural activities. This explains the coherence and synchrony of motor actions difficult to understand in neuroscience framework. The sizes of flux tubes are astrophysical: for instance, EEG frequency of 7.8 Hz corresponds to a wave length defined by Earth's circumference. The non-locality in the length scale of magnetosphere, and even in length scales up to light life, is forced by Uncertainty Principle alone, if taken seriously in macroscopic length scales.

Universal metabolic currencies

The leakage of supra currents of ions and their Cooper pairs from magnetic flux tubes of the Earth's magnetic field to smaller space-time sheets and their dropping back involving liberation of the zero point kinetic energy defines one particular metabolic "Karma's cycle". The dropping of protons from $k = 137$ atomic space-time sheet involved with the utilization of ATP molecules is only a special

instance of the general mechanism involving an entire hierarchy of zero point kinetic energies defining universal metabolic currencies. This leads to the idea that the topologically quantized magnetic field of Earth defines the analog of central nervous system and blood circulation present already during the pre-biotic evolution and making possible primitive metabolism. This has far reaching implications for the understanding of how pre-biotic evolution led to living matter as we understand it [L4].

Dark matter hierarchy and motor control

The following general overview about quantum communication and control emerges from the model for EEG hierarchy as correlate for dark matter hierarchy discussed in detail in [M3].

1. Cyclotron frequencies relate to the control of the biological body by the magnetic body and could be assigned with the magnetic flux sheets going through DNA since it is genome where protein synthesis is initiated and is thus the optimal intermediate step in the cellular control.
2. One of the basic functions of cell membranes is to perceive the chemical environment using various kinds of receptors as sensors. Neurons have specialized to receive symbolic representations of the sensory data of primary sensory organs about the situation in the external world. A good guess is that in this case magnetic flux quanta are hollow cylindrical structures parallel to the cell membrane associated proteins serving as Josephson junctions. Also magnetic flux tubes parallel to axon serving as templates for axons could define communication lines connecting cell membranes to the cellular magnetic body ($k_{em} = 2$ perhaps) Also synaptic contacts should involve similar magnetic flux quanta connecting them to neuronal magnetic body ($k_{em} = 3$ perhaps).
3. This picture would explain why the temperature of brain must be in the narrow range 36-37 K to guarantee optimal functionality of the organism. If interior superconductivity is lost, magnetic body receives sensory data but is paralyzed since its desires cannot be realized. If boundary superconductivity is lost, magnetic body can move but is blind.
4. In the length scales below the weak length scale L_w also charged weak bosons behave as massless particles and the exchange of virtual W bosons makes possible a nonlocal charge transfer. Dark quark-antiquark pairs associated with the color bonds of the atomic nuclei can become charged via the emission of dark W boson and thus produce an exotic ion. The same can happen at the higher levels of dark matter hierarchy.
5. Massless extremals (MEs, topological light rays) serve as correlates for coherent states and Bose-Einstein condensates of dark bosons. Besides neutral massless extremals (MEs) TGD predicts also charged massless extremals obtained from their neutral counterparts by a mere color rotation (color and weak quantum numbers are not totally independent in TGD framework). The second nonlocal quantum control mechanism is based on em charge entanglement involving a superposition of ordinary ions/atoms and exotic ions connected by a W massless extremal joining magnetic body and biological body. In quantum jump this state would be reduced to exotic charge state with some probability increasing with the strength of the classical W field. Charged massless extremals could be seen as correlates for nonlocal quantum control by affecting charge equilibria whereas neutral MEs would serve as correlates for coordination and communication. Color charged MEs could also induce color charge polarization and flows of color charges and thus generate visual color qualia by the capacitor mechanism discussed in [K3].
6. These nonlocal quantal mechanisms can induce or change electromagnetic polarization in turn inducing ordinary charge flows and thus making possible quantum control of nervous system by magnetic body. The generation of nerve pulse could rely on the spontaneous state function reduction occurring for charge entangled state reducing the resting potential below the critical value by this kind of mechanism inducing charge transfer between cell interior and exterior. Also remote mental interactions, in particular telekinesis, might rely on this mechanism.

Emergence of symbols at molecular level and new view about hydrogen bond, water, and bio-catalysts

The first questions one can ask about dark matter is "What dark atoms could be?". This question is discussed in [J6] and more thoroughly and relating it to the general model about living matter in [L2, N2, L4].

One can imagine two notions of dark atom. The first one is based on λ^{2k} -fold radial scaling of ordinary atom and predicts that energies are scaled down like $1/\lambda^{2k}$. Second is based on λ^k -fold radial folding of the ordinary atom without changing its size. Both of these notions seem to make sense.

The radially folded atoms seems to be especially interesting biologically. The nucleus of this dark atom is ordinary whereas electrons are dark. The space-time sheet associated with a dark atom at k^{th} level of dark matter hierarchy is locally λ^k -fold covering of M^4 , $\lambda \simeq 2^{11}$. The sheets however integrate to a single sheet globally.

Single electron states have very nearly the same energy as in the case of ordinary atoms since principal quantum number n is fractionized to n/λ^k . Fermi statistics allows also $N \leq \lambda^k$ -electron states: this is essentially due to the degeneracy caused by the λ^k -fold local stack structure of space-time sheets.

From the point of exterior world these atoms have an effective fractional charge $1 - N/\lambda^k$ since fine structure constant associated with the interaction of dark electron with external world is scaled down by a factor $1/\lambda^k$. $N = \lambda^k$ corresponds to full electron shell and represents especially stable state analogous to noble gas atom or magic nucleus.

Dark N-hydrogen atoms, briefly H_N -atoms for $k = 1$ and $\lambda \simeq 2^{11}$, are of especial interest from the point of view of biology. One ends up with the hypothesis that H_λ -atom corresponds to hydrogen atom appearing in hydrogen bond. Furthermore, H_N -atoms could define λ -fold alphabet and their attachment to various bio-molecules could define letters for the names of bio-molecules.

The molecules labelled by name and conjugate name would have enhanced probability to fuse along the letters and conjugate letters ($N_c = \lambda - N$): in this process one proton would be liberated and could drop to a larger space-time sheet liberating metabolic energy quantum. This process would define simultaneously the basic mechanisms of catalytic action and generation of metabolic energy quantum. H_N atoms would bring in symbolic representations and what might be called molecular sex.

The assumption that that at least part of water molecules of water in living systems could be of form $H_N - O - H$ and $H_{N_1} - O - H_{N_2}$ leads to a model for ordered water as water in which only H_λ -atoms are bound to oxygen and to answer basic questions concerning the role of water in bio-chemistry. For instance, the question why hydration induces de-polymerization unless the water is in ordered phase can be answered. The prediction is that $H_N - O - H$ water acts as a catalytic poison by attaching to the letters of the names of molecules and thus spoiling catalytic specificity. The identification of ordered water as the predecessor of gel-phase emerges naturally.

In this framework it is even possible to say something non-trivial about how first replicators have emerged. The new view about hydrogen bond poses very strong constraints on allowed bio-monomers. Monomers forming negatively charged polymers at the verge of stability are ideal since they define optimal targets for catalytic action.

Magnetic Mother Gaia as conscious entity

Magnetic Mother Gaia could also form sensory and other representations receiving input from several brains via negative energy EEG MEs entangling magnetosphere with brains. The multi-brained magnetospheric selves could be responsible for the third person aspect of consciousness and for the evolution of social structures. Some aspects of remote viewing very difficult to understand if remote viewing involves only the target and viewer [32], the successful healing by prayer and meditation groups [33], and the experiments of Mark Germaine [34] support the view that multi-brained possibly magnetospheric selves are involved. Magnetic flux tubes could function as wave guides for MEs and this aspect is crucial in the model of long term memory.

5.3.2 Time mirror mechanism as a fundamental mechanism transforming intentions to actions

Time mirror mechanism is based on the generalization of what happens in the reflection of light. Instead of reflecting in spatial direction, light propagating in the direction of past is reflected in time direction (see Fig. ??). Phase conjugate light waves can be identified as light propagating in the direction of geometric past and with its photons having negative energies. Reflected light consists in turn of ordinary positive energy photons.

Materialization of intentions

Long ranged electro-weak fields, in particular ELF em fields, are crucial for the TGD inspired model of brain and a natural assumption is that p-adic-real phase transitions occur also for "topological light rays" (massless extremals (MEs)).

A concrete picture about the materialization of intentions emerges, when one asks how a precisely targeted intention could be realized at the atomic or molecular level. The basic point is that molecules can only intend to make simple quantum transitions.

1. If the transition occurs to a lower energy state it can occur spontaneously whereas the transitions to a higher energy states cannot. Spontaneous transitions mask the possibly occurring intended transitions so that only the transitions which cannot occur spontaneously allow precisely targeted intention.
2. What would happen is that first a p-adic ME representing the intention to perform the transition is generated. Then p-adic ME is transformed to a real ME in quantum jump. Quite generally, it seems that intention can be realized in a precisely targeted manner only for the transitions, which cannot occur spontaneously, and thus involve the emission of negative energy MEs.
3. The generation of negative energy MEs utilizes the buy now-let others pay mechanism of metabolism, which implies extreme flexibility since system gets energy instantaneously. Of course, there must exist an unselfish self, which is able to pay and this puts severe constraints on the mechanism.
4. *W* MEs inducing charge entanglement involving exotic nuclear ionizations of opposite sign in entangled systems is especially attractive candidate for inducing generalized motor actions. The mechanism relies on the generation of classical electric fields at dark space-time sheets in turn inducing via Faraday law electric fields at space-time sheets containing the ordinary matter: this leads to generation of ordinary ohmic currents. The generation of nerve pulse could represent one example of a generalized motor action realized in this manner by magnetic body [M2].

Time mirror mechanism, scalar wave pulses, and wormhole magnetic fields

Many-sheeted space-time makes possible many-sheeted lasers since cold space-time sheets can contain Bose-Einstein condensates of ions and their Cooper pairs. If the system contains population inverted many-sheeted laser for which the increment of zero point kinetic energy corresponds to the energy of photons associated with negative energy MEs, the absorption of negative energy photons gives rise to a phase transition like dropping of particles to larger space-time sheet by the induced emission mechanism, and the control signal represented by negative energy MEs can be amplified if a critical number of particles drops to the larger space-time sheet. This control mechanism allows an instantaneous motor control in which intention is transformed to desired represented by negative energy MEs and generates in geometric past a reaction representing the desired response, say neuronal activity giving rise to a motor action. This process probably involves entire hierarchy of magnetic selves realizing their intentions as desires communicated to lower level magnetic selves and the lowest level corresponds to the regions of brain responsible for liberating metabolic energy.

The simplest possibility is that the transformation of the intention to action corresponds to p-adic-to-real phase transition for negative energy topological light ray. It however seems that generation of p-adic scalar wave pulse transformed to real one is more promising mechanism. When scalar wave pulse moves in matter, charges end up to the space-time sheet of the scalar wave pulse and accelerate without dissipation. Instead of brehmstrahlung the accelerated charges emit negative energy "acceleration

radiation” having negative energy MEs as space-time correlates. Since dissipation is negligible this leads to a generation of a strong negative energy signal. The resulting negative energy photons in turn induce the phase-transition like dropping of particles of population inverted many-sheeted laser to larger space-time sheets liberating a beam of positive energy photons which is much more intense than the control signal consisting of negative energy photons. A good guess is that scalar wave pulses provide a fundamental control mechanism in living matter, and that nerve pulse represents only a special case of this control mechanism.

Intentions could be transformed also to actions by generation of magnetic flux tubes: so called wormhole magnetic fields [J5] correspond to pairs of magnetic flux tubes having opposite time orientations and therefore also opposite energies. Wormhole magnetic fields could be created by first generating their p-adic counterparts, and then transforming them to their real counterparts in quantum jump. The phase transition like changes of EEG spectrum involving emergence or disappearance of EEG band might be due to the generation of wormhole magnetic fields giving rise to EEG resonance frequencies via cyclotron transitions and thus represent motor actions of magnetic body [M3].

5.3.3 Applications of time mirror mechanism

Time mirror mechanism has become a corner stone of TGD inspired theory of consciousness and biological applications translate easily to technological applications, which provide a fresh new about how advanced civilizations might study the surrounding cosmos.

Biological applications

Long term memory, sensory perception, and realization of intentions as action, in particular motor actions rely on time mirror mechanism mechanism. The idea is simple. To remember is to ”see” the brain of the past. Ordinary seeing is based on reflection of light on an object. Seeing the brain of past is based on reflection of light in time direction by mirror mechanism. The same mechanism explains remote mental interactions. Now reflection occurs some other brain or some other system containing population inverted lasers.

The strange time delays associated with active and passive aspects of consciousness discovered by Libet [18] can be interpreted as due to the finiteness of light velocity and astrophysical size of the magnetic body, and thus lend support for the notions of magnetic body and time mirror mechanism.

Time mirror mechanism allows also instantaneous remote metabolism: system gets positive energy by sending negative energy topological light rays/photons to some system able to receive them. If the receiving system is population inverted laser, a cascade like process generating positive energy photons propagating to the future and to the system which sent the negative energy photons. The cascade results because the probability of bosons to drop in ground state is proportional to the number of bosons already in ground state. This mechanism makes biological system extremely flexible since any part of it can get energy instantaneously if needed.

Instantaneous quantum remote sensing?

Ordinary remote sensing technology is limited by the finite velocity of light making it impossible to remote sense actively objects that are too faraway. Time mirror mechanism suggests a technology of active remote sensing based on time reflection at the studied object and thus involving no time lapse, and making possible remote sensing of arbitrarily distant, even astrophysical, objects due to the possibility of amplification in reflection and the fact that topological light rays are ”outside” the space-time and the interaction with matter is very weak. The only additional condition is the presence of the many-sheeted population reversal. This condition could be satisfied for living matter at least.

Dela-Warr camera [35] might be based on this mechanism. Even more science-fictively and a little bit of tongue in cheek, one can consider also the possibility of communicating with the civilizations of the geometric future by using population inverted lasers. Send to the geometric future classical k-bit signals (k harmonics of the fundamental) at p-adic frequencies $f(n, k)$ to tell that we have discovered p-adic cognitive codes, and wait whether the population inverted lasers at these frequencies return to the ground state with an abnormally high rate! One can easily imagine simple codes for communication. For instance, for p-adic length scales corresponding to visible wave lengths the typical number of bits would be 163.

Remote utilization of energy

In the technological context remote metabolism would translate to a remote utilization of energy stores making un-necessary the costly transport of the fuel. Only negative energy signal of critical intensity would be required to generate amplified positive energy signal from the geometric past providing the energy instantaneously and over long distances. Since many-sheeted lasers defined by space-time sheets of many-sheeted space-time are everywhere (energies correspond to zero point kinetic energies), the spaceship could get its energy almost in any environment which is sufficiently many-sheeted.

The need to carry large amounts of fuel and the limitations posed by the maximal classical signal velocity are the basic problems of the space technology. The technological variant of the remote metabolism might provide at least a solution to the fuel problem. The work with the Searl machine suggests that phase conjugate laser beams could also generate antigravity effects [G2].

Sharing of mental images and telepathic communications

Time mirror mechanism allows also the system of geometric now to entangle with that of the geometric past. This means that the systems of geometric now and past share mental images. This could be the mechanism of episodal memory in which events of geometric past are re-experienced. The mechanism makes also possible telepathic sharing of mental images: for the system in future the experience represents memory (not necessarily personal) and for the system of past to precognition. It might be that the civilizations of remote geometric future have developed this mechanism to a refined technology allowing them to directly experience what the civilizations of geometric past and future experience. Encounters of UFOs and aliens could be this kind of remote contacts. They would be absolutely real encounters in the sense that the sensory perceptions are about real aliens but generated telepathically.

Plasma oscillation patterns as holograms

The so called 4-wave interaction involves four laser beams: probe beam and its phase conjugate and two laser beams in opposite directions and interfering to a standing wave [K4]. In bio-systems probe beam and its phase conjugate would be responsible for remote metabolism providing the energy needed to build the hologram by time mirror mechanism. Standing wave in turn would define a simple hologram serving as a fundamental sensory representation from which more complex sensory representations are constructed. If the oppositely moving laser beams have slightly different frequencies, the standing wave pattern moves. Nerve pulse could basically result in this manner.

Plasma oscillations of ionic charge densities represent standing waves since the plasma oscillation frequency does not depend on the wavelength so that the standing pattern repeats periodically. The metabolic energy needed to build up plasma oscillation patterns would be obtained by time mirror mechanism using wave and its phase conjugate (probe beam and its phase conjugate).

This would be one reason for why ions are so crucial for living cell. All atomic nuclei are completely ionized Z^0 ions and this would make possible further plasma oscillations. In fact, the Z^0 plasma frequency of water corresponds to the fundamental metabolic energy currency .44 eV so that metabolism could be used to build Z^0 holograms based on water molecules. Many-sheeted space-time predicts entire hierarchy of plasma frequencies coming as powers of 2.

5.3.4 Vision about the evolution of life

The notion of many-sheeted space-time could allow to understand many puzzles related to the pre-biotic evolution [19, 20]. There are many constraints on the models for pre-biotic evolution. The models have also many difficulties [21, 22].

Cognitive evolution proceeding from long to short scales is also present

General principles of TGD lead to an overview about how evolution must have proceeded. Usually the evolution of life is seen as an evolution proceeding from short to long length scales (atoms, molecules, cells,...). Also cognitive evolution must have occurred in parallel with the chemical evolution, and since p-adically small means large in real sense, cognitive growth must have proceeded from long length and time scales to short ones. Learning of a motor skill and carving a statue by starting from a rough sketch and adding gradually details are good examples of the process. Magnetic flux tubes

structure must have developed gradually more and more intricate by the emergence of local structures by a process analogous to a construction of a fractal. The resulting magnetic flux tube structures have in turn served as templates for the formation of bio-matter.

The study of field equations leads to a classification for the phases of matter according to the dimension of CP_2 projection. Magnetic field structures for which CP_2 projections have dimensions $D = 2$ and $D = 3$ have interpretation as phases analogous to ferromagnetic phase and spin glass phase respectively and $D = 2 \rightarrow 3$ phase transition would be presumably induced by the interaction of flux tube structures with bio-matter and lead to the extremely complex but organized phase identifiable as living matter. $D = 4$ phase would in turn correspond to chaotic phase analogous to a demagnetized phase.

These ideas lead to a rather detailed vision about how the pre-biotic evolution might have proceeded.

1. *Standard vision about pre-biotic life is problematic*

The prevailing mechanistic world view forces to conclude that life emerged accidentally in young Earth during a relatively short time period of about .3 billion years. On basis of extensive computer simulations, one can fairly say that a spontaneous generation of life in primordial ocean seems extremely implausible [21].

TGD replaces materialistic view with a continual re-creation in which classical universe in 4-dimensional sense is replaced by a new one in each quantum jump. p-Adic length scale hypothesis allows to formulate the notion of evolution precisely as a generation of increasingly larger space-time sheets characterized by preferred p-adic primes meaning also a sequence of symmetry breakings. Macroscopic and even astrophysical quantum coherence becomes a key features of living matter. Theory is partially non-deterministic also in classical sense but the absolute minimization of Kähler action and self-organization lead to Darwinian selection of selected patterns.

2. *Did life develop in the womb of Mother Gaia?*

A stable star and planet providing appropriate conditions such as temperature for liquid water is needed. The many-sheeted view about life widens dramatically the spectrum of possible environments for the pre-biotic evolution. In fact, the interior of the many-sheeted Earth could contain Mother Gaia's womb providing a shielded environment for the evolution of life instead of the rather harsh environment defined by the primordial atmosphere and ocean.

The womb would be located somewhere below the boundary at which $k = 137$ atomic space-time sheets transform to very hot $k = 131$ space-time sheets: this should occur when the thermal de Broglie wave length becomes equal to the p-adic length scale $L(131)$. The transition occurs above the crust-mantle boundary (1300 K). Below the 131 – 137 boundary, the temperature at $k=137$ atomic space-time sheets diminishes and the range of temperatures could cover also room temperature. Mantle-core boundary (4000 K) is a good candidate for the surface at which the temperature at $k = 137$ space-time sheets is near to the room temperature.

In a sharp contrast to the standard wisdom, something like a mirror image of the biosphere should exist at the other side of the mantle if one takes many-sheeted space-time seriously. The hot $k = 131$ space-time sheets yield a thermal radiation with wave lengths containing ordinary metabolic energy currency about .5 eV. The dropping of ions O, C, N from the hot $k = 131$ space-time sheets to larger space-time sheets generates light at visible frequencies replacing solar light so that even intra-terrestrial counterpart of photosynthesis could develop. The dropping of oxygen atoms could make also possible development of oxygen based metabolism.

3. *Was chemical evolution guided by magnetic body of Mother Gaia?*

The notions of many-sheeted body, topological field quantization, and classical Z^0 modify profoundly the views about chemical evolution.

1. Atoms like C, N, and O and smaller amounts of P and S giving rise to bio-monomers, and metals like Al, Fe, and Zn are the basic building blocks. The formation of various chemical bonds like hydrogen bonds, covalent bonds, and peptide bonds could involve many-sheeted physics in a nontrivial manner.
2. The formation of biological monomers (amino acids, nucleotides, fatty acids, sugars) is an essential element of life. Except for DNA nucleotides, basic monomers evolve in the circumstances

simulating to what have been believed to be the primordial atmosphere. These bio-monomers are found even in the interstellar space and in galactic clouds so that the question is not whether the pre-biotic life can develop but whether our recent day materialistic science allows to understand how it develops. The standard wisdom about primordial atmosphere as a reducing environment (containing no oxygen) indeed leads to grave difficulties. Also the concentrations in the primordial ocean seem to be quite too low for the bio-monomers to be synthesized [22]. Magnetic flux tube structure of the magnetosphere acting as a nervous system and a metabolic circuitry of the magnetic Mother Gaia could make possible controlled metabolism already during the pre-biotic period and allow to circumvent these difficulties.

3. The formation of the biological polymers such as proteins, nucleic acids, lipids, and carbohydrates occurs universally by dehydration. The problem is that in water environment polymers are unstable against decay by hydration: it would seem that a metabolic energy feed is required already at this stage to guarantee non-equilibrium situation. The solution to the difficulties could be quantum control from the magnetic flux tubes of magnetosphere providing primordial metabolism with the same universal energy currencies as associated with the recent metabolism. Phosphate-sugar polymers form the backbone of nucleic acids and metabolism is based on ADP and ATP formed from adenine and phosphate ions. It has been already earlier found that the generation of ATP and its metabolic utilization involve the flow of protons between the atomic space-time sheets and some larger space-time sheets, say magnetic flux tube of Earth [K6]. It will be found that this mechanism is involved also with the dehydration leading to polymerization and phosphorylation. The reversal of this process also implies the un-stability of DNA in an ordinary aqueous environment.
4. The assembly of these macro-molecules into organized aggregates like chromosomes, microtubules and cell organelles could involve many-sheeted physics. Classical Z^0 fields generated by nuclei, which are completely ionized Z^0 ions, are screened by neutrinos but not locally since the size of neutrinos is much larger than the size of the nucleus. Classical Z^0 fields, besides explaining chiral selection of bio-molecules, could be a central tool in the control of the molecular engineering since Z^0 tidal forces allow to distinguish between nuclei with different A-Z/A ratios.
5. Also the emergence of catalysts, metabolism, and the membrane bound structures should be understood. Super-conductivity at magnetic flux tubes and its breakdown, as well as the possibility of negative energy MEs having phase conjugate laser waves as standard physics counterparts, are expected to be especially relevant for the catalytic action. Bound state quantum entanglement in macroscopic length scales is also an absolutely essential part of this mechanism. Intentional action realized in terms of negative energy MEs and appearing already at the molecular level, is expected to become an increasingly important aspect of catalytic action when the complexity of the structures increases. In TGD framework a primitive many-sheeted metabolism is present from the beginning and becomes only refined during evolution. Most importantly, metabolic currencies are constants of nature by the p-adic length scale hypothesis. Self-organization in many-sheeted space-time is expected to automatically lead to the generation of the gel phase as a possible predecessor of membrane bounded structures as well as of membrane structures themselves containing liquid crystal water stabilizing also DNA nucleotides.

4. Emergence of genetic code

The emergence of the genetic code has remained a mystery in various scenarios of pre-biotic evolution. The TGD inspired solution of the puzzle came from a rather unexpected (or should one say un-respected) direction. Chilbolton and Crabwood crop formations [51, 52, 53, 54] led to the realization of the exact A-G symmetry and slightly broken T-C symmetry of the genetic code. These symmetries strongly suggest that the evolution of the triplet code occurred as a fusion of singlet and doublet codes. One ends up with a detailed model for how this happened by using some hints provided by Chilbolton crop formation [51, 52] and the structure of tRNA molecule carrying in its fossilized parts detailed information about the evolution of the code. Nanno-bacteria [23, 24] might correspond to some predecessor of the recent genetic code. Nanno-bacteria accompany mineral structures and actively manipulate them: this conforms with the view that mineral interfaces have been indeed important for the evolution of polymers.

Introns are the basic mystery of DNA. TGD predicts that language is a universal phenomenon. It appears already at prokaryotes and is based on genetic code realized as temporal field patterns and at level of eukaryotes introns define memetic code (code word has 126 bits) besides genetic code and define kind of higher level language. Memes represented as sequences of 21 DNA triplets and expressing themselves as field patterns associated with MEs would realized this higher level universal language.

Plasmoids as primitive life forms?

If the self-organization leading to the generation of life proceeds from magnetic body of to the biological body then simple many-sheeted topological quanta containing plasma, plasmoids, should be the simplest life forms. For instance, plasmoids could carry torus like magnetic flux configurations. The flux tubes of magnetic field can form extremely complex knotted and linked structures. This topology provides almost enormous representational capacity and one can wonder whether the opportunistic Nature could really have failed to notice this opportunity.

Perhaps the simplest plasmoids (even ball lightning!) might be regarded as the magnetic counterparts of the simplest monocellulars. Note that small plasmoids should be generated also when supra-currents in bio-matter leak out from the magnetic flux tubes. Neural circuits might be accompanied by plasmoids responsible for the self-organization of the ordinary matter around them.

The zero point kinetic energy liberated when particles drop from say atomic space-time sheets to the space-time sheets magnetic flux tubes, would define basic metabolic energy quanta for the plasmoid. Therefore metabolic energy quanta would be by p-adic length scale hypothesis universal and same everywhere in Universe. Thus metabolism would not be result of biochemical evolution but precede it. Plasma oscillation patterns at plasma-frequency are ideal hologram like sensory representations built using time mirror mechanism so that plasmoids could have primitive sensory systems.

1. *Plasma sheet as a 'microchip'*

There is a fascinating finding about the 'memory chip' character of the organization of the ionic velocity distribution in the plasma sheet [43] at the night side of the Earth's magnetosphere. The belief was that the distribution is a Maxwellian thermal distribution but a complex organization of the number of ions as a function of speed and direction relative to the direction of the local magnetic field has been detected [43]. By coloring the bins representing small volumes of the velocity space, one finds that 3-dimensional features like 'eyes' and 'wings' appear! The proposed interpretation is that these features codes the history of ionic currents. One cannot exclude the possibility that these ionic currents could reflect even our sensory experiences. The prediction is that also other transition regions (in particular magneto-pause) should exhibit similar complex self-organization patterns.

2. *Plasmoids in laboratory*

It seems that one of the most craziest predictions of TGD inspired theory of consciousness has been realized at laboratory. Quite recent report tells about plasmoids generated in a simple diode involving plasma generator creating plasma column between itself and the positively charged anode [25]. The plasmoids are self-organizing structures able to evolve in a period of few microseconds. They possess many properties that life forms are expected to have. Plasmoids

- i) grow from micrometer size up to cm size,
- ii) replicate by simply dividing into two pieces,
- iii) have an outer negatively charged surface separating the positively charged interior from the environment and obviously analogous to the cell membrane. Hence the plasmoid is analogous to a capacitor, and the exchange of matter with the environment could correspond to a di-electric breakdown essential for qualia in TGD based model of the sensory receptor,
- iv) possess a metabolic cycle involving the transfer of matter between the interior of the plasmoid and environment. This cycle is seen as a periodic generation of visible light at specific frequencies: the light balls are typically found to be red or yellow. The frequency of metabolic oscillations is at 25-45 kHz frequency range,
- v) are able to communicate by generating electromagnetic radiation by inducing vibrations in the receiving plasmoid at the same frequency.

These findings give valuable hints concerning the more detailed modelling the "biology" of plasmoids. Plasmoids are in a key role in the TGD inspired model of pre-biotic evolution discussed in

[L4]. For instance, one can ask whether the preferred colors might be interpreted in terms of quantized increments of zero point kinetic energies liberated when atoms or ions (such as C, N, and O) drop from the hot $k = 131$ space-time sheets (temperature being of the order of the zero point kinetic energy) to larger space-time sheets.

3. Plasmoids and the emergence of dark H_N -atoms

As already discussed briefly, the notion of dark N -atom leads to a new vision about hydrogen bond and water, and allows to identify a fundamental mechanism of catalysis. For instance, H_N atom at $k = 1$ level of dark matter hierarchy can be regarded as a space-time sheet folded λ times in radial direction. Single electron energies are in the lowest order approximation same as for ordinary hydrogen atom and the sizes of H_N - and H -atoms are also same. What is new that the number of electrons can range from $N = 1$ to $N = \lambda \simeq 2^{11}$. This means that H_N -atoms define ideal letters for the names of molecules obtained by replacing ordinary hydrogen atoms capable of forming hydrogen bonds with H_N -atoms. The fusion of H_N - and H_{N_c} -atom ($N_c = \lambda - N$) is strongly favored since it gives rise to λ -atom expected to be especially stable as a full electron shell.

The identification of the hydrogen atoms of hydrogen bonds as H_λ -atoms leads to a general vision about how symbolic representations appear at the molecular level and how the extreme selectivity of bio-catalytic is due to the enhanced probability molecules with name and conjugate name to fuse to hydrogen bonded reaction complex and spitting out one proton dropping to a larger space-time sheet and liberating metabolic energy quantum in this process kicking the reaction complex over the potential wall to the final state. Also the exceptional role of water in the evolution of life can be understood.

How the first H_N atoms did emerge becomes the basic question about pre-biotic evolution. A plasma phase containing free electrons seems to be a necessary prerequisite if one takes seriously the hypothesis that the increase of Planck constant as a phase transition taking place as gauge interactions become so strong that the perturbative treatment fails (color confinement of quarks is good example of this phenomenon).

This supports the view about plasmoids as predecessors of molecular life forms, and also encourages to take more seriously the crazy sounding idea that hot temperatures, say those prevailing in planetary interiors or even solar photosphere, are a necessary prerequisite for the emergence of plasmoids and possible N-molecular variants of life [N3, L4].

Dark matter hierarchy and evolution

Dark matter hierarchy leads to an amazingly concrete picture about evolutionary hierarchy allowing to identify the counterparts for concepts like mineral, plant, and animal kingdom that we learned during schooldays and ceased to take seriously as students of theoretical physics as we learned that other sciences are just taxonomy. Even more, a view about what distinguishes between prokaryotes, eukaryotes, animal cells, neurons, EEG, and even about what makes cultural evolution, becomes possible.

There are two hierarchies involved with the dark matter hierarchy. The dark levels associated with weak bosons for which $k_W = 1$ corresponds to the p-adic length scale about $L_W(1) \sim 1$ Angstrom with exotic weak bosons corresponding to $k = 113$ (rather than $k = 89$ as for ordinary weak bosons). There is also electromagnetic dark hierarchy and in a given length scale one has $k_W = k_{em} + 2$. In a given scale weak sector would be ahead in evolution by two units so that weak dark bosons can be associated with more abstract functions like cognition and planning whereas em level would be related to simpler functions.

Ordinary matter corresponds to $k_W = k_{em} = 0$ and ordinary value of \hbar and higher levels correspond to scaled up values of \hbar with scalings λ^k , $\lambda \sim 2^{11}$. This mean scaling up of various quantum length scales and also the sizes of space-time sheets by λ . It seems that magnetic flux quanta are the primary structures forming hierarchy of this kind and large \hbar means that cyclotron energy scales expressible as $E = \hbar(k)eB/m \propto \lambda$ so that an arbitrarily weak magnetic field strength can in principle correspond to a cyclotron energy above thermal threshold at room temperature.

The appearance of space-time sheets zoomed up in size by a power of λ means the emergence of new levels of structure and it is natural to identify big leaps in evolution in terms of scaling of \hbar by λ and emergence of new large magnetic flux sheets satisfying magnetic flux quantization condition with the unit of flux scaled up by λ . This leap is quantum leap but in different sense as thought usually.

The emergence of higher dark matter levels would basically mean the integration of existing structures to larger structures. A good metaphor are text lines at the pages of book formed by magnetic flux sheets whose width is scaled up by λ as the new level of dark matter hierarchy emerges.

This conceptual framework gives rather strong guidelines for the identification of the levels of evolutionary hierarchy in terms of dark matter hierarchy. The outcome is a detailed vision about big evolutionary leaps discussed in [L2] in detail.

5.3.5 Could simple life forms be induced by intentional action?

Since life would involve self-organization of magnetic flux tube patterns, one can consider the possibility that intentional actions could induce this self-organization and in well-defined sense give the spark of life to the dead matter. Obviously, the highly advanced civilizations of geometric future might have developed a kind of spark-of-life technology and using time mirror mechanism they could induced self-organization inducing life in remote geometric past. Perhaps we are doing this all the time for our brains of the geometric past when we remember.

There is some support for this wild speculation. William Tiller in Stanford University has carried out impressive experimental work with what he calls intention imprinted electronic devices (IIED), and his results challenge that standard assumption that the intentions of experimenter do not affect the experimental apparatus [38, 39, 40]. The simplest explanation for the findings is that intentional action induces magnetic self-organization of IIED and of the target material used in experiments. For instance, purified water develops pH-, temperature- and conductivity oscillations and its pH becomes sensitive to external magnetic fields.

Experimental arrangement

The goal was to try to imprint a specific intention into a simple, low tech electronic device so as to influence the companion, specific, well-designed, target experiment. The intentional imprinting was attempted in a meditative state. The intentionally imprinted device, IIED, was sent to a laboratory located at distance of about 1500 miles where colleagues had set up the experiment. The device was placed about 6 inches from a continuously running and computer-monitored target experiment and switched on (total electrical power rate was less than 1 microwatt). Over a time period of about 1-4 months the recorded results from the target experiment changed in the directions of the specific intention and the change eventually reached the selected magnitude of the specific intention. Also an identical, but not intention imprinted device was used and the results were compared in order to achieve more objective measurements about the effects of human consciousness on electric devices.

The targets used were purified water, some bio-molecules, and larvae of flies. These targets were either unshielded or shielded from radiation. For the latter purpose they were closed inside a grounded Faraday cage (FC), which screened rather effectively the radiation coming at microwave frequencies whereas for ultra low frequency (ULF) fields the screening is virtually absent (skin depth behaves as $1/\sqrt{\pi\sigma f}$ at low frequencies and $f = 2\pi\sigma$ (in units $\hbar = c = 1$) defines kind of critical frequency above which screening occurs effectively). The targets could be affected by control device (CD) or by identical IIED generating microwave radiation. Radiation was generated either at single frequency (7.3 MHz) or at three frequencies (5.0, 8.0 and 9.3 MHz) [41].

In the case of purified water the spatial distributions of physical parameters like pH, temperature, and conductivity were measured as a function time. In the case of bio-molecules the possible effect on thermodynamical activity, which measures the thermodynamical energy of single molecule, was measured. In the case of fly larvae the possible effect on the larval development time was studied. The results from various arrangements were compared with control targets (no FC, no CD, no IIED).

Experimental findings

The basic experimental results were two-fold. First of all intended effects were achieved. Secondly, the "conditioning" of the laboratory resulted as an unexpected effect and continued even after the removal of the target and IIED.

1. *Effects of the intentional action*

1. IIED imprinted by intention to increase/decrease the pH of water gradually induced a shift in the pH of purified water to the intended value, increased the in vitro thermodynamic activity of bio-molecules, and a reduction of larval development time.
2. For bio-molecules and larvae four simultaneous side-by-side treatments were tested: i) an unshielded sample, ii) a shielded sample, iii) a shielded sample with an "on" control device, iv) a shielded sample with an "on" IIED. Just the shielding of em radiation affected the thermodynamic activity of the bio-molecules, and just adding less than about 1 microwatt of microwave radiation via control device reduced the thermodynamical activity and lengthened the developmental time. Thus the microwave radiation acted as a stressor having entropic effect. When the control device was replaced with IIED, the degradation caused by microwave radiation was overcome.

2. "Conditioning" of the laboratory

Quite unexpected phenomena arose from a repeated conduct of IIED in a given laboratory space. By simply continuing to use IIED in the laboratory space, it became "conditioned in some very fundamental way". Three signatures heralded the onset of the "conditioning" process.

1. Oscillations of air and water temperature, and of pH and electrical conductivity of water with large amplitudes with the periods of oscillations in 10-100 minute range developed. The amplitudes of pH- and temperature oscillations was $\sim \Delta pH = .1$ pH-unit and $\Delta T \sim 1 - 3$ K units respectively. Even more remarkably, the oscillations were sustained in the locale even after the removal of the IIED suggesting kind of phantom effect analogous to phantom DNA effect. Oscillation amplitude had peaks at the harmonics of fundamental frequency $f_l = 1/T_l$, $T_l = 36.6$ minutes with three lowest harmonics being very clearly visible [40]. Also $T_l = 51.2$ minutes appears as fundamental period in some experiments. The ratio of these periods is 1.4 and rather near to $\sqrt{2} = 1.41$, which might relate to p-adic length scale hypothesis.
2. When an pH-increasing IIED with intention to increase pH by one unit was turned on in an almost unconditioned space located several hundred feet away from a strongly conditioned space, a well-defined pattern of pH-oscillations in an unconditioned space emerged. This pattern was accompanied by a highly correlated pattern of oscillations in strongly conditioned space. This kind of highly correlated oscillations were not observed in several unconditioned spaces also located several hundred feet away.
3. The targets were subject to the action of a vertically aligned magnetic field in the range of $10^{-2} - 5 \times 10^{-2}$ Tesla, such that the direction of the field could be reversed. In an unconditioned space the change of the direction of the magnetic field did not affect the pH. In the strongly conditioned space the effect on pH was different for the opposite directions of the applied field and the difference in pH values was about .6 units. One can say, that the target had become sensitive to the effects of external magnetic fields.

Explanation of the pH oscillations in terms of the general model of intentional action

The findings described above support the notion of magnetic body as mediator of the intentional action, and provide a connection with the general TGD based vision about pre-biotic evolution. The following general model for the effects suggests itself.

1. Intentional action induces magnetic self-organization of the control device and target

The magnetic body of IIED becomes a part of the intentional agent. Also the magnetic body of the target (purified water, etc...) partially fuses with that of IIED. Even more, the general model for the pre-biotic evolution [L4] suggests that the intentional action mediated via the IIED induced a self-organization of a p-adic hierarchy of topological field quanta of magnetic field in the target system. This kind of hierarchy is associated also with DNA in the TGD based model for the effects of laser radiation on DNA observed by Gariaev [44]. The generation of magnetic structures in shorter length scales is what one expects the intentional action to generate since intentional "growth" proceeds quite generally from long to short length and time scales.

The simplest candidate for the time scale of oscillations varying in 10-100 minute range is as the time scale associated with the cyclotron frequency of magnetic field quanta responsible for the intentional action. The cyclotron period of proton lies in 10-100 minute range for a magnetic field strength varying in the range of 27.8-278 pT. For $T_l = 36.6$ minute period the field strength would be 75.9 pT. The corresponding magnetic length is 4 mm and near to $L(188) = 3.7$ mm. The harmonics of the fundamental f_l could correspond to the quantized values of the magnetic flux coming as integer multiples of the basic flux with the strength of magnetic field quantized to integer multiples. Similar quantization of the Z^0 magnetic field strength is assumed in TGD based model of hearing [M6].

Cyclotron oscillations in the magnetic field could induce by some mechanism a periodic flow of protons between the magnetic flux tubes and the atomic space-time sheets of water and in this manner affect pH. pH-fluctuations would in turn induce temperature and conductivity fluctuations as side effects. Both $T_l = 51.2$ min and $T_l = 36.6$ min appear and have ratio very near to $L(k+1)/L(k) = \sqrt{2}$. If this finding is taken at face value, the magnetic flux quanta must be magnetic sheets for which magnetic flux scales as the inverse of the thickness $d = L(k)$ of the flux sheet having constant size in the second transversal dimension.

2. Scaling law of homeopathy and frequencies of pH-oscillations and microwaves

The experiment involves two frequencies: the ULF frequencies associated with the pH-oscillations and the frequencies associated with the microwaves generated by the control device. Since intentional action compensates for the entropic effect of microwaves, these frequencies must relate to each other and generalized scaling law is an excellent candidate in this respect.

The TGD based model explains and generalizes the scaling law of homeopathy, which states that low and high frequencies having ratio $f_h/f_l = 2 \times 10^{11}$ accompany each other. Cyclotron oscillations with frequency f_l would result when charged particles drop from smaller space-time sheets and liberate the increment of zero point kinetic energy as a radiation with frequency f_h . Also the reverse of this process could occur with generation of negative energy photons at frequencies f_h and f_l . The emission of two photons is needed to guarantee momentum conservation since the momenta of charged particles are so small as compared to photon momenta.

The generalized scaling law predicts

$$f_h/f_l = \Delta E_0/E_c(k_2) ,$$

where $\Delta E_0 = E_0(k_1) - E_0(k_2)$ is the zero point kinetic energy increment when a charged particle drops from the space-time sheet labelled by k_1 to the sheet labelled by k_2 . $E_c(k_2)$ denotes cyclotron frequency at the magnetic flux tube labelled by k_2 .

The factor f_h/f_l varies but does not depend on the mass of the charged particle and by the quantization of the magnetic flux are apart from a numerical factor proportional to the ratio $p_2/p_1 = 2^{k_2-k_1}$ defined by the p-adic primes $p \simeq 2^k$ for the two space-time sheets in question. The scaling law of homeopathy in its basic form and p-adic length scale hypothesis suggest that f_h/f_l is related by a power of two to $f_h/f_l = 2 \times 10^{11} \sim (200/256) \times 2^{38}$ so that one has

$$f_h/f_l = 2 \times 10^{11} = (200/256) \times 2^n ,$$

where the integer n varies.

The generalized scaling law suggests that the frequency of pH oscillations corresponds to f_l . The frequencies of microwaves would correspond to f_h identifiable as the zero point kinetic energy of proton liberated when it drops from space-time sheet generated by the intentionally induced magnetic self-organization.

3. The mechanism of intentional action

The control device generates microwaves, and the intentional action should compensate the effect of the control device. The model of the intentional action based on the time mirror mechanism supports the view that negative energy MEs and photons are involved. Phase conjugation means essentially time reversal, and it could compensate the entropic effect of the ordinary microwaves generated by IIED and acting as a stressor in case of fly larvae. This also conforms with the fact that phase conjugate microwaves and ULF waves can penetrate the Faraday cage.

The microwave radiation at frequencies f_h could induce a flow of protons between $k = 167$ space-time sheets and larger space-time sheets by providing the needed zero point kinetic energy to kick

protons to $k = 167$ space-time sheet. Negative energy (phase conjugate) microwave photons would induce the reverse process. By the basic mechanism of induced emission (now induced dropping) this in turn could induce the flow of protons from atomic space-time sheets to smaller space-time sheets as a kind of domino effect, and lead to a new flow equilibrium would result with different pH. The pre-requisite of this mechanism is that the hierarchy of the magnetic flux tubes characterizing also DNA is present in the target. The IIED affected by the intentional action would give rise to this magnetic hierarchy unless it already exists. IIED would play a role similar to an object received by the person to be healed from the healer (or vice versa) in remote healing.

A more detailed space-time description for what happens might be as follows.

1. ULF and microwave fields are coherently superposed inside MEs (incoherence would mean microwave MEs inside ULF MEs) so that the corresponding transversal magnetic and electric fields are precisely parallel by the highly non-linear properties of MEs. ULF frequencies correspond naturally to harmonics of cyclotron frequency because of the strong coupling to cyclotron phase transitions of the Cooper pair Bose-Einstein condensate.
2. MEs serve as temporary bridges connecting the boundaries of $k = 169$ and $k = 188$ space-time sheets and the oscillating electric field of ME is orthogonal to the boundaries. By quantum classical correspondence the microwave frequencies associated with ME as well as the voltage along the bridge correspond to integer multiples for the energy of a microwave photon. The same mechanism based on Z^0 MEs underlies the TGD based model of nerve pulse.
3. The superposed ULF and microwave frequency electric fields inside ME induce a periodic flow of the protonic Cooper pairs forth and back between the super-conducting flux tubes of the Earth's magnetic field ($k = 169$) and magnetic flux tubes of the field B_I ($k = 188$). Microwave part induces a rapidly oscillating force superposed to the slowly varying ULF part of the force. The oscillatory flow of protons from atomic space-time sheets to larger space-time sheets affects the proton density at atomic space-time sheets causing pH oscillations.

4. *Do the three peak frequencies for pH-oscillations correspond directly to three microwave frequencies by scaling law?*

Scaling law would suggest that the three peak frequencies coming as harmonics of $f = 1/T_l$, $T_l = 51.2$ min, correspond to three frequencies f_l identifiable as cyclotron frequencies corresponding to the quantized values $n = 1, 2, 3$ for the magnetic flux. The frequencies produced by control device producing microwaves in 1-10 MHz range are non-trivial [39, 40] and the first bet is that the frequencies given by the generalized scaling law must be in this range to compensate the entropic effects. The generalized scaling law $f_h/f_l = (200/256) \times 2^n$ with $n = 33$ gives the frequencies $f_h = 3.1$ MHz and its two harmonics 6.2 MHz and 9.3 MHz as counterparts of f_l and its harmonics. The frequencies produced by the control device are 5.0, 8.0 and 9.3 MHz and not harmonics of each other. Note however that the highest frequency corresponds exactly to the third harmonic of f_l .

Rather remarkably, $f_h = 3.1$ MHz corresponds to the zero point kinetic energy of a protonic Cooper pair at $k = 169$ space-time sheet associated with the magnetic flux tubes of the Earth's magnetic field. Thus protonic Cooper pairs could drop from the super-conducting flux tubes of the Earth's magnetic field to the magnetic flux tubes of ~ 76 pT magnetic field having $k = 188$. This in turn would generate a cascade like dropping of protons from the atomic space-time sheet so that pH is changed.

5. *Correlation between pH and temperature oscillations and protonic zero point kinetic energy*

In the case of water at temperature $T = 300$ K the amplitudes of oscillations are $\Delta T = 3$ K and $\Delta pH \simeq .1$. If the density of protons satisfies $n = n_0 \exp(-\Delta E/T)$, where ΔE is most naturally the zero point kinetic energy .4 – .5 eV of protons at the atomic space-time sheet, one has

$$\Delta pH = \frac{\Delta E}{T} \times \frac{\Delta T}{T} .$$

$\Delta pH = .1$ would require $\Delta E \simeq .3$ eV, which is quite near .4 – .5 eV.

The fact that the exponential $\exp(-\Delta E/T)$ happens to be near to the number $n/n_{H_2O} = 10^{-pH}$, gives further support for the idea that the zero point kinetic energy at $k = 137$ space-time sheet determines pH, or more generally, that the densities of various ions are determined by many-sheeted

chemistry and by zero point kinetic energies. If this interpretation is correct, $n(137)$ can be identified as the net density of protons including also protons bound to hydrogen atoms. The net density of protons at a given space-time sheet involves a degeneracy of states factor $g(k)$ so that one would have

$$n(137) = \frac{g(137)}{g(169)} \times n(169) ,$$

where $k = 169$ refers to the super-conducting flux tubes of the Earth's magnetic field. p-Adic fractality and p-adic length scale hypothesis imply that $g(k)$ scales as $1/L^3(k)$. This gives $g(169)/g(137) \sim (L(137)/L(169))^3 = 2^{-48} \simeq 4 \times 10^{-15}$.

6. Sensitivity to the external magnetic field

The effect of the pH values depends on the direction of the external magnetic field B_{ext} . This could be understood if B_{ext} interferes with the magnetic field at some level of magnetic hierarchy induced by the magnetic fields in .1 nT range which mediate the intentional action. pH is changed if the change of the magnetic field at these space-time sheets in the cellular length scale range affects the flow of protons between atomic space-time sheets and larger space-time sheets when .1 nT flux tubes with thickness around 100 μm are present. This is expected to be the case if the thickness of the flux tubes is affected by the external magnetic field. The flux tubes in a given p-adic length scale could even disappear as a result of destructive or constructive interference.

Concerning the detailed model there are two options.

- i) If the magnetic field consists of flux sheets so that one has $B(k) \propto 1/L(k) \propto 2^{-k/2}$. In this case the external field strength corresponds to p-adic length scale $L(k)$ related to the length scale $L(169) \simeq 5 \mu\text{m}$ by a scaling of $.5 \times 10^{-2} - 10^{-3}$ the length scale varies between $L(149) = .5 \text{ nm}$ (thickness of the lipid layer of cell membrane) and 25 nm. This option is supported at the level of DNA magnetic hierarchy by the findings of Gariaev about effects of laser light on DNA, and also by the fact that the ratio of $T_l = 51.2 \text{ min}$ and $T_k = 36.6 \text{ min}$ is very near to $\sqrt{2}$. This situation would result if the flux quanta at various p-adic length scales are quite generally obtained by scaling the flux tubes of the Earth's magnetic field in one direction by keeping the flux as constant.
- ii) If the magnetic field consists of flux tubes ($B(k) \propto 1/L^2(k) \propto 2^{-k}$) $L(k)$ is related to $L(169)$ by a scaling by a factor .1 - .03 so that it is in the range 1.6 - .5 μm .

7. Phantom effect

A further strange finding is that the removal of both IIED and target does not eliminate the temperature oscillations of the air although their amplitude is reduced by a factor of about ten. The phantom effect can be understood if the magnetic flux tubes associated with $k = 188$ magnetic field are present also in the air volume, and are not affected by the removal of IIED and target, so that the oscillatory flow of protons between $k = 169$ and $k = 188$ space-time sheets with cyclotron frequency continues and induces the oscillation of the proton density of air.

The effects caused by the quartz crystal

In some experiments the removal of the target and IIED was followed by the addition of quartz crystal [41]. The quartz crystal was made of natural quartz (in order to avoid undesired intentional imprinting!) and had height $h = 15.24 \text{ cm}$ and minimum diameter $d = h/2 = 7.62 \text{ cm}$. The crystal was asymmetric in the vertical direction having apex pointing upwards.

The findings were following.

1. When the crystal was in a vertical direction, its presence sharpened the existing spatial phantom profile for temperature oscillations of air and somewhat amplified it.
2. When the crystal was turned to a horizontal direction, its presence immediately increased the temporal frequency of T-oscillations by a factor slightly larger than two. The spatial profile became first almost flat and the amplitude weakened.

The interpretation of the stimulates several ideas and questions.

1. Does the spatial profile of T-oscillations correspond to a standing wave resulting as an interference pattern of microwaves?

The spatial profile for the temperature oscillations is measured using spatial resolution $D = h = 15.24$ cm, where h is the height of the quartz crystal. The profile is quasi-periodic with a period of $\lambda = 2D = 2h$. Of course, experiments with a better spatial resolution would be required to deduce reliably the profile but the measurements are consistent with a spatial oscillation having period $\lambda = 2D = 2h$. This kind of profile could result as an interference of two classical microwave beams propagating in two opposite directions and generating a standing wave with wave length $2h$. This kind of interference pattern is involved with the four-wave interaction producing phase conjugate waves: the interfering waves correspond to the reference beam and a beam opposite to it. The two additional beams correspond to beam and its phase conjugate, either of them generating the other one.

2. *Does the quartz crystal act as an amplifier?*

The orientation of the crystal is obviously important. This encourages to think that the incoming signal enters from a vertical direction and is amplified by the quartz crystal so that the vertical dimension determines the resonantly amplified wave lengths. Perhaps magnetic flux tubes of B_I and the Earth's magnetic field B_E are in this direction. It could be that the light-like vacuum current of ME generates positive or negative energy coherent photons with an intensity distribution having maximum in the directions orthogonal to MEs and that the presence of the quartz crystal amplifies the vacuum current inside ME. Alternatively, it could be enough that quartz crystal amplifies the classical fields associated with MEs.

The height h of the quartz crystal is one half of the microwave wavelength. Hence it could act like an absorbing or emitting half wave antenna. The fundamental frequencies associated with the microwaves would correspond to $f_1 = c/2h \simeq 1$ GHz for the vertical crystal and $f_2 = c/2d = 2f_1 \simeq 2$ GHz for the horizontal crystal. For the vertical crystal $\lambda_1 = 2h = 2D = 30.48$ cm would be the wavelength of the spatial profile which conforms with observations. For the horizontal crystal period would be $\lambda_2 = 2d = 15.4$ cm. The observed spatial profile immediately after the turning of the quartz crystal to horizontal position is flat in consistency with this prediction. It should be easy to check out whether the oscillatory pattern is present by improving the resolution.

3. *Are population inverted many-sheeted masers involved?*

The frequencies f_1 resp. $f_2 = 2f_1$ are rather near to the zero point kinetic energies of a protonic Cooper pair for $k = 153$ resp. $k = 152$. In the case of electronic Cooper pairs one has $k = 164$ and 163 (the ratio of proton and electron masses is near to a power of 2: $m_p/m_e \simeq 2^{11}$). Perhaps many-sheeted population inverted micro wave lasers are involved and time mirror mechanism induces dropping of protons to large space-time sheets or the reverse process. $k = 152$ and $k = 153$ correspond to length scales $\sqrt{2} \times L(151)$ and $2 \times L(151)$, where $L(151) = 10$ nm corresponds to the thickness of the cell membrane. The four-wave interaction suggested by the interpretation of the spatial profile would presumably involve many-sheeted laser mechanism at the microscopic level.

4. *Scaling law of homeopathy is satisfied*

The approximate doubling of the ULF frequency of T-oscillations when the quartz crystal is turned to a horizontal position is consistent with the generalized scaling law of homeopathy. The ratio f_h/f_l of frequencies of microwave and ULF oscillations occurring at 51.2 min period is 3.1×10^{12} for $f_h = f_1$ and 6.2×10^{12} for $f_h = f_2$. In a good approximation this ratio differs by a factor 2^4 resp. 2^5 from $f_h/f_l = 2 \times 10^{11}$.

These findings support the scaling law of homeopathy, time mirror mechanism as a microscopic part of the four-wave interaction utilizing many-sheeted population inverted lasers, and quartz crystal as an amplifier of intentional action. Much remains however poorly understood. In particular, the question how the phenomenological description of the four-wave interaction and time mirror mechanism could be integrated to a more comprehensive theory, remains open

5.4 How advanced civilization could study cosmos?

Space travel is not the best manner for the advanced civilization to study the surrounding cosmos. Rather, time mirror mechanism seems to provide almost unlimited opportunities to achieve this. Chilbolton (see Figs. 5.6 and 5.6) and Crabwoodcrop circles suggest that aliens could be either intra-

terrestrial life forms or ourselves in a relatively remote geometric future. The TGD based new physics suggest also a natural solution to the Fermi paradox ("Where are they all?").

5.4.1 Why space travel is not a good idea?

There are several arguments suggesting that space-travel over very long distances is not a good idea.

1. Direct encounters of life forms, which are at different evolutionary level would be probably lethal since immune systems would not be compatible. Thus there is no good reason for long space-travels.
2. With the recent technology the amount of fuel needed makes it impossible to get very far. Remote utilization of energy by time mirror mechanism could resolve this difficulty. Many-sheeted population inverted lasers might be everywhere and provide the needed energy. TGD suggests mechanisms making it possible to reduce the inertial mass of the space-ship dramatically. This kind of feather light space-ships could behave as UFOs are found to behave.
3. The finite value of the light velocity poses the most severe constraints. Time dilatation in principle allows the space-ship moving with sufficiently high velocity to get to arbitrary long distances in arbitrarily short proper time experienced by the crew. The problem is however that the civilization that send the crew to the flight could suffer extinction during the first days (as experienced by travellers) of the travel. Note however that time mirror mechanism could allow to circumvent this difficulty.

5.4.2 Time mirror mechanism as an ideal tool for the study of the Universe

Time mirror mechanism suggest a solution to the problem of communicating with civilizations in distant galaxies and light velocity ceases to be problem. Remote sensing in principle makes possible an active instantaneous scanning of arbitrarily distance galaxies. Remote motor control is also possible and in principle makes it possible to use simple life forms like plasmoids to perform desired tasks. These plasmoids could serve also as quantum mediums making sharing of mental images possible. This would give rise to a remote sensory system.

Also communications with the civilizations of the geometric future could be possible. p-Adic frequencies coming as half octaves of the frequency 10 Hz are excellent candidates for preferred frequencies and one can assign to each of these p-adic frequencies hierarchy of cognitive codes that with definite duration of code word and number of bits. Field patterns realizing these code words could provide means of communication with civilizations of both geometric future and past. ET experiences might have interpretation as a sharing of mental images induced by encounters with the plasmoids generated during the tectonic activity. Abduction experiences could represent real encounters with plasmoids.

Plasmoids could be seen an ideal realization for a living space-ship drawing its energy from environment. UFOs might be plasmoid structures emitted from the plasma sheet of some planet of a distant stellar system which have managed to penetrate through the cusp region of the magneto-pause of Earth, which serves as a magneto-immune system preventing the penetration of solar and other interplanetary magnetic life forms inside magnetosphere. A civilization at sufficiently high level of development could even intentionally generate magnetic self-organization patterns leading to birth of plasmoid like life forms. The somewhat ghostly crew of a magneto-UFO could consists of magnetospheric sensory representations for the inhabitants of this planet but this would not diminish the reality of the experience. Space travel of mental images would not require transfer of huge amounts of fuel through cosmos and light velocity would not be a limitation for the communications. There are good reasons to believe that higher levels of the self hierarchy have discovered mental space travel long ago if even we have been able to invent it!

5.4.3 What aliens are?

The first possibility is that aliens are extraterrestrials. In this case one cannot say much more. If one takes crop circles as an attempt of aliens to tell something about their civilization one ends up with much more detailed speculations. Chilbolton and Crabwood crop formations are the most fascinating

of these messages [51, 52, 53, 54]. The Chilbolton and Crabwood crop circles allow to even deduce rather precise information about the genetic codes of the alien life forms, and the second genetic code involves 80 DNAs and 23 aminoacids. This would mean that the civilization in question might be at a much higher evolutionary level that we are, and could have developed antigravity technology for long time ago. I have discussed the interpretation of these formations in the [N3].

The fact that the Chilbolton message so soon after the sending of Arecibo message providing information about human kind as species and had same format as Arecibo message could mean that the constructor of the messages is inside or at least in the vicinity of solar system.

A plausible hypothesis is that the magnetosphere of Earth, or possibly also of Sun, defining kind of collective conscious entity having various biological life forms as its "cells", has generated the crop circles using the same basic mechanisms as magnetic bodies use to generate generalized motor actions in biological bodies. Magnetosphere could communicate its own higher level knowledge to us or could mediate a message from somewhere.

Do crop circles tell about solars or intra-planetary?

If the crop circles are generated by control signals based on positive energy topological light rays, the constructor of the message, and perhaps also the civilization about which the message tells, can be at most at a distance of few light decades. Indeed, Chilbolton message suggests that the aliens live at Earth, Mars and Jupiter and perhaps even in Sun. The Sun is smaller than in Arecibo message, which might mean that the aliens live in below the corona, perhaps at the magnetic flux tubes of the convective zone carrying magnetic fields of order .2 Tesla for which electronic cyclotron radiation is at micro-wave range. The question is where in Earth's magnetosphere aliens could be hiding. The Freudian answer is that since they are not visible they must lurk in the cellar, that is underground. One can indeed build a vision about alien life based on this idea and consistent with the hints provided by the crop formations.

Do crop circles tell about futuro-terrestrials?

If the crop circles are generated by communications involving negative energy photons (phase conjugate light) then the signals responsible for the formation of crop circles arrive from the geometric future. In this case the civilization could be arbitrary far away from Earth. Chilbolton message however leaves only the possibility that the civilization is some other civilization or ourselves of the geometric future after the colonization of Mars and Jupiter. This civilization must have invented the technology making it possible to apply time mirror mechanism to induce magnetic self-organization patterns leading to the generation of plasmoids serving as mediums for telepathic communications and able to perform simple tasks like construction of crop circles.

How far in the geometric future futuro-terrestrials might live?

Chilbolton message could even allow to estimate how far in the geometric future the civilization constructing crop circles is located.

1. The smaller size of Sun could indeed mean a smaller size of Sun: standard model predicts that the radius increases very slowly so that this interpretation seems to be wrong in standard physics context. There are however highly controversial claims that Sun is shrinking with the rate of .1 per cent per century [45]: $d\log(R)/dt = 10^{-3}/\tau$, $\tau = 100$ years. The analysis of [46] however led to a conclusion that only oscillations with a period of 76 years are in question. If the shrinking occurred for the entire Sun rather than only surface layers, the claimed rate for shrinking would mean that gravitational energy would be liberated with a rate $P = GM_{Sun}^2/R \times d\log(R)/dt$, which would give $P \sim 10^{29}$ Watts, which is much higher than the power $P \sim 4 \times 10^{26}$ Watts radiated by Sun by known mechanisms.

The presence of the classical Z^0 force could make possible considerable deviations from the standard stellar evolution and might be also needed to explain the oscillations of the solar radius. The increase of the gravitational binding energy could be compensated by the increase of the repulsive Z^0 Coulombic energy so that the catastrophic conclusion could be avoided. One could say that gravitational and Z^0 force serve opposite tendencies compensating each other in the "solar homeostasis".

If the shrinking were real and would continue with the rate claimed in [45], one would have $R/R_{now} = \exp(-10^{-3}t/\tau)$. If the radius in Chilbolton message is by a factor $k < 1$ smaller than in Arecibo message, the proposed interpretation implies that the message must have been sent from a temporal distance $t \simeq \log(1/k) \times 10^3\tau \sim 10^5$ years in the geometric future. A more realistic estimate would probably increase the value of t by some powers of 10. If this extremely light hearted argument were taken seriously, a breakthrough in time mirror technology is not to be expected during my lifetime!

2. There is also a second manner to estimate the value of temporal distance of crop circle artists from us. Crabwood formation appeared year and one day later than Chilbolton formation. A possible interpretation is as a message telling that the it takes one day more for Earth to rotate around Sun in the geometric future so that year is by one day longer.

i) The mass loss of Sun causes the gradual weakening of the gravitational force of Sun causing the increase of the radii of planetary orbits and thus also of orbital periods. The rate for the increase of the orbital period is $d\log(T)/dt \equiv 1/\tau = -1/4 \times d\log(M_{Sun})/dt$. The rate of the solar mass loss is believed to be mostly due to the energy liberated in fusion, and one has in a good approximation $d\log(M)/dt = 10^{-13}/\text{year}$. This gives $T(t)/T(now) = \exp(t/\tau)$. The lengthening of year by one day requires a time $t \simeq \tau/365 \sim 10^{11}$ years, which is about one percent of the rough estimate for the lifetime of Sun, and of the same order of magnitude as the estimates for the time parameter called the recent age of the Universe. In fact, Sun is estimated to become a red giant within 7.5 billion years making life as we understand it impossible at Earth.

ii) Also cosmic expansion should affect the orbital radii of the planets. If the Hubble time t and radial coordinate r of Robertson-Walker cosmology with line element $ds^2 = dt^2 - a(t)^2(dr^2/(1+r^2) + r^2d\Omega^2)$ correspond to the coordinates t_{PN} and r_{PN} of the Post-Newtonian approximation, and if cosmic expansion can be treated adiabatically, the prediction is that the sizes of the planetary orbits increase are scaled as $L(a)/L(a_0) = a/a_0$, where a corresponds to M_+^4 light cone proper time appearing as the scaling factor of Robertson-Walker metric and related to the Hubble time t by $(t/t_0) = (a/a_0)^{3/2}$. By Kepler's law one has $T \propto L^{3/2}$ so that the period of the planetary orbit would scale as $T \propto a^{3/2} \propto t$. One day per year lengthening would correspond to $\Delta T/T = 1/365 = \Delta t/t$. For $t = 5 \times 10^9$ years this would give $\Delta t = 17$ million years.

iii) The estimate above is based on the neglect of perturbations caused by planets to each other's orbits. The multiple gravitational resonances between planets resulting, when the ratios of rotation or precession periods are integer valued, are a route to chaos (in the sense of complexity rather than randomness) in the planetary system. Since also Z^0 force is $1/r^2$ force, this hold true also when classical Z^0 force is taken into account. These resonances can affect dramatically orbital parameters. Numerical simulations lead to the conclusion that the Lyapunov time of planetary system is 5-10 million years [47]. If this holds true also in TGD Universe, then the parameter t for the future civilization for which year is one day longer than for us, could be as small as million years. In any case it seems that it takes quite a time to develop time mirror technology if this estimate makes sense.

5.4.4 Have more advanced civilizations performed genetic engineering at Earth?

A fascinating possibility that extraterrestrials, intra-terrestrials, or ourselves of the geometric future have performed genetic engineering. There is some support that this might be occurring.

1. The first sensational finding was the outcome of Great Genome Project. The "head-scratching discovery" by the public consortium, as Science termed it, came when the human genome was compared with the genomes of our predecessors [26, 27]. It was found that human genome contains 223 genes not possessed by invertebrates. Contrary to what one might expect, these 223 genes could make an enormous difference. The reason is that this number is more than two thirds of the number of the 300 genes differentiating between humans and chimpanzees so that these genes could be the main determinant of the dramatic difference between humans and chimpanzees in standard genetics. A possible explanation is that this difference is due to a

genetic engineering carried out by a more advanced civilization [N3]. This genetic engineering might have induced the migration of *Homo Sapiens* from Africa and an explosive evolution of language and culture.

2. The second sensational finding reported towards the end of the year 2003 was that the genome of corals, which are the simplest life forms possessing neurons, seems to resemble much more vertebrate genome than it resembles genomes of flies and worms [28]. Corals resemble vertebrates in the sense that they have calcium carbonate skeleton. Corals are multicellular structures consisting of two cell layers analogous to scaled up versions of the lipid layers of cell membrane. Thus coral colonies can be seen as organisms for which the role of cell is taken by corals, and are in a very well special sense at a higher evolutionary level than us. The assumption that corals are intra-terrestrial or extraterrestrial life-forms which have served as gene banks radiating their genes to the simple life forms in environment could explain the mysterious Cambrian explosion in which a large number of animal phyla emerged apparently from nowhere [29]. This speculative vision is discussed in [L1].

Aliens are not the only candidates for genetic engineers. Also magnetic Mother Gaia could be responsible for the genetic engineering, even the magnetic Mother Gaia of the distance geometric future. There are experimental findings [36] supporting that electromagnetic radiation can be imprinted by genetic information and that this genetic information can be transferred to the genome of developing embryos of even different species [K5].

Nothing precludes the possibility that genes/supergenes/hyper genes at some level of dark matter hierarchy can also code for genetic self engineering since these activities are after all very similar to other genetically coded bio-chemical activities. The computer analogy would be programs writing programs. The engineering genes would be activated by *W* MEs inducing plasma oscillation patterns. The claimed effects could be understood if the interaction with genetically imprinted electromagnetic field pattern activates genes inducing genetic self engineering yielding the genetic modifications consistent with the pattern represented by the em radiation.

Magnetic body would receive information about the desired outcome as electromagnetic field patterns emitted by other organisms, most naturally members of the same species. If these modifications are successful, the magnetic body is exposed to this information for long enough time to react and activate *W* MEs inducing the genetic program inducing the genetic program leading to the suggested genetic modification.

Hyper-genes [L2] integrating groups of organisms to larger wholes would be naturally involved with the mechanism. This mechanism would guarantee a rapid propagation of successful genetic modifications to the entire population and would be much more effective than the slowly occurring selection of random mutations. The possibly existing genes responsible for the genetic self engineering could be also introns and express themselves by activating nuclear RNA and process like reverse transcription.

5.4.5 Fermi paradox

The question "Where are they all?" is the best manner to formulate Fermi paradox. Fermi made estimates about the probability of intelligent life in Cosmos and ended up with the conclusion that intelligent civilizations should have already expressed their presence to us. There are many manners to achieve this.

1. The radiation generated by radio-wave communications leaks out to the interstellar space and should serve as a telltale signature about the presence of intelligence. The civilizations might be as willing as us to tell about the existence, and might send to the interstellar space radio-waves telling about them as a life form. We have indeed sent Arecibo message just in this purpose.

The communications based on Maxwellian radio waves might however represent a rather short period in the development of the civilization. Topological light rays allow precisely targeted communications without weakening and dispersion of the signal and since the signal propagates outside the space-time sheets containing matter, the perturbations caused by the interaction with matter are small. For this kind of communications the leakage of the signals is minimal, and the civilization remains invisible for civilizations which have not yet reached the technological

maturity to receive and interpret signals travelling along topological light rays (possibly parallel to magnetic flux tube structures serving as cosmic nervous systems). This is the safest option since civilizations like us might be very dangerous in their eagerness to declare Star Wars.

2. One might argue that high tech civilizations are doomed to produce a lot of entropy and the radiation resulting in this manner could also serve as a telltale signature. The discovery of the technology based on time mirror mechanism would however mean dramatic reduction in the entropy production. Quite generally, the second law of thermodynamics can be circumvented below p-adic time scale so that also the mad consumer period could be short lasting.
3. The engineering achievements of these civilizations in astrophysical length scales might be one signature. It is however not at all clear whether we are able to see them. Presumably living technology relying on magnetic self-organization of super conducting magnetic flux tube structures serving as an astrophysical "nervous system" is in question. Magnetic flux tubes however quite literally represent dark matter [D4] to us and the established science has not yet even discovered the notion of magnetic body and is still trying to explain dark matter in terms of various X-ons.
4. Star wars thinking would suggest that the civilization evolved to a high level technologically would build space-ships and start the conquering of other planetary systems. Macroscopic quantum coherence of dark matter in astrophysical length scales however provides completely new methods of communication and control, and it is quite possible that the aliens are just patiently waiting that we finally discover that dark matter aliens are here, there, and everywhere. One might hope that this discovery does not require the emergence of the next level of dark matter hierarchy in the terrestrial biological evolution since it might not take place during this week.
5. These civilization hardly see the trouble of transferring tons of material to foreign stellar systems since time mirror mechanism allows telepathic communications by sharing of mental images with civilizations of both geometric future and past. The encounters with UFOs and ETs might be just this kind of virtual meetings but most terrestrial scientists take them as hallucinations. The explosive development of science could be due to the sharing of mental images of more developed civilization but it is difficult for us to even consider the possibility that we have not discovered all this by ourselves.

Time mirror mechanism could make even possible intentional induction of magnetic self-organization creating plasmoid like life forms. The reports about intelligent light balls appear repeatedly but most terrestrial scientists refuse to take seriously these reports. Crop circles might represent an extreme example about an attempt of advanced intelligence to get into a direct communication with us but most scientists receiving monthly salaries refuse to even play with the thought that these formations might not be hoaxes.

On basis of these arguments it seems that Fermi paradox tells much more about us than the surrounding universe. Our view about consciousness and life and physics is so badly wrong that it leads to the conclusions that consciousness is illusion, living beings are deterministic robots, and Earth is the only living planet in the entire Universe. We could test however test the TGD based vision. Perhaps some mad scientist starts some day to build population inverted lasers at energies corresponding to p-adic frequencies and zero point kinetic energy increments in order to receive negative energy signals from future, begins to send phase conjugate waves to the geometric past at these frequencies using p-adic cognitive codes (genetic code in particular, [L1]), and starts to analyze carefully radio-wave patterns at the p-adic frequencies to see whether they contain some structure suggesting that the sender of the signal is intelligent.

5.4.6 Dark matter hierarchy as a solution of Fermi paradox?

The original version of this chapter was written few years before the ideas related to the quantization of Planck constant began to develop [A9]. The original stimulus came from the observation that the radii of the inner planets seem to correspond to the radii of Bohr orbits with a gigantic value of gravitational Planck constant $h_{gr} = gMm/v_0$, $v_0 \simeq 2^{-11}$. The radii for the orbits of outer planets in turn correspond to $v_0 \rightarrow v_0/5$ [50]. The dependence of h_{gr} on masses is fixed by Equivalence Principle

and $v_0 = 2^{-11}$ corresponds in TGD framework to a fundamental constant expressible in terms of CP_2 radius, Planck length, and Kähler coupling strength [D6].

The general theory for the quantization of Planck constants [A9] predicts the spectrum of M_{\pm}^4 and CP_2 Planck constants as integer multiples $\hbar(M_{\pm}^4) = n_a \hbar_0$ and $\hbar(CP_2) = n_b \hbar_0$ of the ordinary Planck constant \hbar_0 . The Planck constant \hbar_{eff} appearing in the Schrödinger equation using \hbar_0 as a unit equals to the ratio n_a/n_b having in principle all positive rational values.

The spectrum of Planck constants reflects a hierarchy of imbedding spaces characterized by finite subgroups of $SU(2)$ identified as a subgroup of $SL(2, C)$ in the case of M_{\pm}^4 Planck constant and of $SU(3)$ in the case of CP_2 Planck constant (appearing in the commutation relations of corresponding isometry Lie algebras). The subgroup $G_b \subset SU(2) \subset SU(3)$ defines a covering of M_{\pm}^4 by G_b -related points whereas the subgroup $G_a \subset SU(2) \subset SL(2, C)$ defines covering of CP_2 by G_a -related points. The covariant metric of M_{\pm}^4 factor is scaled up by n_b^2 , where n_b is the order of the maximal cyclic subgroup of G_b . Analogous result holds for CP_2 .

These copies of imbedding spaces are glued together to a tree like structure such that M_{\pm}^4 (CP_2) are identified by isometry if G_b (G_a) is same for the two copies. Each node involves infinitely many branches labelled by G_b (G_a). One can say that two kind of matters in this hierarchy are dark with respect to each other if they reside at different branches of this structure. If G_a (G_b) is same for the two sectors, a phase transition changing the value of Planck constant $\hbar(CP_2)$ ($\hbar(M_{\pm}^4)$) can occur and corresponds geometrically to a leakage been different sectors via an intermediate state which has 0-dimensional CP_2 projection or 2-dimensional M_{\pm}^4 projection (time like plane remaining invariant under $G_a \subset SO(3)$) containing the quantization axis for angular momentum). The points in the projection correspond to singular orbifold points for the G -covering in question.

Also a spectrum of number theoretic values of Planck constants is predicted: n_a and n_b correspond for them to n-polygons constructible using only ruler and compass. The resulting model for planetary orbits predicts that the ratios of planetary masses should be given as ratios q_{ab}/q_{cd} of ratios $q_{ab} = n_a/n_b$ of these preferred integers. This is rather strong a prediction and satisfied within 3 per cent. Also an absolute prediction $GMm/v_0 = n_a/n_b$ (say in the case of Earth-Sun pair) results and is wrong by about 4 per cent: the failure could be understood if the masses in question correspond to dark matter [D6].

Particles mass spectrum does not depend on the values of Planck constants whereas Compton length scales as n_a . For large values of \hbar_{eff} the overlap criterion for the formation of macroscopic quantum phases is satisfied due to the large values of Compton lengths. In the case of gravitational Planck constant the macroscopic quantum phases would have an astrophysical size. Dark matter hierarchy would correspond to a hierarchy of increasingly refined levels of consciousness with an increasing span of long term memory and planned action and utilizing the lower levels of hierarchy as sensory receptors and motor instruments.

In biology an especially important dark matter hierarchy seems to correspond to $\hbar(M_{\pm}^4, k) = 2^{11k}$, $\hbar(CP_2) = \hbar_0$ and great leaps in evolution could be understood as the emergence of a new level of this kind to the "personal" dark matter hierarchy realized as a hierarchy of magnetic bodies (topologically quantized magnetic fields associated with the system) [M3]. The group G_a would most naturally act as symmetry group of dark magnetic body transforming to each other the flux tubes of the magnetic body representing topological quantized dipole type magnetic field having a full rotational symmetry before topological quantization. n_a would give the number of flux tubes.

If one accepts the model for the hierarchy of EEGs, the duration of life cycle identified as a cyclotron time scale for a typical biologically important ion gives a reasonable guess for the highest level of dark matter hierarchy involved. For instance, from the requirement that EEG photons have energy above thermal energy, the time scale of ordinary EEG would correspond to $n_a = 2^{11k}$, $k = 4$, and the duration of our life cycle to $k = 7$. In meditative states referred often to as cosmic consciousness the value of k might be much higher.

In this conceptual framework the answer to the question "Where are they?" would be based on the identification of "them" as conscious entities at higher levels of dark matter hierarchy and living at different branches of the imbedding space. If all goes well, civilization would sooner or later achieve Omega point at which it becomes so convinced about the existence of this hierarchy that it initiates systematic attempts to build communications with higher levels of the hierarchy and perhaps "moves" more or less permanently to this branch of imbedding space which would naturally explain Fermi paradox.

5.5 What UFOs are?

The second key question concerns the interpretation of UFOs. Interpretation as plasmoids might be equivalent with interpretation as living flying saucers able to reduce their inertial and gravitational mass and using time mirror mechanism to suck energy from environment.

5.5.1 UFOs as plasmoids?

One of the most important findings about UFOs is their butterfly like behavior. They can accelerate very rapidly and change their direction of motion instantaneously. Since this occurs without generation of shock waves, the only conclusion seems to be that their inertial and gravitational masses are very light.

Persinger has proposed a model explaining the experiences about encounters of extraterrestrials as hallucinations caused by the perturbations of Earth's magnetic field induced by the liberation of the tectonic energy at the lines of tectonic activity [37]. The model is based on well-established statistics about the effects of the perturbations of Earth's magnetic field on consciousness collected in mental hospitals. The lines of the tectonic activity are also accompanied by well established luminous phenomena which suggests that the model could be naturally combined with the explanation of UFOs as this kind of luminous phenomena.

This suggests that UFOs might be plasmoids. These primitive life-forms could use time mirror mechanism to receive metabolic energy and tectonic activity would be excellent source of metabolic energy. Plasmoids, being extremely light structures, could easily follow the energy beam flowing from the spot of tectonic activity, and the random variation of the beam direction could explain the random butterfly like motion of UFOs often observed and very difficult to understand if UFOs are structures built of steel and copper. This identification does not of course mean that plasmoids could not be living, intelligent space-ships. The lightness and ability to draw energy from the environment would make plasmoids ideal for this purposed.

5.5.2 UFOs made of copper and steel?

There is some evidence for 'metallic' UFOs too. In particular, the claimed Roswell case involving a "traffic accident" of UFO and dead bodies of aliens suggests that aliens and UFOs are real. TGD based model [G2] for the strange antigravity effects observed in rotating magnetic systems [49] leads to a mechanism which might be behind flying saucers. The basic idea is that the space-time sheet of rotating magnet is connected to the space-time sheet carrying Earth's gravitational field by join along boundaries bonds, one can visualize them as threads connecting the rotating system to the environment. Along these threads the gravitational flux created by the magnet flows to Earth's space-time sheet and these threads mediate the gravitational interaction.

Rotation causes the entanglement of the threads and when the rotational speed becomes high enough, the threads begin to split. This means that the ends of the split threads become carriers of negative and positive gravitational mass. Effectively the gravitational mass of the magnet system remains to the Earth's space-time sheet and the mass of magnet system itself decreases and angular momentum conservation implies an acceleration of the spinning motion (pirouette effect). If the inertial mass is equal to the gravitational mass as Equivalence Principle requires, a system which is light as a feather results!

This mechanism might make possible flying saucers. For instance, the rotating system could apply time mirror mechanism to generate the needed very fast motion making possibly mass loss. It could also accelerate and change direction of motion very quickly. The strange properties of UFOs suggest that if they are really flying saucers, a reduction of the inertial mass is indeed involved. Thus one might think of the possibility that plasmoid like structure and a more rigid structure accompany each other in some cases. The rotating magnet system involves also plasma near its outer boundary and would in this case be due to acceleration of ions in radial electric field generate by the rotating magnet. Plasmoid like structures indeed involve magnetic flux tubes and this suggests that they could rotate rapidly and in this manner reduce their gravitational and inertial mass.

5.5.3 Are flying saucers necessarily living systems?

The following arguments suggest that flying saucers are necessarily living systems.

1. As explained earlier, the study of field equations leads to the classification of basic phases of matter by the dimension D of CP_2 projection of the space-time sheet. $D = 2$ would naturally correspond to magnetic flux tube structure associated with non-rotating magnetic system. This phase is simple and analogous to a ferro-magnet. As already found by Faraday, a radial electric field accompanied by a non-vanishing vacuum charge density is generated when a constant magnetic field is put into rotation. The non-vanishing charge density requires a 3-dimensional CP_2 projection. The conclusion is that rotation induces a phase transition $D = 2 \rightarrow 3$.
2. The phase transition implies a qualitative change in the structure of the magnetic fields and could thus explain the generation of magnetic walls observed in the rotating magnetic system [49]. What is fascinating that $D = 3$ phase corresponds to the living matter in the proposed classification. This would conform with the idea that the ADP-ATP machinery responsible for the metabolism is a molecular Searl machine. Hence the strange effects observed in rotating magnetic systems might reveal the fundamentals of the dead \rightarrow alive phase transition. Also this suggests that plasmoids could be seen as flying saucers which are living just because they are flying saucers.
3. The increase of the dimension of CP_2 projection could generate join along boundaries contacts and wormhole contacts leading to the transfer of charge between different space-time sheets. The possibly resulting flow of gravitational flux to larger space-time sheets might help to explain the claimed antigravity effects.

Bibliography

Online books about TGD

- [1] M. Pitkänen (2006), *Topological Geometro-dynamics: Overview*.
http://tgd.wippiespace.com/public_html/tgdview/tgdview.html.
- [2] M. Pitkänen (2006), *Quantum Physics as Infinite-Dimensional Geometry*.
http://tgd.wippiespace.com/public_html/tgdgeom/tgdgeom.html.
- [3] M. Pitkänen (2006), *Physics in Many-Sheeted Space-Time*.
http://tgd.wippiespace.com/public_html/tgdclass/tgdclass.html.
- [4] M. Pitkänen (2006), *Quantum TGD*.
http://tgd.wippiespace.com/public_html/tgdquant/tgdquant.html.
- [5] M. Pitkänen (2006), *TGD as a Generalized Number Theory*.
http://tgd.wippiespace.com/public_html/tgdnumber/tgdnumber.html.
- [6] M. Pitkänen (2006), *p-Adic length Scale Hypothesis and Dark Matter Hierarchy*.
http://tgd.wippiespace.com/public_html/paddark/paddark.html.
- [7] M. Pitkänen (2006), *TGD and Fringe Physics*.
http://tgd.wippiespace.com/public_html/freenergy/freenergy.html.

Online books about TGD inspired theory of consciousness and quantum biology

- [8] M. Pitkänen (2006), *Bio-Systems as Self-Organizing Quantum Systems*.
http://tgd.wippiespace.com/public_html/bioselforg/bioselforg.html.
- [9] M. Pitkänen (2006), *Quantum Hardware of Living Matter*.
http://tgd.wippiespace.com/public_html/bioware/bioware.html.
- [10] M. Pitkänen (2006), *TGD Inspired Theory of Consciousness*.
http://tgd.wippiespace.com/public_html/tgdconsc/tgdconsc.html.
- [11] M. Pitkänen (2006), *Mathematical Aspects of Consciousness Theory*.
http://tgd.wippiespace.com/public_html/genememe/genememe.html.
- [12] M. Pitkänen (2006), *TGD and EEG*.
http://tgd.wippiespace.com/public_html/tgdeeg/tgdeeg/tgdeeg.html.
- [13] M. Pitkänen (2006), *Bio-Systems as Conscious Holograms*.
http://tgd.wippiespace.com/public_html/hologram/hologram.html.
- [14] M. Pitkänen (2006), *Magnetospheric Consciousness*.
http://tgd.wippiespace.com/public_html/magnconsc/magnconsc.html.
- [15] M. Pitkänen (2006), *Mathematical Aspects of Consciousness Theory*.
http://tgd.wippiespace.com/public_html/magnconsc/mathconsc.html.

References to the chapters of books

- [A9] The chapter *Does TGD Predict the Spectrum of Planck Constants?* of [TGDview].
http://tgd.wippiespace.com/public_html/tgdview/tgdview.html#Planck.
- [D1] The chapter *Basic Extremals of Kähler Action* of [TGDclass].
http://tgd.wippiespace.com/public_html/tgdclass/tgdclass.html#class.
- [D4] The chapter *Cosmic Strings* of [TGDclass].
http://tgd.wippiespace.com/public_html/tgdclass/tgdclass.html#cstrings.
- [D6] The chapter *TGD and Astrophysics* of [TGDclass].
http://tgd.wippiespace.com/public_html/tgdclass/tgdclass.html#astro.
- [F8] The chapter *TGD and Nuclear Physics* of [TGDpad].
http://tgd.wippiespace.com/public_html/paddark/paddark.html#padnucl.
- [F9] The chapter *Dark Nuclear Physics and Living Matter* of [TGDpad].
http://tgd.wippiespace.com/public_html/paddark/paddark.html#exonuclear.
- [G2] The chapter *The Notion of Free Energy and Many-Sheeted Space-Time Concept* of [TGDfree].
http://tgd.wippiespace.com/public_html/freenergy/freenergy.html#freenergy.
- [I5] The chapter *Quantum Control and Coordination in Bio-Systems: Part II* of [TGDselforg].
http://tgd.wippiespace.com/public_html/bioselforg/bioselforg.html#qcococII.
- [J5] The chapter *Wormhole Magnetic Fields* of [TGDware].
http://tgd.wippiespace.com/public_html/bioware/bioware.html#wormc.
- [J6] The chapter *Coherent Dark Matter and Bio-Systems as Macroscopic Quantum Systems* of [TGDware].
http://tgd.wippiespace.com/public_html/bioware/bioware.html#darkbio.
- [K1] The chapter *Time, Spacetime and Consciousness* of [TGDholo].
http://tgd.wippiespace.com/public_html/hologram/hologram.html#time.
- [K2] The chapter *Macro-Temporal Quantum Coherence and Spin Glass Degeneracy* of [TGDholo].
http://tgd.wippiespace.com/public_html/hologram/hologram.html#macro.
- [K3] The chapter *General Theory of Qualia* of [TGDholo].
http://tgd.wippiespace.com/public_html/hologram/hologram.html#qualia.
- [K4] The chapter *Bio-Systems as Conscious Holograms* of [TGDholo].
http://tgd.wippiespace.com/public_html/hologram/hologram.html#hologram.
- [K5] The chapter *Homeopathy in Many-Sheeted Space-Time* of [TGDholo].
http://tgd.wippiespace.com/public_html/hologram/hologram.html#homeoc.
- [K6] The chapter *Macroscopic Quantum Coherence and Quantum Metabolism as Different Sides of the Same Coin* of [TGDholo].
http://tgd.wippiespace.com/public_html/hologram/hologram.html#metab.
- [L1] The chapter *Genes and Memes* of [TGDgame].
http://tgd.wippiespace.com/public_html/genememe/genememe.html#genememec.
- [L2] The chapter *Many-Sheeted DNA* of [TGDgame].
http://tgd.wippiespace.com/public_html/genememe/genememe.html#genecodec.
- [L4] The chapter *Pre-Biotic Evolution in Many-Sheeted Space-Time* of [TGDgame].
http://tgd.wippiespace.com/public_html/genememe/genememe.html#prebio.
- [M2] The chapter *Quantum Model for Nerve Pulse* of [TGDeeg].
http://tgd.wippiespace.com/public_html/tgdeeg/tgdeeg/tgdeeg.html#pulse.

- [M3] The chapter *Dark Matter Hierarchy and Hierarchy of EEGs* of [TGDeeg].
http://tgd.wippiespace.com/public_html/tgdeeg/tgdeeg/tgdeeg.html#eegdark. The
 chapter *Dark Matter Hierarchy and Hierarchy of EEGs* of [TGDeeg].
http://tgd.wippiespace.com/public_html/tgdeeg/tgdeeg/tgdeeg.html#eegdark.
- [M4] The chapter *Quantum Model for EEG: Part I* of [TGDeeg].
http://tgd.wippiespace.com/public_html/tgdeeg/tgdeeg/tgdeeg.html#eegI.
- [M6] The chapter *Quantum Model for Hearing* of [TGDeeg].
http://tgd.wippiespace.com/public_html/tgdeeg/tgdeeg/tgdeeg.html#hearing.
- [N2] The chapter *Crop Circles and Life at Parallel Space-Time Sheets* of [TGDmagn].
http://tgd.wippiespace.com/public_html/magnconsc/magnconsc.html#crop1.
- [N3] The chapter *Crop Circles and Life at Parallel Space-Time Sheets* of [TGDmagn].
http://tgd.wippiespace.com/public_html/magnconsc/magnconsc.html#crop2.

Physics related references

- [16] D. M. Pepper (1982), *Nonlinear Optical Phase Conjugation*, in *Optical Engineering*, vol. 21, no. 2, March/April.
<http://www.usc.edu/dept/ee/People/Faculty/feinberg.html>.
- [17] V. V. Shkunov and B. Ya. Zeldowich (1985), *Optical Phase Conjugation*, Scientific American, December issue.

Life science related references

- [18] B. Libet(1982), E. W. Wright , C. A. Gleason (1982), *Readiness potentials preceding unrestricted spontaneous and preplanned voluntary acts*, *Electroencephalography and Clinical Psychology* 54, 322-325.
 B. Libet, E. W. Wright Jr., B. Feinstein, and D. K. Pearl (1979), *Subjective referral of the timing for a conscious sensory experience* *Brain*, 102, 193-224.
 S. Klein (2002), *Libet's Research on Timing of Conscious Intention to Act: A Commentary of Stanley Klein*, *Consciousness and Cognition* 11, 273-279.
http://cornea.berkeley.edu/pubs/ccog_2002_0580-Klein-Commentary.pdf.
- [19] C. King (2003), *Biocosmology*,
<http://www.dhushara.com/book/biocos/biocos.pdf>.
- [20] L. Margulis and M. F. Dolan (2002)), *Early Life*, Jones and Bartlett Publ. MA.
- [21] R. E. Cremesti and P. Baterman (1998), *Problems with the search for the origin of life*.
http://cremesti.com/portfolio/technical_writing/Academic_Research_Papers/Problems_With_The_Search_For_The_Origin_of_Life.htm.
- [22] G. T. Javor (1987), *Origin of life: a look at late 20th century thinking*. *Origins* 14:7-20.
<http://origins.swau.edu/papers/life/javor1/default.html>.
- [23] R. L. Folk (1997), *Nanno-bacteria; surely not figments but what under heaven are they?*,
naturalSCIENCE, vol. 1, article 3. <http://naturalSCIENCE.com>.
 L. R. Folk and V. A. Pedone (1996), *Formation of aragonite cement by nanno-bacteria in the Great Salt Lake, Utah*. *Geology* 24:763765.
 R.L Folk and F. L. Lynch (1998), *Morphology of nanno-bacterial cells in the Allende carbonaceous chondrite*, in Hoover, R. B., ed., *Instruments, methods, and missions for astrobiology: Proceedings of the Society of Photo-optical Instrumentation Engineers*, v. 3441, p. 112-122.

- [24] E. O. Kajander *et al* (1994), *Comparison of Staphylococci and Novel Bacteria-Like Particles from Blood*, Zbl. Bakt. Suppl. 26, 1994.
 E. O. Kajander and N. Ciftcioglu, 1998, *Nanobacteria: An alternative mechanism for pathogenic intra- and extracellular calcification and stone formation*. Proceedings of the National Academy of Sciences, USA, v. 95, p 8274-8279.
 E. O. Kajander *et al* (1997), *Nanobacteria from blood, the smallest culturable autonomously replicating agent on earth*. In Hoover, R. B., ed., Instruments, methods, and missions for the investigation of extraterrestrial micro-organisms: Proceedings of Society of Photo-optical Instrumentation Engineers, v. 3111, p. 420-428.
- [25] E. Lozneanu and M. Sanduloviciu (2003) *Minimal-cell system created in laboratory by self-organization*, Chaos, Solitons & Fractals, Volume 18, Issue 2, October, p. 335.
 See also *Plasma blobs hint at new form of life*, New Scientist vol. 179, issue 2413 - 20 September 2003, page 16.
- [26] International Human Sequencing Consortium (2001), *Initial sequencing and analysis of the human genome*, Nature, vol 409, Feb 15. <http://www.nature.com>.
- [27] Celera Genomics (2001), Science, vol 291, issue 5507, Feb 16. <http://www.sciencemag.org/>.
- [28] R. D. Kortschak, G. Samuel, R. Saint and D. J. Miller (2003), *EST Analysis of the Cnidarian Acropora millepora Reveals Extensive Gene Loss and Rapid Sequence Divergence in the Model Invertebrates*, Current Biology, Vol 13, 2190-2195, 16 December 2003. <http://www.current-biology.com/content/article/fulltext?uid=PIIS0960982203008728>.
- [29] S. J. Gould (1989), *Wonderful Life: the Burgess Shal and the Nature of History*, Penguin Books.

Remote mental interactions, etc...

- [30] M. Pitkänen (2003), *Macro-temporal quantum coherence, quantum spin glass degeneracy, and number theoretic information concept and Bio-systems as conscious holograms*, Journal of nonlocality and remote mental interactions, issue 2.
<http://www.emergentmind.org/journal.htm>.
- [31] M. Pitkänen (2003), *Time, Space-Time, and Consciousness, Quantum Model for Sensory Receptor, and Quantum Model for Nerve Pulse, EEG, and ZEG*. Journal of nonlocality and remote mental interactions, issue 3.
<http://www.emergentmind.org/journal.htm>.
- [32] J. McMoneagle (2000), *Remote Viewing Secrets*, Hampton Roads Publishing Company, Inc..
- [33] D. J. Benor (2001), *Spiritual Healing: scientific validation of a healing revolution*, Vol. I. Vision publications, Southfield MI.
- [34] M. Germiné (2002), *Scientific Validation of Planetary Consciousness*, Journal of Non-Localities and Remote Mental Interactions Vol.I Nr. 3.
<http://www.emergentmind.org/germineI3.htm>.
- [35] L. Day (with G. DelaWarr)(1956), *New Worlds Beyond the Atom*. Vincent Stuart Publishers Ltd., London.
- [36] Yu. V. Dzang Kangeng, Patent N1828665. *A method of changing biological objects hereditary signs and a device for biological information directed transfer*. Application N3434801, invention priority as of 30.12.1981, registered 13.10.1992.
- [37] M. Persinger (1999), *The tectonic strain theory as an explanation for UFO phenomena*
<http://www.laurentian.ca/www/neurosci/tectonicedit.htm>.
 M. Persinger (1987) *Neuropsychological Bases of God Beliefs*, Praeger Publishers.
 M. A. Persinger and S. Krippner (1989), *Dream ESP experiments and geomagnetic activity*, The Journal of the American Society for Psychical Research, Vol. 83.

- [38] W. A. Tiller (2003), *Towards a Quantitative Science and Technology that Includes Human Consciousness*, Vision-in-Action, Vol.1, No 4. <http://www.via-visioninaction.org>.
- [39] W. A. Tiller and W. E. Dibble Jr. (2001), *New experimental data revealing an unexpected dimension to materials science and engineering*, Mat. Res. Innovat. 5: 21-34.
- [40] W. A. Tiller and W. E. Dibble Jr.(2002), *Anomalous Temperature Oscillation Behavior Near a Source in a "Conditioned" Space: part I, The Spatial Variation*, <http://tillerfoundation.com/newpapers.htm>.
- [41] W. A. Tiller, W. E. Dibble Jr., and M. J. Kohane(2001), *Conscious Acts of Creation: the Emergence of a New Physics*, p.17. Pavior Publishing. <http://www.pavior.com/>.

References related to physics anomalies

- [42] N. A. Kozyrev (1958) "Prichinnaya ili nesimmetrichnaya mekhanika v lineinom priblizhenii.", Pulkovo, GAO AN SSSR, 90 p. (russian) ("Causal or asymmetrical mechanics in linear approximation.").
N. A. Kozyrev (1991) "Izbrannyye trudy.", Leningrad State University, 448 p. (russian) ("Selected works.")
Lavrentiev M. M., Yeganova I.A., Medvedev V.G., Oleinik V.K., Fominykh S.F. "O skanirovanii zvyezozdnogo neba datchikom Kozyreva."
Doklady Akademii Nauk SSSR, 1992, v.323, # 4. (russian) ("On the scanning of the star sky with Kozyrev's detector.").
- [43] L. A. Frank, W. R. Paterson, K. L. Ackerson, S. Kokubun, and T. Yamamoto (1996), *Plasma velocity distributions in the near-Earth plasma sheet: A first look with the Geotail spacecraft*, J. Geophys. Res., 101, pp. 10,627-10,637. <http://www-pi.physics.uiowa.edu/www/cpi/cpi-nuggets.html> .
- [44] P. P. Gariaev *et al*(2002), *The spectroscopy of bio-photons in non-local genetic regulation*, Journal of Non-Locality and Remote Mental Interactions, Vol 1, Nr 3. <http://www.emergentmind.org/gariaevI3.htm>.
- [45] J. A. Eddy and A. A. Boornazian (1979), *Secular decrease in the solar diameter*, 18631953. Bulletin of the American Astronomical Society, 11:437.
- [46] R. L. Gilliland (1981). *Solar radius variations over the past 265 years*. The Astrophysical Journal, 248:11441155.
- [47] R. Malhotra, M. Holman, and T. Ito (2001), *Chaos and stability of the solar system*. Proc. Natl. Acad. Sci. USA. 2001 October 23; 98 (22): 1234212343. <http://www.pubmedcentral.nih.gov/articlerender.fcgi?artid=60054> .
- [48] G. Hawkins (1998), Mathematics Teacher, the magazine of the National Council of Teachers of Mathematics, vol. 91, Number 5, the issue for May,p. 441. <http://www.lovely.clara.net/hawkins.html> .
- [49] V. V. Roshchin, and S. M. Godin, *An Experimental Investigation of the Physical Effects in a Dynamic Magnetic System*, New Energy Technologies Issue #1 July-August 2001.
- [50] D. Da Roacha and L. Nottale (2003), *Gravitational Structure Formation in Scale Relativity*, astro-ph/0310036.

Crop circles, etc...

- [51] <http://www.cropcircleresearch.com/articles/arecibo.html>.
- [52] <http://claudescommentary.com/special/chilbolton/>.
- [53] P. Vigay's homepage about Crop Circle Research.
<http://www.cropcircleresearch.com/articles/alienface.html> . .
- [54] The homepage of Martin Keitel,
<http://www.ioon.net/martian/>.

5.6 Figures and illustrations

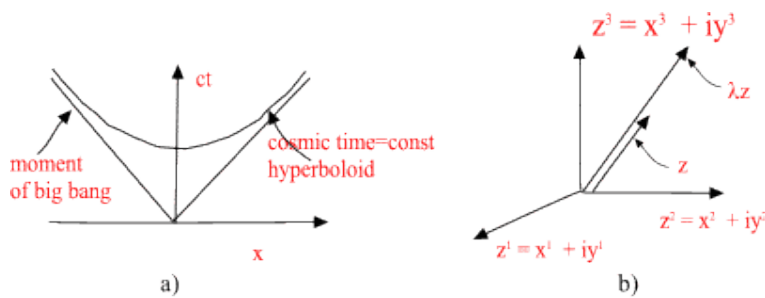

Figure 5.1: Space-times can be regarded as 4-dimensional surfaces in 8-dimensional space $H = M_+^4 \times CP_2$ obtained by replacing points of future light cone of Minkowski space with CP_2 .

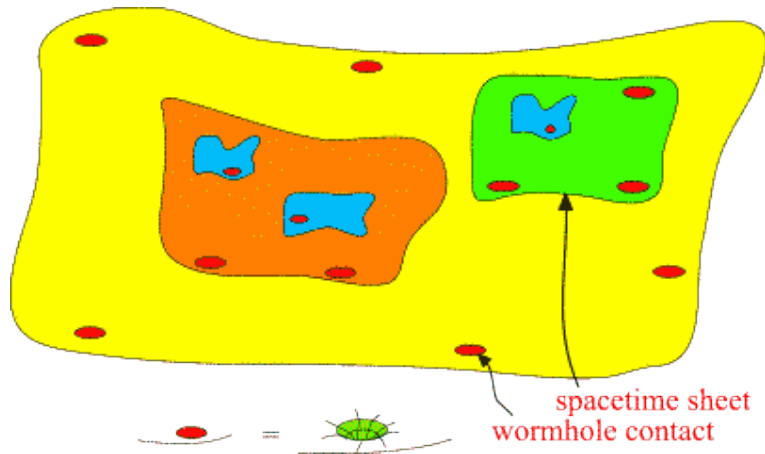

Figure 5.2: Material objects correspond to the sheets of the many-sheeted space-time. Note that sheets are extremely near to each other.

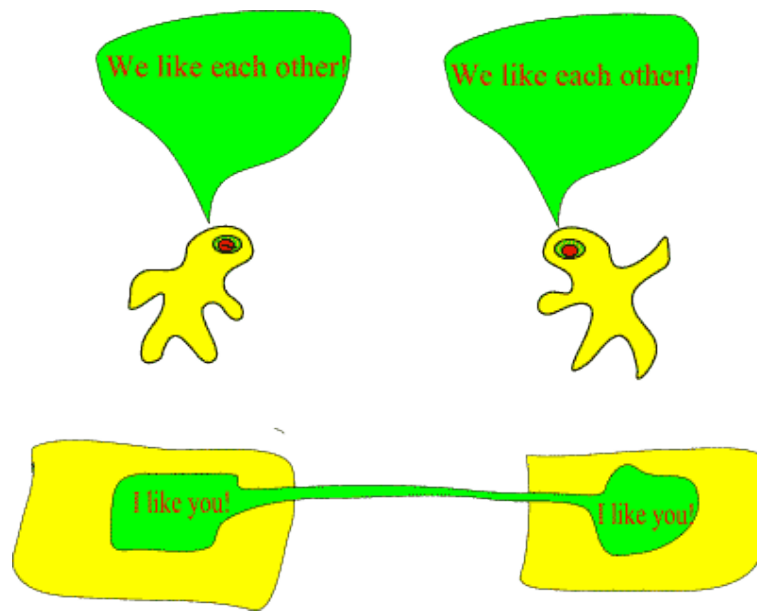

Figure 5.3: The space-time sheets condensed on larger space-time sheets having no join along boundaries bonds can be connected by join along boundaries bonds. This forces to generalize the notion of sub-system and makes possible sharing of mental images.

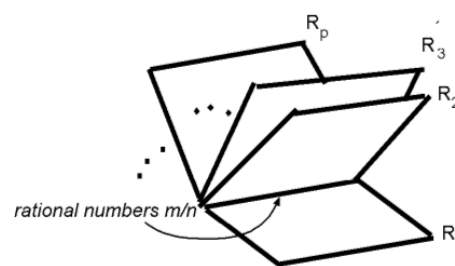

Figure 5.4: Generalization of the number concept: real and p-adic number fields correspond to the pages of book and the rim of book corresponds to rational numbers common to all of them.

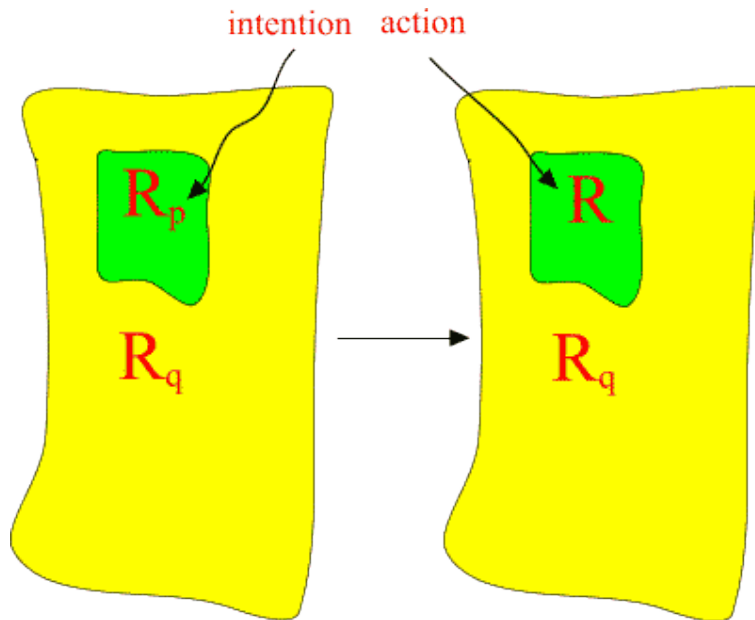

Figure 5.5: The transformation of p-adic space-time sheet to a real one in quantum jump correspond to the transformation of intention to action.

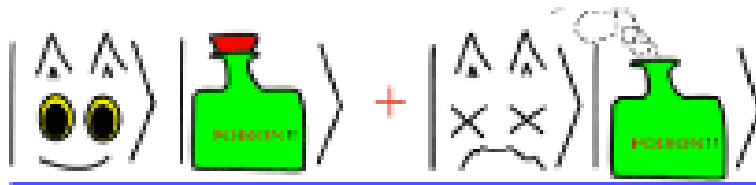

Figure 5.6: Quantum entangled systems lose their identify. Schrödinger cat entangled with the poison bottle is neither living nor dead or is both simultaneously.

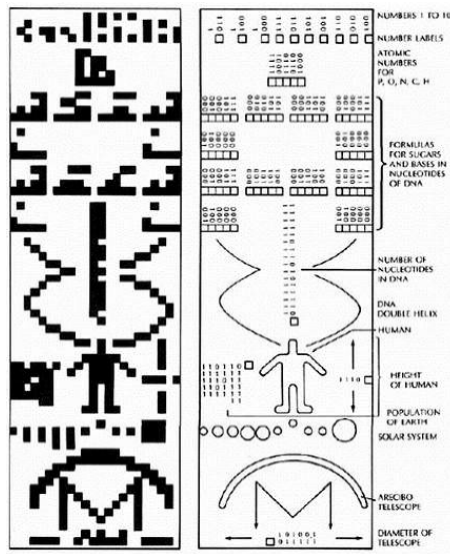

Figure 5.7: Arecibo message provides information about us.

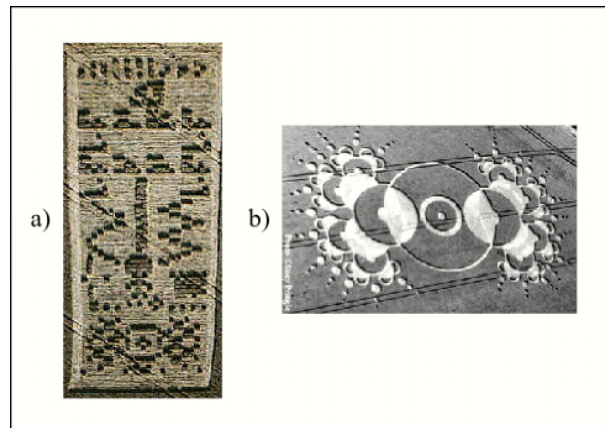

Figure 5.8: Chilbolton crop formation of figure a) is made using the same format as Arecibo message and can be interpreted as providing information about the constructors of the formation. Figure b) is the counterpart of radio antenna used to generate the message. A possible interpretation is as magnetosphere which suggests that the conscious entity responsible for the generation of crop circles is entity magnetosphere, brain of Mother Gaia.

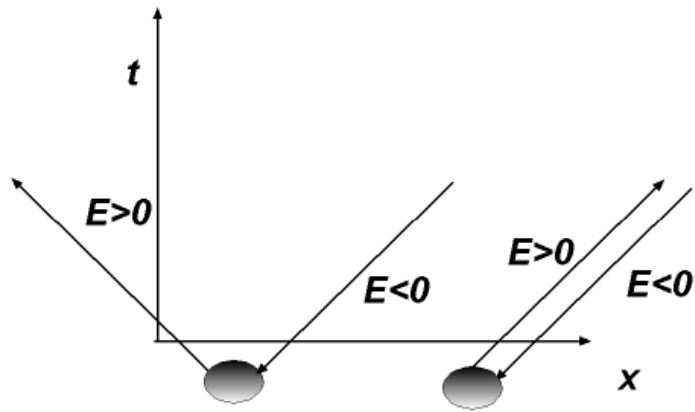

Figure 5.9: Time mirror mechanism

Appendix A

Appendix

A-1 Basic properties of CP_2

A-1.1 CP_2 as a manifold

CP_2 , the complex projective space of two complex dimensions, is obtained by identifying the points of complex 3-space C^3 under the projective equivalence

$$(z^1, z^2, z^3) \equiv \lambda(z^1, z^2, z^3) . \quad (\text{A-1.1})$$

Here λ is any non-zero complex number. Note that CP_2 can also be regarded as the coset space $SU(3)/U(2)$. The pair z^i/z^j for fixed j and $z^i \neq 0$ defines a complex coordinate chart for CP_2 . As j runs from 1 to 3 one obtains an atlas of three charts covering CP_2 , the charts being holomorphically related to each other (e.g. CP_2 is a complex manifold). The points $z^3 \neq 0$ form a subset of CP_2 homeomorphic to R^4 and the points with $z^3 = 0$ a set homeomorphic to S^2 . Therefore CP_2 is obtained by "adding the 2-sphere at infinity to R^4 ".

Besides the standard complex coordinates $\xi^i = z^i/z^3$, $i = 1, 2$ the coordinates of Eguchi and Freund [2] will be used and their relation to the complex coordinates is given by

$$\begin{aligned} \xi^1 &= z + it , \\ \xi^2 &= x + iy . \end{aligned} \quad (\text{A-1.2})$$

These are related to the "spherical coordinates" via the equations

$$\begin{aligned} \xi^1 &= r \exp\left(i \frac{(\Psi + \Phi)}{2}\right) \cos\left(\frac{\Theta}{2}\right) , \\ \xi^2 &= r \exp\left(i \frac{(\Psi - \Phi)}{2}\right) \sin\left(\frac{\Theta}{2}\right) . \end{aligned} \quad (\text{A-1.3})$$

The ranges of the variables r, Θ, Φ, Ψ are $[0, \infty], [0, \pi], [0, 4\pi], [0, 2\pi]$ respectively.

Considered as a real four-manifold CP_2 is compact and simply connected, with Euler number 3, Pontryagin number 3 and second Betti number $b = 1$.

A-1.2 Metric and Kähler structures of CP_2

In order to obtain a natural metric for CP_2 , observe that CP_2 can be thought of as a set of the orbits of the isometries $z^i \rightarrow \exp(i\alpha)z^i$ on the sphere S^5 : $\sum z^i \bar{z}^i = R^2$. The metric of CP_2 is obtained by projecting the metric of S^5 orthogonally to the orbits of the isometries. Therefore the distance between the points of CP_2 is that between the representative orbits on S^5 . The line element has the following form in the complex coordinates

$$ds^2 = g_{a\bar{b}} d\xi^a d\bar{\xi}^b , \quad (\text{A-1.4})$$

where the Hermitian, in fact Kähler, metric $g_{a\bar{b}}$ is defined by

$$g_{a\bar{b}} = R^2 \partial_a \partial_{\bar{b}} K , \quad (\text{A-1.5})$$

where the function K , Kähler function, is defined as

$$\begin{aligned} K &= \log(F) , \\ F &= 1 + r^2 . \end{aligned} \quad (\text{A-1.6})$$

The representation of the metric is given by

$$\frac{ds^2}{R^2} = \frac{(dr^2 + r^2 \sigma_3^2)}{F^2} + \frac{r^2(\sigma_1^2 + \sigma_2^2)}{F} , \quad (\text{A-1.7})$$

where the quantities σ_i are defined as

$$\begin{aligned} r^2 \sigma_1 &= \text{Im}(\xi^1 d\xi^2 - \xi^2 d\xi^1) , \\ r^2 \sigma_2 &= -\text{Re}(\xi^1 d\xi^2 - \xi^2 d\xi^1) , \\ r^2 \sigma_3 &= -\text{Im}(\xi^1 d\bar{\xi}^1 + \xi^2 d\bar{\xi}^2) . \end{aligned} \quad (\text{A-1.8})$$

The vierbein forms, which satisfy the defining relation

$$s_{kl} = R^2 \sum_A e_k^A e_l^A , \quad (\text{A-1.9})$$

are given by

$$\begin{aligned} e^0 &= \frac{dr}{F} , & e^1 &= \frac{r\sigma_1}{\sqrt{F}} , \\ e^2 &= \frac{r\sigma_2}{\sqrt{F}} , & e^3 &= \frac{r\sigma_3}{F} . \end{aligned} \quad (\text{A-1.10})$$

The explicit representations of vierbein vectors are given by

$$\begin{aligned} e^0 &= \frac{dr}{F} , & e^1 &= \frac{r(\sin\Theta \cos\Psi d\Phi + \sin\Psi d\Theta)}{2\sqrt{F}} , \\ e^2 &= \frac{r(\sin\Theta \sin\Psi d\Phi - \cos\Psi d\Theta)}{2\sqrt{F}} , & e^3 &= \frac{r(d\Psi + \cos\Theta d\Phi)}{2F} . \end{aligned} \quad (\text{A-1.11})$$

The explicit representation of the line element is given by the expression

$$ds^2/R^2 = dr^2/F^2 + (r^2/4F^2)(d\Psi + \cos\Theta d\Phi)^2 + (r^2/4F)(d\Theta^2 + \sin^2\Theta d\Phi^2) . \quad (\text{A-1.12})$$

The vierbein connection satisfying the defining relation

$$de^A = -V_B^A \wedge e^B , \quad (\text{A-1.13})$$

is given by

$$\begin{aligned}
V_{01} &= -\frac{e^1}{r} , & V_{23} &= \frac{e^1}{r} , \\
V_{02} &= -\frac{e^2}{r} , & V_{31} &= \frac{e^2}{r} , \\
V_{03} &= (r - \frac{1}{r})e^3 , & V_{12} &= (2r + \frac{1}{r})e^3 .
\end{aligned} \tag{A-1.14}$$

The representation of the covariantly constant curvature tensor is given by

$$\begin{aligned}
R_{01} &= e^0 \wedge e^1 - e^2 \wedge e^3 , & R_{23} &= e^0 \wedge e^1 - e^2 \wedge e^3 , \\
R_{02} &= e^0 \wedge e^2 - e^3 \wedge e^1 , & R_{31} &= -e^0 \wedge e^2 + e^3 \wedge e^1 , \\
R_{03} &= 4e^0 \wedge e^3 + 2e^1 \wedge e^2 , & R_{12} &= 2e^0 \wedge e^3 + 4e^1 \wedge e^2 .
\end{aligned} \tag{A-1.15}$$

Metric defines a real, covariantly constant, and therefore closed 2-form J

$$J = -ig_{a\bar{b}}d\xi^a d\bar{\xi}^b , \tag{A-1.16}$$

the so called Kähler form. Kähler form J defines in CP_2 a symplectic structure because it satisfies the condition

$$J^k_r J^{rl} = -s^{kl} . \tag{A-1.17}$$

The form J is integer valued and by its covariant constancy satisfies free Maxwell equations. Hence it can be regarded as a curvature form of a $U(1)$ gauge potential B carrying a magnetic charge of unit $1/2g$ (g denotes the gauge coupling). Locally one has therefore

$$J = dB , \tag{A-1.18}$$

where B is the so called Kähler potential, which is not defined globally since J describes magnetic monopole.

It should be noticed that the magnetic flux of J through a 2-surface in CP_2 is proportional to its homology equivalence class, which is integer valued. The explicit representations of J and B are given by

$$\begin{aligned}
B &= 2re^3 , \\
J &= 2(e^0 \wedge e^3 + e^1 \wedge e^2) = \frac{r}{F^2} dr \wedge (d\Psi + \cos\Theta d\Phi) + \frac{r^2}{2F} \sin\Theta d\Theta d\Phi .
\end{aligned} \tag{A-1.19}$$

The vielbein curvature form and Kähler form are covariantly constant and have in the complex coordinates only components of type (1,1).

Useful coordinates for CP_2 are the so called canonical coordinates in which Kähler potential and Kähler form have very simple expressions

$$\begin{aligned}
B &= \sum_{k=1,2} P_k dQ_k , \\
J &= \sum_{k=1,2} dP_k \wedge dQ_k .
\end{aligned} \tag{A-1.20}$$

The relationship of the canonical coordinates to the "spherical" coordinates is given by the equations

$$\begin{aligned}
P_1 &= -\frac{1}{1+r^2} , \\
P_2 &= \frac{r^2 \cos\Theta}{2(1+r^2)} , \\
Q_1 &= \Psi , \\
Q_2 &= \Phi .
\end{aligned} \tag{A-1.21}$$

A-1.3 Spinors in CP_2

CP_2 doesn't allow spinor structure in the conventional sense [5]. However, the coupling of the spinors to a half odd multiple of the Kähler potential leads to a respectable spinor structure. Because the delicacies associated with the spinor structure of CP_2 play a fundamental role in TGD, the arguments of Hawking are repeated here.

To see how the space can fail to have an ordinary spinor structure consider the parallel transport of the vierbein in a simply connected space M . The parallel propagation around a closed curve with a base point x leads to a rotated vierbein at x : $e^A = R_B^A e^B$ and one can associate to each closed path an element of $SO(4)$.

Consider now a one-parameter family of closed curves $\gamma(v) : v \in (0, 1)$ with the same base point x and $\gamma(0)$ and $\gamma(1)$ trivial paths. Clearly these paths define a sphere S^2 in M and the element $R_B^A(v)$ defines a closed path in $SO(4)$. When the sphere S^2 is contractible to a point e.g., homologically trivial, the path in $SO(4)$ is also contractible to a point and therefore represents a trivial element of the homotopy group $\Pi_1(SO(4)) = Z_2$.

For a homologically nontrivial 2-surface S^2 the associated path in $SO(4)$ can be homotopically nontrivial and therefore corresponds to a nonclosed path in the covering group $Spin(4)$ (leading from the matrix 1 to -1 in the matrix representation). Assume this is the case.

Assume now that the space allows spinor structure. Then one can parallelly propagate also spinors and by the above construction associate a closed path of $Spin(4)$ to the surface S^2 . Now, however this path corresponds to a lift of the corresponding $SO(4)$ path and cannot be closed. Thus one ends up with a contradiction.

From the preceding argument it is clear that one could compensate the nonallowed -1 - factor associated with the parallel transport of the spinor around the sphere S^2 by coupling it to a gauge potential in such a way that in the parallel transport the gauge potential introduces a compensating -1 -factor. For a $U(1)$ gauge potential this factor is given by the exponential $exp(i2\Phi)$, where Φ is the magnetic flux through the surface. This factor has the value -1 provided the $U(1)$ potential carries half odd multiple of Dirac charge $1/2g$. In case of CP_2 the required gauge potential is half odd multiple of the Kähler potential B defined previously. In the case of $M^4 \times CP_2$ one can in addition couple the spinor components with different chiralities independently to an odd multiple of $B/2$.

A-1.4 Geodesic submanifolds of CP_2

Geodesic submanifolds are defined as submanifolds having common geodesic lines with the imbedding space. As a consequence the second fundamental form of the geodesic manifold vanishes, which means that the tangent vectors h_α^k (understood as vectors of H) are covariantly constant quantities with respect to the covariant derivative taking into account that the tangent vectors are vectors both with respect to H and X^4 .

In [3] a general characterization of the geodesic submanifolds for an arbitrary symmetric space G/H is given. Geodesic submanifolds are in 1-1-correspondence with the so called Lie triple systems of the Lie-algebra g of the group G . The Lie triple system t is defined as a subspace of g characterized by the closedness property with respect to double commutation

$$[X, [Y, Z]] \in t \text{ for } X, Y, Z \in t . \quad (\text{A-1.22})$$

$SU(3)$ allows, besides geodesic lines, two nonequivalent (not isometry related) geodesic spheres. This is understood by observing that $SU(3)$ allows two nonequivalent $SU(2)$ algebras corresponding to subgroups $SO(3)$ (orthogonal 3×3 matrices) and the usual isospin group $SU(2)$. By taking any subset of two generators from these algebras, one obtains a Lie triple system and by exponentiating this system, one obtains a 2-dimensional geodesic submanifold of CP_2 .

Standard representatives for the geodesic spheres of CP_2 are given by the equations

$$S_I^2 : \xi^1 = \xi^2 \text{ or equivalently } (\Theta = \pi/2, \Psi = 0) ,$$

$$S_{II}^2 : \xi^1 = \xi^2 \text{ or equivalently } (\Theta = \pi/2, \Phi = 0) .$$

The non-equivalence of these sub-manifolds is clear from the fact that isometries act as holomorphic transformations in CP_2 . The vanishing of the second fundamental form is also easy to verify. The first geodesic manifold is homologically trivial: in fact, the induced Kähler form vanishes identically for S_I^2 . S_{II}^2 is homologically nontrivial and the flux of the Kähler form gives its homology equivalence class.

A-2 Identification of the electro-weak couplings

The delicacies of the spinor structure of CP_2 make it a unique candidate for space S . First, the coupling of the spinors to the $U(1)$ gauge potential defined by the Kähler structure provides the missing $U(1)$ factor in the gauge group. Secondly, it is possible to couple different H -chiralities independently to a half odd multiple of the Kähler potential. Thus the hopes of obtaining a correct spectrum for the electromagnetic charge are considerable. In the following it will be demonstrated that the couplings of the induced spinor connection are indeed those of the GWS model [4] and in particular that the right handed neutrinos decouple completely from the electro-weak interactions.

To begin with, recall that the space H allows to define three different chiralities for spinors. Spinors with fixed H -chirality $e = \pm 1$, CP_2 -chirality l, r and M^4 -chirality L, R are defined by the condition

$$\begin{aligned}\Gamma\Psi &= e\Psi, \\ e &= \pm 1,\end{aligned}\tag{A-2.1}$$

where Γ denotes the matrix $\Gamma_9 = \gamma_5 \times \gamma_5$, $1 \times \gamma_5$ and $\gamma_5 \times 1$ respectively. Clearly, for a fixed H -chirality CP_2 - and M^4 -chiralities are correlated.

The spinors with H -chirality $e = \pm 1$ can be identified as quark and lepton like spinors respectively. The separate conservation of baryon and lepton numbers can be understood as a consequence of generalized chiral invariance if this identification is accepted. For the spinors with a definite H -chirality one can identify the vielbein group of CP_2 as the electro-weak group: $SO(4) = SU(2)_L \times SU(2)_R$.

The covariant derivatives are defined by the spinorial connection

$$A = V + \frac{B}{2}(n_+ 1_+ + n_- 1_-) .\tag{A-2.2}$$

Here V and B denote the projections of the vielbein and Kähler gauge potentials respectively and $1_{+(-)}$ projects to the spinor H -chirality $+(-)$. The integers n_{\pm} are odd from the requirement of a respectable spinor structure.

The explicit representation of the vielbein connection V and of B are given by the equations

$$\begin{aligned}V_{01} &= -\frac{e^1}{r_2}, & V_{23} &= \frac{e^1}{r_2}, \\ V_{02} &= -\frac{e^2}{r}, & V_{31} &= \frac{e^2}{r}, \\ V_{03} &= (r - \frac{1}{r})e^3, & V_{12} &= (2r + \frac{1}{r})e^3,\end{aligned}\tag{A-2.3}$$

and

$$B = 2re^3 ,\tag{A-2.4}$$

respectively. The explicit representation of the vielbein is not needed here.

Let us first show that the charged part of the spinor connection couples purely left handedly. Identifying Σ_3^0 and Σ_2^1 as the diagonal (neutral) Lie-algebra generators of $SO(4)$, one finds that the charged part of the spinor connection is given by

$$A_{ch} = 2V_{23}I_L^1 + 2V_{13}I_L^2 ,\tag{A-2.5}$$

where one have defined

$$\begin{aligned} I_L^1 &= \frac{(\Sigma_{01} - \Sigma_{23})}{2} , \\ I_L^2 &= \frac{(\Sigma_{02} - \Sigma_{13})}{2} . \end{aligned} \quad (\text{A-2.6})$$

A_{ch} is clearly left handed so that one can perform the identification

$$W^\pm = \frac{2(e^1 \pm ie^2)}{r} , \quad (\text{A-2.7})$$

where W^\pm denotes the charged intermediate vector boson.

Consider next the identification of the neutral gauge bosons γ and Z^0 as appropriate linear combinations of the two functionally independent quantities

$$\begin{aligned} X &= re^3 , \\ Y &= \frac{e^3}{r} , \end{aligned} \quad (\text{A-2.8})$$

appearing in the neutral part of the spinor connection. We show first that the mere requirement that photon couples vectorially implies the basic coupling structure of the GWS model leaving only the value of Weinberg angle undetermined.

To begin with let us define

$$\begin{aligned} \bar{\gamma} &= aX + bY , \\ \bar{Z}^0 &= cX + dY , \end{aligned} \quad (\text{A-2.9})$$

where the normalization condition

$$ad - bc = 1 ,$$

is satisfied. The physical fields γ and Z^0 are related to $\bar{\gamma}$ and \bar{Z}^0 by simple normalization factors.

Expressing the neutral part of the spinor connection in term of these fields one obtains

$$\begin{aligned} A_{nc} &= [(c+d)2\Sigma_{03} + (2d-c)2\Sigma_{12} + d(n_+1_+ + n_-1_-)]\bar{\gamma} \\ &+ [(a-b)2\Sigma_{03} + (a-2b)2\Sigma_{12} - b(n_+1_+ + n_-1_-)]\bar{Z}^0 . \end{aligned} \quad (\text{A-2.10})$$

Identifying Σ_{12} and $\Sigma_{03} = 1 \times \gamma_5 \Sigma_{12}$ as vectorial and axial Lie-algebra generators, respectively, the requirement that γ couples vectorially leads to the condition

$$c = -d . \quad (\text{A-2.11})$$

Using this result plus previous equations, one obtains for the neutral part of the connection the expression

$$A_{nc} = \gamma Q_{em} + Z^0 (I_L^3 - \sin^2 \theta_W Q_{em}) . \quad (\text{A-2.12})$$

Here the electromagnetic charge Q_{em} and the weak isospin are defined by

$$\begin{aligned} Q_{em} &= \Sigma^{12} + \frac{(n_+1_+ + n_-1_-)}{6} , \\ I_L^3 &= \frac{(\Sigma^{12} - \Sigma^{03})}{2} . \end{aligned} \quad (\text{A-2.13})$$

The fields γ and Z^0 are defined via the relations

$$\begin{aligned}\gamma &= 6d\bar{\gamma} = \frac{6}{(a+b)}(aX + bY) , \\ Z^0 &= 4(a+b)\bar{Z}^0 = 4(X - Y) .\end{aligned}\tag{A-2.14}$$

The value of the Weinberg angle is given by

$$\sin^2\theta_W = \frac{3b}{2(a+b)} ,\tag{A-2.15}$$

and is not fixed completely. Observe that right handed neutrinos decouple completely from the electro-weak interactions.

The determination of the value of Weinberg angle is a dynamical problem. The angle is completely fixed once the YM action is fixed by requiring that action contains no cross term of type γZ^0 . Pure symmetry non-broken electro-weak YM action leads to a definite value for the Weinberg angle. One can however add a symmetry breaking term proportional to Kähler action and this changes the value of the Weinberg angle.

To evaluate the value of the Weinberg angle one can express the neutral part F_{nc} of the induced gauge field as

$$F_{nc} = 2R_{03}\Sigma^{03} + 2R_{12}\Sigma^{12} + J(n_{+1+} + n_{-1-}) ,\tag{A-2.16}$$

where one has

$$\begin{aligned}R_{03} &= 2(2e^0 \wedge e^3 + e^1 \wedge e^2) , \\ R_{12} &= 2(e^0 \wedge e^3 + 2e^1 \wedge e^2) , \\ J &= 2(e^0 \wedge e^3 + e^1 \wedge e^2) ,\end{aligned}\tag{A-2.17}$$

in terms of the fields γ and Z^0 (photon and Z - boson)

$$F_{nc} = \gamma Q_{em} + Z^0(I_L^3 - \sin^2\theta_W Q_{em}) .\tag{A-2.18}$$

Evaluating the expressions above one obtains for γ and Z^0 the expressions

$$\begin{aligned}\gamma &= 3J - \sin^2\theta_W R_{03} , \\ Z^0 &= 2R_{03} .\end{aligned}\tag{A-2.19}$$

For the Kähler field one obtains

$$J = \frac{1}{3}(\gamma + \sin^2\theta_W Z^0) .\tag{A-2.20}$$

Expressing the neutral part of the symmetry broken YM action

$$\begin{aligned}L_{ew} &= L_{sym} + f J^{\alpha\beta} J_{\alpha\beta} , \\ L_{sym} &= \frac{1}{4g^2} Tr(F^{\alpha\beta} F_{\alpha\beta}) ,\end{aligned}\tag{A-2.21}$$

where the trace is taken in spinor representation, in terms of γ and Z^0 one obtains for the coefficient X of the γZ^0 cross term (this coefficient must vanish) the expression

$$\begin{aligned}
X &= -\frac{K}{2g^2} + \frac{fp}{18} , \\
K &= \text{Tr} [Q_{em}(I_L^3 - \sin^2\theta_W Q_{em})] ,
\end{aligned} \tag{A-2.22}$$

In the general case the value of the coefficient K is given by

$$K = \sum_i \left[-\frac{(18 + 2n_i^2)\sin^2\theta_W}{9} \right] , \tag{A-2.23}$$

where the sum is over the spinor chiralities, which appear as elementary fermions and n_i is the integer describing the coupling of the spinor field to the the Kähler potential. The cross term vanishes provided the value of the Weinberg angle is given by

$$\sin^2\theta_W = \frac{9\sum_i 1}{(fg^2 + 2\sum_i(18 + n_i^2))} . \tag{A-2.24}$$

In the scenario where both leptons and quarks are elementary fermions the value of the Weinberg angle is given by

$$\sin^2\theta_W = \frac{9}{(\frac{fg^2}{2} + 28)} . \tag{A-2.25}$$

The bare value of the Weinberg angle is $9/28$ in this scenario, which is quite close to the typical value $9/24$ of GUTs [6].

A-2.1 Discrete symmetries

The treatment of discrete symmetries C, P, and T is based on the following requirements:

- a) Symmetries must be realized as purely geometric transformations.
- b) Transformation properties of the field variables should be essentially the same as in the conventional quantum field theories [1].

The action of the reflection P on spinors of is given by

$$\Psi \rightarrow P\Psi = \gamma^0 \otimes \gamma^0 \Psi . \tag{A-2.26}$$

in the representation of the gamma matrices for which γ^0 is diagonal. It should be noticed that W and Z^0 bosons break parity symmetry as they should since their charge matrices do not commute with the matrix of P .

The guess that a complex conjugation in CP_2 is associated with T transformation of the physicist turns out to be correct. One can verify by a direct calculation that pure Dirac action is invariant under T realized according to

$$\begin{aligned}
m^k &\rightarrow T(M^k) , \\
\xi^k &\rightarrow \bar{\xi}^k , \\
\Psi &\rightarrow \gamma^1 \gamma^3 \otimes 1 \Psi .
\end{aligned} \tag{A-2.27}$$

The operation bearing closest resemblance to the ordinary charge conjugation corresponds geometrically to complex conjugation in CP_2 :

$$\begin{aligned}
\xi^k &\rightarrow \bar{\xi}^k , \\
\Psi &\rightarrow \Psi^\dagger \gamma^2 \gamma^0 \otimes 1 .
\end{aligned} \tag{A-2.28}$$

As one might have expected symmetries CP and T are exact symmetries of the pure Dirac action.

A-3 Space-time surfaces with vanishing em, Z^0 , Kähler, or W fields

In the sequel it is shown that space-times for which either em, Z^0 , or Kähler field vanishes decompose into regions characterized by six vacuum parameters: two of these quantum numbers (ω_1 and ω_2) are frequency type parameters, two (k_1 and k_2) are wave vector like quantum numbers, two of the quantum numbers (n_1 and n_2) are integers. The parameters ω_i and n_i will be referred as electric and magnetic quantum numbers. The existence of these quantum numbers is not a feature of these solutions alone but represents a much more general phenomenon differentiating in a clear cut manner between TGD and Maxwell's electrodynamics.

The simplest manner to avoid surface Kähler charges and discontinuities or infinities in the derivatives of CP_2 coordinates on the common boundary of two neighboring regions with different vacuum quantum numbers is topological field quantization, 3-space decomposes into disjoint topological field quanta, 3-surfaces having outer boundaries with possibly macroscopic size.

If one requires that space-time surface is an extremal of Kähler action and has a 2-dimensional CP_2 projection, only vacuum extremals and space-time surfaces for which CP_2 projection is a geodesic sphere, are allowed. Homologically non-trivial geodesic sphere correspond to vanishing W fields and homologically non-trivial sphere to non-vanishing W fields but vanishing γ and Z^0 . For vacuum extremals all electro-weak gauge fields are in general non-vanishing although the net gauge field has $U(1)$ holonomy.

A-3.1 Em neutral space-times

Em and Z^0 neutral spacetimes are especially interesting space-times as far as applications of TGD are considered. Consider first the electromagnetically neutral space-times. Using spherical coordinates (r, Θ, Ψ, Φ) for CP_2 , the expression of Kähler form reads as

$$\begin{aligned} J &= \frac{r}{F^2} dr \wedge (d\Psi + \cos(\Theta)d\Phi) + \frac{r^2}{2F} \sin(\Theta)d\Theta \wedge d\Phi , \\ F &= 1 + r^2 . \end{aligned} \quad (\text{A-3.1})$$

The general expression of electromagnetic field reads as

$$\begin{aligned} F_{em} &= (3 + 2p) \frac{r}{F^2} dr \wedge (d\Psi + \cos(\Theta)d\Phi) + (3 + p) \frac{r^2}{2F} \sin(\Theta)d\Theta \wedge d\Phi , \\ p &= \sin^2(\Theta_W) , \end{aligned} \quad (\text{A-3.2})$$

where Θ_W denotes Weinberg angle.

The vanishing of the electromagnetic fields is guaranteed, when the conditions

$$\begin{aligned} \Psi &= k\Phi , \\ (3 + 2p) \frac{1}{r^2 F} (d(r^2)/d\Theta)(k + \cos(\Theta)) + (3 + p) \sin(\Theta) &= 0 , \end{aligned} \quad (\text{A-3.3})$$

hold true. The conditions imply that CP_2 projection of the electromagnetically neutral space-time is 2-dimensional. Solving the differential equation one obtains

$$\begin{aligned} r &= \sqrt{\frac{X}{1-X}} , \\ X &= D \left[\left| \frac{k+u}{C} \right| \right]^\epsilon , \\ u &\equiv \cos(\Theta) , \quad C = k + \cos(\Theta_0) , \quad D = \frac{r_0^2}{1+r_0^2} , \quad \epsilon = \frac{3+p}{3+2p} , \end{aligned} \quad (\text{A-3.4})$$

where C and D are integration constants. $0 \leq X \leq 1$ is required by the reality of r . $r = 0$ would correspond to $X = 0$ giving $u = -k$ achieved only for $|k| \leq 1$ and $r = \infty$ to $X = 1$ giving $|u + k| = [(1 + r_0^2)/r_0^2]^{(3+2p)/(3+p)}$ achieved only for

$$\text{sign}(u + k) \times \left[\frac{1 + r_0^2}{r_0^2} \right]^{\frac{3+2p}{3+p}} \leq k + 1 ,$$

where $\text{sign}(x)$ denotes the sign of x .

Under rather general conditions the coordinates Ψ and Φ can be written in the form

$$\begin{aligned} \Psi &= \omega_2 m^0 + k_2 m^3 + n_2 \phi + \text{Fourier expansion} , \\ \Phi &= \omega_1 m^0 + k_1 m^3 + n_1 \phi + \text{Fourier expansion} . \end{aligned} \quad (\text{A-3.5})$$

m^0, m^3 and ϕ denote the coordinate variables of the cylindrical M^4 coordinates) so that one has $k = \omega_2/\omega_1 = n_2/n_1 = k_2/k_1$. The regions of the space-time surface with given values of the vacuum parameters ω_i, k_i and n_i and m and C are bounded by the surfaces at which the electromagnetically neutral imbeddings become ill-defined, say by $r > 0$ or $r < \infty$ surfaces.

The space-time surface decomposes into regions characterized by different values of the vacuum parameters r_0 and Θ_0 . At $r = \infty$ surfaces n_2, ω_2 and m can change since all values of Ψ correspond to the same point of CP_2 : at $r = 0$ surfaces also n_1 and ω_1 can change since all values of Φ correspond to same point of CP_2 , too. If $r = 0$ or $r = \infty$ is not in the allowed range space-time surface develops a boundary.

This implies what might be called topological quantization since in general it is not possible to find a smooth global imbedding for, say a constant magnetic field. Although global imbedding exists it decomposes into regions with different values of the vacuum parameters and the coordinate u in general possesses discontinuous derivative at $r = 0$ and $r = \infty$ surfaces. A possible manner to avoid edges of space-time is to allow field quantization so that 3-space (and field) decomposes into disjoint quanta, which can be regarded as structurally stable units a 3-space (and of the gauge field). This doesn't exclude partial join along boundaries for neighboring field quanta provided some additional conditions guaranteeing the absence of edges are satisfied.

The vanishing of the electromagnetic fields implies that the condition

$$\Omega \equiv \frac{\omega_2}{n_2} - \frac{\omega_1}{n_1} = 0 , \quad (\text{A-3.6})$$

is satisfied. In particular, the ratio ω_2/ω_1 is rational number for the electromagnetically neutral regions of space-time surface. The change of the parameter n_1 and n_2 (ω_1 and ω_2) in general generates magnetic field and therefore these integers will be referred to as magnetic (electric) quantum numbers.

The expression for the Kähler form and Z^0 field of the electromagnetically neutral space-time surface will be needed in sequel and is given by

$$\begin{aligned} J &= -\frac{p}{3+2p} X du \wedge d\Phi , \\ Z^0 &= -\frac{6}{p} J . \end{aligned} \quad (\text{A-3.7})$$

The components of the electromagnetic field generated by varying vacuum parameters are proportional to the components of the Kähler field: in particular, the magnetic field is parallel to the Kähler magnetic field. The generation of a long range Z^0 vacuum field is a purely TGD based feature not encountered in the standard gauge theories.

The effective form of the CP_2 metric is given by

$$\begin{aligned} ds_{eff}^2 &= (s_{rr} \left(\frac{dr}{d\Theta} \right)^2 + s_{\Theta\Theta}) d\Theta^2 + (s_{\Phi\Phi} + 2ks_{\Phi\Psi}) d\Phi^2 = \frac{R^2}{4} [s_{\Theta\Theta}^{eff} d\Theta^2 + s_{\Phi\Phi}^{eff} d\Phi^2] , \\ s_{\Theta\Theta}^{eff} &= X \times \left[\frac{\epsilon^2(1-u^2)}{(k+u)^2} \times \frac{1}{1-X} + 1 - X \right] , \\ s_{\Phi\Phi}^{eff} &= X \times [(1-X)(k+u)^2 + 1 - u^2] , \end{aligned} \quad (\text{A-3.8})$$

and is useful in the construction of electromagnetically neutral imbedding of, say Schwartzchild metric. Note however that in general these imbeddings are not extremals of Kähler action.

A-3.2 Space-times with vanishing Z^0 or Kähler fields

The results just derived generalize to the Z^0 neutral case as such. The only modification is the replacement of the parameter ϵ with $\epsilon = 1/2$ as becomes clear by considering the condition stating that Z^0 field vanishes identically. Also the relationship $F_{em} = 3J = -\frac{3}{4}\frac{r^2}{F}du \wedge d\Phi$ is useful.

Also the generalization to the case of vacuum extremals is straightforward and corresponds to $\epsilon = 1, p = 0$ in the formula for em neutral space-times. In this case classical em and Z^0 fields are proportional to each other:

$$\begin{aligned} Z^0 &= 2e^0 \wedge e^3 = \frac{r}{F^2}(k+u)\frac{\partial r}{\partial u}du \wedge d\Phi = (k+u)du \wedge d\Phi, \\ r &= \sqrt{\frac{X}{1-X}}, \quad X = D|k+u|, \\ \gamma &= -\frac{p}{2}Z^0. \end{aligned} \tag{A-3.9}$$

For vanishing value of Weinberg angle ($p = 0$) em field vanishes and only Z^0 field remains as a long range gauge field. Vacuum extremals for which long range Z^0 field vanishes but em field is non-vanishing are not possible.

A-3.3 Induced gauge fields for space-times for which CP_2 projection is a geodesic sphere

For space-time sheets for which CP_2 projection is $r = \infty$ homologically non-trivial geodesic sphere of CP_2 one has

$$\gamma = \left(\frac{3}{4} - \frac{\sin^2(\theta_W)}{2}\right)Z^0 \simeq \frac{5Z^0}{8}.$$

The induced W fields vanish in this case and they vanish also for all geodesic sphere obtained by $SU(3)$ rotation.

For homologically trivial geodesic sphere a standard representative is obtained by using for the phase angles of standard complex CP_2 coordinates constant values. In this case induced em, Z^0 , and Kähler fields vanish but induced W fields are non-vanishing. This holds also for surfaces obtained by color rotation. Hence one can say that for non-vacuum extremals with 2-D CP_2 projection color rotations and weak symmetries commute.

A-4 Second variation of the Kähler action

The Kähler action is apart from a multiplicative constant defined by the Lagrangian density

$$L = J^{\alpha\beta}J_{\alpha\beta}\sqrt{g}, \tag{A-4.1}$$

and depends on the imbedding space coordinates only through the induced metric and Kähler form. In order to calculate the second variation of the Kähler action one can use "covariantization" trick made possible by the covariant constancy of the imbedding space metric and Kähler form. Calculate second variation by treating components of the metric and Kähler form as a constant so that the action depends effectively only on the derivatives of the imbedding space coordinates and replace ordinary derivatives of the deformation with the covariant derivatives in the resulting expression for the second variation.

$$\begin{aligned} \partial_\alpha \delta h^k &\rightarrow D_\alpha \delta h^k \\ &= \partial_\alpha \delta h^k + \{l^k_m\} \partial_\alpha h^m \delta h^l. \end{aligned} \tag{A-4.2}$$

The first variation of the Maxwell term is given by the expression

$$\delta_1 L = 2[T^{\alpha\beta}\delta_1 g_{\alpha\beta} + J^{\alpha\beta}\delta_1 J_{\alpha\beta}]\sqrt{g} , \quad (\text{A-4.3})$$

where the canonical energy momentum tensor $T^{\alpha\beta}$ is given by

$$T^{\alpha\beta} = J^{\alpha\nu} J_{\nu}^{\beta} - (1/4)g^{\alpha\beta} J^{\mu\nu} J_{\mu\nu} . \quad (\text{A-4.4})$$

and is traceless by Weyl invariance.

Second variation is obtained by differentiating first variation and decomposes into three terms

$$\delta_2 L = \delta_2^a L + \delta_2^b L + \delta_2^c L . \quad (\text{A-4.5})$$

The first term is given by the expression

$$\begin{aligned} \delta_2^a L &= [T^{\alpha\beta}\delta_2 g_{\alpha\beta} + J^{\alpha\beta}\delta_2 J_{\alpha\beta} \\ &+ (T^{\alpha\beta}\delta_1 g_{\alpha\beta} + J^{\alpha\beta}\delta_1 J_{\alpha\beta})g^{\mu\nu}\delta_1 g_{\mu\nu}]\sqrt{g} . \end{aligned} \quad (\text{A-4.6})$$

The second term is given by

$$\begin{aligned} \delta_2^b L &= [(\partial T^{\alpha\beta}/\partial g_{\mu\nu})\delta_1 g_{\alpha\beta}\delta_1 g_{\mu\nu} \\ &+ 2(\partial T^{\alpha\beta}/\partial J_{\mu\nu})\delta_1 g_{\alpha\beta}\delta_1 J_{\mu\nu}]\sqrt{g} . \end{aligned} \quad (\text{A-4.7})$$

The partial derivatives of the energy momentum tensor appearing in the expression are given by

$$\begin{aligned} \partial T^{\alpha\beta}/\partial g_{\mu\nu} &= -g^{\alpha\mu}T^{\beta\nu} + K^{\alpha\nu}g^{\beta\mu} - \frac{1}{2}K^{\mu\nu}g^{\alpha\beta} + J^{\alpha\nu}J^{\beta\mu} , \\ K^{\alpha\beta} &= J^{\alpha\nu}J_{\nu}^{\beta} . \end{aligned} \quad (\text{A-4.8})$$

$$\partial T^{\alpha\beta}/\partial J_{\mu\nu} = 2[g^{\alpha\mu}J^{\beta\nu} - g^{\alpha\beta}J^{\mu\nu}/4] . \quad (\text{A-4.9})$$

The third term is given by the expression

$$\begin{aligned} \delta_2^c L &= [(\partial J^{\alpha\beta}/\partial J_{\mu\nu})\delta_1 J_{\alpha\beta}\delta_1 J_{\mu\nu}]\sqrt{g} , \\ \partial J^{\alpha\beta}/\partial J_{\mu\nu} &= g^{\alpha\mu}g^{\beta\nu} . \end{aligned} \quad (\text{A-4.10})$$

Expressing the first term in terms of the coordinate variations one obtains

$$\delta_2^a L = 2[T^{\alpha\beta}h_{kl}^{\perp} + J^{\alpha\beta}J_{kl}^{\perp}]D_{\alpha}\delta_1 h^k D_{\beta}\delta_1 h^l \sqrt{g} , \quad (\text{A-4.11})$$

where h_{kl}^{\perp} and J_{kl}^{\perp} are the projections of the imbedding space metric and Kähler form to the orthogonal complement of the tangent space of X^4

$$\begin{aligned} h_{kl}^{\perp} &= h_{kl} - g^{\mu\nu}h_{kr}h_{ls}\partial_{\mu}h^r\partial_{\nu}h^s , \\ J_{kl}^{\perp} &= h_{kr}^{\perp}h_{ls}^{\perp}J^{rs} , \end{aligned} \quad (\text{A-4.12})$$

so that $\delta_2^a L$ vanishes for four-dimensional *Diff* deformations parallel to X^4 . This term vanishes also, when the induced Kähler form vanishes.

The contribution of the second term to the second variation is given by the expression

$$\begin{aligned} \delta_2^b L &= 4[(-g^{\alpha\mu} T^{\beta\nu} + K^{\alpha\nu} g^{\beta\mu} - \frac{1}{2} K^{\mu\nu} g^{\alpha\beta} + J^{\alpha\nu} J^{\beta\mu}) h_{kr} h_{ls} \\ &+ 2(g^{\alpha\mu} J^{\beta\nu} - g^{\alpha\beta} J^{\mu\nu} / 4) h_{ks} J_{lr}] \partial_\alpha h^k \partial_\beta h^l D_\mu \delta_1 h^r D_\nu \delta_1 h^s \sqrt{g} . \end{aligned} \quad (\text{A-4.13})$$

Also this term is non-vanishing only provided the induced Kähler field is nontrivial.

The third term is given by the expression

$$\delta_2^c L = [g^{\alpha\mu} g^{\beta\nu} J_{kr} J_{ls}] \partial_\alpha h^k \partial_\beta h^l D_\mu \delta_1 h^r D_\nu \delta_1 h^s \sqrt{g} . \quad (\text{A-4.14})$$

This term is the only term, which is nontrivial for the vacuum extremals with vanishing Kähler field and also in this case the variation is nontrivial for CP_2 coordinates only.

The second variation for the Kähler Lagrangian can be written in the following general form

$$\delta^2 L_{intX^4} = I_{kl}^{\alpha\beta} D_\alpha \delta h^k D_\beta \delta h^l , \quad (\text{A-4.15})$$

where the general expressions for the tensor $I_{kl}^{\alpha\beta}$ reads as

$$I_{kl}^{\alpha\beta} = \partial_{\partial_\alpha h^k} \partial_{\partial_\beta h^l} L . \quad (\text{A-4.16})$$

The explicit expression for the tensors $I_{kl}^{\alpha\beta}$ can be read from the expressions for δL_2^i , $i = a, b, c$ and $\delta_2 L_{CS}$ respectively.

The general form of the variational equations satisfied by the second variation in the interior of X^4 reads as

$$D_\alpha (I_{kl}^{\alpha\beta} D_\beta \delta h^l) = 0 . \quad (\text{A-4.17})$$

On the boundary the variational equations read

$$I_{kl}^{n\beta} D_\beta \delta h^l = 0 . \quad (\text{A-4.18})$$

These equations are satisfied on a dynamically generated boundary only. These equations are not satisfied on the intersection of the four-surface with the surfaces $a = \sqrt{(m^0)^2 - r_M^2} \rightarrow \infty$ and $a = 0$ (light cone boundary).

The expression for the second variation of the action reduces to a mere boundary term resulting from the intersections of the four-surface with $a \rightarrow \infty$ and $a = 0$ surfaces, when X^4 corresponds to a submanifold of light cone and reads

$$\delta^2 S = \int_{a=0}^{a=\infty} I_{kl}^{n\beta} \delta h^k D_\beta \delta h^l d^3 x . \quad (\text{A-4.19})$$

The general expressions for the tensor I suggests that only non-vanishing contribution to the second variation comes from the boundary of the light cone.

A-5 p-Adic numbers

p-Adic numbers (p is prime: 2,3,5,...) can be regarded as a completion of the rational numbers using a norm, which is different from the ordinary norm of real numbers [8]. p-Adic numbers are representable as power expansion of the prime number p of form:

$$x = \sum_{k \geq k_0} x(k)p^k, \quad x(k) = 0, \dots, p-1 . \quad (\text{A-5.1})$$

The norm of a p-adic number is given by

$$|x| = p^{-k_0(x)} . \quad (\text{A-5.2})$$

Here $k_0(x)$ is the lowest power in the expansion of the p-adic number. The norm differs drastically from the norm of the ordinary real numbers since it depends on the lowest pinary digit of the p-adic number only. Arbitrarily high powers in the expansion are possible since the norm of the p-adic number is finite also for numbers, which are infinite with respect to the ordinary norm. A convenient representation for p-adic numbers is in the form

$$x = p^{k_0} \varepsilon(x) , \quad (\text{A-5.3})$$

where $\varepsilon(x) = k + \dots$ with $0 < k < p$, is p-adic number with unit norm and analogous to the phase factor $\exp(i\phi)$ of a complex number.

The distance function $d(x, y) = |x - y|_p$ defined by the p-adic norm possesses a very general property called ultra-metricity:

$$d(x, z) \leq \max\{d(x, y), d(y, z)\} . \quad (\text{A-5.4})$$

The properties of the distance function make it possible to decompose R_p into a union of disjoint sets using the criterion that x and y belong to same class if the distance between x and y satisfies the condition

$$d(x, y) \leq D . \quad (\text{A-5.5})$$

This division of the metric space into classes has following properties:

- a) Distances between the members of two different classes X and Y do not depend on the choice of points x and y inside classes. One can therefore speak about distance function between classes.
- b) Distances of points x and y inside single class are smaller than distances between different classes.
- c) Classes form a hierarchical tree.

Notice that the concept of the ultra-metricity emerged in physics from the models for spin glasses and is believed to have also applications in biology [10]. The emergence of p-adic topology as the topology of the effective space-time would make ultra-metricity property basic feature of physics.

A-6 Canonical correspondence between p-adic and real numbers

There exists a natural continuous map $Id : R_p \rightarrow R_+$ from p-adic numbers to non-negative real numbers given by the "pinary" expansion of the real number for $x \in R$ and $y \in R_p$ this correspondence reads

$$\begin{aligned}
 y &= \sum_{k>N} y_k p^k \rightarrow x = \sum_{k<N} y_k p^{-k} , \\
 y_k &\in \{0, 1, \dots, p-1\} .
 \end{aligned}
 \tag{A-6.1}$$

This map is continuous as one easily finds out. There is however a little difficulty associated with the definition of the inverse map since the pinary expansion like also decimal expansion is not unique ($1 = 0.999\dots$) for the real numbers x , which allow pinary expansion with finite number of pinary digits

$$\begin{aligned}
 x &= \sum_{k=N_0}^N x_k p^{-k} , \\
 x &= \sum_{k=N_0}^{N-1} x_k p^{-k} + (x_N - 1)p^{-N} + (p-1)p^{-N-1} \sum_{k=0,\dots} p^{-k} .
 \end{aligned}
 \tag{A-6.2}$$

The p-adic images associated with these expansions are different

$$\begin{aligned}
 y_1 &= \sum_{k=N_0}^N x_k p^k , \\
 y_2 &= \sum_{k=N_0}^{N-1} x_k p^k + (x_N - 1)p^N + (p-1)p^{N+1} \sum_{k=0,\dots} p^k \\
 &= y_1 + (x_N - 1)p^N - p^{N+1} ,
 \end{aligned}
 \tag{A-6.3}$$

so that the inverse map is either two-valued for p-adic numbers having expansion with finite pinary digits or single valued and discontinuous and non-surjective if one makes pinary expansion unique by choosing the one with finite pinary digits. The finite pinary digit expansion is a natural choice since in the numerical work one always must use a pinary cutoff on the real axis.

What about the p-adic counterpart of the negative real numbers? It seems that in the applications this correspondence is not needed since canonical identification is used only in the direction $R_p \rightarrow R$ to map the predictions of p-adic probability calculus and statistics to real numbers (in particular, p-adic entanglement entropy must be mapped to its real counterpart). This means that also the inverse of the canonical identification is not needed in the applications. At tge space time level the p-adics and reals relate via common rationals. p-Adic effective topology is expected to be a good approximation only within some length scale range which means infrared and UV cutoffs.

The topology induced by the canonical identification t map in the set of positive real numbers differs from the ordinary topology. The difference is easily understood by interpreting the p-adic norm as a norm in the set of the real numbers. The norm is constant in each interval $[p^k, p^{k+1})$ (see Fig. A-6) and is equal to the usual real norm at the points $x = p^k$: the usual linear norm is replaced with a piecewise constant norm. This means that p-adic topology is coarser than the usual real topology and the higher the value of p is, the coarser the resulting topology is above a given length scale. This hierarchical ordering of the p-adic topologies will be a central feature as far as the proposed applications of the p-adic numbers are considered.

Ordinary continuity implies p-adic continuity since the norm induced from the p-adic topology is rougher than the ordinary norm. p-Adic continuity implies ordinary continuity from right as is clear already from the properties of the p-adic norm (the graph of the norm is indeed continuous from right). This feature is one clear signature of the p-adic topology.

The linear structure of the p-adic numbers induces a corresponding structure in the set of the non-negative real numbers and p-adic linearity in general differs from the ordinary concept of linearity. For example, p-adic sum is equal to real sum only provided the summands have no common pinary digits. Furthermore, the condition $x +_p y < \max\{x, y\}$ holds in general for the p-adic sum of the

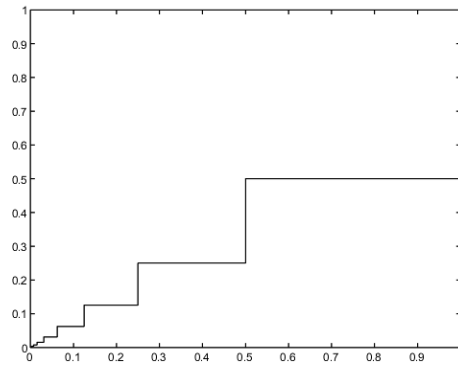

Figure A.1: The real norm induced by canonical identification from 2-adic norm.

real numbers. p-Adic multiplication is equivalent with the ordinary multiplication only provided that either of the members of the product is power of p . Moreover one has $x \times_p y < x \times y$ in general. The p-Adic negative -1_p associated with p-adic unit 1 is given by $(-1)_p = \sum_k (p-1)p^k$ and defines p-adic negative for each real number x . An interesting possibility is that p-adic linearity might replace the ordinary linearity in some strongly nonlinear systems so these systems would look simple in the p-adic topology.

Canonical identification is in a key role in the successful predictions of the elementary particle masses. Canonical identification makes also possible to understand the connection between p-adic and real probabilities. These suggests that canonical identification is involved with some deeper mathematical structure. The following inequalities hold true:

$$\begin{aligned} (x + y)_R &\leq x_R + y_R \ , \\ |x|_p |y|_R \leq (xy)_R &\leq x_R y_R \ , \end{aligned} \tag{A-6.4}$$

where $|x|_p$ denotes p-adic norm. These inequalities can be generalized to the case of $(R_p)^n$ (a linear vector space over the p-adic numbers).

$$\begin{aligned} (x + y)_R &\leq x_R + y_R \ , \\ |\lambda|_p |y|_R \leq (\lambda y)_R &\leq \lambda_R y_R \ , \end{aligned} \tag{A-6.5}$$

where the norm of the vector $x \in T_p^n$ is defined in some manner. The case of Euclidian space suggests the definition

$$(x_R)^2 = \left(\sum_n x_n^2 \right)_R \ . \tag{A-6.6}$$

These inequalities resemble those satisfied by the vector norm. The only difference is the failure of linearity in the sense that the norm of a scaled vector is not obtained by scaling the norm of the original vector. Ordinary situation prevails only if the scaling corresponds to a power of p .

These observations suggests that the concept of a normed space or Banach space might have a generalization and physically the generalization might apply to the description of some nonlinear systems. The nonlinearity would be concentrated in the nonlinear behavior of the norm under scaling.

Bibliography

- [TGDview] M. Pitkänen (2006), *Topological Geometro-dynamics: Overview*.
<http://www.physics.helsinki.fi/~matpitka/tgdview/tgdview.html>.
- [TGDgeom] M. Pitkänen (2006), *Quantum Physics as Infinite-Dimensional Geometry*.
<http://www.physics.helsinki.fi/~matpitka/tgdgeom/tgdgeom.html>.
- [TGDquant] M. Pitkänen (2006), *Quantum TGD*.
<http://www.physics.helsinki.fi/~matpitka/tgdquant/tgdquant.html>.
- [TGDclass] M. Pitkänen (2006), *Physics in Many-Sheeted Space-Time*.
<http://www.physics.helsinki.fi/~matpitka/tgdclass/tgdclass.html>.
- [TGDnumber] M. Pitkänen (2006), *TGD as a Generalized Number Theory*.
<http://www.physics.helsinki.fi/~matpitka/tgdnumber/tgdnumber.html>.
- [TGDpad] M. Pitkänen (2006), *p-Adic length Scale Hypothesis and Dark Matter Hierarchy*.
<http://www.physics.helsinki.fi/~matpitka/paddark/paddark.html>.
- [TGDfree] M. Pitkänen (2006), *TGD and Fringe Physics*.
<http://www.physics.helsinki.fi/~matpitka/freenergy/freenergy.html>.
- [TGDconsc] M. Pitkänen (2006), *TGD Inspired Theory of Consciousness*.
<http://www.physics.helsinki.fi/~matpitka/tgdconsc/tgdconsc.html>.
- [TGDselforg] M. Pitkänen (2006), *Bio-Systems as Self-Organizing Quantum Systems*.
<http://www.physics.helsinki.fi/~matpitka/bioselforg/bioselforg.html>.
- [TGDware] M. Pitkänen (2006), *Quantum Hardware of Living Matter*.
<http://www.physics.helsinki.fi/~matpitka/bioware/bioware.html>.
- [TGDholo] M. Pitkänen (2006), *Bio-Systems as Conscious Holograms*.
<http://www.physics.helsinki.fi/~matpitka/hologram/hologram.html>.
- [TGDgeme] M. Pitkänen (2006), *Mathematical Aspects of Consciousness Theory*.
<http://www.physics.helsinki.fi/~matpitka/genememe/genememe.html>.
- [TGDdeeg] M. Pitkänen (2006), *TGD and EEG*.
<http://www.physics.helsinki.fi/~matpitka/tgdeeg/tgdeeg/tgdeeg.html>.
- [TGDmagn] M. Pitkänen (2006), *Magnetospheric Consciousness*.
<http://www.physics.helsinki.fi/~matpitka/magnconsc/magnconsc.html>.
- [1] Björken, J. and Drell, S. (1965): *Relativistic Quantum Fields*. Mc-Graw-Hill, New York.
- [2] Eguchi, T., Gilkey, B., Hanson, J. (1980): *Phys. Rep.* 66, 6.
- [3] Helgason, S. (1962): *Differential Geometry and Symmetric Spaces*. New York: Academic Press.
- [4] Huang, K. (1982): *Quarks, Leptons & Gauge Fields*. World Scientific.
- [5] Pope, C., N. (1980): *Eigenfunctions and Spin^c Structures on CP₂* D.A.M.T.P. preprint.

- [6] Zee, A. (1982): *The Unity of Forces in the Universe* World Science Press, Singapore.
- [7] R. B. J. T. Allenby and E. J. Redfern (1989), *Introduction to Number Theory with Computing*, Edward Arnold.
- [8] Z. I. Borevich and I. R. Shafarevich (1966) ,*Number Theory*, Academic Press.
- [9] L. Brekke and P. G. O. Freund (1993), *p-Adic Numbers in Physics*, Phys. Rep. vol. 233, No 1.
- [10] G. Parisi (1992), *Field Theory, Disorder and Simulations*, World Scientific.