

PHYSICS IN MANY-SHEETED SPACE-TIME

Matti Pitkänen

Köydenpunojankatu D 11, 10900, Hanko, Finland

Preface

This book belongs to a series of online books summarizing the recent state Topological Geometro-dynamics (TGD) and its applications. TGD can be regarded as a unified theory of fundamental interactions but is not the kind of unified theory as so called GUTs constructed by graduate students at seventies and eighties using detailed recipes for how to reduce everything to group theory. Nowadays this activity has been completely computerized and it probably takes only a few hours to print out the predictions of this kind of unified theory as an article in the desired format. TGD is something different and I am not ashamed to confess that I have devoted the last 32 years of my life to this enterprise and am still unable to write The Rules.

I got the basic idea of Topological Geometro-dynamics (TGD) during autumn 1978, perhaps it was October. What I realized was that the representability of physical space-times as 4-dimensional surfaces of some higher-dimensional space-time obtained by replacing the points of Minkowski space with some very small compact internal space could resolve the conceptual difficulties of general relativity related to the definition of the notion of energy. This belief was too optimistic and only with the advent of what I call zero energy ontology the understanding of the notion of Poincare invariance has become satisfactory.

It soon became clear that the approach leads to a generalization of the notion of space-time with particles being represented by space-time surfaces with finite size so that TGD could be also seen as a generalization of the string model. Much later it became clear that this generalization is consistent with conformal invariance only if space-time is 4-dimensional and the Minkowski space factor of imbedding space is 4-dimensional.

It took some time to discover that also the geometrization of also gauge interactions and elementary particle quantum numbers could be possible in this framework: it took two years to find the unique internal space providing this geometrization involving also the realization that family replication phenomenon for fermions has a natural topological explanation in TGD framework and that the symmetries of the standard model symmetries are much more profound than pragmatic TOE builders have believed them to be. If TGD is correct, main stream particle physics chose the wrong track leading to the recent deep crisis when people decided that quarks and leptons belong to same multiplet of the gauge group implying instability of proton.

There have been also longstanding problems.

- Gravitational energy is well-defined in cosmological models but is not conserved. Hence the conservation of the inertial energy does not seem to be consistent with the Equivalence Principle. Furthermore, the imbeddings of Robertson-Walker cosmologies turned out to be vacuum extremals with respect to the inertial energy. About 25 years was needed to realize that the sign of the inertial energy can be also negative and in cosmological scales the density of inertial energy vanishes: physically acceptable universes are creatable from vacuum. Eventually this led to the notion of zero energy ontology which deviates dramatically from the standard ontology being however consistent with the crossing symmetry of quantum field theories. In this framework the quantum numbers are assigned with zero energy states located at the boundaries of so called causal diamonds defined as intersections of future and past directed light-cones. The notion of energy-momentum becomes length scale dependent since one has a scale hierarchy for causal diamonds. This allows to understand the non-conservation of energy as apparent. Equivalence Principle generalizes and has a formulation in terms of coset representations of Super-Virasoro algebras providing also a justification for p-adic thermodynamics.
- From the beginning it was clear that the theory predicts the presence of long ranged classical electro-weak and color gauge fields and that these fields necessarily accompany classical electromagnetic fields. It took about 26 years to gain the maturity to admit the obvious: these fields are classical correlates for long range color and weak interactions assignable to dark matter. The only possible conclusion is that TGD physics is a fractal consisting of an entire hierarchy of fractal copies of standard model physics. Also the understanding of electro-weak massivation and screening of weak charges has been a long standing problem, and 32 years was needed to discover that what I call weak form of electric-magnetic duality gives a satisfactory solution of the problem and provides also surprisingly powerful insights to the mathematical structure of quantum TGD.

I started the serious attempts to construct quantum TGD after my thesis around 1982. The original optimistic hope was that path integral formalism or canonical quantization might be enough to construct the quantum theory but the first discovery made already during first year of TGD was that these formalisms might be useless due to the extreme non-linearity and enormous vacuum degeneracy of the theory. This turned out to be the case.

- It took some years to discover that the only working approach is based on the generalization of Einstein's program. Quantum physics involves the geometrization of the infinite-dimensional "world of classical worlds" (WCW) identified as 3-dimensional surfaces. Still few years had to pass before I understood that general coordinate invariance leads to a more or less unique solution of the problem and implies that space-time surfaces are analogous to Bohr orbits. Still a couple of years and I discovered that quantum states of the Universe can be identified as classical spinor fields in WCW. Only quantum jump remains the genuinely quantal aspect of quantum physics.
- During these years TGD led to a rather profound generalization of the space-time concept. Quite general properties of the theory led to the notion of many-sheeted space-time with sheets representing physical subsystems of various sizes. At the beginning of 90s I became dimly aware of the importance of p-adic number fields and soon ended up with the idea that p-adic thermodynamics for a conformally invariant system allows to understand elementary particle massivation with amazingly few input assumptions. The attempts to understand p-adicity from basic principles led gradually to the vision about physics as a generalized number theory as an approach complementary to the physics as an infinite-dimensional spinor geometry of WCW approach. One of its elements was a generalization of the number concept obtained by fusing real numbers and various p-adic numbers along common rationals. The number theoretical trinity involves besides p-adic number fields also quaternions and octonions and the notion of infinite prime.
- TGD inspired theory of consciousness entered the scheme after 1995 as I started to write a book about consciousness. Gradually it became difficult to say where physics ends and consciousness theory begins since consciousness theory could be seen as a generalization of quantum measurement theory by identifying quantum jump as a moment of consciousness and by replacing the observer with the notion of self identified as a system which is conscious as long as it can avoid entanglement with environment. "Everything is conscious and consciousness can be only lost" summarizes the basic philosophy neatly. The idea about p-adic physics as physics of cognition and intentionality emerged also rather naturally and implies perhaps the most dramatic generalization of the space-time concept in which most points of p-adic space-time sheets are infinite in real sense and the projection to the real imbedding space consists of discrete set of points. One of the most fascinating outcomes was the observation that the entropy based on p-adic norm can be negative. This observation led to the vision that life can be regarded as something in the intersection of real and p-adic worlds. Negentropic entanglement has interpretation as a correlate for various positively colored aspects of conscious experience and means also the possibility of strongly correlated states stable under state function reduction and different from the conventional bound states and perhaps playing key role in the energy metabolism of living matter.
- One of the latest threads in the evolution of ideas is only slightly more than six years old. Learning about the paper of Laurent Nottale about the possibility to identify planetary orbits as Bohr orbits with a gigantic value of gravitational Planck constant made once again possible to see the obvious. Dynamical quantized Planck constant is strongly suggested by quantum classical correspondence and the fact that space-time sheets identifiable as quantum coherence regions can have arbitrarily large sizes. During summer 2010 several new insights about the mathematical structure and interpretation of TGD emerged. One of these insights was the realization that the postulated hierarchy of Planck constants might follow from the basic structure of quantum TGD. The point is that due to the extreme non-linearity of the classical action principle the correspondence between canonical momentum densities and time derivatives of the imbedding space coordinates is one-to-many and the natural description of the situation is in terms of local singular covering spaces of the imbedding space. One could speak about effective value of Planck

constant coming as a multiple of its minimal value. The implications of the hierarchy of Planck constants are extremely far reaching so that the significance of the reduction of this hierarchy to the basic mathematical structure distinguishing between TGD and competing theories cannot be under-estimated.

From the point of view of particle physics the ultimate goal is of course a practical construction recipe for the S-matrix of the theory. I have myself regarded this dream as quite too ambitious taking into account how far reaching re-structuring and generalization of the basic mathematical structure of quantum physics is required. It has indeed turned out that the dream about explicit formula is unrealistic before one has understood what happens in quantum jump. Symmetries and general physical principles have turned out to be the proper guide line here. To give some impressions about what is required some highlights are in order.

- With the emergence of zero energy ontology the notion of S-matrix was replaced with M-matrix which can be interpreted as a complex square root of density matrix representable as a diagonal and positive square root of density matrix and unitary S-matrix so that quantum theory in zero energy ontology can be said to define a square root of thermodynamics at least formally.
- A decisive step was the strengthening of the General Coordinate Invariance to the requirement that the formulations of the theory in terms of light-like 3-surfaces identified as 3-surfaces at which the induced metric of space-time surfaces changes its signature and in terms of space-like 3-surfaces are equivalent. This means effective 2-dimensionality in the sense that partonic 2-surfaces defined as intersections of these two kinds of surfaces plus 4-D tangent space data at partonic 2-surfaces code for the physics. Quantum classical correspondence requires the coding of the quantum numbers characterizing quantum states assigned to the partonic 2-surfaces to the geometry of space-time surface. This is achieved by adding to the modified Dirac action a measurement interaction term assigned with light-like 3-surfaces.
- The replacement of strings with light-like 3-surfaces equivalent to space-like 3-surfaces means enormous generalization of the super conformal symmetries of string models. A further generalization of these symmetries to non-local Yangian symmetries generalizing the recently discovered Yangian symmetry of $\mathcal{N} = 4$ supersymmetric Yang-Mills theories is highly suggestive. Here the replacement of point like particles with partonic 2-surfaces means the replacement of conformal symmetry of Minkowski space with infinite-dimensional super-conformal algebras. Yangian symmetry provides also a further refinement to the notion of conserved quantum numbers allowing to define them for bound states using non-local energy conserved currents.
- A further attractive idea is that quantum TGD reduces to almost topological quantum field theory. This is possible if the Kähler action for the preferred extremals defining WCW Kähler function reduces to a 3-D boundary term. This takes place if the conserved currents are so called Beltrami fields with the defining property that the coordinates associated with flow lines extend to single global coordinate variable. This ansatz together with the weak form of electric-magnetic duality reduces the Kähler action to Chern-Simons term with the condition that the 3-surfaces are extremals of Chern-Simons action subject to the constraint force defined by the weak form of electric magnetic duality. It is the latter constraint which prevents the trivialization of the theory to a topological quantum field theory. Also the identification of the Kähler function of WCW as Dirac determinant finds support as well as the description of the scattering amplitudes in terms of braids with interpretation in terms of finite measurement resolution coded to the basic structure of the solutions of field equations.
- In standard QFT Feynman diagrams provide the description of scattering amplitudes. The beauty of Feynman diagrams is that they realize unitarity automatically via the so called Cutkosky rules. In contrast to Feynman's original beliefs, Feynman diagrams and virtual particles are taken only as a convenient mathematical tool in quantum field theories. QFT approach is however plagued by UV and IR divergences and one must keep mind open for the possibility that a genuine progress might mean opening of the black box of the virtual particle.

In TGD framework this generalization of Feynman diagrams indeed emerges unavoidably. Light-like 3-surfaces replace the lines of Feynman diagrams and vertices are replaced by 2-D partonic

2-surfaces. Zero energy ontology and the interpretation of parton orbits as light-like "wormhole throats" suggests that virtual particles do not differ from mass shell particles only in that the four- and three- momenta of wormhole throats fail to be parallel. The two throats of the wormhole defining virtual particle would contact carry on mass shell quantum numbers but for virtual particles the four-momenta need not be parallel and can also have opposite signs of energy. Modified Dirac equation suggests a number theoretical quantization of the masses of the virtual particles. The kinematic constraints on the virtual momenta are extremely restrictive and reduce the dimension of the sub-space of virtual momenta and if massless particles are not allowed (IR cutoff provided by zero energy ontology naturally), the number of Feynman diagrams contributing to a particular kind of scattering amplitude is finite and manifestly UV and IR finite and satisfies unitarity constraint in terms of Cutkosky rules. What is remarkable that fermionic propagators are massless propagators but for on mass shell four-momenta. This gives a connection with the twistor approach and inspires the generalization of the Yangian symmetry to infinite-dimensional super-conformal algebras.

What I have said above is strongly biased view about the recent situation in quantum TGD and I have left all about applications to the introductions of the books whose purpose is to provide a bird's eye view about TGD as it is now. This vision is single man's view and doomed to contain unrealistic elements as I know from experience. My dream is that young critical readers could take this vision seriously enough to try to demonstrate that some of its basic premises are wrong or to develop an alternative based on these or better premises. I must be however honest and tell that 32 years of TGD is a really vast bundle of thoughts and quite a challenge for anyone who is not able to cheat himself by taking the attitude of a blind believer or a light-hearted debunker trusting on the power of easy rhetoric tricks.

Matti Pitkänen

Hanko,

September 15, 2010

Acknowledgements

Neither TGD nor these books would exist without the help and encouragement of many people. The friendship with Heikki and Raija Haila and their family have kept me in contact with the everyday world and without this friendship I would not have survived through these lonely 32 years most of which I have remained unemployed as a scientific dissident. I am happy that my children have understood my difficult position and like my friends have believed that what I am doing is something valuable although I have not received any official recognition for it.

During last decade Tapio Tammi has helped me quite concretely by providing the necessary computer facilities and being one of the few persons in Finland with whom to discuss about my work. I have had also stimulating discussions with Samuli Penttinen who has also helped to get through the economical situations in which there seemed to be no hope. The continual updating of fifteen online books means quite a heavy bureaucracy at the level of bits and without a systemization one ends up with endless copying and pasting and internal consistency is soon lost. Pekka Rapinoja has offered his help in this respect and I am especially grateful for him for my Python skills. Also Matti Vallinkoski has helped me in computer related problems.

The collaboration with Lian Sidorov was extremely fruitful and she also helped me to survive economically through the hardest years. The participation to CASYS conferences in Liege has been an important window to the academic world and I am grateful for Daniel Dubois and Peter Marcer for making this participation possible. The discussions and collaboration with Eduardo de Luna and Istvan Dienes stimulated the hope that the communication of new vision might not be a mission impossible after all. Also blog discussions have been very useful. During these years I have received innumerable email contacts from people around the world. In particular, I am grateful for Mark McWilliams and Ulla Matfolk for providing links to possibly interesting web sites and articles. These contacts have helped me to avoid the depressive feeling of being some kind of Don Quixote of Science and helped me to widen my views: I am grateful for all these people.

In the situation in which the conventional scientific communication channels are strictly closed it is important to have some loop hole through which the information about the work done can at

least in principle leak to the publicity through the iron wall of the academic censorship. Without any exaggeration I can say that without the world wide web I would not have survived as a scientist nor as individual. Homepage and blog are however not enough since only the formally published result is a result in recent day science. Publishing is however impossible without a direct support from power holders- even in archives like arXiv.org.

Situation changed for five years ago as Andrew Adamatsky proposed the writing of a book about TGD when I had already got used to the thought that my work would not be published during my life time. The Prespacetime Journal and two other journals related to quantum biology and consciousness - all of them founded by Huping Hu - have provided this kind of loop holes. In particular, Dainis Zeps, Phil Gibbs, and Arkadiusz Jadczyk deserve my gratitude for their kind help in the preparation of an article series about TGD catalyzing a considerable progress in the understanding of quantum TGD. Also the viXra archive founded by Phil Gibbs and its predecessor Archive Freedom have been of great help: Victor Christianto deserves special thanks for doing the hard work needed to run Archive Freedom. Also the Neuroquantology Journal founded by Sultan Tarlaci deserves a special mention for its publication policy. And last but not least: there are people who experience as a fascinating intellectual challenge to spoil the practical working conditions of a person working with something which might be called unified theory: I am grateful for the people who have helped me to survive through the virus attacks, an activity which has taken roughly one month per year during the last half decade and given a strong hue of grey to my hair.

For a person approaching his sixty year birthday it is somewhat easier to overcome the hard feelings due to the loss of academic human rights than for an inpatient youngster. Unfortunately the economic situation has become increasingly difficult during the twenty years after the economic depression in Finland which in practice meant that Finland ceased to be a constitutional state in the strong sense of the word. It became possible to depose people like me from the society without fear about public reactions and the classification as dropout became a convenient tool of ridicule to circumvent the ethical issues. During last few years when the right wing has held the political power this trend has been steadily strengthening. In this kind of situation the concrete help from individuals has been and will be of utmost importance. Against this background it becomes obvious that this kind of work is not possible without the support from outside and I apologize for not being able to mention all the people who have helped me during these years.

Matti Pitkänen

Hanko,
September 15, 2010

Contents

1	Introduction	1
1.1	Basic Ideas of TGD	1
1.1.1	Background	1
1.1.2	TGD as a Poincare invariant theory of gravitation	2
1.1.3	TGD as a generalization of the hadronic string model	2
1.1.4	Fusion of the two approaches via a generalization of the space-time concept	2
1.2	The threads in the development of quantum TGD	3
1.2.1	Quantum TGD as spinor geometry of World of Classical Worlds	3
1.2.2	TGD as a generalized number theory	5
1.2.3	Hierarchy of Planck constants and dark matter hierarchy	8
1.2.4	TGD as a generalization of physics to a theory consciousness	10
1.3	Bird's eye of view about the topics of the book	15
1.3.1	The implications deriving from the topology of space-time surface and from the properties of induced gauge fields	15
1.3.2	Many-sheeted cosmology	16
1.3.3	Dark matter and quantization of gravitational Planck constant	17
1.3.4	The topics of the book	17
1.4	The contents of the book	18
1.4.1	PART I: The notion of many-sheeted space-time	18
1.4.2	PART II: Many-Sheeted Cosmology, and Astrophysics	26
1.4.3	PART III: Topological field quantization	35
I	THE NOTION OF MANY-SHEETED SPACE-TIME	37
2	Basic Extremals of the Kähler Action	39
2.1	Introduction	39
2.1.1	General considerations	39
2.1.2	In what sense field equations mimic dissipative dynamics?	40
2.1.3	The dimension of CP_2 projection as classifier for the fundamental phases of matter	40
2.1.4	Specific extremals of Kähler action	41
2.1.5	The weak form of electric-magnetic duality and modification of Kähler action	41
2.2	General considerations	42
2.2.1	Number theoretical compactification and $M^8 - H$ duality	42
2.2.2	The exponent of Kähler function as Dirac determinant for the modified Dirac action	44
2.2.3	Preferred extremal property as classical correlate for quantum criticality, holography, and quantum classical correspondence	45
2.2.4	Can one determine experimentally the shape of the space-time surface?	47
2.3	General view about field equations	49
2.3.1	Field equations	49
2.3.2	Topologization and light-likeness of the Kähler current as alternative manners to guarantee vanishing of Lorentz 4-force	50
2.3.3	How to satisfy field equations?	55

2.3.4	$DCP_2 = 3$ phase allows infinite number of topological charges characterizing the linking of magnetic field lines	65
2.3.5	Preferred extremal property and the topologization/light-likeness of Kähler current?	66
2.3.6	Generalized Beltrami fields and biological systems	67
2.3.7	About small perturbations of field equations	71
2.4	Vacuum extremals	74
2.4.1	CP_2 type extremals	74
2.4.2	Vacuum extremals with vanishing Kähler field	78
2.5	Non-vacuum extremals	79
2.5.1	Cosmic strings	79
2.5.2	Massless extremals	79
2.5.3	Generalization of the solution ansatz defining massless extremals (MEs)	80
2.5.4	Maxwell phase	84
2.5.5	Stationary, spherically symmetric extremals	85
2.5.6	Maxwell hydrodynamics as a toy model for TGD	92
2.6	Weak form electric-magnetic duality and its implications	95
2.6.1	Could a weak form of electric-magnetic duality hold true?	97
2.6.2	Magnetic confinement, the short range of weak forces, and color confinement	101
2.6.3	Could Quantum TGD reduce to almost topological QFT?	104
2.6.4	Kähler action for Euclidian regions as Kähler function and Kähler action for Minkowskian regions as Morse function?	106
2.6.5	A general solution ansatz based on almost topological QFT property	108
2.6.6	Hydrodynamic picture in fermionic sector	111
2.6.7	Possible role of Beltrami flows and symplectic invariance in the description of gauge and gravitational interactions	117
2.7	How to define Dirac determinant?	118
2.7.1	Dirac determinant when the number of eigenvalues is infinite	119
2.7.2	Hyper-octonionic primes	121
2.7.3	Three basic options for the pseudo-momentum spectrum	122
2.7.4	Expression for the Dirac determinant for various options	124
2.8	An attempt to understand preferred extremals of Kähler action	132
2.8.1	Basic ideas about preferred extremals	133
2.8.2	What could be the construction recipe for the preferred extremals assuming $CP_2 = CP_2^{mod}$ identification?	136
2.8.3	Could octonion analyticity solve the field equations?	139
2.9	In what sense TGD could be an integrable theory?	147
2.9.1	What integrable theories are?	148
2.9.2	Why TGD could be integrable theory in some sense?	150
2.9.3	Questions	151
2.9.4	Could TGD be an integrable theory?	151
2.10	About deformations of known extremals of Kähler action	153
2.10.1	What might be the common features of the deformations of known extremals	153
2.10.2	What small deformations of CP_2 type vacuum extremals could be?	155
2.10.3	Hamilton-Jacobi conditions in Minkowskian signature	158
2.10.4	Deformations of cosmic strings	160
2.10.5	Deformations of vacuum extremals?	160
2.10.6	About the interpretation of the generalized conformal algebras	161
2.11	Do geometric invariants of preferred extremals define topological invariants of space-time surface and code for quantum physics?	162
2.11.1	Preferred extremals of Kähler action as manifolds with constant Ricci scalar whose geometric invariants are topological invariants	163
2.11.2	Is there a connection between preferred extremals and AdS_4/CFT correspondence?	164
2.11.3	Generalizing Ricci flow to Maxwell flow for 4-geometries and Kähler flow for space-time surfaces	166
2.11.4	Could correlation functions, S-matrix, and coupling constant evolution be coded the statistical properties of preferred extremals?	171

2.12	Does thermodynamics have a representation at the level of space-time geometry? . . .	173
2.12.1	Motivations and background	174
2.12.2	Kiehn's topological thermodynamics (TTD)	176
2.12.3	Attempt to identify TTD in TGD framework	176
2.13	Robert Kiehn's ideas about Falaco solitons and generation of turbulent wake from TGD perspective	180
2.13.1	Falaco solitons and TGD	181
2.13.2	Stringy description of condensed matter physics and chemistry?	181
2.13.3	New manner to understand the generation of turbulent wake	183
3	General View About Physics in Many-Sheeted Space-Time: Part I	187
3.1	Introduction	187
3.1.1	Various types of topological condensation	187
3.1.2	Implications of the topological non-triviality of macroscopic space-time	188
3.1.3	Topics of the chapter	188
3.2	What do space-like 3-surfaces look like?	190
3.2.1	Renormalization group invariance, quantum criticality and topology of 3-space	190
3.2.2	3-surfaces can have outer boundaries	192
3.2.3	Topological field quantization	193
3.2.4	Comparison of Maxwellian and TGD views about classical gauge fields	196
3.3	Basic phenomenology of topological condensation	201
3.3.1	Basic concepts	202
3.3.2	Gauge charges and gauge fluxes	204
3.3.3	Can one regard $\#$ <i>resp.</i> $\#_B$ contacts as particles <i>resp.</i> string like objects?	207
3.3.4	TGD based description of external fields	208
3.3.5	Number theoretical considerations	210
3.4	The new space time picture and some of its consequences	212
3.4.1	Topological condensation and formation of bound states	212
3.4.2	3-topology and chemistry	212
3.4.3	3-topology and super-conductivity	213
3.4.4	Macroscopic bodies as a topology of 3-space	214
3.5	Topological condensation and color confinement	218
3.5.1	Explanation of color confinement using quantum classical correspondence	218
3.5.2	Hadrons as color magnetic/electric flux tubes	218
3.5.3	Color confinement and generation of macro-temporal quantum coherence	221
4	General View About Physics in Many-Sheeted Space-Time: Part II	225
4.1	Introduction	225
4.1.1	Parton level formulation of quantum TGD	225
4.1.2	Zero energy ontology	225
4.1.3	Fusion of real and p-adic physics to single one	226
4.1.4	Dark matter hierarchy and hierarchy of Planck constants	226
4.2	The new developments in quantum TGD	227
4.2.1	Reduction of quantum TGD to parton level	227
4.2.2	Quantum measurement theory with finite measurement resolution	229
4.2.3	Hierarchy of Planck constants	229
4.2.4	Zero energy ontology	231
4.2.5	U- and S-matrices	232
4.2.6	Number theoretic ideas	233
4.3	Identification of elementary particles and the role of Higgs in particle massivation	236
4.3.1	Identification of elementary particles	236
4.3.2	New view about the role of Higgs boson in massivation	240
4.3.3	Microscopic identification of Weinberg angle	240
4.4	Super-symplectic degrees of freedom	242
4.4.1	What could happen in the transition to non-perturbative QCD?	242
4.4.2	Super-symplectic bosons as a particular kind of dark matter	244
4.5	Number theoretic compactification and $M^8 - H$ duality	249

4.5.1	Basic idea behind $M^8 - M^4 \times CP_2$ duality	250
4.5.2	Hyper-octonionic Pauli "matrices" and modified definition of hyper-quaternionicity	251
4.5.3	Minimal form of $M^8 - H$ duality	251
4.5.4	Strong form of $M^8 - H$ duality	253
4.5.5	$M^8 - H$ duality and low energy hadron physics	259
4.5.6	The notion of number theoretical braid	259
4.5.7	Connection with string model and Equivalence Principle at space-time level	261
4.6	Weak form electric-magnetic duality and its implications	264
4.6.1	Could a weak form of electric-magnetic duality hold true?	265
4.6.2	Magnetic confinement, the short range of weak forces, and color confinement	269
4.6.3	Could Quantum TGD reduce to almost topological QFT?	273
4.6.4	Kähler action for Euclidian regions as Kähler function and Kähler action for Minkowskian regions as Morse function?	276
4.7	How to define generalized Feynman diagrams?	278
4.7.1	Questions	280
4.7.2	Generalized Feynman diagrams at fermionic and momentum space level	282
4.7.3	How to define integration and p-adic Fourier analysis, integral calculus, and p-adic counterparts of geometric objects?	284
4.7.4	Harmonic analysis in WCW as a manner to calculate WCW functional integrals	290
5	Coupling Constant Evolution in Quantum TGD	295
5.1	Introduction	295
5.1.1	Geometric ideas	296
5.1.2	The construction of M-matrix	299
5.1.3	Could correlation functions, S-matrix, and coupling constant evolution be coded the statistical properties of preferred extremals?	301
5.1.4	Vision about coupling constant evolution	303
5.2	General vision about real and p-adic coupling constant evolution	306
5.2.1	A general view about coupling constant evolution	306
5.2.2	Both symplectic and conformal field theories are needed in TGD framework	308
5.3	Does the evolution of gravitational coupling make sense at space-time level?	316
5.3.1	Is stringy action principle coded by the geometry of preferred extremals?	316
5.3.2	What does the equality of gravitational and inertial masses mean?	318
5.3.3	What is the connection with General Relativity?	319
5.3.4	What does one mean with the evolution of gravitational constant?	319
5.4	RG invariance of gauge couplings inside CD	320
5.4.1	Are all gauge couplings RG invariants within given CD ?	320
5.4.2	Slicing of space-time surface by light-like 3-surfaces	320
5.4.3	Coupling constant evolution as evolution of classical gauge fluxes	321
5.4.4	Questions related to the physical interpretation	322
5.5	Quantitative predictions for the values of coupling constants	324
5.5.1	A revised view about coupling constant evolution	324
5.5.2	Why gravitation is so weak as compared to gauge interactions?	330
5.6	p-Adic coupling constant evolution	332
5.6.1	p-Adic coupling constant evolution associated with length scale resolution at space-time level	332
5.6.2	p-Adic evolution in angular resolution and dynamical Planck constant	333
5.6.3	Large values of Planck constant and electro-weak and strong coupling constant evolution	335
5.6.4	Super-symplectic gluons and non-perturbative aspects of hadron physics	335
5.6.5	Why Mersenne primes should label a fractal hierarchy of physics?	336
5.6.6	The formula for the hadronic string tension	337
5.6.7	How p-adic and real coupling constant evolutions are related to each other?	338
5.6.8	How p-adic coupling constant evolution and p-adic length scale hypothesis emerge from quantum TGD proper?	341

II	MANY-SHEETED COSMOLOGY, AND ASTROPHYSICS	347
6	The Relationship Between TGD and GRT	349
6.1	Introduction	349
6.1.1	Does Equivalence Principle hold true in TGD Universe?	349
6.1.2	Zero energy ontology	350
6.1.3	Dark matter hierarchy and hierarchy of Planck constants	352
6.1.4	The problem of cosmological constant	353
6.1.5	Topics of the chapter	353
6.2	Basic principles of General Relativity from TGD point of view	354
6.2.1	General Coordinate Invariance	354
6.2.2	Equivalence Principle	355
6.2.3	Long length scale limit of TGD as General Relativity with sub-manifold constraint	362
6.2.4	Could preferred extremals of Kähler action satisfy Einstein's equations?	364
6.2.5	The basic objection against TGD	365
6.3	Imbedding of the Reissner-Nordström metric	366
6.3.1	Two basic types of imbeddings	367
6.3.2	The condition guaranteing the vanishing of em , Z^0 , or Kähler fields	367
6.3.3	Imbedding of Reissner-Nordström metric	368
6.4	A model for the final state of the star	374
6.4.1	Spherically symmetric model	375
6.4.2	Dynamo model	378
6.4.3	Z^0 force and dynamics of compact objects	382
6.4.4	Correlation between gamma ray bursts and supernovae and dynamo model for the final state of the star	382
6.4.5	Z^0 force and Super Nova explosion	383
6.4.6	Microscopic description of black-holes in TGD Universe	384
6.5	TGD based model for cosmic strings	388
6.5.1	Zero energy ontology and cosmic strings	389
6.5.2	Topological condensation of cosmic strings	389
6.5.3	Dark energy is replaced with dark matter in TGD framework	390
6.5.4	The values for the TGD counterpart of cosmological constant	390
6.5.5	Matter-antimatter asymmetry and cosmic strings	391
6.6	Allais effect and TGD	392
6.6.1	The effect	392
6.6.2	Could gravitational screening explain Allais effect	393
6.6.3	Allais effect as evidence for large values of gravitational Planck constant?	398
6.6.4	Could Z^0 force be present?	403
6.7	Gravimagnetism and TGD	405
6.7.1	Gravity Probe B and TGD	405
6.7.2	Does horizon correspond to a degenerate four-metric for the rotating counterpart of Schwarzschild metric?	408
6.7.3	Has strong gravimagnetism been observed?	410
6.7.4	Is the large gravimagnetic field possible in TGD framework?	412
6.8	Some differences between GRT and TGD	416
6.8.1	Do neutrinos travel with superluminal speed?	416
6.8.2	Anomalous time dilation effects due to warping as basic distinction between TGD and GRT	425
6.8.3	Evidence for many-sheeted space-time from gamma ray flares	427
6.8.4	Do ultracold neutrons provide direct evidence for many-sheeted space-time?	429
6.8.5	Is gravitational constant really constant?	431
6.9	Entropic gravity in TGD framework	434
6.9.1	The phenomenology of EG in TGD framework	435
6.9.2	The conceptual framework of TGD	443
6.9.3	What one obtains from quantum TGD by replacing space-times as surfaces with abstract 4-geometries?	445
6.9.4	What can one conclude?	453

6.10	Could the measurements trying to detect absolute motion of Earth allow to test sub-manifold gravity?	453
6.10.1	The predictions of TGD for the local light-velocity	455
6.10.2	The analysis of Cahill of the measurements trying to measure absolute motion	459
6.10.3	Cahill's work in relation to TGD	462
6.11	Miscellaneous topics	463
6.11.1	Michelson Morley revisited	463
6.11.2	Various interpretations of Machian Principle in TGD framework	470
6.11.3	Einstein's equations and second variation of volume element	470
7	Cosmic Strings	473
7.1	Introduction	473
7.1.1	Various strings	474
7.1.2	Equivalence Principle and cosmic strings	474
7.1.3	TGD based quantum model for astrophysical systems	475
7.1.4	Correlation between super-novae and cosmic strings	476
7.2	General vision about topological condensation of cosmic strings	477
7.2.1	Free cosmic strings	477
7.2.2	TGD based model for cosmic strings	480
7.3	More detailed view about topological condensation of cosmic strings	484
7.3.1	Topological condensation of a positive energy cosmic string	484
7.3.2	Exterior metrics of cosmic string as extremal of curvature scalar	485
7.3.3	Geodesic motion in the exterior metric of cosmic string	487
7.3.4	Matter distribution around cosmic string	488
7.3.5	Quantization of the cosmic recession velocity	490
7.4	Cosmic evolution and cosmic strings	492
7.4.1	Cosmic strings and generation of structures	492
7.4.2	Generation of ordinary matter via TGD counterpart of Hawking radiation?	493
7.4.3	How single cosmic string could reduce its Kähler string tension?	493
7.4.4	Zero energy ontology and cosmic strings	493
7.4.5	A new cosmological finding challenging General Relativity	495
7.5	Cosmic string model for galaxies and other astrophysical objects	497
7.5.1	Cosmic strings and the organization of galaxies into linear structures	497
7.5.2	Cosmic strings and dark matter problem	498
7.5.3	Estimate for the velocity parameters	500
7.5.4	Galaxies as split cosmic strings?	500
7.5.5	Cylindrically symmetric model for the galactic dark matter	503
7.5.6	New information about the distribution of galactic dark matter	504
7.5.7	Cold dark matter in difficulties	506
7.5.8	Three blows against standard view about dark matter	507
7.6	Cosmic strings and energy production in quasars	509
7.6.1	Basic properties of the decaying cosmic strings	509
7.6.2	Decaying cosmic string ends as a central engine	510
7.6.3	How to understand the micro-jet structure?	511
7.6.4	Gamma-ray bursts and cosmic strings	511
7.7	The light particles associated with dark matter and the correlation between gamma ray bursts and supernovae	512
7.7.1	Correlations between gamma ray bursts and supernovae	513
7.7.2	Lepto-pions as a signature dark matter?	518
8	TGD and Cosmology	523
8.1	Introduction	523
8.1.1	Zero energy cosmology	523
8.1.2	Dark matter hierarchy and hierarchy of Planck constants	525
8.1.3	Quantum criticality and quantum phase transitions	526
8.1.4	Critical and over-critical cosmologies are highly unique	526
8.1.5	Equivalence Principle in TGD framework	527

8.1.6	Cosmic strings as basic building blocks of TGD inspired cosmology	528
8.1.7	Topics of the chapter	528
8.2	Basic ingredients of TGD inspired cosmology	529
8.2.1	Many-sheeted space-time defines a hierarchy of smoothed out space-times . . .	529
8.2.2	Robertson-Walker cosmologies	531
8.2.3	Cosmic strings and cosmology	538
8.2.4	Thermodynamical considerations	544
8.2.5	Structure of WCW in zero energy ontology and Robertson-Walker cosmology .	550
8.3	TGD inspired cosmology	552
8.3.1	Primordial cosmology	552
8.3.2	Critical phases	553
8.3.3	Radiation dominated phases	554
8.3.4	Matter dominated phases	555
8.3.5	Stationary cosmology	556
8.4	Inflationary cosmology or quantum critical cosmology?	559
8.4.1	Comparison with inflationary cosmology	560
8.4.2	Balloon measurements of the cosmic microwave background favor flat cosmos .	561
8.4.3	Quantum critical fractal cosmology as TGD counterpart of the inflationary cos- mology	562
8.4.4	The problem of cosmological missing mass	568
8.4.5	TGD based explanation of the results of the balloon experiments	569
8.5	Some problems of cosmology	575
8.5.1	Why some stars seem to be older than the Universe?	575
8.5.2	Mechanism of accelerated expansion in TGD Universe	579
8.5.3	New anomaly in Cosmic Microwave Background	584
8.5.4	Could many-sheeted cosmology explain the claimed time dependence of the fine structure constant?	585
8.5.5	The problem of fermion families	587
8.5.6	The redshift anomaly of quasars	588
8.5.7	Experimental arrangement and findings	590
8.5.8	TGD based model for the quark-gluon plasma	592
8.5.9	Further experimental findings and theoretical ideas	594
8.5.10	Are ordinary black-holes replaced with super-symplectic black-holes in TGD Universe?	598
8.5.11	Very cautious conclusions	600
8.5.12	Five years later	600
8.6	Could hyperbolic 3-manifolds and hyperbolic lattices be relevant in zero energy ontology? 606	
8.6.1	Hyperbolic lattices in H^3 from zero energy ontology	606
8.6.2	Comparing crystallographies in E^3 and H^3	608
8.6.3	Quasicrystals	611
8.6.4	Could quasi-lattices and quasi-crystals emerge from the notion of p-adic manifold? 612	
9	TGD and Astrophysics	621
9.1	Introduction	621
9.1.1	p-Adic length scale hypothesis and astrophysics	621
9.1.2	Quantum criticality, hierarchy of dark matters, and dynamical \hbar	622
9.1.3	Dark matter as a source of long ranged weak and color fields	626
9.2	p-Adic length scale hypothesis at astrophysical and cosmological length scales	626
9.2.1	List of long p-adic length scales	626
9.2.2	p-Adic evolution of cosmological constant	627
9.2.3	Evidence for a new length scale in cosmology	628
9.2.4	Sunspot cycle	629
9.2.5	Sunspots as helical vortices	630
9.2.6	A model for the Sunspot cycle	631
9.2.7	Helical vortex as a model for a magnetic flux tube	632
9.2.8	Estimates for the vacuum parameters of magnetic flux tube	635
9.3	Explanation for the high temperature of solar corona	638

9.3.1	Topological model for the magnetic field of Sun	638
9.3.2	Quantitative formulation	639
9.4	A quantum model for the formation of astrophysical structures and dark matter? . . .	642
9.4.1	TGD prediction for the parameter v_0	642
9.4.2	Model for planetary orbits without $v_0 \rightarrow v_0/5$ scaling	643
9.4.3	The interpretation of \hbar_{gr} and pre-planetary period	648
9.4.4	Inclinations for the planetary orbits and the quantum evolution of the planetary system	649
9.4.5	Eccentricities and comets	650
9.4.6	Why the quantum coherent dark matter is not visible?	650
9.4.7	Quantum interpretation of gravitational Schrödinger equation	651
9.4.8	How do the magnetic flux tube structures and quantum gravitational bound states relate?	655
9.4.9	p-Adic length scale hypothesis and $v_0 \rightarrow v_0/5$ transition at inner-outer border for planetary system	657
9.4.10	About the interpretation of the parameter v_0	658
9.4.11	The challenge of six planets	659
9.5	Further evidence for dark matter	662
9.5.1	Some anomalies	662
9.5.2	Anti-matter and dark matter	667
9.6	Explanations of some astrophysical and cosmological anomalies	668
9.6.1	Apparent shrinking of solar system	669
9.6.2	In what sense speed of light could be changing in solar system?	671
9.6.3	Pioneer anomaly	672
9.6.4	Fly-by anomaly	674
9.7	Do we really understand the solar system?	680
9.7.1	Motivations	680
9.7.2	A model for the motion of comet in the gravitational field of flux tube	685
9.7.3	A model for the precession of the solar system in the gravitational field of flux tube	687
9.7.4	Cosmic evolution as transformation of dark energy to matter	693
9.7.5	The origin of cosmic rays	694
9.8	Inflation and TGD	697
9.8.1	Brief summary of the inflationary scenario	697
9.8.2	Comparison with TGD inspired cosmology	699
9.9	Matter-antimatter asymmetry, baryo-genesis, lepto-genesis, and TGD	703
9.9.1	Background	704
9.9.2	Could TGD allow matter-antimatter asymmetry and baryo-genesis?	706
9.10	Updated view about the hierarchy of Planck constants	711
9.10.1	Basic physical ideas	712
9.10.2	Space-time correlates for the hierarchy of Planck constants	713
9.10.3	Basic phenomenological rules of thumb in the new framework	714
9.10.4	Charge fractionalization and anyons	715
9.10.5	What about the relationship of gravitational Planck constant to ordinary Planck constant?	716
9.10.6	Summary	717
9.11	Do blackholes and blackhole evaporation have TGD counterparts?	718
9.11.1	Background	718
9.11.2	About basic assumptions about blackhole evaporation as seen in TGD context	719
9.11.3	Relating the terminology of blackhole evaporation to TGD framework	721
9.11.4	Could blackhole evaporation have a TGD counterpart?	722

10 Quantum Astrophysics	727
10.1 Introduction	727
10.1.1 Generalization of the notion of imbedding space	727
10.1.2 Gravitational Bohr orbitology	731
10.1.3 How General Coordinate Invariance and Lorentz invariance are achieved?	734
10.2 General quantum vision about formation of structures	736
10.2.1 Simple quantitative model	736
10.2.2 Formation of ring like structures	738
10.2.3 A quantum model for the dark part of the central mass and rings	740
10.2.4 Two stellar components in the halo of Milky Way	742
10.3 Quantum chaos in astrophysical length scales	743
10.3.1 Brief summary about quantum chaos	743
10.3.2 What does the transition to quantum chaos mean?	744
10.3.3 Quantum chaos in astrophysical scales?	745
10.4 Gravitational radiation and large value of gravitational Planck constant	747
10.4.1 Standard view about gravitational radiation	747
10.4.2 Quantum mechanisms for the emission of gravitational radiation	748
10.4.3 Model for dark gravitons	752
10.4.4 Detection of gravitational radiation	756
10.4.5 Quantitative model	757
10.4.6 Generalization to gauge interactions	759
10.4.7 Can graviton have mass?	760
10.5 New view about black-holes	763
10.5.1 Anyonic view about blackholes	763
10.5.2 Super-symplectic bosons	764
10.5.3 Are ordinary black-holes replaced with super-symplectic black-holes in TGD Universe?	765
10.6 Piece-wise accelerated cosmic expansion as basic prediction of quantum cosmology	767
10.6.1 Experimental evidence for accelerated expansion is consistent with TGD based model	767
10.6.2 Quantum version of Expanding Earth theory	771
10.7 Implications of Expanding Earth model for the pre-Cambrian evolution of continents, of climate, and of life	776
10.7.1 Super-continent theory	777
10.7.2 Standard view about oceans	777
10.7.3 Glaciations during Neoproterozoic period	778
10.7.4 Snowball Earth model for the glaciation during pre-Cambrian era	778
10.7.5 TGD point of view about pre-Cambrian period	780
10.7.6 Paleo-magnetic data and Expanding Earth model	785
10.7.7 Did life go underground during pre-Cambrian glaciations?	787
10.8 About the anomalies of the cosmic microwave background	787
10.8.1 Background	788
10.8.2 Anomalies of CMB	789
10.8.3 What TGD could say about the anomalies?	790
10.9 Quantum fluctuations in geometry as a new kind of noise?	800
10.9.1 The experiment	800
10.9.2 Hogan's theory	800
10.9.3 TGD based model	802
10.10 Appendix: Orbital radii of exoplanets as a test for the theory	805
11 What are the counterparts of Einstein's equations in TGD?	811
11.1 Introduction	811
11.2 Does the $SO(3)$ symmetry preserving deformation of the metric of E^3 regularize the icosahedral tetrahedra?	813
11.2.1 Strong gravitation is possible in TGD framework	815
11.2.2 Construction of deformed metrics in zero energy ontology	816
11.2.3 Various realizations of E^3 and its deformations in TGD framework	819

11.2.4	Cosmic honeycombs?	823
11.2.5	Does the replacement $E^3 \rightarrow S^3$ make sense quantum mechanically?	824
11.3	Appendix A: Does TGD force a modification of Einstein equations?	827
11.3.1	Does TGD allow several cosmological "constants"?	828
11.3.2	Preferred extremals suggest a generalization of Einstein's equations	828
11.3.3	Also vacuum extremals suggest a generalization of Einstein's equations	829
11.3.4	What could the modification of Einstein's equations mean from the point of view of dark energy?	830
11.4	Appendix B: Conditions on function $k(r)$ from the generalization of Einstein's equations for vacuum extremals	832
11.4.1	Differential equation for $k(r)$ from generalized Einstein equations	832
11.4.2	Spherical and hyperbolic metrics satisfy modified Einstein's equations	833
11.4.3	Approximate solutions for $\Lambda_1 \neq 0$	834
11.5	Appendix C: Explicit form for the regular tetrahedron property for $k = constant$ option	835
11.5.1	Equations of geodesic lines for deformed E^3	836
11.5.2	Explicit form for the condition $s = k$	838

III TOPOLOGICAL FIELD QUANTIZATION AND GENERATION OF STRUCTURES 839

12	Hydrodynamics and CP_2 Geometry	841
12.1	Introduction	841
12.1.1	Basic ideas and concepts	841
12.1.2	Z^0 magnetic fields and hydrodynamics	843
12.1.3	Topics of the chapter	843
12.2	Many-sheeted space-time concept	844
12.2.1	Basic concepts related to topological condensation and evaporation	844
12.2.2	Can one regard $\# resp. \#_B$ contacts as particles <i>resp.</i> string like objects?	847
12.2.3	Number theoretical considerations	849
12.2.4	Physically interesting p-adic length scales in condensed matter systems	852
12.3	Hydrodynamical and thermodynamical hierarchies	852
12.3.1	Dissipation by the collisions of condensate blocks	852
12.3.2	Energy transfer between different condensate levels in turbulent flow	853
12.3.3	The magnetic fields associated with vortex and rigid body flows	856
12.3.4	Criticality condition	857
12.3.5	Sono-luminescence, Z^0 plasma waves, and hydrodynamic hierarchy	859
12.3.6	p-Adic length scale hypothesis, hydrodynamic turbulence, and distribution of primes	861
12.3.7	Thermodynamical hierarchy	863
12.4	Configuration space geometry and phase transitions	865
12.4.1	Basic ideas of the catastrophe theory	865
12.4.2	Configuration space geometry and catastrophe theory	865
12.4.3	Quantum TGD and catastrophe theory	866
12.4.4	TGD based description of phase transitions	867
12.5	Imbeddings of the cylindrically symmetric flows	868
12.5.1	The general form of the imbedding of the cylindrically symmetric rotational flow	868
12.5.2	Orders of magnitude for some vacuum parameters	871
12.5.3	Critical radii for some special flows	872
12.6	Transition to the turbulence in channel flow	873
12.6.1	Transition to the turbulence	873
12.6.2	Definition of the model	874
12.6.3	Estimates for the parameters	875
12.6.4	Kähler fields associated with the cascade process	876
12.6.5	Order of magnitude estimate for the change of the Kähler action and Reynolds criterion	877
12.6.6	Phase slippage as a mechanism for the decay of vortices	878

13	Macroscopic Quantum Phenomena and CP_2 Geometry	885
13.1	Introduction	885
13.2	General theory	885
13.2.1	Identification of the topological field quanta	886
13.2.2	Formation of the supra phase	887
13.2.3	Generalized quantization conditions	891
13.2.4	Dissipation in super fluids: critical velocities	893
13.2.5	Meissner effect	896
13.2.6	Phase slippage	902
13.3	Models for the topological field quanta	903
13.3.1	The Kähler field created by a constant mass density	903
13.3.2	The imbedding of a constant magnetic field	907
13.3.3	Magnetic fields associated with constant velocity flows	909
13.4	Quantum Hall effect from topological field quantization	909
13.4.1	The effect	909
13.4.2	The model	910
13.5	TGD and condensed matter	914
13.5.1	Electronic conductivity and topological field quantization	914
13.5.2	Dielectrics and topological field quantization	914
13.5.3	Magnetism and topological field quantization	915
1	Appendix	917
A-1	Basic properties of CP_2 and elementary facts about p-adic numbers	917
A-1.1	CP_2 as a manifold	917
A-1.2	Metric and Kähler structure of CP_2	918
A-1.3	Spinors in CP_2	920
A-1.4	Geodesic sub-manifolds of CP_2	921
A-2	CP_2 geometry and standard model symmetries	921
A-2.1	Identification of the electro-weak couplings	921
A-2.2	Discrete symmetries	926
A-3	Basic facts about induced gauge fields	926
A-3.1	Induced gauge fields for space-times for which CP_2 projection is a geodesic sphere	927
A-3.2	Space-time surfaces with vanishing em, Z^0 , or Kähler fields	927
A-4	p-Adic numbers and TGD	930
A-4.1	p-Adic number fields	930
A-4.2	Canonical correspondence between p-adic and real numbers	931

List of Figures

2.1	The projection of the bifurcation set of the swallowtail catastrophe to the 3-dimensional space of control variables. The potential function has four extrema in the interior of the swallowtail bounded by the triangles, no extrema in the valley above the swallowtail, and 2 extrema elsewhere.	73
2.2	Cusp catastrophe. Vertical direction corresponds to the behavior variable and orthogonal directions to control variables.	74
2.3	Topological sum of CP_2 's as Feynman graph with lines thickened to four-manifolds . . .	77
3.1	Topological sum of two manifolds	188
3.2	Hierarchical, fractal like structure of topological condensate predicted by RGI hypothesis: 2-dim. visualization	192
3.3	How one could understand the solid state topologically in terms of the join along boundaries interaction: 2-dim. visualization	213
3.4	3-dimensional matter as projection of the boundary of 3-surface to E^3 : 2-dim. visualization	215
7.1	Quantization of the cosmic recession velocity.	490
7.2	String model for galaxies.	501
8.1	Intuitive definition of length scale dependent space-time	529
12.1	Cusp catastrophe	867
12.2	Phase slippage process and CP_2 geometry	880
13.1	Schematic representation for super conductor	886
13.2	Schematic representation for Super Fluid	887
13.3	The penetration of magnetic field into a super conductor of type I	898
13.4	Experimental arrangement demonstrating Meissner effect for Super fluids	899
13.5	Quantum Hall effect	910
1	The real norm induced by canonical identification from 2-adic norm.	932

Chapter 1

Introduction

1.1 Basic Ideas of TGD

The basic physical picture behind TGD was formed as a fusion of two rather disparate approaches: namely TGD as a Poincare invariant theory of gravitation and TGD as a generalization of the old-fashioned string model.

1.1.1 Background

T(opological) G(eometro)D(ynamics) is one of the many attempts to find a unified description of basic interactions. The development of the basic ideas of TGD to a relatively stable form took time of about half decade [K3]. The great challenge is to construct a mathematical theory around these physically very attractive ideas and I have devoted the last twenty-three years for the realization of this dream and this has resulted in seven online books about TGD and eight online books about TGD inspired theory of consciousness and of quantum biology.

Quantum T(opological) G(eometro)D(ynamics) as a classical spinor geometry for infinite-dimensional configuration space, p-adic numbers and quantum TGD, and TGD inspired theory of consciousness and of quantum biology have been for last decade of the second millenium the basic three strongly interacting threads in the tapestry of quantum TGD.

For few years ago the discussions with Tony Smith initiated a fourth thread which deserves the name 'TGD as a generalized number theory'. The basic observation was that classical number fields might allow a deeper formulation of quantum TGD. The work with Riemann hypothesis made time ripe for realization that the notion of infinite primes could provide, not only a reformulation, but a deep generalization of quantum TGD. This led to a thorough and extremely fruitful revision of the basic views about what the final form and physical content of quantum TGD might be. Together with the vision about the fusion of p-adic and real physics to a larger coherent structure these sub-threads fused to the "physics as generalized number theory" th

A further thread emerged from the realization that by quantum classical correspondence TGD predicts an infinite hierarchy of macroscopic quantum systems with increasing sizes, that it is not at all clear whether standard quantum mechanics can accommodate this hierarchy, and that a dynamical quantized Planck constant might be necessary and certainly possible in TGD framework. The identification of hierarchy of Planck constants whose values TGD "predicts" in terms of dark matter hierarchy would be natural. This also led to a solution of a long standing puzzle: what is the proper interpretation of the predicted fractal hierarchy of long ranged classical electro-weak and color gauge fields. Quantum classical correspondences allows only single answer: there is infinite hierarchy of p-adically scaled up variants of standard model physics and for each of them also dark hierarchy. Thus TGD Universe would be fractal in very abstract and deep sense.

Every updating of the books makes me frustrated as I see how badly the structure of the representation reflects my bird's eye of view as it is at the moment of updating. At this time I realized that the chronology based identification of the threads is quite natural but not logical and it is much more logical to see p-adic physics, the ideas related to classical number fields, and infinite primes as sub-threads of a thread which might be called "physics as a generalized number theory". In the

following I adopt this view. This reduces the number of threads to four! I am not even sure about the number of threads! Be patient!

TGD forces the generalization of physics to a quantum theory of consciousness, and represent TGD as a generalized number theory vision leads naturally to the emergence of p-adic physics as physics of cognitive representations. The seven online books [K87, K68, K59, K54, K69, K78, K75] about TGD and eight online books about TGD inspired theory of consciousness and of quantum biology [K82, K14, K64, K12, K39, K46, K49, K74] are warmly recommended to the interested reader.

1.1.2 TGD as a Poincare invariant theory of gravitation

The first approach was born as an attempt to construct a Poincare invariant theory of gravitation. Space-time, rather than being an abstract manifold endowed with a pseudo-Riemannian structure, is regarded as a surface in the 8-dimensional space $H = M^4 \times CP_2$, where M^4 denotes Minkowski space and $CP_2 = SU(3)/U(2)$ is the complex projective space of two complex dimensions [A62, A52, A59, A50].

The identification of the space-time as a submanifold [A48, A61] of $M^4 \times CP_2$ leads to an exact Poincare invariance and solves the conceptual difficulties related to the definition of the energy-momentum in General Relativity.

It soon however turned out that submanifold geometry, being considerably richer in structure than the abstract manifold geometry, leads to a geometrization of all basic interactions. First, the geometrization of the elementary particle quantum numbers is achieved. The geometry of CP_2 explains electro-weak and color quantum numbers. The different H-chiralities of H -spinors correspond to the conserved baryon and lepton numbers. Secondly, the geometrization of the field concept results. The projections of the CP_2 spinor connection, Killing vector fields of CP_2 and of H -metric to four-surface define classical electro-weak, color gauge fields and metric in X^4 .

1.1.3 TGD as a generalization of the hadronic string model

The second approach was based on the generalization of the mesonic string model describing mesons as strings with quarks attached to the ends of the string. In the 3-dimensional generalization 3-surfaces correspond to free particles and the boundaries of the 3- surface correspond to partons in the sense that the quantum numbers of the elementary particles reside on the boundaries. Various boundary topologies (number of handles) correspond to various fermion families so that one obtains an explanation for the known elementary particle quantum numbers. This approach leads also to a natural topological description of the particle reactions as topology changes: for instance, two-particle decay corresponds to a decay of a 3-surface to two disjoint 3-surfaces.

This decay vertex does not however correspond to a direct generalization of trouser vertex of string models. Indeed, the important difference between TGD and string models is that the analogs of string world sheet diagrams do not describe particle decays but the propagation of particles via different routes. Particle reactions are described by generalized Feynman diagrams for which 3-D light-like surface describing particle propagating join along their ends at vertices. As 4-manifolds the space-time surfaces are therefore singular like Feynman diagrams as 1-manifolds.

1.1.4 Fusion of the two approaches via a generalization of the space-time concept

The problem is that the two approaches to TGD seem to be mutually exclusive since the orbit of a particle like 3-surface defines 4-dimensional surface, which differs drastically from the topologically trivial macroscopic space-time of General Relativity. The unification of these approaches forces a considerable generalization of the conventional space-time concept. First, the topologically trivial 3-space of General Relativity is replaced with a "topological condensate" containing matter as particle like 3-surfaces "glued" to the topologically trivial background 3-space by connected sum operation. Secondly, the assumption about connectedness of the 3-space is given up. Besides the "topological condensate" there could be "vapor phase" that is a "gas" of particle like 3-surfaces (counterpart of the "baby universes" of GRT) and the nonconservation of energy in GRT corresponds to the transfer of energy between the topological condensate and vapor phase.

What one obtains is what I have christened as many-sheeted space-time. One particular aspect is topological field quantization meaning that various classical fields assignable to a physical system

correspond to space-time sheets representing the classical fields to that particular system. One can speak of the field body of a particular physical system. Field body consists of topological light rays, and electric and magnetic flux quanta. In Maxwell's theory system does not possess this kind of field identity. The notion of magnetic body is one of the key players in TGD inspired theory of consciousness and quantum biology.

This picture became more detailed with the advent of zero energy ontology (ZEO). The basic notion of ZEO is causal diamond (CD) identified as the Cartesian product of CP_2 and of the intersection of future and past directed light-cones and having scale coming as an integer multiple of CP_2 size is fundamental. CD s form a fractal hierarchy and zero energy states decompose to products of positive and negative energy parts assignable to the opposite boundaries of CD defining the ends of the space-time surface. The counterpart of zero energy state in positive energy ontology is in terms of initial and final states of a physical event, say particle reaction.

General Coordinate Invariance allows to identify the basic dynamical objects as space-like 3-surfaces at the ends of space-time surface at boundaries of CD : this means that space-time surface is analogous to Bohr orbit. An alternative identification is as light-like 3-surfaces at which the signature of the induced metric changes from Minkowskian to Euclidian and interpreted as lines of generalized Feynman diagrams. Also the Euclidian 4-D regions would have similar interpretation. The requirement that the two interpretations are equivalent, leads to a strong form of General Coordinate Invariance. The outcome is effective 2-dimensionality stating that the partonic 2-surfaces identified as intersections of the space-like ends of space-time surface and light-like wormhole throats are the fundamental objects. That only effective 2-dimensionality is in question is due to the effects caused by the failure of strict determinism of Kähler action. In finite length scale resolution these effects can be neglected below UV cutoff and above IR cutoff. One can also speak about strong form of holography.

There is a further generalization of the space-time concept inspired by p-adic physics forcing a generalization of the number concept through the fusion of real numbers and various p-adic number fields. Also the hierarchy of Planck constants forces a generalization of the notion of space-time.

A very concise manner to express how TGD differs from Special and General Relativities could be following. Relativity Principle (Poincare Invariance), General Coordinate Invariance, and Equivalence Principle remain true. What is new is the notion of sub-manifold geometry: this allows to realize Poincare Invariance and geometrize gravitation simultaneously. This notion also allows a geometrization of known fundamental interactions and is an essential element of all applications of TGD ranging from Planck length to cosmological scales. Sub-manifold geometry is also crucial in the applications of TGD to biology and consciousness theory.

The worst objection against TGD is the observation that all classical gauge fields are expressible in terms of four imbedding space coordinates only- essentially CP_2 coordinates. The linear superposition of classical gauge fields taking place independently for all gauge fields is lost. This would be a catastrophe without many-sheeted space-time. Instead of gauge fields, only the effects such as gauge forces are superposed. Particle topologically condenses to several space-time sheets simultaneously and experiences the sum of gauge forces. This transforms the weakness to extreme economy: in a typical unified theory the number of primary field variables is countered in hundreds if not thousands, now it is just four.

1.2 The threads in the development of quantum TGD

The development of TGD has involved several strongly interacting threads: physics as infinite-dimensional geometry; TGD as a generalized number theory, the hierarchy of Planck constants interpreted in terms of dark matter hierarchy, and TGD inspired theory of consciousness. In the following these threads are briefly described.

1.2.1 Quantum TGD as spinor geometry of World of Classical Worlds

A turning point in the attempts to formulate a mathematical theory was reached after seven years from the birth of TGD. The great insight was "Do not quantize". The basic ingredients to the new approach have served as the basic philosophy for the attempt to construct Quantum TGD since then and have been the following ones:

1. Quantum theory for extended particles is free(!), classical(!) field theory for a generalized Schrödinger amplitude in the configuration space CH consisting of all possible 3-surfaces in H . "All possible" means that surfaces with arbitrary many disjoint components and with arbitrary internal topology and also singular surfaces topologically intermediate between two different manifold topologies are included. Particle reactions are identified as topology changes [A58, A65, A66]. For instance, the decay of a 3-surface to two 3-surfaces corresponds to the decay $A \rightarrow B + C$. Classically this corresponds to a path of configuration space leading from 1-particle sector to 2-particle sector. At quantum level this corresponds to the dispersion of the generalized Schrödinger amplitude localized to 1-particle sector to two-particle sector. All coupling constants should result as predictions of the theory since no nonlinearities are introduced.
2. During years this naive and very rough vision has of course developed a lot and is not anymore quite equivalent with the original insight. In particular, the space-time correlates of Feynman graphs have emerged from theory as Euclidian space-time regions and the strong form of General Coordinate Invariance has led to a rather detailed and in many respects un-expected visions. This picture forces to give up the idea about smooth space-time surfaces and replace space-time surface with a generalization of Feynman diagram in which vertices represent the failure of manifold property. I have also started introduced the word "world of classical worlds" (WCW) instead of rather formal "configuration space". I hope that "WCW" does not induce despair in the reader having tendency to think about the technicalities involved!
3. WCW is endowed with metric and spinor structure so that one can define various metric related differential operators, say Dirac operator, appearing in the field equations of the theory. The most ambitious dream is that zero energy states correspond to a complete solution basis for the Dirac operator of WCW so that this classical free field theory would dictate M-matrices which form orthonormal rows of what I call U-matrix. Given M-matrix in turn would decompose to a product of a hermitian density matrix and unitary S-matrix.

M-matrix would define time-like entanglement coefficients between positive and negative energy parts of zero energy states (all net quantum numbers vanish for them) and can be regarded as a hermitian square root of density matrix multiplied by a unitary S-matrix. Quantum theory would be in well-defined sense a square root of thermodynamics. The orthogonality and hermiticity of the complex square roots of density matrices commuting with S-matrix means that they span infinite-dimensional Lie algebra acting as symmetries of the S-matrix. Therefore quantum TGD would reduce to group theory in well-defined sense: its own symmetries would define the symmetries of the theory. In fact the Lie algebra of Hermitian M-matrices extends to Kac-Moody type algebra obtained by multiplying hermitian square roots of density matrices with powers of the S-matrix. Also the analog of Yangian algebra involving only non-negative powers of S-matrix is possible.

4. By quantum classical correspondence the construction of WCW spinor structure reduces to the second quantization of the induced spinor fields at space-time surface. The basic action is so called modified Dirac action in which gamma matrices are replaced with the modified gamma matrices defined as contractions of the canonical momentum currents with the imbedding space gamma matrices. In this manner one achieves super-conformal symmetry and conservation of fermionic currents among other things and consistent Dirac equation. This modified gamma matrices define as anticommutators effective metric, which might provide geometrization for some basic observables of condensed matter physics. The conjecture is that Dirac determinant for the modified Dirac action gives the exponent of Kähler action for a preferred extremal as vacuum functional so that one might talk about bosonic emergence in accordance with the prediction that the gauge bosons and graviton are expressible in terms of bound states of fermion and antifermion.

The evolution of these basic ideas has been rather slow but has gradually led to a rather beautiful vision. One of the key problems has been the definition of Kähler function. Kähler function is Kähler action for a preferred extremal assignable to a given 3-surface but what this preferred extremal is? The obvious first guess was as absolute minimum of Kähler action but could not be proven to be right or wrong. One big step in the progress was boosted by the idea that TGD should reduce to almost topological QFT in which braids would replace 3-surfaces in finite measurement resolution, which could

be inherent property of the theory itself and imply discretization at partonic 2-surfaces with discrete points carrying fermion number.

1. TGD as almost topological QFT vision suggests that Kähler action for preferred extremals reduces to Chern-Simons term assigned with space-like 3-surfaces at the ends of space-time (recall the notion of causal diamond (CD)) and with the light-like 3-surfaces at which the signature of the induced metric changes from Minkowskian to Euclidian. Minkowskian and Euclidian regions would give at wormhole throats the same contribution apart from coefficients and in Minkowskian regions the $\sqrt{g_4}$ factor would be imaginary so that one would obtain sum of real term identifiable as Kähler function and imaginary term identifiable as the ordinary action giving rise to interference effects and stationary phase approximation central in both classical and quantum field theory. Imaginary contribution - the presence of which I realized only after 33 years of TGD - could also have topological interpretation as a Morse function. On physical side the emergence of Euclidian space-time regions is something completely new and leads to a dramatic modification of the ideas about black hole interior.
2. The manner to achieve the reduction to Chern-Simons terms is simple. The vanishing of Coulombic contribution to Kähler action is required and is true for all known extremals if one makes a general ansatz about the form of classical conserved currents. The so called weak form of electric-magnetic duality defines a boundary condition reducing the resulting 3-D terms to Chern-Simons terms. In this manner almost topological QFT results. But only "almost" since the Lagrange multiplier term forcing electric-magnetic duality implies that Chern-Simons action for preferred extremals depends on metric.
3. A further quite recent hypothesis inspired by effective 2-dimensionality is that Chern-Simons terms reduce to a sum of two 2-dimensional terms. An imaginary term proportional to the total area of Minkowskian string world sheets and a real term proportional to the total area of partonic 2-surfaces or equivalently strings world sheets in Euclidian space-time regions. Also the equality of the total areas of strings world sheets and partonic 2-surfaces is highly suggestive and would realize a duality between these two kinds of objects. String world sheets indeed emerge naturally for the proposed ansatz defining preferred extremals. Therefore Kähler action would have very stringy character apart from effects due to the failure of the strict determinism meaning that radiative corrections break the effective 2-dimensionality.

1.2.2 TGD as a generalized number theory

Quantum T(opological)D(ynamics) as a classical spinor geometry for infinite-dimensional configuration space, p-adic numbers and quantum TGD, and TGD inspired theory of consciousness, have been for last ten years the basic three strongly interacting threads in the tapestry of quantum TGD. The fourth thread deserves the name 'TGD as a generalized number theory'. It involves three separate threads: the fusion of real and various p-adic physics to a single coherent whole by requiring number theoretic universality discussed already, the formulation of quantum TGD in terms of hyper-counterparts of classical number fields identified as sub-spaces of complexified classical number fields with Minkowskian signature of the metric defined by the complexified inner product, and the notion of infinite prime.

p-Adic TGD and fusion of real and p-adic physics to single coherent whole

The p-adic thread emerged for roughly ten years ago as a dim hunch that p-adic numbers might be important for TGD. Experimentation with p-adic numbers led to the notion of canonical identification mapping reals to p-adics and vice versa. The breakthrough came with the successful p-adic mass calculations using p-adic thermodynamics for Super-Virasoro representations with the super-Kac-Moody algebra associated with a Lie-group containing standard model gauge group. Although the details of the calculations have varied from year to year, it was clear that p-adic physics reduces not only the ratio of proton and Planck mass, the great mystery number of physics, but all elementary particle mass scales, to number theory if one assumes that primes near prime powers of two are in a physically favored position. Why this is the case, became one of the key puzzles and led to a number

of arguments with a common gist: evolution is present already at the elementary particle level and the primes allowed by the p-adic length scale hypothesis are the fittest ones.

It became very soon clear that p-adic topology is not something emerging in Planck length scale as often believed, but that there is an infinite hierarchy of p-adic physics characterized by p-adic length scales varying to even cosmological length scales. The idea about the connection of p-adics with cognition motivated already the first attempts to understand the role of the p-adics and inspired 'Universe as Computer' vision but time was not ripe to develop this idea to anything concrete (p-adic numbers are however in a central role in TGD inspired theory of consciousness). It became however obvious that the p-adic length scale hierarchy somehow corresponds to a hierarchy of intelligences and that p-adic prime serves as a kind of intelligence quotient. Ironically, the almost obvious idea about p-adic regions as cognitive regions of space-time providing cognitive representations for real regions had to wait for almost a decade for the access into my consciousness.

There were many interpretational and technical questions crying for a definite answer.

1. What is the relationship of p-adic non-determinism to the classical non-determinism of the basic field equations of TGD? Are the p-adic space-time region genuinely p-adic or does p-adic topology only serve as an effective topology? If p-adic physics is direct image of real physics, how the mapping relating them is constructed so that it respects various symmetries? Is the basic physics p-adic or real (also real TGD seems to be free of divergences) or both? If it is both, how should one glue the physics in different number field together to get *The Physics*? Should one perform p-adicization also at the level of the configuration space of 3-surfaces? Certainly the p-adicization at the level of super-conformal representation is necessary for the p-adic mass calculations.
2. Perhaps the most basic and most irritating technical problem was how to precisely define p-adic definite integral which is a crucial element of any variational principle based formulation of the field equations. Here the frustration was not due to the lack of solution but due to the too large number of solutions to the problem, a clear symptom for the sad fact that clever inventions rather than real discoveries might be in question. Quite recently I however learned that the problem of making sense about p-adic integration has been for decades central problem in the frontier of mathematics and a lot of profound work has been done along same intuitive lines as I have proceeded in TGD framework. The basic idea is certainly the notion of algebraic continuation from the world of rationals belonging to the intersection of real world and various p-adic worlds.

Despite these frustrating uncertainties, the number of the applications of the poorly defined p-adic physics grew steadily and the applications turned out to be relatively stable so that it was clear that the solution to these problems must exist. It became only gradually clear that the solution of the problems might require going down to a deeper level than that represented by reals and p-adics.

The key challenge is to fuse various p-adic physics and real physics to single larger structures. This has inspired a proposal for a generalization of the notion of number field by fusing real numbers and various p-adic number fields and their extensions along rationals and possible common algebraic numbers. This leads to a generalization of the notions of imbedding space and space-time concept and one can speak about real and p-adic space-time sheets. The quantum dynamics should be such that it allows quantum transitions transforming space-time sheets belonging to different number fields to each other. The space-time sheets in the intersection of real and p-adic worlds are of special interest and the hypothesis is that living matter resides in this intersection. This leads to surprisingly detailed predictions and far reaching conjectures. For instance, the number theoretic generalization of entropy concept allows negentropic entanglement central for the applications to living matter.

The basic principle is number theoretic universality stating roughly that the physics in various number fields can be obtained as completion of rational number based physics to various number fields. Rational number based physics would in turn describe physics in finite measurement resolution and cognitive resolution. The notion of finite measurement resolution has become one of the basic principles of quantum TGD and leads to the notions of braids as representatives of 3-surfaces and inclusions of hyper-finite factors as a representation for finite measurement resolution.

The role of classical number fields

The vision about the physical role of the classical number fields relies on the notion of number theoretic compactification stating that space-time surfaces can be regarded as surfaces of either M^8 or $M^4 \times CP_2$. As surfaces of M^8 identifiable as space of hyper-octonions they are hyper-quaternionic or co-hyper-quaternionic- and thus maximally associative or co-associative. This means that their tangent space is either hyper-quaternionic plane of M^8 or an orthogonal complement of such a plane. These surface can be mapped in natural manner to surfaces in $M^4 \times CP_2$ [K81] provided one can assign to each point of tangent space a hyper-complex plane $M^2(x) \subset M^4$. One can also speak about $M^8 - H$ duality.

This vision has very strong predictive power. It predicts that the extremals of Kähler action correspond to either hyper-quaternionic or co-hyper-quaternionic surfaces such that one can assign to tangent space at each point of space-time surface a hyper-complex plane $M^2(x) \subset M^4$. As a consequence, the M^4 projection of space-time surface at each point contains $M^2(x)$ and its orthogonal complement. These distributions are integrable implying that space-time surface allows dual slicings defined by string world sheets Y^2 and partonic 2-surfaces X^2 . The existence of this kind of slicing was earlier deduced from the study of extremals of Kähler action and christened as Hamilton-Jacobi structure. The physical interpretation of $M^2(x)$ is as the space of non-physical polarizations and the plane of local 4-momentum.

One can fairly say, that number theoretical compactification is responsible for most of the understanding of quantum TGD that has emerged during last years. This includes the realization of Equivalence Principle at space-time level, dual formulations of TGD as Minkowskian and Euclidian string model type theories, the precise identification of preferred extremals of Kähler action as extremals for which second variation vanishes (at least for deformations representing dynamical symmetries) and thus providing space-time correlate for quantum criticality, the notion of number theoretic braid implied by the basic dynamics of Kähler action and crucial for precise construction of quantum TGD as almost-topological QFT, the construction of configuration space metric and spinor structure in terms of second quantized induced spinor fields with modified Dirac action defined by Kähler action realizing automatically the notion of finite measurement resolution and a connection with inclusions of hyper-finite factors of type II_1 about which Clifford algebra of configuration space represents an example.

The two most important number theoretic conjectures relate to the preferred extremals of Kähler action. The general idea is that classical dynamics for the preferred extremals of Kähler action should reduce to number theory: space-time surfaces should be either associative or co-associative in some sense.

1. The first meaning for associativity (co-associativity) would be that tangent (normal) spaces of space-time surfaces are quaternionic in some sense and thus associative. This can be formulated in terms of octonionic representation of the imbedding space gamma matrices possible in dimension $D = 8$ and states that induced gamma matrices generate quaternionic sub-algebra at each space-time point. It seems that induced rather than modified gamma matrices must be in question.
2. Second meaning for associative (co-associativity) would be following. In the case of complex numbers the vanishing of the real part of real-analytic function defines a 1-D curve. In octonionic case one can decompose octonion to sum of quaternion and quaternion multiplied by an octonionic imaginary unit. Quaternionicity could mean that space-time surfaces correspond to the vanishing of the imaginary part of the octonion real-analytic function. Co-quaternionicity would be defined in an obvious manner. Octonionic real analytic functions form a function field closed also with respect to the composition of functions. Space-time surfaces would form the analog of function field with the composition of functions with all operations realized as algebraic operations for space-time surfaces. Co-associativity could be perhaps seen as an additional feature making the algebra in question also co-algebra.
3. The third conjecture is that these conjectures are equivalent.

Infinite primes

The discovery of the hierarchy of infinite primes and their correspondence with a hierarchy defined by a repeatedly second quantized arithmetic quantum field theory gave a further boost for the speculations

about TGD as a generalized number theory. The work with Riemann hypothesis led to further ideas.

After the realization that infinite primes can be mapped to polynomials representable as surfaces geometrically, it was clear how TGD might be formulated as a generalized number theory with infinite primes forming the bridge between classical and quantum such that real numbers, p-adic numbers, and various generalizations of p-adics emerge dynamically from algebraic physics as various completions of the algebraic extensions of rational (hyper-)quaternions and (hyper-)octonions. Complete algebraic, topological and dimensional democracy would characterize the theory.

What is especially satisfying is that p-adic and real regions of the space-time surface could emerge automatically as solutions of the field equations. In the space-time regions where the solutions of field equations give rise to in-admissible complex values of the imbedding space coordinates, p-adic solution can exist for some values of the p-adic prime. The characteristic non-determinism of the p-adic differential equations suggests strongly that p-adic regions correspond to 'mind stuff', the regions of space-time where cognitive representations reside. This interpretation implies that p-adic physics is physics of cognition. Since Nature is probably an extremely brilliant simulator of Nature, the natural idea is to study the p-adic physics of the cognitive representations to derive information about the real physics. This view encouraged by TGD inspired theory of consciousness clarifies difficult interpretational issues and provides a clear interpretation for the predictions of p-adic physics.

1.2.3 Hierarchy of Planck constants and dark matter hierarchy

By quantum classical correspondence space-time sheets can be identified as quantum coherence regions. Hence the fact that they have all possible size scales more or less unavoidably implies that Planck constant must be quantized and have arbitrarily large values. If one accepts this then also the idea about dark matter as a macroscopic quantum phase characterized by an arbitrarily large value of Planck constant emerges naturally as does also the interpretation for the long ranged classical electro-weak and color fields predicted by TGD. Rather seldom the evolution of ideas follows simple linear logic, and this was the case also now. In any case, this vision represents the fifth, relatively new thread in the evolution of TGD and the ideas involved are still evolving.

Dark matter as large \hbar phase

D. Da Rocha and Laurent Nottale [E175] have proposed that Schrödinger equation with Planck constant \hbar replaced with what might be called gravitational Planck constant $\hbar_{gr} = \frac{GmM}{v_0}$ ($\hbar = c = 1$). v_0 is a velocity parameter having the value $v_0 = 144.7 \pm .7$ km/s giving $v_0/c = 4.6 \times 10^{-4}$. This is rather near to the peak orbital velocity of stars in galactic halos. Also subharmonics and harmonics of v_0 seem to appear. The support for the hypothesis coming from empirical data is impressive.

Nottale and Da Rocha believe that their Schrödinger equation results from a fractal hydrodynamics. Many-sheeted space-time however suggests astrophysical systems are not only quantum systems at larger space-time sheets but correspond to a gigantic value of gravitational Planck constant. The gravitational (ordinary) Schrödinger equation would provide a solution of the black hole collapse (IR catastrophe) problem encountered at the classical level. The resolution of the problem inspired by TGD inspired theory of living matter is that it is the dark matter at larger space-time sheets which is quantum coherent in the required time scale [K72].

TGD predicts correctly the value of the parameter v_0 assuming that cosmic strings and their decay remnants are responsible for the dark matter. The harmonics of v_0 can be understood as corresponding to perturbations replacing cosmic strings with their n-branched coverings so that tension becomes n^2 -fold: much like the replacement of a closed orbit with an orbit closing only after n turns. $1/n$ -sub-harmonic would result when a magnetic flux tube split into n disjoint magnetic flux tubes. Also a model for the formation of planetary system as a condensation of ordinary matter around quantum coherent dark matter emerges [K72].

The values of Planck constants postulated by Nottale are gigantic and it is natural to assign them to the space-time sheets mediating gravitational interaction and identifiable as magnetic flux tubes (quanta). The magnetic energy of these flux quanta would correspond to dark energy and magnetic tension would give rise to negative "pressure" forcing accelerate cosmological expansion. This leads to a rather detailed vision about the evolution of stars and galaxies identified as bubbles of ordinary and dark matter inside magnetic flux tubes identifiable as dark energy.

Hierarchy of Planck constants from the anomalies of neuroscience biology

The quantal effects of ELF em fields on vertebrate brain have been known since seventies. ELF em fields at frequencies identifiable as cyclotron frequencies in magnetic field whose intensity is about 2/5 times that of Earth for biologically important ions have physiological effects and affect also behavior. What is intriguing that the effects are found only in vertebrates (to my best knowledge). The energies for the photons of ELF em fields are extremely low - about 10^{-10} times lower than thermal energy at physiological temperatures- so that quantal effects are impossible in the framework of standard quantum theory. The values of Planck constant would be in these situations large but not gigantic.

This inspired the hypothesis that these photons correspond to so large value of Planck constant that the energy of photons is above the thermal energy. The proposed interpretation was as dark photons and the general hypothesis was that dark matter corresponds to ordinary matter with non-standard value of Planck constant. If only particles with the same value of Planck constant can appear in the same vertex of Feynman diagram, the phases with different value of Planck constant are dark relative to each other. The phase transitions changing Planck constant can however make possible interactions between phases with different Planck constant but these interactions do not manifest themselves in particle physics. Also the interactions mediated by classical fields should be possible. Dark matter would not be so dark as we have used to believe.

Also the anomalies of biology support the view that dark matter might be a key player in living matter.

Does the hierarchy of Planck constants reduce to the vacuum degeneracy of Kähler action?

This starting point led gradually to the recent picture in which the hierarchy of Planck constants is postulated to come as integer multiples of the standard value of Planck constant. Given integer multiple $\hbar = n\hbar_0$ of the ordinary Planck constant \hbar_0 is assigned with a multiple singular covering of the imbedding space [K30]. One ends up to an identification of dark matter as phases with non-standard value of Planck constant having geometric interpretation in terms of these coverings providing generalized imbedding space with a book like structure with pages labelled by Planck constants or integers characterizing Planck constant. The phase transitions changing the value of Planck constant would correspond to leakage between different sectors of the extended imbedding space. The question is whether these coverings must be postulated separately or whether they are only a convenient auxiliary tool.

The simplest option is that the hierarchy of coverings of imbedding space is only effective. Many-sheeted coverings of the imbedding space indeed emerge naturally in TGD framework. The huge vacuum degeneracy of Kähler action implies that the relationship between gradients of the imbedding space coordinates and canonical momentum currents is many-to-one: this was the very fact forcing to give up all the standard quantization recipes and leading to the idea about physics as geometry of the "world of classical worlds". If one allows space-time surfaces for which all sheets corresponding to the same values of the canonical momentum currents are present, one obtains effectively many-sheeted covering of the imbedding space and the contributions from sheets to the Kähler action are identical. If all sheets are treated effectively as one and the same sheet, the value of Planck constant is an integer multiple of the ordinary one. A natural boundary condition would be that at the ends of space-time at future and past boundaries of causal diamond containing the space-time surface, various branches co-incide. This would raise the ends of space-time surface in special physical role.

Dark matter as a source of long ranged weak and color fields

Long ranged classical electro-weak and color gauge fields are unavoidable in TGD framework. The smallness of the parity breaking effects in hadronic, nuclear, and atomic length scales does not however seem to allow long ranged electro-weak gauge fields. The problem disappears if long range classical electro-weak gauge fields are identified as space-time correlates for massless gauge fields created by dark matter. Also scaled up variants of ordinary electro-weak particle spectra are possible. The identification explains chiral selection in living matter and unbroken $U(2)_{ew}$ invariance and free color in bio length scales become characteristics of living matter and of bio-chemistry and bio-nuclear physics. A possible solution of the matter antimatter asymmetry is based on the identification of also antimatter as dark matter.

1.2.4 TGD as a generalization of physics to a theory consciousness

General coordinate invariance forces the identification of quantum jump as quantum jump between entire deterministic quantum histories rather than time=constant snapshots of single history. The new view about quantum jump forces a generalization of quantum measurement theory such that observer becomes part of the physical system. Thus a general theory of consciousness is unavoidable outcome. This theory is developed in detail in the books [K82, K14, K64, K12, K39, K46, K49, K74].

Quantum jump as a moment of consciousness

The identification of quantum jump between deterministic quantum histories (configuration space spinor fields) as a moment of consciousness defines microscopic theory of consciousness. Quantum jump involves the steps

$$\Psi_i \rightarrow U\Psi_i \rightarrow \Psi_f ,$$

where U is informational "time development" operator, which is unitary like the S-matrix characterizing the unitary time evolution of quantum mechanics. U is however only formally analogous to Schrödinger time evolution of infinite duration although there is *no* real time evolution involved. It is not however clear whether one should regard U-matrix and S-matrix as two different things or not: U -matrix is a completely universal object characterizing the dynamics of evolution by self-organization whereas S-matrix is a highly context dependent concept in wave mechanics and in quantum field theories where it at least formally represents unitary time translation operator at the limit of an infinitely long interaction time. The S-matrix understood in the spirit of superstring models is however something very different and could correspond to U-matrix.

The requirement that quantum jump corresponds to a measurement in the sense of quantum field theories implies that each quantum jump involves localization in zero modes which parameterize also the possible choices of the quantization axes. Thus the selection of the quantization axes performed by the Cartesian outsider becomes now a part of quantum theory. Together these requirements imply that the final states of quantum jump correspond to quantum superpositions of space-time surfaces which are macroscopically equivalent. Hence the world of conscious experience looks classical. At least formally quantum jump can be interpreted also as a quantum computation in which matrix U represents unitary quantum computation which is however not identifiable as unitary translation in time direction and cannot be 'engineered'.

Can one say anything about the unitary process? Zero energy states correspond in positive energy ontology to physical events and break time reversal invariance. This because either the positive or negative energy part of the state is prepared whereas the second end of CD corresponds to a superposition of (negative/positive energy) states with varying particle numbers and single particle quantum numbers just as in ordinary particle physics experiment. State function reduction must change the roles of the ends of CD s. Therefore U -matrix should correspond to the unitary matrix relating zero energy state basis prepared at different ends of CD and state function reduction would be equivalent with state preparation.

The basic objection is that the arrow of geometric time alternates at imbedding space level but we know that arrow of time is universal. What one can say about the arrow of time at space-time level? Quantum classical correspondence requires that quantum mechanical irreversibility corresponds to irreversibility at space-time level. If the observer is analogous to an inhabitant of Flatland gaining information only about space-time surface, he or she is not able to discover that the arrow of time alternates at the level of imbedding space. The inhabitant of a folded bath towel is not able to observe the folding of the towel! Only by observing systems for which the imbedding space arrow of time is opposite, observer can discover the alternation. Living systems indeed behave as if they would contain space-time sheets with opposite arrow of geometric time (self-organization). Phase conjugate light beam is second example of this.

The notion of self

The concept of self is absolutely essential for the understanding of the macroscopic and macro-temporal aspects of consciousness. Self corresponds to a subsystem able to remain un-entangled under the

sequential informational 'time evolutions' U . Exactly vanishing entanglement is practically impossible in ordinary quantum mechanics and it might be that 'vanishing entanglement' in the condition for self-property should be replaced with 'subcritical entanglement'. On the other hand, if space-time decomposes into p-adic and real regions, and if entanglement between regions representing physics in different number fields vanishes, space-time indeed decomposes into selves in a natural manner.

It is assumed that the experiences of the self after the last 'wake-up' sum up to single average experience. This means that subjective memory is identifiable as conscious, immediate short term memory. Selves form an infinite hierarchy with the entire Universe at the top. Self can be also interpreted as mental images: our mental images are selves having mental images and also we represent mental images of a higher level self. A natural hypothesis is that self S experiences the experiences of its subselves as kind of abstracted experience: the experiences of subselves S_i are not experienced as such but represent kind of averages $\langle S_{ij} \rangle$ of sub-subselves S_{ij} . Entanglement between selves, most naturally realized by the formation of join along boundaries bonds between cognitive or material space-time sheets, provides a possible a mechanism for the fusion of selves to larger selves (for instance, the fusion of the mental images representing separate right and left visual fields to single visual field) and forms wholes from parts at the level of mental images.

An attractive possibility suggested by zero energy ontology is that the notions of self and quantum jump reduce to each other and that a fractal hierarchy of quantum jumps within quantum jumps is enough. CD s would serve as imbedding space correlates of selves and quantum jumps would be followed by cascades of state function reductions beginning from given CD and proceeding downwards to the smaller scales (smaller CD s). State function reduction cascades could also take place in parallel branches of the quantum state. One ends up with concrete ideas about how the arrow of geometric time is induced from that of subjective time defined by the experiences induced by the sequences of quantum jumps for sub-selves of self. One ends also ends up with concrete ideas about how the localization of the contents of sensory experience and cognition to the upper boundaries of CD could take place.

Relationship to quantum measurement theory

The third basic element relates TGD inspired theory of consciousness to quantum measurement theory. The assumption that localization occurs in zero modes in each quantum jump implies that the world of conscious experience looks classical. It also implies the state function reduction of the standard quantum measurement theory as the following arguments demonstrate (it took incredibly long time to realize this almost obvious fact!).

1. The standard quantum measurement theory a la von Neumann involves the interaction of brain with the measurement apparatus. If this interaction corresponds to entanglement between microscopic degrees of freedom m with the macroscopic effectively classical degrees of freedom M characterizing the reading of the measurement apparatus coded to brain state, then the reduction of this entanglement in quantum jump reproduces standard quantum measurement theory provide the unitary time evolution operator U acts as flow in zero mode degrees of freedom and correlates completely some orthonormal basis of configuration space spinor fields in non-zero modes with the values of the zero modes. The flow property guarantees that the localization is consistent with unitarity: it also means 1-1 mapping of quantum state basis to classical variables (say, spin direction of the electron to its orbit in the external magnetic field).
2. Since zero modes represent classical information about the geometry of space-time surface (shape, size, classical Kähler field,...), they have interpretation as effectively classical degrees of freedom and are the TGD counterpart of the degrees of freedom M representing the reading of the measurement apparatus. The entanglement between quantum fluctuating non-zero modes and zero modes is the TGD counterpart for the $m - M$ entanglement. Therefore the localization in zero modes is equivalent with a quantum jump leading to a final state where the measurement apparatus gives a definite reading.

This simple prediction is of utmost theoretical importance since the black box of the quantum measurement theory is reduced to a fundamental quantum theory. This reduction is implied by the replacement of the notion of a point like particle with particle as a 3-surface. Also the infinite-dimensionality of the zero mode sector of the configuration space of 3-surfaces is absolutely essential. Therefore the reduction is a triumph for quantum TGD and favors TGD against string models.

Standard quantum measurement theory involves also the notion of state preparation which reduces to the notion of self measurement. Each localization in zero modes is followed by a cascade of self measurements leading to a product state. This process is obviously equivalent with the state preparation process. Self measurement is governed by the so called Negentropy Maximization Principle (NMP) stating that the information content of conscious experience is maximized. In the self measurement the density matrix of some subsystem of a given self localized in zero modes (after ordinary quantum measurement) is measured. The self measurement takes place for that subsystem of self for which the reduction of the entanglement entropy is maximal in the measurement. In p-adic context NMP can be regarded as the variational principle defining the dynamics of cognition. In real context self measurement could be seen as a repair mechanism allowing the system to fight against quantum thermalization by reducing the entanglement for the subsystem for which it is largest (fill the largest hole first in a leaking boat).

Selves self-organize

The fourth basic element is quantum theory of self-organization based on the identification of quantum jump as the basic step of self-organization [K70]. Quantum entanglement gives rise to the generation of long range order and the emergence of longer p-adic length scales corresponds to the emergence of larger and larger coherent dynamical units and generation of a slaving hierarchy. Energy (and quantum entanglement) feed implying entropy feed is a necessary prerequisite for quantum self-organization. Zero modes represent fundamental order parameters and localization in zero modes implies that the sequence of quantum jumps can be regarded as hopping in the zero modes so that Haken's classical theory of self organization applies almost as such. Spin glass analogy is a further important element: self-organization of self leads to some characteristic pattern selected by dissipation as some valley of the "energy" landscape.

Dissipation can be regarded as the ultimate Darwinian selector of both memes and genes. The mathematically ugly irreversible dissipative dynamics obtained by adding phenomenological dissipation terms to the reversible fundamental dynamical equations derivable from an action principle can be understood as a phenomenological description replacing in a well defined sense the series of reversible quantum histories with its envelope.

Classical non-determinism of Kähler action

The fifth basic element are the concepts of association sequence and cognitive space-time sheet. The huge vacuum degeneracy of the Kähler action suggests strongly that the absolute minimum space-time is not always unique. For instance, a sequence of bifurcations can occur so that a given space-time branch can be fixed only by selecting a finite number of 3-surfaces with time like(!) separations on the orbit of 3-surface. Quantum classical correspondence suggest an alternative formulation. Space-time surface decomposes into maximal deterministic regions and their temporal sequences have interpretation a space-time correlate for a sequence of quantum states defined by the initial (or final) states of quantum jumps. This is consistent with the fact that the variational principle selects preferred extremals of Kähler action as generalized Bohr orbits.

In the case that non-determinism is located to a finite time interval and is microscopic, this sequence of 3-surfaces has interpretation as a simulation of a classical history, a geometric correlate for contents of consciousness. When non-determinism has long lasting and macroscopic effect one can identify it as volitional non-determinism associated with our choices. Association sequences relate closely with the cognitive space-time sheets defined as space-time sheets having finite time duration and psychological time can be identified as a temporal center of mass coordinate of the cognitive space-time sheet. The gradual drift of the cognitive space-time sheets to the direction of future force by the geometry of the future light cone explains the arrow of psychological time.

p-Adic physics as physics of cognition and intentionality

The sixth basic element adds a physical theory of cognition to this vision. TGD space-time decomposes into regions obeying real and p-adic topologies labelled by primes $p = 2, 3, 5, \dots$. p-Adic regions obey the same field equations as the real regions but are characterized by p-adic non-determinism since the functions having vanishing p-adic derivative are pseudo constants which are piecewise constant functions. Pseudo constants depend on a finite number of positive binary digits of arguments just like

numerical predictions of any theory always involve decimal cutoff. This means that p-adic space-time regions are obtained by gluing together regions for which integration constants are genuine constants. The natural interpretation of the p-adic regions is as cognitive representations of real physics. The freedom of imagination is due to the p-adic non-determinism. p-Adic regions perform mimicry and make possible for the Universe to form cognitive representations about itself. p-Adic physics space-time sheets serve also as correlates for intentional action.

A more precise formulation of this vision requires a generalization of the number concept obtained by fusing reals and p-adic number fields along common rationals (in the case of algebraic extensions among common algebraic numbers). This picture is discussed in [K80]. The application of this notion at the level of the imbedding space implies that imbedding space has a book like structure with various variants of the imbedding space glued together along common rationals (algebraics). The implication is that genuinely p-adic numbers (non-rationals) are strictly infinite as real numbers so that most points of p-adic space-time sheets are at real infinity, outside the cosmos, and that the projection to the real imbedding space is discrete set of rationals (algebraics). Hence cognition and intentionality are almost completely outside the real cosmos and touch it at a discrete set of points only.

This view implies also that purely local p-adic physics codes for the p-adic fractality characterizing long range real physics and provides an explanation for p-adic length scale hypothesis stating that the primes $p \simeq 2^k$, k integer are especially interesting. It also explains the long range correlations and short term chaos characterizing intentional behavior and explains why the physical realizations of cognition are always discrete (say in the case of numerical computations). Furthermore, a concrete quantum model for how intentions are transformed to actions emerges.

The discrete real projections of p-adic space-time sheets serve also space-time correlate for a logical thought. It is very natural to assign to p-adic binary digits a p -valued logic but as such this kind of logic does not have any reasonable identification. p-Adic length scale hypothesis suggest that the $p = 2^k - n$ binary digits represent a Boolean logic B^k with k elementary statements (the points of the k -element set in the set theoretic realization) with n taboos which are constrained to be identically true.

p-Adic and dark matter hierarchies and hierarchy of moments of consciousness

Dark matter hierarchy assigned to a spectrum of Planck constant having arbitrarily large values brings additional elements to the TGD inspired theory of consciousness.

1. Macroscopic quantum coherence can be understood since a particle with a given mass can in principle appear as arbitrarily large scaled up copies (Compton length scales as \hbar). The phase transition to this kind of phase implies that space-time sheets of particles overlap and this makes possible macroscopic quantum coherence.
2. The space-time sheets with large Planck constant can be in thermal equilibrium with ordinary ones without the loss of quantum coherence. For instance, the cyclotron energy scale associated with EEG turns out to be above thermal energy at room temperature for the level of dark matter hierarchy corresponding to magnetic flux quanta of the Earth's magnetic field with the size scale of Earth and a successful quantitative model for EEG results [K26].

Dark matter hierarchy leads to detailed quantitative view about quantum biology with several testable predictions [K26]. The general prediction is that Universe is a kind of inverted Mandelbrot fractal for which each bird's eye of view reveals new structures in long length and time scales representing scaled down copies of standard physics and their dark variants. These structures would correspond to higher levels in self hierarchy. This prediction is consistent with the belief that 75 per cent of matter in the universe is dark.

1. Living matter and dark matter

Living matter as ordinary matter quantum controlled by the dark matter hierarchy has turned out to be a particularly successful idea. The hypothesis has led to models for EEG predicting correctly the band structure and even individual resonance bands and also generalizing the notion of EEG [K26]. Also a generalization of the notion of genetic code emerges resolving the paradoxes related to the

standard dogma [K47, K26] . A particularly fascinating implication is the possibility to identify great leaps in evolution as phase transitions in which new higher level of dark matter emerges [K26] .

It seems safe to conclude that the dark matter hierarchy with levels labelled by the values of Planck constants explains the macroscopic and macro-temporal quantum coherence naturally. That this explanation is consistent with the explanation based on spin glass degeneracy is suggested by following observations. First, the argument supporting spin glass degeneracy as an explanation of the macro-temporal quantum coherence does not involve the value of \hbar at all. Secondly, the failure of the perturbation theory assumed to lead to the increase of Planck constant and formation of macroscopic quantum phases could be precisely due to the emergence of a large number of new degrees of freedom due to spin glass degeneracy. Thirdly, the phase transition increasing Planck constant has concrete topological interpretation in terms of many-sheeted space-time consistent with the spin glass degeneracy.

2. Dark matter hierarchy and the notion of self

The vision about dark matter hierarchy leads to a more refined view about self hierarchy and hierarchy of moments of consciousness [K25, K26] . The larger the value of Planck constant, the longer the subjectively experienced duration and the average geometric duration $T(k) \propto \hbar$ of the quantum jump.

Quantum jumps form also a hierarchy with respect to p-adic and dark hierarchies and the geometric durations of quantum jumps scale like \hbar . Dark matter hierarchy suggests also a slight modification of the notion of self. Each self involves a hierarchy of dark matter levels, and one is led to ask whether the highest level in this hierarchy corresponds to single quantum jump rather than a sequence of quantum jumps. The averaging of conscious experience over quantum jumps would occur only for sub-selves at lower levels of dark matter hierarchy and these mental images would be ordered, and single moment of consciousness would be experienced as a history of events. The quantum parallel dissipation at the lower levels would give rise to the experience of flow of time. For instance, hadron as a macro-temporal quantum system in the characteristic time scale of hadron is a dissipating system at quark and gluon level corresponding to shorter p-adic time scales. One can ask whether even entire life cycle could be regarded as a single quantum jump at the highest level so that consciousness would not be completely lost even during deep sleep. This would allow to understand why we seem to know directly that this biological body of mine existed yesterday.

The fact that we can remember phone numbers with 5 to 9 digits supports the view that self corresponds at the highest dark matter level to single moment of consciousness. Self would experience the average over the sequence of moments of consciousness associated with each sub-self but there would be no averaging over the separate mental images of this kind, be their parallel or serial. These mental images correspond to sub-selves having shorter wake-up periods than self and would be experienced as being time ordered. Hence the digits in the phone number are experienced as separate mental images and ordered with respect to experienced time.

3. The time span of long term memories as signature for the level of dark matter hierarchy

The basic question is what time scale can one assign to the geometric duration of quantum jump measured naturally as the size scale of the space-time region about which quantum jump gives conscious information. This scale is naturally the size scale in which the non-determinism of quantum jump is localized. During years I have made several guesses about this time scales but zero energy ontology and the vision about fractal hierarchy of quantum jumps within quantum jumps leads to a unique identification.

Causal diamond as an imbedding space correlate of self defines the time scale τ for the space-time region about which the consciousness experience is about. The temporal distances between the tips of CD as come as integer multiples of CP_2 length scales and for prime multiples correspond to what I have christened as secondary p-adic time scales. A reasonable guess is that secondary p-adic time scales are selected during evolution and the primes near powers of two are especially favored. For electron, which corresponds to Mersenne prime $M_{127} = 2^{127} - 1$ this scale corresponds to .1 seconds defining the fundamental time scale of living matter via 10 Hz biorhythm (alpha rhythm). The unexpected prediction is that all elementary particles correspond to time scales possibly relevant to living matter.

Dark matter hierarchy brings additional finesse. For the higher levels of dark matter hierarchy τ is scaled up by \hbar/\hbar_0 . One could understand evolutionary leaps as the emergence of higher levels at

the level of individual organism making possible intentionality and memory in the time scale defined τ .

Higher levels of dark matter hierarchy provide a neat quantitative view about self hierarchy and its evolution. Various levels of dark matter hierarchy would naturally correspond to higher levels in the hierarchy of consciousness and the typical duration of life cycle would give an idea about the level in question. The level would determine also the time span of long term memories as discussed in [K26]. The emergence of these levels must have meant evolutionary leap since long term memory is also accompanied by ability to anticipate future in the same time scale. This picture would suggest that the basic difference between us and our cousins is not at the level of genome as it is usually understood but at the level of the hierarchy of magnetic bodies [K47, K26]. In fact, higher levels of dark matter hierarchy motivate the introduction of the notions of super-genome and hyper-genome. The genomes of entire organ can join to form super-genome expressing genes coherently. Hyper-genomes would result from the fusion of genomes of different organisms and collective levels of consciousness would express themselves via hyper-genome and make possible social rules and moral.

1.3 Bird's eye of view about the topics of the book

This book is mostly devoted to what might be called classical TGD.

1. In a well-defined sense classical TGD defined as the dynamics of space-time surfaces determining them as kind of generalized Bohr orbits can be regarded as an exact part of quantum theory and assuming quantum classical correspondence has served as an extremely valuable guideline in the attempts to interpret TGD, to form a view about what TGD really predicts, and to guess what the underlying quantum theory could be and how it deviates from standard quantum theory.
2. The notions of many-sheeted space-time, topological field quantization and the notion of field/magnetic body, follow from simple topological considerations. The observation that space-time sheets can have arbitrarily large sizes and their interpretation as quantum coherence regions forces to conclude that in TGD Universe macroscopic and macro-temporal quantum coherence are possible in arbitrarily long scales. Also long ranged classical color and electro-weak fields are an unavoidable prediction.
3. It took a considerable time to make the obvious conclusion: TGD Universe is fractal containing fractal copies of standard model physics at various space-time sheets and labeled by the collection of p-adic primes assignable to elementary particles and by the level of dark matter hierarchy characterized partially by the value of Planck constant labeling the pages of the book like structure formed by singular covering spaces of the imbedding space $M^4 \times CP_2$ glued together along a four-dimensional back. Particles at different pages are dark relative to each other since purely local interactions defined in terms of the vertices of Feynman diagram involve only particles at the same page.
4. The new view about energy and time justified by the notion of zero energy ontology means that the sign of inertial energy depends on the time orientation of the space-time sheet and that negative energy space-time sheets serve as correlates for communications to the geometric past. This alone leads to profoundly new views about metabolism, long term memory, and realization of intentional action.

1.3.1 The implications deriving from the topology of space-time surface and from the properties of induced gauge fields

1. The general properties of Kähler action, in particular its vacuum degeneracy and failure of the classical determinism in the conventional sense, have rather far reaching implications. Space-time surfaces as a generalization of Bohr orbit provide not only a representation of quantum states but also sequences of quantum jumps and thus contents of consciousness. Vacuum degeneracy implies spin glass degeneracy in 4-D sense reflecting quantum criticality which is the fundamental characteristic of TGD Universe.

2. The detailed study of the simplest extremals of Kähler action interpreted as correlates for asymptotic self organization patterns provides additional insights [K11] . CP_2 type extremals representing elementary particles, cosmic strings, vacuum extremals, topological light rays ("massless extremal", ME), flux quanta of magnetic and electric fields represent the basic extremals. Pairs of wormhole throats identifiable as parton pairs define a completely new kind of particle carrying only color quantum numbers in ideal case and I have proposed their interpretation as quantum correlates for Boolean cognition. MEs and flux quanta of magnetic and electric fields are of special importance in living matter.

This general picture serves as a cornerstone of also TGD inspired view about cosmology and astrophysics. For obvious reasons the newest ideas developed during last year and still developing (in particular, the vision about dark matter) are not discussed in full depth yet.

1.3.2 Many-sheeted cosmology

The many-sheeted space-time concept, the new view about the relationship between inertial and gravitational four-momenta, the basic properties of the paired cosmic strings, the existence of the limiting temperature, the assumption about the existence of the vapor phase dominated by cosmic strings, and quantum criticality imply a rather detailed picture of the cosmic evolution, which differs from that provided by the standard cosmology in several respects but has also strong resemblances with inflationary scenario.

Basic deviations from standard cosmology

The most important differences between TGD based and standard cosmology are following.

1. Many-sheetedness implies cosmologies inside cosmologies Russian doll like structure with a spectrum of Hubble constants.
2. TGD cosmology is also genuinely quantal: each quantum jump in principle recreates each sub-cosmology in 4-dimensional sense: this makes possible a genuine evolution in cosmological length scales so that the use of anthropic principle to explain why fundamental constants are tuned for life is not necessary.
3. The new view about energy means that inertial energy is negative for space-time sheets with negative time orientation and that the density of inertial energy vanishes in cosmological length scales. Therefore any cosmology is in principle creatable from vacuum and the problem of initial values of cosmology disappears. The density of matter near the initial moment is dominated by cosmic strings approaches to zero so that big bang is transformed to a silent whisper amplified to a relatively big bang.
4. Dark matter hierarchy with dynamical quantized Planck constant implies the presence of dark space-time sheets which differ from non-dark ones in that they define multiple coverings of M^4 . Quantum coherence of dark matter in the length scale of space-time sheet involved implies that even in cosmological length scales Universe is more like a living organism than a thermal soup of particles.
5. Sub-critical and over-critical Robertson-Walker cosmologies are fixed completely from the imbeddability requirement apart from a single parameter characterizing the duration of the period after which transition to sub-critical cosmology necessarily occurs. The fluctuations of the microwave background reflect the quantum criticality of the critical period rather than amplification of primordial fluctuations by exponential expansion. This and also the finite size of the space-time sheets predicts deviations from the standard cosmology.

Cosmic strings

Cosmic strings belong to the basic extremals of the Kähler action. The string tension of the cosmic strings is $T \simeq .2 \times 10^{-6}/G$ and slightly smaller than the string tension of the GUT strings and this makes them very interesting cosmologically. Concerning the understanding of cosmic strings a decisive

breakthrough came through the identification of gravitational four-momentum as the difference of inertial momenta associated with matter and antimatter and the realization that the net inertial energy of the Universe vanishes. This forced to conclude cosmological constant in TGD Universe is non-vanishing. p-Adic length fractality predicts that Λ scales as $1/L^2(k)$ as a function of the p-adic scale characterizing the space-time sheet. The recent value of the cosmological constant comes out correctly. The gravitational energy density described by the cosmological constant is identifiable as that associated with topologically condensed cosmic strings and of magnetic flux tubes to which they are gradually transformed during cosmological evolution.

p-Adic fractality and simple quantitative observations lead to the hypothesis that pairs of cosmic strings are responsible for the evolution of astrophysical structures in a very wide length scale range. Large voids with size of order 10^8 light years can be seen as structures containing knotted and linked cosmic string pairs wound around the boundaries of the void. Galaxies correspond to same structure with smaller size and linked around the supra-galactic strings. This conforms with the finding that galaxies tend to be grouped along linear structures. Simple quantitative estimates show that even stars and planets could be seen as structures formed around cosmic strings of appropriate size. Thus Universe could be seen as fractal cosmic necklace consisting of cosmic strings linked like pearls around longer cosmic strings linked like...

1.3.3 Dark matter and quantization of gravitational Planck constant

The notion of gravitational Planck constant having gigantic value is perhaps the most radical idea related to the astrophysical applications of TGD. D. Da Rocha and Laurent Nottale have proposed that Schrödinger equation with Planck constant \hbar replaced with what might be called gravitational Planck constant $\hbar_{gr} = \frac{GmM}{v_0}$ ($\hbar = c = 1$). v_0 is a velocity parameter having the value $v_0 = 144.7 \pm .7$ km/s giving $v_0/c = 4.6 \times 10^{-4}$. This is rather near to the peak orbital velocity of stars in galactic halos. Also subharmonics and harmonics of v_0 seem to appear. The support for the hypothesis coming from empirical data is impressive.

Nottale and Da Rocha believe that their Schrödinger equation results from a fractal hydrodynamics. Many-sheeted space-time however suggests astrophysical systems are not only quantum systems at larger space-time sheets but correspond to a gigantic value of gravitational Planck constant. The gravitational (ordinary) Schrödinger equation would provide a solution of the black hole collapse (IR catastrophe) problem encountered at the classical level. The resolution of the problem inspired by TGD inspired theory of living matter is that it is the dark matter at larger space-time sheets which is quantum coherent in the required time scale.

TGD predicts correctly the value of the parameter v_0 assuming that cosmic strings and their decay remnants are responsible for the dark matter. The harmonics of v_0 can be understood as corresponding to perturbations replacing cosmic strings with their n-branched coverings so that tension becomes n^2 -fold: much like the replacement of a closed orbit with an orbit closing only after n turns. $1/n$ -sub-harmonic would result when a magnetic flux tube split into n disjoint magnetic flux tubes. An attractive solution of the matter antimatter asymmetry is based on the identification of also antimatter as dark matter.

1.3.4 The topics of the book

The topics of the book are organized as follows.

1. In the first part of the book extremals of Kähler action are discussed and the notions of many-sheeted space-time and topological condensation and evaporation are introduced.
2. In the second part of the book many-sheeted-cosmology and astrophysics are summarized. Cosmic strings and their deformations are basic objects of TGD inspired cosmology and are therefore treated in a separate chapter. p-Adic and dark matter hierarchies imply that TGD inspired cosmology has a kind of Russian doll structure containing cosmologies within cosmologies. In a chapter about TGD inspired cosmology the imbeddings of Robertson-Walker cosmology are studied. Both critical and over-critical cosmology are found to be unique apart from the parameter characterizing its duration.

The idea about dark matter hierarchy with levels labeled by the values of Planck constant was originally motivated by the observation that planetary orbits could be interpreted as Bohr orbits

with enormous value of Planck constant whose value is fixed to a high degree by Equivalence Principle. One ends up to a rather detailed view about macroscopically quantum coherent dark matter in astrophysics and cosmology. In particular, dark matter could be in anyonic phase at light-like 2-surfaces with complex topology and astrophysical size and visible matter would condense around it. Dark matter hierarchy allows to interpret critical cosmologies as correlates for the phase transitions increasing Planck constant and involving a relatively rapid expansion of space-time sheets. The quantum counterpart of the smooth cosmological expansion would be a series of phase transitions increasing the value of Planck constant and these phase transitions are predicted to take place also at planetary level, which provides a new theoretical basis for Expanding Earth hypothesis and suggests totally unexpected connections between biology and geology.

3. The third part of the book includes some old chapters about possible implications of TGD for condensed matter physics written for at least about 15 years ago at least and updated only slightly. The phases of CP_2 complex coordinates could define phases of order parameters of macroscopic quantum phases so that the deviations of induced gauge field concept from the standard one could have direct experimental implications visible for instance in the properties of living matter and even in hydrodynamics. For instance, Z^0 magnetic gauge field could make itself visible in hydrodynamics and also Z^0 magnetic vortices could be involved with super-fluidity.

1.4 The contents of the book

In the first part of the book extremals of Kähler action are discussed and the notions of many-sheeted space-time and topological condensation and evaporation are introduced. In the second part many-sheeted-cosmology and astrophysics are summarized. The third part of the book includes some old chapters about possible implications of TGD for condensed matter physics written for at least about 15 years ago at least and updated only slightly. There is a lot of material about applications of classical TGD in its recent form to say living matter but its inclusion would have led to an explosion: this material can from seven online books about TGD [K87, K68, K69, K78, K59, K54, K75] and eight online books about TGD inspired theory of consciousness and quantum biology [K82, K14, K64, K12, K39, K46, K49, K74] are warmly recommended for the reader willing to get overall view about what is involved.

1.4.1 PART I: The notion of many-sheeted space-time

Basic extremals of the Kähler action

The physical interpretation of the Kähler function and the TGD based space-time concept are the basic themes of this book. The aim is to develop what might be called classical TGD at fundamental level. The strategy is simple: try to guess the general physical consequences of the configuration space geometry and of the TGD based gauge field concept and study the simplest extremals of Kähler action and try to abstract general truths from their properties.

The fundamental underlying assumptions are the following:

1. The 4-surface associated with given 3-surface defined by Kähler function K as a preferred extremal of the Kähler action is identifiable as a classical space-time. Number theoretically preferred extremals would decompose to hyper-quaternionic and co-hyper-quaternionic regions. The reduction of the classical theory to the level of the modified Dirac action implies that the preferred extremals are critical in the sense of allowing infinite number of deformations for which the second variation of Kähler action vanishes [?] It is not clear whether criticality and hyper-quaternionicity are consistent with each other.

Due to the preferred extremal property classical space-time can be also regarded as a generalized Bohr orbit so that the quantization of the various parameters associated with a typical extremal of the Kähler action is expected to take place in general. In TGD quantum states corresponds to quantum superpositions of these classical space-times so that this classical space-time is certainly not some kind of effective quantum average space-time.

2. The bosonic vacuum functional of the theory is the exponent of the Kähler function $\Omega_B = \exp(K)$. This assumption is the only assumption about the dynamics of the theory and is necessitated by the requirement of divergence cancellation in perturbative approach.
3. Renormalization group invariance and spin glass analogy. The value of the Kähler coupling strength is such that the vacuum functional $\exp(K)$ is analogous to the exponent $\exp(H/T)$ defining the partition function of a statistical system at critical temperature. This allows Kähler coupling strength to depend on zero modes of the configuration space metric and as already found there is very attractive hypothesis determining completely the dependence of the Kähler coupling strength on the zero modes based on p-adic considerations motivated by the spin glass analogy.
4. In spin degrees of freedom the massless Dirac equation for the induced spinor fields with modified Dirac action defines classical theory: this is in complete accordance with the proposed definition of the configuration space spinor structure.

The geometrization of the classical gauge fields in terms of the induced gauge field concept is also important concerning the physical interpretation. Electro-weak gauge potentials correspond to the space-time projections of the spinor connection of CP_2 , gluonic gauge potentials to the projections of the Killing vector fields of CP_2 and gravitational field to the induced metric. The topics to be discussed in this part of the book are summarized briefly in the following.

What the selection of preferred extremals of Kähler action might mean has remained a long standing problem and real progress occurred only quite recently (I am writing this towards the end of year 2003).

1. The vanishing of Lorentz 4-force for the induced Kähler field means that the vacuum 4-currents are in a mechanical equilibrium. Lorentz 4-force vanishes for all known solutions of field equations which inspires the hypothesis that all preferred extremals of Kähler action satisfy the condition. The vanishing of the Lorentz 4-force in turn implies local conservation of the ordinary energy momentum tensor. The corresponding condition is implied by Einstein's equations in General Relativity. The hypothesis would mean that the solutions of field equations are what might be called generalized Beltrami fields. The condition implies that vacuum currents can be non-vanishing only provided the dimension D_{CP_2} of the CP_2 projection of the space-time surface is less than four so that in the regions with $D_{CP_2} = 4$, Maxwell's vacuum equations are satisfied.
2. The hypothesis that Kähler current is proportional to a product of an arbitrary function ψ of CP_2 coordinates and of the instanton current generalizes Beltrami condition and reduces to it when electric field vanishes. Instanton current has a vanishing divergence for $D_{CP_2} < 4$, and Lorentz 4-force indeed vanishes. Four 4-dimensional projection the scalar function multiplying the instanton current can make it divergenceless. The remaining task would be the explicit construction of the imbeddings of these fields and the demonstration that field equations can be satisfied.
3. By quantum classical correspondence the non-deterministic space-time dynamics should mimic the dissipative dynamics of the quantum jump sequence. Beltrami fields appear in physical applications as asymptotic self organization patterns for which Lorentz force and dissipation vanish. This suggests that preferred extremals of Kähler action correspond to space-time sheets which at least asymptotically satisfy the generalized Beltrami conditions so that one can indeed assign to the final 3-surface a unique 4-surface apart from effects related to non-determinism. Preferred extremal property abstracted to purely algebraic generalized Beltrami conditions makes sense also in the p-adic context.

This chapter is mainly devoted to the study of the basic extremals of the Kähler action besides the detailed arguments supporting the view that the preferred extrema satisfy generalized Beltrami conditions at least asymptotically.

The newest results discussed in the last section about the weak form of electric-magnetic duality suggest strongly that Beltrami property is general and together with the weak form of electric-magnetic duality allows a reduction of quantum TGD to almost topological field theory with Kähler function allowing expression as a Chern-Simons term.

The surprising implication of the duality is that Kähler form of CP_2 must be replaced with that for $S^2 \times CP_2$ in order to obtain a configuration space metric which is non-trivial in M^4 degrees of freedom. This modification implies much richer vacuum structure than the original Kähler action which is a good news as far as the description of classical gravitational fields in terms of small deformations of vacuum extremals with the four-momentum density of the topologically condensed matter given by Einstein's equations is considered. The breaking of Lorentz invariance from $SO(3,1)$ to $SO(3)$ is implied already by the geometry of CD but is extremely small for a given causal diamond (CD). Since a wave function over the Lorentz boosts and translates of CD is allowed, there is no actual breaking of Poincaré invariance at the level of the basic theory. Beltrami property leads to a rather explicit construction of the general solution of field equations based on the hydrodynamic picture implying that single particle quantum numbers are conserved along flow lines defined by the instanton current. The construction generalizes also to the fermionic sector.

General View About Physics in Many-Sheeted Space-Time: Part I

This chapter is first part of the discussion devoted to the notion of many-sheeted space-time. The notion of many-sheeted space-time used is roughly that as it was around 1990 and text only refers to the recent picture when needed. Topological condensation and somewhat questionable notion of topological evaporation represent the basic new concepts of TGD and an attempt to formulate a general qualitative theory of the topological condensation and evaporation and TGD based space-time concept is made.

The fusion of real and various p-adic physics to single coherent whole by generalizing the notion of number, the generalization of the notion of the imbedding space to allow a mathematical representation of dark matter hierarchy based on dynamical and quantized Planck constant, parton level formulation of TGD using light-like 3-surfaces as basic dynamical objects, and so called zero energy ontology force to generalizes considerably the view about space-time. These developments are discussed in the next chapter.

The topics to be discussed in the sequel will be following.

1. The general structure of topological condensate

The question what 3-space looks like in various scales and end up to a purely topological description for the generation of structures. Topological arguments imply a finite size for non-vacuum 3-surfaces and the conservation of the gauge and gravitational fluxes requires that 3-surface feeds these fluxes to a larger 3-surface via # contacts situated near the boundaries of the 3-surface. Renormalization group invariance (RGI) hypothesis suggests that 3-surfaces with all sizes are important in the functional integral and this leads to the idea of the many-sheeted space-time with hierarchical, fractal like structure such that each level of the hierarchy corresponds to a characteristic length scale.

2. Topological field quantization

The general space-time picture suggested by RGI hypothesis can be justified mathematically. Due to the compactness of CP_2 , a general space-time surface representable as a map $M^4 \rightarrow CP_2$ decomposes into regions, "topological field quanta", characterized by certain vacuum quantum numbers and 3-surface is in general unstable against the decay to disjoint components along the boundaries of the field quanta.

Topological field quanta have finite size depending on the values of the vacuum quantum numbers: the size increases as the values of the vacuum quantum numbers increase. Topological field quantum is therefore a good candidate for a quantum coherent system provided some Bose Einstein condensate or quantum coherent state is available. The BE condensate or coherent state of the light # contacts (wormhole contacts) near the boundaries of the topological field quantum is a good candidate in this respect.

The requirement of the gauge charge conservation implies the hierarchical structure of the topological condensate: gauge fluxes must go somewhere from the outer boundaries of the topological field quantum with finite size and this 'somewhere' must be a larger topological field quantum, which in turn feeds its gauge fluxes to a larger topological field quantum,.... Of course, the nonlinearity of the theory could allow vacuum charge densities which can cancel the net charge near boundaries. The recent view about quantum TGD however supports the conclusion that vacuum currents are light-like and do not contribute to charge renormalization. This provides a justification for the notion of p-adic

coupling constant evolution.

Topological field quanta allow discrete scalings as a dynamical symmetry. p-Adic length scale hypothesis states that the allowed scaling factors correspond to powers of $\sqrt[p]{p}$, where the prime p satisfies $p \simeq 2^k$, k integer with prime values favored. p-Adic fractality (actually multi-p-fractality) can be justified more rigorously by a precise formulation for the fusion of real and various p-adic physics based on the generalization of the notion of number.

3. General physical consequences of new view about space-time

The physical consequences of the new space-time picture are nontrivial at all length scales.

1. A natural interpretation for the hierarchical structure is in terms of bound state formation. Quarks condense to form hadrons, nucleons condense to form atomic nuclei, nuclei and electrons condense to form atoms, how atoms condense to form molecules, and so on. One ends up with a general picture for the topology of 3-space associated with, say, solid state and with the idea that even the macroscopic bodies of the everyday world correspond to topologically condensed 3-surfaces.
2. The join of 3-surfaces along their boundaries defines a new kind of interaction, which has in fact has been used in phenomenological modeling of chemical reactions. Usually chemical bond is believed to result from Schrödinger equation. At the macroscopic level this interaction is rather familiar to us since it means that two macroscopic bodies just touch each other.
3. In TGD context there are purely topological necessary conditions for quantum coherence and a topological description for dissipative phenomena. The formation of the join along boundaries bonds plays a decisive role in the description and this process provides a universal manner to generate macroscopic quantum systems. There is also a topological description for the formation of the supra phases and the phase of the order parameter of the supra phase ground state contains information about the homotopy of the join along boundaries condensate.

4. Gauge bosons and Higgs boson as wormhole contacts

The proper understanding of the concepts of gauge charges and fluxes and their gravitational counterparts in TGD space-time has taken a lot of efforts.

1. Wormhole (#-) contact is the key notion. Wormhole contacts can be regarded as particles carrying classical charges defined by the gauge fluxes but behaving as extremely tiny dipoles quantum mechanically in the case that gauge charge is conserved. Gauge fluxes and gauge charges assignable to light-like 3-D surfaces (wormhole throats, elementary particle horizons, causal determinants) surrounding a topologically condensed CP_2 type extremals can be identified as the quantum numbers assignable to fermionic oscillator operators generating the state associated with horizon (wormhole throat) identifiable as a parton.
2. Quantum classical correspondence requires that commuting classical gauge charges are quantized and this is expected to be true by the generalized Bohr orbit property of the space-time surface.
3. Both gauge bosons and Higgs boson must be identified as wormhole contacts whereas elementary fermions correspond to wormhole throats associated with topologically condensed CP_2 type vacuum extremals. Gravitons in turn correspond to string like objects formed by pairs of wormhole contacts connected by a flux tube.

5. The interpretation of long range weak and color gauge fields

In TGD gravitational fields are accompanied by long ranged electro-weak and color gauge fields. The only possible interpretation is that there exists a p-adic hierarchy of color and electro-weak physics such that weak bosons are massless below the p-adic length scale determining the mass scale of weak bosons. By quantum classical correspondence classical long ranged gauge fields serve as space-time correlates for gauge bosons below the p-adic length scale in question.

The unavoidable long ranged electro-weak and color gauge fields are created by dark matter and dark particles can screen dark nuclear electro-weak charges below the weak scale. Above this scale

vacuum screening occurs as for ordinary weak interactions. Dark gauge bosons are massless below the appropriate p-adic length scale but massive above it and $U(2)_{ew}$ is broken only in the fermionic sector. For dark copies of ordinary fermions masses are essentially identical with those of ordinary fermions.

This interpretation is consistent with the standard elementary particle physics for visible matter apart from predictions such as the possibility of p-adically scaled up versions of ordinary quarks predicted to appear already in ordinary low energy hadron physics. The most interesting implications are seen in longer length scales. Dark variants of ordinary valence quarks and gluons and a scaled up copy of ordinary quarks and gluons are predicted to emerge already in ordinary nuclear physics. Chiral selection in living matter suggests that dark matter is an essential component of living systems so that non-broken $U(2)_{ew}$ symmetry and free color in bio length scales become characteristics of living matter and of bio-chemistry and bio-nuclear physics. An attractive solution of the matter antimatter asymmetry is based on the identification of also antimatter as dark matter.

In this chapter the above vision is discussed in detail. As an application a simple model of color confinement is discussed using the general properties of the induced (classical) color gauge field, in particular the fact that its holonomy group is Abelian.

General View About Physics in Many-Sheeted Space-Time: Part II

This chapter, which is second part of a summary about the recent view about many-sheeted space-time, provides a summary of the developments in TGD that have occurred during last few years (the year I am writing this is 2007). The most important steps of progress are following ones.

1. Parton level formulation of quantum TGD

The formulation of quantum TGD at partonic level identifying fundamental objects as light-like 3-surfaces having also interpretation as random light-like orbits of 2-D partons having arbitrarily large size. This picture reduces quantum TGD to an almost-topological quantum field theory and leads to a dramatic understanding of S-matrix. A generalization of Feynman diagrams emerges obtained by replacing lines of Feynman diagram with light-like 3-surfaces meeting along their ends at vertices. This picture is different from that of string models and means also a generalization of the view about space-time and 3-surface since these surfaces cannot be assumed to be a smooth manifold anymore.

2. Zero energy ontology

In zero energy ontology physical states are creatable from vacuum and have vanishing net quantum numbers, in particular energy. Zero energy states can be decomposed to positive and negative energy parts with definite geometro-temporal separation, call it T , and having interpretation in terms of initial and final states of particle reactions. Zero energy ontology is consistent with ordinary positive energy ontology at the limit when the time scale of the perception of observer is much shorter than T .

Zero energy ontology leads to the view about S-matrix as a characterizer of time-like entanglement associated with the zero energy state and a generalization of S-matrix to what might be called M-matrix emerges. M-matrix is complex square root of density matrix expressible as a product of real valued "modulus" and unitary matrix representing phase and can be seen as a matrix valued generalization of Schrödinger amplitude. Also thermodynamics becomes an inherent element of quantum theory in this approach.

3. Fusion of real and p-adic physics to single one

The fusion of p-adic physics and real physics to single coherent whole requires generalization of the number concept obtained by gluing reals and various p-adic number fields along common algebraic numbers. This leads to a new vision about how cognition and intentionality make themselves visible in real physics via long range correlations realized via the effective p-adicity of real physics. The success of the p-adic length scale hypothesis and p-adic mass calculations suggest that cognition and intentionality are present already at elementary particle level. This picture leads naturally to an effective discretization of the real physics at the level of S-matrix and relying on the notion of umber theoretic braid.

4. Dark matter hierarchy and hierarchy of Planck constants

Dark matter revolution with levels of the hierarchy labeled by values of Planck constant forces a further generalization of the notion of imbedding space and thus of space-time. One can say, that imbedding space is a book like structure obtained by gluing together infinite number of copies of the imbedding space like pages of a book: two copies characterized by singular discrete bundle structure are glued together along 4-dimensional set of common points. These points have physical interpretation in terms of quantum criticality. Particle states belonging to different sectors (pages of the book) can interact via field bodies representing space-time sheets which have parts belonging to two pages of this book.

5. *Equivalence Principle and evolution of gravitational constant*

Before saying anything about evolution of gravitational constant one must understand whether it is a fundamental constant or prediction of quantum TGD. Also one should understand whether Equivalence Principle holds true and if so, in what sense. Also the identification of gravitational and inertial masses seems to be necessary.

1. The coset construction for super-symplectic and super Kac-Moody algebras implies Equivalence Principle in the sense that four-momenta assignable to the Super Virasoro generators of the two algebras are identical. The challenge is to understand this result in more concrete terms.
2. The progress made in the understanding of number theoretical compactification led to a dramatic progress in the construction of configuration space geometry and spinor structure in terms of the modified Dirac operator associated with light-like 3-surfaces appearing in the slicing of the preferred extremal $X(X_l^3)$ of Kähler action to light-like 3-surfaces Y_l^3 "parallel" to X_l^3 . Even more the M^4 projection is predicted to have a slicing into 2-dimensional stringy worldsheets having $M^2(x) \subset M^4$ as a tangent space at point x .
3. By dimensional reduction one can assign to any stringy slice Y^2 a stringy action obtained by integrating Kähler action over the transversal degrees of freedom labeling the copies of Y^2 . One can assign length scale evolution to the string tension $T(x)$, which in principle can depend on the point of the string world sheet and thus evolves. $T(x)$ is not identifiable as inverse of gravitational constant but by general arguments proportional to $1/L_p^2$, where L_p is p-adic length scale.
4. Gravitational constant can be understood as a product of L_p^2 with the exponential of the Kähler action for the two pieces of CP_2 type vacuum extremals representing wormhole contacts assignable to graviton connected by the string world sheets. The volume of the typical CP_2 type extremal associated with the graviton increases with L_p so that the exponential factor decreases reducing the growth due to the increase of L_p . Hence G could be RG invariant in p-adic coupling constant evolution. It does not make sense to formulate evolution of gravitational constant at space-time level and gravitational constant characterizes given CD .
5. Gravitational mass is assigned to the stringy world sheet and should be identical with the inertial mass identified as Noether charge assignable to the preferred extremal. By construction there are good hopes that for a proper choice of G gravitational and inertial masses are identical.

6. *Renormalization group equations for gauge couplings at space-time level*

Renormalization group evolution equations for gauge couplings at given space-time sheet are discussed using quantum classical correspondence. For known extremals of Kähler action gauge couplings are RG invariants inside single space-time sheet, which supports the view that discrete p-adic coupling constant evolution replaces the ordinary coupling constant evolution.

7. *Quantitative predictions for the values of coupling constants*

The latest progress in the understanding of p-adic coupling constant evolution comes from a formula for Kähler coupling strength α_K in terms of Dirac determinant of the modified Dirac operator associated with Kähler action.

The formula for α_K fixes its number theoretic anatomy and also that of other coupling strengths. The assumption that simple rationals (p-adicization) are involved can be combined with the input from p-adic mass calculations and with an old conjecture for the formula of gravitational constant

allowing to express it in terms of CP_2 length scale and Kähler action of topologically condensed CP_2 type vacuum extremal. The prediction is that α_K is renormalization group invariant and equals to the value of fine structure constant at electron length scale characterized by M_{127} . Although Newton's constant is proportional to p-adic length scale squared it can be RG invariant thanks to exponential reduction due to the presence of the exponent of Kähler action associated with the two CP_2 type vacuum extremals representing the wormhole contacts associated with graviton. The number theoretic anatomy of R^2/G allows to consider two options. For the first one only M_{127} gravitons are possible number theoretically. For the second option gravitons corresponding to $p \simeq 2^k$ are possible.

A relationship between electromagnetic and color coupling constant evolutions based on the formula $1/\alpha_{em} + 1/\alpha_s = 1/\alpha_K$ is suggested by the induced gauge field concept, and would mean that the otherwise hard-to-calculate evolution of color coupling strength is fixed completely. The predicted value of α_s at intermediate boson length scale is correct.

In this chapter the above topics are discussed in detail. Also the possible role of so called super-symplectic gauge bosons in the understanding of non-perturbative phase of QCD and black-hole physics is discussed.

Coupling Constant Evolution in Quantum TGD

This chapter summarizes the recent views about p-adic coupling constant evolution.

1. *The most recent view about coupling constant evolution*

Zero energy ontology, the construction of M -matrix as time like entanglement coefficients defining Connes tensor product characterizing finite measurement resolution in terms of inclusion of hyper-finite factors of type II_1 , the realization that symplectic invariance of N-point functions provides a detailed mechanism eliminating UV divergences, and the understanding of the relationship between super-canonical and super Kac-Moody symmetries: these are the pieces of the puzzle whose combination makes possible a rather concrete vision about coupling constant evolution in TGD Universe and one can even speak about rudimentary form of generalized Feynman rules.

2. *Equivalence Principle and evolution of gravitational constant*

Before saying anything about evolution of gravitational constant one must understand whether it is a fundamental constant or prediction of quantum TGD. Also one should understand whether Equivalence Principle holds true and if so, in what sense. Also the identification of gravitational and inertial masses seems to be necessary.

1. The coset construction for super-symplectic and super Kac-Moody algebras implies Equivalence Principle in the sense that four-momenta assignable to the Super Virasoro generators of the two algebras are identical. The challenge is to understand this result in more concrete terms.
2. The progress made in the understanding of number theoretical compactification led to a dramatic progress in the construction of configuration space geometry and spinor structure in terms of the modified Dirac operator associated with light-like 3-surfaces appearing in the slicing of the preferred extremal $X(X_l^3)$ of Kähler action to light-like 3-surfaces Y_l^3 "parallel" to X_l^3 . Even more the M^4 projection is predicted to have a slicing into 2-dimensional stringy worldsheets having $M^2(x) \subset M^4$ as a tangent space at point x .
3. By dimensional reduction one can assign to any stringy slice Y^2 a stringy action obtained by integrating Kähler action over the transversal degrees of freedom labeling the copies of Y^2 . One can assign length scale evolution to the string tension $T(x)$, which in principle can depend on the point of the string world sheet and thus evolves. $T(x)$ is not identifiable as inverse of gravitational constant but by general arguments proportional to $1/L_p^2$, where L_p is p-adic length scale.
4. Gravitational constant can be understood as a product of L_p^2 with the exponential of the Kähler action for the two pieces of CP_2 type vacuum extremals representing wormhole contacts assignable to graviton connected by the string world sheets. The volume of the typical CP_2 type extremal associated with the graviton increases with L_p so that the exponential factor

decreases reducing the growth due to the increase of L_p . Hence G could be RG invariant in p-adic coupling constant evolution. It does not make sense to formulate evolution of gravitational constant at space-time level and gravitational constant characterizes given CD .

5. Gravitational mass is assigned to the stringy world sheet and should be identical with the inertial mass identified as Noether charge assignable to the preferred extremal. By construction there are good hopes that for a proper choice of G gravitational and inertial masses are identical.

3. The RG invariance of gauge couplings inside causal diamond

Quantum classical correspondence suggests that the notion of p-adic coupling constant evolution should have space-time correlate. Zero energy ontology suggests that this counterpart is realized in terms of CD s in the sense that coupling constant evolution has formulation at space-time level inside CD of given size scale and that RG invariance holds true for this evolution. Number theoretic compactification forces to conclude that space-time surfaces has slicing into light-like 3-surfaces Y_l^3 : this prediction is consistent with that is known about the extremals. General Coordinate Invariance requires that basic theory can be formulated by replacing the light-like 3-surface X_l^3 associated with wormhole throats with any surface Y_l^3 appearing in the associated slicing.

The natural identification for the renormalization group parameter is as the light-like coordinate labeling different light-like slices. The light-likeness of the RG parameter suggests RG invariance. Quantum classical correspondence requires that the classical gauge fluxes to X_l^3 selected by stationary phase approximation correspond to the expectation values of gQ_g , where g is coupling constant and Q_g the expectation (eigen) value of corresponding charge matrix in the state in question. If the gauge currents are light-like and in direction of Y_l^3 as they are for known extremals under proper selection of X_l^3 , RG invariance follows because Abelian gauge fluxes are conserved due to the absence of the component of vacuum current in the direction of slicing.

In principle TGD predicts the values of all coupling constants including also the value of Kähler coupling strength which follows from the identification of Kähler action of the preferred extremal $X^4(X_l^3)$ of Kähler action as Dirac determinant associated with modified Dirac action. Hence Kähler coupling strength could have several values. Quantum criticality in the strongest form however motivates the hypothesis that g_K^2 is invariant under p-adic coupling constant evolution and evolution under evolution associated with the hierarchy of Planck constants.

4. Quantitative predictions for the values of coupling constants

The latest progress in the understanding of p-adic coupling constant evolution comes from a formula for Kähler coupling strength α_K in terms of Dirac determinant of the modified Dirac operator associated with $C - S$ action. The progress came from the realization about how that data about preferred extremal of Kähler action is feeded into the eigenvalue spectrum, which - due to the almost topological character of $C - S$ action - is otherwise far from fixed.

The formula for α_K fixes its number theoretic anatomy and also that of other coupling strengths. The assumption that simple rationals (p-adicization) are involved can be combined with the input from p-adic mass calculations and with an old conjecture for the formula of gravitational constant allowing to express it in terms of CP_2 length scale and Kähler action of topologically condensed CP_2 type vacuum extremal. The prediction is that α_K is renormalization group invariant and equals to the value of fine structure constant at electron length scale characterized by M_{127} . Newton's constant is proportional to p-adic length scale squared and ordinary gravitons correspond to M_{127} . The number theoretic anatomy of R^2/G allows to consider two options. For the first one only M_{127} gravitons are possible number theoretically. For the second option gravitons corresponding to $p \simeq 2^k$ are possible.

A relationship between electromagnetic and color coupling constant evolutions based on the formula $1/\alpha_{em} + 1/\alpha_s = 1/\alpha_K$ is suggested by the induced gauge field concept, and would mean that the otherwise hard-to-calculate evolution of color coupling strength is fixed completely. The predicted value of α_s at intermediate boson length scale is correct.

5. p-Adic length scale evolution of gauge couplings

Understanding the dependence of gauge couplings constants on p-adic prime is one of the basic challenges of quantum TGD. The problem has been poorly understood even at the conceptual level to say nothing about concrete calculations. The generalization of the motion of S-matrix to that of M-matrix changed however the situation. M-matrix is always defined with respect to measurement

resolution characterized in terms of an inclusion of von Neumann algebra. Coupling constant evolution reduces to a discrete evolution involving only octaves of $T(k) = 2^k T_0$ of the fundamental time scale $T_0 = R$, where R CP_2 scale. p-Adic length scale $L(k)$ is related to $T(k)$ by $L^2(k) = T(k)T_0$. p-Adic length scale hypothesis $p \simeq 2^k$, k integer, is automatic prediction of the theory. There is also a close connection with the description of coupling constant evolution in terms of radiative corrections.

If RG invariance at given space-time sheet holds true, the question arises whether it is possible to understand p-adic coupling constant evolution at space-time level and why certain p-adic primes are favored.

1. Simple considerations lead to the idea that M^4 scalings of the intersections of 3-surfaces defined by the intersections of space-time surfaces with light-cone boundary induce transformations of space-time surface identifiable as RG transformations. If sufficiently small they leave gauge charges invariant: this seems to be the case for known extremals which form scaling invariant families. When the scaling corresponds to a ratio p_2/p_1 , $p_2 > p_1$, bifurcation would become possible replacing p_1 -adic effective topology with p_2 -adic one.
2. Stability considerations determine whether p_2 -adic topology is actually realized and could explain why primes near powers of 2 are favored. The renormalization of coupling constant would be dictated by the requirement that Q_i/g_i^2 remains invariant.

1.4.2 PART II: Many-Sheeted Cosmology, and Astrophysics

The Relationship Between TGD and GRT

In this chapter the recent view about TGD as Poincare invariant theory of gravitation is discussed. Radically new views about ontology were necessary before it was possible to see what had been there all the time. Zero energy ontology states that all physical states have vanishing net quantum numbers. The hierarchy of dark matter identified as macroscopic quantum phases labeled by arbitrarily large values of Planck constant is second aspect of the new ontology.

1. *Is Equivalence Principle satisfied in TGD?*

Whether or not Equivalence Principle holds true in TGD Universe has been a long standing issue. The source of problems was the attempt to deduce the formulation of Equivalence Principle in the framework provided by General Relativity framework rather than in string model like context. There were several steps in the enlightenment process.

1. First came the conviction that coset representation for super-symplectic and super Kac-Moody algebras provides extremely general formulation of Equivalence Principle in which inertial and gravitational four-momenta are replaced with Super Virasoro generators of two algebras whose differences annihilate physical states. This idea came for years before becoming aware of its importance and I simply forgot it.
2. Next came the realization of the fundamental role of number theoretical compactification providing a number theoretical interpretation of $M^4 \times CP_2$ and thus also of standard model quantum numbers. This led to the identification of the preferred extremals of Kähler action and to the formulation of quantum TGD in terms of second quantized induced spinors fields. One of the conclusions was that dimensional reduction for preferred extremals of Kähler action- if they have the properties required by theoretic compactification- leads to string model with string tension which is however not proportional to the inverse of Newton's constant but to L_p^2 , p-adic length scale squared and thus gigantic. The connection between gravitational constant and L_p^2 comes from an old argument that I discovered about two decades ago and which allowed to predict the value of Kähler coupling strength by using as input electron mass and p-adic mass calculations. In this framework the role of Planck length as a fundamental length scale is taken by CP_2 size so that Planck length scale loses its magic role as a length scale in which usual views about space-time geometry cease to hold true.
3. The next step was the realization that zero energy ontology allows to avoid the paradox implied in positive energy ontology by the fact that gravitational energy is not conserved but inertial energy identified as Noether charge is. Energy conservation is always in some length scale in zero energy ontology.

4. As a matter fact, there was still one step. I had to become fully aware that the identification of gravitational four-momentum in terms of Einstein tensor makes sense only in long length scales. This is of course trivial but for some reason I did not realize that this fact resolves the paradoxes associated with objects like cosmic strings.

To sum up, the understanding of Equivalence Principle in TGD context required quite many discoveries of mostly mathematical character: the understanding of the super-conformal symmetries of quantum TGD, the discovery of zero energy ontology, the identification of preferred extremals of Kähler action by requiring number theoretical compactification, and the discovery that dimensional reduction allows to formulate quantum in terms of slicing of space-time surface by stringy word sheets.

2. *The problem of cosmological constant*

A further implication of dark matter hierarchy is that astrophysical systems correspond to stationary states analogous to atoms and do not participate to cosmic expansion in a continuous manner but via discrete quantum phase transitions in which gravitational Planck constant increases. By quantum criticality of these phase transitions critical cosmologies are excellent candidates for the modeling of these transitions. Imbeddable critical (and also over-critical) cosmologies are unique apart from a parameter determining their duration and represent accelerating cosmic expansion so that there is no need to introduce cosmological constant.

It indeed turns out possible to understand these critical phases in terms of quantum phase transition increasing the size of large modeled in terms of cosmic strings. A possible mechanism driving the strings to the boundaries of large voids could be repulsive interaction due to net charges of strings. Also repulsive gravitational acceleration could do this. In this framework cosmological constant like parameter does not characterize the density of dark energy but that of dark matter identifiable as quantum phases with large Planck constant.

A further problem is that the naive estimate for the cosmological constant is predicted to be by a factor 10^{120} larger than its value deduced from the accelerated expansion of the Universe. In TGD framework the resolution of the problem comes naturally from the fact that large voids are quantum systems which follow the cosmic expansion only during the quantum critical phases.

p-Adic fractality predicting that cosmological constant is reduced by a power of 2 in phase transitions occurring at times $T(k) \propto 2^{k/2}$, which correspond to p-adic time scales. These phase transitions would naturally correspond to quantum phase transitions increasing the size of the large voids during which critical cosmology predicting accelerated expansion naturally applies. On the average $\Lambda(k)$ behaves as $1/a^2$, where a is the light-cone proper time. This predicts correctly the order of magnitude for observed value of Λ .

3. *Topics of the chapter*

The topics discussed in the chapter are following.

1. The basic principles of GRT (General Coordinate Invariance, Equivalence Principle, and Machian Principle) are discussed from TGD point of view.
2. The theory is applied to the vacuum extremal embeddings of Reissner-Nordström and Schwarzschild metric.
3. A model for the final state of a star, which indicates that Z^0 force, presumably created by dark matter, might have an important role in the dynamics of the compact objects. During year 2003, more than decade after the formulation of the model, the discovery of the connection between supernovas and gamma ray bursts provided strong support for the predicted axial magnetic and Z^0 magnetic flux tube structures predicted by the model for the final state of a rotating star. Two years later the interpretation of the predicted long range weak forces as being caused by dark matter emerged.

The progress in understanding of hadronic mass calculations has led to the identification of so called super-symplectic bosons and their super-counterparts as basic building blocks of hadrons. This notion leads also to a microscopic description of neutron stars and black-holes in terms of highly entangled string like objects in Hagedorn temperature and in very precise sense analogous to gigantic hadrons.

4. A brief summary about cosmic strings, which form a corner stone of TGD inspired cosmology, is given.
5. Allais effect is interpreted as interference effect made possible by gigantic value of gravitational Planck constant assignable to space-time sheets mediating gravitational interaction. There is experimental evidence for gravimagnetic fields in rotating superconductors which are by 20 orders of magnitudes stronger than predicted by general relativity. A TGD based explanation of these observations is proposed. Also the predicted anomalous time dilation due to warping of space-time sheet and possible even for gravitational vacua is discussed.

Cosmic strings

Cosmic strings belong to the basic extremals of the Kähler action. The upper bound for string tension of the cosmic strings is $T \simeq .5 \times 10^{-6}/G$ and in the same range as the string tension of GUT strings and this makes them very interesting cosmologically although TGD cosmic strings have otherwise practically nothing to do with their GUT counterparts.

1. Basic ideas

The understanding of cosmic strings has developed only slowly and has required dramatic modifications of existing views.

1. Zero energy ontology implies that the inertial energy and all quantum numbers of the Universe vanishes and physical states are zero energy states decomposing into pairs of positive and negative energy states localizable to the light-like boundaries of causal diamonds defined as intersections of future and past directed light-cones. Positive energy ontology is a good approximation under certain assumptions.
2. Dark matter hierarchy whose levels are labeled by gigantic values of gravitational Planck constant associated with dark matter is second essential piece of the picture.
3. The second variation of Kähler action vanishes for preferred extremals - at least the second variations associated with dynamical symmetries. This guarantees that Noether currents assignable to the modified Dirac action are conserved. The properties of the preferred extremals allow a dimensional reduction providing formulations of quantum TGD in terms of dual slicings of space-time surface by string world sheets and partonic 2-surfaces. Stringy picture allows a formulation Equivalence Principle at space-time level. The realization that general relativistic formulation of Equivalence Principle holds true only in long length scales resolves various paradoxes, which have plagued quantum TGD from the beginning.
4. The basic question whether one can model the exterior region of the topologically condensed cosmic string using General Relativity. The exterior metric of the cosmic string corresponds to a small deformation of a vacuum extremal. The angular defect and surplus associated with the exterior metrics extremizing curvature scalar can be much smaller than assuming vacuum Einstein's equations. The conjecture is that the exterior metric of galactic string conforms with the Newtonian intuitions and thus explains the constant velocity spectrum of distant stars if one assumes that galaxies are organized to linear structures along long strings like pearls in a necklace.

2. Critical and over-critical cosmologies involve accelerated cosmic expansion

In TGD framework critical and over-critical cosmologies are unique apart from single parameter telling their duration and predict the recently discovered accelerated cosmic expansion. Critical cosmologies are naturally associated with quantum critical phase transitions involving the change of gravitational Planck constant. A natural candidate for such a transition is the increase of the size of a large void as galactic strings have been driven to its boundary. During the phase transitions connecting two stationary cosmologies (extremals of curvature scalar) also determined apart from single parameter, accelerated expansion is predicted to occur. These transitions are completely analogous to quantum transitions at atomic level.

The proposed microscopic model predicts that the TGD counterpart of the quantity $\rho + 3p$ for cosmic strings is negative during the phase transition which implies accelerated expansion. Dark energy is replaced in TGD framework with dark matter indeed predicted by TGD and its fraction is .74 as in standard scenario. Cosmological constant thus characterizes phenomenologically the density of dark matter rather than energy in TGD Universe.

The sizes of large voids stay constant during stationary periods which means that also cosmological constant is piecewise constant. p-Adic length fractality predicts that Λ scales as $1/L^2(k)$ as a function of the p-adic scale characterizing the space-time sheet of void. The order of magnitude for the recent value of the cosmological constant comes out correctly. The gravitational energy density described by the cosmological constant is identifiable as that associated with topologically condensed cosmic strings and of magnetic flux tubes to which they are gradually transformed during cosmological evolution.

3. Cosmic strings and generation of structures

1. In zero energy ontology cosmic strings must be created from vacuum as zero energy states consisting of pairs of strings with opposite time orientation and inertial energy.
2. The counterpart of Hawking radiation provides a mechanism by which cosmic strings can generate ordinary matter. The splitting of cosmic strings followed by a "burning" of the string ends provides a second manner to generate visible matter. Matter-antimatter symmetry would result if antimatter is inside cosmic strings and matter in the exterior region. A justification for CP asymmetry comes from basic quantum TGD. One can add to Kähler function of the configuration space an imaginary part defined by instanton term $J \wedge J$. This term does not affect Kähler metric but implies CP breaking.
3. Zero energy ontology has deep implications for the cosmic and ultimately also for biological evolution (magnetic flux tubes play a fundamental role in TGD inspired biology and cosmic strings are limiting cases of them). The arrows of geometric time are opposite for the strings and also for positive energy matter and negative energy antimatter. This implies a competition between two dissipative time developments proceeding in different directions of geometric time and looking self-organization and even self-assembly from the point of view of each other. This resolves paradoxes created by gravitational self-organization contra second law of thermodynamics. So called super-symplectic matter at cosmic strings implies large p-adic entropy resolves the well-known entropy paradox.
4. p-Adic fractality and simple quantitative observations lead to the hypothesis that cosmic strings are responsible for the evolution of astrophysical structures in a very wide length scale range. Large voids with size of order 10^8 light years can be seen as structures cosmic strings wound around the boundaries of the void. Galaxies correspond to same structure with smaller size and linked around the supra-galactic strings. This conforms with the finding that galaxies tend to be grouped along linear structures. Simple quantitative estimates show that even stars and planets could be seen as structures formed around cosmic strings of appropriate size. Thus Universe could be seen as fractal cosmic necklace consisting of cosmic strings linked like pearls around longer cosmic strings linked like...

4. Cosmic strings, gamma ray bursts, and supernovae

During year 2003 two important findings related to cosmic strings were made.

1. A correlation between supernovae and gamma ray bursts was observed.
2. Evidence that some unknown particles of mass $m \simeq 2m_e$ and decaying to gamma rays and/or electron positron pairs annihilating immediately serve as signatures of dark matter. These findings challenge the identification of cosmic strings and/or their decay products as dark matter, and also the idea that gamma ray bursts correspond to cosmic fire crackers formed by the decaying ends of cosmic strings.

This forces the updating of the more than decade old rough vision about topologically condensed cosmic strings and about gamma ray bursts described in this chapter. According to the updated

model, cosmic strings transform in topological condensation to magnetic flux tubes about which they represent a limiting case. Primordial magnetic flux tubes forming ferro-magnet like structures become seeds for gravitational condensation leading to the formation of stars and galaxies. The TGD based model for the asymptotic state of a rotating star as dynamo leads to the identification of the predicted magnetic flux tube at the rotation axis of the star as Z^0 magnetic flux tube of primordial origin. Besides Z^0 magnetic flux tube structure also magnetic flux tube structure exists at different space-time sheet but is in general not parallel to the Z^0 magnetic structure. This structure cannot have primordial origin (the magnetic field of star can even flip its polarity).

The flow of matter along Z^0 magnetic (rotation) axis generates synchrotron radiation, which escapes as a precisely targeted beam along magnetic axis and leaves the star. The identification is as the rotating light beam associated with ordinary neutron stars. During the core collapse leading to the supernova this beam becomes gamma ray burst. The mechanism is very much analogous to the squeezing of the tooth paste from the tube. The fact that all nuclei are fully ionized Z^0 ions, the Z^0 charge unbalance caused by the ejection of neutrinos, and the radial compression make the effect extremely strong so that there are hopes to understand the observed incredibly high polarization of 80 ± 20 per cent.

TGD suggests the identification of particles of mass $m \simeq 2m_e$ accompanying dark matter as leptopions formed by color excited leptons, and topologically condensed at magnetic flux tubes having thickness of about lepto-pion Compton length. Lepto-pions would serve as signatures of dark matter whereas dark matter itself would correspond to the magnetic energy of topologically condensed cosmic strings transformed to magnetic flux tubes.

TGD inspired cosmology

A proposal for what might be called TGD inspired cosmology is made. The basic ingredient of this cosmology is the TGD counter part of the cosmic string. It is found that many-sheeted space-time concept, the new view about the relationship between inertial and gravitational four-momenta, the basic properties of the cosmic strings, zero energy ontology, the hierarchy of dark matter with levels labeled by arbitrarily large values of Planck constant: the existence of the limiting temperature (as in string model, too), the assumption about the existence of the vapor phase dominated by cosmic strings, and quantum criticality imply a rather detailed picture of the cosmic evolution, which differs from that provided by the standard cosmology in several respects but has also strong resemblances with inflationary scenario.

TGD inspired cosmology in its recent form relies on an ontology differing dramatically from that of GRT based cosmologies. Zero energy ontology states that all physical states have vanishing net quantum numbers so that all matter is creatable from vacuum. The hierarchy of dark matter identified as macroscopic quantum phases labeled by arbitrarily large values of Planck constant is second aspect of the new ontology. The values of the gravitational Planck constant assignable to space-time sheets mediating gravitational interaction are gigantic. This implies that TGD inspired late cosmology might decompose into stationary phases corresponding to stationary quantum states in cosmological scales and critical cosmologies corresponding to quantum transitions changing the value of the gravitational Planck constant and inducing an accelerated cosmic expansion.

1. Zero energy ontology

The construction of quantum theory leads naturally to zero energy ontology stating that everything is creatable from vacuum. Zero energy states decompose into positive and negative energy parts having identification as initial and final states of particle reaction in time scales of perception longer than the geometro-temporal separation T of positive and negative energy parts of the state. If the time scale of perception is smaller than T , the usual positive energy ontology applies.

In zero energy ontology inertial four-momentum is a quantity depending on the temporal time scale T used and in time scales longer than T the contribution of zero energy states with parameter $T_1 < T$ to four-momentum vanishes. This scale dependence alone implies that it does not make sense to speak about conservation of inertial four-momentum in cosmological scales. Hence it would be in principle possible to identify inertial and gravitational four-momenta and achieve strong form of Equivalence Principle. It however seems that this is not the correct approach to follow.

2. Dark matter hierarchy and hierarchy of Planck constants

Dark matter revolution with levels of the hierarchy labeled by values of Planck constant forces a further generalization of the notion of imbedding space and thus of space-time. One can say, that imbedding space is a book like structure obtained by gluing together infinite number of copies of the imbedding space like pages of a book: two copies characterized by singular discrete bundle structure are glued together along 4-dimensional set of common points. These points have physical interpretation in terms of quantum criticality. Particle states belonging to different sectors (pages of the book) can interact via field bodies representing space-time sheets which have parts belonging to two pages of this book.

3. Quantum criticality

TGD Universe is quantum counterpart of a statistical system at critical temperature. As a consequence, topological condensate is expected to possess hierarchical, fractal like structure containing topologically condensed 3-surfaces with all possible sizes. Both Kähler magnetized and Kähler electric 3-surfaces ought to be important and string like objects indeed provide a good example of Kähler magnetic structures important in TGD inspired cosmology. In particular space-time is expected to be many-sheeted even at cosmological scales and ordinary cosmology must be replaced with many-sheeted cosmology. The presence of vapor phase consisting of free cosmic strings containing topologically condensed fermions is second crucial aspect of TGD inspired cosmology.

Quantum criticality of TGD Universe, which corresponds to the vanishing of second variation of Kähler action for preferred extremals - at least of the variations related to dynamical symmetries - supports the view that many-sheeted cosmology is in some sense critical. Criticality in turn suggests fractality. Phase transitions, in particular the topological phase transitions giving rise to new space-time sheets, are (quantum) critical phenomena involving no scales. If the curvature of the 3-space does not vanish, it defines scale: hence the flatness of the cosmic time=constant section of the cosmology implied by the criticality is consistent with the scale invariance of the critical phenomena. This motivates the assumption that the new space-time sheets created in topological phase transitions are in good approximation modelable as critical Robertson-Walker cosmologies for some period of time at least.

These phase transitions are between stationary quantum states having stationary cosmologies as space-time correlates: also these cosmologies are determined uniquely apart from single parameter.

4. Only sub-critical cosmologies are globally imbeddable

TGD allows global imbedding of subcritical cosmologies. A partial imbedding of one-parameter families of critical and overcritical cosmologies is possible. The infinite size of the horizon for the imbeddable critical cosmologies is in accordance with the presence of arbitrarily long range fluctuations at criticality and guarantees the average isotropy of the cosmology. Imbedding is possible for some critical duration of time. The parameter labeling these cosmologies is scale factor characterizing the duration of the critical period. These cosmologies have the same optical properties as inflationary cosmologies. Critical cosmology can be regarded as a 'Silent Whisper amplified to Bang' rather than 'Big Bang' and transformed to hyperbolic cosmology before its imbedding fails. Split strings decay to elementary particles in this transition and give rise to seeds of galaxies. In some later stage the hyperbolic cosmology can decompose to disjoint 3-surfaces. Thus each sub-cosmology is analogous to biological growth process leading eventually to death.

5. Fractal many-sheeted cosmology

The critical cosmologies can be used as a building blocks of a fractal cosmology containing cosmologies containing ... cosmologies. p-Adic length scale hypothesis allows a quantitative formulation of the fractality. Fractal cosmology predicts cosmos to have essentially same optic properties as inflationary scenario but avoids the prediction of unknown vacuum energy density. Fractal cosmology explains the paradoxical result that the observed density of the matter is much lower than the critical density associated with the largest space-time sheet of the fractal cosmology. Also the observation that some astrophysical objects seem to be older than the Universe, finds a nice explanation.

6. Cosmic strings as basic building blocks of TGD inspired cosmology

Cosmic strings are the basic building blocks of TGD inspired cosmology and all structures including large voids, galaxies, stars, and even planets can be seen as pearls in a cosmic fractal necklaces consisting of cosmic strings containing smaller cosmic strings linked around them containing... During

cosmological evolution the cosmic strings are transformed to magnetic flux tubes with smaller Kähler string tension and these structures are also key players in TGD inspired quantum biology.

The observed large voids would contain galactic cosmic strings at their boundaries. These voids would participate cosmic expansion only in average sense. During stationary periods the quantum states would be modelable using stationary cosmologies and during phase transitions increasing gravitational Planck constant and thus size of the large void they critical cosmologies would be the appropriate description. The acceleration of cosmic expansion predicted by critical cosmologies can be naturally assigned with these periods. Classically the quantum phase transition would be induced when galactic strings are driven to the boundary of the large void. The mechanism forcing the phase transition could be repulsive Coulomb energy associated with dark matter at strings if cosmic strings generate net em charge as a consequence of CP breaking (antimatter could reside inside cosmic strings) or a repulsive gravitational acceleration. The large values of Planck constant are crucial for understanding of living matter so that gravitation would play fundamental role also in the evolution of life and intelligence.

Many-sheeted fractal cosmology containing both hyperbolic and critical space-time sheets based on cosmic strings suggests an explanation for several puzzles of GRT based cosmology such as dark matter problem, origin of matter antimatter asymmetry, the problem of cosmological constant and mechanism of accelerated expansion, the problem of several Hubble constants, and the existence of stars apparently older than the Universe. Under natural assumptions TGD predicts same optical properties of the large scale Universe as inflationary scenario does. The recent balloon experiments however favor TGD inspired cosmology.

TGD and Astrophysics

In this chapter some applications of TGD based view about cosmology and astrophysics are discussed.

1. p-Adic length scale hypothesis can be applied in astrophysical length scales, too and some examples of possible applications are discussed. One of the most interesting implications of p-adicity is the possibility of series of phase transitions changing the value of cosmological constant behaving as $\Lambda \propto 1/L^2(k)$ as a function of p-adic length scale characterizing the size of the space-time sheet.
2. A model for the solar magnetic field as a bundle of topological magnetic flux tubes is constructed and a model of Sunspot cycle is proposed. This model is also shown to explain the mysteriously high temperature of solar corona and also some other mysterious phenomena related to the solar atmosphere. A direct connection with the TGD based explanation of the dark energy as magnetic and Z^0 magnetic energy of the magnetic flux tubes containing dark matter as ordinary matter, emerges. The matter in the solar corona is simply dark matter leaked from the highly curved portions of the magnetic flux tubes to the space-time sheets where it becomes visible. The generation of anomalous Z^0 charge caused by the runoff of dark neutrinos in Super Nova could provide a first principle explanation for the avoidance of collapse to black-hole in Super Nova explosion.
3. D. Da Rocha and Laurent Nottale have proposed that Schrödinger equation with Planck constant \hbar replaced with what might be called gravitational Planck constant $\hbar_{gr} = \frac{GmM}{v_0}$ ($\hbar = c = 1$). v_0 is a velocity parameter having the value $v_0 = 144.7 \pm .7$ km/s giving $v_0/c = 4.6 \times 10^{-4}$. This is rather near to the peak orbital velocity of stars in galactic halos. Also subharmonics and harmonics of v_0 seem to appear. The support for the hypothesis coming from empirical data is impressive.

Nottale and Da Rocha believe that their Schrödinger equation results from a fractal hydrodynamics. Many-sheeted space-time however suggests astrophysical systems are not only quantum systems at larger space-time sheets but correspond to a gigantic value of gravitational Planck constant. The gravitational (ordinary) Schrödinger equation would provide a solution of the black hole collapse (IR catastrophe) problem encountered at the classical level. The resolution of the problem inspired by TGD inspired theory of living matter is that it is the dark matter at larger space-time sheets which is quantum coherent in the required time scale.

I have proposed already earlier the possibility that Planck constant is quantized.

- (a) The spectrum would given in terms of integers n characterizing the quantum phases $q = \exp(i\pi/n)$. The Planck constants associated with M^4 and CP_2 degrees of freedom are predicted to be different in general and arbitrarily large values of Planck constants are possible so that $\hbar_{gr} = GMm/v_0$ can be understood in this framework. The general philosophy would be that when the quantum system would become non-perturbative, a phase transition increasing the value of \hbar occurs to preserve the perturbative character. This would apply to QCD and to atoms with $Z > 137$ as well.
 - (b) The model explaining Nottale's findings led later to the generalization of the notion of imbedding space involving a book like structure in both M^4 and CP_2 degrees of freedom. The particles at different pages of the book cannot appear in the same vertex of Feynman diagram. This might be called relative darkness. Interactions via classical fields and exchange of particles leaking between pages are however possible. This distinguishes between TGD based model and more conventional models of dark matter.
 - (c) The integers n which correspond to polygons constructible using ruler and compass are number theoretically preferred. This gives very strong constraints on planetary masses, their general mass scale, and also on the value of v_0 . The constraints are satisfied with accuracy better than 10 per cent.
 - (d) TGD predicts correctly the value of the parameter v_0 assuming that cosmic strings and their decay remnants are responsible for the dark matter. The harmonics of v_0 can be understood as corresponding to perturbations replacing cosmic strings with their n -branched coverings so that tension becomes n^2 -fold: much like the replacement of a closed orbit with an orbit closing only after n turns. $1/n$ -sub-harmonic would result when a magnetic flux tube split into n disjoint magnetic flux tubes.
4. Long ranged classical electro-weak and color gauge fields are unavoidable in TGD framework. The smallness of the parity breaking effects in hadronic, nuclear, and atomic length scales does not however seem to allow long ranged electro-weak gauge fields. The problem disappears if long range classical electro-weak gauge fields are identified as space-time correlates for massless gauge fields created by dark matter. The identification explains chiral selection in living matter and unbroken $U(2)_{ew}$ invariance and free color in bio length scales become characteristics of living matter and of bio-chemistry and bio-nuclear physics. An attractive solution of the matter antimatter asymmetry is based on the identification of also antimatter as dark matter.
 5. The last section of the chapter is devoted to some astrophysical and cosmological anomalies such as the apparent shrinking of solar system observed by Masreliez, Pioneer anomaly and Flyby anomaly.

Quantum Astrophysics

The vision that the quantum dynamics for dark matter is behind the formation of the visible structures suggests that the formation of the astrophysical structures could be understood as a consequence of gravitational Bohr rules. The origin of these rules has remained a little bit mysterious until the discovery that the hierarchy of Planck constants relates very closely to anyons and fractionization of quantum numbers.

1. Key element is the notion of partonic 2-surface, which for large values of Planck constant can have astrophysical size. This surface contains dark matter in anyonic many particle state if it surrounds the tip of so called causal diamond (the intersection of future and past directed light-cones). Also flux tubes surrounding the orbits of planets and other astrophysical objects containing dark matter would be connected by radial flux tubes to central anyonic 2-surface so that the entire system would be anyonic and quantum coherent in astrophysical scale. Visible matter is condensed around these dark matter structures.
2. Since space-times are 4-surfaces in $H = M^4 \times CP_2$ (or rather, its generalization to a book like structure), gravitational Bohr rules can be formulated in a manner which is general coordinate invariant and Lorentz invariant.

3. The value of the parameter v_0 appearing in gravitational Planck constant varies and this leads to a weakened form of Equivalence Principle stating that v_0 is same for given connected anyonic 2-surface, which can have very complex topology. In the case of solar system inner planets would be connected to an anyonic surface assignable to Sun and outer planets with different value of v_0 to an anyonic surface assignable to Sun and inner planets as a whole. If one accepts ruler-and-compass hypothesis for allowed values of Planck constant very powerful predictions follow.

This general conceptual framework is applied to build simple models in some concrete examples.

1. Concerning Bohr orbitology in astrophysical length scales, the basic observation is that in the case of a straight cosmic string creating a gravitational potential of form v_1^2/ρ Bohr quantization does not pose any conditions on the radii of the circular orbits so that a continuous mass distribution is possible. This situation is obviously exceptional. If one however accepts the TGD based vision that the very early cosmology was cosmic string dominated and that elementary particles were generated in the decay of cosmic strings, this situation might have prevailed at very early times. If so, the differentiation of a continuous density of ordinary matter to form the observed astrophysical structures would correspond to an approach to a stationary situation governed by Bohr rules for dark matter and in the first approximation one could neglect the intermediate stages.
2. This general picture is applied by considering some simple models for astrophysical systems involving planar structures. There are several universal predictions. Velocity spectrum is universal and only the Bohr radii depend on the choice of mass distribution. The inclusion of cosmic string implies that the system associated with the central mass is finite. Quite generally dark parts of astrophysical objects have shell like structure like atoms as do also ring like structures.
3. p-Adic length scale hypothesis provides a manner to obtain a realistic model for the central objects meaning a structure consisting of shells coming as half octaves of the basic radius: this obviously relates to Titius-Bode law. Also a simple model for planetary rings is obtained. Bohr orbits do not follow cosmic expansion which is obtained only in the average sense if phase transitions reducing the value of basic parameter v_0 occur at preferred values of cosmic time. This explains why v_0 has different values and also the decomposition of planetary system to outer and inner planets with different values of v_0 .

TGD Universe is quantum critical and quantum criticality corresponds very naturally to what has been identified as the transition region to quantum chaos.

1. The basic formulation of quantum TGD is consistent with what has been learned from the properties of quantum chaotic systems and quantum chaotic scattering. Wave functions are concentrated around Bohr orbits in the limit of quantum chaos, which is just what dark matter picture assumes.
2. The model for the emission and detection of dark gravitons allows to conclude that the transition to chaos via generation of sub-harmonics of fundamental frequency spoiling the original exact periodicity corresponds to a sequence of phase transitions in which Planck constant transforms from integer to a rational number whose denominator increases as chaos is approached. This gives a precise characterization for the phase transitions leading to quantum chaos in general.
3. In this framework the chaotic motion of astrophysical object becomes the counterpart of quantum chaotic scattering and the description in terms of classical chaos is predicted to fail. By Equivalence Principle the value of the mass of the object does not matter at all so that the motion of sufficiently light objects in solar system might be understandable only as quantum chaotic scattering. The motion of gravitationally unbound comets and rings of Saturn and Jupiter and the collisions of galactic structures known to exhibit the presence of cart-wheel like structures define possible applications.

Gravitational radiation can be emitted either in transitions between Bohr orbits or in the transitions which reduce Planck constant by increasing the velocity parameter $v_0 \leq 1$. The estimate for

the average radiation power requires an estimate for the transition time (transition rate). Quantum classical correspondence does not allow the radiation power to depend on v_0 . This fixes the expression for transition time highly uniquely, and the predicted power is of same order of magnitude as classical radiation power for both mechanisms. The radiation from Hulse-Taylor binary would be associated with $n = 3 \rightarrow 1$ transition.

The description of gravitational radiation provides a stringent test for the idea about dark matter hierarchy with arbitrary large values of Planck constants. In accordance with quantum classical correspondence, one can take the consistency with classical formulas as a constraint allowing to deduce information about how dark gravitons interact with ordinary matter. The standard facts about gravitational radiation are discussed first and then TGD based view about the situation is sketched.

What are the counterparts of Einstein's equations in TGD?

The original motivation of this work was related to Platonic solids. The playing with Einstein's equations and the attempts to interpret them physically forced the return to an old interpretational problem of TGD. TGD allows enormous vacuum degeneracy for Kähler action but the vacuum extremals are not gravitational vacua. Could this mean that TGD forces to modify Einstein's equations? Could space-time surfaces carrying energy and momentum in GRT framework be vacua in TGD context? Of course, also in GRT context cosmological constant means just this and an experimental fact, is that cosmological constant is non-vanishing albeit extremely small.

Trying to understand what is involved led to the realization that the hypothesis that preferred extremals correspond to the solutions of Einstein-Maxwell equations with cosmological constant is too restricted in the case of vacuum extremals and also in the case of standard cosmologies imbedded as vacuum extremals. What one must achieve is the vanishing of the divergence of energy momentum tensor of Kähler action expressing the local conservation of energy momentum currents. The most general analog of Einstein's equations and Equivalence Principle would be just this condition giving in GRT framework rise to the Einstein-Maxwell equations with cosmological constant.

One can however wonder whether it could be possible to find some general ansätze allowing to satisfy this condition. This kind of ansätze can be indeed found and can be written as $kG + \sum \Lambda_i P_i = T$, where Λ_i are cosmological "constants" and P_i are mutually orthogonal projectors such that each projector contribution has a vanishing divergence. One can interpret the projector contribution in terms of topologically condensed matter, whose energy momentum tensor the projectors code in the representation $kG = -\sum \Lambda_i P_i + T$. Therefore Einstein's equations with cosmological constant are generalized. This generalization is not possible in General Relativity, where Einstein's equations follow from a variational principle. This kind of ansätze can be indeed found and involve the analogs of cosmological constant, which are however not genuine constants anymore. Therefore Einstein's equations with cosmological constant are generalized. This generalization is not possible in General Relativity, where Einstein's equations follow from a variational principle.

The suggested quaternionic preferred extremals and preferred extremals involving Hamilton-Jacobi structure could be identified as different families characterized by the little group of particles involved and assignable to time-like/light-like local direction. One should prove that this ansatz works also for all vacuum extremals. This progress - if it really is progress - provides a more refined view about how TGD Universe differs from the Universe according to General Relativity and leads also to a model for how the cosmic honeycomb structure with basic unit cells having size scale 10^8 ly could be modelled in TGD framework.

1.4.3 PART III: Topological field quantization

Hydrodynamics and CP_2 geometry

The chapter begins with a brief summary of the basic notions related to many-sheeted space-time. A generalization of hydrodynamics to a p-adic hierarchy of hydrodynamics is performed and a mechanism of energy transfer between condensate levels is identified. Mary Selvam has found a fascinating connection between the distribution of primes and the distribution of vortex radii in turbulent flow in atmosphere. These observations provide new insights into p-adic length scale hypothesis and suggest that TGD based generalization of Hawking-Bekenstein law holds even in macroscopic length scales and that hydrodynamical vortices behave in some aspects like elementary particles. TGD leads to

a formulation of a general theory of phase transitions: the new element is the presence of several condensate levels.

A topological model for the generation of the hydrodynamical turbulence is proposed. The basic idea is that hydrodynamical turbulence can be regarded as a spontaneous Kähler magnetization leading to the increase the value of Kähler function and therefore of the probability of the configuration. Kähler magnetization is achieved through the formation of a vortex cascade via the decay of the mother vortex by the emission of smaller daughter vortices. Vortices with various values of the fractal quantum number and with sizes related by a discrete scaling transformation appear in the cascade. The decay of the vortices takes place via the so called phase slippage process.

An encouraging result is the prediction for the size distribution of the vortices: the prediction is practically identical with that obtained from the model of Heisenberg but on rather different physical grounds. The model is rather insensitive to the p-adic scaling of vortices in the transition as long as it is smaller than $\lambda = 2^{-5}$. The model is also consistent with the assumption that the decay of a vortex to smaller vortices corresponds to a phase transition from a given level of dark matter hierarchy to a lower level so that the value of \hbar is reduced by a factor $\lambda = v_0/n \simeq 2^{-11}/n$, $n = 1, 2, \dots$ so that Compton length scales as well as sizes of vortices are reduced by this factor.

Macroscopic quantum phenomena and CP_2 geometry

Topological field quantization is applied to a unified description of three macroscopic quantum phases: super conductors, super fluids and quantum Hall phase. The basic observation is that the formation of the join along boundaries bonds makes possible the formation of macroscopic quantum system from topological field quanta having size of the order of the coherence length ξ for ordinary phase. The presence of the bridges (join along boundaries bonds) makes possible supra flow and the presence of two levels of the topological condensate explains the two-fluid picture of super fluids. In standard physics, the order parameter is constant in the ground state. In TGD context, the non-simply connected topology of the 3-surface makes possible ground states with a covariantly constant order parameter characterized by the integers telling the change of the order parameter along closed homotopically nontrivial loops.

The role of the ordinary magnetic field in super conductivity is taken by the Z^0 magnetic field in super fluidity and the mathematical descriptions of super conductors and super fluids become practically identical. The generalization of the quantization condition for the magnetic flux to a condition involving also a velocity circulation, plays a central role in the description of both phases and suggests a new description of the rotating super fluid and some new effects. A classical explanation for the fractional Quantum Hall effect in terms of the topological field quanta is proposed. Quantum Hall phase is very similar to the supra phases: an essential role is played by the generalized quantization condition and the hydrodynamic description of the Hall electrons.

The results obtained support the view that in condensed matter systems topological field quanta with size of the order of $\xi \simeq 10^{-8} - 10^{-7}$ meters are of special importance. This new length scale is expected to have also applications to less exotic phenomena of the condensed matter physics (the description of the conductors and di-electrics and ferromagnetism) and in hydrodynamics (the failure of the hydrodynamic approximation takes place at this length scale). These field quanta of course, correspond to only one condensate level and many length scales are expected to be present.

Part I

**THE NOTION OF
MANY-SHEETED SPACE-TIME**

Chapter 2

Basic Extremals of the Kähler Action

2.1 Introduction

In this chapter the classical field equations associated with the Kähler action are studied. The study of the extremals of the Kähler action has turned out to be extremely useful for the development of TGD. Towards the end of year 2003 quite dramatic progress occurred in the understanding of field equations and it seems that field equations might be in well-defined sense exactly solvable. The progress made during next five years led to a detailed understanding of quantum TGD at the fundamental parton level and this provides considerable additional insights concerning the interpretation of field equations.

2.1.1 General considerations

The vanishing of Lorentz 4-force for the induced Kähler field means that the vacuum 4-currents are in a mechanical equilibrium. Lorentz 4-force vanishes for all known solutions of field equations which inspires the hypothesis that preferred extremals satisfy the condition. The vanishing of the Lorentz 4-force in turn implies a local conservation of the ordinary energy momentum tensor. The corresponding condition is implied by Einstein's equations in General Relativity. The hypothesis would mean that the solutions of field equations are what might be called generalized Beltrami fields. If Kähler action is defined by CP_2 Kähler form alone, the condition implies that vacuum currents can be non-vanishing only provided the dimension D_{CP_2} of the CP_2 projection of the space-time surface is less than four so that in the regions with $D_{CP_2} = 4$, Maxwell's vacuum equations are satisfied.

The hypothesis that Kähler current is proportional to a product of an arbitrary function ψ of CP_2 coordinates and of the instanton current generalizes Beltrami condition and reduces to it when electric field vanishes. Instanton current has vanishing divergence for $D_{CP_2} < 4$, and Lorentz 4-force indeed vanishes. The remaining task would be the explicit construction of the imbeddings of these fields and the demonstration that field equations can be satisfied.

Under additional conditions magnetic field reduces to what is known as Beltrami field. Beltrami fields are known to be extremely complex but highly organized structures. The natural conjecture is that topologically quantized many-sheeted magnetic and Z^0 magnetic Beltrami fields and their generalizations serve as templates for the helical molecules populating living matter, and explain both chirality selection, the complex linking and knotting of DNA and protein molecules, and even the extremely complex and self-organized dynamics of biological systems at the molecular level.

Field equations can be reduced to algebraic conditions stating that energy momentum tensor and second fundamental form have no common components (this occurs also for minimal surfaces in string models) and only the conditions stating that Kähler current vanishes, is light-like, or proportional to instanton current, remain and define the remaining field equations. The conditions guaranteeing topologization to instanton current can be solved explicitly. Solutions can be found also in the more general case when Kähler current is not proportional to instanton current. On basis of these findings there are strong reasons to believe that classical TGD is exactly solvable.

An important outcome is the notion of Hamilton-Jacobi structure meaning dual slicings of M^4

projection of preferred extremals to string world sheets and partonic 2-surfaces. The necessity of this slicing was discovered years later from number theoretic compactification and is now a key element of quantum TGD allowing to deduce Equivalence Principle in its stringy form from quantum TGD and formulate and understand quantum TGD in terms of modified Dirac action assignable to Kähler action. The conservation of Noether charges associated with modified Dirac action requires the vanishing of the second second variation of Kähler action for preferred extremals - at least for the deformations generating dynamical symmetries. Preferred extremals would thus define space-time representation for quantum criticality. Infinite-dimensional variant for the hierarchy of criticalities analogous to the hierarchy assigned to the extrema of potential function with levels labeled by the rank of the matrix defined by the second derivatives of the potential function in catastrophe theory would suggest itself.

2.1.2 In what sense field equations mimic dissipative dynamics?

By quantum classical correspondence the non-deterministic space-time dynamics should mimic the dissipative dynamics of the quantum jump sequence. The nontrivial question is what this means in TGD framework.

1. Beltrami fields appear in physical applications as asymptotic self organization patterns for which Lorentz force and dissipation vanish. This suggests that preferred extremals of Kähler action correspond to space-time sheets which at least asymptotically satisfy generalized Beltrami conditions so that one can indeed assign to the final (rather than initial!) 3-surface a unique 4-surface apart from effects related to non-determinism. Preferred extremal property of Kähler action abstracted to purely algebraic generalized Beltrami conditions would make sense also in the p-adic context. The general solution ansatz discussed in the last section of the chapter assumes that all conserved isometry currents are proportional to instanton current so that various charges are conserved separately for all flow lines: this means essentially the integrability of the theory. This ansatz is forced by the hypothesis that TGD reduces to almost topological QFT and this idea. The basic consequence is that dissipation is impossible classically.
2. A more radical view inspired by zero energy ontology is that the light-like 3-surfaces and corresponding space-time regions with Euclidian signature defining generalized Feynman diagrams provide a space-time representation of dissipative dynamics just as they provide this representation in quantum field theory. Minkowskian regions would represent empty space so that the vanishing of Lorentz 4-force and absence of dissipation would be natural. This would mean very precise particle field duality and the topological pattern associated with the generalized Feynman diagram would represent dissipation. One could also interpret dissipation as transfer of energy between sheets of the many-sheeted space time and thus as an essentially topological phenomenon. This option seems to be the only viable one.

2.1.3 The dimension of CP_2 projection as classifier for the fundamental phases of matter

The dimension D_{CP_2} of CP_2 projection of the space-time sheet encountered already in p-adic mass calculations classifies the fundamental phases of matter. For $D_{CP_2} = 4$ empty space Maxwell equations hold true. The natural guess would be that this phase is chaotic and analogous to de-magnetized phase. $D_{CP_2} = 2$ phase is analogous to ferromagnetic phase: highly ordered and relatively simple. It seems however that preferred extremals can correspond only to small perturbations of these extremals resulting by topological condensation of CP_2 type vacuum extremals and through topological condensation to larger space-time sheets. $D_{CP_2} = 3$ is the analog of spin glass and liquid crystal phases, extremely complex but highly organized by the properties of the generalized Beltrami fields. This phase could be seen as the boundary between chaos and order and corresponds to life emerging in the interaction of magnetic bodies with bio-matter. It is possible only in a finite temperature interval (note however the p-adic hierarchy of critical temperatures) and characterized by chirality just like life.

The original proposal was that $D(CP_2) = 4$ phase is completely chaotic. This is not true if the reduction to almost topological QFT takes place. This phase must correspond to Maxwellian phase with a vanishing Kähler current as concluded already earlier. Various isometry currents are however

proportional to the instanton current and conserved along the flow lines of the instanton current whose flow parameter extends to a global coordinate. Hence a completely chaotic phase is not in question even in this case.

2.1.4 Specific extremals of Kähler action

The study of extremals of Kähler action represents more than decade old layer in the development of TGD.

1. The huge vacuum degeneracy is the most characteristic feature of Kähler action (any 4-surface having CP_2 projection which is Legendre sub-manifold is vacuum extremal, Legendre sub-manifolds of CP_2 are in general 2-dimensional). This vacuum degeneracy is behind the spin glass analogy and leads to the p-adic TGD. As found in the second part of the book, various particle like vacuum extremals also play an important role in the understanding of the quantum TGD.
2. The so called CP_2 type vacuum extremals have finite, negative action and are therefore an excellent candidate for real particles whereas vacuum extremals with vanishing Kähler action are candidates for the virtual particles. These extremals have one dimensional M^4 projection, which is light like curve but not necessarily geodesic and locally the metric of the extremal is that of CP_2 : the quantization of this motion leads to Virasoro algebra. Space-times with topology $CP_2 \# CP_2 \# \dots CP_2$ are identified as the generalized Feynmann diagrams with lines thickened to 4-manifolds of "thickness" of the order of CP_2 radius. The quantization of the random motion with light velocity associated with the CP_2 type extremals in fact led to the discovery of Super Virasoro invariance, which through the construction of the configuration space geometry, becomes a basic symmetry of quantum TGD.
3. There are also various non-vacuum extremals.
 - (a) String like objects, with string tension of same order of magnitude as possessed by the cosmic strings of GUTs, have a crucial role in TGD inspired model for the galaxy formation and in the TGD based cosmology.
 - (b) The so called massless extremals describe non-linear plane waves propagating with the velocity of light such that the polarization is fixed in given point of the space-time surface. The purely TGD:ish feature is the light like Kähler current: in the ordinary Maxwell theory vacuum gauge currents are not possible. This current serves as a source of coherent photons, which might play an important role in the quantum model of bio-system as a macroscopic quantum system.
 - (c) In the so called Maxwell's phase, ordinary Maxwell equations for the induced Kähler field are satisfied in an excellent approximation. A special case is provided by a radially symmetric extremal having an interpretation as the space-time exterior to a topologically condensed particle. The sign of the gravitational mass correlates with that of the Kähler charge and one can understand the generation of the matter antimatter asymmetry from the basic properties of this extremal. The possibility to understand the generation of the matter antimatter asymmetry directly from the basic equations of the theory gives strong support in favor of TGD in comparison to the ordinary EYM theories, where the generation of the matter antimatter asymmetry is still poorly understood.

2.1.5 The weak form of electric-magnetic duality and modification of Kähler action

The newest results discussed in the last section about the weak form of electric-magnetic duality suggest strongly that Beltrami property is general and together with the weak form of electric-magnetic duality allows a reduction of quantum TGD to almost topological field theory with Kähler function allowing expression as a Chern-Simons term.

Generalized Beltrami property leads to a rather explicit construction of the general solution of field equations based on the hydrodynamic picture implying that single particle quantum numbers are

conserved along flow lines defined by the instanton current. The construction generalizes also to the fermionic sector and there are reasons to hope that TGD is completely integrable theory.

2.2 General considerations

The solution families of field equations studied in this chapter were found already during eighties. The physical interpretation turned out to be the really tough problem. What is the principle selecting preferred extremals of Kähler action as analogs of Bohr orbits assigning to 3-surface X^3 a unique space-time surface $X^4(X^3)$? Does Equivalence Principle hold true and if so, in what sense? These have been the key questions. The realization that light-like 3-surfaces X_l^3 associated with the light-like wormhole throats at which the signature of the induced metric changes from Minkowskian to Euclidian led to the formulation of quantum TGD in terms of second quantized induced spinor fields at these surfaces. Together with the notion of number theoretical compactification this approach allowed to identify the conditions characterizing the preferred extremals. What is remarkable that these conditions are consistent with what is known about extremals. Also a connection with string models and understanding of the space-time realization of Equivalence Principle emerged. In this section the theoretical background behind field equations is briefly summarized. I will not repeat the discussion of previous two chapters [K35, K36] summarizing the general vision about many-sheeted space-time, and consideration will be restricted to those aspects of vision leading to direct predictions about the properties of preferred extremals of Kähler action.

2.2.1 Number theoretical compactification and $M^8 - H$ duality

The notion of hyper-quaternionic and octonionic manifold makes sense but it not plausible that $H = M^4 \times CP_2$ could be endowed with a hyper-octonionic manifold structure. Situation changes if H is replaced with hyper-octonionic M^8 . Suppose that $X^4 \subset M^8$ consists of hyper-quaternionic and co-hyper-quaternionic regions. The basic observation is that the hyper-quaternionic sub-spaces of M^8 with a fixed hyper-complex structure (containing in their tangent space a fixed hyper-complex subspace M^2 or at least one of the light-like lines of M^2) are labeled by points of CP_2 . Hence each hyper-quaternionic and co-hyper-quaternionic four-surface of M^8 defines a 4-surface of $M^4 \times CP_2$. One can loosely say that the number-theoretic analog of spontaneous compactification occurs: this of course has nothing to do with dynamics.

This picture was still too naive and it became clear that not all known extremals of Kähler action contain fixed $M^2 \subset M^4$ or light-like line of M^2 in their tangent space.

1. The first option represents the minimal form of number theoretical compactification. M^8 is interpreted as the tangent space of H . Only the 4-D tangent spaces of light-like 3-surfaces X_l^3 (wormhole throats or boundaries) are assumed to be hyper-quaternionic or co-hyper-quaternionic and contain fixed M^2 or its light-like line in their tangent space. Hyper-quaternionic regions would naturally correspond to space-time regions with Minkowskian signature of the induced metric and their co-counterparts to the regions for which the signature is Euclidian. What is of special importance is that this assumption solves the problem of identifying the boundary conditions fixing the preferred extremals of Kähler action since in the generic case the intersection of M^2 with the 3-D tangent space of X_l^3 is 1-dimensional. The surfaces $X^4(X_l^3) \subset M^8$ would be hyper-quaternionic or co-hyper-quaternionic but would not allow a local mapping between the 4-surfaces of M^8 and H .
2. One can also consider a more local map of $X^4(X_l^3) \subset H$ to $X^4(X_l^3) \subset M^8$. The idea is to allow $M^2 \subset M^4 \subset M^8$ to vary from point to point so that $S^2 = SO(3)/SO(2)$ characterizes the local choice of M^2 in the interior of X^4 . This leads to a quite nice view about strong geometric form of $M^8 - H$ duality in which M^8 is interpreted as tangent space of H and $X^4(X_l^3) \subset M^8$ has interpretation as tangent for a curve defined by light-like 3-surfaces at X_l^3 and represented by $X^4(X_l^3) \subset H$. Space-time surfaces $X^4(X_l^3) \subset M^8$ consisting of hyper-quaternionic and co-hyper-quaternionic regions would naturally represent a preferred extremal of E^4 Kähler action. The value of the action would be same as CP_2 Kähler action. $M^8 - H$ duality would apply also at the induced spinor field and at the level of configuration space. The possibility to assign $M^2(x) \subset M^4$ to each point of M^4 projection $P_{M^4}(X^4(X_l^3))$ is consistent with what is known

about extremals of Kähler action with only one exception: CP_2 type vacuum extremals. In this case M^2 can be assigned to the normal space.

3. Strong form of $M^8 - H$ duality satisfies all the needed constraints if it represents Kähler isometry between $X^4(X_l^3) \subset M^8$ and $X^4(X_l^3) \subset H$. This implies that light-like 3-surface is mapped to light-like 3-surface and induced metrics and Kähler forms are identical so that also Kähler action and field equations are identical. The only differences appear at the level of induced spinor fields at the light-like boundaries since due to the fact that gauge potentials are not identical.
4. The map of $X_l^3 \subset H \rightarrow X_l^3 \subset M^8$ would be crucial for the realization of the number theoretical universality. $M^8 = M^4 \times E^4$ allows linear coordinates as those preferred coordinates in which the points of imbedding space are rational/algebraic. Thus the point of $X^4 \subset H$ is algebraic if it is mapped to algebraic point of M^8 in number theoretic compactification. This of course restricts the symmetry groups to their rational/algebraic variants but this does not have practical meaning. Number theoretical compactification could thus be motivated by the number theoretical universality.
5. The possibility to use either M^8 or H picture might be extremely useful for calculational purposes. In particular, M^8 picture based on $SO(4)$ gluons rather than $SU(3)$ gluons could perturbative description of low energy hadron physics. The strong $SO(4)$ symmetry of low energy hadron physics can be indeed seen direct experimental support for the $M^8 - H$ duality.

Number theoretical compactification has quite deep implications for quantum TGD and is actually responsible for most of the progress in the understanding of the mathematical structure of quantum TGD. A very powerful prediction is that preferred extremals should allow slicings to either stringy world sheets or dual partonic 2-surfaces as well as slicing by light-like 3-surfaces. Both predictions are consistent with what is known about extremals.

1. If the distribution of planes $M^2(x)$ is integrable, it is possible to slice $X^4(X^3)$ to a union of 2-dimensional surfaces having interpretation as string world sheets and dual 2-dimensional copies of partonic surfaces X^2 . This decomposition defining 2+2 Kaluza-Klein type structure realizes quantum gravitational holography and allows to understand Equivalence Principle at space-time level in the sense that dimensional reduction defined by the integral of Kähler action over the 2-dimensional space labeling stringy world sheets gives rise to the analog of stringy action and one obtains string model like description of quantum TGD as dual for a description based on light-like partonic 3-surfaces. String tension is not however equal to the inverse of gravitational constant as one might naively expect but the connection is more delicate.
2. Second implication is the slicing of $X^4(X_l^3)$ to light-like 3-surfaces Y_l^3 "parallel" to X_l^3 . Also this slicing realizes quantum gravitational holography if one requires General Coordinate Invariance in the sense that the Dirac determinant defined by the generalized eigenvalues of the transverse part $D_K(X^2)$ of D_K differs for two 3-surfaces Y_l^3 in the slicing only by an exponent of a real part of a holomorphic function of configuration space complex coordinates giving no contribution to the Kähler metric. The requirement that the zero modes of the 4-D modified Dirac operators D_K reduce to the analogs of 3-D shock waves for all 3-surfaces Y_l^3 in the slicing requires that Noether currents are parallel to Y_l^3 . Clearly, 3+1 type Kaluza-Klein structure is in question. This slicing allows to realize RG flow at space-time level using the light-like coordinate associated with the slicing as RG parameter [K36]. The prediction is RG invariance of couplings for a causal diamond (CD) in given p-adic length scale meaning a justification of the hypothesis that coupling constant evolution reduces to a discrete p-adic coupling constant evolution with p-adic length scales coming as half octaves. This prediction follows if the known properties of extremals of Kähler action hold true quite generally.
3. The assumption that Kähler current and other gauge currents flow along the slices Y_l^3 of the slicing of $X^4(X_l^3)$ is enough for the renormalization group invariance of gauge couplings inside CD guaranteeing p-adic coupling constant evolution [K36]. The current could thus have also a component parallel to the transverse cross section in which case the current would be space-like. Space-likeness brings in mind the Euclidian signature of the effective metric defined by the modified gamma matrices $\hat{\Gamma}^\alpha = (\partial L_K / \partial h_\alpha^k) \gamma^k$ necessary for the Higgs mechanism. Dissipation

would be absent but Lorentz force would be non-vanishing. The general solution ansatz for the field equations allows besides light-like Kähler currents also space-like gauge currents, which can be regarded as topological currents. The gluing of CP_2 type vacuum extremals to the known extremals with light-like gauge currents could generate the transversal part of the currents and increase the dimension D_{CP_2} of the CP_2 projection to at least $D_{CP_2} = 3$.

2.2.2 The exponent of Kähler function as Dirac determinant for the modified Dirac action

Although quantum criticality in principle predicts the possible values of Kähler coupling strength, one might hope that there exists even more fundamental approach involving no coupling constants and predicting even quantum criticality and realizing quantum gravitational holography.

The identification of the light-like partonic 3-surfaces as carriers of elementary particle quantum numbers inspired by the TGD based quantum measurement theory suggests the identification of the modified Dirac action as that associated with the Chern-Simons action for the induced Kähler gauge potential. It however turned out that it is 4-D modified Dirac action associated with Kähler action, which is the correct choice. The point is that only the solutions of D_K which are effectively 3-dimensional by generalized super-conformal gauge invariance are physical. The effective metric defined by the modified gamma matrices is non-singular even for light-like 3-surfaces Y_l^3 , and this allows to develop a well-defined theory involving also metric degrees of freedom. In this framework $C - S$ action emerges as a phase factor of quantum states for phases with non-standard value of Planck constant and is related to anyons and charge fractionization.

Absolutely essential role is played by number theoretical compactification predicted that space-time sheets have dual slicings to string world sheets and partonic 2-surfaces. This prediction is supported by the properties of known extremals of Kähler action. This allows the decompositions $D_K = D_K(Y^2) + D_K(X^2)$ generalized eigenvalues can be associated associated with $D_K(X^2)$ for zero modes of D_K .

1. The Dirac determinant defined by the product of Dirac determinants associated with the light-like partonic 3-surfaces X_l^3 associated with a given space-time sheet X^4 is the simplest candidate for vacuum functional identifiable as the exponent of the Kähler function. One can of course worry about the finiteness of the Dirac determinant. p-Adicization requires that the eigenvalues belong to a given algebraic extension of rationals. This restriction would imply a hierarchy of physics corresponding to different extensions and could automatically imply the finiteness and algebraic number property of the Dirac determinants if only finite number of eigenvalues would contribute. The regularization would be performed by physics itself if this were the case.
- 2.
3. The basic problem has been how to feed in the information about the preferred extremal of Kähler action to the eigenvalue spectrum $D_K(X^2)$ at light-like 3-surface X_l^3 . The identification of the preferred extremal came possible via boundary conditions at X_l^3 dictated by number theoretical compactification. The basic observation is that the Dirac equation associated with the 4-D Dirac operator D_K defined by Kähler action can be seen as a conservation law for a super current. By restricting the super current to flow along X_l^3 by requiring that its normal component vanishes, one obtains a singular solution of 4-D modified Dirac equation restricted to X_l^3 . The "energy" spectrum to the spectrum of eigenvalues for $D_K(X^2)$ and the product of the eigenvalues defines the Dirac determinant in standard manner. Since the eigenmodes are restricted to those localized to regions of non-vanishing induced Kähler form, the number of eigen modes is finite and therefore also Dirac determinant is finite. The eigenvalues can be also algebraic numbers.
4. It remains to be proven that the product of eigenvalues gives rise to the exponent of Kähler action for the preferred extremal of Kähler action. At this moment the only justification for the conjecture is that this the only thing that one can imagine.
5. An additional bonus is precise definition of quantum criticality. The Noether currents associated with the modified Dirac action are conserved if its variation with respect to H -coordinates

vanishes. This means that the second variation of Kähler action varies. One can consider also a weaker form of quantum criticality in which case only the variations with respect to deformations defining the conserved currents are vanishing. This would give to a hierarchy of criticalities defined by the second variations of Kähler action. The vacuum degeneracy of Kähler action would be essential for the realization of quantum criticality and could correspond to a hierarchy of dynamical gauge symmetries characterizing finite measurement resolution suggested by the hierarchy of Jones inclusions [K30].

6. A long-standing conjecture has been that the zeros of Riemann Zeta are somehow relevant for quantum TGD. Riemann zeta is however naturally replaced Dirac zeta defined by the eigenvalues of $D_K(X^2)$ and closely related to Riemann Zeta since the spectrum consists essentially for the cyclotron energy spectra for localized solutions region of non-vanishing induced Kähler magnetic field and hence is in good approximation integer valued up to some cutoff integer. In zero energy ontology the Dirac zeta function associated with these eigenvalues defines "square root" of thermodynamics assuming that the energy levels of the system in question are expressible as logarithms of the eigenvalues of the modified Dirac operator defining kind of fundamental constants. Critical points correspond to approximate zeros of Dirac zeta and if Kähler function vanishes at criticality as it indeed should, the thermal energies at critical points are in first order approximation proportional to zeros themselves so that a connection between quantum criticality and approximate zeros of Dirac zeta emerges.
7. The discretization induced by the number theoretic braids reduces the world of classical worlds to effectively finite-dimensional space and configuration space Clifford algebra reduces to a finite-dimensional algebra. The interpretation is in terms of finite measurement resolution represented in terms of Jones inclusion $\mathcal{M} \subset \mathcal{N}$ of HFFs with \mathcal{M} taking the role of complex numbers. The finite-D quantum Clifford algebra spanned by fermionic oscillator operators is identified as a representation for the coset space \mathcal{N}/\mathcal{M} describing physical states modulo measurement resolution. In the sectors of generalized imbedding space corresponding to non-standard values of Planck constant quantum version of Clifford algebra is in question.

Concerning the understanding of preferred extremals, the basic prediction (assuming that Kähler gauge potential has no gauge part in M^4) is that the CP_2 projection of the light-like 3-surfaces is 3-dimensional for non-vacuum partons. One implication is that a very general family of cosmic string type solutions with 2-D CP_2 projection cannot correspond to preferred extremals. If ideal cosmic strings were preferred extremals, the most general realization for the hierarchy of Planck constants in terms of a book like structure of the imbedding space would not be possible [K30]. Also massless extremals have 2-D CP_2 projection and are excluded as preferred extremals. The interpretation is that the preferred extremals must be deformations of these extremals containing topologically condensed CP_2 type vacuum extremals representing elementary particles and that these extremals provide only smoothed out representation of the actual physics. The general principle would be that matter is present only if light-like 3-surfaces at which the signature of the induced metric changes (light-like boundary components cannot be excluded but in this case gauge charges would vanish). That the interaction with a larger Minkowskian space-time sheet creates matter could be seen as a variant of Mach Principle.

2.2.3 Preferred extremal property as classical correlate for quantum criticality, holography, and quantum classical correspondence

The Noether currents assignable to the modified Dirac equation are conserved only if the first variation of the modified Dirac operator D_K defined by Kähler action vanishes. This is equivalent with the vanishing of the second variation of Kähler action -at least for the variations corresponding to dynamical symmetries having interpretation as dynamical degrees of freedom which are below measurement resolution and therefore effectively gauge symmetries. The weaker condition would mean that the inner product defined by the integral of $D_\alpha \partial L_K / \partial h_\alpha^k \delta h^k$ over the space-time surface vanishes for the deformations defining dynamical symmetries but the field equations are not satisfied completely generally. The weaker condition would mean that the inner product defined by the integral of $D_\alpha \partial L_K / \partial h_\alpha^k \delta h^k$ over the space-time surface vanishes for the deformations defining dynamical symmetries but the field equations are not satisfied completely generally.

The vanishing of the second variation in interior of $X^4(X_l^3)$ is what corresponds exactly to quantum criticality so that the basic vision about quantum dynamics of quantum TGD would lead directly to a precise identification of the preferred extremals. Something which I should have noticed for more than decade ago! The question whether these extremals correspond to absolute minima remains however open.

The vanishing of second variations of preferred extremals -at least for deformations representing dynamical symmetries, suggests a generalization of catastrophe theory of Thom, where the rank of the matrix defined by the second derivatives of potential function defines a hierarchy of criticalities with the tip of bifurcation set of the catastrophe representing the complete vanishing of this matrix. In the recent case this theory would be generalized to infinite-dimensional context. There are three kind of variables now but quantum classical correspondence (holography) allows to reduce the types of variables to two.

1. The variations of $X^4(X_l^3)$ vanishing at the intersections of $X^4(X_l^3)$ with the light-like boundaries of causal diamonds CD would represent behavior variables. At least the vacuum extremals of Kähler action would represent extremals for which the second variation vanishes identically (the "tip" of the multi-furcation set).
2. The zero modes of Kähler function would define the control variables interpreted as classical degrees of freedom necessary in quantum measurement theory. By effective 2-dimensionality (or holography or quantum classical correspondence) meaning that the configuration space metric is determined by the data coming from partonic 2-surfaces X^2 at intersections of X_l^3 with boundaries of CD , the interiors of 3-surfaces X^3 at the boundaries of CD s in rough sense correspond to zero modes so that there is indeed huge number of them. Also the variables characterizing 2-surface, which cannot be complexified and thus cannot contribute to the Kähler metric of configuration space represent zero modes. Fixing the interior of the 3-surface would mean fixing of control variables. Extremum property would fix the 4-surface and behavior variables if boundary conditions are fixed to sufficient degree.
3. The complex variables characterizing X^2 would represent third kind of variables identified as quantum fluctuating degrees of freedom contributing to the configuration space metric. Quantum classical correspondence requires 1-1 correspondence between zero modes and these variables. This would be essentially holography stating that the 2-D "causal boundary" X^2 of $X^3(X^2)$ codes for the interior. Preferred extremal property identified as criticality condition would realize the holography by fixing the values of zero modes once X^2 is known and give rise to the holographic correspondence $X^2 \rightarrow X^3(X^2)$. The values of behavior variables determined by extremization would fix then the space-time surface $X^4(X_l^3)$ as a preferred extremal.
4. Clearly, the presence of zero modes would be absolutely essential element of the picture. Quantum criticality, quantum classical correspondence, holography, and preferred extremal property would all represent more or less the same thing. One must of course be very cautious since the boundary conditions at X_l^3 involve normal derivative and might bring in delicacies forcing to modify the simplest heuristic picture.

The basic question is whether number theoretic view about preferred extremals imply absolute minimization or something analogous to it.

1. The number theoretic conditions defining preferred extremals are purely algebraic and make sense also p-adically and this is enough since p-adic variants of field equations make sense although the notion of Kähler action does not make sense as integral. Despite this the identification of the vacuum functional as exponent of Kähler function as Dirac determinant allows to define the exponent of Kähler function as a p-adic number [K19] .
2. The general objection against all extremization principles is that they do not make sense p-adically since p-adic numbers are not well-ordered.
3. These observations do not encourage the idea about equivalence of the two approaches. On the other hand, real and p-adic sectors are related by algebraic continuation and it could be quite enough if the equivalence were true in real context alone.

The finite-dimensional analogy allows to compare absolute minimization and criticality with each other.

1. Absolute minimization would select the branch of Thom's catastrophe surface with the smallest value of potential function for given values of control variables. In general this value would not correspond to criticality since absolute minimization says nothing about the values of control variables (zero modes).
2. Criticality forces the space-time surface to belong to the bifurcation set and thus fixes the values of control variables, that is the interior of 3-surface assignable to the partonic 2-surface, and realized holography. If the catastrophe has more than $N = 3$ sheets, several preferred extremals are possible for given values of control variables fixing $X^3(X^2)$ unless one assumes that absolute minimization or some other criterion is applied in the bifurcation set. In this sense absolute minimization might make sense in the real context and if the selection is between finite number of alternatives is in question, it should be possible carry out the selection in number theoretically universal manner.

2.2.4 Can one determine experimentally the shape of the space-time surface?

The question 'Can one determine experimentally the shape of the space-time surface?' does not relate directly to the topic of this chapter in technical sense, and the only excuse for its inclusion is the title of this section plus the fact that the general conceptual framework behind quantum TGD assumes an affirmative answer to this question. If physics were purely classical physics, operationalism in the strong sense of the word would require that one can experimentally determine the shape of the space-time as a surface of the imbedding space with arbitrary accuracy by measuring suitable classical observables. In quantum physics situation is considerably more complex and quantum effects are both a blessing and a curse.

Measuring classically the shape of the space-time surface

Consider first the purely classical situation to see what is involved.

1. All classical gauge fields are expressible in terms of CP_2 coordinates and their space-time gradients so that the measurement of four field quantities with some finite resolution in some space-time volume could in principle give enough information to deduce the remaining field quantities. The requirement that space-time surface corresponds to an extremal of Kähler action gives a further strong consistency constraint and one can in principle test whether this constraint is satisfied. A highly over-determined system is in question.
2. The freedom to choose the space-time coordinates freely causes complications and it seems that one must be able to determine also the distances between the points at which the field quantities are determined. At purely classical Riemannian level this boils down to the measurement of the induced metric defining classical gravitational field. In macroscopic length scales one could base the approach to iterative procedure in which one starts from the assumption that the coordinates used are Minkowski coordinates and gravitational corrections are very weak.
3. The measurement of induced Kähler form in some space-time volume determines space-time surface only modulo canonical transformations of CP_2 and isometries of the imbedding space. If one measures classical electromagnetic field, which is not canonical invariant in general case, with some precision, one can determine to what kind of surface space-time region corresponds apart from the action of the isometries of H .

Quantum measurement of the shape of the space-time surface

In practice the measurement of the shape of the space-time surface is necessarily a bootstrap procedure based on the model for space-time region and on the requirement of internal consistency. Many-sheeted space-time and quantum phenomena produce considerable complications but also provide universal measurement standards.

Consider first how quantum effects could help to measure classical fields and distances.

1. The measurement of distances by measuring first induced metric at each point of space-time sheet is rather unpractical procedure. Many-sheeted space-time however comes in rescue here. p-Adic length scale hypothesis provides a hierarchy of natural length scales and one can use p-adic length and time scales as natural units of length and time: space-time sheets serve as meter sticks. For instance, length measurement reduces in principle to a finite number of operations using various space-time sheets with standardized lengths given by p-adic length scales. Also various transition frequencies and corresponding wavelengths provide universal time and length units. Atomic clock provides a standard example of this kind of time unit. A highly nontrivial implication is the possibility to deduce the composition of distant star from its spectral lines. Without p-adic length scale hypothesis the scales for the mass spectra of the elementary particles would be variable and atomic spectra would vary from point to point in TGD universe.

Do the p-adic length scales correspond to the length units of the induced metric or of M_+^4 metric? If the topological condensation a meter stick space-time sheet at a larger space-time sheet does not stretch the meter stick but only bends it, the length topologically condensed meter stick in the induced metric equals to its original length measured using M_+^4 metric.

2. If superconducting order parameters are expressible in terms of the CP_2 coordinates (there is evidence for this, see the chapter "Macroscopic quantum phenomena and CP_2 geometry"), one might determine directly the CP_2 coordinates as functions of Minkowski coordinates and this would allow to estimate all classical fields directly and thus to deduce strong consistency constraints.
3. At quantum level only the fluxes of the classical fields through surface areas with some minimum size determined by the length scale resolution can be measured. In case of magnetic fields the quantization of the magnetic flux simplifies the situation dramatically. Topological field quantization quite generally modifies the measurement of continuous field variables to the measurement of fluxes. Interestingly, the construction of the configuration space geometry uses as configuration space coordinates various electric and magnetic fluxes over 2-dimensional cross sections of 3-surface.

Quantum effects introduce also difficulties and restrictions.

1. Canonical transformations localized with respect to the boundary of the light cone or more general light like surfaces act as isometries of the configuration space and one can determine the space-time surface only modulo these isometries. Even more, only the values of the non-quantum fluctuating zero modes characterizing the shape and size of the space-time surface are measurable with arbitrary precision in quantum theory. At the level of conscious experience quantum fluctuating degrees of freedom correspond to sensory qualia like color having no classical geometric content.
2. Space-time surface is replaced by a new one in each quantum jump (or rather the superposition of perceptively equivalent space-time surfaces). Only in the approximation that the change of the space-time region in single quantum jump is negligible, the measurement of the shape of space-time surface makes sense. The physical criterion for this is that dissipation is negligible. The change of the space-time region in single quantum jump can indeed be negligible if the measurement is performed with a finite resolution.
3. Conscious experience of self is an average over quantum jumps defining moments of consciousness. In particular, only the average increment of the zero modes is experienced and this means that one cannot fix the space-time surface apart from canonical transformation affecting the zero modes. Again the notion of measurement resolution comes in rescue.
4. The possibility of coherent states of photons and gravitons brings in a further quantum complication since the effective classical em and gravitational fields are superpositions of classical field and the order parameter describing the coherent state. In principle the extremely strong constraints between the classical field quantities allow to measure both the order parameters of the coherent phases and classical fields.

Quantum holography and the shape of the space-time surface

If the Dirac determinant associated with the generalized eigenvalue spectrum of the modified Dirac operator $D_K(X^2)$ indeed codes for Kähler action of a preferred extremal, it is fair to say that a lot of information about the shape of the space-time surface is coded to physical observables, which eigenvalues indeed represent. Quantum gravitational holography due to the Bohr orbit like character of space-time surface reduces the amount of information needed. Only a finite number of eigenvalues is involved and the eigen modes are associated with the 3-D light-like wormhole throats rather than with the space-time surface itself. If the eigenvalues were known or could be measured with infinite accuracy, one could in principle fix the boundary conditions at X_l^3 and solve field equations determining the preferred extremal of Kähler action.

What is of course needed is the complete knowledge of the light-like 3-surfaces X_l^3 . Needless to say, in practice a complete knowledge of X_l^3 is impossible since measurement resolution is finite. The notion number theoretic braid provides a precise realization for the finite measurement accuracy at space-time level. At the level of configuration space spinors fields (world of classical worlds) just the fact that the number of eigenvalues is finite is correlate for the finite measurement accuracy. Furthermore, quantum states are actually quantum superpositions of 3-surfaces, which means that one can only speak about quantum average space-time surface for which the phase factors coding for the quantum numbers of elementary particles assigned to the strands of number theoretic braids are stationary so that correlation of classical gauge charges with quantum gauge charges is obtained.

2.3 General view about field equations

In this section field equations are deduced and discussed in general level. The fact that the divergence of the energy momentum tensor, Lorentz 4-force, does not vanish in general, in principle makes possible the mimicry of even dissipation and of the second law. For asymptotic self organization patterns for which dissipation is absent the Lorentz 4-force must vanish. This condition is guaranteed if Kähler current is proportional to the instanton current in the case that CP_2 projection of the space-time sheet is smaller than four and vanishes otherwise. An attractive identification for the vanishing of Lorentz 4-force is as a condition equivalent with the selection of preferred extremal of Kähler action. If preferred extremals correspond to absolute minima this principle would be essentially equivalent with the second law of thermodynamics.

2.3.1 Field equations

The requirement that Kähler action is stationary leads to the following field equations in the interior of the four-surface

$$\begin{aligned} D_\beta(T^{\alpha\beta}h_\alpha^k) - j^\alpha J_l^k \partial_\alpha h^l &= 0 \ , \\ T^{\alpha\beta} &= J^{\nu\alpha} J_\nu^\beta - \frac{1}{4} g^{\alpha\beta} J^{\mu\nu} J_{\mu\nu} \ . \end{aligned} \quad (2.3.1)$$

Here $T^{\alpha\beta}$ denotes the traceless canonical energy momentum tensor associated with the Kähler action. An equivalent form for the first equation is

$$\begin{aligned} T^{\alpha\beta} H_{\alpha\beta}^k - j^\alpha (J_\alpha^\beta h_\beta^k + J_l^k \partial_\alpha h^l) &= 0 \ . \\ H_{\alpha\beta}^k &= D_\beta \partial_\alpha h^k \ . \end{aligned} \quad (2.3.2)$$

$H_{\alpha\beta}^k$ denotes the components of the second fundamental form and $j^\alpha = D_\beta J^{\alpha\beta}$ is the gauge current associated with the Kähler field.

On the boundaries of X^4 and at wormhole throats the field equations are given by the expression

$$\frac{\partial L_K}{\partial_n h^k} = T^{n\beta} \partial_\beta h^k - J^{n\alpha} (J_\alpha^\beta \partial_\beta h^k + J_l^k \partial_\alpha h^l) = 0 \ . \quad (2.3.3)$$

At wormhole throats problems are caused by the vanishing of metric determinant implying that contravariant metric is singular.

For M^4 coordinates boundary conditions are satisfied if one assumes

$$T^{n\beta} = 0 \quad (2.3.4)$$

stating that there is no flow of four-momentum through the boundary component or wormhole throat. This means that there is no energy exchange between Euclidian and Minkowskian regions so that Euclidian regions provide representations for particles as autonomous units. This is in accordance with the general picture [K36]. Note that momentum transfer with external world necessarily involves generalized Feynman diagrams also at classical level.

For CP_2 coordinates the boundary conditions are more delicate. The construction of configuration space spinor structure [K19] led to the conditions

$$g_{ni} = 0, \quad J_{ni} = 0. \quad (2.3.5)$$

$J^{ni} = 0$ does not and should not follow from this condition since contravariant metric is singular. It seems that limiting procedure is necessary in order to see what comes out.

The condition that Kähler electric charge defined as a gauge flux is non-vanishing would require that the quantity $J^{nr}\sqrt{g}$ is finite (here r refers to the light-like coordinate of X_l^3). Also $g^{nr}\sqrt{g_4}$ which is analogous to gravitational flux if n is interpreted as time coordinate could be non-vanishing. These conditions are consistent with the above condition if one has

$$\begin{aligned} J_{ni} = 0, \quad g_{ni} = 0, \quad J_{ir} = 0, \quad g_{ir} = 0, \\ J^{nk} = 0 \quad k \neq r, \quad g^{nk} = 0 \quad k \neq r, \quad J^{nr}\sqrt{g_4} \neq 0, \quad g^{nr}\sqrt{g_4} \neq 0. \end{aligned} \quad (2.3.6)$$

The interpretation of this conditions is rather transparent.

1. The first two conditions state that covariant form of the induced Kähler electric field is in direction normal to X_l^3 and metric separate into direct sum of normal and tangential contributions. Fifth and sixth condition state the same in contravariant form for $k \neq n$.
2. Third and fourth condition state that the induced Kähler field at X_l^3 is purely magnetic and that the metric of x_l^3 reduces to a block diagonal form. The reduction to purely magnetic field is of obvious importance as far as the understanding of the generalized eigen modes of the modified Dirac operator is considered [K19].
3. The last two conditions must be understood as a limit and \neq means only the possibility of non-vanishing Kähler gauge flux or analog of gravitational flux through X_l^3 .
4. The vision inspired by number theoretical compactification allows to identify r and n in terms of the light-like coordinates assignable to an integrable distribution of planes $M^2(x)$ assumed to be assignable to M^4 projection of $X^4(X_l^3)$. Later it will be found that Hamilton-Jacobi structure assignable to the extremals indeed means the existence of this kind of distribution meaning slicing of $X^4(X_l^3)$ both by string world sheets and dual partonic 2-surfaces as well as by light-like 3-surfaces Y_l^3 .
5. The physical analogy for the situation is the surface of an ideal conductor. It would not be surprising that these conditions are satisfied by all induced gauge fields.

2.3.2 Topologization and light-likeness of the Kähler current as alternative manners to guarantee vanishing of Lorentz 4-force

The general solution of 4-dimensional Einstein-Yang Mills equations in Euclidian 4-metric relies on self-duality of the gauge field, which topologizes gauge charge. This topologization can be achieved by a weaker condition, which can be regarded as a dynamical generalization of the Beltrami condition. An alternative manner to achieve vanishing of the Lorentz 4-force is light-likeness of the Kähler 4-current. This does not require topologization.

Topologization of the Kähler current for $D_{CP_2} = 3$: covariant formulation

The condition states that Kähler 4-current is proportional to the instanton current whose divergence is instanton density and vanishes when the dimension of CP_2 projection is smaller than four: $D_{CP_2} < 4$. For $D_{CP_2} = 2$ the instanton 4-current vanishes identically and topologization is equivalent with the vanishing of the Kähler current.

If the simplest vision about light-like 3-surfaces as basic dynamical objects is accepted $D_{CP_2} = 2$, corresponds to a non-physical situation and only the deformations of these surfaces - most naturally resulting by gluing of CP_2 type vacuum extremals on them - can represent preferred extremals of Kähler action. One can however speak about $D_{CP_2} = 2$ phase if 4-surfaces are obtained are obtained in this manner.

$$j^\alpha \equiv D_\beta J^{\alpha\beta} = \psi \times j_I^\alpha = \psi \times \epsilon^{\alpha\beta\gamma\delta} J_{\beta\gamma} A_\delta . \quad (2.3.7)$$

Here the function ψ is an arbitrary function $\psi(s^k)$ of CP_2 coordinates s^k regarded as functions of space-time coordinates. It is essential that ψ depends on the space-time coordinates through the CP_2 coordinates only. Hence the representation as an imbedded gauge field is crucial element of the solution ansatz.

The field equations state the vanishing of the divergence of the 4-current. This is trivially true for instanton current for $D_{CP_2} < 4$. Also the contraction of $\nabla\psi$ (depending on space-time coordinates through CP_2 coordinates only) with the instanton current is proportional to the winding number density and therefore vanishes for $D_{CP_2} < 4$.

The topologization of the Kähler current guarantees the vanishing of the Lorentz 4-force. Indeed, using the self-duality condition for the current, the expression for the Lorentz 4-force reduces to a term proportional to the instanton density:

$$\begin{aligned} j^\alpha J_{\alpha\beta} &= \psi \times j_I^\alpha J_{\alpha\beta} \\ &= \psi \times \epsilon^{\alpha\mu\nu\delta} J_{\mu\nu} A_\delta J_{\alpha\beta} . \end{aligned} \quad (2.3.8)$$

Since all vector quantities appearing in the contraction with the four-dimensional permutation tensor are proportional to the gradients of CP_2 coordinates, the expression is proportional to the instanton density, and thus winding number density, and vanishes for $D_{CP_2} < 4$.

Remarkably, the topologization of the Kähler current guarantees also the vanishing of the term $j^\alpha J^{k\iota} \partial_\alpha s^k$ in the field equations for CP_2 coordinates. This means that field equations reduce in both M_+^4 and CP_2 degrees of freedom to

$$T^{\alpha\beta} H_{\alpha\beta}^k = 0 . \quad (2.3.9)$$

These equations differ from the equations of minimal surface only by the replacement of the metric tensor with energy momentum tensor. The earlier proposal that quaternion conformal invariance in a suitable sense might provide a general solution of the field equations could be seen as a generalization of the ordinary conformal invariance of string models. If the topologization of the Kähler current implying effective dimensional reduction in CP_2 degrees of freedom is consistent with quaternion conformal invariance, the quaternion conformal structures must differ for the different dimensions of CP_2 projection.

Topologization of the Kähler current for $D_{CP_2} = 3$: non-covariant formulation

In order to gain a concrete understanding about what is involved it is useful to repeat these arguments using the 3-dimensional notation. The components of the instanton 4-current read in three-dimensional notation as

$$\vec{j}_I = \vec{E} \times \vec{A} + \phi \vec{B} , \quad \rho_I = \vec{B} \cdot \vec{A} . \quad (2.3.10)$$

The self duality conditions for the current can be written explicitly using 3-dimensional notation and read

$$\begin{aligned}\nabla \times \bar{B} - \partial_t \bar{E} &= \bar{j} = \psi \bar{j}_I = \psi (\phi \bar{B} + \bar{E} \times \bar{A}) \quad , \\ \nabla \cdot \bar{E} &= \rho = \psi \rho_I \quad .\end{aligned}\tag{2.3.11}$$

For a vanishing electric field the self-duality condition for Kähler current reduces to the Beltrami condition

$$\nabla \times \bar{B} = \alpha \bar{B} \quad , \quad \alpha = \psi \phi \quad .\tag{2.3.12}$$

The vanishing of the divergence of the magnetic field implies that α is constant along the field lines of the flow. When ϕ is constant and \bar{A} is time independent, the condition reduces to the Beltrami condition with $\alpha = \phi = \text{constant}$, which allows an explicit solution [B49] .

One can check also the vanishing of the Lorentz 4-force by using 3-dimensional notation. Lorentz 3-force can be written as

$$\rho_I \bar{E} + \bar{j} \times \bar{B} = \psi \bar{B} \cdot \bar{A} \bar{E} + \psi (\bar{E} \times \bar{A} + \phi \bar{B}) \times \bar{B} = 0 \quad .\tag{2.3.13}$$

The fourth component of the Lorentz force reads as

$$\bar{j} \cdot \bar{E} = \psi \bar{B} \cdot \bar{E} + \psi (\bar{E} \times \bar{A} + \phi \bar{B}) \cdot \bar{E} = 0 \quad .\tag{2.3.14}$$

The remaining conditions come from the induction law of Faraday and could be guaranteed by expressing \bar{E} and \bar{B} in terms of scalar and vector potentials.

The density of the Kähler electric charge of the vacuum is proportional to the the helicity density of the so called helicity charge $\rho = \psi \rho_I = \psi \bar{B} \cdot \bar{A}$. This charge is topological charge in the sense that it does not depend on the induced metric at all. Note the presence of arbitrary function ψ of CP_2 coordinates.

Further conditions on the functions appearing in the solution ansatz come from the 3 independent field equations for CP_2 coordinates. What is remarkable that the generalized self-duality condition for the Kähler current allows to understand the general features of the solution ansatz to very high degree without any detailed knowledge about the detailed solution. The question whether field equations allow solutions consistent with the self duality conditions of the current will be dealt later. The optimistic guess is that the field equations and topologization of the Kähler current relate to each other very intimately.

Vanishing or light likeness of the Kähler current guarantees vanishing of the Lorentz 4-force for $D_{CP_2} = 2$

For $D_{CP_2} = 2$ one can always take two CP_2 coordinates as space-time coordinates and from this it is clear that instanton current vanishes so that topologization gives a vanishing Kähler current. In particular, the Beltrami condition $\nabla \times \bar{B} = \alpha \bar{B}$ is not consistent with the topologization of the instanton current for $D_{CP_2} = 2$.

$D_{CP_2} = 2$ case can be treated in a coordinate invariant manner by using the two coordinates of CP_2 projection as space-time coordinates so that only a magnetic or electric field is present depending on whether the gauge current is time-like or space-like. Light-likeness of the gauge current provides a second manner to achieve the vanishing of the Lorentz force and is realized in case of massless extremals having $D_{CP_2} = 2$: this current is in the direction of propagation whereas magnetic and electric fields are orthogonal to it so that Beltrami conditions is certainly not satisfied.

Under what conditions topologization of Kähler current yields Beltrami conditions?

Topologization of the Kähler 4-current gives rise to magnetic Beltrami fields if either of the following conditions is satisfied.

1. The $\overline{E} \times \overline{A}$ term contributing besides $\phi \overline{B}$ term to the topological current vanishes. This requires that \overline{E} and \overline{A} are parallel to each other

$$\overline{E} = \nabla \Phi - \partial_t \overline{A} = \beta \overline{A} \quad (2.3.15)$$

This condition is analogous to the Beltrami condition. Now only the 3-space has as its coordinates time coordinate and two spatial coordinates and \overline{B} is replaced with \overline{A} . Since E and B are orthogonal, this condition implies $\overline{B} \cdot \overline{A} = 0$ so that Kähler charge density is vanishing.

2. The vector $\overline{E} \times \overline{A}$ is parallel to \overline{B} .

$$\overline{E} \times \overline{A} = \beta \overline{B} \quad (2.3.16)$$

The condition is consistent with the orthogonality of \overline{E} and \overline{B} but implies the orthogonality of \overline{A} and \overline{B} so that electric charge density vanishes

In both cases vector potential fails to define a contact structure since $B \cdot A$ vanishes (contact structures are discussed briefly below), and there exists a global coordinate along the field lines of \overline{A} and the full contact structure is lost again. Note however that the Beltrami condition for magnetic field means that magnetic field defines a contact structure irrespective of whether $\overline{B} \cdot \overline{A}$ vanishes or not. The transition from the general case to Beltrami field would thus involve the replacement

$$(\overline{A}, \overline{B}) \rightarrow_{\nabla \times} (\overline{B}, \overline{j})$$

induced by the rotor.

One must of course take these considerations somewhat cautiously since the inner product depends on the induced 4-metric and it might be that induced metric could allow small vacuum charge density and make possible genuine contact structure.

Hydrodynamic analogy

The field equations of TGD are basically hydrodynamic equations stating the local conservation of the currents associated with the isometries of the imbedding space. Therefore it is intriguing that Beltrami fields appear also as solutions of ideal magnetohydrodynamics equations and as steady solutions of non-viscous incompressible flow described by Euler equations [B21] .

In hydrodynamics the role of the magnetic field is taken by the velocity field. This raises the idea that the incompressible flow could occur along the field lines of some natural vector field. The considerations of the last section show that the instanton current defines a universal candidate as far as the general solution of the field equations is considered. All conserved currents defined by the isometry charges would be parallel to the instanton current: one can say each flow line of instanton current is a carrier of conserved quantum numbers. Perhaps even the flow lines of an incompressible hydrodynamic flow could in reasonable approximation correspond to those of instanton current.

The conservation laws are satisfied for each flow line separately and therefore it seems that one cannot have the analog of viscous hydrodynamic flow in this framework. On the other hand, quantum classical correspondence requires that also dissipative effects have space-time correlates. Does something go badly wrong?

One must however take this argument with a grain of salt. Dissipation, that is the transfer of conserved quantities to degrees of freedom corresponding to shorter scales, could correspond to a transfer of these quantities between different space-time sheets of the many-sheeted space-time. Here the opponent could however argue that larger space-time sheets mimic the dissipative dynamics in shorter scales and that classical currents represent "symbolically" averaged currents in shorter length scales, and that the local non-conservation of energy momentum tensor consistent with local conservation of isometry currents provides a unique manner to mimic the dissipative dynamics.

An argument allowing to circumvent the objection in a more convincing manner emerged more than decade after the emergence of the interpretation in terms of asymptotic self-organization patterns [K19, K31] .

1. The construction of quantum TGD through second quantization of the modified Dirac equation led through several twists to the realization that the addition of a 3-dimensional measurement interaction term to the modified Dirac action is necessary in order to have quantum classical correspondence in the sense that the preferred extremals depend on the quantum numbers labeling states of super-conformal representations. Among many other things this also guarantees that the fermionic propagator has stringy character.
2. This term characterizes measurement interaction inducing state function reductions and hence also dissipation. It induces to a Kähler function a term which is real part of a holomorphic function of complex coordinates of the configuration space ("world of classical worlds") and a priori arbitrary function of zero modes and does not therefore contribute to the Kähler metric of configuration space. Kähler action is however affected by a term describing at space-time level the measurement interaction so that extremals do not remain the same.
3. Dissipation is absent in space-time regions where the measurement interaction term vanishes and there are good reasons to expect that also Kähler action reduces to Kähler action. Therefore preferred extremals can be interpreted as space-time correlates for asymptotic self-organization patterns.

The stability of generalized Beltrami fields

The stability of generalized Beltrami fields is of high interest since unstable points of space-time sheets are those around which macroscopic changes induced by quantum jumps are expected to be localized.

1. Contact forms and contact structures

The stability of Beltrami flows has been studied using the theory of contact forms in three-dimensional Riemann manifolds [B33]. Contact form is a one-form A (that is covariant vector field A_α) with the property $A \wedge dA \neq 0$. In the recent case the induced Kähler gauge potential A_α and corresponding induced Kähler form $J_{\alpha\beta}$ for any 3-sub-manifold of space-time surface define a contact form so that the vector field $A^\alpha = g^{\alpha\beta} A_\beta$ is not orthogonal with the magnetic field $B^\alpha = \epsilon^{\alpha\beta\gamma} J_{\beta\gamma}$. This requires that magnetic field has a helical structure. Induced metric in turn defines the Riemann structure.

If the vector potential defines a contact form, the charge density associated with the topologized Kähler current must be non-vanishing. This can be seen as follows.

1. The requirement that the flow lines of a one-form X_μ defined by the vector field X^μ as its dual allows to define a global coordinate x varying along the flow lines implies that there is an integrating factor ϕ such that $\phi X = dx$ and therefore $d(\phi X) = 0$. This implies $d \log(\phi) \wedge X = -dX$. From this the necessary condition for the existence of the coordinate x is $X \wedge dX = 0$. In the three-dimensional case this gives $\bar{X} \cdot (\nabla \times \bar{X}) = 0$.
2. This condition is by definition not satisfied by the vector potential defining a contact form so that one cannot identify a global coordinate varying along the flow lines of the vector potential. The condition $\bar{B} \cdot \bar{A} \neq 0$ states that the charge density for the topologized Kähler current is non-vanishing. The condition that the field lines of the magnetic field allow a global coordinate requires $\bar{B} \cdot \nabla \times \bar{B} = 0$. The condition is not satisfied by Beltrami fields with $\alpha \neq 0$. Note that in this case magnetic field defines a contact structure.

Contact structure requires the existence of a vector ξ satisfying the condition $A(\xi) = 0$. The vector field ξ defines a plane field, which is orthogonal to the vector field A^α . Reeb field in turn is a vector field for which $A(X) = 1$ and $dA(X; \cdot) = 0$ hold true. The latter condition states the vanishing of the cross product $X \times B$ so that X is parallel to the Kähler magnetic field B^α and has unit projection in the direction of the vector field A^α . Any Beltrami field defines a Reeb field irrespective of the Riemannian structure.

2. Stability of the Beltrami flow and contact structures

Contact structures are used in the study of the topology and stability of the hydrodynamical flows [B33], and one might expect that the notion of contact structure and its proper generalization to the four-dimensional context could be useful in TGD framework also. An example giving some

idea about the complexity of the flows defined by Beltrami fields is the Beltrami field in R^3 possessing closed orbits with all possible knot and link types simultaneously [B33] !

Beltrami flows associated with Euler equations are known to be unstable [B33] . Since the flow is volume preserving, the stationary points of the Beltrami flow are saddle points at which also vorticity vanishes and linear instabilities of Navier-Stokes equations can develop. From the point of view of biology it is interesting that the flow is stabilized by vorticity which implies also helical structures. The stationary points of the Beltrami flow correspond in TGD framework to points at which the induced Kähler magnetic field vanishes. They can be unstable by the vacuum degeneracy of Kähler action implying classical non-determinism. For generalized Beltrami fields velocity and vorticity (both divergence free) are replaced by Kähler current and instanton current.

More generally, the points at which the Kähler 4-current vanishes are expected to represent potential instabilities. The instanton current is linear in Kähler field and can vanish in a gauge invariant manner only if the induced Kähler field vanishes so that the instability would be due to the vacuum degeneracy also now. Note that the vanishing of the Kähler current allows also the generation of region with $D_{CP_2} = 4$. The instability of the points at which induce Kähler field vanish is manifested in quantum jumps replacing the generalized Beltrami field with a new one such that something new is generated around unstable points. Thus the regions in which induced Kähler field becomes weak are the most interesting ones. For example, unwinding of DNA could be initiated by an instability of this kind.

2.3.3 How to satisfy field equations?

The topologization of the Kähler current guarantees also the vanishing of the term $j^\alpha J^{kl} \partial_\alpha s^k$ in the field equations for CP_2 coordinates. This means that field equations reduce in both M_+^4 and CP_2 degrees of freedom to

$$T^{\alpha\beta} H_{\alpha\beta}^k = 0 . \quad (2.3.17)$$

These equations differ from the equations of minimal surface only by the replacement of the metric tensor with energy momentum tensor. The following approach utilizes the properties of Hamilton Jacobi structures of M_+^4 introduced in the study of massless extremals and contact structures of CP_2 emerging naturally in the case of generalized Beltrami fields.

String model as a starting point

String model serves as a starting point.

1. In the case of Minkowskian minimal surfaces representing string orbit the field equations reduce to purely algebraic conditions in light cone coordinates (u, v) since the induced metric has only the component g_{uv} , whereas the second fundamental form has only diagonal components H_{uu}^k and H_{vv}^k .
2. For Euclidian minimal surfaces (u, v) is replaced by complex coordinates (w, \bar{w}) and field equations are satisfied because the metric has only the component $g^{w\bar{w}}$ and second fundamental form has only components of type H_{ww}^k and $H_{\bar{w}\bar{w}}^k$. The mechanism should generalize to the recent case.

The general form of energy momentum tensor as a guideline for the choice of coordinates

Any 3-dimensional Riemann manifold allows always a orthogonal coordinate system for which the metric is diagonal. Any 4-dimensional Riemann manifold in turn allows a coordinate system for which 3-metric is diagonal and the only non-diagonal components of the metric are of form g^{ti} . This kind of coordinates might be natural also now. When \bar{E} and \bar{B} are orthogonal, energy momentum tensor has the form

$$T = \begin{pmatrix} \frac{E^2+B^2}{2} & 0 & 0 & EB \\ 0 & \frac{E^2+B^2}{2} & 0 & 0 \\ 0 & 0 & \frac{-E^2+B^2}{2} & 0 \\ EB & 0 & 0 & \frac{E^2-B^2}{2} \end{pmatrix} \quad (2.3.18)$$

in the tangent space basis defined by time direction and longitudinal direction $\overline{E} \times \overline{B}$, and transversal directions \overline{E} and \overline{B} . Note that T is traceless.

The optimistic guess would be that the directions defined by these vectors integrate to three orthogonal coordinates of X^4 and together with time coordinate define a coordinate system containing only g^{ti} as non-diagonal components of the metric. This however requires that the fields in question allow an integrating factor and, as already found, this requires $\nabla \times X \cdot X = 0$ and this is not the case in general.

Physical intuition suggests however that X^4 coordinates allow a decomposition into longitudinal and transversal degrees freedom. This would mean the existence of a time coordinate t and longitudinal coordinate z the plane defined by time coordinate and vector $\overline{E} \times \overline{B}$ such that the coordinates $u = t - z$ and $v = t + z$ are light like coordinates so that the induced metric would have only the component g^{uv} whereas g^{vv} and g^{uu} would vanish in these coordinates. In the transversal space-time directions complex space-time coordinate coordinate w could be introduced. Metric could have also non-diagonal components besides the components $g^{w\overline{w}}$ and g^{uv} .

Hamilton Jacobi structures in M_+^4

Hamilton Jacobi structure in M_+^4 can understood as a generalized complex structure combing transversal complex structure and longitudinal hyper-complex structure so that notion of holomorphy and Kähler structure generalize.

1. Denote by m^i the linear Minkowski coordinates of M^4 . Let (S^+, S^-, E^1, E^2) denote local coordinates of M_+^4 defining a *local* decomposition of the tangent space M^4 of M_+^4 into a direct, not necessarily orthogonal, sum $M^4 = M^2 \oplus E^2$ of spaces M^2 and E^2 . This decomposition has an interpretation in terms of the longitudinal and transversal degrees of freedom defined by local light-like four-velocities $v_\pm = \nabla S_\pm$ and polarization vectors $\epsilon_i = \nabla E^i$ assignable to light ray. Assume that E^2 allows complex coordinates $w = E^1 + iE^2$ and $\overline{w} = E^1 - iE^2$. The simplest decomposition of this kind corresponds to the decomposition $(S^+ \equiv u = t + z, S^- \equiv v = t - z, w = x + iy, \overline{w} = x - iy)$.
2. In accordance with this physical picture, S^+ and S^- define light-like curves which are normals to light-like surfaces and thus satisfy the equation:

$$(\nabla S_\pm)^2 = 0 \quad .$$

The gradients of S_\pm are obviously analogous to local light like velocity vectors $v = (1, \overline{v})$ and $\tilde{v} = (1, -\overline{v})$. These equations are also obtained in geometric optics from Hamilton Jacobi equation by replacing photon's four-velocity with the gradient ∇S : this is consistent with the interpretation of massless extremals as Bohr orbits of em field. $S_\pm = \text{constant}$ surfaces can be interpreted as expanding light fronts. The interpretation of S_\pm as Hamilton Jacobi functions justifies the term Hamilton Jacobi structure.

The simplest surfaces of this kind correspond to $t = z$ and $t = -z$ light fronts which are planes. They are dual to each other by hyper complex conjugation $u = t - z \rightarrow v = t + z$. One should somehow generalize this conjugation operation. The simplest candidate for the conjugation $S^+ \rightarrow S^-$ is as a conjugation induced by the conjugation for the arguments: $S^+(t - z, t + z, x, y) \rightarrow S^-(t - z, t + z, x, y) = S^+(t + z, t - z, x, -y)$ so that a dual pair is mapped to a dual pair. In transversal degrees of freedom complex conjugation would be involved.

3. The coordinates (S_\pm, w, \overline{w}) define local light cone coordinates with the line element having the form

$$\begin{aligned}
ds^2 &= g_{+-}dS^+dS^- + g_{w\bar{w}}dw d\bar{w} \\
&+ g_{+w}dS^+dw + g_{+\bar{w}}dS^+d\bar{w} \\
&+ g_{-w}dS^-dw + g_{-\bar{w}}dS^-d\bar{w} .
\end{aligned} \tag{2.3.19}$$

Conformal transformations of M_+^4 leave the general form of this decomposition invariant. Also the transformations which reduces to analytic transformations $w \rightarrow f(w)$ in transversal degrees of freedom and hyper-analytic transformations $S^+ \rightarrow f(S^+), S^- \rightarrow f(S^-)$ in longitudinal degrees of freedom preserve this structure.

4. The basic idea is that of generalized Kähler structure meaning that the notion of Kähler function generalizes so that the non-vanishing components of metric are expressible as

$$\begin{aligned}
g_{w\bar{w}} &= \partial_w \partial_{\bar{w}} K , & g_{+-} &= \partial_{S^+} \partial_{S^-} K , \\
g_{w\pm} &= \partial_w \partial_{S^\pm} K , & g_{\bar{w}\pm} &= \partial_{\bar{w}} \partial_{S^\pm} K .
\end{aligned} \tag{2.3.20}$$

for the components of the metric. The expression in terms of Kähler function is coordinate invariant for the same reason as in case of ordinary Kähler metric. In the standard lightcone coordinates the Kähler function is given by

$$K = w_0 \bar{w}_0 + uv , \quad w_0 = x + iy , \quad u = t - z , \quad v = t + z . \tag{2.3.21}$$

The Christoffel symbols satisfy the conditions

$$\left\{ \begin{smallmatrix} k \\ w \bar{w} \end{smallmatrix} \right\} = 0 , \quad \left\{ \begin{smallmatrix} k \\ +- \end{smallmatrix} \right\} = 0 . \tag{2.3.22}$$

If energy momentum tensor has only the components $T^{w\bar{w}}$ and T^{+-} , field equations are satisfied in M_+^4 degrees of freedom.

5. The Hamilton Jacobi structures related by these transformations can be regarded as being equivalent. Since light-like 3- surface is, as the dynamical evolution defined by the light front, fixed by the 2-surface serving as the light source, these structures should be in one-one correspondence with 2-dimensional surfaces with two surfaces regarded as equivalent if they correspond to different time=constant snapshots of the same light front, or are related by a conformal transformation of M_+^4 . Obviously there should be quite large number of them. Note that the generating two-dimensional surfaces relate also naturally to quaternion conformal invariance and corresponding Kac Moody invariance for which deformations defined by the M^4 coordinates as functions of the light-cone coordinates of the light front evolution define Kac Moody algebra, which thus seems to appear naturally also at the level of solutions of field equations.

The task is to find all possible local light cone coordinates defining one-parameter families 2-surfaces defined by the condition $S_i = \text{constant}$, $i = + \text{ or } -$, dual to each other and expanding with light velocity. The basic open questions are whether the generalized Kähler function indeed makes sense and whether the physical intuition about 2-surfaces as light sources parameterizing the set of all possible Hamilton Jacobi structures makes sense.

Hamilton Jacobi structure means the existence of foliations of the M^4 projection of X^4 by 2-D surfaces analogous to string world sheets labeled by w and the dual of this foliation defined by partonic 2-surfaces labeled by the values of S_i . Also the foliation by light-like 3-surfaces Y_l^3 labeled by S_\pm with S_\mp serving as light-like coordinate for Y_l^3 is implied. This is what number theoretic compactification and $M^8 - H$ duality predict when space-time surface corresponds to hyper-quaternionic surface of M^8 [K36, K81] .

Contact structure and generalized Kähler structure of CP_2 projection

In the case of 3-dimensional CP_2 projection it is assumed that one can introduce complex coordinates $(\xi, \bar{\xi})$ and the third coordinate s . These coordinates would correspond to a contact structure in 3-dimensional CP_2 projection defining transversal symplectic and Kähler structures. In these coordinates the transversal parts of the induced CP_2 Kähler form and metric would contain only components of type $g_{w\bar{w}}$ and $J_{w\bar{w}}$. The transversal Kähler field $J_{w\bar{w}}$ would induce the Kähler magnetic field and the components $J_{s\bar{w}}$ and $J_{s\bar{s}}$ the Kähler electric field.

It must be emphasized that the non-integrability of the contact structure implies that J cannot be parallel to the tangent planes of $s = \text{constant}$ surfaces, s cannot be parallel to neither A nor the dual of J , and ξ cannot vary in the tangent plane defined by J . A further important conclusion is that for the solutions with 3-dimensional CP_2 projection topologized Kähler charge density is necessarily non-vanishing by $A \wedge J \neq 0$ whereas for the solutions with $D_{CP_2} = 2$ topologized Kähler current vanishes.

Also the CP_2 projection is assumed to possess a generalized Kähler structure in the sense that all components of the metric except s_{ss} are derivable from a Kähler function by formulas similar to M_+^4 case.

$$s_{w\bar{w}} = \partial_w \partial_{\bar{w}} K \quad , \quad s_{ws} = \partial_w \partial_s K \quad , \quad s_{\bar{w}s} = \partial_{\bar{w}} \partial_s K \quad . \quad (2.3.23)$$

Generalized Kähler property guarantees that the vanishing of the Christoffel symbols of CP_2 (rather than those of 3-dimensional projection), which are of type $\left\{ \begin{smallmatrix} k \\ \xi \bar{\xi} \end{smallmatrix} \right\}$.

$$\left\{ \begin{smallmatrix} k \\ \xi \bar{\xi} \end{smallmatrix} \right\} = 0 \quad . \quad (2.3.24)$$

Here the coordinates of CP_2 have been chosen in such a manner that three of them correspond to the coordinates of the projection and fourth coordinate is constant at the projection. The upper index k refers also to the CP_2 coordinate, which is constant for the CP_2 projection. If energy momentum tensor has only components of type T^{+-} and $T^{w\bar{w}}$, field equations are satisfied even when if non-diagonal Christoffel symbols of CP_2 are present. The challenge is to discover solution ansatz, which guarantees this property of the energy momentum tensor.

A stronger variant of Kähler property would be that also s_{ss} vanishes so that the coordinate lines defined by s would define light like curves in CP_2 . The topologization of the Kähler current however implies that CP_2 projection is a projection of a 3-surface with strong Kähler property. Using $(s, \xi, \bar{\xi}, S^-)$ as coordinates for the space-time surface defined by the ansatz $(w = w(\xi, s), S^+ = S^+(s))$ one finds that g_{ss} must be vanishing so that stronger variant of the Kähler property holds true for $S^- = \text{constant}$ 3-surfaces.

The topologization condition for the Kähler current can be solved completely generally in terms of the induced metric using $(\xi, \bar{\xi}, s)$ and some coordinate of M_+^4 , call it x^4 , as space-time coordinates. Topologization boils down to the conditions

$$\begin{aligned} \partial_\beta (J^{\alpha\beta} \sqrt{g}) &= 0 \quad \text{for } \alpha \in \{\xi, \bar{\xi}, s\} \quad , \\ g^{4i} &\neq 0 \quad . \end{aligned} \quad (2.3.25)$$

Thus 3-dimensional empty space Maxwell equations and the non-orthogonality of X^4 coordinate lines and the 3-surfaces defined by the lift of the CP_2 projection.

A solution ansatz yielding light-like current in $D_{CP_2} = 3$ case

The basic idea is that of generalized Kähler structure and solutions of field equations as maps or deformations of canonically imbedded M_+^4 respecting this structure and guaranteeing that the only non-vanishing components of the energy momentum tensor are $T^{\xi\xi}$ and T^{s-} in the coordinates $(\xi, \bar{\xi}, s, S^-)$.

1. The coordinates (w, S^+) are assumed to holomorphic functions of the CP_2 coordinates (s, ξ)

$$S^+ = S^+(s) \ , \quad w = w(\xi, s) \ . \quad (2.3.26)$$

Obviously S^+ could be replaced with S^- . The ansatz is completely symmetric with respect to the exchange of the roles of (s, w) and (S^+, ξ) since it maps longitudinal degrees of freedom to longitudinal ones and transverse degrees of freedom to transverse ones.

2. Field equations are satisfied if the only non-vanishing components of the energy momentum tensor are of type $T^{\xi\bar{\xi}}$ and T^{s-} . The reason is that the CP_2 Christoffel symbols for projection and projections of M_+^4 Christoffel symbols are vanishing for these lower index pairs.
3. By a straightforward calculation one can verify that the only manner to achieve the required structure of energy momentum tensor is to assume that the induced metric in the coordinates $(\xi, \bar{\xi}, s, S^-)$ has as non-vanishing components only $g_{\xi\bar{\xi}}$ and g_{s-}

$$g_{ss} = 0 \ , \quad g_{\xi s} = 0 \ , \quad g_{\bar{\xi} s} = 0 \ . \quad (2.3.27)$$

Obviously the space-time surface must factorize into an orthogonal product of longitudinal and transversal spaces.

4. The condition guaranteing the product structure of the metric is

$$\begin{aligned} s_{ss} &= m_{+w} \partial_s w(\xi, s) \partial_s S^+(s) + m_{+\bar{w}} \partial_s \bar{w}(\xi, s) \partial_s S^+(s) \ , \\ s_{s\xi} &= m_{+w} \partial_\xi w(\xi) \partial_s S^+(s) \ , \\ s_{s\bar{\xi}} &= m_{+w} \partial_{\bar{\xi}} w(\bar{\xi}) \partial_s S^+(s) \ . \end{aligned} \quad (2.3.28)$$

Thus the function of dynamics is to diagonalize the metric and provide it with strong Kähler property. Obviously the CP_2 projection corresponds to a light-like surface for all values of S^- so that space-time surface is foliated by light-like surfaces and the notion of generalized conformal invariance makes sense for the entire space-time surface rather than only for its boundary or elementary particle horizons.

5. The requirement that the Kähler current is proportional to the instanton current means that only the j^- component of the current is non-vanishing. This gives the following conditions

$$\begin{aligned} j^\xi \sqrt{g} &= \partial_\beta (J^{\xi\beta} \sqrt{g}) = 0 \ , \quad j^{\bar{\xi}} \sqrt{g} = \partial_\beta (J^{\bar{\xi}\beta} \sqrt{g}) = 0 \ , \\ j^+ \sqrt{g} &= \partial_\beta (J^{+\beta} \sqrt{g}) = 0 \ . \end{aligned} \quad (2.3.29)$$

Since $J^{+\beta}$ vanishes, the condition

$$\sqrt{g} j^+ = \partial_\beta (J^{+\beta} \sqrt{g}) = 0 \quad (2.3.30)$$

is identically satisfied. Therefore the number of field equations reduces to three.

The physical interpretation of the solution ansatz deserves some comments.

1. The light-like character of the Kähler current brings in mind CP_2 extremals for which CP_2 projection is light like. This suggests that the topological condensation of CP_2 type extremal occurs on $D_{CP_2} = 3$ helical space-time sheet representing zitterbewegung. In the case of many-body system light-likeness of the current does not require that particles are massless if particles of opposite charges can be present. Field tensor has the form $(J^{\xi\bar{\xi}}, J^{\xi-}, J^{\bar{\xi}-})$. Both helical magnetic field and electric field present as is clear when one replaces the coordinates (S^+, S^-) with time-like and space-like coordinate. Magnetic field dominates but the presence of electric field means that genuine Beltrami field is not in question.
2. Since the induced metric is product metric, 3-surface is metrically product of 2-dimensional surface X^2 and line or circle and obeys product topology. If absolute minima correspond to asymptotic self-organization patterns, the appearance of the product topology and even metric is not so surprising. Thus the solutions can be classified by the genus of X^2 . An interesting question is how closely the explanation of family replication phenomenon in terms of the topology of the boundary component of elementary particle like 3-surface relates to this. The heaviness and instability of particles which correspond to genera $g > 2$ (sphere with more than two handles) might have simple explanation as absence of (stable) $D_{CP_2} = 3$ solutions of field equations with genus $g > 2$.
3. The solution ansatz need not be the most general. Kähler current is light-like and already this is enough to reduce the field equations to the form involving only energy momentum tensor. One might hope of finding also solution ansätze for which Kähler current is time-like or space-like. Space-likeness of the Kähler current might be achieved if the complex coordinates $(\xi, \bar{\xi})$ and hyper-complex coordinates (S^+, S^-) change the role. For this solution ansatz electric field would dominate. Note that the possibility that Kähler current is always light-like cannot be excluded.
4. Suppose that CP_2 projection quite generally defines a foliation of the space-time surface by light-like 3-surfaces, as is suggested by the conformal invariance. If the induced metric has Minkowskian signature, the fourth coordinate x^4 and thus also Kähler current must be time-like or light-like so that magnetic field dominates. Already the requirement that the metric is non-degenerate implies $g_{s4} \neq 0$ so that the metric for the $\xi = \text{constant}$ 2-surfaces has a Minkowskian signature. Thus space-like Kähler current does not allow the lift of the CP_2 projection to be light-like.

Are solutions with time-like or space-like Kähler current possible in $D_{CP_2} = 3$ case?

As noticed in the section about number theoretical compactification, the flow of gauge currents along slices Y_l^3 of $X^4(X_l^3)$ "parallel" to X_l^3 requires only that gauge currents are parallel to Y_l^3 and can thus space-like. The following ansatz gives good hopes for obtaining solutions with space-like and perhaps also time-like Kähler currents.

1. Assign to light-like coordinates coordinates (T, Z) by the formula $T = S^+ + S^-$ and $Z = S^+ - S^-$. Space-time coordinates are taken to be $(\xi, \bar{\xi}, s)$ and coordinate Z . The solution ansatz with time-like Kähler current results when the roles of T and Z are changed. It will however found that same solution ansatz can give rise to both space-like and time-like Kähler current.
2. The solution ansatz giving rise to a space-like Kähler current is defined by the equations

$$T = T(Z, s) \quad , \quad w = w(\xi, s) \quad . \quad (2.3.31)$$

If T depends strongly on Z , the g_{ZZ} component of the induced metric becomes positive and Kähler current time-like.

3. The components of the induced metric are

$$\begin{aligned}
g_{ZZ} &= m_{ZZ} + m_{TT} \partial_Z T \partial_s T , & g_{Zs} &= m_{TT} \partial_Z T \partial_s T , \\
g_{ss} &= s_{ss} + m_{TT} \partial_s T \partial_s T , & g_{w\bar{w}} &= s_{w\bar{w}} + m_{w\bar{w}} \partial_\xi w \partial_{\bar{\xi}} \bar{w} , \\
g_{s\xi} &= s_{s\xi} , & g_{s\bar{\xi}} &= s_{s\bar{\xi}} .
\end{aligned} \tag{2.3.32}$$

Topologized Kähler current has only Z -component and 3-dimensional empty space Maxwell's equations guarantee the topologization.

In CP_2 degrees of freedom the contractions of the energy momentum tensor with Christoffel symbols vanish if T^{ss} , $T^{\xi s}$ and $T^{\xi\xi}$ vanish as required by internal consistency. This is guaranteed if the condition

$$J^{\xi s} = 0 \tag{2.3.33}$$

holds true. Note however that $J^{\xi Z}$ is non-vanishing. Therefore only the components $T^{\xi\bar{\xi}}$ and $T^{Z\xi}$, $T^{Z\bar{\xi}}$ of energy momentum tensor are non-vanishing, and field equations reduce to the conditions

$$\begin{aligned}
\partial_{\bar{\xi}}(J^{\xi\bar{\xi}}\sqrt{g}) + \partial_Z(J^{\xi Z}\sqrt{g}) &= 0 , \\
\partial_\xi(J^{\xi\bar{\xi}}\sqrt{g}) + \partial_Z(J^{\xi Z}\sqrt{g}) &= 0 .
\end{aligned} \tag{2.3.34}$$

In the special case that the induced metric does not depend on z -coordinate equations reduce to holomorphicity conditions. This is achieved if T depends linearly on Z : $T = aZ$.

The contractions with M_+^4 Christoffel symbols come from the non-vanishing of $T^{Z\xi}$ and vanish if the Hamilton Jacobi structure satisfies the conditions

$$\begin{aligned}
\{T^k_w\} = 0 , \quad \{T^k_{\bar{w}}\} = 0 , \\
\{Z^k_w\} = 0 , \quad \{Z^k_{\bar{w}}\} = 0
\end{aligned} \tag{2.3.35}$$

hold true. The conditions are equivalent with the conditions

$$\{\pm^k_w\} = 0 , \quad \{\pm^k_{\bar{w}}\} = 0 . \tag{2.3.36}$$

These conditions possess solutions (standard light cone coordinates are the simplest example). Also the second derivatives of $T(s, Z)$ contribute to the second fundamental form but they do not give rise to non-vanishing contractions with the energy momentum tensor. The cautious conclusion is that also solutions with time-like or space-like Kähler current are possible.

$DCP_2 = 4$ case

The preceding discussion was for $DCP_2 = 3$ and one should generalize the discussion to $DCP_2 = 4$ case.

1. Hamilton Jacobi structure for M_+^4 is expected to be crucial also now.
2. One might hope that for $DCP_2 = 4$ the Kähler structure of CP_2 defines a foliation of CP_2 by 3-dimensional contact structures. This requires that there is a coordinate varying along the field lines of the normal vector field X defined as the dual of the three-form $A \wedge dA = A \wedge J$. By the previous considerations the condition for this reads as $dX = d(\log\phi) \wedge X$ and implies $X \wedge dX = 0$. Using the self duality of the Kähler form one can express X as $X^k = J^{kl}A_l$. By a brief calculation one finds that $X \wedge dX \propto X$ holds true so that (somewhat disappointingly) a foliation of CP_2 by contact structures does not exist.

For $D_{CP_2} = 4$ case Kähler current vanishes and this case corresponds to what I have called earlier Maxwellian phase since empty space Maxwell's equations are indeed satisfied.

1. *Solution ansatz with a 3-dimensional M_+^4 projection*

The basic idea is that the complex structure of CP_2 is preserved so that one can use complex coordinates (ξ^1, ξ^2) for CP_2 in which CP_2 Christoffel symbols and energy momentum tensor have automatically the desired properties. This is achieved the second light like coordinate, say v , is non-dynamical so that the induced metric does not receive any contribution from the longitudinal degrees of freedom. In this case one has

$$S^+ = S^+(\xi^1, \xi^2) , \quad w = w(\xi^1, \xi^2) , \quad S^- = \text{constant} . \quad (2.3.37)$$

The induced metric does possess only components of type $g_{i\bar{j}}$ if the conditions

$$g_{+w} = 0 , \quad g_{+\bar{w}} = 0 . \quad (2.3.38)$$

This guarantees that energy momentum tensor has only components of type $T^{i\bar{j}}$ in coordinates (ξ^1, ξ^2) and their contractions with the Christoffel symbols of CP_2 vanish identically. In M_+^4 degrees of freedom one must pose the conditions

$$\{^k_{w+}\} = 0 , \quad \{^k_{\bar{w}+}\} = 0 , \quad \{^k_{++}\} = 0 . \quad (2.3.39)$$

on Christoffel symbols. These conditions are satisfied if the the M_+^4 metric does not depend on S^+ :

$$\partial_+ m_{kl} = 0 . \quad (2.3.40)$$

This means that m_{-w} and $m_{-\bar{w}}$ can be non-vanishing but like m_{+-} they cannot depend on S^+ .

The second derivatives of S^+ appearing in the second fundamental form are also a source of trouble unless they vanish. Hence S^+ must be a linear function of the coordinates ξ^k :

$$S^+ = a_k \xi^k + \bar{a}_k \bar{\xi}^k . \quad (2.3.41)$$

Field equations are the counterparts of empty space Maxwell equations $j^\alpha = 0$ but with M_+^4 coordinates (u, w) appearing as dynamical variables and entering only through the induced metric. By holomorphy the field equations can be written as

$$\partial_j (J^{j\bar{i}} \sqrt{g}) = 0 , \quad \partial_{\bar{j}} (J^{j\bar{i}} \sqrt{g}) = 0 , \quad (2.3.42)$$

and can be interpreted as conditions stating the holomorphy of the contravariant Kähler form.

What is remarkable is that the M_+^4 projection of the solution is 3-dimensional light like surface and that the induced metric has Euclidian signature. Light front would become a concrete geometric object with one compactified dimension rather than being a mere conceptualization. One could see this as topological quantization for the notion of light front or of electromagnetic shock wave, or perhaps even as the realization of the particle aspect of gauge fields at classical level.

If the latter interpretation is correct, quantum classical correspondence would be realized very concretely. Wave and particle aspects would both be present. One could understand the interactions of charged particles with electromagnetic fields both in terms of absorption and emission of topological field quanta and in terms of the interaction with a classical field as particle topologically condenses at the photonic light front.

For CP_2 type extremals for which M_+^4 projection is a light like curve correspond to a special case of this solution ansatz: transversal M_+^4 coordinates are constant and S^+ is now arbitrary function of CP_2 coordinates. This is possible since M_+^4 projection is 1-dimensional.

2. *Are solutions with a 4-dimensional M_+^4 projection possible?*

The most natural solution ansatz is the one for which CP_2 complex structure is preserved so that energy momentum tensor has desired properties. For four-dimensional M_+^4 projection this ansatz does not seem to make promising since the contribution of the longitudinal degrees of freedom implies that the induced metric is not anymore of desired form since the components $g_{ij} = m_{+-}(\partial_{\xi^i} S^+ \partial_{\xi^j} S^- + m_{+-} \partial_{\xi^i} S^- \partial_{\xi^j} S^+)$ are non-vanishing.

1. The natural dynamical variables are still Minkowski coordinates (w, \bar{w}, S^+, S^-) for some Hamilton Jacobi structure. Since the complex structure of CP_2 must be given up, CP_2 coordinates can be written as (ξ, s, r) to stress the fact that only "one half" of the Kähler structure of CP_2 is respected by the solution ansatz.
2. The solution ansatz has the same general form as in $D_{CP_2} = 3$ case and must be symmetric with respect to the exchange of M_+^4 and CP_2 coordinates. Transverse coordinates are mapped to transverse ones and longitudinal coordinates to longitudinal ones:

$$(S^+, S^-) = (S^+(s, r), S^-(s, r)) \quad , \quad w = w(\xi) \quad . \quad (2.3.43)$$

This ansatz would describe ordinary Maxwell field in M_+^4 since the roles of M_+^4 coordinates and CP_2 coordinates are interchangeable.

It is however far from obvious whether there are any solutions with a 4-dimensional M_+^4 projection. That empty space Maxwell's equations would allow only the topologically quantized light fronts as its solutions would realize quantum classical correspondence very concretely.

$D_{CP_2} = 2$ case

Hamilton Jacobi structure for M_+^4 is assumed also for $D_{CP_2} = 2$, whereas the contact structure for CP_2 is in $D_{CP_2} = 2$ case replaced by the induced Kähler structure. Topologization yields vanishing Kähler current. Light-likeness provides a second manner to achieve vanishing Lorentz force but one cannot exclude the possibility of time- and space-like Kähler current.

1. Solutions with vanishing Kähler current

1. String like objects, which are products $X^2 \times Y^2 \subset M_+^4 \times CP_2$ of minimal surfaces Y^2 of M_+^4 with geodesic spheres S^2 of CP_2 and carry vanishing gauge current. String like objects allow considerable generalization from simple Cartesian products of $X^2 \times Y^2 \subset M^4 \times S^2$. Let (w, \bar{w}, S^+, S^-) define the Hamilton Jacobi structure for M_+^4 . $w = \text{constant}$ surfaces define minimal surfaces X^2 of M_+^4 . Let ξ denote complex coordinate for a sub-manifold of CP_2 such that the imbedding to CP_2 is holomorphic: $(\xi^1, \xi^2) = (f^1(\xi), f^2(\xi))$. The resulting surface $Y^2 \subset CP_2$ is a minimal surface and field equations reduce to the requirement that the Kähler current vanishes: $\partial_{\bar{\xi}}(J^{\xi\bar{\xi}} \sqrt{g_2}) = 0$. One-dimensional strings are deformed to 3-dimensional cylinders representing magnetic flux tubes. The oscillations of string correspond to waves moving along string with light velocity, and for more general solutions they become TGD counterparts of Alfven waves associated with magnetic flux tubes regarded as oscillations of magnetic flux lines behaving effectively like strings. It must be emphasized that Alfven waves are a phenomenological notion not really justified by the properties of Maxwell's equations.
2. Also electret type solutions with the role of the magnetic field taken by the electric field are possible. $(\xi, \bar{\xi}, u, v)$ would provide the natural coordinates and the solution ansatz would be of the form

$$(s, r) = (s(u, v), r(u, v)) \quad , \quad \xi = \text{constant} \quad , \quad (2.3.44)$$

and corresponds to a vanishing Kähler current.

- Both magnetic and electric fields are necessarily present only for the solutions carrying non-vanishing electric charge density (proportional to $\bar{B} \cdot \bar{A}$). Thus one can ask whether more general solutions carrying both magnetic and electric field are possible. As a matter fact, one must first answer the question what one really means with the magnetic field. By choosing the coordinates of 2-dimensional CP_2 projection as space-time coordinates one can define what one means with magnetic and electric field in a coordinate invariant manner. Since the CP_2 Kähler form for the CP_2 projection with $D_{CP_2} = 2$ can be regarded as a pure Kähler magnetic field, the induced Kähler field is either magnetic field or electric field.

The form of the ansatz would be

$$(s, r) = (s, r)(u, v, w, \bar{w}) \ , \ \xi = \text{constant} \ . \quad (2.3.45)$$

As a matter fact, CP_2 coordinates depend on two properly chosen M^4 coordinates only.

1. Solutions with light-like Kähler current

There are large classes of solutions of field equations with a light-like Kähler current and 2-dimensional CP_2 projection.

- Massless extremals for which CP_2 coordinates are arbitrary functions of one transversal coordinate $e = f(w, \bar{w})$ defining local polarization direction and light like coordinate u of M^4_+ and carrying in the general case a light like current. In this case the holomorphy does not play any role.
- The string like solutions thickened to magnetic flux tubes carrying TGD counterparts of Alfven waves generalize to solutions allowing also light-like Kähler current. Also now Kähler metric is allowed to develop a component between longitudinal and transversal degrees of freedom so that Kähler current develops a light-like component. The ansatz is of the form

$$\xi^i = f^i(\xi) \ , \ w = w(\xi) \ , \ S^- = s^- \ , \ S^+ = s^+ + f(\xi, \bar{\xi}) \ .$$

Only the components $g_{+\xi}$ and $g_{+\bar{\xi}}$ of the induced metric receive contributions from the modification of the solution ansatz. The contravariant metric receives contributions to $g^{-\xi}$ and $g^{-\bar{\xi}}$ whereas $g^{+\xi}$ and $g^{+\bar{\xi}}$ remain zero. Since the partial derivatives $\partial_\xi \partial_+ h^k$ and $\partial_{\bar{\xi}} \partial_+ h^k$ and corresponding projections of Christoffel symbols vanish, field equations are satisfied. Kähler current develops a non-vanishing component j^- . Apart from the presence of the electric field, these solutions are highly analogous to Beltrami fields.

Could $D_{CP_2} = 2 \rightarrow 3$ transition occur in rotating magnetic systems?

I have studied the imbeddings of simple cylindrical and helical magnetic fields in various applications of TGD to condensed matter systems, in particular in attempts to understand the strange findings about rotating magnetic systems [K83] .

Let S^2 be the homologically non-trivial geodesic sphere of CP_2 with standard spherical coordinates $(U \equiv \cos(\theta), \Phi)$ and let (t, ρ, ϕ, z) denote cylindrical coordinates for a cylindrical space-time sheet. The simplest possible space-time surfaces $X^4 \subset M^4_+ \times S^2$ carrying helical Kähler magnetic field depending on the radial cylindrical coordinate ρ , are given by:

$$\begin{aligned} U &= U(\rho) \ , \quad \Phi = n\phi + kz \ , \\ J_{\rho\phi} &= n\partial_\rho U \ , \quad J_{\rho z} = k\partial_\rho U \ . \end{aligned} \quad (2.3.46)$$

This helical field is not Beltrami field as one can easily find. A more general ansatz corresponding defined by

$$\Phi = \omega t + kz + n\phi$$

would in cylindrical coordinates give rise to both helical magnetic field and radial electric field depending on ρ only. This field can be obtained by simply replacing the vector potential with its rotated

version and provides the natural first approximation for the fields associated with rotating magnetic systems.

A non-vanishing vacuum charge density is however generated when a constant magnetic field is put into rotation and is implied by the condition $\bar{E} = \bar{v} \times \bar{B}$ stating vanishing of the Lorentz force. This condition does not follow from the induction law of Faraday although Faraday observed this effect first. This is also clear from the fact that the sign of the charge density depends on the direction of rotation.

The non-vanishing charge density is not consistent with the vanishing of the Kähler 4-current and requires a 3-dimensional CP_2 projection and topologization of the Kähler current. Beltrami condition cannot hold true exactly for the rotating system. The conclusion is that rotation induces a phase transition $D_{CP_2} = 2 \rightarrow 3$. This could help to understand various strange effects related to the rotating magnetic systems [K83]. For instance, the increase of the dimension of CP_2 projection could generate join along boundaries contacts and wormhole contacts leading to the transfer of charge between different space-time sheets. The possibly resulting flow of gravitational flux to larger space-time sheets might help to explain the claimed antigravity effects.

2.3.4 $D_{CP_2} = 3$ phase allows infinite number of topological charges characterizing the linking of magnetic field lines

When space-time sheet possesses a $D = 3$ -dimensional CP_2 projection, one can assign to it a non-vanishing and conserved topological charge characterizing the linking of the magnetic field lines defined by Chern-Simons action density $A \wedge dA/4\pi$ for induced Kähler form. This charge can be seen as classical topological invariant of the linked structure formed by magnetic field lines.

The topological charge can also vanish for $D_{CP_2} = 3$ space-time sheets. In Darboux coordinates for which Kähler gauge potential reads as $A = P_k dQ^k$, the surfaces of this kind result if one has $Q^2 = f(Q^1)$ implying $A = fdQ^1$, $f = P_1 + P_2 \partial_{Q_1} Q^2$, which implies the condition $A \wedge dA = 0$. For these space-time sheets one can introduce Q^1 as a global coordinate along field lines of A and define the phase factor $\exp(i \int A_\mu dx^\mu)$ as a wave function defined for the entire space-time sheet. This function could be interpreted as a phase of an order parameter of super-conductor like state and there is a high temptation to assume that quantum coherence in this sense is lost for more general $D_{CP_2} = 3$ solutions.

Chern-Simons action is known as helicity in electrodynamics [B51]. Helicity indeed describes the linking of magnetic flux lines as is easy to see by interpreting magnetic field as incompressible fluid flow having A as vector potential: $B = \nabla \times A$. One can write A using the inverse of $\nabla \times$ as $A = (1/\nabla \times)B$. The inverse is non-local operator expressible as

$$\frac{1}{\nabla \times} B(r) = \int dV' \frac{(r - r')}{|r - r'|^3} \times B(r') ,$$

as a little calculation shows. This allows to write $\int A \cdot B$ as

$$\int dV A \cdot B = \int dV dV' B(r) \cdot \left(\frac{(r - r')}{|r - r'|^3} \times B(r') \right) ,$$

which is completely analogous to the Gauss formula for linking number when linked curves are replaced by a distribution of linked curves and an average is taken.

For $D_{CP_2} = 3$ field equations imply that Kähler current is proportional to the helicity current by a factor which depends on CP_2 coordinates, which implies that the current is automatically divergence free and defines a conserved charge for $D = 3$ -dimensional CP_2 projection for which the instanton density vanishes identically. Kähler charge is not equal to the helicity defined by the inner product of magnetic field and vector potential but to a more general topological charge.

The number of conserved topological charges is infinite since the product of any function of CP_2 coordinates with the helicity current has vanishing divergence and defines a topological charge. A very natural function basis is provided by the scalar spherical harmonics of $SU(3)$ defining Hamiltonians of CP_2 canonical transformations and possessing well defined color quantum numbers. These functions define an infinite number of conserved charges which are also classical knot invariants in the sense that they are not affected at all when the 3-surface interpreted as a map from CP_2 projection to M_+^4 is deformed in M_+^4 degrees of freedom. Also canonical transformations induced by Hamiltonians in

irreducible representations of color group affect these invariants via Poisson bracket action when the $U(1)$ gauge transformation induced by the canonical transformation corresponds to a single valued scalar function. These link invariants are additive in union whereas the quantum invariants defined by topological quantum field theories are multiplicative.

Also non-Abelian topological charges are well-defined. One can generalize the topological current associated with the Kähler form to a corresponding current associated with the induced electro-weak gauge fields whereas for classical color gauge fields the Chern-Simons form vanishes identically. Also in this case one can multiply the current by CP_2 color harmonics to obtain an infinite number of invariants in $D_{CP_2} = 3$ case. The only difference is that $A \wedge dA$ is replaced by $Tr(A \wedge (dA + 2A \wedge A/3))$.

There is a strong temptation to assume that these conserved charges characterize colored quantum states of the conformally invariant quantum theory as a functional of the light-like 3-surface defining boundary of space-time sheet or elementary particle horizon surrounding wormhole contacts. They would be TGD analogs of the states of the topological quantum field theory defined by Chern-Simons action as highest weight states associated with corresponding Wess-Zumino-Witten theory. These charges could be interpreted as topological counterparts of the isometry charges of configuration space of 3-surfaces defined by the algebra of canonical transformations of CP_2 .

The interpretation of these charges as contributions of light-like boundaries to configuration space Hamiltonians would be natural. The dynamics of the induced second quantized spinor fields relates to that of Kähler action by a super-symmetry, so that it should define super-symmetric counterparts of these knot invariants. The anti-commutators of these super charges cannot however contribute to configuration space Kähler metric so that topological zero modes are in question. These Hamiltonians and their super-charge counterparts would be responsible for the topological sector of quantum TGD.

2.3.5 Preferred extremal property and the topologization/light-likeness of Kähler current?

The basic question is under what conditions the Kähler current is either topologized or light-like so that the Lorentz force vanishes. Does this hold for all preferred extremals of Kähler action? Or only asymptotically as suggested by the fact that generalized Beltrami fields can be interpreted as asymptotic self-organization patterns, when dissipation has become insignificant. Or does topologization take place in regions of space-time surface having Minkowskian signature of the induced metric? And what asymptotia actually means? Do absolute minima of Kähler action correspond to preferred extremals?

One can challenge the interpretation in terms of asymptotic self organization patterns assigned to the Minkowskian regions of space-time surface.

1. Zero energy ontology challenges the notion of approach to asymptotia in Minkowskian sense since the dynamics of light-like 3-surfaces is restricted inside finite volume $CD \subset M^4$ since the partonic 2-surfaces representing their ends are at the light-like boundaries of causal diamond in a given p-adic time scale.
2. One can argue that generic non-asymptotic field configurations have $D_{CP_2} = 4$, and would thus carry a vanishing Kähler four-current if Beltrami conditions were satisfied universally rather than only asymptotically. $j^\alpha = 0$ would obviously hold true also for the asymptotic configurations, in particular those with $D_{CP_2} < 4$ so that empty space Maxwell's field equations would be universally satisfied for asymptotic field configurations with $D_{CP_2} < 4$. The weak point of this argument is that it is 3-D light-like 3-surfaces rather than space-time surfaces which are the basic dynamical objects so that the generic and only possible case corresponds to $D_{CP_2} = 3$ for X_1^3 . It is quite possible that preferred extremal property implies that $D_{CP_2} = 3$ holds true in the Minkowskian regions since these regions indeed represent empty space. Geometrically this would mean that the CP_2 projection does not change as the light-like coordinate labeling Y_1^3 varies. This conforms nicely with the notion of quantum gravitational holography.
3. The failure of the generalized Beltrami conditions would mean that Kähler field is completely analogous to a dissipative Maxwell field for which also Lorentz force vanishes since $\vec{j} \cdot \vec{E}$ is non-vanishing (note that isometry currents are conserved although energy momentum tensor is not). Quantum classical correspondence states that classical space-time dynamics is by its classical non-determinism able to mimic the non-deterministic sequence of quantum jumps at

space-time level, in particular dissipation in various length scales defined by the hierarchy of space-time sheets. Classical fields would represent "symbolically" the average dynamics, in particular dissipation, in shorter length scales. For instance, vacuum 4-current would be a symbolic representation for the average of the currents consisting of elementary particles. This would seem to support the view that $D_{CP_2} = 4$ Minkowskian regions are present. The weak point of this argument is that there is fractal hierarchy of length scales represented by the hierarchy of causal diamonds (CDs) and that the resulting hierarchy of generalized Feynman graphs might be enough to represent dissipation classically.

4. One objection to the idea is that second law realized as an asymptotic vanishing of Lorentz-Kähler force implies that all space-like 3-surfaces approaching same asymptotic state have the same value of Kähler function assuming that the Kähler function assignable to space-like 3-surface is same for all space-like sections of $X^4(X_l^3)$ (assuming that one can realize general coordinate invariance also in this sense). This need not be the case. In any case, this need not be a problem since it would mean an additional symmetry extending general coordinate invariance. The exponent of Kähler function would be highly analogous to a partition function defined as an exponent of Hamiltonian with Kähler coupling strength playing the role of temperature.

It seems that asymptotic self-organization pattern need not be correct interpretation for non-dissipating regions, and the identification of light-like 3-surfaces as generalized Feynman diagrams encourages an alternative interpretation.

1. $M^8 - H$ duality states that also the H counterparts of co-hyper-hyperquaternionic surfaces of M^8 are preferred extremals of Kähler action. CP_2 type vacuum extremals represent the basic example of these and a plausible conjecture is that the regions of space-time with Euclidian signature of the induced metric represent this kind of regions. If this conjecture is correct, dissipation could be assigned with regions having Euclidian signature of the induced metric. This makes sense since dissipation has quantum description in terms of Feynman graphs and regions of Euclidian signature indeed correspond to generalized Feynman graphs. This argument would suggest that generalized Beltrami conditions or light-likeness hold true inside Minkowskian regions rather than only asymptotically.
2. One could of course play language games and argue that asymptotia is with respect to the Euclidian time coordinate inside generalized Feynman graphs and is achieved exactly when the signature of the induced metric becomes Minkowskian. This is somewhat artificial attempt to save the notion of asymptotic self-organization pattern since the regions outside Feynman diagrams represent empty space providing a holographic representations for the matter at X_l^3 so that the vanishing of $j^\alpha F_{\alpha\beta}$ is very natural.
3. What is then the correct identification of asymptotic self-organization pattern. Could correspond to the negative energy part of the zero energy state at the upper light-like boundary δM_-^4 of CD ? Or in the case of phase conjugate state to the positive energy part of the state at δM_+^4 ? An identification consistent with the fractal structure of zero energy ontology and TGD inspired theory of consciousness is that the entire zero energy state reached by a sequence of quantum jumps represents asymptotic self-organization pattern represented by the asymptotic generalized Feynman diagram or their superposition. Biological systems represent basic examples about self-organization, and one cannot avoid the questions relating to the relationship between experience and geometric time. A detailed discussion of these points can be found in [K6].

Absolute minimization of Kähler action was the first guess for the criterion selecting preferred extremals. Absolute minimization in a strict sense of the word does not make sense in the p-adic context since p-adic numbers are not well-ordered, and one cannot even define the action integral as a p-adic number. The generalized Beltrami conditions and the boundary conditions defining the preferred extremals are however local and purely algebraic and make sense also p-adically. If absolute minimization reduces to these algebraic conditions, it would make sense.

2.3.6 Generalized Beltrami fields and biological systems

The following arguments support the view that generalized Beltrami fields play a key role in living systems, and that $D_{CP_2} = 2$ corresponds to ordered phase, $D_{CP_2} = 3$ to spin glass phase and $D_{CP_2} = 4$

to chaos, with $D_{CP_2} = 3$ defining life as a phenomenon at the boundary between order and chaos. If the criteria suggested by the number theoretic compactification are accepted, it is not clear whether D_{CP_2} extremals can define preferred extremals of Kähler action. For instance, cosmic strings are not preferred extremals and the Y_I^3 associated with MEs allow only covariantly constant right handed neutrino eigenmode of $D_K(X^2)$. The topological condensation of CP_2 type vacuum extremals around $D_{CP_2} = 2$ type extremals is however expected to give preferred extremals and if the density of the condensate is low enough one can still speak about $D_{CP_2} = 2$ phase. A natural guess is also that the deformation of $D_{CP_2} = 2$ extremals transforms light-like gauge currents to space-like topological currents allowed by $D_{CP_2} = 3$ phase.

Why generalized Beltrami fields are important for living systems?

Chirality, complexity, and high level of organization make $D_{CP_2} = 3$ generalized Beltrami fields excellent candidates for the magnetic bodies of living systems.

1. Chirality selection is one of the basic signatures of living systems. Beltrami field is characterized by a chirality defined by the relative sign of the current and magnetic field, which means parity breaking. Chirality reduces to the sign of the function ψ appearing in the topologization condition and makes sense also for the generalized Beltrami fields.
2. Although Beltrami fields can be extremely complex, they are also extremely organized. The reason is that the function α is constant along flux lines so that flux lines must in the case of compact Riemann 3-manifold belong to 2-dimensional $\alpha = \text{constant}$ closed surfaces, in fact two-dimensional invariant tori [B21].

For generalized Beltrami fields the function ψ is constant along the flow lines of the Kähler current. Space-time sheets with 3-dimensional CP_2 projection serve as an illustrative example. One can use the coordinates for the CP_2 projection as space-time coordinates so that one space-time coordinate disappears totally from consideration. Hence the situation reduces to a flow in a 3-dimensional sub-manifold of CP_2 . One can distinguish between three types of flow lines corresponding to space-like, light-like and time-like topological current. The 2-dimensional $\psi = \text{constant}$ invariant manifolds are sub-manifolds of CP_2 . Ordinary Beltrami fields are a special case of space-like flow with flow lines belonging to the 2-dimensional invariant tori of CP_2 . Time-like and light-like situations are more complex since the flow lines need not be closed so that the 2-dimensional $\psi = \text{constant}$ surfaces can have boundaries.

For periodic self-organization patterns flow lines are closed and $\psi = \text{constant}$ surfaces of CP_2 must be invariant tori. The dynamics of the periodic flow is obtained from that of a steady flow by replacing one spatial coordinate with effectively periodic time coordinate. Therefore topological notions like helix structure, linking, and knotting have a dynamical meaning at the level of CP_2 projection. The periodic generalized Beltrami fields are highly organized also in the temporal domain despite the potentiality for extreme topological complexity.

For these reasons topologically quantized generalized Beltrami fields provide an excellent candidate for a generic model for the dynamics of biological self-organization patterns. A natural guess is that many-sheeted magnetic and Z^0 magnetic fields and their generalizations serve as templates for the helical molecules populating living matter, and explain both chiral selection, the complex linking and knotting of DNA and protein molecules, and even the extremely complex and self-organized dynamics of biological systems at the molecular level.

The intricate topological structures of DNA, RNA, and protein molecules are known to have a deep significance besides their chemical structure, and they could even define something analogous to the genetic code. Usually the topology and geometry of bio-molecules is believed to reduce to chemistry. TGD suggests that space-like generalized Beltrami fields serve as templates for the formation of bio-molecules and bio-structures in general. The dynamics of bio-systems would in turn utilize the time-like Beltrami fields as templates. There could even exist a mapping from the topology of magnetic flux tube structures serving as templates for bio-molecules to the templates of self-organized dynamics. The helical structures, knotting, and linking of bio-molecules would thus define a symbolic representation, and even coding for the dynamics of the bio-system analogous to written language.

$D_{CP_2} = 3$ systems as boundary between $D_{CP_2} = 2$ order and $D_{CP_2} = 4$ chaos

The dimension of CP_2 projection is basic classifier for the asymptotic self-organization patterns.

1. $D_{CP_2} = 4$ phase, dead matter, and chaos

$D_{CP_2} = 4$ corresponds to the ordinary Maxwellian phase in which Kähler current and charge density vanish and there is no topologization of Kähler current. By its maximal dimension this phase would naturally correspond to disordered phase, ordinary "dead matter". If one assumes that Kähler charge corresponds to either em charge or Z^0 charge then the signature of this state of matter would be em neutrality or Z^0 neutrality.

2. $D_{CP_2} = 2$ phase as ordered phase

By the low dimension of CP_2 projection $D_{CP_2} = 2$ phase is the least stable phase possible only at cold space-time sheets. Kähler current is either vanishing or light-like, and Beltrami fields are not possible. This phase is highly ordered and much like a topological quantized version of ferro-magnet. In particular, it is possible to have a global coordinate varying along the field lines of the vector potential also now. The magnetic and Z^0 magnetic body of any system is a candidate for this kind of system. Z^0 field is indeed always present for vacuum extremals having $D_{CP_2} = 2$ and the vanishing of em field requires that that $\sin^2(\theta_W)$ (θ_W is Weinberg angle) vanishes.

3. $D_{CP_2} = 3$ corresponds to living matter

$D_{CP_2} = 3$ corresponds to highly organized phase characterized in the case of space-like Kähler current by complex helical structures necessarily accompanied by topologized Kähler charge density $\propto \bar{A} \cdot \bar{B} \neq 0$ and Kähler current $\bar{E} \times \bar{A} + \phi \bar{B}$. For time like Kähler currents the helical structures are replaced by periodic oscillation patterns for the state of the system. By the non-maximal dimension of CP_2 projection this phase must be unstable against too strong external perturbations and cannot survive at too high temperatures. Living matter is thus excellent candidate for this phase and it might be that the interaction of the magnetic body with living matter makes possible the transition from $D_{CP_2} = 2$ phase to the self-organizing $D_{CP_2} = 3$ phase.

Living matter which is indeed populated by helical structures providing examples of space-like Kähler current. Strongly charged lipid layers of cell membrane might provide example of time-like Kähler current. Cell membrane, micro-tubuli, DNA, and proteins are known to be electrically charged and Z^0 charge plays key role in TGD based model of catalysis discussed in [K33]. For instance, denaturing of DNA destroying its helical structure could be interpreted as a transition leading from $D_{CP_2} = 3$ phase to $D_{CP_2} = 4$ phase. The prediction is that the denatured phase should be electro-magnetically (or Z^0) neutral.

Beltrami fields result when Kähler charge density vanishes. For these configurations magnetic field and current density take the role of the vector potential and magnetic field as far as the contact structure is considered. For Beltrami fields there exist a global coordinate along the field lines of the vector potential but not along those of the magnetic field. As a consequence, the covariant consistency condition $(\partial_s - qeA_s)\Psi = 0$ frequently appearing in the physics of super conducting systems would make sense along the flow lines of the vector potential for the order parameter of Bose-Einstein condensate. If Beltrami phase is super-conducting, then the state of the system must change in the transition to a more general phase. It is impossible to assign slicing of 4-surface by 3-D surfaces labeled by a coordinate t varying along the flow lines. This means that one cannot speak about a continuous evolution of Schrödinger amplitude with t playing the role of time coordinate. One could perhaps say that the entire space-time sheet represents single quantum event which cannot be decomposed to evolution. This would conform with the assignment of macroscopic and macro-temporal quantum coherence with living matter.

The existence of these three phases brings in mind systems allowing chaotic de-magnetized phase above critical temperature T_c , spin glass phase at the critical point, and ferromagnetic phase below T_c . Similar analogy is provided by liquid phase, liquid crystal phase possible in the vicinity of the critical point for liquid to solid transition, and solid phase. Perhaps one could regard $D_{CP_2} = 3$ phase and life as a boundary region between $D_{CP_2} = 2$ order and $D_{CP_2} = 4$ chaos. This would naturally explain why life as it is known is possible in relatively narrow temperature interval.

Can one assign a continuous Schrödinger time evolution to light-like 3-surfaces?

Alain Connes wrote [A42] about factors of various types using as an example Schrödinger equation for various kinds of foliations of space-time to time=constant slices. If this kind of foliation does not exist, one cannot speak about time evolution of Schrödinger equation at all. Depending on the character of the foliation one can have factor of type I, II, or III. For instance, torus with slicing $dx = a dy$ in flat coordinates, gives a factor of type I for rational values of a and factor of type II for irrational values of a .

1. 3-D foliations and type III factors

Connes mentioned 3-D foliations V which give rise to type III factors. Foliation property requires a slicing of V by a one-form v to which slices are orthogonal (this requires metric).

1. The foliation property requires that v multiplied by suitable scalar is gradient. This gives the integrability conditions $dv = w \wedge v$, $w = -d\psi/\psi = -d\log(\psi)$. Something proportional to $\log(\psi)$ can be taken as a third coordinate varying along flow lines of v : the flow defines a continuous sequence of maps of 2-dimensional slice to itself.
2. If the so called Godbillon-Vey invariant defined as the integral of $dw \wedge w$ over V is non-vanishing, factor of type III is obtained using Schrödinger amplitudes for which the flow lines of foliation define the time evolution. The operators of the algebra in question are transversal operators acting on Schrödinger amplitudes at each slice. Essentially Schrödinger equation in 3-D space-time would be in question with factor of type III resulting from the exotic choice of the time coordinate defining the slicing.

2. What happens in case of light-like 3-surfaces?

In TGD light-like 3-surfaces are natural candidates for V and it is interesting to look what happens in this case. Light-likeness is of course a disturbing complication since orthogonality condition and thus contravariant metric is involved with the definition of the slicing. Light-likeness is not however involved with the basic conditions.

1. The one-form v defined by the induced Kähler gauge potential A defining also a braiding is a unique identification for v . If foliation exists, the braiding flow defines a continuous sequence of maps of partonic 2-surface to itself.
2. Physically this means the possibility of a super-conducting phase with order parameter satisfying covariant constancy equation $D\psi = (d/dt - ieA)\psi = 0$. This would describe a supra current flowing along flow lines of A .
3. If the integrability fails to be true, one *cannot* assign Schrödinger time evolution with the flow lines of v . One might perhaps say that 3-surface behaves like single quantum event not allowing slicing into a continuous Schrödinger time evolution.
4. In TGD Schrödinger amplitudes are replaced by second quantized induced spinor fields. Hence one does not face the problem whether it makes sense to speak about Schrödinger time evolution of complex order parameter along the flow lines of a foliation or not. Also the fact that the "time evolution" for the modified Dirac operator corresponds to single position dependent generalized eigenvalue identified as Higgs expectation same for all transversal modes (essentially z^n labeled by conformal weight) is crucial since it saves from the problems caused by the possible non-existence of Schrödinger evolution.

4. Extremals of Kähler action

Some comments relating to the interpretation of the classification of the extremals of Kähler action by the dimension of their CP_2 projection are in order. It has been already found that the extremals can be classified according to the dimension D of the CP_2 projection of space-time sheet in the case that $A_a = 0$ holds true.

1. For $D_{CP_2} = 2$ integrability conditions for the vector potential can be satisfied for $A_a = 0$ so that one has generalized Beltrami flow and one can speak about Schrödinger time evolution associated with the flow lines of vector potential defined by covariant constancy condition $D\psi = 0$ makes sense. Kähler current is vanishing or light-like. This phase is analogous to a super-conductor or a ferromagnetic phase. For non-vanishing A_a the Beltrami flow property is lost but the analogy with ferromagnetism makes sense still.
2. For $D_{CP_2} = 3$ foliations are lost. The phase is dominated by helical structures. This phase is analogous to spin glass phase around phase transition point from ferromagnetic to non-magnetized phase and expected to be important in living matter systems.
3. $D_{CP_2} = 4$ is analogous to a chaotic phase with vanishing Kähler current and to a phase without magnetization. The interpretation in terms of non-quantum coherent "dead" matter is suggestive.

An interesting question is whether the ordinary 8-D imbedding space which defines one sector of the generalized imbedding space could correspond to $A_a = 0$ phase. If so, then all states for this sector would be vacua with respect to M^4 quantum numbers. M^4 -trivial zero energy states in this sector could be transformed to non-trivial zero energy states by a leakage to other sectors.

2.3.7 About small perturbations of field equations

The study of small perturbations of the known solutions of field equations is a standard manner to get information about the properties of the solutions, their stability in particular. Fourier expansion is the standard manner to do the perturbation theory. In the recent case an appropriate modification of this ansatz might make sense if the solution in question is representable as a map $M^4_+ \rightarrow CP_2$, and the perturbations are rapidly varying when compared to the components of the induced metric and Kähler form so that one can make adiabatic approximation and approximate them as being effectively constant. Presumably also restrictions on directions of wave 4-vectors $k_\mu = (\omega, \vec{k})$ are necessary so that the direction of wave vector adapts to the slowly varying background as in ray optics. Also Hamilton Jacobi structure is expected to modify the most straightforward approach. The four CP_2 coordinates are the dynamical variables so that the situation is relatively simple.

A completely different approach is inspired by the physical picture. In this approach one glues CP_2 type vacuum extremal to a known extremal and tries to deduce the behavior of the deformed extremal in the vicinity of wormhole throat by posing the general conditions on the slicing by light-like 3-surfaces Y_1^3 . This approach is not followed now.

Generalized plane waves

Individual plane waves are geometrically very special since they represent a deformation of the space-time surface depending on single coordinate only. Despite this one might hope that plane waves or their appropriate modifications allowing to algebraize the treatment of small perturbations could give useful information also now.

1. Lorentz invariance plus the translational invariance due to the assumption that the induced metric and Kähler form are approximately constant encourage to think that the coordinates reduce Minkowski coordinates locally with the orientation of the local Minkowski frame depending slowly on space-time position. Hamilton Jacobi (S^+, S^-, w, \bar{w}) are a good candidate for this kind of coordinates. The properties of the Hamilton Jacobi structure and of the solution ansatz suggest that excitations are generalized plane waves in longitudinal degrees of freedom only so that four-momentum would be replaced by the longitudinal momentum. In transverse degrees of freedom one might expect that holomorphic plane-waves $exp(ik_T w)$, where k_T is transverse momentum, make algebraization possible.

For time-like longitudinal momenta one can choose the local M^4 coordinates in such a manner that longitudinal momentum reduces to $(\omega_0, 0)$, where ω_0 plays the role of rest mass and is analogous to the plasma frequency serving as an infrared cutoff for plasma waves. In these coordinates the simplest candidates for excitations with time-like momentum would be of form $\Delta s^k = \epsilon a^k exp(i\omega_0 u)$, where s^k are some real coordinates for CP_2 , a^k are Fourier coefficients,

and time-like coordinate is defined as $u = S^+ + S^-$. The excitations moving with light velocity correspond to $\omega_0 = 0$, and one must treat this case separately using plane wave $\exp(i\omega S^\pm)$, where ω has continuum of values.

2. It is possible that only some preferred CP_2 coordinates are excited in longitudinal degrees of freedom. For $D_{CP_2} = 3$ ansatz the simplest option is that the complex CP_2 coordinate ξ depends analytically on w and the longitudinal CP_2 coordinate s obeys the plane wave ansatz. $\xi(w) = a \times \exp(ik_T w)$, where k_T is transverse momentum allows the algebraization of the solution ansatz also in the transversal degrees of freedom so that a dispersion relation results. For imaginary values of k_T and ω the equations are real.

2. General form for the second variation of the field equations

For time-like four-momentum the second variation of field equations contains three kinds of terms. There are terms quadratic in ω_0 and coming from the second derivatives of the deformation, terms proportional to $i\omega_0$ coming from the variation with respect to the derivatives of CP_2 coordinates, and terms which do not depend on ω_0 and come from the variations of metric and Kähler form with respect to the CP_2 coordinates.

In standard perturbation theory the terms proportional to $i\omega_0$ would have interpretation as analogs of dissipative terms. This forces to assume that ω_0 is complex: note that in purely imaginary ω_0 the equations are real. The basic assumption is that Kähler action is able to mimic dissipation despite the fact that energy and momentum are conserved quantities. The vanishing of the Lorentz force has an interpretation as the vanishing of the dissipative effects. This would suggest that the terms proportional to $i\omega_0$ vanish for the perturbations of the solution preserving the non-dissipative character of the asymptotic solutions. This might quite well result from the vanishing of the contractions with the deformation of the energy momentum tensor with the second fundamental form and of energy momentum tensor with the deformation of the second fundamental form coming from first derivatives.

Physical intuition would suggest that dissipation-less propagation is possible only along special directions. Thus the vanishing of the linear terms should occur only for special directions of the longitudinal momentum vector, say for light-like four-momenta in the direction of coordinate lines of S^+ or S^- . Quite generally, the sub-space of allowed four-momenta is expected to depend on position since the components of metric and Kähler form are slowly varying. This dependence is completely analogous with that appearing in the Hamilton Jacobi (ray-optics) approach to the approximate treatment of wave equations and makes sense if the phase of the plane wave varies rapidly as compared to the variation of CP_2 coordinates for the unperturbed solution.

Complex values of ω_0 are also possible, and would allow to deduce important information about the rate at which small deviations from asymptotia vanish as well as about instabilities of the asymptotic solutions. In particular, for imaginary values of ω_0 one obtains completely well-defined solution ansatz representing exponentially decaying or increasing perturbation.

High energy limit

One can gain valuable information by studying the perturbations at the limit of very large four-momentum. At this limit the terms which are quadratic in the components of momentum dominate and come from the second derivatives of the CP_2 coordinates appearing in the second fundamental form. The resulting equations reduce for all CP_2 coordinates to the same condition

$$T^{\alpha\beta} k_\alpha k_\beta = 0 \quad .$$

This condition is generalization of masslessness condition with metric replaced by the energy momentum tensor, which means that light velocity is replaced by an effective light velocity. In fact, energy momentum tensor effectively replaces metric also in the modified Dirac equation whose form is dictated by super symmetry. Light-like four momentum is a rather general solution to the condition and corresponds to $\omega_0 = 0$ case.

Reduction of the dispersion relation to the graph of swallowtail catastrophe

Also the general structure of the equations for small perturbations allows to deduce highly non-trivial conclusions about the character of perturbations.

1. The equations for four CP_2 coordinates are simultaneously satisfied if the determinant associated with the equations vanishes. This condition defines a 3-dimensional surface in the 4-dimensional space defined by ω_0 and coordinates of 3-space playing the role of slowly varying control parameters. 4×4 determinant results and corresponds to a polynomial which is of order $d = 8$ in ω_0 . If the determinant is real, the polynomial can depend on ω_0^2 only so that a fourth order polynomial in $w = \omega_0^2$ results.
2. Only complex roots are possible in the case that the terms linear in $i\omega_0$ are non-vanishing. One might hope that the linear term vanishes for certain choices of the direction of slowly varying four-momentum vector $k^\mu(x)$ at least. For purely imaginary values of ω_0 the equations determinant are real always. Hence catastrophe theoretic description applies in this case at least, and the so called swallow tail [A68] with three control parameters applies to the situation.
3. The general form of the vanishing determinant is

$$D(w, a, b, c) = w^4 - ew^3 - cw^2 - bw - a \quad .$$

The transition from the oscillatory to purely dissipative case changes only the sign of w . By the shift $w = \hat{w} + e/4$ the determinant reduces to the canonical form

$$D(\hat{w}, a, b, c) = \hat{w}^4 - c\hat{w}^2 - b\hat{w} - a$$

of the swallowtail catastrophe. This catastrophe has three control variables, which basically correspond to the spatial 3-coordinates on which the induced metric and Kähler form depend. The variation of these coefficients at the space-time sheet of course covers only a finite region of the parameter space of the swallowtail catastrophe. The number of real roots for $w = \omega_0^2$ is four, two, or none since complex roots appear in complex conjugate pairs for a real polynomial. The general shape of the region of 3-space is that for a portion of swallow tail catastrophe.

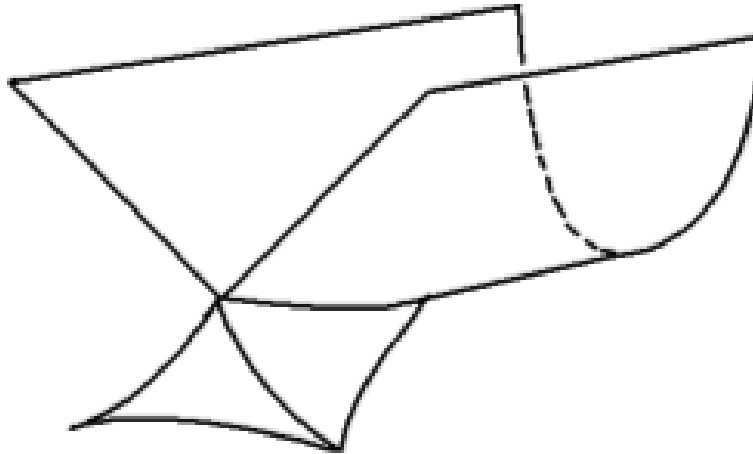

Figure 2.1: The projection of the bifurcation set of the swallowtail catastrophe to the 3-dimensional space of control variables. The potential function has four extrema in the interior of the swallowtail bounded by the triangles, no extrema in the valley above the swallowtail, and 2 extrema elsewhere.

4. The dispersion relation for the "rest mass" ω_0 (decay rate for the imaginary value of ω_0) has at most four real branches, which conforms with the fact that there are four dynamical variables. In real case ω_0 is analogous to plasma frequency acting as an infrared cutoff for the frequencies of plasma excitations. To get some grasp on the situation notice that for $a = 0$ the swallowtail reduces to $\hat{w} = 0$ and

$$\hat{w}^3 - c\hat{w} - b = 0 \quad ,$$

which represents the cusp catastrophe easy to illustrate in 3-dimensional space. Cusp in turn reduces for $b = 0$ to $\hat{w} = 0$ and fold catastrophe $\hat{w} = \pm\sqrt{c}$. Thus the catastrophe surface becomes 4-sheeted for $c \geq 0$ for sufficiently small values of the parameters a and b . The possibility of negative values of \hat{w} in principle allows $\omega^2 = \hat{w} + e/4 < 0$ solutions identifiable as exponentially decaying or amplified perturbations. At the high frequency limit the 4 branches degenerate to a single branch $T^{\alpha\beta}k_\alpha k_\beta = 0$, which as a special case gives light-like four-momenta corresponding to $\omega_0 = 0$ and the origin of the swallowtail catastrophe.



Figure 2.2: Cusp catastrophe. Vertical direction corresponds to the behavior variable and orthogonal directions to control variables.

5. It is quite possible that the imaginary terms proportional to $i\omega_0$ cannot be neglected in the time-like case. The interpretation would be as dissipative effects. If these effects are not too large, an approximate description in terms of butterfly catastrophe makes still sense. Note however that the second variation contains besides gravitational terms potentially large dissipative terms coming from the variation of the induced Kähler form and from the variation of CP_2 Christoffel symbols.
6. Additional complications are encountered at the points, where the induced Kähler field vanishes since the second variation vanishes identically at these points. By the arguments represented earlier, these points quite generally represent instabilities.

2.4 Vacuum extremals

Vacuum extremals come as two basic types: CP_2 type vacuum extremals for which the induced Kähler field and Kähler action are non-vanishing and the extremals for which the induced Kähler field vanishes. The deformations of both extremals are expected to be of fundamental importance in TGD universe. Vacuum extremals are not gravitational vacua and they are indeed fundamental in TGD inspired cosmology.

2.4.1 CP_2 type extremals

CP_2 type vacuum extremals

These extremals correspond to various isometric imbeddings of CP_2 to $M_+^4 \times CP_2$. One can also drill holes to CP_2 . Using the coordinates of CP_2 as coordinates for X^4 the imbedding is given by the formula

$$\begin{aligned} m^k &= m^k(u) , \\ m_{kl}\dot{m}^k\dot{m}^l &= 0 , \end{aligned} \tag{2.4.1}$$

where $u(s^k)$ is an arbitrary function of CP_2 coordinates. The latter condition tells that the curve representing the projection of X^4 to M^4 is light like curve. One can choose the functions $m^i, i = 1, 2, 3$ freely and solve m^0 from the condition expressing light likeness so that the number of this kind of extremals is very large.

The induced metric and Kähler field are just those of CP_2 and energy momentum tensor $T^{\alpha\beta}$ vanishes identically by the self duality of the Kähler form of CP_2 . Also the canonical current $j^\alpha =$

$D_\beta J^{\alpha\beta}$ associated with the Kähler form vanishes identically. Therefore the field equations in the interior of X^4 are satisfied. The field equations are also satisfied on the boundary components of CP_2 type extremal because the non-vanishing boundary term is, besides the normal component of Kähler electric field, also proportional to the projection operator to the normal space and vanishes identically since the induced metric and Kähler form are identical with the metric and Kähler form of CP_2 .

As a special case one obtains solutions for which M^4 projection is light like geodesic. The projection of $m^0 = \text{constant}$ surfaces to CP_2 is $u = \text{constant}$ 3-submanifold of CP_2 . Geometrically these solutions correspond to a propagation of a massless particle. In a more general case the interpretation as an orbit of a massless particle is not the only possibility. For example, one can imagine a situation, where the center of mass of the particle is at rest and motion occurs along a circle at say (m^1, m^2) plane. The interpretation as a massive particle is natural. Amusingly, there is nice analogy with the classical theory of Dirac electron: massive Dirac fermion moves also with the velocity of light (zitterbewegung). The quantization of this random motion with light velocity leads to Virasoro conditions and this led to a breakthrough in the understanding of the p-adic QFT limit of TGD. Furthermore, it has turned out that Super Virasoro invariance is a general symmetry of the configuration space geometry and quantum TGD and appears both at the level of imbedding space and space-time surfaces.

The action for all extremals is same and given by the Kähler action for the imbedding of CP_2 . The value of the action is given by

$$S = -\frac{\pi}{8\alpha_K} . \quad (2.4.2)$$

To derive this expression we have used the result that the value of Lagrangian is constant: $L = 4/R^4$, the volume of CP_2 is $V(CP_2) = \pi^2 R^4/2$ and the definition of the Kähler coupling strength $k_1 = 1/16\pi\alpha_K$ (by definition, πR is the length of CP_2 geodesics). Four-momentum vanishes for these extremals so that they can be regarded as vacuum extremals. The value of the action is negative so that these vacuum extremals are indeed favored by the minimization of the Kähler action. The absolute minimization of Kähler action suggests that ordinary vacuums with vanishing Kähler action density are unstable against the generation of CP_2 type extremals. There are even reasons to expect that CP_2 type extremals are for TGD what black holes are for GRT. Indeed, the nice generalization of the area law for the entropy of black hole [K34] supports this view.

In accordance with the basic ideas of TGD topologically condensed vacuum extremals should somehow correspond to massive particles. The properties of the CP_2 type vacuum extremals are in accordance with this interpretation. Although these objects move with a velocity of light, the motion can be transformed to a mere zitterbewegung so that the center of mass motion is trivial. Even the generation of the rest mass could be understood classically as a consequence of the minimization of action. Long range Kähler fields generate negative action for the topologically condensed vacuum extremal (momentum zero massless particle) and Kähler field energy in turn is identifiable as the rest mass of the topologically condensed particle.

An interesting feature of these objects is that they can be regarded as gravitational instantons [A50]. A further interesting feature of CP_2 type extremals is that they carry nontrivial classical color charges. The possible relationship of this feature to color confinement raises interesting questions. Could one model classically the formation of the color singlets to take place through the emission of "colorons": states with zero momentum but non-vanishing color? Could these peculiar states reflect the infrared properties of the color interactions?

Are CP_2 type non-vacuum extremals possible?

The isometric imbeddings of CP_2 are all vacuum extremals so that these extremals as such cannot correspond to physical particles. One obtains however nonvacuum extremals as deformations of these solutions. There are several types of deformations leading to nonvacuum solutions. In order to describe some of them, recall the expressions of metric and Kähler form of CP_2 in the coordinates (r, Θ, Ψ, Φ) [A62] are given by

$$\begin{aligned}
\frac{ds^2}{R^2} &= \frac{dr^2}{(1+r^2)^2} + \frac{r}{2(1+r^2)^2} (d\Psi + \cos(\Theta)d\Phi)^2 \\
&+ \frac{r^2}{4(1+r^2)} (d\Theta^2 + \sin^2\Theta d\Phi^2) , \\
J &= \frac{r}{(1+r^2)} dr \wedge (d\Psi + \cos(\Theta)d\Phi) \\
&- \frac{r^2}{2(1+r^2)} \sin(\Theta) d\Theta \wedge d\Phi .
\end{aligned} \tag{2.4.3}$$

The scaling of the line element is defined so that πR is the length of the CP_2 geodesic line. Note that Φ and Ψ appear as "cyclic" coordinates in metric and Kähler form: this feature plays important role in the solution ansatz to be described.

Let $M^4 = M^2 \times E^2$ denote the decomposition of M^4 to a product of 2-dimensional Minkowski space and 2-dimensional Euclidian plane. This decomposition corresponds physically to the decomposition of momentum degrees of freedom for massless particle: E^2 corresponds to polarization degrees of freedom.

There are several types of nonvacuum extremals.

1. "Virtual particle" extremals: the mass spectrum is continuous (also Euclidian momenta are allowed) but these extremals reduce to vacuum extremals in the massless limit.
2. Massless extremals.

Consider first an example of virtual particle extremal. The simplest extremal of this type is obtained in the following form

$$m^k = a^k \Psi + b^k \Phi . \tag{2.4.4}$$

Here a^k and b^k are some constant quantities. Field equations are equivalent to the conditions expressing four-momentum conservation and are identically satisfied the reason being that induced metric and Kähler form do not depend on the coordinates Ψ and Φ .

Extremal describes 3-surface, which moves with constant velocity in M^4 . Four-momentum of the solution can be both space and time like. In the massless limit solution however reduces to a vacuum extremal. Therefore the interpretation as an off mass shell massless particle seems appropriate.

Massless extremals are obtained from the following solution ansatz.

$$\begin{aligned}
m^0 &= m^3 = a\Psi + b\Phi , \\
(m^1, m^2) &= (m^1(r, \Theta), m^2(r, \Theta)) .
\end{aligned} \tag{2.4.5}$$

Only E^2 degrees of freedom contribute to the induced metric and the line element is obtained from

$$ds^2 = ds_{CP_2}^2 - (dm^1)^2 - (dm^2)^2 . \tag{2.4.6}$$

Field equations reduce to conservation condition for the components of four-momentum in E^2 plane. By their cyclicity the coordinates Ψ and Φ disappear from field equations and one obtains essentially current conservation condition for two-dimensional field theory defined in space spanned by the coordinates r and Θ .

$$\begin{aligned}
(J_a^i)_{,i} &= 0 , \\
J_a^i &= T^{ij} f_{,j}^a \sqrt{g} .
\end{aligned} \tag{2.4.7}$$

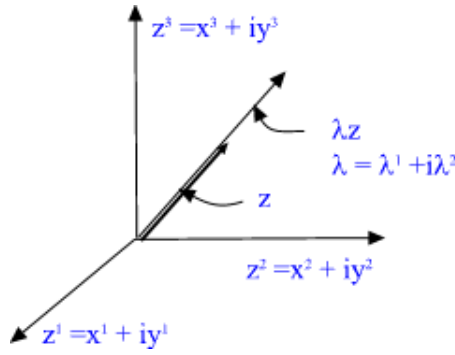

Figure 2.3: Topological sum of CP_2 :s as Feynman graph with lines thickened to four-manifolds

Here the index i and a refer to r and Θ and to E^2 coordinates m^1 and m^2 respectively. T^{ij} denotes the canonical energy momentum tensor associated with Kähler action. One can express the components of T^{ij} in terms of induced metric and CP_2 metric in the following form

$$T^{ij} = (-g^{ik}g^{jl} + g^{ij}g^{kl}/2)s_{kl} . \quad (2.4.8)$$

This expression holds true for all components of the energy momentum tensor.

Since field equations are essentially two-dimensional conservation conditions they imply that components of momentum currents can be regarded as vector fields of some canonical transformations

$$J_a^i = \varepsilon^{ij} H_{,j}^a , \quad (2.4.9)$$

where ε^{ij} denotes two-dimensional constant symplectic form. An open problem is whether one could solve field equations exactly and whether there exists some nonlinear superposition principle for the solutions of these equations. Solutions are massless since transversal momentum densities vanish identically.

Consider as a special case the solution obtained by assuming that one E^2 coordinate is constant and second coordinate is function $f(r)$ of the variable r only. Field equations reduce to the following form

$$f_{,r} = \pm \frac{k}{(1+r^2)^{1/3}} \sqrt{r^2 - k^2(1+r^2)^{4/3}} . \quad (2.4.10)$$

The solution is well defined only for sufficiently small values of the parameter k appearing as integration constant and becomes ill defined at two singular values of the variable r . Boundary conditions are identically satisfied at the singular values of r since the radial component of induced metric diverges at these values of r . The result leads to suspect that the generation of boundary components dynamically is a general phenomenon so that all nonvacuum solutions have boundary components in accordance with basic ideas of TGD.

$CP_2 \# CP_2 \# \dots \# CP_2$:s as generalized Feynman graphs

There are reasons to believe that point like particles might be identified as CP_2 type extremals in TGD approach. Also the geometric counterparts of the massless on mass shell particles and virtual particles have been identified. It is natural to extend this idea to the level of particle interactions: the lines of Feynman diagrams of quantum field theory are thickened to four-manifolds, which are in a good approximation CP_2 type vacuum extremals. This would mean that generalized Feynman graphs are essentially connected sums of CP_2 :s (see Fig. 2.4.1): $X^4 = CP_2 \# CP_2 \dots \# CP_2$.

Unfortunately, this picture seems to be oversimplified. First, it is questionable whether the cross sections for the scattering of CP_2 type extremals have anything to do with the cross sections associated with the standard gauge interactions. A naive geometric argument suggests that the cross section should reflect the geometric size of the scattered objects and therefore be of the order of CP_2 radius for topologically non-condensed CP_2 type extremals. The observed cross sections would result at the first level of condensation, where particles are effectively replaced by surfaces with size of order Compton length. Secondly, the $h_{vac} = -D$ rule, considered in the previous chapter, suggests that only real particles correspond to the CP_2 type extremals whereas virtual particles in general correspond to the vacuum extremals with a vanishing Kähler action. The reason is that the negative exponent of the Kähler action reduces the contribution of the CP_2 type extremals to the functional integral very effectively. Therefore the exchanges of CP_2 type extremals are suppressed by the negative exponent of the Kähler action very effectively so that geometric scattering cross section is obtained.

2.4.2 Vacuum extremals with vanishing Kähler field

Vacuum extremals correspond to 4-surfaces with vanishing Kähler field and therefore to gauge field zero configurations of gauge field theory. These surfaces have CP_2 projection, which is Legendre manifold. The condition expressing Legendre manifold property is obtained in the following manner. Kähler potential of CP_2 can be expressed in terms of the canonical coordinates (P_i, Q_i) for CP_2 as

$$A = \sum_k P_k dQ^k . \quad (2.4.11)$$

The conditions

$$P_k = \partial_{Q^k} f(Q^i) , \quad (2.4.12)$$

where $f(Q^i)$ is arbitrary function of its arguments, guarantee that Kähler potential is pure gauge. It is clear that canonical transformations, which act as local $U(1)$ gauge transformations, transform different vacuum configurations to each other so that vacuum degeneracy is enormous. Also M_+^4 diffeomorphisms act as the dynamical symmetries of the vacuum extremals. Some sub-group of these symmetries extends to the isometry group of the configuration space in the proposed construction of the configuration space metric. The vacuum degeneracy is still enhanced by the fact that the topology of the four-surface is practically free.

Vacuum extremals are certainly not absolute minima of the action. For the induced metric having Minkowski signature the generation of Kähler electric fields lowers the action. For Euclidian signature both electric and magnetic fields tend to reduce the action. Therefore the generation of Euclidian regions of space-time is expected to occur. CP_2 type extremals, identifiable as real (as contrast to virtual) elementary particles, can be indeed regarded as these Euclidian regions.

Particle like vacuum extremals can be classified roughly by the number of the compactified dimensions D having size given by CP_2 length. Thus one has $D_{CP_2} = 3$ for CP_2 type extremals, $D_{CP_2} = 2$ for string like objects, $D_{CP_2} = 1$ for membranes and $D_{CP_2} = 0$ for pieces of M^4 . As already mentioned, the rule $h_{vac} = -D$ relating the vacuum weight of the Super Virasoro representation to the number of compactified dimensions of the vacuum extremal is very suggestive. $D < 3$ vacuum extremals would correspond in this picture to virtual particles, whose contribution to the generalized Feynman diagram is not suppressed by the exponential of Kähler action unlike that associated with the virtual CP_2 type lines.

M^4 type vacuum extremals (representable as maps $M_+^4 \rightarrow CP_2$ by definition) are also expected to be natural idealizations of the space-time at long length scales obtained by smoothing out small scale topological inhomogenities (particles) and therefore they should correspond to space-time of GRT in a reasonable approximation.

The reason would be "Yin-Yang principle".

1. Consider first the option for which Kähler function corresponds to an absolute minimum of Kähler action. Vacuum functional as an exponent of Kähler function is expected to concentrate on those 3-surfaces for which the Kähler action is non-negative. On the other hand, the

requirement that Kähler action is absolute minimum for the space-time associated with a given 3-surface, tends to make the action negative. Therefore the vacuum functional is expected to differ considerably from zero only for 3-surfaces with a vanishing Kähler action per volume. It could also occur that the degeneracy of 3-surfaces with same large negative action compensates the exponent of Kähler function.

2. If preferred extrema correspond to Kähler calibrations or their duals [K81], Yin-Yang principle is modified to a more local principle. For Kähler calibrations (their duals) the absolute value of action in given region is minimized (maximized). A given region with positive (negative sign) of action density favors Kähler electric (magnetic) fields. In long length scales the average density of Kähler action per four-volume tends to vanish so that Kähler function of the entire universe is expected to be very nearly zero. This regularizes the theory automatically and implies that average Kähler action per volume vanishes. Positive and finite values of Kähler function are of course favored.

In both cases the vanishing of Kähler action per volume in long length scales makes vacuum extremals excellent idealizations for the smoothed out space-time surface. Robertson-Walker cosmologies provide a good example in this respect. As a matter fact the smoothed out space-time is not a mere fictive concept since larger space-time sheets realize it as a essential part of the Universe.

Several absolute minima could be possible and the non-determinism of the vacuum extremals is not expected to be reduced completely. The remaining degeneracy could be even infinite. A good example is provided by the vacuum extremals representable as maps $M_+^4 \rightarrow D^1$, where D^1 is one-dimensional curve of CP_2 . This degeneracy could be interpreted as a space-time correlate for the non-determinism of quantum jumps with maximal deterministic regions representing quantum states in a sequence of quantum jumps.

2.5 Non-vacuum extremals

2.5.1 Cosmic strings

Cosmic strings are extremals of type $X^2 \times S^2$, where X^2 is minimal surface in M_+^4 (analogous to the orbit of a bosonic string) and S^2 is the homologically non-trivial geodesic sphere of CP_2 . The action of these extremals is positive and thus absolute minima are certainly not in question. One can however consider the possibility that these extremals are building blocks of the absolute minimum space-time surfaces since the absolute minimization of the Kähler action is global rather than a local principle. Cosmic strings can contain also Kähler charged matter in the form of small holes containing elementary particle quantum numbers on their boundaries and the negative Kähler electric action for a topologically condensed cosmic string could cancel the Kähler magnetic action.

The string tension of the cosmic strings is given by

$$T = \frac{1}{8\alpha_K R^2} \simeq .2210^{-6} \frac{1}{G} , \quad (2.5.1)$$

where $\alpha_K \simeq \alpha_{em}$ has been used to get the numerical estimate. The string tension is of the same order of magnitude as the string tension of the cosmic strings of GUTs and this leads to the model of the galaxy formation providing a solution to the dark matter puzzle as well as to a model for large voids as caused by the presence of a strongly Kähler charged cosmic string. Cosmic strings play also fundamental role in the TGD inspired very early cosmology.

2.5.2 Massless extremals

Massless extremals (or topological light rays) are characterized by massless wave vector p and polarization vector ε orthogonal to this wave vector. Using the coordinates of M^4 as coordinates for X^4 the solution is given as

$$\begin{aligned} s^k &= f^k(u, v) , \\ u &= p \cdot m , & v &= \varepsilon \cdot m , \\ p \cdot \varepsilon &= 0 , & p^2 &= 0 . \end{aligned}$$

CP_2 coordinates are arbitrary functions of $p \cdot m$ and $\varepsilon \cdot m$. Clearly these solutions correspond to plane wave solutions of gauge field theories. It is important to notice however that linear super position doesn't hold as it holds in Maxwell phase. Gauge current is proportional to wave vector and its divergence vanishes as a consequence. Also cylindrically symmetric solutions for which the transverse coordinate is replaced with the radial coordinate $\rho = \sqrt{m_1^2 + m_2^2}$ are possible. In fact, v can be *any* function of the coordinates m^1, m^2 transversal to the light like vector p .

Boundary conditions on the boundaries of the massless extremal are satisfied provided the normal component of the energy momentum tensor vanishes. Since energy momentum tensor is of the form $T^{\alpha\beta} \propto p^\alpha p^\beta$ the conditions $T^{n\beta} = 0$ are satisfied if the M^4 projection of the boundary is given by the equations of form

$$\begin{aligned} H(p \cdot m, \varepsilon \cdot m, \varepsilon_1 \cdot m) &= 0 \quad , \\ \varepsilon \cdot p &= 0 \quad , \quad \varepsilon_1 \cdot p = 0 \quad , \quad \varepsilon \cdot \varepsilon_1 = 0 \quad . \end{aligned} \quad (2.5.2)$$

where H is arbitrary function of its arguments. Recall that for M^4 type extremals the boundary conditions are also satisfied if Kähler field vanishes identically on the boundary.

The following argument suggests that there are not very many manners to satisfy boundary conditions in case of M^4 type extremals. The boundary conditions, when applied to M^4 coordinates imply the vanishing of the normal component of energy momentum tensor. Using coordinates, where energy momentum tensor is diagonal, the requirement boils down to the condition that at least one of the eigen values of $T^{\alpha\beta}$ vanishes so that the determinant $\det(T^{\alpha\beta})$ must vanish on the boundary: this condition defines 3-dimensional surface in X^4 . In addition, the normal of this surface must have same direction as the eigen vector associated with the vanishing eigen value: this means that three additional conditions must be satisfied and this is in general true in single point only. The boundary conditions in CP_2 coordinates are satisfied provided that the conditions

$$J^{n\beta} J_l^k \partial_\beta s^l = 0$$

are satisfied. The identical vanishing of the normal components of Kähler electric and magnetic fields on the boundary of massless extremal property provides a manner to satisfy all boundary conditions but it is not clear whether there are any other manners to satisfy them.

The characteristic feature of the massless extremals is that in general the Kähler gauge current is non-vanishing. In ordinary Maxwell electrodynamicis this is not possible. This means that these extremals are accompanied by vacuum current, which contains in general case both weak and electromagnetic terms as well as color part.

A possible interpretation of the solution is as the exterior space-time to a topologically condensed particle with vanishing mass described by massless CP_2 type extremal, say photon or neutrino. In general the surfaces in question have boundaries since the coordinates s^k are bounded this is in accordance with the general ideas about topological condensation. The fact that massless plane wave is associated with CP_2 type extremal combines neatly the wave and particle aspects at geometrical level.

The fractal hierarchy of space-time sheets implies that massless extremals should be interesting also in long length scales. The presence of a light like electromagnetic vacuum current implies the generation of coherent photons and also coherent gravitons are generated since the Einstein tensor is also non-vanishing and light like (proportional to $k^\alpha k^\beta$). Massless extremals play an important role in the TGD based model of bio-system as a macroscopic quantum system. The possibility of vacuum currents is what makes possible the generation of the highly desired coherent photon states.

2.5.3 Generalization of the solution ansatz defining massless extremals (MEs)

The solution ansatz for MEs has developed gradually to an increasingly general form and the following formulation is the most general one achieved hitherto. Rather remarkably, it rather closely resembles the solution ansatz for the CP_2 type extremals and has direct interpretation in terms of geometric optics. Equally remarkable is that the latest generalization based on the introduction of the local light cone coordinates was inspired by quantum holography principle.

The solution ansatz for MEs has developed gradually to an increasingly general form and the following formulation is the most general one achieved hitherto. Rather remarkably, it rather closely resembles the solution ansatz for the CP_2 type extremals and has direct interpretation in terms of geometric optics. Equally remarkable is that the latest generalization based on the introduction of the local light cone coordinates was inspired by quantum holography principle.

Local light cone coordinates

The solution involves a decomposition of M^4_+ tangent space localizing the decomposition of Minkowski space to an orthogonal direct sum $M^2 \oplus E^2$ defined by light-like wave vector and polarization vector orthogonal to it. This decomposition defines what might be called local light cone coordinates.

1. Denote by m^i the linear Minkowski coordinates of M^4 . Let (S^+, S^-, E^1, E^2) denote local coordinates of M^4_+ defining a *local* decomposition of the tangent space M^4 of M^4_+ into a direct *orthogonal* sum $M^4 = M^2 \oplus E^2$ of spaces M^2 and E^2 . This decomposition has interpretation in terms of the longitudinal and transversal degrees of freedom defined by local light-like four-velocities $v_{\pm} = \nabla S_{\pm}$ and polarization vectors $\epsilon_i = \nabla E^i$ assignable to light ray.
2. With these assumptions the coordinates (S_{\pm}, E^i) define local light cone coordinates with the metric element having the form

$$ds^2 = 2g_{+-}dS^+dS^- + g_{11}(dE^1)^2 + g_{22}(dE^2)^2 . \quad (2.5.3)$$

If complex coordinates are used in transversal degrees of freedom one has $g_{11} = g_{22}$.

3. This family of light cone coordinates is not the most general family since longitudinal and transversal spaces are orthogonal. One can also consider light-cone coordinates for which one non-diagonal component, say m_{1+} , is non-vanishing if the solution ansatz is such that longitudinal and transversal spaces are orthogonal for the induced metric.

A conformally invariant family of local light cone coordinates

The simplest solutions to the equations defining local light cone coordinates are of form $S_{\pm} = k \cdot m$ giving as a special case $S_{\pm} = m^0 \pm m^3$. For more general solutions of from

$$S_{\pm} = m^0 \pm f(m^1, m^2, m^3) , \quad (\nabla_3 f)^2 = 1 ,$$

where f is an otherwise arbitrary function, this relationship reads as

$$S^+ + S^- = 2m^0 .$$

This condition defines a natural rest frame. One can integrate f from its initial data at some two-dimensional $f = \text{constant}$ surface and solution describes curvilinear light rays emanating from this surface and orthogonal to it. The flow velocity field $\bar{v} = \nabla f$ is irrotational so that closed flow lines are not possible in a connected region of space and the condition $\bar{v}^2 = 1$ excludes also closed flow line configuration with singularity at origin such as $v = 1/\rho$ rotational flow around axis.

One can identify E^2 as a local tangent space spanned by polarization vectors and orthogonal to the flow lines of the velocity field $\bar{v} = \nabla f(m^1, m^2, m^3)$. Since the metric tensor of any 3-dimensional space allows always diagonalization in suitable coordinates, one can always find coordinates (E^1, E^2) such that (f, E^1, E^2) form orthogonal coordinates for $m^0 = \text{constant}$ hyperplane. Obviously one can select the coordinates E^1 and E^2 in infinitely many manners.

Closer inspection of the conditions defining local light cone coordinates

Whether the conformal transforms of the local light cone coordinates $\{S_{\pm} = m^0 \pm f(m^1, m^2, m^3), E^i\}$ define the only possible compositions $M^2 \oplus E^2$ with the required properties, remains an open question. The best that one might hope is that any function S^+ defining a family of light-like curves defines a local decomposition $M^4 = M^2 \oplus E^2$ with required properties.

1. Suppose that S^+ and S^- define light-like vector fields which are not orthogonal (proportional to each other). Suppose that the polarization vector fields $\epsilon_i = \nabla E^i$ tangential to local E^2 satisfy the conditions $\epsilon_i \cdot \nabla S^+ = 0$. One can formally integrate the functions E^i from these condition since the initial values of E^i are given at $m^0 = \text{constant}$ slice.
2. The solution to the condition $\nabla S_+ \cdot \epsilon_i = 0$ is determined only modulo the replacement

$$\epsilon_i \rightarrow \hat{\epsilon}_i = \epsilon_i + k \nabla S_+ \quad ,$$

where k is any function. With the choice

$$k = -\frac{\nabla E^i \cdot \nabla S^-}{\nabla S^+ \cdot \nabla S^-}$$

one can satisfy also the condition $\hat{\epsilon}_i \cdot \nabla S^- = 0$.

3. The requirement that also $\hat{\epsilon}_i$ is gradient is satisfied if the integrability condition

$$k = k(S^+)$$

is satisfied in this case $\hat{\epsilon}_i$ is obtained by a gauge transformation from ϵ_i . The integrability condition can be regarded as an additional, and obviously very strong, condition for S^- once S^+ and E^i are known.

4. The problem boils down to that of finding local momentum and polarization directions defined by the functions S^+ , S^- and E^1 and E^2 satisfying the orthogonality and integrability conditions

$$(\nabla S^+)^2 = (\nabla S^-)^2 = 0 \quad , \quad \nabla S^+ \cdot \nabla S^- \neq 0 \quad ,$$

$$\nabla S^+ \cdot \nabla E^i = 0 \quad , \quad \frac{\nabla E^i \cdot \nabla S^-}{\nabla S^+ \cdot \nabla S^-} = k_i(S^+) \quad .$$

The number of integrability conditions is 3+3 (all derivatives of k_i except the one with respect to S^+ vanish): thus it seems that there are not much hopes of finding a solution unless some discrete symmetry relating S^+ and S^- eliminates the integrability conditions altogether.

A generalization of the spatial reflection $f \rightarrow -f$ working for the separable Hamilton Jacobi function $S_{\pm} = m^0 \pm f$ ansatz could relate S^+ and S^- to each other and trivialize the integrability conditions. The symmetry transformation of M_+^4 must perform the permutation $S^+ \leftrightarrow S^-$, preserve the light-likeness property, map E^2 to E^2 , and multiply the inner products between M^2 and E^2 vectors by a mere conformal factor. This encourages the conjecture that all solutions are obtained by conformal transformations from the solutions $S_{\pm} = m^0 \pm f$.

General solution ansatz for MEs for given choice of local light cone coordinates

Consider now the general solution ansatz assuming that a local wave-vector-polarization decomposition of M_+^4 tangent space has been found.

1. Let $E(S^+, E^1, E^2)$ be an arbitrary function of its arguments: the gradient ∇E defines at each point of E^2 an S^+ -dependent (and thus time dependent) polarization direction orthogonal to the direction of local wave vector defined by ∇S^+ . Polarization vector depends on E^2 position only.
2. Quite a general family of MEs corresponds to the solution family of the field equations having the general form

$$s^k = f^k(S^+, E) \quad ,$$

where s^k denotes CP_2 coordinates and f^k is an arbitrary function of S^+ and E . The solution represents a wave propagating with light velocity and having definite S^+ dependent polarization

in the direction of ∇E . By replacing S^+ with S^- one obtains a dual solution. Field equations are satisfied because energy momentum tensor and Kähler current are light-like so that all tensor contractions involved with the field equations vanish: the orthogonality of M^2 and E^2 is essential for the light-likeness of energy momentum tensor and Kähler current.

3. The simplest solutions of the form $S_{\pm} = m^0 \pm m^3$, $(E^1, E^2) = (m^1, m^2)$ and correspond to a cylindrical MEs representing waves propagating in the direction of the cylinder axis with light velocity and having polarization which depends on point (E^1, E^2) and S^+ (and thus time). For these solutions four-momentum is light-like: for more general solutions this cannot be the case. Polarization is in general case time dependent so that both linearly and circularly polarized waves are possible. If m^3 varies in a finite range of length L , then 'free' solution represents geometrically a cylinder of length L moving with a light velocity. Of course, ends could be also anchored to the emitting or absorbing space-time surfaces.
4. For the general solution the cylinder is replaced by a three-dimensional family of light like curves and in this case the rectilinear motion of the ends of the cylinder is replaced with a curvilinear motion with light velocity unless the ends are anchored to emitting/absorbing space-time surfaces. The non-rotational character of the velocity flow suggests that the freely moving particle like 3-surface defined by ME cannot remain in a infinite spatial volume. The most general ansatz for MEs should be useful in the intermediate and nearby regions of a radiating object whereas in the far away region radiation solution is expected to decompose to cylindrical ray like MEs for which the function $f(m^1, m^2, m^2)$ is a linear function of m^i .
5. One can try to generalize the solution ansatz further by allowing the metric of M_{\pm}^4 to have components of type g_{i+} or g_{i-} in the light cone coordinates used. The vanishing of T^{11} , T^{+1} , and T^{-} is achieved if $g_{i\pm} = 0$ holds true for the induced metric. For $s^k = s^k(S^+, E^1)$ ansatz neither $g_{2\pm}$ nor g_{1-} is affected by the imbedding so that these components of the metric must vanish for the Hamilton Jacobi structure:

$$ds^2 = 2g_{+-}dS^+dS^- + 2g_{1+}dE^1dS^+ + g_{11}(dE^1)^2 + g_{22}(dE^2)^2 . \quad (2.5.4)$$

$g_{1+} = 0$ can be achieved by an additional condition

$$m_{1+} = s_{kl}\partial_1 s^k \partial_+ s^k . \quad (2.5.5)$$

The diagonalization of the metric seems to be a general aspect of absolute minima. The absence of metric correlations between space-time degrees of freedom for asymptotic self-organization patterns is somewhat analogous to the minimization of non-bound entanglement in the final state of the quantum jump.

Are the boundaries of space-time sheets quite generally light like surfaces with Hamilton Jacobi structure?

Quantum holography principle naturally generalizes to an approximate principle expected to hold true also in non-cosmological length and time scales.

1. The most general ansatz for topological light rays or massless extremals (MEs) inspired by the quantum holographic thinking relies on the introduction of the notion of local light cone coordinates S_+, S_-, E_1, E_2 . The gradients ∇S_+ and ∇S_- define two light like directions just like Hamilton Jacobi functions define the direction of propagation of wave in geometric optics. The two polarization vector fields ∇E_1 and ∇E_2 are orthogonal to the direction of propagation defined by either S_+ or S_- . Since also E_1 and E_2 can be chosen to be orthogonal, the metric of M_{\pm}^4 can be written locally as $ds^2 = g_{+-}dS_+dS_- + g_{11}dE_1^2 + g_{22}dE_2^2$. In the earlier ansatz S_+ and S_- were restricted to the variables $k \cdot m$ and $\tilde{k} \cdot m$, where k and \tilde{k} correspond to light like momentum and its mirror image and m denotes linear M^4 coordinates: these MEs describe cylindrical structures with constant direction of wave propagation expected to be most important in regions faraway from the source of radiation.

2. Boundary conditions are satisfied if the 3-dimensional boundaries of MEs have one light like direction (S_+ or S_- is constant). This means that the boundary of ME has metric dimension $d = 2$ and is characterized by an infinite-dimensional super-symplectic and super-conformal symmetries just like the boundary of the imbedding space $M_+^4 \times CP_2$: The boundaries are like moments for mini big bangs (in TGD based fractal cosmology big bang is replaced with a silent whisper amplified to not necessarily so big bang).
3. These observations inspire the conjecture that boundary conditions for M^4 like space-time sheets fixed by the absolute minimization of Kähler action quite generally require that space-time boundaries correspond to light like 3-surfaces with metric dimension equal to $d = 2$. This does not yet imply that light like surfaces of imbedding space would take the role of the light cone boundary: these light like surface could be seen only as a special case of causal determinants analogous to event horizons.

2.5.4 Maxwell phase

"Maxwell phase" corresponds to small deformations of the M^4 type vacuum extremals. Since energy momentum tensor is quadratic in Kähler field the term proportional to the contraction of the energy momentum tensor with second fundamental form drops from field equations and one obtains in lowest order the following field equations

$$j^\alpha J_{ls,\alpha}^k = 0 . \quad (2.5.6)$$

These equations are satisfied if Maxwell's equations

$$j^\alpha = 0 \quad (2.5.7)$$

hold true. Massless extremals and Maxwell phase clearly exclude each other and it seems that they must corresponds to different space-time sheets.

The explicit construction of these extremals reduces to the task of finding an imbedding for an arbitrary free Maxwell field to H . One can also allow source terms corresponding to the presence of the point like charges: these should correspond to the regions of the space-time, where the flat space-time approximation of the space-time fails. The regions where the approximation defining the Maxwell phase fails might correspond to a topologically condensed CP_2 type extremals, for example. As a consequence, Kähler field is superposition of radiation type Kähler field and of Coulombic term. A second possibility is the generation of "hole" with similar Coulombic Kähler field.

An important property of the Maxwell phase (also of massless extremals) is its approximate canonical invariance. Canonical transformations do not spoil the extremal property of the four-surface in the approximation used, since it corresponds to a mere $U(1)$ gauge transformation. This implies the counter part of the vacuum degeneracy, that is, the existence of an enormous number of four-surfaces with very nearly the same action. Also there is an approximate $Diff(M_+^4)$ invariance.

The canonical degeneracy has some very interesting consequences concerning the understanding of the electro-weak symmetry breaking and color confinement. Kähler field is canonical invariant and satisfies Maxwells equations. This is in accordance with the identification of Kähler field as $U(1)$ part of the electro-weak gauge field. Electromagnetic gauge field is a superposition of Kähler field and Z^0 field $\gamma = 3J - \sin^2(\theta_W)Z^0/2$ so that also electromagnetic gauge field is long ranged assuming that Z^0 and W^+ fields are short ranged. These fields are not canonical invariants and their behavior seems to be essentially random, which implies short range correlations and the consequent massivation.

There is an objection against this argument. For the known $D < 4$ solutions of field equations weak fields are not random at all. These situations could represent asymptotic configurations assignable to space-time sheets. This conforms with the interpretation that weak gauge fields are essentially massless within the asymptotic space-time sheets representing weak bosons. Gauge fields are however transferred between space-time sheets through # contacts modelable as pieces of CP_2 type extremals having $D_{CP_2} = 4$. In contrast to Kähler and color gauge fluxes, weak gauge fluxes are not conserved in the Euclidian time evolution between the 3-D causal horizons separating the Euclidian # contact from space-time sheets with Minkowskian signature. This non-conservation implying the loss of coherence

in the transfer of fields between space-time sheets is a plausible mechanism for the loss of correlations and massivation of the weak gauge fields.

Classical gluon fields are proportional to Kähler field and to the Hamiltonians associated with the color isometry generators.

$$g_{\alpha\beta}^A = kH^A J_{\alpha\beta} . \quad (2.5.8)$$

This implies that the direction of gluon fields in color algebra is random. One can always perform a canonical transformation, which reduces to a global color rotation in some arbitrary small region of space-time and reduces to identity outside this region. The proportionality of a gluon field to Kähler form implies that there is a classical long range correlation in X^4 degrees of freedom: in this sense classical gluon fields differ from massive electro-weak fields in Maxwell phase.

2.5.5 Stationary, spherically symmetric extremals

The stationary, spherically symmetric extremals of the Kähler action imbeddable in $M^4 \times S^2$, where S^2 is geodesic sphere, are the simplest extremals, which one can study as models for the space-time surrounding a topologically condensed particle, say CP_2 type vacuum extremal. In the region near the particle the spherical symmetry is an unrealistic assumption since it excludes the presence of magnetic fields needed to cancel the total Kähler action. The stationarity is also unrealistic assumption since zitterbewegung seems to provide a necessary mechanism for generating Kähler magnetic field and for satisfying boundary conditions. Also the imbeddability to $M^4 \times S^2$ implies unrealistic relationship between Z^0 and photon charges.

According to the general wisdom, the generation of a Kähler electric field must take place in order to minimize the action and it indeed turns out that the extremal is characterized by essentially $1/r^2$ Kähler electric field. The necessary presence of a hole or of a topologically condensed object is also demonstrated: it is impossible to find extremals well defined in the region surrounding the origin. It is impossible to satisfy boundary conditions at a hole: this is in accordance with the idea that Euclidian region corresponding to a CP_2 type extremal performing zitterbewegung is generated. In case of CP_2 extremal radius is of the order of the Compton length of the particle and in case of a "hole" of the order of Planck length. The value of the vacuum frequency ω is of order of particle mass whereas for macroscopic vacuum extremals it must be of the order of $1/R$. This does not lead to a contradiction if the concept of a many-sheeted space-time is accepted.

The Poincare energy of the exterior region is considerably smaller than the gravitational mass; this conforms with the interpretation that gravitational mass is sum of absolute values of positive and negative inertial masses associated with matter and negative energy antimatter. It is quite possible that classical considerations cannot provide much understanding concerning the inertial masses of topologically condensed particles. Electro-weak gauge forces are considerably weaker than the gravitational force at large distances, when the value of the frequency parameter ω is of order $1/R$. Both these desirable properties fail to be true if CP_2 radius is of order Planck length as believed earlier.

In light of the general ideas about topological condensation it is clear that in planetary length scales these kind of extremals cannot provide a realistic description of space-time. Indeed, spherically symmetric extremals predict a wrong rate for the precession of the perihelion of Mercury. Schwarzschild and Reissner-Nordström metric do this and indeed allow imbedding as vacuum extremals for which the inertial masses of positive energy matter and negative energy antimatter sum up to zero.

This does not yet resolve the interpretational challenge due to the unavoidable long range color and weak gauge fields. A dark matter hierarchy giving rise to a hierarchy of color and electro-weak physics characterized by increasing values of weak and confinement scales explains these fields. # contacts involve a pair of causal horizons at which the Euclidian metric signature of # contact transforms to Minkowskian one. These causal horizons have interpretation as partons so that # contact can be regarded as a bound state of partons bound together by a gravitational instanton (CP_2 type extremal). # contacts provide basic example of dark matter creating long ranged weak fields.

An important result is the correlation between the sign of the vacuum frequency ω and that of the Kähler charge, which is of opposite sign for fermions and anti-fermions. This suggests an explanation for matter-antimatter asymmetry. Matter and antimatter condense stably on disjoint regions of the space-time surface at different space-time sheets. Stable antimatter could correspond

to negative time orientation and negative energy. This leads to a model for the primordial generation of matter as spontaneous generation of zero energy # contacts between space-time sheets of opposite time orientations. If CP conjugation is not exact symmetry, # contacts and their CP conjugates are created with slightly different rates and this gives rise to CP asymmetry at each of the two space-time sheets involved. After the splitting of # contacts and subsequent annihilation of particles and antiparticles at each space-time sheet, the two space-time sheets contain only positive energy matter and negative energy antimatter.

General solution ansatz

The general form of the solution ansatz is obtained by assuming that the space-time surface in question is a sub-manifold of $M^4 \times S^2$, where S^2 is the homologically non-trivial geodesic sphere of CP_2 . S^2 is most conveniently realized as $r = \infty$ surface of CP_2 , for which all values of the coordinate Ψ correspond to same point of CP_2 so that one can use Θ and Φ as the coordinates of S^2 .

The solution ansatz is given by the expression

$$\begin{aligned} \cos(\Theta) &= u(r) , \\ \Phi &= \omega t , \\ m^0 &= \lambda t , \\ r_M &= r , \quad \theta_M = \theta , \quad \phi_M = \phi . \end{aligned} \tag{2.5.9}$$

The induced metric is given by the expression

$$ds^2 = \left[\lambda^2 - \frac{R^2}{4} \omega^2 (1 - u^2) \right] dt^2 - \left(1 + \frac{R^2}{4} \theta_{,r}^2 \right) dr^2 - r^2 d\Omega^2 . \tag{2.5.10}$$

The value of the parameter λ is fixed by the condition $g_{tt}(\infty) = 1$:

$$\lambda^2 - \frac{R^2}{4} \omega^2 (1 - u(\infty)^2) = 1 . \tag{2.5.11}$$

From the condition $e^0 \wedge e^3 = 0$ the non-vanishing components of the induced Kähler field are given by the expression

$$J_{tr} = \frac{\omega}{4} u_{,r} . \tag{2.5.12}$$

Geodesic sphere property implies that Z^0 and photon fields are proportional to Kähler field:

$$\begin{aligned} \gamma &= (3 - p/2) J , \\ Z^0 &= J . \end{aligned} \tag{2.5.13}$$

From this formula one obtains the expressions

$$\begin{aligned} Q_{em} &= \frac{(3 - p/2)}{4\pi\alpha_{em}} Q_K , \quad Q_Z = \frac{1}{4\pi\alpha_Z} Q , \\ Q &\equiv \frac{J_{tr} 4\pi r^2}{\sqrt{-g_{rr} g_{tt}}} . \end{aligned} \tag{2.5.14}$$

for the electromagnetic and Z^0 charges of the solution using e and g_Z as unit.

Field equations can be written as conditions for energy momentum conservation (two equations is in principle all what is needed in the case of geodesic sphere). Energy conservation holds identically true and conservation of momentum, say, in z -direction gives the equation

$$(T^{rr}z_{,r})_{,r} + (T^{\theta\theta}z_{,\theta})_{,\theta} = 0 . \quad (2.5.15)$$

Using the explicit expressions for the components of the energy momentum tensor

$$\begin{aligned} T^{rr} &= g^{rr}L/2 , \\ T^{\theta\theta} &= -g^{\theta\theta}L/2 , \\ L &= g^{tt}g^{rr}(J_{tr})^2\sqrt{g}/2 , \end{aligned} \quad (2.5.16)$$

and the following notations

$$\begin{aligned} A &= g^{tt}g^{rr}r^2\sqrt{-g_{tt}g_{rr}} , \\ X &\equiv (J_{tr})^2 , \end{aligned} \quad (2.5.17)$$

the field equations reduce to the following form

$$(g^{rr}AX)_{,r} - \frac{2AX}{r} = 0 . \quad (2.5.18)$$

In the approximation $g^{rr} = 1$ this equation can be readily integrated to give $AX = C/r^2$. Integrating Eq. (4.6.7), one obtains integral equation for X

$$J_{tr} = \frac{q}{r_c} (|g_{rr}|^3 g_{tt})^{1/4} \exp\left(\int_{r_c}^r dr \frac{g_{rr}}{r}\right) \frac{1}{r} , \quad (2.5.19)$$

where q is integration constant, which is related to the charge parameter of the long range Kähler electric field associated with the solution. r_c denotes the critical radius at which the solution ceases to be well defined.

The inspection of this formula shows that J_{tr} behaves essentially as $1/r^2$ Coulomb field. This behavior doesn't depend on the detailed properties of the solution ansatz (for example the imbeddability to $M^4 \times S^2$): stationarity and spherical symmetry is what matters only. The compactness of CP_2 means that stationary, spherically symmetric solution is not possible in the region containing origin. This is in concordance with the idea that either a hole surrounds the origin or there is a topologically condensed CP_2 extremal performing zitterbewegung near the origin and making the solution non-stationary and breaking spherical symmetry.

Second integration gives the following integral equation for CP_2 coordinate $u = \cos(\Theta)$

$$u(r) = u_0 + \frac{4q}{\omega} \int_{r_c}^r (-g_{rr}^3 g_{tt})^{1/4} \frac{1}{r} \exp\left(\int_{r_c}^r dr \frac{g_{rr}}{r}\right) . \quad (2.5.20)$$

Here u_0 denotes the value of the coordinate u at $r = r_0$.

The form of the field equation suggests a natural iterative procedure for the numerical construction of the solution for large values of r .

$$u_n(r) = T_{n-1} , \quad (2.5.21)$$

where T_{n-1} is evaluated using the induced metric associated with u_{n-1} . The physical content of the approximation procedure is clear: estimate the gravitational effects using lower order solution since these are expected to be small.

A more convenient manner to solve u is based on Taylor expansion around the point $V \equiv 1/r = 0$. The coefficients appearing in the power series expansion $u = \sum_n u_n A^n V^n$: $A = q/\omega$ can be solved by calculating successive derivatives of the integral equation for u .

The lowest order solution is simply

$$u_0 = u_\infty , \quad (2.5.22)$$

and the corresponding metric is flat metric. In the first order one obtains for $u(r)$ the expression

$$u = u_\infty - \frac{4q}{\omega r} , \quad (2.5.23)$$

which expresses the fact that Kähler field behaves essentially as $1/r^2$ Coulomb field. The behavior of u as a function of r is identical with that obtained for the imbedding of the Reissner-Nordström solution.

To study the properties of the solution we fix the signs of the parameters in the following manner:

$$u_\infty < 0 , \quad q < 0 , \quad \omega > 0 \quad (2.5.24)$$

(reasons become clear later).

Concerning the behavior of the solution one can consider two different cases.

1) The condition $g_{tt} > 0$ hold true for all values of Θ . In this case u decreases and the rate of decrease gets faster for small values of r . This means that in the lowest order the solution becomes certainly ill defined at a critical radius $r = r_c$ given by the the condition $u = 1$: the reason is that u cannot get values large than one. The expression of the critical radius is given by

$$\begin{aligned} r_c &\geq \frac{4q}{(|u_\infty| + 1)\omega} \\ &= \frac{4\alpha Q_{em}}{(3 - p/2)(|u_\infty| + 1)\omega} . \end{aligned} \quad (2.5.25)$$

The presence of the critical radius for the actual solution is also a necessity as the inspection of the expression for J_{tr} shows: $\partial_r \theta$ grows near the origin without bound and $u = 1$ is reached at some finite value of r . Boundary conditions require that the quantity $X = T^{rr} \sqrt{g}$ vanishes at critical radius (no momentum flows through the boundary). Substituting the expression of J_{tr} from the field equation to T^{rr} the expression for X reduces to a form, from which it is clear that X cannot vanish. The cautious conclusion is that boundary conditions cannot be satisfied and the underlying reason is probably the stationarity and spherical symmetry of the solution. Physical intuition suggests that that CP_2 type extremal performing zitterbewegung is needed to satisfy the boundary conditions.

2) g_{tt} vanishes for some value of Θ . In this case the radial derivative of u together with g_{tt} can become zero for some value of $r = r_c$. Boundary conditions can be satisfied only provided $r_c = 0$. Thus it seems that for the values of ω satisfying the condition $\omega^2 = \frac{4\lambda^2}{R^2 \sin^2(\Theta_0)}$ it might be possible to find a globally defined solution. The study of differential equation for u however shows that the ansatz doesn't work. The conclusion is that although the boundary is generated it is not possible to satisfy boundary conditions.

A direct calculation of the coefficients u_n from power series expansion gives the following third order polynomial approximation for u ($V = 1/r$)

$$\begin{aligned} u &= \sum_n u_n A^n V^n , \\ u_0 &= u_\infty (< 0) , \quad u_1 = 1 , \\ u_2 &= K|u_\infty| , \quad u_3 = K(1 + 4K|u_\infty|) , \\ A &\equiv \frac{4q}{\omega} , \quad K \equiv \omega^2 \frac{R^2}{4} . \end{aligned} \quad (2.5.26)$$

The coefficients u_2 and u_3 are indeed positive which means that the value of the critical radius gets larger at least in these orders.

Solution contains three parameters: Kähler electric flux $Q = 4\pi q$, parameter ωR and parameter u_∞ . The latter parameters can be regarded as parameters describing the properties of a flat vacuum extremal (lowest order solution) to which particle like solution is glued and are analogous to the parameters describing symmetry broken vacuum in gauge theories.

Solution is not a realistic model for topological condensation

The solution does not provide realistic model for topological condensation although it gives indirect support for some essential assumptions of TGD based description of Higgs mechanism.

1. When the value of ω is of the order of CP_2 mass the solution could be interpreted as the "exterior metric" of a "hole".
 - i) The radius of the hole is of the order of CP_2 length and its mass is of the order of CP_2 mass.
 - ii) Kähler electric field is generated and charge renormalization takes place classically at CP_2 length scales as is clear from the expression of $Q(r)$: $Q(r) \propto \left(\frac{-g_{rr}}{g_{tt}}\right)^{1/4}$ and charge increases at short distances.
 - iii) The existence of the critical radius is unavoidable but boundary conditions cannot be satisfied. The failure to satisfy boundary conditions might be related to stationarity or to the absence of magnetic field. The motion of the boundary component with velocity of light might be the only manner to satisfy boundary conditions. Second possibility is the breaking of spherical symmetry by the generation of a static magnetic field.
 - iv) The absence of the Kähler magnetic field implies that the Kähler action has an infinite magnitude and the probability of the configuration is zero. A more realistic solution ansatz would break spherical symmetry containing dipole type magnetic field in the nearby region of the hole. The motion of the boundary with a velocity of light could serve as an alternative mechanism for the generation of magnetic field. The third possibility, supported by physical intuition, is that one must give up "hole" type extremal totally.
2. For sufficiently large values of r and for small values of ω (of the order of elementary particle mass scale), the solution might provide an approximate description for the region surrounding elementary particle. Although it is not possible to satisfy boundary conditions the order of magnitude estimate for the size of critical radius ($r_c \simeq \alpha/\omega$) should hold true for more realistic solutions, too. The order of magnitude for the critical radius is smaller than Compton length or larger if the vacuum parameter ω is larger than the mass of the particle. In macroscopic length scales the value of ω is of order $1/R$. This does not lead to a contradiction if the many-sheeted space-time concept is accepted so that $\omega < m$ corresponds to elementary particle space-time sheet. An unrealistic feature of the solution is that the relationship between Z^0 and em charges is not correct: Z^0 charge should be very small in these length scales.

Exterior solution cannot be identified as a counter part of Schwarzschild solution

The first thing, which comes into mind is to ask whether one might identify exterior solution as the TGD counterpart of the Schwarzschild solution. The identification of gravitational mass as absolute value of inertial mass which is negative for antimatter implies that vacuum extremals are vacua only with respect to the inertial four-momentum and have a non-vanishing gravitational four-momentum. Hence, in the approximation that the net density of inertial mass vanishes, vacuum extremals provide the proper manner to model matter, and the identification of spherically symmetric extremal as the counterpart of Schwarzschild metric is certainly not possible. It is however useful to show explicitly that the identification is indeed unrealistic. The solution is consistent with Equivalence Principle but the electro-weak gauge forces are considerably weaker than gravitational forces. A wrong perihelion shift is also predicted so that the identification as an exterior metric of macroscopic objects is out of question.

1. Is Equivalence Principle respected?

TGD predicts the possibility of negative classical energy for space-time sheets with negative time orientation, and the only manner to second quantize induced spinor fields without diverging vacuum energy is by assuming that fermions have positive energies and anti-fermions negative energies (vice

versa for phase conjugate fermions). This modifies the original form of Equivalence Principle: gravitational mass can be interpreted as absolute value of inertial mass so that the density of gravitational mass becomes the difference of densities of inertial mass for matter and antimatter (or vice versa). This interpretation leads to an elegant solution of the basic interpretational difficulties created by the conservation of inertial four-momentum and non-conservation of gravitational four-momentum.

The gravitational mass of the solution is determined from the asymptotic behavior of g_{tt} and is given by

$$M_{gr} = \frac{R^2}{G} \omega q u_\infty , \quad (2.5.27)$$

and is proportional to the Kähler charge q of the solution.

One can estimate the gravitational mass density also by applying Newtonian approximation to the time component of the metric $g_{tt} = 1 - 2\Phi_{gr}$. One obtains Φ_{gr} corresponds in the lowest order approximation to a solution of Einstein's equations with the source consisting of a mass point at origin and the energy density of the Kähler electric field. The effective value of gravitational constant is however $G_{eg} = 8R^2\alpha_K$. Thus the only sensible interpretation is that the density of Kähler (inertial) energy is only a fraction $G/G_{eg} \equiv \epsilon \simeq .22 \times 10^{-6}$ of the density of gravitational mass. Hence the densities of positive energy matter and negative energy antimatter cancel each other in a good approximation.

The work with cosmic strings lead to a possible interpretation of the solution as a space-time sheet containing topologically condensed magnetic flux tube idealizable as a point. The negative Kähler electric action must cancel the positive Kähler magnetic action. The resulting structure in turn can condense to a vacuum extremal and Schwartzchild metric is a good approximation for the metric.

One can estimate the contribution of the exterior region ($r > r_c$) to the inertial mass of the system and Equivalence principle requires this to be a fraction of order ϵ about the gravitational mass unless the region $r < r_c$ contains negative inertial mass density, which is of course quite possible. Approximating the metric with a flat metric and using first order approximation for $u(r)$ the energy reduces just to the standard Coulomb energy of charged sphere with radius r_c

$$\begin{aligned} M_I(ext) &= \frac{1}{32\pi\alpha_K} \int_{r>r_c} E^2 \sqrt{g} d^3x \\ &\simeq \frac{\lambda q^2}{2\alpha_K r_c} , \\ \lambda &= \sqrt{1 + \frac{R^2}{4} \omega^2 (1 - u_\infty^2)} (> 1) . \end{aligned} \quad (2.5.28)$$

Approximating the metric with flat metric the contribution of the region $r > r_c$ to the energy of the solution is given by

$$M_I(ext) = \frac{1}{8\alpha_K} \lambda q \omega (1 + |u_\infty|) . \quad (2.5.29)$$

The contribution is proportional to Kähler charge as expected. The ratio of external inertial and gravitational masses is given by the expression

$$\begin{aligned} \frac{M_I(ext)}{M_{gr}} &= \frac{G}{4R^2\alpha_K} x , \\ x &= \frac{(1 + |u_\infty|)}{|u_\infty|} > 1 . \end{aligned} \quad (2.5.30)$$

In the approximation used the the ratio of external inertial and gravitational masses is of order 10^{-6} for $R \sim 10^4 \sqrt{G}$ implied by the p-adic length scale hypothesis and for $x \sim 1$. The result conforms with the above discussed interpretation.

2. Z^0 and electromagnetic forces are much weaker than gravitational force

The extremal in question carries Kähler charge and therefore also Z^0 and electromagnetic charge. This implies long range gauge interactions, which ought to be weaker than gravitational interaction in the astrophysical scales. This is indeed the case as the following argument shows.

Expressing the Kähler charge using Planck mass as unit and using the relationships between gauge fields one obtains a direct measure for the strength of the Z^0 force as compared with the strength of gravitational force.

$$Q_Z \equiv \varepsilon_Z M_{gr} \sqrt{G} . \quad (2.5.31)$$

The value of the parameter ε_Z should be smaller than one. A transparent form for this condition is obtained, when one writes $\Phi = \omega t = \Omega m^0 : \Omega = \lambda \omega$:

$$\varepsilon_Z = \frac{\alpha_K}{\alpha_Z} \frac{1}{\pi(1 + |u_\infty|)\Omega R} \sqrt{\frac{G}{R}} . \quad (2.5.32)$$

The order of magnitude is determined by the values of the parameters $\sqrt{\frac{G}{R^2}} \sim 10^{-4}$ and ΩR . Global Minkowskian signature of the induced metric implies the condition $\Omega R < 2$ for the allowed values of the parameter ΩR . In macroscopic length scales one has $\Omega R \sim 1$ so that Z^0 force is by a factor of order 10^{-4} weaker than gravitational force. In elementary particle length scales with $\omega \sim m$ situation is completely different as expected.

3. The shift of the perihelion is predicted incorrectly

The g_{rr} component of Reissner-Nordström and TGD metrics are given by the expressions

$$g_{rr} = -\frac{1}{\left(1 - \frac{2GM}{r}\right)} , \quad (2.5.33)$$

and

$$g_{rr} \simeq 1 - \frac{\frac{Rq}{\omega^2}}{\left[1 - \left(u_\infty - \frac{4q}{\omega r}\right)^2\right] r^4} , \quad (2.5.34)$$

respectively. For reasonable values of q , ω and u_∞ the this terms is extremely small as compared with $1/r$ term so that these expressions differ by $1/r$ term.

The absence of the $1/r$ term from g_{rr} -component of the metric predicts that the shift of the perihelion for elliptic plane orbits is about 2/3 times that predicted by GRT so that the identification as a metric associated with objects of a planetary scale leads to an experimental contradiction. Reissner-Nordström solutions are obtained as vacuum extremals so that standard predictions of GRT are obtained for the planetary motion.

One might hope that the generalization of the form of the spherically symmetric ansatz by introducing the same modification as needed for the imbedding of Reissner-Nordström metric might help. The modification would read as

$$\begin{aligned} \cos(\Theta) &= u(r) , \\ \Phi &= \omega t + f(r) , \\ m^0 &= \lambda t + h(r) , \\ r_M &= r , \quad \theta_M = \theta , \quad \phi_M = \phi . \end{aligned} \quad (2.5.35)$$

The vanishing of the g_{tr} component of the metric gives the condition

$$\lambda \partial_r h - \frac{R^2}{4} \sin^2(\Theta) \omega \partial_r f = 0 . \quad (2.5.36)$$

The expression for the radial component of the metric transforms to

$$g_{rr} \simeq \partial_r h^2 - 1 - \frac{R^2}{4} (\partial_r \Theta)^2 - \frac{R^2}{4} \sin^2(\Theta) \partial_r f^2, \quad (2.5.37)$$

Essentially the same perihelion shift as for Schwarzschild metric is obtained if g_{rr} approaches asymptotically to its expression for Schwarzschild metric. This is guaranteed if the following conditions hold true:

$$f(r)_{r \rightarrow \infty} \rightarrow \omega r, \quad \Lambda^2 - 1 = \frac{R^2 \omega^2}{4} \sin^2(\Theta_\infty) \ll \frac{2GM}{\langle r \rangle}. \quad (2.5.38)$$

In the second equation $\langle r \rangle$ corresponds to the average radius of the planetary orbit.

The field equations for this ansatz can be written as conditions for energy momentum and color charge conservation. Two equations are enough to determine the functions $\Theta(r)$ and $f(r)$. The equation for momentum conservation is same as before. Second field equation corresponds to the conserved isometry current associated with the color isometry $\Phi \rightarrow \Phi + \epsilon$ and gives equation for f .

$$[T^{rr} f_{,r} s_{\Phi\Phi} \sqrt{g}]_{,r} = 0. \quad (2.5.39)$$

The conservation laws associated with other infinitesimal $SU(2)$ rotations of S^2_f should be satisfied identically. This equation can be readily integrated to give

$$T^{rr} f_{,r} s_{\Phi\Phi} \sqrt{g_{tt} g_{rr}} = \frac{C}{r^2}. \quad (2.5.40)$$

Unfortunately, the result is inconsistent with the $1/r^4$ behavior of T^{rr} and $f \rightarrow \omega r$ implies by correct red shift.

It seems that the only possible way out of the difficulty is to replace spherical symmetry with a symmetry with respect to the rotations around z-axis. The simplest modification of the solution ansatz is as follows:

$$m^0 = \lambda t + h(\rho), \quad \Phi = \omega t + k\rho.$$

Thanks to the linear dependence of Φ on ρ , the conservation laws for momentum and color isospin reduce to the same condition. The ansatz induces a small breaking of spherical symmetry by adding to $g_{\rho\rho}$ the term

$$(\partial_\rho h)^2 - \frac{R^2}{4} \sin^2(\Theta) k^2.$$

One might hope that in the plane $\theta = \pi/2$, where $r = \rho$ holds true, the ansatz could behave like Schwarzschild metric if the conditions discussed above are posed (including the condition $k = \omega$). The breaking of the spherical symmetry in the planetary system would be coded already to the gravitational field of Sun.

Also the study of the imbeddings of Reissner-Nordström metric as vacuum extremals and the investigation of spherically symmetric (inertial) vacuum extremals for which gravitational four-momentum is conserved [K85] leads to the conclusion that the loss of spherical symmetry due to rotation is inevitable characteristic of realistic solutions.

2.5.6 Maxwell hydrodynamics as a toy model for TGD

The field equations of TGD are extremely non-linear and all known solutions have been discovered by symmetry arguments. Chern-Simons term plays essential role also in the construction of solutions of field equations and at partonic level defines braiding for light-like partonic 3-surfaces expected to play key role in the construction of S-matrix. The inspiration for this section came from Terence Tao's blog posting *2006 ICM: Etienne Ghys, Knots and dynamics* [A63] giving an elegant summary about amazing mathematical results related to knots, links, braids and hydrodynamical flows in dimension $D = 3$. Posting tells about really amazing mathematical results related to knots.

Chern-Simons term as helicity invariant

Tao mentions helicity as an invariant of fluid flow. Chern-Simons action defined by the induced Kähler gauge potential for light-like 3-surfaces has interpretation as helicity when Kähler gauge potential is identified as fluid velocity. This flow can be continued to the interior of space-time sheet. Also the dual of the induced Kähler form defines a flow at the light-like partonic surfaces but not in the interior of space-time sheet. The lines of this flow can be interpreted as magnetic field lines. This flow is incompressible and represents a conserved charge (Kähler magnetic flux).

The question is which of these flows should define number theoretical braids. Perhaps both of them can appear in the definition of S-matrix and correspond to different kinds of partonic matter (electric/magnetic charges, quarks/leptons?,...). Second kind of matter could not flow in the interior of space-time sheet. Or could interpretation in terms of electric magnetic duality make sense?

Helicity is not gauge invariant and this is as it must be in TGD framework since CP_2 symplectic transformations induce $U(1)$ gauge transformation, which deforms space-time surface and modifies induced metric as well as classical electroweak fields defined by induced spinor connection. Gauge degeneracy is transformed to spin glass degeneracy.

Maxwell hydrodynamics

In TGD Maxwell's equations are replaced with field equations which express conservation laws and are thus hydrodynamical in character. With this background the idea that the analogy between gauge theory and hydrodynamics might be applied also in the reverse direction is natural. Hence one might ask what kind of relativistic hydrodynamics results if assumes that the action principle is Maxwell action for the four-velocity u^α with the constraint term saying that light velocity is maximal signal velocity.

1. For massive particles the length of four-velocity equals to 1: $u^\alpha u_\alpha = 1$. In massless case one has $u^\alpha u_\alpha = 0$. Geometrically this means that one has sigma model with target space which is 3-D Lobatschevski space or at light-cone boundary. This condition means the addition of constraint term

$$\lambda(u^\alpha u_\alpha - \epsilon) \tag{2.5.41}$$

to the Maxwell action. $\epsilon = 1/0$ holds for massive/massless flow. In the following the notation of electrodynamics is used to make easier the comparison with electrodynamics.

2. The constraint term destroys gauge invariance by allowing to express A^0 in terms of A^i but in general the constraint is not equivalent to a choice of gauge in electrodynamics since the solutions to the field equations with constraint term are not solutions of field equations without it. One obtains field equations for an effectively massive em field with Lagrange multiplier λ having interpretation as photon mass depending on space-time point:

$$\begin{aligned} j^\alpha &= \partial_\beta F^{\alpha\beta} = \lambda A^\alpha , \\ A^\alpha &\equiv u^\alpha , \quad F^{\alpha\beta} = \partial^\beta A^\alpha - \partial^\alpha A^\beta . \end{aligned} \tag{2.5.42}$$

3. In electrodynamic context the natural interpretation would be in terms of spontaneous massivation of photon and seems to occur for both values of ϵ . The analog of em current given by λA^α is in general non-vanishing and conserved. This conservation law is quite strong additional constraint on the hydrodynamics. What is interesting is that breaking of gauge invariance does not lead to a loss of charge conservation.
4. One can solve λ by contracting the equations with A_α to obtain

$$\lambda = j^\alpha A_\alpha$$

for $\epsilon = 1$. For $\epsilon = 0$ one obtains

$$j^\alpha A_\alpha = 0$$

stating that the field does not dissipate energy: λ can be however non-vanishing unless field equations imply $j^\alpha = 0$. One can say that for $\epsilon = 0$ spontaneous massivation can occur. For $\epsilon = 1$ massivation is present from the beginning and dissipation rate determines photon mass: a natural interpretation for $\epsilon = 1$ would be in terms of thermal massivation of photon. Non-tachyonicity fixes the sign of the dissipation term so that the thermodynamical arrow of time is fixed by causality.

5. For $\epsilon = 0$ massless plane wave solutions are possible and one has

$$\partial_\alpha \partial_\beta A^\beta = \lambda A_\alpha .$$

$\lambda = 0$ is obtained in Lorentz gauge which is consistent with the condition $\epsilon = 0$. Also superpositions of plane waves with same polarization and direction of propagation are solutions of field equations: these solutions represent dispersionless precisely targeted pulses. For superpositions of plane waves λ with 4-momenta, which are not all parallel λ is non-vanishing so that non-linear self interactions due to the constraint can be said to induce massivation. In asymptotic states for which gauge symmetry is not broken one expects a decomposition of solutions to regions of space-time carrying this kind of pulses, which brings in mind final states of particle reactions containing free photons with fixed polarizations.

6. Gradient flows satisfying the conditions

$$A_\alpha = \partial_\alpha \Phi , \quad A^\alpha A_\alpha = \epsilon \tag{2.5.43}$$

give rise to identically vanishing hydrodynamical gauge fields and $\lambda = 0$ holds true. These solutions are vacua since energy momentum tensor vanishes identically. There is huge number of this kind of solutions and spin glass degeneracy suggests itself. Small deformations of these vacuum flows are expected to give rise to non-vacuum flows.

7. The counterparts of charged solutions are of special interest. For $\epsilon = 0$ the solution $(u^0, u^r) = (Q/r)(1, 1)$ is a solution of field equations outside origin and corresponds to electric field of a point charge Q . In fact, for $\epsilon = 0$ any ansatz $(u^0, u^r) = f(r)(1, 1)$ satisfies field equations for a suitable choice of $\lambda(r)$ since the ratio of equations associate with j^0 and j^r gives an equation which is trivially satisfied. For $\epsilon = 1$ the ansatz $(u^0, u^r) = (\cosh(u), \sinh(u))$ expressing solution in terms of hyperbolic angle linearizes the field equation obtained by dividing the equations for j^0 and j^r to eliminate λ . The resulting equation is

$$\partial_r^2 u + \frac{2\partial_r u}{r} = 0$$

for ordinary Coulomb potential and one obtains $(u^0, u^r) = (\cosh(u_0 + k/r), \sinh(u_0 + k/r))$. The charge of the solution at the limit $r \rightarrow \infty$ approaches to the value $Q = \sinh(u_0)k$ and diverges at the limit $r \rightarrow 0$. The charge increases exponentially as a function of $1/r$ near origin rather than logarithmically as in QED and the interpretation in terms of thermal screening suggests itself. Hyperbolic ansatz might simplify considerably the field equations also in the general case.

Similarities with TGD

There are strong similarities with TGD which suggests that the proposed model might provide a toy model for the dynamics defined by Kähler action.

1. Also in TGD field equations are essentially hydrodynamical equations stating the conservation of various isometry charges. Gauge invariance is broken for the induced Kähler field although Kähler charge is conserved. There is huge vacuum degeneracy corresponding to vanishing of induced Kähler field and the interpretation is in terms of spin glass degeneracy.
2. Also in TGD dissipation rate vanishes for the known solutions of field equations and a possible interpretation is as space-time correlates for asymptotic non-dissipating self organization patterns.
3. In TGD framework massless extremals represent the analogs for superpositions of plane waves with fixed polarization and propagation direction and representing targeted and dispersionless propagation of signal. Gauge currents are light-like and non-vanishing for these solutions. The decomposition of space-time surface to space-time sheets representing particles is much more general counterpart for the asymptotic solutions of Maxwell hydrodynamics with vanishing λ .
4. In TGD framework one can consider the possibility that the four-velocity assignable to a macroscopic quantum phase is proportional to the induced Kähler gauge potential. In this kind of situation one could speak of a quantal variant of Maxwell hydrodynamics, at least for light-like partonic 3-surfaces. For instance, the condition

$$D^\alpha D_\alpha \Psi = 0 \quad , \quad D_\alpha \Psi = (\partial_\alpha - iq_K A_\alpha) \Psi$$

for the order parameter of the quantum phase corresponds at classical level to the condition $p^\alpha = q_K Q^\alpha + l^\alpha$, where q_K is Kähler charge of fermion and l^α is a light-like vector field naturally assignable to the partonic boundary component. This gives $u^\alpha = (q_K Q^\alpha + l^\alpha)/m$, $m^2 = p^\alpha p_\alpha$, which is somewhat more general condition. The expressibility of u^α in terms of the vector fields provided by the induced geometry is very natural.

The value ϵ depends on space-time region and it would seem that also $\epsilon = -1$ is possible meaning tachyonicity and breaking of causality. Kähler gauge potential could however have a time-like pure gauge component in M^4 possibly saving the situation. The construction of quantum TGD at parton level indeed forces to assume that Kähler gauge potential has Lorentz invariant M^4 component $A_a = \text{constant}$ in the direction of the light-cone proper time coordinate axis a . Note that the decomposition of configuration space to sectors consisting of space-time sheets inside future or past light-cone of M^4 is an essential element of the construction of configuration space geometry and does not imply breaking of Poincare invariance. Without this component $u_\alpha u^\alpha$ could certainly be negative. The contribution of M^4 component could prevent this for preferred extremals.

If TGD is taken seriously, these similarities force to ask whether Maxwell hydrodynamics might be interpreted as a nonlinear variant of electrodynamics. Probably not: in TGD em field is proportional to the induced Kähler form only in special cases and is in general non-vanishing also for vacuum extremals.

2.6 Weak form electric-magnetic duality and its implications

The notion of electric-magnetic duality [B11] was proposed first by Olive and Montonen and is central in $\mathcal{N} = 4$ supersymmetric gauge theories. It states that magnetic monopoles and ordinary particles are two different phases of theory and that the description in terms of monopoles can be applied at the limit when the running gauge coupling constant becomes very large and perturbation theory fails to converge. The notion of electric-magnetic self-duality is more natural since for CP_2 geometry Kähler form is self-dual and Kähler magnetic monopoles are also Kähler electric monopoles and Kähler coupling strength is by quantum criticality renormalization group invariant rather than running coupling constant. The notion of electric-magnetic (self-)duality emerged already two decades ago in the attempts to formulate the Kähler geometric of world of classical worlds. Quite recently a considerable step of progress took place in the understanding of this notion [K20]. What seems to be essential is that one adopts a weaker form of the self-duality applying at partonic 2-surfaces. What this means will be discussed in the sequel.

Every new idea must be of course taken with a grain of salt but the good sign is that this concept leads to precise predictions. The point is that elementary particles do not generate monopole fields in macroscopic length scales: at least when one considers visible matter. The first question is whether elementary particles could have vanishing magnetic charges: this turns out to be impossible. The next question is how the screening of the magnetic charges could take place and leads to an identification of the physical particles as string like objects identified as pairs magnetic charged wormhole throats connected by magnetic flux tubes.

1. The first implication is a new view about electro-weak massivation reducing it to weak confinement in TGD framework. The second end of the string contains particle having electroweak isospin neutralizing that of elementary fermion and the size scale of the string is electro-weak scale would be in question. Hence the screening of electro-weak force takes place via weak confinement realized in terms of magnetic confinement.
2. This picture generalizes to the case of color confinement. Also quarks correspond to pairs of magnetic monopoles but the charges need not vanish now. Rather, valence quarks would be connected by flux tubes of length of order hadron size such that magnetic charges sum up to zero. For instance, for baryonic valence quarks these charges could be $(2, -1, -1)$ and could be proportional to color hyper charge.
3. The highly non-trivial prediction making more precise the earlier stringy vision is that elementary particles are string like objects in electro-weak scale: this should become manifest at LHC energies.
4. The weak form electric-magnetic duality together with Beltrami flow property of Kähler leads to the reduction of Kähler action to Chern-Simons action so that TGD reduces to almost topological QFT and that Kähler function is explicitly calculable. This has enormous impact concerning practical calculability of the theory.
5. One ends up also to a general solution ansatz for field equations from the condition that the theory reduces to almost topological QFT. The solution ansatz is inspired by the idea that all isometry currents are proportional to Kähler current which is integrable in the sense that the flow parameter associated with its flow lines defines a global coordinate. The proposed solution ansatz would describe a hydrodynamical flow with the property that isometry charges are conserved along the flow lines (Beltrami flow). A general ansatz satisfying the integrability conditions is found. The solution ansatz applies also to the extremals of Chern-Simons action and and to the conserved currents associated with the modified Dirac equation defined as contractions of the modified gamma matrices between the solutions of the modified Dirac equation. The strongest form of the solution ansatz states that various classical and quantum currents flow along flow lines of the Beltrami flow defined by Kähler current (Kähler magnetic field associated with Chern-Simons action). Intuitively this picture is attractive. A more general ansatz would allow several Beltrami flows meaning multi-hydrodynamics. The integrability conditions boil down to two scalar functions: the first one satisfies massless d'Alembert equation in the induced metric and the the gradients of the scalar functions are orthogonal. The interpretation in terms of momentum and polarization directions is natural.
6. The general solution ansatz works for induced Kähler Dirac equation and Chern-Simons Dirac equation and reduces them to ordinary differential equations along flow lines. The induced spinor fields are simply constant along flow lines of induced spinor field for Dirac equation in suitable gauge. Also the generalized eigen modes of the modified Chern-Simons Dirac operator can be deduced explicitly if the throats and the ends of space-time surface at the boundaries of CD are extremals of Chern-Simons action. Chern-Simons Dirac equation reduces to ordinary differential equations along flow lines and one can deduce the general form of the spectrum and the explicit representation of the Dirac determinant in terms of geometric quantities characterizing the 3-surface (eigenvalues are inversely proportional to the lengths of strands of the flow lines in the effective metric defined by the modified gamma matrices).

2.6.1 Could a weak form of electric-magnetic duality hold true?

Holography means that the initial data at the partonic 2-surfaces should fix the configuration space metric. A weak form of this condition allows only the partonic 2-surfaces defined by the wormhole throats at which the signature of the induced metric changes. A stronger condition allows all partonic 2-surfaces in the slicing of space-time sheet to partonic 2-surfaces and string world sheets. Number theoretical vision suggests that hyper-quaternionicity *resp.* co-hyperquaternionicity constraint could be enough to fix the initial values of time derivatives of the imbedding space coordinates in the space-time regions with Minkowskian *resp.* Euclidian signature of the induced metric. This is a condition on modified gamma matrices and hyper-quaternionicity states that they span a hyper-quaternionic sub-space.

Definition of the weak form of electric-magnetic duality

One can also consider alternative conditions possibly equivalent with this condition. The argument goes as follows.

1. The expression of the matrix elements of the metric and Kähler form of WCW in terms of the Kähler fluxes weighted by Hamiltonians of δM_{\pm}^{\pm} at the partonic 2-surface X^2 looks very attractive. These expressions however carry no information about the 4-D tangent space of the partonic 2-surfaces so that the theory would reduce to a genuinely 2-dimensional theory, which cannot hold true. One would like to code to the WCW metric also information about the electric part of the induced Kähler form assignable to the complement of the tangent space of $X^2 \subset X^4$.
2. Electric-magnetic duality of the theory looks a highly attractive symmetry. The trivial manner to get electric magnetic duality at the level of the full theory would be via the identification of the flux Hamiltonians as sums of of the magnetic and electric fluxes. The presence of the induced metric is however troublesome since the presence of the induced metric means that the simple transformation properties of flux Hamiltonians under symplectic transformations -in particular color rotations- are lost.
3. A less trivial formulation of electric-magnetic duality would be as an initial condition which eliminates the induced metric from the electric flux. In the Euclidian version of 4-D YM theory this duality allows to solve field equations exactly in terms of instantons. This approach involves also quaternions. These arguments suggest that the duality in some form might work. The full electric magnetic duality is certainly too strong and implies that space-time surface at the partonic 2-surface corresponds to piece of CP_2 type vacuum extremal and can hold only in the deep interior of the region with Euclidian signature. In the region surrounding wormhole throat at both sides the condition must be replaced with a weaker condition.
4. To formulate a weaker form of the condition let us introduce coordinates (x^0, x^3, x^1, x^2) such (x^1, x^2) define coordinates for the partonic 2-surface and (x^0, x^3) define coordinates labeling partonic 2-surfaces in the slicing of the space-time surface by partonic 2-surfaces and string world sheets making sense in the regions of space-time sheet with Minkowskian signature. The assumption about the slicing allows to preserve general coordinate invariance. The weakest condition is that the generalized Kähler electric fluxes are apart from constant proportional to Kähler magnetic fluxes. This requires the condition

$$J^{03}\sqrt{g_4} = K J_{12} . \quad (2.6.1)$$

A more general form of this duality is suggested by the considerations of [K40] reducing the hierarchy of Planck constants to basic quantum TGD and also reducing Kähler function for preferred extremals to Chern-Simons terms [B5] at the boundaries of CD and at light-like wormhole throats. This form is following

$$J^{n\beta}\sqrt{g_4} = K \epsilon \times \epsilon^{n\beta\gamma\delta} J_{\gamma\delta}\sqrt{g_4} . \quad (2.6.2)$$

Here the index n refers to a normal coordinate for the space-like 3-surface at either boundary of CD or for light-like wormhole throat. ϵ is a sign factor which is opposite for the two ends of CD . It could be also opposite of opposite at the opposite sides of the wormhole throat. Note that the dependence on induced metric disappears at the right hand side and this condition eliminates the potentials singularity due to the reduction of the rank of the induced metric at wormhole throat.

- Information about the tangent space of the space-time surface can be coded to the configuration space metric with loosing the nice transformation properties of the magnetic flux Hamiltonians if Kähler electric fluxes or sum of magnetic flux and electric flux satisfying this condition are used and K is symplectic invariant. Using the sum

$$J_e + J_m = (1 + K)J_{12} , \quad (2.6.3)$$

where J denotes the Kähler magnetic flux, , makes it possible to have a non-trivial configuration space metric even for $K = 0$, which could correspond to the ends of a cosmic string like solution carrying only Kähler magnetic fields. This condition suggests that it can depend only on Kähler magnetic flux and other symplectic invariants. Whether local symplectic coordinate invariants are possible at all is far from obvious, If the slicing itself is symplectic invariant then K could be a non-constant function of X^2 depending on string world sheet coordinates. The light-like radial coordinate of the light-cone boundary indeed defines a symplectically invariant slicing and this slicing could be shifted along the time axis defined by the tips of CD .

Electric-magnetic duality physically

What could the weak duality condition mean physically? For instance, what constraints are obtained if one assumes that the quantization of electro-weak charges reduces to this condition at classical level?

- The first thing to notice is that the flux of J over the partonic 2-surface is analogous to magnetic flux

$$Q_m = \frac{e}{\hbar} \oint B dS = n .$$

n is non-vanishing only if the surface is homologically non-trivial and gives the homology charge of the partonic 2-surface.

- The expressions of classical electromagnetic and Z^0 fields in terms of Kähler form [L1] , [L1] read as

$$\begin{aligned} \gamma &= \frac{eF_{em}}{\hbar} = 3J - \sin^2(\theta_W)R_{03} , \\ Z^0 &= \frac{g_Z F_Z}{\hbar} = 2R_{03} . \end{aligned} \quad (2.6.4)$$

Here R_{03} is one of the components of the curvature tensor in vielbein representation and F_{em} and F_Z correspond to the standard field tensors. From this expression one can deduce

$$J = \frac{e}{3\hbar} F_{em} + \sin^2(\theta_W) \frac{g_Z}{6\hbar} F_Z . \quad (2.6.5)$$

3. The weak duality condition when integrated over X^2 implies

$$\begin{aligned} \frac{e^2}{3\hbar}Q_{em} + \frac{g_Z^2 p}{6}Q_{Z,V} &= K \oint J = Kn \ , \\ Q_{Z,V} &= \frac{I_V^3}{2} - Q_{em} \ , \ p = \sin^2(\theta_W) \ . \end{aligned} \quad (2.6.6)$$

Here the vectorial part of the Z^0 charge rather than as full Z^0 charge $Q_Z = I_L^3 + \sin^2(\theta_W)Q_{em}$ appears. The reason is that only the vectorial isospin is same for left and right handed components of fermion which are in general mixed for the massive states.

The coefficients are dimensionless and expressible in terms of the gauge coupling strengths and using $\hbar = r\hbar_0$ one can write

$$\begin{aligned} \alpha_{em}Q_{em} + p\frac{\alpha_Z}{2}Q_{Z,V} &= \frac{3}{4\pi} \times rnK \ , \\ \alpha_{em} &= \frac{e^2}{4\pi\hbar_0} \ , \ \alpha_Z = \frac{g_Z^2}{4\pi\hbar_0} = \frac{\alpha_{em}}{p(1-p)} \ . \end{aligned} \quad (2.6.7)$$

4. There is a great temptation to assume that the values of Q_{em} and Q_Z correspond to their quantized values and therefore depend on the quantum state assigned to the partonic 2-surface. The linear coupling of the modified Dirac operator to conserved charges implies correlation between the geometry of space-time sheet and quantum numbers assigned to the partonic 2-surface. The assumption of standard quantized values for Q_{em} and Q_Z would be also seen as the identification of the fine structure constants α_{em} and α_Z . This however requires weak isospin invariance.

The value of K from classical quantization of Kähler electric charge

The value of K can be deduced by requiring classical quantization of Kähler electric charge.

1. The condition that the flux of $F^{03} = (\hbar/g_K)J^{03}$ defining the counterpart of Kähler electric field equals to the Kähler charge g_K would give the condition $K = g_K^2/\hbar$, where g_K is Kähler coupling constant which should invariant under coupling constant evolution by quantum criticality. Within experimental uncertainties one has $\alpha_K = g_K^2/4\pi\hbar_0 = \alpha_{em} \simeq 1/137$, where α_{em} is finite structure constant in electron length scale and \hbar_0 is the standard value of Planck constant.
2. The quantization of Planck constants makes the condition highly non-trivial. The most general quantization of r is as rationals but there are good arguments favoring the quantization as integers corresponding to the allowance of only singular coverings of CD and CP_2 . The point is that in this case a given value of Planck constant corresponds to a finite number pages of the "Big Book". The quantization of the Planck constant implies a further quantization of K and would suggest that K scales as $1/r$ unless the spectrum of values of Q_{em} and Q_Z allowed by the quantization condition scales as r . This is quite possible and the interpretation would be that each of the r sheets of the covering carries (possibly same) elementary charge. Kind of discrete variant of a full Fermi sphere would be in question. The interpretation in terms of anyonic phases [K63] supports this interpretation.
3. The identification of J as a counterpart of eB/\hbar means that Kähler action and thus also Kähler function is proportional to $1/\alpha_K$ and therefore to \hbar . This implies that for large values of \hbar Kähler coupling strength $g_K^2/4\pi$ becomes very small and large fluctuations are suppressed in the functional integral. The basic motivation for introducing the hierarchy of Planck constants was indeed that the scaling $\alpha \rightarrow \alpha/r$ allows to achieve the convergence of perturbation theory: Nature itself would solve the problems of the theoretician. This of course does not mean that the physical states would remain as such and the replacement of single particles with anyonic states in order to satisfy the condition for K would realize this concretely.

4. The condition $K = g_K^2/\hbar$ implies that the Kähler magnetic charge is always accompanied by Kähler electric charge. A more general condition would read as

$$K = n \times \frac{g_K^2}{\hbar}, n \in Z . \quad (2.6.8)$$

This would apply in the case of cosmic strings and would allow vanishing Kähler charge possible when the partonic 2-surface has opposite fermion and antifermion numbers (for both leptons and quarks) so that Kähler electric charge should vanish. For instance, for neutrinos the vanishing of electric charge strongly suggests $n = 0$ besides the condition that abelian Z^0 flux contributing to em charge vanishes.

It took a year to realize that this value of K is natural at the Minkowskian side of the wormhole throat. At the Euclidian side much more natural condition is

$$K = \frac{1}{\hbar} . \quad (2.6.9)$$

In fact, the self-duality of CP_2 Kähler form favours this boundary condition at the Euclidian side of the wormhole throat. Also the fact that one cannot distinguish between electric and magnetic charges in Euclidian region since all charges are magnetic can be used to argue in favor of this form. The same constraint arises from the condition that the action for CP_2 type vacuum extremal has the value required by the argument leading to a prediction for gravitational constant in terms of the square of CP_2 radius and α_K the effective replacement $g_K^2 \rightarrow 1$ would spoil the argument.

The boundary condition $J_E = J_B$ for the electric and magnetic parts of Kähler form at the Euclidian side of the wormhole throat inspires the question whether all Euclidian regions could be self-dual so that the density of Kähler action would be just the instanton density. Self-duality follows if the deformation of the metric induced by the deformation of the canonically imbedded CP_2 is such that in CP_2 coordinates for the Euclidian region the tensor $(g^{\alpha\beta}g^{\mu\nu} - g^{\alpha\nu}g^{\mu\beta})/\sqrt{g}$ remains invariant. This is certainly the case for CP_2 type vacuum extremals since by the light-likeness of M^4 projection the metric remains invariant. Also conformal scalings of the induced metric would satisfy this condition. Conformal scaling is not consistent with the degeneracy of the 4-metric at the wormhole

Reduction of the quantization of Kähler electric charge to that of electromagnetic charge

The best manner to learn more is to challenge the form of the weak electric-magnetic duality based on the induced Kähler form.

1. Physically it would seem more sensible to pose the duality on electromagnetic charge rather than Kähler charge. This would replace induced Kähler form with electromagnetic field, which is a linear combination of induced Kähler field and classical Z^0 field

$$\begin{aligned} \gamma &= 3J - \sin^2\theta_W R_{03} , \\ Z^0 &= 2R_{03} . \end{aligned} \quad (2.6.10)$$

Here $Z_0 = 2R_{03}$ is the appropriate component of CP_2 curvature form [L1]. For a vanishing Weinberg angle the condition reduces to that for Kähler form.

2. For the Euclidian space-time regions having interpretation as lines of generalized Feynman diagrams Weinberg angle should be non-vanishing. In Minkowskian regions Weinberg angle could however vanish. If so, the condition guaranteeing that electromagnetic charge of the partonic 2-surfaces equals to the above condition stating that the em charge assignable to the fermion content of the partonic 2-surfaces reduces to the classical Kähler electric flux at the Minkowskian side of the wormhole throat. One can argue that Weinberg angle must increase smoothly from a vanishing value at both sides of wormhole throat to its value in the deep interior of the Euclidian region.

3. The vanishing of the Weinberg angle in Minkowskian regions conforms with the physical intuition. Above elementary particle length scales one sees only the classical electric field reducing to the induced Kähler form and classical Z^0 fields and color gauge fields are effectively absent. Only in phases with a large value of Planck constant classical Z^0 field and other classical weak fields and color gauge field could make themselves visible. Cell membrane could be one such system [K66]. This conforms with the general picture about color confinement and weak massivation.

The GRT limit of TGD suggests a further reason for why Weinberg angle should vanish in Minkowskian regions.

1. The value of the Kähler coupling strength must be very near to the value of the fine structure constant in electron length scale and these constants can be assumed to be equal.
2. GRT limit of TGD with space-time surfaces replaced with abstract 4-geometries would naturally correspond to Einstein-Maxwell theory with cosmological constant which is non-vanishing only in Euclidian regions of space-time so that both Reissner-Nordström metric and CP_2 are allowed as simplest possible solutions of field equations [K85]. The extremely small value of the observed cosmological constant needed in GRT type cosmology could be equal to the large cosmological constant associated with CP_2 metric multiplied with the 3-volume fraction of Euclidian regions.
3. Also at GRT limit quantum theory would reduce to almost topological QFT since Einstein-Maxwell action reduces to 3-D term by field equations implying the vanishing of the Maxwell current and of the curvature scalar in Minkowskian regions and curvature scalar + cosmological constant term in Euclidian regions. The weak form of electric-magnetic duality would guarantee also now the preferred extremal property and prevent the reduction to a mere topological QFT.
4. GRT limit would make sense only for a vanishing Weinberg angle in Minkowskian regions. A non-vanishing Weinberg angle would make sense in the deep interior of the Euclidian regions where the approximation as a small deformation of CP_2 makes sense.

The weak form of electric-magnetic duality has surprisingly strong implications for the basic view about quantum TGD as following considerations show.

2.6.2 Magnetic confinement, the short range of weak forces, and color confinement

The weak form of electric-magnetic duality has surprisingly strong implications if one combines it with some very general empirical facts such as the non-existence of magnetic monopole fields in macroscopic length scales.

How can one avoid macroscopic magnetic monopole fields?

Monopole fields are experimentally absent in length scales above order weak boson length scale and one should have a mechanism neutralizing the monopole charge. How electroweak interactions become short ranged in TGD framework is still a poorly understood problem. What suggests itself is the neutralization of the weak isospin above the intermediate gauge boson Compton length by neutral Higgs bosons. Could the two neutralization mechanisms be combined to single one?

1. In the case of fermions and their super partners the opposite magnetic monopole would be a wormhole throat. If the magnetically charged wormhole contact is electromagnetically neutral but has vectorial weak isospin neutralizing the weak vectorial isospin of the fermion only the electromagnetic charge of the fermion is visible on longer length scales. The distance of this wormhole throat from the fermionic one should be of the order weak boson Compton length. An interpretation as a bound state of fermion and a wormhole throat state with the quantum numbers of a neutral Higgs boson would therefore make sense. The neutralizing throat would have quantum numbers of $X_{-1/2} = \nu_L \bar{\nu}_R$ or $X_{1/2} = \bar{\nu}_L \nu_R$. $\nu_L \bar{\nu}_R$ would not be neutral Higgs boson (which should correspond to a wormhole contact) but a super-partner of left-handed neutrino obtained by adding a right handed neutrino. This mechanism would apply separately

to the fermionic and anti-fermionic throats of the gauge bosons and corresponding space-time sheets and leave only electromagnetic interaction as a long ranged interaction.

2. One can of course wonder what is the situation for the bosonic wormhole throats feeding gauge fluxes between space-time sheets. It would seem that these wormhole throats must always appear as pairs such that for the second member of the pair monopole charges and I_V^3 cancel each other at both space-time sheets involved so that one obtains at both space-time sheets magnetic dipoles of size of weak boson Compton length. The proposed magnetic character of fundamental particles should become visible at TeV energies so that LHC might have surprises in store!

Magnetic confinement and color confinement

Magnetic confinement generalizes also to the case of color interactions. One can consider also the situation in which the magnetic charges of quarks (more generally, of color excited leptons and quarks) do not vanish and they form color and magnetic singlets in the hadronic length scale. This would mean that magnetic charges of the state $q_{\pm 1/2} - X_{\mp 1/2}$ representing the physical quark would not vanish and magnetic confinement would accompany also color confinement. This would explain why free quarks are not observed. To how degree then quark confinement corresponds to magnetic confinement is an interesting question.

For quark and antiquark of meson the magnetic charges of quark and antiquark would be opposite and meson would correspond to a Kähler magnetic flux so that a stringy view about meson emerges. For valence quarks of baryon the vanishing of the net magnetic charge takes place provided that the magnetic net charges are $(\pm 2, \mp 1, \mp 1)$. This brings in mind the spectrum of color hyper charges coming as $(\pm 2, \mp 1, \mp 1)/3$ and one can indeed ask whether color hyper-charge correlates with the Kähler magnetic charge. The geometric picture would be three strings connected to single vertex. Amusingly, the idea that color hypercharge could be proportional to color hyper charge popped up during the first year of TGD when I had not yet discovered CP_2 and believed on $M^4 \times S^2$.

p-Adic length scale hypothesis and hierarchy of Planck constants defining a hierarchy of dark variants of particles suggest the existence of scaled up copies of QCD type physics and weak physics. For p-adically scaled up variants the mass scales would be scaled by a power of $\sqrt{2}$ in the most general case. The dark variants of the particle would have the same mass as the original one. In particular, Mersenne primes $M_k = 2^k - 1$ and Gaussian Mersennes $M_{G,k} = (1 + i)^k - 1$ has been proposed to define zoomed copies of these physics. At the level of magnetic confinement this would mean hierarchy of length scales for the magnetic confinement.

One particular proposal is that the Mersenne prime M_{89} should define a scaled up variant of the ordinary hadron physics with mass scaled up roughly by a factor $2^{(107-89)/2} = 512$. The size scale of color confinement for this physics would be same as the weak length scale. It would look more natural that the weak confinement for the quarks of M_{89} physics takes place in some shorter scale and M_{61} is the first Mersenne prime to be considered. The mass scale of M_{61} weak bosons would be by a factor $2^{(89-61)/2} = 2^{14}$ higher and about 1.6×10^4 TeV. M_{89} quarks would have virtually no weak interactions but would possess color interactions with weak confinement length scale reflecting themselves as new kind of jets at collisions above TeV energies.

In the biologically especially important length scale range 10 nm -2500 nm there are as many as four Gaussian Mersennes corresponding to $M_{G,k}$, $k = 151, 157, 163, 167$. This would suggest that the existence of scaled up scales of magnetic-, weak- and color confinement. An especially interesting possibly testable prediction is the existence of magnetic monopole pairs with the size scale in this range. There are recent claims about experimental evidence for magnetic monopole pairs [D8].

Magnetic confinement and stringy picture in TGD sense

The connection between magnetic confinement and weak confinement is rather natural if one recalls that electric-magnetic duality in super-symmetric quantum field theories means that the descriptions in terms of particles and monopoles are in some sense dual descriptions. Fermions would be replaced by string like objects defined by the magnetic flux tubes and bosons as pairs of wormhole contacts would correspond to pairs of the flux tubes. Therefore the sharp distinction between gravitons and physical particles would disappear.

The reason why gravitons are necessarily stringy objects formed by a pair of wormhole contacts is that one cannot construct spin two objects using only single fermion states at wormhole throats. Of course, also super partners of these states with higher spin obtained by adding fermions and anti-fermions at the wormhole throat but these do not give rise to graviton like states [K32]. The upper and lower wormhole throat pairs would be quantum superpositions of fermion anti-fermion pairs with sum over all fermions. The reason is that otherwise one cannot realize graviton emission in terms of joining of the ends of light-like 3-surfaces together. Also now magnetic monopole charges are necessary but now there is no need to assign the entities X_{\pm} with gravitons.

Graviton string is characterized by some p-adic length scale and one can argue that below this length scale the charges of the fermions become visible. Mersenne hypothesis suggests that some Mersenne prime is in question. One proposal is that gravitonic size scale is given by electronic Mersenne prime M_{127} . It is however difficult to test whether graviton has a structure visible below this length scale.

What happens to the generalized Feynman diagrams is an interesting question. It is not at all clear how closely they relate to ordinary Feynman diagrams. All depends on what one is ready to assume about what happens in the vertices. One could of course hope that zero energy ontology could allow some very simple description allowing perhaps to get rid of the problematic aspects of Feynman diagrams.

1. Consider first the recent view about generalized Feynman diagrams which relies zero energy ontology. A highly attractive assumption is that the particles appearing at wormhole throats are on mass shell particles. For incoming and outgoing elementary bosons and their super partners they would be positive it resp. negative energy states with parallel on mass shell momenta. For virtual bosons they the wormhole throats would have opposite sign of energy and the sum of on mass shell states would give virtual net momenta. This would make possible twistor description of virtual particles allowing only massless particles (in 4-D sense usually and in 8-D sense in TGD framework). The notion of virtual fermion makes sense only if one assumes in the interaction region a topological condensation creating another wormhole throat having no fermionic quantum numbers.
2. The addition of the particles X^{\pm} replaces generalized Feynman diagrams with the analogs of stringy diagrams with lines replaced by pairs of lines corresponding to fermion and $X_{\pm 1/2}$. The members of these pairs would correspond to 3-D light-like surfaces glued together at the vertices of generalized Feynman diagrams. The analog of 3-vertex would not be splitting of the string to form shorter strings but the replication of the entire string to form two strings with same length or fusion of two strings to single string along all their points rather than along ends to form a longer string. It is not clear whether the duality symmetry of stringy diagrams can hold true for the TGD variants of stringy diagrams.
3. How should one describe the bound state formed by the fermion and X^{\pm} ? Should one describe the state as superposition of non-parallel on mass shell states so that the composite state would be automatically massive? The description as superposition of on mass shell states does not conform with the idea that bound state formation requires binding energy. In TGD framework the notion of negentropic entanglement has been suggested to make possible the analogs of bound states consisting of on mass shell states so that the binding energy is zero [K51]. If this kind of states are in question the description of virtual states in terms of on mass shell states is not lost. Of course, one cannot exclude the possibility that there is infinite number of this kind of states serving as analogs for the excitations of string like object.
4. What happens to the states formed by fermions and $X_{\pm 1/2}$ in the internal lines of the Feynman diagram? Twistor philosophy suggests that only the higher on mass shell excitations are possible. If this picture is correct, the situation would not change in an essential manner from the earlier one.

The highly non-trivial prediction of the magnetic confinement is that elementary particles should have stringy character in electro-weak length scales and could behaving to become manifest at LHC energies. This adds one further item to the list of non-trivial predictions of TGD about physics at LHC energies [K52].

2.6.3 Could Quantum TGD reduce to almost topological QFT?

There seems to be a profound connection with the earlier unrealistic proposal that TGD reduces to almost topological quantum theory in the sense that the counterpart of Chern-Simons action assigned with the wormhole throats somehow dictates the dynamics. This proposal can be formulated also for the modified Dirac action action. I gave up this proposal but the following argument shows that Kähler action with weak form of electric-magnetic duality effectively reduces to Chern-Simons action plus Coulomb term.

1. Kähler action density can be written as a 4-dimensional integral of the Coulomb term $j_K^\alpha A_\alpha$ plus and integral of the boundary term $J^{n\beta} A_\beta \sqrt{g_4}$ over the wormhole throats and of the quantity $J^{0\beta} A_\beta \sqrt{g_4}$ over the ends of the 3-surface.
2. If the self-duality conditions generalize to $J^{n\beta} = 4\pi\alpha_K \epsilon^{n\beta\gamma\delta} J_{\gamma\delta}$ at throats and to $J^{0\beta} = 4\pi\alpha_K \epsilon^{0\beta\gamma\delta} J_{\gamma\delta}$ at the ends, the Kähler function reduces to the counterpart of Chern-Simons action evaluated at the ends and throats. It would have same value for each branch and the replacement $\hbar_0 \rightarrow r\hbar_0$ would effectively describe this. Boundary conditions would however give $1/r$ factor so that \hbar would disappear from the Kähler function! The original attempt to realize quantum TGD as an almost topological QFT was in terms of Chern-Simons action but was given up. It is somewhat surprising that Kähler action gives Chern-Simons action in the vacuum sector defined as sector for which Kähler current is light-like or vanishes.

Holography encourages to ask whether also the Coulomb interaction terms could vanish. This kind of dimensional reduction would mean an enormous simplification since TGD would reduce to an almost topological QFT. The attribute "almost" would come from the fact that one has non-vanishing classical Noether charges defined by Kähler action and non-trivial quantum dynamics in M^4 degrees of freedom. One could also assign to space-time surfaces conserved four-momenta which is not possible in topological QFTs. For this reason the conditions guaranteeing the vanishing of Coulomb interaction term deserve a detailed analysis.

1. For the known extremals j_K^α either vanishes or is light-like ("massless extremals" for which weak self-duality condition does not make sense [K11]) so that the Coulombic term vanishes identically in the gauge used. The addition of a gradient to A induces terms located at the ends and wormhole throats of the space-time surface but this term must be cancelled by the other boundary terms by gauge invariance of Kähler action. This implies that the M^4 part of WCW metric vanishes in this case. Therefore massless extremals as such are not physically realistic: wormhole throats representing particles are needed.
2. The original naive conclusion was that since Chern-Simons action depends on CP_2 coordinates only, its variation with respect to Minkowski coordinates must vanish so that the WCW metric would be trivial in M^4 degrees of freedom. This conclusion is in conflict with quantum classical correspondence and was indeed too hasty. The point is that the allowed variations of Kähler function must respect the weak electro-magnetic duality which relates Kähler electric field depending on the induced 4-metric at 3-surface to the Kähler magnetic field. Therefore the dependence on M^4 coordinates creeps via a Lagrange multiplier term

$$\int \Lambda_\alpha (J^{n\alpha} - K \epsilon^{n\alpha\beta\gamma} J_{\beta\gamma}) \sqrt{g_4} d^3x . \quad (2.6.11)$$

The (1,1) part of second variation contributing to M^4 metric comes from this term.

3. This erratic conclusion about the vanishing of M^4 part WCW metric raised the question about how to achieve a non-trivial metric in M^4 degrees of freedom. The proposal was a modification of the weak form of electric-magnetic duality. Besides CP_2 Kähler form there would be the Kähler form assignable to the light-cone boundary reducing to that for $r_M = \text{constant}$ sphere - call it J^1 . The generalization of the weak form of self-duality would be $J^{n\beta} = \epsilon^{n\beta\gamma\delta} K (J_{\gamma\delta} + \epsilon J_{\gamma\delta}^1)$. This form implies that the boundary term gives a non-trivial contribution to the M^4 part of

the WCW metric even without the constraint from electric-magnetic duality. Kähler charge is not affected unless the partonic 2-surface contains the tip of CD in its interior. In this case the value of Kähler charge is shifted by a topological contribution. Whether this term can survive depends on whether the resulting vacuum extremals are consistent with the basic facts about classical gravitation.

4. The Coulombic interaction term is not invariant under gauge transformations. The good news is that this might allow to find a gauge in which the Coulomb term vanishes. The vanishing condition fixing the gauge transformation ϕ is

$$j_K^\alpha \partial_\alpha \phi = -j^\alpha A_\alpha \quad . \quad (2.6.12)$$

This differential equation can be reduced to an ordinary differential equation along the flow lines j_K by using $dx^\alpha/dt = j_K^\alpha$. Global solution is obtained only if one can combine the flow parameter t with three other coordinates- say those at the either end of CD to form space-time coordinates. The condition is that the parameter defining the coordinate differential is proportional to the covariant form of Kähler current: $dt = \phi j_K$. This condition in turn implies $d^2t = d(\phi j_K) = d\phi \wedge j_K + \phi dj_K = 0$ implying $j_K \wedge dj_K = 0$ or more concretely,

$$\epsilon^{\alpha\beta\gamma\delta} j_\beta^K \partial_\gamma j_\delta^K = 0 \quad . \quad (2.6.13)$$

j_K is a four-dimensional counterpart of Beltrami field [B49] and could be called generalized Beltrami field.

The integrability conditions follow also from the construction of the extremals of Kähler action [K11]. The conjecture was that for the extremals the 4-dimensional Lorentz force vanishes (no dissipation): this requires $j_K \wedge J = 0$. One manner to guarantee this is the topologization of the Kähler current meaning that it is proportional to the instanton current: $j_K = \phi j_I$, where $j_I = *(J \wedge A)$ is the instanton current, which is not conserved for 4-D CP_2 projection. The conservation of j_K implies the condition $j_I^\alpha \partial_\alpha \phi = \partial_\alpha j^\alpha \phi$ and from this ϕ can be integrated if the integrability condition $j_I \wedge dj_I = 0$ holds true implying the same condition for j_K . By introducing at least 3 or CP_2 coordinates as space-time coordinates, one finds that the contravariant form of j_I is purely topological so that the integrability condition fixes the dependence on M^4 coordinates and this selection is coded into the scalar function ϕ . These functions define families of conserved currents $j_K^\alpha \phi$ and $j_I^\alpha \phi$ and could be also interpreted as conserved currents associated with the critical deformations of the space-time surface.

5. There are gauge transformations respecting the vanishing of the Coulomb term. The vanishing condition for the Coulomb term is gauge invariant only under the gauge transformations $A \rightarrow A + \nabla\phi$ for which the scalar function the integral $\int j_K^\alpha \partial_\alpha \phi$ reduces to a total divergence a giving an integral over various 3-surfaces at the ends of CD and at throats vanishes. This is satisfied if the allowed gauge transformations define conserved currents

$$D_\alpha(j^\alpha \phi) = 0 \quad . \quad (2.6.14)$$

As a consequence Coulomb term reduces to a difference of the conserved charges $Q_\phi^e = \int j^0 \phi \sqrt{g_4} d^3x$ at the ends of the CD vanishing identically. The change of the imons type term is trivial if the total weighted Kähler magnetic flux $Q_\phi^m = \sum \int J \phi dA$ over wormhole throats is conserved. The existence of an infinite number of conserved weighted magnetic fluxes is in accordance with the electric-magnetic duality. How these fluxes relate to the flux Hamiltonians central for WCW geometry is not quite clear.

6. The gauge transformations respecting the reduction to almost topological QFT should have some special physical meaning. The measurement interaction term in the modified Dirac interaction corresponds to a critical deformation of the space-time sheet and is realized as an addition of a gauge part to the Kähler gauge potential of CP_2 . It would be natural to identify this gauge transformation giving rise to a conserved charge so that the conserved charges would provide a representation for the charges associated with the infinitesimal critical deformations not affecting Kähler action. The gauge transformed Kähler potential couples to the modified Dirac equation and its effect could be visible in the value of Kähler function and therefore also in the properties of the preferred extremal. The effect on WCW metric would however vanish since K would transform only by an addition of a real part of a holomorphic function. Kähler function is identified as a Dirac determinant for Chern-Simons Dirac action and the spectrum of this operator should not be invariant under these gauge transformations if this picture is correct. This is achieved if the gauge transformation is carried only in the Dirac action corresponding to the Chern-Simons term: this assumption is motivated by the breaking of time reversal invariance induced by quantum measurements. The modification of Kähler action can be guessed to correspond just to the Chern-Simons contribution from the instanton term.
7. A reasonable looking guess for the explicit realization of the quantum classical correspondence between quantum numbers and space-time geometry is that the deformation of the preferred extremal due to the addition of the measurement interaction term is induced by a $U(1)$ gauge transformation induced by a transformation of $\delta CD \times CP_2$ generating the gauge transformation represented by ϕ . This interpretation makes sense if the fluxes defined by Q_ϕ^m and corresponding Hamiltonians affect only zero modes rather than quantum fluctuating degrees of freedom.

To sum up, one could understand the basic properties of WCW metric in this framework. Effective 2-dimensionality would result from the existence of an infinite number of conserved charges in two different time directions (genuine conservation laws plus gauge fixing). The infinite-dimensional symmetric space for given values of zero modes corresponds to the Cartesian product of the WCWs associated with the partonic 2-surfaces at both ends of CD and the generalized Chern-Simons term decomposes into a sum of terms from the ends giving single particle Kähler functions and to the terms from light-like wormhole throats giving interaction term between positive and negative energy parts of the state. Hence Kähler function could be calculated without any knowledge about the interior of the space-time sheets and TGD would reduce to almost topological QFT as speculated earlier. Needless to say this would have immense boost to the program of constructing WCW Kähler geometry.

2.6.4 Kähler action for Euclidian regions as Kähler function and Kähler action for Minkowskian regions as Morse function?

One of the nasty questions about the interpretation of Kähler action relates to the square root of the metric determinant. If one proceeds completely straightforwardly, the only reason conclusion is that the square root is imaginary in Minkowskian space-time regions so that Kähler action would be complex. The Euclidian contribution would have a natural interpretation as positive definite Kähler function but how should one interpret the imaginary Minkowskian contribution? Certainly the path integral approach to quantum field theories supports its presence. For some mysterious reason I was able to forget this nasty question and serious consideration of the obvious answer to it. Only when I worked between possible connections between TGD and Floer homology [K93] I realized that the Minkowskian contribution is an excellent candidate for Morse function whose critical points give information about WCW homology. This would fit nicely with the vision about TGD as almost topological QFT.

Euclidian regions would guarantee the convergence of the functional integral and one would have a mathematically well-defined theory. Minkowskian contribution would give the quantal interference effects and stationary phase approximation. The analog of Floer homology would represent quantum superpositions of critical points identifiable as ground states defined by the extrema of Kähler action for Minkowskian regions. Perturbative approach to quantum TGD would rely on functional integrals around the extrema of Kähler function. One would have maxima also for the Kähler function but only in the zero modes not contributing to the WCW metric.

There is a further question related to almost topological QFT character of TGD. Should one assume that the reduction to Chern-Simons terms occurs for the preferred extremals in *both* Minkowskian and Euclidian regions or only in Minkowskian regions?

1. All arguments for this have been represented for Minkowskian regions [K31] involve local light-like momentum direction which does not make sense in the Euclidian regions. This does not however kill the argument: one can have non-trivial solutions of Laplacian equation in the region of CP_2 bounded by wormhole throats: for CP_2 itself only covariantly constant right-handed neutrino represents this kind of solution and at the same time supersymmetry. In the general case solutions of Laplacian represent broken super-symmetries and should be in one-one correspondences with the solutions of the modified Dirac equation. The interpretation for the counterparts of momentum and polarization would be in terms of classical representation of color quantum numbers.
2. If the reduction occurs in Euclidian regions, it gives in the case of CP_2 two 3-D terms corresponding to two 3-D gluing regions for three coordinate patches needed to define coordinates and spinor connection for CP_2 so that one would have two Chern-Simons terms. I have earlier claimed that without any other contributions the first term would be identical with that from Minkowskian region apart from imaginary unit and different coefficient. This statement is wrong since the space-like parts of the corresponding 3-surfaces are disjoint for Euclidian and Minkowskian regions.
3. There is also another very delicate issue involved. Quantum classical correspondence requires that the quantum numbers of partonic states must be coded to the space-time geometry, and this is achieved by adding to the action a measurement interaction term which reduces to what is almost a gauge term present only in Chern-Simons-Dirac equation but not at space-time interior [K31]. This term would represent a coupling to Poincare quantum numbers at the Minkowskian side and to color and electro-weak quantum numbers at CP_2 side. Therefore the net Chern-Simons contributions would be different.
4. There is also a very beautiful argument stating that Dirac determinant for Chern-Simons-Dirac action equals to Kähler function, which would be lost if Euclidian regions would not obey holography. The argument obviously generalizes and applies to both Morse and Kähler function which are definitely not proportional to each other.

The Minkowskian contribution of Kähler action is imaginary due to the negative of the metric determinant and gives a phase factor to vacuum functional reducing to Chern-Simons terms at wormhole throats. Ground state degeneracy due to the possibility of having both signs for Minkowskian contribution to the exponent of vacuum functional provides a general view about the description of CP breaking in TGD framework.

1. In TGD framework path integral is replaced by inner product involving integral over WCV. The vacuum functional and its conjugate are associated with the states in the inner product so that the phases of vacuum functionals cancel if only one sign for the phase is allowed. Minkowskian contribution would have no physical significance. This of course cannot be the case. The ground state is actually degenerate corresponding to the phase factor and its complex conjugate since \sqrt{g} can have two signs in Minkowskian regions. Therefore the inner products between states associated with the two ground states define 2×2 matrix and non-diagonal elements contain interference terms due to the presence of the phase factor. At the limit of full CP_2 type vacuum extremal the two ground states would reduce to each other and the determinant of the matrix would vanish.
2. A small mixing of the two ground states would give rise to CP breaking and the first principle description of CP breaking in systems like $K - \bar{K}$ and of CKM matrix should reduce to this mixing. K^0 mesons would be CP even and odd states in the first approximation and correspond to the sum and difference of the ground states. Small mixing would be present having exponential sensitivity to the actions of CP_2 type extremals representing wormhole throats. This might allow to understand qualitatively why the mixing is about 50 times larger than expected for B^0 mesons.

3. There is a strong temptation to assign the two ground states with two possible arrows of geometric time. At the level of M-matrix the two arrows would correspond to state preparation at either upper or lower boundary of CD. Do long- and shortlived neutral K mesons correspond to almost fifty-fifty orthogonal superpositions for the two arrow of geometric time or almost completely to a fixed arrow of time induced by environment? Is the dominant part of the arrow same for both or is it opposite for long and short-lived neutral measons? Different lifetimes would suggest that the arrow must be the same and apart from small leakage that induced by environment. CP breaking would be induced by the fact that CP is performed only K^0 but not for the environment in the construction of states. One can probably imagine also alternative interpretations.

2.6.5 A general solution ansatz based on almost topological QFT property

The basic vision behind the ansatz is the reduction of quantum TGD to almost topological field theory. This requires that the flow parameters associated with the flow lines of isometry currents and Kähler current extend to global coordinates. This leads to integrability conditions implying generalized Beltrami flow and Kähler action for the preferred extremals reduces to Chern-Simons action when weak electro-weak duality is applied as boundary conditions. The strongest form of the hydrodynamical interpretation requires that all conserved currents are parallel to Kähler current. In the more general case one would have several hydrodynamic flows. Also the braidings (several of them for the most general ansatz) assigned with the light-like 3-surfaces are naturally defined by the flow lines of conserved currents. The independent behavior of particles at different flow lines can be seen as a realization of the complete integrability of the theory. In free quantum field theories on mass shell Fourier components are in a similar role but the geometric interpretation in terms of flow is of course lacking. This picture should generalize also to the solution of the modified Dirac equation.

Basic field equations

Consider first the equations at general level.

1. The breaking of the Poincare symmetry due to the presence of monopole field occurs and leads to the isometry group $T \times SO(3) \times SU(3)$ corresponding to time translations, rotations, and color group. The Cartan algebra is four-dimensional and field equations reduce to the conservation laws of energy E , angular momentum J , color isospin I_3 , and color hypercharge Y .
2. Quite generally, one can write the field equations as conservation laws for I, J, I_3 , and Y .

$$D_\alpha [D_\beta (J^{\alpha\beta} H_A) - j_K^\alpha H^A + T^{\alpha\beta} j_A^l h_{kl} \partial_\beta h^l] = 0 . \quad (2.6.15)$$

The first term gives a contraction of the symmetric Ricci tensor with antisymmetric Kähler form and vanishes so that one has

$$D_\alpha [j_K^\alpha H^A - T^{\alpha\beta} j_A^k h_{kl} \partial_\beta h^l] = 0 . \quad (2.6.16)$$

For energy one has $H_A = 1$ and energy current associated with the flow lines is proportional to the Kähler current. Its divergence vanishes identically.

3. One can express the divergence of the term involving energy momentum tensor as as sum of terms involving $j_K^\alpha J_{\alpha\beta}$ and contraction of second fundamental form with energy momentum tensor so that one obtains

$$j_K^\alpha D_\alpha H^A = j_K^\alpha J_{\alpha\beta} j_\beta^A + T^{\alpha\beta} H_{\alpha\beta}^k j_k^A . \quad (2.6.17)$$

Hydrodynamical solution ansatz

The characteristic feature of the solution ansatz would be the reduction of the dynamics to hydrodynamics analogous to that for a continuous distribution of particles initially at the end of X^3 of the light-like 3-surface moving along flow lines defined by currents j_A satisfying the integrability condition $j_A \wedge dj_A = 0$. Field theory would reduce effectively to particle mechanics along flow lines with conserved charges defined by various isometry currents. The strongest condition is that all isometry currents j_A and also Kähler current j_K are proportional to the same current j . The more general option corresponds to multi-hydrodynamics.

Conserved currents are analogous to hydrodynamical currents in the sense that the flow parameter along flow lines extends to a global space-time coordinate. The conserved current is proportional to the gradient $\nabla\Phi$ of the coordinate varying along the flow lines: $J = \Psi\nabla\Phi$ and by a proper choice of Ψ one can allow to have conservation. The initial values of Ψ and Φ can be selected freely along the flow lines beginning from either the end of the space-time surface or from wormhole throats.

If one requires hydrodynamics also for Chern-Simons action (effective 2-dimensionality is required for preferred extremals), the initial values of scalar functions can be chosen freely only at the partonic 2-surfaces. The freedom to choose the initial values of the charges conserved along flow lines at the partonic 2-surfaces means the existence of an infinite number of conserved charges so that the theory would be integrable and even in two different coordinate directions. The basic difference as compared to ordinary conservation laws is that the conserved currents are parallel and their flow parameter extends to a global coordinate.

1. The most general assumption is that the conserved isometry currents

$$J_A^\alpha = j_K^\alpha H^A - T^{\alpha\beta} j_A^k h_{kl} \partial_\beta h^l \quad (2.6.18)$$

and Kähler current are integrable in the sense that $J_A \wedge J_A = 0$ and $j_K \wedge j_K = 0$ hold true. One could imagine the possibility that the currents are not parallel.

2. The integrability condition $dJ_A \wedge J_A = 0$ is satisfied if one one has

$$J_A = \Psi_A d\Phi_A . \quad (2.6.19)$$

The conservation of J_A gives

$$d * (\Psi_A d\Phi_A) = 0 . \quad (2.6.20)$$

This would mean separate hydrodynamics for each of the currents involved. In principle there is not need to assume any further conditions and one can imagine infinite basis of scalar function pairs (Ψ_A, Φ_A) since criticality implies infinite number deformations implying conserved Noether currents.

3. The conservation condition reduces to d'Alembert equation in the induced metric if one assumes that $\nabla\Psi_A$ is orthogonal with every $d\Phi_A$.

$$d * d\Phi_A = 0 , \quad d\Psi_A \cdot d\Phi_A = 0 . \quad (2.6.21)$$

Taking $x = \Phi_A$ as a coordinate the orthogonality condition states $g^{xj} \partial_j \Psi_A = 0$ and in the general case one cannot solve the condition by simply assuming that Ψ_A depends on the coordinates transversal to Φ_A only. These conditions bring in mind $p \cdot p = 0$ and $p \cdot e$ condition for massless modes of Maxwell field having fixed momentum and polarization. $d\Phi_A$ would correspond to p

and $d\Psi_A$ to polarization. The condition that each isometry current corresponds its own pair (Ψ_A, Φ_A) would mean that each isometry current corresponds to independent light-like momentum and polarization. Ordinary free quantum field theory would support this view whereas hydrodynamics and QFT limit of TGD would support single flow.

These are the most general hydrodynamical conditions that one can assume. One can consider also more restricted scenarios.

1. The strongest ansatz is inspired by the hydrodynamical picture in which all conserved isometry charges flow along same flow lines so that one would have

$$J_A = \Psi_A d\Phi . \quad (2.6.22)$$

In this case same Φ would satisfy simultaneously the d'Alembert type equations.

$$d * d\Phi = 0 , \quad d\Psi_A \cdot d\Phi = 0. \quad (2.6.23)$$

This would mean that the massless modes associated with isometry currents move in parallel manner but can have different polarizations. The spinor modes associated with light-like like 3-surfaces carry parallel four-momenta, which suggest that this option is correct. This allows a very general family of solutions and one can have a complete 3-dimensional basis of functions Ψ_A with gradient orthogonal to $d\Phi$.

2. Isometry invariance under $T \times SO(3) \times SU(3)$ allows to consider the possibility that one has

$$J_A = k_A \Psi_A d\Phi_{G(A)} , \quad d * (d\Phi_{G(A)}) = 0 , \quad d\Psi_A \cdot d\Phi_{G(A)} = 0 . \quad (2.6.24)$$

where $G(A)$ is T for energy current, $SO(3)$ for angular momentum currents and $SU(3)$ for color currents. Energy would thus flow along its own flux lines, angular momentum along its own flow lines, and color quantum numbers along their own flow lines. For instance, color currents would differ from each other only by a numerical constant. The replacement of Ψ_A with $\Psi_{G(A)}$ would be too strong a condition since Killing vector fields are not related by a constant factor.

To sum up, the most general option is that each conserved current J_A defines its own integrable flow lines defined by the scalar function pair (Ψ_A, Φ_A) . A complete basis of scalar functions satisfying the d'Alembert type equation guaranteeing current conservation could be imagined with restrictions coming from the effective 2-dimensionality reducing the scalar function basis effectively to the partonic 2-surface. The diametrically opposite option corresponds to the basis obtained by assuming that only single Φ is involved.

The proposed solution ansatz can be compared to the earlier ansatz [K40] stating that Kähler current is topologized in the sense that for $D(CP_2) = 3$ it is proportional to the identically conserved instanton current (so that 4-D Lorentz force vanishes) and vanishes for $D(CP_2) = 4$ (Maxwell phase). This hypothesis requires that instanton current is Beltrami field for $D(CP_2) = 3$. In the recent case the assumption that also instanton current satisfies the Beltrami hypothesis in strong sense (single function Φ) generalizes the topologization hypothesis for $D(CP_2) = 3$. As a matter fact, the topologization hypothesis applies to isometry currents also for $D(CP_2) = 4$ although instanton current is not conserved anymore.

Can one require the extremal property in the case of Chern-Simons action?

Effective 2-dimensionality is achieved if the ends and wormhole throats are extremals of Chern-Simons action. The strongest condition would be that space-time surfaces allow orthogonal slicings by 3-surfaces which are extremals of Chern-Simons action.

Also in this case one can require that the flow parameter associated with the flow lines of the isometry currents extends to a global coordinate. Kähler magnetic field $B = *J$ defines a conserved current so that all conserved currents would flow along the field lines of B and one would have 3-D Beltrami flow. Note that in magnetohydrodynamics the standard assumption is that currents flow along the field lines of the magnetic field.

For wormhole throats light-likeness causes some complications since the induced metric is degenerate and the contravariant metric must be restricted to the complement of the light-like direction. This means that d'Alembert equation reduces to 2-dimensional Laplace equation. For space-like 3-surfaces one obtains the counterpart of Laplace equation with partonic 2-surfaces serving as sources. The interpretation in terms of analogs of Coulomb potentials created by 2-D charge distributions would be natural.

2.6.6 Hydrodynamic picture in fermionic sector

Super-symmetry inspires the conjecture that the hydrodynamical picture applies also to the solutions of the modified Dirac equation.

4-dimensional modified Dirac equation and hydrodynamical picture

Consider first the solutions of of the induced spinor field in the interior of space-time surface.

1. The local inner products of the modes of the induced spinor fields define conserved currents

$$\begin{aligned} D_\alpha J_{mn}^\alpha &= 0 , \\ J_{mn}^\alpha &= \bar{u}_m \hat{\Gamma}^\alpha u_n , \\ \hat{\Gamma}^\alpha &= \frac{\partial L_K}{\partial(\partial_\alpha h^k)} \Gamma_k . \end{aligned} \tag{2.6.25}$$

The conjecture is that the flow parameters of also these currents extend to a global coordinate so that one would have in the completely general case the condition

$$\begin{aligned} J_{mn}^\alpha &= \Phi_{mn} d\Psi_{mn} , \\ d*(d\Phi_{mn}) &= 0 , \quad \nabla\Psi_{mn} \cdot \Phi_{mn} = 0 . \end{aligned} \tag{2.6.26}$$

The condition $\Phi_{mn} = \Phi$ would mean that the massless modes propagate in parallel manner and along the flow lines of Kähler current. The conservation condition along the flow line implies tht the current component J_{mn} is constant along it. Everything would reduce to initial values at the ends of the space-time sheet boundaries of CD and 3-D modified Dirac equation would reduce everything to initial values at partonic 2-surfaces.

2. One might hope that the conservation of these super currents for all modes is equivalent with the modified Dirac equation. The modes u_n appearing in Ψ in quantized theory would be kind of "square roots" of the basis Φ_{mn} and the challenge would be to deduce the modes from the conservation laws.
3. The quantization of the induced spinor field in 4-D sense would be fixed by those at 3-D space-like ends by the fact that the oscillator operators are carried along the flow lines as such so that the anti-commutator of the induced spinor field at the opposite ends of the flow lines at the light-like boundaries of CD is in principle fixed by the anti-commutations at the either end. The anti-commutations at 3-D surfaces cannot be fixed freely since one has 3-D Chern-Simons flow reducing the anti-commutations to those at partonic 2-surfaces.

The following argument suggests that induced spinor fields are in a suitable gauge simply constant along the flow lines of the Kähler current just as massless spinor modes are constant along the geodesic in the direction of momentum.

1. The modified gamma matrices are of form $T_k^\alpha \Gamma^k$, $T_k^\alpha = \partial L_K / \partial (\partial_\alpha h^k)$. The H-vectors T_k^α can be expressed as linear combinations of a subset of Killing vector fields j_A^k spanning the tangent space of H . For CP_2 the natural choice are the 4 Lie-algebra generators in the complement of $U(2)$ sub-algebra. For CD one can use generator time translation and three generators of rotation group $SO(3)$. The completeness of the basis defined by the subset of Killing vector fields gives completeness relation $h_l^k = j^{Ak} j_{Al}$. This implies $T^{\alpha k} = T^{\alpha k} j_A^k j_A^\alpha = T^{\alpha A} j_A^k$. One can define gamma matrices Γ_A as $\Gamma_k j_A^k$ to get $T_k^\alpha \Gamma^k = T^{\alpha A} \Gamma_A$.
2. This together with the condition that all isometry currents are proportional to the Kähler current (or if this vanishes to some conserved current- say energy current) satisfying Beltrami flow property implies that one can reduce the modified Dirac equation to an ordinary differential equation along flow lines. The quantities T^{tA} are constant along the flow lines and one obtains

$$T^{tA} j_A D_t \Psi = 0 . \quad (2.6.27)$$

By choosing the gauge suitably the spinors are just constant along flow lines so that the spinor basis reduces by effective 2-dimensionality to a complete spinor basis at partonic 2-surfaces.

Generalized eigen modes for the modified Chern-Simons Dirac equation and hydrodynamical picture

Hydrodynamical picture helps to understand also the construction of generalized eigen modes of 3-D Chern-Simons Dirac equation.

The general form of generalized eigenvalue equation for Chern-Simons Dirac action

Consider first the the general form and interpretation of the generalized eigenvalue equation assigned with the modified Dirac equation for Chern-Simons action [K19] . This is of course only an approximation since an additional contribution to the modified gamma matrices from the Lagrangian multiplier term guaranteeing the weak form of electric-magnetic duality must be included.

1. The modified Dirac equation for Ψ is consistent with that for its conjugate if the coefficient of the instanton term is real and one uses the Dirac action $\bar{\Psi}(D^\rightarrow - D^\leftarrow)\Psi$ giving modified Dirac equation as

$$D_{C-S} \Psi + \frac{1}{2} (D_\alpha \hat{\Gamma}_{C-S}^\alpha) \Psi = 0 . \quad (2.6.28)$$

As noticed, the divergence $D_\alpha \hat{\Gamma}_{C-S}^\alpha$ does not contain second derivatives in the case of Chern-Simons action. In the case of Kähler action they occur unless field equations equivalent with the vanishing of the divergence term are satisfied. The extremals of Chern-Simons action provide a natural manner to define effective 2-dimensionality.

Also the fermionic current is conserved in this case, which conforms with the idea that fermions flow along the light-like 3-surfaces. If one uses the action $\bar{\Psi} D^\rightarrow \Psi$, $\bar{\Psi}$ does not satisfy the Dirac equation following from the variational principle and fermion current is not conserved.

2. The generalized eigen modes of D_{C-S} should be such that one obtains the counterpart of Dirac propagator which is purely algebraic and does not therefore depend on the coordinates of the throat. This is satisfied if the generalized eigenvalues are expressible in terms of covariantly constant combinations of gamma matrices and here only M^4 gamma matrices are possible. Therefore the eigenvalue equation would read as

$$D\Psi = \lambda^k \gamma_k \Psi, \quad D = D_{C-S} + \frac{1}{2} D_\alpha \hat{\Gamma}_{C-S}^\alpha, \quad D_{C-S} = \hat{\Gamma}_{C-S}^\alpha D_\alpha. \quad (2.6.29)$$

Here the covariant derivatives D_α contain the measurement interaction term as an apparent gauge term. For extremals one has

$$D = D_{C-S}. \quad (2.6.30)$$

Covariant constancy allows to take the square of this equation and one has

$$(D^2 + [D, \lambda^k \gamma_k])\Psi = \lambda^k \lambda_k \Psi. \quad (2.6.31)$$

The commutator term is analogous to magnetic moment interaction.

3. The generalized eigenvalues correspond to $\lambda = \sqrt{\lambda^k \lambda_k}$ and Dirac determinant is defined as a product of the eigenvalues and conjecture to give the exponent of Kähler action reducing to Chern-Simons term. λ is completely analogous to mass. λ_k cannot be however interpreted as ordinary four-momentum: for instance, number theoretic arguments suggest that λ_k must be restricted to the preferred plane $M^2 \subset M^4$ interpreted as a commuting hyper-complex plane of complexified quaternions. For incoming lines this mass would vanish so that all incoming particles irrespective their actual quantum numbers would be massless in this sense and the propagator is indeed that for a massless particle. Note that the eigen-modes define the boundary values for the solutions of $D_K \Psi = 0$ so that the values of λ indeed define the counterpart of the momentum space.

This transmutation of massive particles to effectively massless ones might make possible the application of the twistor formalism as such in TGD framework [K89]. $N = 4$ SUSY is one of the very few gauge theory which might be UV finite but it is definitely unphysical due to the masslessness of the basic quanta. Could the resolution of the interpretational problems be that the four-momenta appearing in this theory do not directly correspond to the observed four-momenta?

2. Inclusion of the constraint term

As already noticed one must include also the constraint term due to the weak form of electric-magnetic duality and this changes somewhat the above simple picture.

1. At the 3-dimensional ends of the space-time sheet and at wormhole throats the 3-dimensionality allows to introduce a coordinate varying along the flow lines of Kähler magnetic field $B = *J$. In this case the integrability conditions state that the flow is Beltrami flow. Note that the value of B^α along the flow line defining magnetic flux appearing in anti-commutation relations is constant. This suggests that the generalized eigenvalue equation for the Chern-Simons action reduces to a collection of ordinary apparently independent differential equations associated with the flow lines beginning from the partonic 2-surface. This indeed happens when the CP_2 projection is 2-dimensional. In this case it however seems that the basis u_n is not of much help.
2. The conclusion is wrong: the variations of Chern-Simons action are subject to the constraint that electric-magnetic duality holds true expressible in terms of Lagrange multiplier term

$$\int \Lambda_\alpha (J^{n\alpha} - K \epsilon^{n\alpha\beta\gamma} J_{\beta\gamma}) \sqrt{g_4} d^3 x. \quad (2.6.32)$$

This gives a constraint force to the field equations and also a dependence on the induced 4-metric so that one has only almost topological QFT. This term also guarantees the M^4 part of WCW Kähler metric is non-trivial. The condition that the ends of space-time sheet and wormhole throats are extrema of Chern-Simons action subject to the electric-magnetic duality constraint is strongly suggested by the effective 2-dimensionality. Without the constraint term Chern-Simons action would vanish for its extremals so that Kähler function would be identically zero.

This term implies also an additional contribution to the modified gamma matrices besides the contribution coming from Chern-Simons action so that the first guess for the modified Dirac operator would not be quite correct. This contribution is of exactly of the same general form as the contribution for any general coordinate invariant action. The dependence of the induced metric on M^4 degrees of freedom guarantees that also M^4 gamma matrices are present. In the following this term will not be considered.

3. When the contribution of the constraint term to the modified gamma matrices is neglected, the explicit expression of the modified Dirac operator D_{C-S} associated with the Chern-Simons term is given by

$$\begin{aligned}
D &= \hat{\Gamma}^\mu D_\mu + \frac{1}{2} D_\mu \hat{\Gamma}^\mu , \\
\hat{\Gamma}^\mu &= \frac{\partial L_{C-S}}{\partial_\mu h^k} \Gamma_k = \epsilon^{\mu\alpha\beta} [2J_{kl} \partial_\alpha h^l A_\beta + J_{\alpha\beta} A_k] \Gamma^k D_\mu , \\
D_\mu \hat{\Gamma}^\mu &= B_K^\alpha (J_{k\alpha} + \partial_\alpha A_k) , \\
B_K^\alpha &= \epsilon^{\alpha\beta\gamma} J_{\beta\gamma} , \quad J_{k\alpha} = J_{kl} \partial_\alpha s^l , \quad \hat{\epsilon}^{\alpha\beta\gamma} = \epsilon^{\alpha\beta\gamma} \sqrt{g_3} .
\end{aligned} \tag{2.6.33}$$

For the extremals of Chern-Simons action one has $D_\alpha \hat{\Gamma}^\alpha = 0$. Analogous condition holds true when the constraining contribution to the modified gamma matrices is added.

3. Generalized eigenvalue equation for Chern-Simons Dirac action

Consider now the Chern-Simons Dirac equation in more detail assuming that the inclusion of the constraint contribution to the modified gamma matrices does not induce any complications. Assume also extremal property for Chern-Simons action with constraint term and Beltrami flow property.

1. For the extremals the Chern-Simons Dirac operator (constraint term not included) reduces to a one-dimensional Dirac operator

$$D_{C-S} = \hat{\epsilon}^{r\alpha\beta} [2J_{k\alpha} A_\beta + J_{\alpha\beta} A_k] \Gamma^k D_r . \tag{2.6.34}$$

Constraint term implies only a modification of the modified gamma matrices but the form of the operator remains otherwise same when extrema are in question so that one has $D_\alpha \hat{\Gamma}^\alpha = 0$.

2. For the extremals of Chern-Simons action the general solution of the modified Chern-Simons Dirac equation ($\lambda^k = 0$) is covariantly constant with respect to the coordinate r :

$$D_r \Psi = 0 . \tag{2.6.35}$$

The solution to this condition can be written immediately in terms of a non-integrable phase factor $P \exp(i \int A_r dr)$, where integration is along curve with constant transversal coordinates. If $\hat{\Gamma}^v$ is light-like vector field also $\hat{\Gamma}^v \Psi_0$ defines a solution of D_{C-S} . This solution corresponds to a zero mode for D_{C-S} and does not contribute to the Dirac determinant (suggested to give rise to

the exponent of Kähler function identified as Kähler action). Note that the dependence of these solutions on transversal coordinates of X_l^3 is arbitrary which conforms with the hydrodynamic picture. The solutions of Chern-Simons-Dirac are obtained by similar integration procedure also when extremals are not in question.

The formal solution associated with a general eigenvalue λ can be constructed by integrating the eigenvalue equation separately along all coordinate curves. This makes sense if r indeed assigned to possibly light-like flow lines of B^α or more general Beltrami field possible induced by the constraint term. There are very strong consistency conditions coming from the conditions that Ψ in the interior is constant along the flow lines of Kähler current and continuous at the ends and throats (call them collectively boundaries), where Ψ has a non-trivial variation along the flow lines of B^α .

1. This makes sense only if the flow lines of the Kähler current are transversal to the boundaries so that the spinor modes at boundaries dictate the modes of the spinor field in the interior. Effective 2-dimensionality means that the spinor modes in the interior can be calculated either by starting from the throats or from the ends so that the data at either upper or lower partonic 2-surfaces dictates everything in accordance with zero energy ontology.
2. This gives an infinite number of commuting diagrams stating that the flow-line time evolution along flow lines along wormhole throats from lower partonic 2-surface to the upper one is equivalent with the flow-line time evolution along the lower end of space-time surface to interior, then along interior to the upper end of the space-time surface and then back to the upper partonic 2-surface. If the space-time surface allows a slicing by partonic 2-surfaces these conditions can be assumed for any pair of partonic 2-surfaces connected by Chern-Simons flow evolution.
3. Since the time evolution along interior keeps the spinor field as constant in the proper gauge and since the flow evolutions at the lower and upper ends are in a reverse direction, there is a strong attemptation to assume that the spinor field at the ends of the of the flow lines of Kähler magnetic field are identical apart from a gauge transformation. This leads to a particle-in-box quantization of the values of the pseudo-mass (periodic boundary conditions). These conditions will be assumed in the sequel.

These assumptions lead to the following picture about the generalized eigen modes.

1. By choosing the gauge so that covariant derivative reduces to ordinary derivative and using the constancy of $\hat{\Gamma}^r$, the solution of the generalized eigenvalue equation can be written as

$$\begin{aligned}\Psi &= \exp(iL(r)\hat{\Gamma}^r\lambda^k\Gamma_k)\Psi_0 , \\ L(r) &= \int_0^r \frac{1}{\sqrt{\hat{g}^{rr}}}dr .\end{aligned}\tag{2.6.36}$$

$L(r)$ can be regarded as the along flux line as defined by the effective metric defined by modified gamma matrices. If λ_k is linear combination of Γ^0 and Γ^{rM} it anti-commutes with Γ^r which contains only CP_2 gamma matrices so that the pseudo-momentum is a priori arbitrary.

2. When the constraint term taking care of the electric-magnetic duality is included, also M^4 gamma matrices are present. If they are in the orthogonal complement of a preferred plane $M^2 \subset M^4$, anti-commutativity is achieved. This assumption cannot be fully justified yet but conforms with the general physical vision. There is an obvious analogy with the condition that polarizations are in a plane orthogonal to M^2 . The condition indeed states that only transversal deformations define quantum fluctuating WCW degrees of freedom contributing to the WCW Kähler metric. In M^8-H duality the preferred plane M^2 is interpreted as a hyper-complex plane belonging to the tangent space of the space-time surface and defines the plane of non-physical polarizations. Also a generalization of this plane to an integrable distribution of planes $M^2(x)$ has been proposed and one must consider also now the possibility of a varying plane $M^2(x)$ for the pseudo-momenta. The scalar function Φ appearing in the general solution ansatz for the field equations satisfies massless d'Alembert equation and its gradient defines a local light-like

direction at space-time-level and hence a 2-D plane of the tangent space. Maybe the projection of this plane to M^4 could define the preferred M^2 . The minimum condition is that these planes are defined only at the ends of space-time surface and at wormhole throats.

3. If one accepts this hypothesis, one can write

$$\begin{aligned}\Psi &= \left[\cos(L(r)\lambda) + i \sin(\lambda(r)) \hat{\Gamma}^r \lambda^k \Gamma_k \right] \Psi_0 , \\ \lambda &= \sqrt{\lambda_k \lambda^k} .\end{aligned}\tag{2.6.37}$$

4. Boundary conditions should fix the spectrum of masses. If the the flow lines of Kähler current coincide with the flow lines of Kähler magnetic field or more general Beltrami current at wormhole throats one ends up with difficulties since the induced spinor fields must be constant along flow lines and only trivial eigenvalues are possible. Hence it seems that the two Beltrami fields must be transversal. This requires that at the partonic 2-surfaces the value of the induced spinor mode in the interior coincides with its value at the throat. Since the induced spinor fields in interior are constant along flow lines, one must have

$$\exp(i\lambda L(r_{max})) = 1 .\tag{2.6.38}$$

This implies that one has essentially particle in a box with size defined by the effective metric

$$\lambda_n = \frac{n2\pi}{L(r_{max})} .\tag{2.6.39}$$

5. This condition cannot however hold true simultaneously for all points of the partonic 2-surfaces since $L(r_{max})$ depends on the point of the surface. In the most general case one can consider only a subset consisting of the points for which the values of $L(r_{max})$ are rational multiples of the value of $L(r_{max})$ at one of the points -call it L_0 . This implies the notion of number theoretical braid. Induced spinor fields are localized to the points of the braid defined by the flow lines of the Kähler magnetic field (or equivalently, any conserved current- this resolves the longstanding issue about the identification of number theoretical braids). The number of the included points depends on measurement resolution characterized somehow by the number rationals which are allowed. Only finite number of harmonics and sub-harmonics of L_0 are possible so that for integer multiples the number of points is finite. If $n_{max}L_0$ and L_0/n_{min} are the largest and smallest lengths involved, one can argue that the rationals n_{max}/n , $n = 1, \dots, n_{max}$ and n/n_{min} , $n = 1, \dots, n_{min}$ are the natural ones.

6. One can consider also algebraic extensions for which L_0 is scaled from its reference value by an algebraic number so that the mass scale m must be scaled up in similar manner. The spectrum comes also now in integer multiples. p-Adic mass calculations predicts mass scales to the inverses of square roots of prime and this raises the expectation that \sqrt{n} harmonics and sub-harmonics of L_0 might be necessary. Notice however that pseudo-momentum spectrum is in question so that this argument is on shaky grounds.

There is also the question about the allowed values of (λ_0, λ_3) for a given value of λ . This issue will be discussed in the next section devoted to the attempt to calculate the Dirac determinant assignable to this spectrum: suffice it to say that integer valued spectrum is the first guess implying that the pseudo-momenta satisfy $n_0^2 - n_3^2 = n^2$ and therefore correspond to Pythagorean triangles. What is remarkable that the notion of number theoretic braid pops up automatically from the Beltrami flow hypothesis.

2.6.7 Possible role of Beltrami flows and symplectic invariance in the description of gauge and gravitational interactions

One of the most recent observations made by people working with twistors is the finding of Monteiro and O'Connell described in the preprint *The Kinematic Algebra From the Self-Dual Sector* [B58]. The claim is that one can obtain supergravity amplitudes by replacing the color factors with kinematic factors which obey formally 2-D symplectic algebra defined by the plane defined by light-like momentum direction and complexified variable in the plane defined by polarizations. One could say that momentum and polarization dependent kinematic factors are in exactly the same role as the factors coming from Yang-Mills couplings. Unfortunately, the symplectic algebra looks rather formal object since the first coordinate is light-like coordinate and second coordinate complex transverse coordinate. It could make sense only in the complexification of Minkowski space.

In any case, this would suggest that the gravitational gauge group (to be distinguished from diffeomorphisms) is symplectic group of some kind having enormous representative power as we know from the fact that the symmetries of practically any physical system are realized in terms of symplectic transformations. According to the authors of [B58] one can identify the Lie algebra of symplectic group of sphere with that of $SU(N)$ at large N limit in suitable basis. What makes this interesting is that at large N limit non-planar diagrams which are the problem of twistor Grassmann approach vanish: this is old result of t'Hooft, which initiated the developments leading to AdS/CFT correspondence.

The symplectic group of $\delta M_{\pm}^4 \times CP_2$ is the isometry algebra of WCW and I have proposed that the effective replacement of gauge group with this group implies the vanishing of non-planar diagrams [K92]. The extension of SYM to a theory of also gravitation in TGD framework could make Yangian symmetry exact, resolve the infrared divergences, and the problems caused by non-planar diagrams. It would also imply stringy picture in finite measurement resolution. Also the construction of the non-commutative homology and cohomology in TGD framework led to the lifting of Galois group algebras to their braided variants realized as symplectic flows [K93] and to the conjecture that in finite measurement resolution the cohomology obtained in this manner represents WCW ("world of classical worlds") spinor fields (or at least something very essential about them).

It is however difficult to understand how one could generalize the symplectic structure so that also symplectic transformations involving light-like coordinate and complex coordinate of the partonic 2-surface would make sense in some sense. In fact, a more natural interpretation for the kinematic algebra would in terms of volume preserving flows which are also Beltrami flows [B49, B52]. This gives a connection with quantum TGD since Beltrami flows define a basic dynamical symmetry for the preferred extremals of Kähler action which might be called Maxwellian phase.

1. Classical TGD is defined by Kähler action which is the analog of Maxwell action with Maxwell field expressed as the projection of CP_2 Kähler form. The field equations are extremely non-linear and only the second topological half of Maxwell equations is satisfied. The remaining equations state conservation laws for various isometry currents. Actually much more general conservation laws are obtained.
2. As a special case one obtains solutions analogous to those for Maxwell equations but there are also other objects such as CP_2 type vacuum extremals providing correlates for elementary particles and string like objects: for these solutions it does not make sense to speak about QFT in Minkowski space-time. For the Maxwell like solutions linear superposition is lost but a superposition holds true for solutions with the same local direction of polarization and massless four-momentum. This is a very quantal outcome (in accordance with quantum classical correspondence) since also in quantum measurement one obtains final state with fixed polarization and momentum. So called massless extremals (topological light rays) analogous to wave guides containing laser beam and its phase conjugate are solutions of this kind. The solutions are very interesting since no dispersion occurs so that wave packet preserves its form and the radiation is precisely targeted.
3. Maxwellian preferred extremals decompose in Minkowskian space-time regions to regions that can be regarded as classical space-time correlates for massless particles. Massless particles are characterized by polarization direction and light-like momentum direction. Now these directions can depend on position and are characterized by gradients of two scalar functions Φ and Ψ . Φ defines light-like momentum direction and the square of the gradient of Φ in Minkowski metric

must vanish. Ψ defines polarization direction and its gradient is orthogonal to the gradient of Φ since polarization is orthogonal to momentum.

4. The flow has the additional property that the coordinate associated with the flow lines integrates to a global coordinate. Beltrami flow is the term used by mathematicians. Beltrami property means that the condition $j \wedge dj = 0$ is satisfied. In other words, the current is in the plane defined by its exterior derivative. The above representation obviously guarantees this. Beltrami property allows to assign order parameter to the flow depending only the parameter varying along flow line.

This is essential for the hydrodynamical interpretation of the preferred extremals which relies on the idea that various conservation laws hold along flow lines. For instance, super-conducting phase requires this kind of flow and velocity along flow line is gradient of the order parameter. The breakdown of super-conductivity would mean topologically the loss of the Beltrami flow property. One might say that the space-time sheets in TGD Universe represent analogs of supra flow and this property is spoiled only by the finite size of the sheets. This strongly suggests that the space-time sheets correspond to perfect fluid flows with very low viscosity to entropy ratio and one application is to the observed perfect flow behavior of quark gluon plasma.

5. The current $J = \Phi \nabla \Psi$ has vanishing divergence if besides the orthogonality of the gradients the functions Ψ and Φ satisfy massless d'Alembert equation. This is natural for massless field modes and when these functions represent constant wave vector and polarization also d'Alembert equations are satisfied. One can actually add to $\nabla \Psi$ a gradient of an arbitrary function of Φ this corresponds to $U(1)$ gauge invariance and the addition to the polarization vector a vector parallel to light-like four-momentum. One can replace Φ by any function of Φ so that one has Abelian Lie algebra analogous to $U(1)$ gauge algebra restricted to functions depending on Φ only.

The general Beltrami flow gives as a special case the kinetic flow associated by Monteiro and O'Connell with plane waves. For ordinary plane wave with constant direction of momentum vector and polarization vector one could take $\Phi = \cos(\phi)$, $\phi = k \cdot m$ and $\Psi = \epsilon \cdot m$. This would give a real flow. The kinematical factor in SYM diagrams corresponds to a complexified flow $\Phi = \exp(i\phi)$ and $\Psi = \phi + w$, where w is complex coordinate for polarization plane or more naturally, complexification of the coordinate in polarization direction. The flow is not unique since gauge invariance allows to modify ϕ term. The complexified flow is volume preserving only in the formal algebraic sense and satisfies the analog of Beltrami condition only in Dolbeault cohomology where d is identified as complex exterior derivative ($df = df/dz dz$ for holomorphic functions). In ordinary cohomology it fails. This formal complex flow of course does not define a real diffeomorphism at space-time level: one should replace Minkowski space with its complexification to get a genuine flow.

The finding of Monteiro and O'Connell encourages to think that the proposed more general Abelian algebra pops up also in non-Abelian YM theories. Discretization by braids would actually select single polarization and momentum direction. If the volume preserving Beltrami flows characterize the basic building bricks of radiation solutions of both general relativity and YM theories, it would not be surprising if the kinematic Lie algebra generators would appear in the vertices of YM theory and replace color factors in the transition from YM theory to general relativity. In TGD framework the construction of vertices at partonic two-surfaces would define local kinematic factors as effectively constant ones.

2.7 How to define Dirac determinant?

The basic challenge is to define Dirac determinant hoped to give rise to the exponent of Kähler action associated with the preferred extremal. The reduction to almost topological QFT gives this kind of expression in terms of Chern-Simons action and one might hope of obtaining even more concrete expression from the Chern-Simons Dirac determinant. The calculation of the previous section allowed to calculate the most general spectrum of the modified Dirac operator. If the number of the eigenvalues is infinite as the naive expectation is then Dirac determinant diverges if calculated as the product of the eigenvalues and one must calculate it by using some kind of regularization procedure. Zeta function regularization is the natural manner to do this.

The following arguments however lead to a concrete vision how the regularization could be avoided and a connection with infinite primes. In fact, the manifestly finite option and the option involving zeta function regularization give Kähler functions differing only by a scaling factor and only the manifestly finite option satisfies number theoretical constraints coming from p-adicization. An explicit expression for the Dirac determinant in terms of geometric data of the orbit of the partonic 2-surface emerges.

Arithmetic quantum field theory defined by infinite primes emerges naturally. The lines of the generalized Feynman graphs are characterized by infinite primes and the selection rules correlating the geometries of the lines of the generalized Feynman graphs corresponds to the conservation of the sum of number theoretic momenta $\log(p_i)$ assignable to sub-braids corresponding to different primes p_i assignable to the orbit of parton. This conforms with the vision that infinite primes indeed characterize the geometry of light-like 3-surfaces and therefore also of space-time sheets. The eigenvalues of the modified Dirac operator are proportional $1/\sqrt{p_i}$ where p_i are the primes appearing in the definition of the p-adic prime and the interpretation as analogs of Higgs vacuum expectation values makes sense and is consistent with p-adic length scale hypothesis and p-adic mass calculations. It must be emphasized that all this is essentially due to single basic hypothesis, namely the reduction of quantum TGD to almost topological QFT guaranteed by the Beltrami ansatz for field equations and by the weak form of electric-magnetic duality.

2.7.1 Dirac determinant when the number of eigenvalues is infinite

At first sight the general spectrum looks the only reasonable possibility but if the eigenvalues correlate with the geometry of the partonic surface as quantum classical correspondence suggests, this conclusion might be wrong. The original hope was the number of eigenvalues would be finite so that also determinant would be finite automatically. There were some justifications for this hope in the definition of Dirac determinant based on the dimensional reduction of D_K as $D_K = D_{K,3} + D_1$ and the identification of the generalized eigenvalues as those assigned to $D_{K,3}$ as analogs of energy eigenvalues assignable to the light-like 3-surface. It will be found that number theoretic input could allow to achieve a manifest finiteness in the case of D_{C-S} and that this option is the only possible one if number theoretic universality is required.

If there are no constraints on the eigenvalue spectrum of D_{C-S} for a given partonic orbit, the naive definition of the determinant gives an infinite result and one must define Dirac determinant using ζ function regularization implying that Kähler function reduces to the derivative of the zeta function $\zeta_D(s)$ -call it Dirac Zeta- associated with the eigenvalue spectrum.

Consider now the situation when the number of eigenvalues is infinite.

1. In this kind of situation zeta function regularization is the standard manner to define the Dirac determinant. What one does is to assign zeta function to the spectrum- let us call it Dirac zeta function and denote by $\zeta_D(s)$ - as

$$\zeta_D(s) = \sum_k \lambda_k^{-s} . \quad (2.7.1)$$

If the eigenvalue λ_k has degeneracy g_k it appears g_k times in the sum. In the case of harmonic oscillator one obtains Riemann zeta for which sum representation converges only for $Re(s) \geq 1$. Riemann zeta can be however analytically continued to the entire complex plane and the idea is that this can be done also in the more general case.

2. By the basic conjecture Kähler function corresponds to the logarithm of the Dirac determinant and equals to the sum of the logarithms of the eigenvalues

$$K = \log\left(\prod \lambda_k\right) = -\frac{d\zeta_D}{ds} \Big|_{s=0} . \quad (2.7.2)$$

The expression on the left hand side diverges if taken as such but the expression on the right hand side based on the analytical continuation of the zeta function is completely well-defined and

finite quantity. Note that the replacement of eigenvalues λ_k by their powers λ_k^n -or equivalently the increase of the degeneracy by a factor n - brings in only a factor n to K : $K \rightarrow nK$.

3. Dirac determinant involves in the minimal situation only the integer multiples of pseudo-mass scale $\lambda = 2\pi/L_{min}$. One can consider also rational and even algebraic multiples $qL_{min} < L_{max}$, $q \geq 1$, of L_{min} so that one would have several integer spectra simultaneously corresponding to different braids. Here L_{min} and L_{max} are the extrema of the braid strand length determined in terms of the effective metric as $L = \int (\hat{g}^{rr})^{-1/2} dr$. The question what multiples are involved will be needed later.
4. Each rational or algebraic multiple of L_{min} gives to the zeta function a contribution which is of same form so that one has

$$\zeta_D = \sum_q \zeta(\log(qx)s) , \quad x = \frac{L_{min}}{R} , \quad 1 \leq q < \frac{L_{max}}{L_{min}} . \quad (2.7.3)$$

Kähler function can be expressed as

$$K = \sum_n \log(\lambda_n) = - \frac{d\zeta_D(s)}{ds} = - \sum_q \log(qx) \frac{d\zeta(s)}{ds} \Big|_{s=0} , \quad x = \frac{L_{min}}{R} . \quad (2.7.4)$$

What is remarkable that the number theoretical details of ζ_D determine only the overall scaling factor of Kähler function and thus the value of Kähler coupling strength, which would be purely number theoretically determined if the hypothesis about the role of infinite primes is correct. Also the value of R is irrelevant since it does not affect the Kähler metric.

5. The dependence of Kähler function on WCW degrees of freedom would be coded completely by the dependence of the length scales qL_{min} on the complex coordinates of WCW: note that this dependence is different for each scale. This is reminiscent of the coding of the shape of the drum (or more generally - manifold) by the spectrum of its eigen frequencies. Now Kähler geometry would code for the dependence of the spectrum on the shape of the drum defined by the partonic 2-surface and the 4-D tangent space distribution associated with it.

What happens at the limit of vacuum extremals serves as a test for the identification of Kähler function as Dirac determinant. The weak form of electric magnetic duality implies that all components of the induced Kähler field vanish simultaneously if Kähler magnetic field cancels. In the modified Chern-Simons Dirac equation one obtains $L = \int (\hat{g}^{rr})^{-1/2} dr$. The modified gamma matrix $\hat{\Gamma}^r$ approaches a finite limit when Kähler magnetic field vanishes

$$\hat{\Gamma}^r = \epsilon^{r\beta\gamma} (2J_{\beta k} A_\gamma + J_{\beta\gamma} A_k) \Gamma^k \rightarrow 2\epsilon^{r\beta\gamma} J_{\beta k} \Gamma^k . \quad (2.7.5)$$

The relevant component of the effective metric is \hat{g}^{rr} and is given by

$$\hat{g}^{rr} = (\hat{\Gamma}^r)^2 = 4\epsilon^{r\beta\gamma} \epsilon^{r\mu\nu} J_{\beta k} J_\mu^k A_\gamma A_\nu . \quad (2.7.6)$$

The limit is non-vanishing in general and therefore the eigenvalues remain finite also at this limit as also the parameter $L_{min} = \int (\hat{g}^{rr})^{-1/2} dr$ defining the minimum of the length of the braid strand defined by Kähler magnetic flux line in the effective metric unless \hat{g}^{rr} goes to zero everywhere inside the partonic surface. Chern-Simons action and Kähler action vanish for vacuum extremals so that in this case one could require that Dirac determinant approaches to unity in a properly chosen gauge. Dirac determinant should approach to unit for vacuum extremals indeed approaches to unity since there are no finite eigenvalues at the limit $\hat{g}^{rr} = 0$.

2.7.2 Hyper-octonionic primes

Before detailed discussion of the hyper-octonionic option it is good to consider the basic properties of hyper-octonionic primes.

1. Hyper-octonionic primes are of form

$$\Pi_p = (n_0, n_3, n_1, n_2, \dots, n_7) , \quad \Pi_p^2 = n_0^2 - \sum_i n_i^2 = p \text{ or } p^2 . \quad (2.7.7)$$

2. Hyper-octonionic primes have a standard representation as hyper-complex primes. The Minkowski norm squared factorizes into a product as

$$n_0^2 - n_3^2 = (n_0 + n_3)(n_0 - n_3) . \quad (2.7.8)$$

If one has $n_3 \neq 0$, the prime property implies $n_0 - n_3 = 1$ so that one obtains $n_0 = n_3 + 1$ and $2n_3 + 1 = p$ giving

$$(n_0, n_3) = ((p+1)/2, (p-1)/2) . \quad (2.7.9)$$

Note that one has $(p+1)/2$ odd for $p \bmod 4 = 1$ and $(p+1)/2$ even for $p \bmod 4 = 3$). The difference $n_0 - n_3 = 1$ characterizes prime property.

If n_3 vanishes the prime property implies equivalence with ordinary prime and one has $n_0^2 = p^2$. These hyper-octonionic primes represent particles at rest.

3. The action of a discrete subgroup $G(p)$ of the octonionic automorphism group G_2 generates form hyper-complex primes with $n_3 \neq 0$ further hyper-octonionic primes $\Pi(p, k)$ corresponding to the same value of n_0 and p and for these the integer valued projection to M^2 satisfies $n_0^2 - n_3^2 = n > p$. It is also possible to have a state representing the system at rest with $(n_0, n_3) = ((p+1)/2, 0)$ so that the pseudo-mass varies in the range $[\sqrt{p}, (p+1)/2]$. The subgroup $G(n_0, n_3) \subset SU(3)$ leaving invariant the projection (n_0, n_3) generates the hyper-octonionic primes corresponding to the same value of mass for hyper-octonionic primes with same Minkowskian length p and pseudo-mass $\lambda = n \geq \sqrt{p}$.
4. One obtains two kinds of primes corresponding to the lengths of pseudo-momenta equal to p or \sqrt{p} . The first kind of particles are always at rest whereas the second kind of particles can be brought at rest only if one interprets the pseudo-momentum as M^2 projection. This brings in mind the secondary p-adic length scales assigned to causal diamonds (CDs) and the primary p-adic lengths scales assigned to particles.

If the M^2 projections of hyper-octonionic primes with length \sqrt{p} characterize the allowed basic momenta, ζ_D is sum of zeta functions associated with various projections which must be in the limits dictated by the geometry of the orbit of the partonic surface giving upper and lower bounds L_{max} and L_{min} on the length L . L_{min} is scaled up to $\sqrt{n_0^2 - n_3^2} L_{min}$ for a given projection (n_0, n_3) . In general a given M^2 projection (n_0, n_3) corresponds to several hyper-octonionic primes since $SU(3)$ rotations give a new hyper-octonionic prime with the same M^2 projection. This leads to an inconsistency unless one has a good explanation for why some basic momentum can appear several times. One might argue that the spinor mode is degenerate due to the possibility to perform discrete color rotations of the state. For hyper complex representatives there is no such problem and it seems favored. In any case, one can look how the degeneracy factors for given projection can be calculated.

1. To calculate the degeneracy factor $D(n)$ associated with given pseudo-mass value $\lambda = n$ one must find all hyper-octonionic primes Π , which can have projection in M^2 with length n and sum up the degeneracy factors $D(n, p)$ associated with them:

$$\begin{aligned}
 D(n) &= \sum_p D(n, p) , \\
 D(n, p) &= \sum_{n_0^2 - n_3^2 = p} D(p, n_0, n_3) , \\
 n_0^2 - n_3^2 &= n , \quad \Pi_p^2(n_0, n_3) = n_0^2 - n_3^2 - \sum_i n_i^2 = n - \sum_i n_i^2 = p .
 \end{aligned} \tag{2.7.10}$$

2. The condition $n_0^2 - n_3^2 = n$ allows only Pythagorean triangles and one must find the discrete subgroup $G(n_0, n_3) \subset SU(3)$ producing hyper-octonions with integer valued components with length p and components (n_0, n_3) . The points at the orbit satisfy the condition

$$\sum n_i^2 = p - n . \tag{2.7.11}$$

The degeneracy factor $D(p, n_0, n_3)$ associated with given mass value n is the number of elements of in the coset space $G(n_0, n_3, p)/H(n_0, n_3, p)$, where $H(n_0, n_3, p)$ is the isotropy group of given hyper-octonionic prime obtained in this manner. For $n_0^2 - n_3^2 = p^2$ $D(n_0, n_3, p)$ obviously equals to unity.

2.7.3 Three basic options for the pseudo-momentum spectrum

The calculation of the scaling factor of the Kähler function requires the knowledge of the degeneracies of the mass squared eigen values. There are three options to consider.

First option: all pseudo-momenta are allowed

If the degeneracy for pseudo-momenta in M^2 is same for all mass values- and formally characterizable by a number N telling how many 2-D pseudo-momenta reside on mass shell $n_0^2 - n_3^2 = m^2$. In this case zeta function would be proportional to a sum of Riemann Zetas with scaled arguments corresponding to scalings of the basic mass m to m/q .

$$\zeta_D(s) = N \sum_q \zeta(\log(qx)s) , \quad x = \frac{L_{min}}{R} . \tag{2.7.12}$$

This option provides no idea about the possible values of $1 \leq q \leq L_{max}/L_{min}$. The number N is given by the integral of relativistic density of states $\int dk/2\sqrt{k^2 + m^2}$ over the hyperbola and is logarithmically divergent so that the normalization factor N of the Kähler function would be infinite.

Second option: All integer valued pseudomomenta are allowed

Second option is inspired by number theoretic vision and assumes integer valued components for the momenta using $m_{max} = 2\pi/L_{min}$ as mass unit. p-Adicization motivates also the assumption that momentum components using m_{max} as mass scale are integers. This would restrict the choice of the number theoretical braids.

Integer valuedness together with masses coming as integer multiples of m_{max} implies $(\lambda_0, \lambda_3) = (n_0, n_3)$ with on mass shell condition $n_0^2 - n_3^2 = n^2$. Note that the condition is invariant under scaling. These integers correspond to Pythagorean triangles plus the degenerate situation with $n_3 = 0$. There exists a finite number of pairs (n_0, n_3) satisfying this condition as one finds by expressing n_0 as $n_0 = n_3 + k$ giving $2n_3k + k^2 = p^2$ giving $n_3 < n^2/2, n_0 < n^2/2 + 1$. This would be enough to have a

finite degeneracy $D(n) \geq 1$ for a given value of mass squared and ζ_D would be well defined. ζ_D would be a modification of Riemann zeta given by

$$\begin{aligned}\zeta_D &= \sum_q \zeta_1(\log(qx)s) , \quad x = \frac{L_{min}}{R} , \\ \zeta_1(s) &= \sum g_n n^{-s} , \quad g_n \geq 1 .\end{aligned}\tag{2.7.13}$$

For generalized Feynman diagrams this option allows conservation of pseudo-momentum and for loops no divergences are possible since the integral over two-dimensional virtual momenta is replaced with a sum over discrete mass shells containing only a finite number of points. This option looks thus attractive but requires a regularization. On the other hand, the appearance of a zeta function having a strong resemblance with Riemann zeta could explain the finding that Riemann zeta is closely related to the description of critical systems. This point will be discussed later.

Third option: Infinite primes code for the allowed mass scales

According to the proposal of [K79] , [L4] the hyper-complex parts of hyper-octonionic primes appearing in their infinite counterparts correspond to the M^2 projections of real four-momenta. This hypothesis suggests a very detailed map between infinite primes and standard model quantum numbers and predicts a universal mass spectrum [K79] . Since pseudo-momenta are automatically restricted to the plane M^2 , one cannot avoid the question whether they could actually correspond to the hyper-octonionic primes defining the infinite prime. These interpretations need not of course exclude each other. This option allows several variants and at this stage it is not possible to exclude any of these options.

1. One must choose between two alternatives for which pseudo-momentum corresponds to hyper-complex prime serving as a canonical representative of a hyper-octonionic prime or a projection of hyper-octonionic prime to M^2 .
2. One must decide whether one allows a) only the momenta corresponding to hyper-complex primes, b) also their powers (p-adic fractality), or c) all their integer multiples ("Riemann option").

One must also decide what hyper-octonionic primes are allowed.

1. The first guess is that all hyper-complex/hyper-octonionic primes defining length scale $\sqrt{p}L_{min} \leq L_{max}$ or $pL_{min} \leq L_{max}$ are allowed. p-Adic fractality suggests that also the higher p-adic length scales $p^{n/2}L_{min} < L_{max}$ and $p^n L_{min} < L_{max}$, $n \geq 1$, are possible.

It can however happen that no primes are allowed by this criterion. This would mean vanishing Kähler function which is of course also possible since Kähler action can vanish (for instance, for massless extremals). It seems therefore safer to allow also the scale corresponding to the trivial prime $(n_0, n_3) = (1, 0)$ (1 is formally prime because it is not divisible by any prime different from 1) so that at least L_{min} is possible. This option also allows only rather small primes unless the partonic 2-surface contains vacuum regions in which case L_{max} is infinite: in this case all primes would be allowed and the exponent of Kähler function would vanish.

2. The hypothesis that only the hyper-complex or hyper-octonionic primes appearing in the infinite hyper-octonionic prime are possible looks more reasonable since large values of p would be possible and could be identified in terms of the p-adic length scale hypothesis. All hyper-octonionic primes appearing in infinite prime would be possible and the geometry of the orbit of the partonic 2-surface would define an infinite prime. This would also give a concrete physical interpretation for the earlier hypothesis that hyper-octonionic primes appearing in the infinite prime characterize partonic 2-surfaces geometrically. One can also identify the fermionic and purely bosonic primes appearing in the infinite prime as braid strands carrying fermion number and purely bosonic quantum numbers. This option will be assumed in the following.

2.7.4 Expression for the Dirac determinant for various options

The expressions for the Dirac determinant for various options can be deduced in a straightforward manner. Numerically Riemann option and manifestly finite option do not differ much but their number theoretic properties are totally different.

Riemann option

All integer multiples of these basic pseudo-momenta would be allowed for Riemann option so that ζ_D would be sum of Riemann zetas with arguments scaled by the basic pseudo-masses coming as inverses of the basic length scales for braid strands. For the option involving only hyper-complex primes the formula for ζ_D reads as

$$\begin{aligned} \zeta_D &= \zeta(\log(x_{min}s)) + \sum_{i,n} \zeta(\log(x_{i,n}s)) + \sum_{i,n} \zeta(\log(y_{i,n}s)) , \\ x_{i,n} &= p_i^{n/2} x_{min} \leq x_{max} , \quad p_i \geq 3 , \quad y_{i,n} = p_i^n x_{min} \leq x_{max} \cdot p_i \geq 2 , \end{aligned} \quad (2.7.14)$$

L_{max} resp. L_{min} is the maximal resp. minimal length $L = \int (\hat{g}^{rr})^{-1/2} dr$ for the braid strand defined by the flux line of the Kähler magnetic field in the effective metric. The contributions correspond to the effective hyper-complex prime $p_1 = (1, 0)$ and hyper-complex primes with Minkowski lengths \sqrt{p} ($p \geq 3$) and $p, p \geq 2$. If also higher p-adic length scales $L_n = p^{n/2} L_{min} < L_{max}$ and $L_n = p^n L_{min} < L_{max}$, $n > 1$, are allowed there is no further restriction on the summation. For the restricted option only L_n , $n = 0, 2$ is allowed.

The expressions for the Kähler function and its exponent reads as

$$\begin{aligned} K &= k(\log(x_{min}) + \sum_i \log(x_i) + \sum_i \log(y_i)) , \\ exp(K) &= \left(\frac{1}{x_{min}}\right)^k \times \prod_i \left(\frac{1}{x_i}\right)^k \times \prod_i \left(\frac{1}{y_i}\right)^k , \\ x_i &\leq x_{max} , \quad y_i \leq x_{max} , \quad k = -\frac{d\zeta(s)}{ds} \Big|_{s=0} = \frac{1}{2} \log(2\pi) \simeq .9184 . \end{aligned} \quad (2.7.15)$$

From the point of view of p-adicization program the appearance of strongly transcendental numbers in the normalization factor of ζ_D is not a well-come property.

If the scaling of the WCW Kähler metric by $1/k$ is a legitimate procedure it would allow to get rid of the transcendental scaling factor k and this scaling would cancel also the transcendental from the exponent of Kähler function. The scaling is not however consistent with the view that Kähler coupling strength determines the normalization of the WCW metric.

This formula generalizes in a rather obvious manner to the cases when one allows M^2 projections of hyper-octonionic primes.

Manifestly finite options

The options for which one does not allow summation over all integer multiples of the basic momenta characterized by the canonical representatives of hyper-complex primes or their projections to M^2 are manifestly finite. They differ from the Riemann option only in that the normalization factor $k \simeq .9184$ defined by the derivative Riemann Zeta at origin is replaced with $k = 1$. This would mean manifest finiteness of ζ_D . Kähler function and its exponent are given by

$$\begin{aligned} K &= k(\log(x_{min}) + \sum_i \log(x_i) + \sum_i \log(y_i)) , \quad x_i \leq x_{max} , \quad y_i \leq x_{max} , \\ exp(K) &= \frac{1}{x_{min}} \times \prod_i \frac{1}{x_i} \times \prod_i \frac{1}{y_i} . \end{aligned} \quad (2.7.16)$$

Numerically the Kähler functions do not differ much since their ratio is .9184. Number theoretically these functions are however completely different. The resulting dependence involves only square roots of primes and is an algebraic function of the lengths p_i and rational function of x_{min} . p-Adicization program would require rational values of the lengths x_{min} in the intersection of the real and p-adic worlds if one allows algebraic extension containing the square roots of the primes involved. Note that in p-adic context this algebraic extension involves two additional square roots for $p > 2$ if one does not want square root of p . Whether one should allow for R_p also extension based on \sqrt{p} is not quite clear. This would give 8-D extension.

For the more general option allowing all projections of hyper-complex primes to M^2 the general form of Kähler function is same. Instead of pseudo-masses coming as primes and their square roots one has pseudomasses coming as square roots of some integers $n \leq p$ or $n \leq p^2$ for each p . In this case the conservation laws are not so strong.

Note that in the case of vacuum extremals $x_{min} = \infty$ holds true so that there are no primes satisfying the condition and Kähler function vanishes as it indeed should.

More concrete picture about the option based on infinite primes

The identification of pseudo-momenta in terms of infinite primes suggests a rather concrete connection between number theory and physics.

1. One could assign the finite hyper-octonionic primes Π_i making the infinite prime to the sub-braids identified as Kähler magnetic flux lines with the same length L in the effective metric. The primes assigned to the finite part of the infinite prime correspond to single fermion and some number of bosons. The primes assigned to the infinite part correspond to purely bosonic states assignable to the purely bosonic braid strands. Purely bosonic state would correspond to the action of a WCW Hamiltonian to the state.

This correspondence can be expanded to include all quantum numbers by using the pair of infinite primes corresponding to the "vacuum primes" $X \pm 1$, where X is the product of all finite primes [K79]. The only difference with respect to the earlier proposal is that physical momenta would be replaced by pseudo-momenta.

2. Different primes p_i appearing in the infinite prime would correspond to their own sub-braids. For each sub-braid there is a N -fold degeneracy of the generalized eigen modes corresponding to the number N of braid strands so that many particle states are possible as required by the braid picture.
3. The correspondence of infinite primes with the hierarchy of Planck constants could allow to understand the fermion-many boson states and many boson states assigned with a given finite prime in terms of many-particle states assigned to n_a and n_b -sheeted singular covering spaces of CD and CP_2 assignable to the two infinite primes. This interpretation requires that only single p-adic prime p_i is realized as quantum state meaning that quantum measurement always selects a particular p-adic prime p_i (and corresponding sub-braid) characterizing the p-adicity of the quantum state. This selection of number field behind p-adic physics responsible for cognition looks very plausible.
4. The correspondence between pairs of infinite primes and quantum states [K79] allows to interpret color quantum numbers in terms of the states associated with the representations of a finite subgroup of $SU(3)$ transforming hyper-octonionic primes to each other and preserving the M^2 pseudo-momentum. Same applies to $SO(3)$. The most natural interpretation is in terms of wave functions in the space of discrete $SU(3)$ and $SO(3)$ transforms of the partonic 2-surface. The dependence of the pseudo-masses on these quantum numbers is natural so that the projection hypothesis finds support from this interpretation.
5. The infinite prime characterizing the orbit of the partonic 2-surface would thus code which multiples of the basic mass $2\pi/L_{min}$ are possible. Either the M^2 projections of hyper-octonionic primes or their hyper-complex canonical representatives would fix the basic M^2 pseudo-momenta for the corresponding number theoretic braid associated. In the reverse direction the knowledge of the light-like 3-surface, the CD and CP_2 coverings, and the number of the allowed discrete

$SU(3)$ and $SU(2)$ rotations of the partonic 2-surface would dictate the infinite prime assignable to the orbit of the partonic 2-surface.

One would also like to understand whether there is some kind of conservation laws associated with the pseudo-momenta at vertices. The arithmetic QFT assignable to infinite primes would indeed predict this kind of conservation laws.

1. For the manifestly finite option the ordinary conservation of pseudo-momentum conservation at vertices is not possible since the addition of pseudo-momenta does not respect the condition $n_0 - n_3 = 1$. In fact, this difference in the sum of hyper-complex prime momenta tells how many momenta are present. If one applies the conservation law to the sum of the pseudo-momenta corresponding to different primes and corresponding braids, one can have reactions in which the number of primes involved is conserved. This would give the selection rule $\sum_1^N p_i = \sum_1^N p_f$. These reactions have interpretation in terms of the geometry of the 3-surface representing the line of the generalized Feynman diagram.
2. Infinite primes define an arithmetic quantum field theory in which the total momentum defined as $\sum n_i \log(p_i)$ is a conserved quantity. As matter fact, each prime p_i would define a separately conserved momentum so that there would be an infinite number of conservation laws. If the sum $\sum_i \log(p_i)$ is conserved in the vertex, the primes p_i associated with the incoming particle are shared with the outgoing particles so that also the total momentum is conserved. This looks the most plausible option and would give very powerful number theoretical selection rules at vertices since the collection of primes associated with incoming line would be union of the collections associated with the outgoing lines and also total pseudo-momentum would be conserved.
3. For the both Riemann zeta option and manifestly finite options the arithmetic QFT associated with infinite primes would be realized at the level of pseudo-momenta meaning very strong selection rules at vertices coding for how the geometries of the partonic lines entering the vertex correlate. WCW integration would reduce for the lines of Feynman diagram to a sum over light-like 3-surfaces characterized by (x_{min}, x_{max}) with a suitable weighting factor and the exponent of Kähler function would give an exponential damping as a function of x_{min} .

Which option to choose?

One should be able to make two choices. One must select between hyper-complex representations and the projections of hyper-octonionic primes and between the manifestly finite options and the one producing Riemann zeta?

Hyper-complex option seems to be slightly favored over the projection option.

1. The appearance of the scales $\sqrt{p_i} x_{min}$ and possibly also their p^n multiples brings in mind p-adic length scales coming as \sqrt{p}^n multiples of CP_2 length scale. The scales $p_i x_{min}$ associated with hyper-complex primes reducing to ordinary primes in turn bring in mind the size scales assignable to CDs . The hierarchy of Planck constants implies also $\hbar/\hbar_0 = \sqrt{n_a n_b}$ multiples of these length scales but mass scales would not depend on n_a and n_b [K80]. For large values of p the pseudo-momenta are almost light-like for hyper-complex option whereas the projection option allows also states at rest.
2. Hyper-complex option predicts that only the p-adic pseudo-mass scales appear in the partition function and is thus favored by the p-adic length scale hypothesis. Projection option predicts also the possibility of the mass scales (not all of them) coming as $1/\sqrt{n}$. These mass scales are however not predicted by the hierarchy of Planck constants.
3. The same pseudo-mass scale can appear several times for the projection option. This degeneracy corresponds to the orbit of the hyper-complex prime under the subgroup of $SU(3)$ respecting integer property. Similar statement holds true in the case of $SO(3)$: these groups are assigned to the two infinite primes characterizing parton. The natural assignment of this degeneracy is to the discrete color rotational and rotational degrees associated with the partonic 2-surface itself rather than spinor modes at fixed partonic 2-surface. That the pseudo-mass would depend on color and angular momentum quantum numbers would make sense.

Consider next the arguments in favor of the manifestly finite option.

1. The manifestly finite option is admittedly more elegant than the one based on Riemann zeta and also guarantees that no additional loop summations over pseudo-momenta are present. The strongest support for the manifestly finite option comes from number theoretical universality.
2. One could however argue that the restriction of the pseudo-momenta to a finite number is not consistent with the modified Dirac-Chern-Simons equation. Quantum classical correspondence however implies correlation between the geometry of the partonic orbits and the pseudo-momenta and the summation over all prime valued pseudo-momenta is present but with a weighting factor coming from Kähler function implying exponential suppression.

The Riemann zeta option could be also defended.

1. The numerical difference of the normalization factors of the Kähler function is however only about 8 per cent and quantum field theorists might interpret the replacement the length scales x_i and y_i with x_i^d and y_i^d , $d \simeq .9184$, in terms of an anomalous dimension of these length scales. Could one say that radiative corrections mean the scaling of the original preferred coordinates so that one could still have consistency with number theoretic universality?
2. Riemann zeta with a non-vanishing argument could have also other applications in quantum TGD. Riemann zeta has interpretation as a partition function and the zeros of partition functions have interpretation in terms of phase transitions. The quantum criticality of TGD indeed corresponds to a phase transition point. There is also experimental evidence that the distribution of zeros of zeta corresponds to the distribution of energies of quantum critical systems in the sense that the energies correspond to the imaginary parts of the zeros of zeta [A33].

The first explanation would be in terms of the analogs of the harmonic oscillator coherent states with integer multiple of the basic momentum taking the role of occupation number of harmonic oscillator and the zeros $s = 1/2 + iy$ of ζ defining the values of the complex coherence parameters. TGD inspired strategy for the proof of Riemann hypothesis indeed leads to the identification of the zeros as coherence parameters rather than energies as in the case of Hilbert-Polya hypothesis [K71] and the vanishing of the zeta at zero has interpretation as orthogonality of the state with respect to the state defined by a vanishing coherence parameter interpreted as a tachyon. One should demonstrate that the energies of quantum states can correspond to the imaginary parts of the coherence parameters.

Second interpretation could be in terms of quantum critical zero energy states for which the "complex square root of density matrix" defines time-like entanglement coefficients of M -matrix. The complex square roots of the probabilities defined by the coefficient of harmonic oscillator states (perhaps identifiable in terms of the multiples of pseudo-momentum) in the coherent state defined by the zero of ζ would define the M -matrix in this situation. Energy would correspond also now to the imaginary part of the coherence parameter. The norm of the state would be completely well-defined.

Representation of configuration Kähler metric in terms of eigenvalues of D_{C-S}

A surprisingly concrete connection of the configuration space metric in terms of generalized eigenvalue spectrum of D_{C-S} results. From the general expression of Kähler metric in terms of Kähler function

$$G_{k\bar{l}} = \partial_k \partial_{\bar{l}} K = \frac{\partial_k \partial_{\bar{l}} \exp(K)}{\exp(K)} - \frac{\partial_k \exp(K)}{\exp(K)} \frac{\partial_{\bar{l}} \exp(K)}{\exp(K)}, \quad (2.7.17)$$

and from the expression of $\exp(K) = \prod_i \lambda_i$ as the product of of finite number of eigenvalues of D_{C-S} , the expression

$$G_{k\bar{l}} = \sum_i \frac{\partial_k \partial_{\bar{l}} \lambda_i}{\lambda_i} - \frac{\partial_k \lambda_i}{\lambda_i} \frac{\partial_{\bar{l}} \lambda_i}{\lambda_i} \quad (2.7.18)$$

for the configuration space metric follows. Here complex coordinates refer to the complex coordinates of configuration space. Hence the knowledge of the eigenvalue spectrum of $D_{C-S}(X^3)$ as function of some complex coordinates of configuration space allows to deduce the metric to arbitrary accuracy. If the above arguments are correct the calculation reduces to the calculation of the derivatives of $\log(\sqrt{p}L_{min}/R)$, where L_{min} is the length of the Kähler magnetic flux line between partonic 2-surfaces with respect to the effective metric defined by the anti-commutators of the modified gamma matrices. Note that these length scales have different dependence on WCW coordinates so that one cannot reduce everything to L_{min} . Therefore one would have explicit representation of the basic building brick of WCW Kähler metric in terms of the geometric data associated with the orbit of the partonic 2-surface.

The formula for the Kähler action of CP_2 type vacuum extremals is consistent with the Dirac determinant formula

The first killer test for the formula of Kähler function in terms of the Dirac determinant based on infinite prime hypothesis is provided by the action of CP_2 type vacuum extremals. One of the first attempts to make quantitative predictions in TGD framework was the prediction for the gravitational constant. The argument went as follows.

1. For dimensional reasons gravitational constant must be proportional to p-adic length scale squared, where p characterizes the space-time sheet of the graviton. It must be also proportional to the square of the vacuum function for the graviton representing a line of generalized Feynman diagram and thus to the exponent $\exp(-2K)$ of Kähler action for topologically condensed CP_2 type vacuum extremals with very long projection. If topological condensation does not reduce much of the volume of CP_2 type vacuum extremal, the action is just Kähler action for CP_2 itself. This gives

$$\hbar_0 G = L_p^2 \exp(2L_K(CP_2)) = pR^2 \exp(2L_K(CP_2)) . \quad (2.7.19)$$

2. Using as input the constraint $\alpha_K \simeq \alpha_{em} \sim 1/137$ for Kähler coupling strengths coming from the comparison of the TGD prediction for the rotation velocity of distant galaxies around galactic nucleus and the p-adic mass calculation for the electron mass, one obtained the result

$$\exp(2L_K(CP_2)) = \frac{1}{p \times \prod_{p_i \leq 23} p_i} . \quad (2.7.20)$$

The product contains the product of all primes smaller than 24 ($p_i \in \{2, 3, 5, 7, 11, 13, 17, 19, 23\}$). The expression for the Kähler function would be just of the form predicted by the Dirac determinant formula with L_{min} replaced with CP_2 length scale. As a matter fact, this was the first indication that particles are characterized by several p-adic primes but that only one of them is "active". As explained, the number theoretical state function reduction explains this.

3. The same formula for the gravitational constant would result for any prime p but the value of Kähler coupling strength would depend on prime p logarithmically for this option. I indeed proposed that this formula fixes the discrete evolution of the Kähler coupling strength as function of p-adic prime from the condition that gravitational constant is renormalization group invariant quantity but gave up this hypothesis later. It is wisest to keep an agnostic attitude to this issue.
4. I also made numerous brave attempts to deduce an explicit formula for Kähler coupling strength. The general form of the formula is

$$\frac{1}{\alpha_K} = k \log(K^2), \quad K^2 = p \times 2 \times 3 \times 5 \dots \times 23 . \quad (2.7.21)$$

The problem is the exact value of k cannot be known precisely and the guesses for its value depend on what one means with number theoretical universality. Should Kähler action be a rational number? Or is it Kähler function which is rational number (it is for the Dirac determinant option in this particular case). Is Kähler coupling strength $g_K^2/4\pi$ or g_K^2 a rational number? Some of the guesses were $k = \pi/4$ and $k = 137/107$. The facts that the value of Kähler action for the line of a generalized diagram is not exactly CP_2 action and the value of α_K is not known precisely makes these kind of attempts hopeless in absence of additional ideas.

Also other elementary particles -in particular exchanged bosons- should involve the exponent of Kähler action for CP_2 type vacuum extremal. Since the values of gauge couplings are gigantic as compared to the expression of the gravitational constant the value of Kähler action must be rather small form them. CP_2 type vacuum extremals must be short in the sense that L_{min} in the effective metric is very short. Note however that the p-adic prime characterizing the particle according to p-adic mass calculations would be large also now. One can of course ask whether this p-adic prime characterizes the gravitational space-time sheets associated with the particle and not the particle itself. The assignment of p-adic mass calculations with thermodynamics at gravitational space-time sheets of the particle would be indeed natural. The value of α_K would depend on p in logarithmic manner for this option. The topological condensation of could also eat a lot of CP_2 volume for them.

Eigenvalues of D_{C-S} as vacuum expectations of Higgs field?

Infinite prime hypothesis implies the analog of p-adic length scale hypothesis but since pseudo-momenta are in question, this need not correspond to the p-adic length scale hypothesis for the actual masses justified by p-adic thermodynamics. Note also that L_{min} does not correspond to CP_2 length scale. This is actually not a problem since the effective metric is not M^4 metric and one can quite well consider the possibility that L_{min} corresponds to CP_2 length scale in the the induced metric. The reason is that light-like 3- surface is in question the distance along the Kähler magnetic flux line reduces essentially to a distance along the partonic 2-surface having size scale of order CP_2 length for the partonic 2-surfaces identified as wormhole throats. Therefore infinite prime can code for genuine p-adic length scales associated with the light-like 3-surface and quantum states would correspond by number theoretical state function reduction hypothesis to single ordinary prime.

Support for this identification comes also from the expression of gravitational constant deduced from p-adic length scale hypothesis. The result is that gravitational constant is assumed to be proportional to have the expression $G = L_p^2 \exp(-2S_K(CP_2))$, where p characterizes graviton or the space-time sheet mediating gravitational interaction and exponent gives Kähler action for CP_2 type vacuum extremal representing graviton. The argument allows to identify the p-adic prime $p = M_{127}$ associated with electron (largest Mersenne prime which does not correspond to super-astronomical length scale) as the p-adic prime characterizing also graviton. The exponent of Kähler action is proportional to $1/p$ which conforms with the general expression for Kähler function. I have considered several identifications of the numerical factor and one of them has been as product of primes $2 \leq p \leq 23$ assuming that somehow the primes $\{2, \dots, 23, p\}$ characterize graviton. This guess is indeed consistent with the prediction of the infinite-prime hypothesis.

The first guess inspired by the p-adic mass calculations is that the squares λ_i^2 of the eigenvalues of D_{C-S} could correspond to the conformal weights of ground states. Another natural physical interpretation of λ is as an analog of the Higgs vacuum expectation. The instability of the Higgs=0 phase would corresponds to the fact that $\lambda = 0$ mode is not localized to any region in which ew magnetic field or induced Kähler field is non-vanishing. By the previous argument one would have order of magnitude estimate $h_0 = \sqrt{2\pi/L_{min}}$.

1. The vacuum expectation value of Higgs is only proportional to the scale of λ . Indeed, Higgs and gauge bosons as elementary particles correspond to wormhole contacts carrying fermion and anti-fermion at the two wormhole throats and must be distinguished from the space-time correlate of its vacuum expectation as something proportional to λ . For free fermions the vacuum expectation value of Higgs does not seem to be even possible since free fermions do not correspond to wormhole contacts between two space-time sheets but possess only single wormhole throat (p-adic mass calculations are consistent with this). If fermion suffers topological condensation as indeed assumed to do in interaction region, a wormhole contact is generated and makes possible the generation of Higgs vacuum expectation value.

2. Physical considerations suggest that the vacuum expectation of Higgs field corresponds to a particular eigenvalue λ_i of modified Chern-Simons Dirac operator so that the eigenvalues λ_i would define TGD counterparts for the minima of Higgs potential. For the minimal option one has only a finite number of pseudo-mass eigenvalues inversely proportional \sqrt{p} so that the identification as a Higgs vacuum expectation is consistent with the p-adic length scale hypothesis. Since the vacuum expectation of Higgs corresponds to a condensate of wormhole contacts giving rise to a coherent state, the vacuum expectation cannot be present for topologically condensed CP_2 type vacuum extremals representing fermions since only single wormhole throat is involved. This raises a hen-egg question about whether Higgs contributes to the mass or whether Higgs is only a correlate for massivation having description using more profound concepts. From TGD point of view the most elegant option is that Higgs does not give rise to mass but Higgs vacuum expectation value accompanies bosonic states and is naturally proportional to λ_i . With this interpretation λ_i could give a contribution to both fermionic and bosonic masses.
3. If the coset construction for super-symplectic and super Kac-Moody algebra implying Equivalence Principle is accepted, one encounters what looks like a problem. p-Adic mass calculations require negative ground state conformal weight compensated by Super Virasoro generators in order to obtain massless states. The tachyonicity of the ground states would mean a close analogy with both string models and Higgs mechanism. λ_i^2 is very natural candidate for the ground state conformal weights identified but would have wrong sign. Therefore it seems that λ_i^2 can define only a deviation of the ground state conformal weight from negative value and is positive.
4. In accordance with this λ_i^2 would give constant contribution to the ground state conformal weight. What contributes to the thermal mass squared is the deviation of the ground state conformal weight from half-odd integer since the negative integer part of the total conformal weight can be compensated by applying Virasoro generators to the ground state. The first guess motivated by cyclotron energy analogy is that the lowest conformal weights are of form $h_c = -n/2 + \lambda_i^2$ where the negative contribution comes from Super Virasoro representation. The negative integer part of the net conformal weight can be canceled using Super Virasoro generators but Δh_c would give to mass squared a contribution analogous to Higgs contribution. The mapping of the real ground state conformal weight to a p-adic number by canonical identification involves some delicacies.
5. p-Adic mass calculations are consistent with the assumption that Higgs type contribution is vanishing (that is small) for fermions and dominates for gauge bosons. This requires that the deviation of λ_i^2 with smallest magnitude from half-odd integer value in the case of fermions is considerably smaller than in the case of gauge bosons in the scale defined by p-adic mass scale $1/L(k)$ in question. Somehow this difference could relate to the fact that bosons correspond to pairs of wormhole throats.

Is there a connection between p-adic thermodynamics, hierarchy of Planck constants, and infinite primes

The following observations suggest that there might be an intrinsic connection between p-adic thermodynamics, hierarchy of Planck constants, and infinite primes.

1. p-Adic thermodynamics [K48] is based on string mass formula in which mass squared is proportional to conformal weight having values which are integers apart from the contribution of the conformal weight of vacuum which can be non-integer valued. The thermal expectation in p-adic thermodynamics is obtained by replacing the Boltzman weight $\exp(-E/T)$ of ordinary thermodynamics with p-adic conformal weight p^{n/T_p} , where n is the value of conformal weight and $1/T_p = m$ is integer values inverse p-adic temperature. Apart from the ground state contribution and scale factor p-adic mass squared is essentially the expectation value

$$\langle n \rangle = \frac{\sum_n g(n) n p^{\frac{n}{T_p}}}{\sum_n g(n) p^{\frac{n}{T_p}}} . \quad (2.7.22)$$

$g(n)$ denotes the degeneracy of a state with given conformal weight and depends only on the number of tensor factors in the representations of Virasoro or Super-Virasoro algebra. p-Adic mass squared is mapped to its real counterpart by canonical identification $\sum x_n p^n \rightarrow \sum x_n p^{-n}$. The real counterpart of p-adic thermodynamics is obtained by the replacement $p^{-\frac{n}{p}}$ and gives under certain additional assumptions in an excellent accuracy the same results as the p-adic thermodynamics.

2. An intriguing observation is that one could interpret p-adic and real thermodynamics for mass squared also in terms of number theoretic thermodynamics for the number theoretic momentum $\log(p^n) = n \log(p)$. The expectation value for this differs from the expression for $\langle n \rangle$ only by the factor $\log(p)$.
3. In the proposed characterization of the partonic orbits in terms of infinite primes the primes appearing in infinite prime are identified as p-adic primes. For minimal option the p-adic prime characterizes \sqrt{p} - or p - multiple of the minimum length L_{min} of braid strand in the effective metric defined by modified Chern-Simons gamma matrix. One can consider also $(\sqrt{p})^n$ and p^n (p-adic fractality)- and even integer multiples of L_{min} if they are below L_{max} . If light-like 3-surface contains vacuum regions arbitrary large p 's are possible since for these one has $L_{min} \rightarrow \infty$. Number theoretic state function reduction implies that only single p can be realized -one might say "is active"- for a given quantum state. The powers p_i^n appearing in the infinite prime have interpretation as many particle states with total number theoretic momentum $n_i \log(p)_i$. For the finite part of infinite prime one has one fermion and $n_i - 1$ bosons and for the bosonic part n_i bosons. The arithmetic QFT associated with infinite primes - in particular the conservation of the number theoretic momentum $\sum n_i \log(p_i)$ - would naturally describe the correlations between the geometries of light-like 3-surfaces representing the incoming lines of the vertex of generalized Feynman diagram. As a matter fact, the momenta associated with different primes are separately conserved so that one has infinite number of conservation laws.
4. One must assign two infinite primes to given partonic two surface so that one has for a given prime p two integers n_+ and n_- . Also the hierarchy of Planck constants assigns to a given page of the Big Book two integers and one has $\hbar = n_a n_b \hbar_0$. If one has $n_a = n_+$ and $n_b = n_-$ then the reactions in which given initial number theoretic momenta $n_{\pm, i} \log(p_i)$ is shared between final states would have concrete interpretation in terms of the integers n_a, n_b characterizing the coverings of incoming and outgoing lines.

Note that one can also consider the possibility that the hierarchy of Planck constants emerges from the basic quantum TGD. Basically due to the vacuum degeneracy of Kähler action the canonical momentum densities correspond to several values of the time derivatives of the imbedding space coordinates so that for a given partonic 2-surface there are several space-time sheets with same conserved quantities defined by isometry currents and Kähler current. This forces the introduction of N -fold covering of $CD \times CP_2$ in order to describe the situation. The splitting of the partonic 2-surface into N pieces implies a charge fractionization during its travel to the upper end of CD . One can also develop an argument suggesting that the coverings factorize to coverings of CD and CP_2 so that the number of the sheets of the covering is $N = n_a n_b$ [K40].

These observations make one wonder whether there could be a connection between p-adic thermodynamics, hierarchy of Planck constants, and infinite primes.

1. Suppose that one accepts the identification $n_a = n_+$ and $n_b = n_-$. Could one perform a further identification of these integers as non-negative conformal weights characterizing physical states so that conservation of the number theoretic momentum for a given p-adic prime would correspond to the conservation of conformal weight. In p-adic thermodynamics this conformal weight is sum of conformal weights of 5 tensor factors of Super-Virasoro algebra. The number must be indeed five and one could assign them to the factors of the symmetry group. One factor for color symmetries and two factors of electro-weak $SU(2)_L \times U(1)$ are certainly present. The remaining two factors could correspond to transversal degrees of freedom assignable to string like objects but one can imagine also other identifications [K48].
2. If this interpretation is correct, a given conformal weight $n = n_a = n_+$ (say) would correspond to all possible distributions of five conformal weights n_i , $i = 1, \dots, 5$ between the n_a sheets of

covering of CD satisfying $\sum_{i=1}^5 n_i = n_a = n_+$. Single sheet of covering would carry only unit conformal weight so that one would have the analog of fractionization also now and a possible interpretation would be in terms of the instability of states with conformal weight $n > 1$. Conformal thermodynamics would also mean thermodynamics in the space of states determined by infinite primes and in the space of coverings.

3. The conformal weight assignable to the CD would naturally correspond to mass squared but there is also the conformal weight assignable to CP_2 and one can wonder what its interpretation might be. Could it correspond to the expectation of pseudo mass squared characterizing the generalized eigenstates of the modified Dirac operator? Note that one should allow in the spectrum also the powers of hyper-complex primes up to some maximum power $p^{n_{max}/2} \leq L_{max}/L_{min}$ so that Dirac determinant would be non-vanishing and Kähler function finite. From the point of conformal invariance this is indeed natural.

2.8 An attempt to understand preferred extremals of Kähler action

There are pressing motivations for understanding the preferred extremals of Kähler action. For instance, the conformal invariance of string models naturally generalizes to 4-D invariance defined by quantum Yangian of quantum affine algebra (Kac-Moody type algebra) characterized by two complex coordinates and therefore explaining naturally the effective 2-dimensionality [K92]. The problem is however how to assign a complex coordinate with the string world sheet having Minkowskian signature of metric. One can hope that the understanding of preferred extremals could allow to identify two preferred complex coordinates whose existence is also suggested by number theoretical vision giving preferred role for the rational points of partonic 2-surfaces in preferred coordinates. The best one could hope is a general solution of field equations in accordance with the hints that TGD is integrable quantum theory.

A lot is known about properties of preferred extremals and just by trying to integrate all this understanding, one might gain new visions. The problem is that all these arguments are heuristic and rely heavily on physical intuition. The following considerations relate to the space-time regions having Minkowskian signature of the induced metric. The attempt to generalize the construction also to Euclidian regions could be very rewarding. Only a humble attempt to combine various ideas to a more coherent picture is in question.

The core observations and visions are following.

1. Hamilton-Jacobi coordinates for M^4 (discussed in this chapter) define natural preferred coordinates for Minkowskian space-time sheet and might allow to identify string world sheets for X^4 as those for M^4 . Hamilton-Jacobi coordinates consist of light-like coordinate m and its dual defining local 2-plane $M^2 \subset M^4$ and complex transversal complex coordinates (w, \bar{w}) for a plane E_x^2 orthogonal to M_x^2 at each point of M^4 . Clearly, hyper-complex analyticity and complex analyticity are in question.
2. Space-time sheets allow a slicing by string world sheets (partonic 2-surfaces) labelled by partonic 2-surfaces (string world sheets).
3. The quaternionic planes of octonion space containing preferred hyper-complex plane are labelled by CP_2 , which might be called CP_2^{mod} [K81]. The identification $CP_2 = CP_2^{mod}$ motivates the notion of $M^8 - -M^4 \times CP_2$ duality [K23]. It also inspires a concrete solution ansatz assuming the equivalence of two different identifications of the quaternionic tangent space of the space-time sheet and implying that string world sheets can be regarded as strings in the 6-D coset space $G_2/SU(3)$. The group G_2 of octonion automorphisms has already earlier appeared in TGD framework.
4. The duality between partonic 2-surfaces and string world sheets in turn suggests that the $CP_2 = CP_2^{mod}$ conditions reduce to string model for partonic 2-surfaces in $CP_2 = SU(3)/U(2)$. String model in both cases could mean just hypercomplex/complex analyticity for the coordinates of the coset space as functions of hyper-complex/complex coordinate of string world sheet/partonic 2-surface.

The considerations of this section lead to a revival of an old very ambitious and very romantic number theoretic idea.

1. To begin with express octonions in the form $o = q_1 + Iq_2$, where q_i is quaternion and I is an octonionic imaginary unit in the complement of fixed a quaternionic sub-space of octonions. Map preferred coordinates of $H = M^4 \times CP_2$ to octonionic coordinate, form an arbitrary octonion analytic function having expansion with real Taylor or Laurent coefficients to avoid problems due to non-commutativity and non-associativity. Map the outcome to a point of H to get a map $H \rightarrow H$. This procedure is nothing but a generalization of Wick rotation to get an 8-D generalization of analytic map.
2. Identify the preferred extremals of Kähler action as surfaces obtained by requiring the vanishing of the imaginary part of an octonion analytic function. Partonic 2-surfaces and string world sheets would correspond to commutative sub-manifolds of the space-time surface and of imbedding space and would emerge naturally. The ends of braid strands at partonic 2-surface would naturally correspond to the poles of the octonion analytic functions. This would mean a huge generalization of conformal invariance of string models to octonionic conformal invariance and an exact solution of the field equations of TGD and presumably of quantum TGD itself.

2.8.1 Basic ideas about preferred extremals

The slicing of the space-time sheet by partonic 2-surfaces and string world sheets

The basic vision is that space-time sheets are sliced by partonic 2-surfaces and string world sheets. The challenge is to formulate this more precisely at the level of the preferred extremals of Kähler action.

1. Almost topological QFT property means that the Kähler action reduces to Chern-Simons terms assignable to 3-surfaces. This is guaranteed by the vanishing of the Coulomb term in the action density implied automatically if conserved Kähler current is proportional to the instanton current with proportionality coefficient some scalar function.
2. The field equations reduce to the conservation of isometry currents. An attractive ansatz is that the flow lines of these currents define global coordinates. This means that these currents are Beltrami flows [B49] so that corresponding 1-forms J satisfy the condition $J \wedge dJ = 0$. These conditions are satisfied if

$$J = \Phi \nabla \Psi$$

hold true for conserved currents. From this one obtains that Ψ defines global coordinate varying along flow lines of J .

3. A possible interpretation is in terms of local polarization and momentum directions defined by the scalar functions involved and natural additional conditions are that the gradients of Ψ and Φ are orthogonal:

$$\nabla \Phi \cdot \nabla \Psi = 0 \quad ,$$

and that the Ψ satisfies massless d'Alembert equation

$$\nabla^2 \Psi = 0$$

as a consequence of current conservation. If Ψ defines a light-like vector field - in other words

$$\nabla \Psi \cdot \nabla \Psi = 0 \quad ,$$

the light-like dual of Φ -call it Φ_c - defines a light-like like coordinate and Φ and Φ_c defines a light-like plane at each point of space-time sheet.

If also Φ satisfies d'Alembert equation

$$\nabla^2 \Phi = 0 \quad ,$$

also the current

$$K = \Psi \nabla \Phi$$

is conserved and its flow lines define a global coordinate in the polarization plane orthogonal to time-like plane defined by local light-like momentum direction.

If Φ allows a continuation to an analytic function of the transversal complex coordinate, one obtains a coordinatization of spacetime surface by Ψ and its dual (defining hyper-complex coordinate) and w, \bar{w} . Complex analyticity and its hyper-complex variant would allow to provide space-time surface with four coordinates very much analogous with Hamilton-Jacobi coordinates of M^4 .

This would mean a decomposition of the tangent space of space-time surface to orthogonal planes defined by light-like momentum and plane orthogonal to it. If the flow lines of J defined Beltrami flow it seems that the distribution of momentum planes is integrable.

4. General arguments suggest that the space-time sheets allow a slicing by string world sheets parametrized by partonic 2-surfaces or vice versa. This would mean a intimate connection with the mathematics of string models. The two complex coordinates assignable to the Yangian of affine algebra would naturally relate to string world sheets and partonic 2-surfaces and the highly non-trivial challenge is to identify them appropriately.

Hamilton-Jacobi coordinates for M^4

The earlier attempts to construct preferred extremals [K11] led to the realization that so called Hamilton-Jacobi coordinates (m, w) for M^4 define its slicing by string world sheets parametrized by partonic 2-surfaces. m would be pair of light-like conjugate coordinates associated with an integrable distribution of planes M^2 and w would define a complex coordinate for the integrable distribution of 2-planes E^2 orthogonal to M^2 . There is a great temptation to assume that these coordinates define preferred coordinates for M^4 .

1. The slicing is very much analogous to that for space-time sheets and the natural question is how these slicings relate. What is of special interest is that the momentum plane M^2 can be defined by massless momentum. The scaling of this vector does not matter so that these planes are labelled by points z of sphere S^2 telling the direction of the line $M^2 \cap E^3$, when one assigns rest frame and therefore S^2 with the preferred time coordinate defined by the line connecting the tips of CD . This direction vector can be mapped to a twistor consisting of a spinor and its conjugate. The complex scalings of the twistor $(u, \bar{u}) \rightarrow \lambda u, \bar{u}/\lambda$ define the same plane. Projective twistor like entities defining CP_1 having only one complex component instead of three are in question. This complex number defines with certain prerequisites a local coordinate for space-time sheet and together with the complex coordinate of E^2 could serve as a pair of complex coordinates (z, w) for space-time sheet. This brings strongly in mind the two complex coordinates appearing in the expansion of the generators of quantum Yangian of quantum affine algebra [K92].
2. The coordinate Ψ appearing in Beltrami flow defines the light-like vector field defining M^2 distribution. Its hyper-complex conjugate would define Ψ_c and conjugate light-like direction. An attractive possibility is that Φ allows analytic continuation to a holomorphic function of w . In this manner one would have four coordinates for M^4 also for space-time sheet.
3. The general vision is that at each point of space-time surface one can decompose the tangent space to $M^2(x) \subset M^4 = M_x^2 \times E_x^2$ representing momentum plane and polarization plane $E^2 \subset E_x^2 \times T(CP_2)$. The moduli space of planes $E^2 \subset E^6$ is 8-dimensional and parametrized by $SO(6)/SO(2) \times SO(4)$ for a given E_x^2 . How can one achieve this selection and what conditions it must satisfy? Certainly the choice must be integrable but this is not the only condition.

Space-time surfaces as quaternionic surfaces

The idea that number theory determines classical dynamics in terms of associativity condition means that space-time surfaces are in some sense quaternionic surfaces of an octonionic space-time. It took several trials before the recent form of this hypothesis was achieved.

1. Octonionic structure is defined in terms of the octonionic representation of gamma matrices of the imbedding space existing only in dimension $D = 8$ since octonion units are in one-one correspondence with tangent vectors of the tangent space. Octonionic real unit corresponds to a preferred time axes (and rest frame) identified naturally as that connecting the tips of CD . What modified gamma matrices mean depends on variational principle for space-time surface. For volume action one would obtain induced gamma matrices. For Kähler action one obtains something different. In particular, the modified gamma matrices do not define vector basis identical with tangent vector basis of space-time surface.
2. Quaternionicity means that the modified gamma matrices defined as contractions of gamma matrices of H with canonical momentum densities for Kähler action span quaternionic sub-space of the octonionic tangent space [K31]. A further condition is that each quaternionic space defined in this manner contains a preferred hyper-complex subspace of octonions.
3. The sub-space defined by the modified gamma matrices does not co-incide with the tangent space of space-time surface in general so that the interpretation of this condition is far from obvious. The canonical momentum densities need not define four independent vectors at given point. For instance, for massless extremals these densities are proportional to light-like vector so that the situation is degenerate and the space in question reduces to 2-D hyper-complex sub-space since light-like vector defines plane M^2 .

The obvious questions are following.

1. Does the analog of tangent space defined by the octonionic modified gammas contain the local tangent space $M^2 \subset M^4$ for preferred extremals? For massless extremals [K11] this condition would be true. The orthogonal decomposition $T(X^4) = M^2 \oplus_{\perp} E^2$ can be defined at each point if this is true. For massless extremals also the functions Ψ and Φ can be identified.
2. One should answer also the following delicate question. Can M^2 really depend on point x of space-time? CP_2 as a moduli space of quaternionic planes emerges naturally if M^2 is *same* everywhere. It however seems that one should allow an integrable distribution of M_x^2 such that M_x^2 is same for all points of a given partonic 2-surface.

How could one speak about fixed CP_2 (the imbedding space) at the entire space-time sheet even when M_x^2 varies?

- (a) Note first that G_2 defines the Lie group of octonionic automorphisms and G_2 action is needed to change the preferred hyper-octonionic sub-space. Various $SU(3)$ subgroups of G_2 are related by G_2 automorphism. Clearly, one must assign to each point of a string world sheet in the slicing parameterizing the partonic 2-surfaces an element of G_2 . One would have Minkowskian string model with G_2 as a target space. As a matter fact, this string model is defined in the target space $G_2/SU(3)$ having dimension $D = 6$ since $SU(3)$ automorphisms leave given $SU(3)$ invariant.
- (b) This would allow to identify at each point of the string world sheet standard quaternionic basis - say in terms of complexified basis vectors consisting of two hyper-complex units and octonionic unit q_1 with "color isospin" $I_3 = 1/2$ and "color hypercharge" $Y = -1/3$ and its conjugate \bar{q}_1 with opposite color isospin and hypercharge.
- (c) The CP_2 point assigned with the quaternionic basis would correspond to the $SU(3)$ rotation needed to rotate the standard basis to this basis and would actually correspond to the first row of $SU(3)$ rotation matrix. Hyper-complex analyticity is the basic property of the solutions of the field equations representing Minkowskian string world sheets. Also now the same assumption is highly natural. In the case of string models in Minkowski space, the reduction of the induced metric to standard form implies Virasoro conditions and similar conditions are expected also now. There is no need to introduce action principle -just the hyper-complex analyticity is enough-since Kähler action already defines it.

3. The WZW model inspired approach to the situation would be following. The parametrization corresponds to a map $g : X^2 \rightarrow G_2$ for which g defines a flat G_2 connection at string world sheet. WZW type action would give rise to this kind of situation. The transition $G_2 \rightarrow G_2/SU(3)$ would require that one gauges $SU(3)$ degrees of freedom by bringing in $SU(3)$ connection. Similar procedure for $CP_2 = SU(3)/U(2)$ would bring in $SU(3)$ valued chiral field and $U(2)$ gauge field. Instead of introducing these connections one can simply introduce $G_2/SU(3)$ and $SU(3)/U(2)$ valued chiral fields. What this observation suggests that this ansatz indeed predicts gluons and electroweak gauge bosons assignable to string like objects so that the mathematical picture would be consistent with physical intuition.

The two interpretations of CP_2

An old observation very relevant for what I have called $M^8 - H$ duality [K23] is that the moduli space of quaternionic sub-spaces of octonionic space (identifiable as M^8) containing preferred hyper-complex plane is CP_2 . Or equivalently, the space of two planes whose addition extends hyper-complex plane to some quaternionic subspace can be parametrized by CP_2 . This CP_2 can be called it CP_2^{mod} to avoid confusion. In the recent case this would mean that the space $E^2(x) \subset E_x^2 \times T(CP_2)$ is represented by a point of CP_2^{mod} . On the other hand, the imbedding of space-time surface to H defines a point of "real" CP_2 . This gives two different CP_2 s.

1. The highly suggestive idea is that the identification $CP_2^{mod} = CP_2$ (apart from isometry) is crucial for the construction of preferred extremals. Indeed, the projection of the space-time point to CP_2 would fix the local polarization plane completely. This condition for $E^2(x)$ would be purely local and depend on the values of CP_2 coordinates only. Second condition for $E^2(x)$ would involve the gradients of imbedding space coordinates including those of CP_2 coordinates.
2. The conditions that the planes M_x^2 form an integrable distribution at space-like level and that M_x^2 is determined by the modified gamma matrices. The integrability of this distribution for M^4 could imply the integrability for X^2 . X^4 would differ from M^4 only by a deformation in degrees of freedom transversal to the string world sheets defined by the distribution of M^2 s.

Does this mean that one can begin from vacuum extremal with constant values of CP_2 coordinates and makes them non-constant but allows to depend only on transversal degrees of freedom? This condition is too strong even for simplest massless extremals for which CP_2 coordinates depend on transversal coordinates defined by $\epsilon \cdot m$ and $\epsilon \cdot k$. One could however allow dependence of CP_2 coordinates on light-like M^4 coordinate since the modification of the induced metric is light-like so that light-like coordinate remains light-like coordinate in this modification of the metric.

Therefore, if one generalizes directly what is known about massless extremals, the most general dependence of CP_2 points on the light-like coordinates assignable to the distribution of M_x^2 would be dependence on either of the light-like coordinates of Hamilton-Jacobi coordinates but not both.

2.8.2 What could be the construction recipe for the preferred extremals assuming $CP_2 = CP_2^{mod}$ identification?

The crucial condition is that the planes $E^2(x)$ determined by the point of $CP_2 = CP_2^{mod}$ identification and by the tangent space of $E_x^2 \times CP_2$ are same. The challenge is to transform this condition to an explicit form. $CP_2 = CP_2^{mod}$ identification should be general coordinate invariant. This requires that also the representation of E^2 as (e^2, e^3) plane is general coordinate invariant suggesting that the use of preferred CP_2 coordinates -presumably complex Eguchi-Hanson coordinates- could make life easy. Preferred coordinates are also suggested by number theoretical vision. A careful consideration of the situation would be required.

The modified gamma matrices define a quaternionic sub-space analogous to tangent space of X^4 but not in general identical with the tangent space: this would be the case only if the action were 4-volume. I will use the notation $T_x^m(X^4)$ about the modified tangent space and call the vectors of $T_x^m(X^4)$ modified tangent vectors. I hope that this would not cause confusion.

$CP_2 = CP_2^{mod}$ condition

Quaternionic property of the counterpart of $T_x^m(X^4)$ allows an explicit formulation using the tangent vectors of $T_x^m(X^4)$.

1. The unit vector pair (e_2, e_3) should correspond to a unique tangent vector of H defined by the coordinate differentials dh^k in some natural coordinates used. Complex Eguchi-Hanson coordinates [L1] are a natural candidate for CP_2 and require complexified octonionic imaginary units. If octonionic units correspond to the tangent vector basis of H uniquely, this is possible.
2. The pair (e_2, e_3) as also its complexification $(q_1 = e_2 + ie_3, \bar{q}_1 = e_2 - ie_3)$ is expressible as a linear combination of octonionic units I_2, \dots, I_7 should be mapped to a point of $CP_2^{mod} = CP_2$ in canonical manner. This mapping is what should be expressed explicitly. One should express given (e_2, e_3) in terms of $SU(3)$ rotation applied to a standard vector. After that one should define the corresponding CP_2 point by the bundle projection $SU(3) \rightarrow CP_2$.
3. The tangent vector pair

$$(\partial_w h^k, \partial_{\bar{w}} h^k)$$

defines second representation of the tangent space of $E^2(x)$. This pair should be equivalent with the pair (q_1, \bar{q}_1) . Here one must be however very cautious with the choice of coordinates. If the choice of w is unique apart from constant the gradients should be unique. One can use also real coordinates (x, y) instead of $(w = x + iy, \bar{w} = x - iy)$ and the pair (e_2, e_3) . One can project the tangent vector pair to the standard vielbein basis which must correspond to the octonionic basis

$$(\partial_x h^k, \partial_y h^k) \rightarrow (\partial_x h^k e_k^A e_A, \partial_y h^k e_k^A e_A) \leftrightarrow (e_2, e_3) ,$$

where the e_A denote the octonion units in 1-1 correspondence with vielbein vectors. This expression can be compared to the expression of (e_2, e_3) derived from the knowledge of CP_2 projection.

Formulation of quaternionicity condition in terms of octonionic structure constants

One can consider also a formulation of the quaternionic tangent planes in terms of (e_2, e_3) expressed in terms of octonionic units deducible from the condition that unit vectors obey quaternionic algebra. The expressions for octonionic *resp.* quaternionic structure constants can be found at [A21] *resp.* [A25].

1. The ansatz is

$$\begin{aligned} \{E_k\} &= \{1, I_1, E_2, E_3\} , \\ E_2 &= E_{2k} e^k \equiv \sum_{k=2}^7 E_{2k} e^k , \quad E_3 = E_{3k} e^k \equiv \sum_{k=2}^7 E_{3k} e^k , \\ |E_2| &= 1 , \quad |E_3| = 1 . \end{aligned} \tag{2.8.1}$$

2. The multiplication table for octonionic units expressible in terms of octonionic triangle [A21] gives

$$f^{1kl} E_{2k} = E_{3l} , \quad f^{1kl} E_{3k} = -E_{2l} , \quad f^{klr} E_{2k} E_{3l} = \delta_1^r . \tag{2.8.2}$$

Here the indices are raised by unit metric so that there is no difference between lower and upper indices. Summation convention is assumed. Also the contribution of the real unit is present in the structure constants of third equation but this contribution must vanish.

3. The conditions are linear and quadratic in the coefficients E_{2k} and E_{3k} and are expected to allow an explicit solution. The first two conditions define homogenous equations which must allow solution. The coefficient matrix acting on (E_2, E_3) is of the form

$$\begin{pmatrix} f_1 & 1 \\ -1 & f_1 \end{pmatrix} ,$$

where 1 denotes unit matrix. The vanishing of the determinant of this matrix should be due to the highly symmetric properties of the structure constants. In fact the equations can be written as eigen conditions

$$f_1 \circ (E_2 \pm iE_3) = \mp i(E_2 \pm iE_3) ,$$

and one can say that the structure constants are eigenstates of the hermitian operator defined by I_1 analogous to color hyper charge. Both values of color hyper charged are obtained.

Explicit expression for the $CP_2 = CP_2^{mod}$ conditions

The symmetry under $SU(3)$ allows to construct the solutions of the above equations directly.

1. One can introduce complexified basis of octonion units transforming like $(1, 1, 3, \bar{3})$ under $SU(3)$. Note the analogy of triplet with color triplet of quarks. One can write complexified basis as $(1, e_1, (q_1, q_2, q_3), (\bar{q}_1, \bar{q}_2, \bar{q}_3))$. The expressions for complexified basis elements are

$$(q_1, q_2, q_3) = \frac{1}{\sqrt{2}}(e_2 + ie_3, e_4 + ie_5, e_6 + ie_7) .$$

These options can be seen to be possible by studying octonionic triangle in which all lines containing 3 units defined associative triple: any pair of octonion units at this kind of fine can be used to form pair of complexified unit and its conjugate. In the tangent space of $M^4 \times CP_2$ the basis vectors q_1 , and q_2 are mixtures of E_x^2 and CP_2 tangent vectors. q_3 involves only CP_2 tangent vectors and there is a temptation to interpret it as the analog of the quark having no color isospin.

2. The quaternionic basis is real and must transform like $(1, 1, q_1, \bar{q}_1)$, where q_1 is any quark in the triplet and \bar{q}_1 its conjugate in antitriplet. Having fixed some basis one can perform $SU(3)$ rotations to get a new basis. The action of the rotation is by 3×3 special unitary matrix. The over all phases of its rows do not matter since they induce only a rotation in (e_2, e_3) plane not affecting the plane itself. The action of $SU(3)$ on q_1 is simply the action of its first row on (q_1, q_2, q_3) triplet:

$$\begin{aligned} q_1 &\rightarrow (Uq)_1 = U_{11}q_1 + U_{12}q_2 + U_{13}q_3 \equiv z_1q_1 + z_2q_2 + z_3q_3 \\ &= z_1(e_2 + ie_3) + z_2(e_4 + ie_5) + z_3(e_6 + ie_7) . \end{aligned} \quad (2.8.3)$$

The triplets (z_1, z_2, z_3) defining a complex unit vector and point of S^5 . Since overall phase does not matter a point of CP_2 is in question. The new real octonion units are given by the formulas

$$\begin{aligned} e_2 &\rightarrow Re(z_1)e_2 + Re(z_2)e_4 + Re(z_3)e_6 - Im(z_1)e_3 - Im(z_2)e_5 - Im(z_3)e_7 , \\ e_3 &\rightarrow Im(z_1)e_2 + Im(z_2)e_4 + Im(z_3)e_6 + Re(z_1)e_3 + Re(z_2)e_5 + Re(z_3)e_7 . \end{aligned} \quad (2.8.4)$$

For instance the CP_2 coordinates corresponding to the coordinate patch (z_1, z_2, z_3) with $z_3 \neq 0$ are obtained as $(\xi_1, \xi_2) = (z_1/z_3, z_2/z_3)$.

Using these expressions the equations expressing the conjecture $CP_2 = CP_2^{mod}$ equivalence can be expressed explicitly as first order differential equations. The conditions state the equivalence

$$(e_2, e_3) \leftrightarrow (\partial_x h^k e_k^A e_A, \partial_y h^k e_k^A e_A) , \quad (2.8.5)$$

where e_A denote octonion units. The comparison of two pairs of vectors requires normalization of the tangent vectors on the right hand side to unit vectors so that one takes unit vector in the direction of the tangent vector. After this the vectors can be equated. This allows to express the contractions of the partial derivatives with vielbein vectors with the 6 components of e_2 and e_3 . Each condition gives 6+6 first order partial differential equations which are non-linear by the presence of the overall normalization factor for the right hand side. The equations are invariant under scalings of (x, y) . The very special form of these equations suggests that some symmetry is involved.

It must be emphasized that these equations make sense only in preferred coordinates: ordinary Minkowski coordinates and Hamiltonin-Jacobi coordinates for M^4 and Eguchi-Hanson complex coordinates in which $SU(2) \times U(1)$ is represented linearly for CP_2 . These coordinates are preferred because they carry deep physical meaning.

Does TGD boil down to two string models?

It is good to look what have we obtained. Besides Hamilton-Jacobi conditions, and $CP_2 = CP_2^{mod}$ conditions one has what one might call string model with 6-dimensional $G_2/SU(3)$ as target space. The orbit of string in $G_2/SU(3)$ allows to deduce the G_2 rotation identifiable as a point of $G_2/SU(3)$ defining what one means with standard quaternionic plane at given point of string world sheet. The hypothesis is that hyper-complex analyticity solves these equations.

The conjectured electric-magnetic duality implies duality between string world sheet and partonic 2-surfaces central for the proposed mathematical applications of TGD [K41, K42, K79, K93]. This duality suggests that the solutions to the $CP_2 = CP_2^{mod}$ conditions could reduce to holomorphy with respect to the coordinate w for partonic 2-surface plus the analogs of Virasoro conditions. The dependence on light-like coordinate would appear as a parametric dependence.

If this were the case, TGD would reduce at least partially to what might be regarded as dual string models in $G_2/SU(3)$ and $SU(3)/U(2)$ and also to string model in M^4 and X^4 ! In the previous arguments one ends up to string models in moduli spaces of string world sheets and partonic 2-surfaces. TGD seems to yield an inflation of string models! This not actually surprising since the slicing of space-time sheets by string world sheets and partonic 2-surfaces implies automatically various kinds of maps having interpretation in terms of string orbits.

2.8.3 Could octonion analyticity solve the field equations?

The interesting question is what happens in the space-time regions with Euclidian signature of induced metric. In this case it is not possible to introduce light-like plane at each point of the space-time sheet. Nothing however prevents from applying the above described procedure to construct conserved currents whose flow lines define global coordinates. In both cases analytic continuation allows to extend the coordinates to complex coordinates. Therefore one would have two complex functions satisfying Laplace equation and having orthogonal gradients.

1. When CP_2 projection is 4-dimensional, there is strong temptation to assume that these functions could be reduced to complex CP_2 coordinates analogous to the Hamilton-Jacobi coordinates for M^4 . Complex Eguchi-Hanson coordinates transforming linearly under $U(2) \subset SU(3)$ define the simplest candidates in this respect. Laplace-equations are satisfied automatically since holomorphic functions are in question. The gradients are also orthogonal automatically since the metric is Kähler metric. Note however that one could argue that in inner product the conjugate of the function appears. Any holomorphic map defines new coordinates of this kind. Note that the maps need not be globally holomorphic since CP_2 projection of space-time sheet need not cover the entire CP_2 .
2. For string like objects $X^4 = X^2 \times Y^2 \subset M^4 \times CP_2$ with Minkowskian signature of the metric the coordinate pair would be hyper-complex coordinate in M^4 and complex coordinate in CP_2 .

If X^2 has Euclidian signature of induced metric the coordinate in question would be complex coordinate. The proposal in the case of CP_2 allows all holomorphic functions of the complex coordinates.

There is an objection against this construction. There should be a symmetry between M^4 and CP_2 but this is not the case. Therefore this picture cannot be quite correct.

Could the construction of new preferred coordinates by holomorphic maps generalize as electric-magnetic duality suggests? One can imagine several options, which bring in mind old ideas that what I have christened as "romantic stuff" [K81].

1. Should one generalize the holomorphic map to a quaternion analytic map with real Taylor coefficients so that non-commutativity would not produce problems. One would map first M^4 coordinates to quaternions, map these coordinates to new ones by quaternion analytic map defined by a Taylor or even Laurnte expansion with real coefficients, and then map the resulting quaternion valued coordinate back to hyper-quaternion defining four coordinates as fuctions in M^4 . This procedure would be very much analogous to Wick rotation used in quantum field theories. Similar quaternion analytic map be applied also in CP_2 degrees of freedom followed by the map of the quaternion to two complex numbers. This would give additional constraints on the map. This option could be seen as a quaternionic generalization of conformal invariance.

The problem is that one decouples M^4 and CP_2 degrees of freedom completely. These degrees are however coupled in the proposed construction since the $E^2(x)$ corresponds to subspace of $E_x^2 \times T(CP_2)$. Something goes still wrong.

2. This motivates to imagine even more ambitious and even more romantic option realizing the original idea about octonionic generalization of conformal invariance. Assume linear $M^4 \times CP_2$ coordinates (Eguchi-Hanson coordinates transforming linearly under $U(2)$ in the case of CP_2). Map these to octonionic coordinate h . Map the octonionic coordinate to itself by an octonionic analytic map defined by Taylor or even Laurent series with real coefficients so that non-commutativity and non-associativity do not cause troubles. Map the resulting octonion valued coordinates back to ordinary H -coordinates and expressible as functions of original coordinates.

It must be emphasized that this would be nothing but a generalization of Wick rotation and its inverse used routinely in quantum field theories in order to define loop integrals.

Could octonion real-analyticity make sense?

Suppose that one -for a fleeting moment- takes octonionic analyticity seriously. For space-time surfaces themselves one should have in some sense quaternionic variant of conformal invariance. What does this mean?

1. Could one regard space-time surfaces analogous to the curves at which the imaginary part of analytic function of complex argument vanishes so that complex analyticity reduces to real analyticity. One can indeed divide octonion to quaternion and its imaginary part to give $o = q_1 + Iq_2$: q_1 and q_2 are quaternionis and I is octonionic imaginary unit in the complement of the quaternionic sub-space. This decomposition actually appears in the standard construction of octonions. Therefore 4-dimensional surfaces at which the imaginary part of octonion valued function vanishes make sense and defined in well-defined sense quaternionic 4-surfaces.

This kind of definition would be in nice accord with the vision about physics as algebraic geometry. Now the algebraic geometry would be extended from complex realm to the octonionic realm since quaternionic surfaces/string world sheets could be regarded as associative/commutative sub-algebras of the algebra of the octonionic real-analytic functions.

2. Could these surfaces correspond to quaternionic 4-surfaces defined in terms of the modified gamma matrices or induced gamma matrices? Contrary to the original expectations it will be found that only induced gamma matrices is a plausible option. This would be an enormous simplification and would mean that the theory is exactly solvable in the same sense as string models are: complex analyticity would be replaced with octonion analyticity. I have considered this option in several variants using the notion of real octonion analyticity [K81] but have not managed to build any satisfactory scenario.

3. Hyper-complex and complex conformal symmetries would result by a restriction to hyper-complex *resp.* complex sub-manifolds of the imbedding space defined by string world sheets *resp.* partonic 2-surfaces. The principle forcing this restriction would be commutativity. Yangian of an affine algebra would unify these views to single coherent view [K92].

4-D n-point functions of the theory should result from the restriction on partonic 2-surfaces or string world sheets with arguments of n-point functions identified as the ends of braid strands so that a kind of analytic continuation from 2-D to the 4-D case would be in question. The octonionic conformal invariance would be induced by the ordinary conformal invariance in accordance with strong form of General Coordinate Invariance.

4. This algebraic continuation of the ordinary conformal invariance could help to construct also the representations of Yangians of affine Kac-Moody type algebras. For the Yangian symmetry of 1+1 D integrable QFTs the charges are multilocal involving multiple integrals over ordered multiple points of 1-D space. I

In the recent case multiple 1-D space is replaced with a space-like 3-surface at the light-like end of CD . The point of the 1-D space appearing in the multiple integral are replaced by a partonic 2-surface represented by a collection of punctures. There is a strong temptation to assume that the intermediate points on the line correspond to genuine physical particles and therefore to partonic 2-surfaces at which the signature of the induced metric changes. If so, the 1-D space would correspond to a closed curve connecting punctures of different partonic 2-surfaces representing physical particles and ordered along a loop. The integral over multiple points would correspond to an integral over WCW rather than over fixed back-ground space-time.

1-D space would be replaced with a closed curve going through punctures of a subset of partonic 2-surfaces associated with a space-like 3-surface. If a given partonic surface or a given puncture can contribute only once to the multiple integral the multi-locality is bounded from above and only a finite number of Yangian generators are obtained in this manner unless one allows the number of partonic 2-surfaces and of punctures for them to vary. This variation is physically natural and would correspond to generation of particle pairs by vacuum polarization. Although only punctures would contribute, the Yangian charges would be defined in WCW rather than in fixed space-time. Integral over positions of punctures and possible numbers of them would be actually an integral over WCW. 2-D modular invariance of Yangian charges for the partonic 2-surfaces is a natural constraint.

The question is whether some conformal fields at the punctures of the partonic 2-surfaces appearing in the multiple integral define the basic building bricks of the conserved quantum charges representing the multilocal generators of the Yangian algebra? Note that Wick rotation would be involved.

What Wick rotation could mean?

Second definition of quaternionicity is on more shaky basis and motivated by the solutions of 2-D Laplace equation: quaternionic space-time surfaces would be obtained as zero loci of octonion real-analytic functions. Unfortunately octonion real-analyticity does not make sense in Minkowskian signature.

One could understand octonion real-analyticity in Minkowskian signature if one could understand the deeper meaning of Wick rotation. Octonion real analyticity formulated as a condition for the vanishing of the imaginary part of octonion real-analytic function makes sense for in octonionic coordinates for $E^4 \times CP_2$ with Euclidian signature of metric. $M^4 \times CP_2$ is however only a subspace of complexified octonions and not closed with respect to multiplication so that octonion real-analytic functions do not make sense in $M^4 \times CP_2$. Wick rotation should transform the solution candidate defined by an octonion real-analytic function to that defined in $M^4 \times CP_2$. A natural additional condition is that Wick rotation should reduce to that taking $M^2 \subset M^4$ to $E^2 \subset E^4$.

The following trivial observation made in the construction of Hamilton-Jacobi structure in M^4 with Minkowskian signature of the induced metric (see the appendix of [K94]) as a Wick rotation of Hermitian structure in E^4 might help here.

1. The components of the metric of E^2 in complex coordinates (z, \bar{z}) for E^2 are given by $g_{u\bar{v}} = -1$ whereas the metric of M^2 in light-like coordinates $(u = x+t, v = x-t)$ is given by $g_{uv} = -1$. The

metric is same and M^2 and E^2 correspond only to different interpretations for the coordinates! One could say that $M^4 \times CP_2$ and $E^4 \times CP_2$ have same metric tensor, Kähler structure, and spinor structure. Since only these appear in field equations, one could hope that the solutions of field equations in $M^4 \times CP_2$ and $E^4 \times CP_2$ are obtained by Wick rotation. This for preferred extremals at least and if the field equations reduce to purely algebraic ones.

2. If one accepts the proposed construction of preferred extremals of Kähler action discussed in [K94], the field equations indeed reduce to purely algebraic conditions satisfied if space-time surface possesses Hermitian structure in the case of Euclidian signature of the induced metric and Hamilton-Jacobi structure in the case of Minkowskian signature. Just as in the case of minimal surfaces, energy momentum tensor and second fundamental form have no common non-vanishing components. The algebraization requires as a consistency condition Einstein's equations with a cosmological term. Gravitational constant and cosmological constant follow as predictions.
3. If Wick rotation in the replacement of E^2 coordinates (z, \bar{z}) with M^2 coordinates (u, v) makes sense, one can hope that field equations for the preferred extremals hold true also for a Wick rotated surfaces obtained by mapping $M^2 \subset M^4$ to $E^2 \subset E^4$. Also Einstein's equations should be satisfied by the Wick rotated metric with Euclidian signature.
4. Wick rotation makes sense also for the surfaces defined by the vanishing of the imaginary part (complementary to quaternionic part) of octonion real-analytic function. Therefore one can hope that this ansatz could work. Wick rotation is non-trivial geometrically. For instance, light-like lines $v = 0$ of hyper-complex plane M^2 are taken to $\bar{z} = 0$ defining a point of complex plane E^2 . Note that non-invertible hyper-complex numbers correspond to the two light-like lines $u = 0$ and $v = 0$ whereas non-invertible complex numbers correspond to the origin of E^2 .
5. If the conjecture holds true, one can apply to both factors in $E^4 = E^2 \times E^2$ and to get preferred extremals in $M^{2,2} \times CP_2$. Minkowski space $M^{2,2}$ is essential in twistor approach and the possibility to carry out Wick rotation for preferred extremals could justify Wick rotation in quantum theory.

What the non-triviality of the moduli space of the octonionic structures means?

The moduli space G_2 of the octonionic structures is essentially the Galois group defined as maps of octonions to itself respecting octonionic sum and multiplication. This raises the question whether octonion analyticity should be generalized in such a manner that the global choice of the octonionic imaginary units - in particular that of preferred commuting complex sub-space- would become local. Physically this would correspond to the choice of momentum plane M_x^2 for a position dependent light-like momentum defining the plane of non-physical polarizations.

This question is inspired by the general solution ansatz based on the slicing of space-time sheets which involves the dependence of the choice of the momentum plane M_x^2 on the point of string world sheet. This dependence is parameterized by a point of $G_2/SU(3)$ and assumed to be constant along partonic 2-surfaces. These slicings would be naturally associated with the two complex parts c_i of the quaternionic coordinate $q_1 = c_1 + Ic_2$ of the space-time sheet.

This dependence is well-defined only for the quaternionic 4-surface defining the space-time surface and can be seen as a local choice of a preferred complex imaginary unit along string world sheets. CP_2 would parametrize the remaining geometric degrees of freedom. Should/could one extend this dependence to entire 8-D imbedding space? This is possible if the 8-D imbedding space allows a slicing by the string world sheets. If the string world sheets correspond to the string world sheets appearing in the slicing of M^4 defined by Hamilton-Jacobi coordinates [K11], this slicing indeed exists.

Zero energy ontology and octonion analyticity

How does this picture relate to zero energy ontology and how partonic 2-surfaces and string world sheets could be identified in this framework?

1. The intersection of the quaternionic four-surfaces with the 7-D light-like boundaries of CDs is 3-D space-like surface. String world sheets are obtained as 2-D complex surfaces by putting $c_2 = 0$,

where c_2 is the imaginary part of the quaternion coordinate $q = c_1 + Ic_2$. Their intersections with CD boundaries are generally 1-dimensional and represent space-like strings.

2. Partonic 2-surfaces could correspond to the intersections of $Re(c_1) = constant$ 3-surfaces with the boundaries of CD . The variation of $Re(c_1)$ would give a family of (possibly light-like) 3-surfaces whose intersection with the boundaries of CD would be 2-dimensional. The interpretation $Re(c_1) = constant$ surfaces as (possibly light-like) orbits of partonic 2-surfaces would be natural. Wormhole throats at which the signature of the induced metric changes (by definition) would correspond to some special value of $Re(c_1)$, naturally $Re(c_1) = 0$.

What comes first in mind is that partonic 2-surfaces assignable to wormhole throats correspond to co-complex 2-surfaces obtained by putting $c_1 = 0$ (or $c_1 = constant$) in the decomposition $q = c_1 + ic_2$. This option is consistent with the above assumption if $Im(c_1) = 0$ holds true at the boundaries of CD . Note that also co-quaternionic surfaces make sense and would have Euclidian signature of the induced metric: the interpretation as counterparts of lines of generalized Feynman graphs might make sense.

3. One can of course wonder whether also the poles of c_1 might be relevant. The most natural idea is that the value of $Re(c_1)$ varies between 0 and ∞ between the ends of the orbit of partonic 2-surface. This would mean that c_1 has a pole at the other end of CD (or light-like orbit of partonic 2-surface). In light of this the earlier proposal [K79] that zero energy states might correspond to rational functions assignable to infinite primes and that the zeros/poles of these functions correspond to the positive/negative energy part of the state is interesting.

The intersections of string world sheets and partonic 2-surfaces identifiable as the common ends of space-like and time like brand strands would correspond to the points $q = c_1 + Ic_2 = 0$ and $q = \infty + Ic_2$, where ∞ means real infinity. In other words, to the zeros and real poles of quaternion analytic function with real coefficients. In the number theoretic vision especially interesting situations correspond to polynomials with rational number valued coefficients and rational functions formed from these. In this kind of situations the number of zeros and therefore of braid strands is always finite.

Do induced or modified gamma matrices define quaternionicity?

There are two options to be considered: either induced or modified gamma matrices define quaternionicity.

1. There are several arguments supporting this view that induced gamma matrices define quaternionicity and that quaternionic planes are therefore tangent planes for space-time sheet.
 - (a) $H - M^8$ correspondence is based on the observation that quaternionic sub-spaces of octonions containing preferred complex sub-space are labelled by points of CP_2 . The integrability of the distribution of quaternionic spaces could follow from the parametrization by points of CP_2 ($CP_2 = CP_{mod}$ condition). Quaternionic planes would be necessarily tangent planes of space-time surface. Induced gamma matrices correspond naturally to the tangent space vectors of the space-time surface.

Here one should however understand the role of the M^4 coordinates. What is the functional form of M^4 coordinates as functions of space-time coordinates or does this matter at all (general coordinate invariance): could one choose the space-time coordinates as M^4 coordinates for surfaces representable as graphs for maps $M^4 \rightarrow CP_2$? What about other cases such as cosmic strings [K24]?
 - (b) Could one do entirely without gamma matrices and speak only about induced octonion structure in 8-D tangent space (raising also dimension $D = 8$ to preferred role) with reduces to quaternionic structure for quaternionic 4-surfaces. The interpretation of quaternionic plane as tangent space would be unavoidable also now. In this approach there would be no question about whether one should identify octonionic gamma matrices as induced gamma matrices or as modified octonionic gamma matrices.
 - (c) If quaternion analyticity is defined in terms of modified gamma matrices defined by the volume action why it would solve the field equations for Kähler action rather than for

minimal surfaces? Is the reason that quaternionic and octonionic analyticities defined as generalized differentiability are not possible. The real and imaginary parts of quaternionic real-analytic function with quaternion interpreted as bi-complex number are not analytic functions of two complex variables of either complex variable. In 4-D situation minimal surface property would be too strong a condition whereas Kähler action poses much weaker conditions. Octonionic real-analyticity however poses strong symmetries and suggests effective 2-dimensionality.

2. The following argument suggest that modified gamma matrices cannot define the notion of quaternionic plane.
 - (a) Modified gamma matrices can define sub-spaces of lower dimensionality so that they do not defined a 4-plane. In this case they cannot define CP_2 point so that $CP_2 = CP_2^{mod}$ identity fails. Massless extremals represents the basic example about this. Hydrodynamic solutions defined in terms of Beltrami flows could represent a more general phase of this kind.
 - (b) Modified gamma matrices are not in general parallel to the space-time surface. The CP_2 part of field equations coming from the variation of Kähler form gives the non-tangential contribution. If the distribution of the quaternionic planes is integrable it defines another space-time surface and this looks rather strange.
 - (c) Integrable quaternionicity can mean only tangent space quaternionicity. For modified gamma matrices this cannot be the case. One cannot assign to the octonion analytic map modified gamma matrices in any natural manner.

The conclusion seems to be that induced gamma matrices or induced octonion structure must define quaternionicity and quaternionic planes are tangent planes of space-time surface and therefore define an integrable distribution. An open question is whether $CP_2 = CP_2^{mod}$ condition implies the integrability automatically.

Volume action or Kähler action?

What seems clear is that quaternionicity must be defined by the induced gamma matrices obtained as contractions of canonical momentum densities associated with volume action with imbedding space gamma matrices. Probably equivalent definition is in terms of induced octonion structure. For the believer in strings this would suggest that the volume action is the correct choice. There are however strong objections against this choice.

1. In 2-dimensional case the minimal surfaces allow conformal invariance and one can speak of complex structure in their tangent space. In particular, string world sheets can be regarded as complex 2-surfaces of quaternionic space-time surfaces. In 4-dimensional case the situation is different since quaternionic differentiability fails by non-commutativity. It is quite possible that only very few minimal surfaces (volume action) are quaternionic.
2. The possibility of Beltrami flows is a rather plausible property of quite many preferred extremals of Kähler action. Beltrami flows are also possible for a 4-D minimal surface action. In particular, M^4 translations would define Beltrami flows for which the 1-forms would be gradients of linear M^4 coordinates. If M^4 coordinate can be used on obtains flows in directions of all coordinate axes. Hydrodynamical picture in the strong form therefore fails whereas for Kähler action various isometry currents could be parallel (as they are for massless extremals).
3. For volume action topological QFT property fails as also fails the decomposition of solutions to massless quanta in Minkowskian regions. The same applies to criticality. The crucial vacuum degeneracy responsible for most nice features of Kähler action is absent and also the effective 2-dimensionality and almost topological QFT property are lost since the action does not reduce to 3-D term.

One can however keep Kähler action and define quaternionicity in terms of induced gamma matrices or induced octonion structure. Preferred extremals could be identified as extremals of Kähler action which are also quaternionic 4-surfaces.

1. Preferred extremal property for Kähler action could be much weaker condition than minimal surface property so that much larger set of quaternionic space-time surfaces would be extremals of the Kähler action than of volume action. The reason would be that the rank of energy momentum tensor for Maxwell action tends to be smaller than maximal. This expectation is supported by the vacuum degeneracy, the properties of massless extremals and of CP_2 type vacuum extremals, and by the general hydrodynamical picture.
2. There is also a long list of beautiful properties supporting Kähler action which should be also familiar: effective 2-dimensionality and slicing of space-time surface by string world sheets and partonic 2-surfaces, reduction to almost topological QFT and to abelian Chern-Simons term, weak form of electric-magnetic duality, quantum criticality, spin glass degeneracy, etc...

Are quaternionicities defined in terms of induced gamma matrices *resp.* octonion real-analytic maps equivalent?

Quaternionicity could be defined by induced gamma matrices or in terms of octonion real-analytic maps. Are these two definitions equivalent and how could one test the equivalence?

1. The calculation technical problem is that space-time surfaces are not defined in terms of imbedding map involving some coordinate choice but in terms of four vanishing conditions for the imaginary part of the octonion real-analytic function expressible as biquaternion valued functions.
2. Integrability to 4-D surface is achieved if there exists a 4-D closed Lie algebra defined by vector fields identifiable as tangent vector fields. This Lie algebra can be generalized to a local 4-D Lie algebra. One cannot however represent octonionic units in terms of 8-D vector fields since the commutators of the latter do not form an associative algebra. Also the representation of 7 octonionic imaginary units as 8-D vector fields is impossible since the algebra in question is non-associative Malcev algebra [A17] which can be seen as a Lie algebra over non-associative number field (one speaks of 7-dimensional cross product [A30]). One must use instead of vector fields either octonionic units as such or octonionic gamma "matrices" to represent tangent vectors. The use of octonionic units as such would mean the introduction of the notion of octonionic tangent space structure. That the subalgebra generated by any two octonionic units is associative brings strongly in mind effective 2-dimensionality.
3. The tangent vector fields of space-time surface in the representation using octonionic units can be identified in the following manner. Map can be defined using 8-D octonionic coordinates defined by standard M^4 coordinates or possibly Hamilton-Jacobi coordinates and CP_2 complex coordinates for which $U(2)$ is represented linearly. Gamma "matrices" for H using octonionic representation are known in these coordinates. One can introduce the 8 components of the image of a given point under the octonion real-analytic map as new imbedding space coordinates. One can calculate the covariant gamma matrices of H in these coordinates.

What should check whether the octonionic gamma matrices associated with the four non-vanishing coordinates define quaternionic (and thus associative) algebra in the octonionic basis for the gamma matrices. Also the interpretation as a associative subspace of local Malcev algebra elements is possible and one should check whether if the algebra reduces to a quaternionic Lie-algebra. Local $SO(2) \times U(1)$ algebra should emerge in this manner.

4. Can one identify quaternionic imaginary units with vector fields generating $SO(3)$ Lie algebra or its local variant? The Lie algebra of rotation generators defines algebra equivalent with that based on commutars of quaternionic units. Could the slicing of space-time sheet by time axis define local $SO(3)$ algebra? Light-like momentum direction and momentum direction and its dual define as their sum space-like vector field and together with vector fields defining transversal momentum directions they might generate a local $SO(3)$ algebra.

Questions related to quaternion real-analyticity

There are many poorly understood issues and the following questions represent only some of very many such questions picked up rather randomly.

1. The above considerations are restricted to Minkowskian regions of space-time sheets. What happens in the Euclidian regions? Does the existence of light-like Beltrami field and its dual generalize to the existence of complex vector field and its dual?
2. It would be nice to find a justification for the notion of CD from basic principles. The condition $q\bar{q} = 0$ implies $q = 0$ for quaternions. For hyper-quaternionic subspace of complexified quaternions obtained by Wick rotation it implies $q\bar{q} = 0$ corresponds the entire light-cone boundary. If n-point functions can be identified as products of quaternion valued n-point functions and their quaternionic conjugates, the outcome could be proportional to $1/q\bar{q}$ having poles at light-cone boundaries or CD boundaries rather than at single point as in Euclidian realm.
3. This correspondence of points and light-cone boundaries would effectively identify the points at future and past light-like boundaries of CD along light rays. Could one think that only the 2-sphere at which the upper and lower light-like boundaries of CD meet remains after this identification. The structure would be homologically very much like CP_2 which is obtained by compactifying E^4 by adding a 2-sphere at infinity. Could this $CD - CP_2$ correspondence have some deep physical meaning? Do the boundaries of CD somehow correspond to zeros and/or poles of quaternionic analytic functions in the Minkowskian realm? Could the light-like orbits of partonic 2-surfaces at which the signature of the induced metric changes correspond to similar counterparts of zeros or poles when the quaternion analytic variables is obtained as quaternion real analytic function of H coordinates regarded as bi-quaternions?
4. Could braids correspond to zeros and poles of an octonion real-analytic function? Consider the partonic 2-surfaces at which the signature of the induced metric changes. The intersections of these surfaces with string world sheets at the ends of CD s. contain only complex and thus commutative points meaning that the imaginary part of bi-complex number representing quaternionic value of octonion real-analytic function vanishes. Braid ends would thus correspond to the origins of local complex coordinate patches. Finite measurement resolution would be forced by commutativity condition and correlate directly with the complexity of the partonic 2-surface measured by the minimal number of coordinate patches. Its realization would be as an upper bound on the number of braid strands. A natural expectation would be that only the values of n-point functions at these points contribute to scattering amplitudes. Number theoretic braids would be realized but in a manner different from the original guess.

How complex analysis could generalize?

One can make several questions related to the possible generalization of complex analysis to the quaternionic and octonionic situation.

1. Does the notion of analyticity in the sense that derivatives df/dq and df/do make sense hold true? The answer is "No": non-commutativity destroys all hopes about this kind of generalization. Octonion and quaternion real-analyticity has however a well-defined meaning.
2. Could the generalization of residue calculus by keeping interaction contours as 1-D curves make sense? Since residue formulas is the outcome of the fact that any analytic function g can be written as $g = df/dz$ locally, the answer is "No".
3. Could one generalize of the residue calculus by replacing 1-dimensional curves with 4-D surfaces -possibly quaternionic 4-surfaces? Could one reduce the 4-D integral of quaternion analytic function to a double residue integral? This would be the case if the quaternion real-analytic function of $q = c_1 + Ic_2$ could be regarded as an analytic function of complex arguments c_1 and c_2 . This is not the case. The product of two octonions decomposed to two quaternions as $o_i = q_{i1} + Iq_{i2}$, $i = a, b$ reads as

$$o_a o_b = q_{a1} q_{b1} - \bar{q}_{a2} q_{b2} + I(\bar{q}_{a1} q_{b2} - q_{a2} q_{b1}) . \quad (2.8.6)$$

The conjugations result from the anticommutativity of imaginary parts and I . This formula gives similar formula for quaternions by restriction. As a special cas $o_a = o_b = q_1 + Iq_2$ one has

$$o^2 = q_1^2 - \bar{q}_2 q_2 + I(\bar{q}_1 q_2 - q_2 q_1)$$

From this it is clear that the real part of an octonion real-analytic function cannot be regarded as quaternion-analytic function unless one assumes that the imaginary part q_2 vanishes. By similar argument real part of quaternion real-analytic function $q = c_1 + Ic_2$ fails to be analytic unless one restricts the consideration to a surface at which one has $c_2 = 0$. These negative results are obviously consistent with the effective 2-dimensionality.

4. One must however notice that physicists use often what might be called analytization trick [A1] working if the non-analytic function $f(x, y) = f(z, \bar{z})$ is differentiable. The trick is to interpret z and \bar{z} as independent variables. In the recent case this is rather natural. Wick rotation could be used to transform the integral over the space-time sheet to integral in quaternionic domain. For 4-dimensional integrals of quaternion real-analytic function with integration measure proportional to $dc_1 d\bar{c}_1 dc_2 d\bar{c}_2$ one could formally define the integral using multiple residue integration with four complex variables. The constraint is that the poles associated with c_i and \bar{c}_i are conjugates of each other. Quaternion real-analyticity should guarantee this. This would of course be a *definition* of four-dimensional integral and might work for the 4-D generalization of conformal field theory.

Mandelbrot and Julia sets are fascinating fractals and already now more or less a standard piece of complex analysis. The fact that the iteration of octonion real-analytic map produces a sequence of space-time surfaces and partonic 2-surfaces encourages to ask whether these notions -and more generally, the dynamics based on iteration of analytic functions - might have a higher-dimensional generalization in the proposed framework.

1. The canonical Mandelbrot set corresponds to the set of the complex parameters c in $f(z) = z^2 + c$ for which iterates of $z = 0$ remain finite. In octonionic and quaternionic real-analytic case c would be real so that one would obtain only the intersection of the Mandelbrot set with real axes and the outcome would be rather uninteresting. This is true quite generally.
2. Julia set corresponds to the boundary of the Fatou set in which the dynamics defined by the iteration of $f(z)$ by definition behaves in a regular manner. In Julia set the behavior is chaotic. Julia set can be defined as a set of complex plane resulting by taking inverse images of a generic point belonging to the Julia set. For polynomials Julia set is the boundary of the region in which iterates remain finite. In Julia set the dynamics defined by the iteration is chaotic.

Julia set could be interesting also in the recent case since it could make sense for real analytic functions of both quaternions and octonions, and one might hope that the dynamics determined by the iterations of octonion real-analytic function could have a physical meaning as a space-time correlate for quantal self-organization by quantum jump in TGD framework. Single step in iteration would be indeed a very natural space-time correlate for quantum jump. The restriction of octonion analytic functions to string world sheets should produce the counterparts of the ordinary Julia sets since these surfaces are mapped to themselves under iteration and octonion real-analytic functions reduces to ordinary complex real-analytic functions at them. Therefore one might obtain the counterparts of Julia sets in 4-D sense as extensions of ordinary Julia sets. These extensions would be 3-D sets obtained as piles of ordinary Julia sets labelled by partonic 2-surfaces.

2.9 In what sense TGD could be an integrable theory?

During years evidence supporting the idea that TGD could be an integrable theory in some sense has accumulated. The challenge is to show that various ideas about what integrability means form pieces of a bigger coherent picture. Of course, some of the ideas are doomed to be only partially correct or simply wrong. Since it is not possible to know beforehand what ideas are wrong and what are right the situation is very much like in experimental physics and it is easy to claim (and has been and will be claimed) that all this argumentation is useless speculation. This is the price that must be paid for real thinking.

Integrable theories allow to solve nonlinear classical dynamics in terms of scattering data for a linear system. In TGD framework this translates to quantum classical correspondence. The solutions of modified Dirac equation define the scattering data. This data should define a real analytic function whose octonionic extension defines the space-time surface as a surface for which its imaginary part in the representation as bi-quaternion vanishes. There are excellent hopes about this thanks to the reduction of the modified Dirac equation to geometric optics.

In the following I will first discuss briefly what integrability means in (quantum) field theories, list some bits of evidence for integrability in TGD framework, discuss once again the question whether the different pieces of evidence are consistent with other and what one really means with various notions. As an outcome I represent what I regard as a more coherent view about integrability of TGD. The notion of octonion analyticity developed in the previous section is essential for the for what follows.

2.9.1 What integrable theories are?

The following is an attempt to get some bird's eye of view about the landscape of integrable theories.

Examples of integrable theories

Integrable theories are typically non-linear 1+1-dimensional (quantum) field theories. Solitons and various other particle like structures are the characteristic phenomenon in these theories. Scattering matrix is trivial in the sense that the particles go through each other in the scattering and suffer only a phase change. In particular, momenta are conserved. Korteweg-de Vries equation [B9] was motivated by the attempt to explain the experimentally discovered shallow water wave preserving its shape and moving with a constant velocity. Sine-Gordon equation [B15] describes geometrically constant curvature surfaces and defines a Lorentz invariant non-linear field theory in 1+1-dimensional space-time, which can be applied to Josephson junctions (in TGD inspired quantum biology it is encountered in the model of nerve pulse [K66]). Non-linear Schrödinger equation [B12] having applications to optics and water waves represents a further example. All these equations have various variants.

From TGD point of view conformal field theories represent an especially interesting example of integrable theories. (Super-)conformal invariance is the basic underlying symmetry and by its infinite-dimensional character implies infinite number of conserved quantities. The construction of the theory reduces to the construction of the representations of (super-)conformal algebra. One can solve 2-point functions exactly and characterize them in terms of (possibly anomalous) scaling dimensions of conformal fields involved and the coefficients appearing in 3-point functions can be solved in terms of fusion rules leading to an associative algebra for conformal fields. The basic applications are to 2-dimensional critical thermodynamical systems whose scaling invariance generalizes to conformal invariance. String models represent second application in which a collection of super-conformal field theories associated with various genera of 2-surface is needed to describe loop corrections to the scattering amplitudes. Also moduli spaces of conformal equivalence classes become important.

Topological quantum field theories are also examples of integrable theories. Because of its independence on the metric Chern-Simons action is in 3-D case the unique action defining a topological quantum field theory. The calculations of knot invariants (for TGD approach see [K41]), topological invariants of 3-manifolds and 4-manifolds, and topological quantum computation (for a model of DNA as topological quantum computer see [K29]) represent applications of this approach. TGD as almost topological QFT means that the Kähler action for preferred extremals reduces to a surface term by the vanishing of Coulomb term in action and by the weak form of electric-magnetic duality reduces to Chern-Simons action. Both Euclidian and Minkowskian regions give this kind of contribution.

$\mathcal{N} = 4$ SYM is the a four-dimensional and very nearly realistic candidate for an integral quantum field theory. The observation that twistor amplitudes allow also a dual of the 4-D conformal symmetry motivates the extension of this symmetry to its infinite-dimensional Yangian variant [A39]. Also the enormous progress in the construction of scattering amplitudes suggests integrability. In TGD framework Yangian symmetry would emerge naturally by extending the symplectic variant of Kac-Moody algebra from light-cone boundary to the interior of causal diamond and the Kac-Moody algebra from light-like 3-surface representing wormhole throats at which the signature of the induced metric changes to the space-time interior [K92].

About mathematical methods

The mathematical methods used in integrable theories are rather refined and have contributed to the development of the modern mathematical physics. Mention only quantum groups, conformal algebras, and Yangian algebras.

The basic element of integrability is the possibility to transform the non-linear classical problem for which the interaction is characterized by a potential function or its analog to a linear scattering problem depending on time. For instance, for the ordinary Schrödinger function one can solve potential once single solution of the equation is known. This does not work in practice. One can however gather information about the asymptotic states in scattering to deduce the potential. One cannot do without information about bound state energies too.

In TGD framework asymptotic states correspond to partonic 2-surfaces at the two light-like boundaries of CD (more precisely: the largest CD involved and defining the IR resolution for momenta). From the scattering data coding information about scattering for various values of energy of the incoming particle one deduced the potential function or its analog.

1. The basic tool is inverse scattering transform known as Gelfand-Marchenko-Levitan (GML) transform described in simple terms in [B19].
 - (a) In 1+1 dimensional case the S-matrix characterizing scattering is very simple since the only thing that can take place in scattering is reflection or transmission. Therefore the S-matrix elements describe either of these processes and by unitarity the sum of corresponding probabilities equals to 1. The particle can arrive to the potential either from left or right and is characterized by a momentum. The transmission coefficient can have a pole meaning complex (imaginary in the simplest case) wave vector serving as a signal for the formation of a bound state or resonance. The scattering data are represented by the reflection and transmission coefficients as function of time.
 - (b) One can deduce an integral equation for a propagator like function $K(t, x)$ describing how delta pulse moving with light velocity is scattered from the potential and is expressible in terms of time integral over scattering data with contributions from both scattering states and bound states. The derivation of GML transform [B19] uses time reversal and time translational invariance and causality defined in terms of light velocity. After some tricks one obtains the integral equation as well as an expression for the time independent potential as $V(x) = K(x, x)$. The argument can be generalized to more complex problems to deduce the GML transform.
2. The so called Lax pair is one manner to describe integrable systems [B10]. Lax pair consists of two operators L and M . One studies what might be identified as "energy" eigenstates satisfying $L(x, t)\Psi = \lambda\Psi$. λ does not depend on time and one can say that the dynamics is associated with x coordinate whereas as t is time coordinate parametrizing different variants of eigenvalue problem with the same spectrum for L . The operator $M(t)$ does not depend on x at all and the independence of λ on time implies the condition

$$\partial_t L = [L, M] .$$

This equation is analogous to a quantum mechanical evolution equation for an operator induced by time dependent "Hamiltonian" M and gives the non-linear classical evolution equation when the commutator on the right hand side is a multiplicative operator (so that it does not involve differential operators acting on the coordinate x). Non-linear classical dynamics for the time dependent potential emerges as an integrability condition.

One could say that $M(t)$ introduces the time evolution of $L(t, x)$ as an automorphism which depends on time and therefore does not affect the spectrum. One has $L(t, x) = U(t)L(0, x)U^{-1}(t)$ with $dU(t)/dt = M(t)U(t)$. The time evolution of the analog of the quantum state is given by a similar equation.

3. A more refined view about Lax pair is based on the observation that the above equation can be generalized so that M depends also on x . The generalization of the basic equation for $M(x, t)$ reads as

$$\partial_t L - \partial_x M - [L, M] = 0 \ .$$

The condition has interpretation as a vanishing of the curvature of a gauge potential having components $A_x = L, A_t = M$. This generalization allows a beautiful geometric formulation of the integrability conditions and extends the applicability of the inverse scattering transform. The monodromy of the flat connection becomes important in this approach. Flat connections in moduli spaces are indeed important in topological quantum field theories and in conformal field theories.

4. There is also a connection with the so called Riemann-Hilbert problem [A27]. The monodromies of the flat connection define monodromy group and Riemann-Hilbert problem concerns the existence of linear differential equations having a given monodromy group. Monodromy group emerges in the analytic continuation of an analytic function and the action of the element of the monodromy group tells what happens for the resulting many-valued analytic function as one turns around a singularity once ('mono-'). The linear equations obviously relate to the linear scattering problem. The flat connection (M, L) in turn defines the monodromy group. What is needed is that the functions involved are analytic functions of (t, x) replaced with a complex or hyper-complex variable. Again Wick rotation is involved. Similar approach generalizes also to higher dimensional moduli spaces with complex structures.

In TGD framework the effective 2-dimensionality raises the hope that this kind of mathematical apparatus could be used. An interesting possibility is that finite measurement resolution could be realized in terms of a gauge group or Kac-Moody type group represented by trivial gauge potential defining a monodromy group for n-point functions. Monodromy invariance would hold for the full n-point functions constructed in terms of analytic n-point functions and their conjugates. The ends of braid strands are natural candidates for the singularities around which monodromies are defined.

2.9.2 Why TGD could be integrable theory in some sense?

There are many indications that TGD could be an integrable theory in some sense. The challenge is to see which ideas are consistent with each other and to build a coherent picture where everything finds its own place.

1. 2-dimensionality or at least effective 2-dimensionality seems to be a prerequisite for integrability. Effective 2-dimensionality is suggested by the strong form of General Coordinate Invariance implying also holography and generalized conformal invariance predicting infinite number of conservation laws. The dual roles of partonic 2-surfaces and string world sheets supports a four-dimensional generalization of conformal invariance. Twistor considerations [K89] indeed suggest that Yangian invariance and Kac-Moody invariances combine to a 4-D analog of conformal invariance induced by 2-dimensional one by algebraic continuation.
2. Octonionic representation of imbedding space Clifford algebra and the identification of the space-time surfaces as quaternionic space-time surfaces would define a number theoretically natural generalization of conformal invariance. The reason for using gamma matrix representation is that vector field representation for octonionic units does not exist. The problem concerns the precise meaning of the octonionic representation of gamma matrices.

Space-time surfaces could be quaternionic also in the sense that conformal invariance is analytically continued from string curve to 8-D space by octonion real-analyticity. The question is whether the Clifford algebra based notion of tangent space quaternionicity is equivalent with octonionic real-analyticity based notion of quaternionicity.

The notions of co-associativity and co-quaternionicity make also sense and one must consider seriously the possibility that associativity-co-associativity dichotomy corresponds to Minkowskian-Euclidian dichotomy.

3. Field equations define hydrodynamic Beltrami flows satisfying integrability conditions of form $J \wedge dJ = 0$.

- (a) One can assign local momentum and polarization directions to the preferred extremals and this gives a decomposition of Minkowskian space-time regions to massless quanta analogous to the 1+1-dimensional decomposition to solitons. The linear superposition of modes with 4-momenta with different directions possible for free Maxwell action does not look plausible for the preferred extremals of Kähler action. This rather quantal and solitonic character is in accordance with the quantum classical correspondence giving very concrete connection between quantal and classical particle pictures. For 4-D volume action one does not obtain this kind of decomposition. In 2-D case volume action gives superposition of solutions with different polarization directions so that the situation is nearer to that for free Maxwell action and is not like soliton decomposition.
 - (b) Beltrami property in strong sense allows to identify 4 preferred coordinates for the space-time surface in terms of corresponding Beltrami flows. This is possible also in Euclidian regions using two complex coordinates instead of hyper-complex coordinate and complex coordinate. The assumption that isometry currents are parallel to the same light-like Beltrami flow implies hydrodynamic character of the field equations in the sense that one can say that each flow line is analogous to particle carrying some quantum numbers. This property is not true for all extremals (say cosmic strings).
 - (c) The tangent bundle theoretic view about integrability is that one can find a Lie algebra of vector fields in some manifold spanning the tangent space of a lower-dimensional manifolds and is expressed in terms of Frobenius theorem [A7]). The gradients of scalar functions defining Beltrami flows appearing in the ansatz for preferred extremals would define these vector fields and the slicing. Partonic 2-surfaces would correspond to two complex conjugate vector fields (local polarization direction) and string world sheets to light-like vector field and its dual (light-like momentum directions). This slicing generalizes to the Euclidian regions.
4. Infinite number of conservation laws is the signature of integrability. Classical field equations follow from the condition that the vector field defined by modified gamma matrices has vanishing divergence and can be identified an integrability condition for the modified Dirac equation guaranteeing also the conservation of super currents so that one obtains an infinite number of conserved charges.
 5. Quantum criticality is a further signal of integrability. 2-D conformal field theories describe critical systems so that the natural guess is that quantum criticality in TGD framework relates to the generalization of conformal invariance and to integrability. Quantum criticality implies that Kähler coupling strength is analogous to critical temperature. This condition does affect classical field equations only via boundary conditions expressed as weak form of electric magnetic duality at the wormhole throats at which the signature of the metric changes.

For finite-dimensional systems the vanishing of the determinant of the matrix defined by the second derivatives of potential is similar signature and applies in catastrophe theory. Therefore the existence of vanishing second variations of Kähler action should characterize criticality and define a property of preferred extremals. The vanishing of second variations indeed leads to an infinite number of conserved currents [K31, K11].

2.9.3 Questions

There are several questions which are not completely settled yet. Even the question what preferred extremals are is still partially open. In the following I try to de-learn what I have possibly learned during these years and start from scratch to see which assumptions might be un-necessarily strong or even wrong.

2.9.4 Could TGD be an integrable theory?

Consider first the abstraction of integrability in TGD framework. Quantum classical correspondence could be seen as a correspondence between linear quantum dynamics and non-linear classical dynamics. Integrability would realize this correspondence. In integrable models such as Sine-Gordon equation particle interactions are described by potential in 1+1 dimensions. This too primitive for the purposes

of TGD. The vertices of generalized Feynman diagrams take care of this. At lines one has free particle dynamics so that the situation could be much simpler than in integrable models if one restricts the considerations to the lines or Minkowskian space-time regions surrounding them.

The non-linear dynamics for the space-time sheets representing incoming lines of generalized Feynman diagram should be obtainable from the linear dynamics for the induced spinor fields defined by modified Dirac operator. There are two options.

1. Strong form of the quantum classical correspondence states that each solution for the linear dynamics of spinor fields corresponds to space-time sheet. This is analogous to solving the potential function in terms of a single solution of Schrödinger equation. Coupling of space-time geometry to quantum numbers via measurement interaction term is a proposal for realizing this option. It is however the quantum numbers of positive/negative energy parts of zero energy state which would be visible in the classical dynamics rather than those of induced spinor field modes.
2. Only overall dynamics characterized by scattering data- the counterpart of S -matrix for the modified Dirac operator- is mapped to the geometry of the space-time sheet. This is much more abstract realization of quantum classical correspondence.
3. Can these two approaches be equivalent? This might be the case since quantum numbers of the state are not those of the modes of induced spinor fields.

What the scattering data could be for the induced spinor field satisfying modified Dirac equation?

1. If the solution of field equation has hydrodynamic character, the solutions of the modified Dirac equation can be localized to light-like Beltrami flow lines of hydrodynamic flow. These correspond to basic solutions and the general solution is a superposition of these. There is no dispersion and the dynamics is that of geometric optics at the basic level. This means geometric optics like character of the spinor dynamics.

Solutions of the modified Dirac equation are completely analogous to the pulse solutions defining the fundamental solution for the wave equation in the argument leading from wave equation with external time independent potential to Marchenko-Gelfand-Levitan equation allowing to identify potential in terms of scattering data. There is however no potential present now since the interactions are described by the vertices of Feynman diagram where the particle lines meet. Note that particle like regions are Euclidian and that this picture applies only to the Minkowskian exteriors of particles.

2. Partonic 2-surfaces at the ends of the line of generalized Feynman diagram are connected by flow lines. Partonic 2-surfaces at which the signature of the induced metric changes are in a special position. Only the imaginary part of the bi-quaternionic value of the octonion valued map is non-vanishing at these surfaces which can be said to be co-complex 2-surfaces. By geometric optics behavior the scattering data correspond to a diffeomorphism mapping initial partonic 2-surface to the final one in some preferred complex coordinates common to both ends of the line.
3. What could be these preferred coordinates? Complex coordinates for S^2 at light-cone boundary define natural complex coordinates for the partonic 2-surface. With these coordinates the diffeomorphism defining scattering data is diffeomorphism of S^2 . Suppose that this map is real analytic so that maps "real axis" of S^2 to itself. This map would be same as the map defining the octonionic real analyticity as algebraic extension of the complex real analytic map. By octonionic analyticity one can make large number of alternative choices for the coordinates of partonic 2-surface.
4. There can be non-uniqueness due to the possibility of $G_2/SU(3)$ valued map characterizing the local octonionic units. The proposal is that the choice of octonionic imaginary units can depend on the point of string like orbit: this would give string model in $G_2/SU(3)$. Conformal invariance for this string model would imply analyticity and helps considerably but would not probably fix the situation completely since the element of the coset space would constant at the partonic 2-surfaces at the ends of CD . One can of course ask whether the $G_2/SU(3)$ element could be constant for each propagator line and would change only at the 2-D vertices?

This would be the inverse scattering problem formulated in the spirit of TGD. There could be also dependence of space-time surface on quantum numbers of quantum states but not on individual solution for the induced spinor field since the scattering data of this solution would be purely geometric.

2.10 About deformations of known extremals of Kähler action

I have done a considerable amount of speculative guesswork to identify what I have used to call preferred extremals of Kähler action. The problem is that the mathematical problem at hand is extremely non-linear and that there is no existing mathematical literature. One must proceed by trying to guess the general constraints on the preferred extremals which look physically and mathematically plausible. The hope is that this net of constraints could eventually crystallize to Eureka! Certainly the recent speculative picture involves also wrong guesses. The need to find explicit ansatz for the deformations of known extremals based on some common principles has become pressing. The following considerations represent an attempt to combine the existing information to achieve this.

2.10.1 What might be the common features of the deformations of known extremals

The dream is to discover the deformations of all known extremals by guessing what is common to all of them. One might hope that the following list summarizes at least some common features.

Effective three-dimensionality at the level of action

1. Holography realized as effective 3-dimensionality also at the level of action requires that it reduces to 3-dimensional effective boundary terms. This is achieved if the contraction $j^\alpha A_\alpha$ vanishes. This is true if j^α vanishes or is light-like, or if it is proportional to instanton current in which case current conservation requires that CP_2 projection of the space-time surface is 3-dimensional. The first two options for j have a realization for known extremals. The status of the third option - proportionality to instanton current - has remained unclear.
2. As I started to work again with the problem, I realized that instanton current could be replaced with a more general current $j = *B \wedge J$ or concretely: $j^\alpha = \epsilon^{\alpha\beta\gamma\delta} B_\beta J_{\gamma\delta}$, where B is vector field and CP_2 projection is 3-dimensional, which it must be in any case. The contractions of j appearing in field equations vanish automatically with this ansatz.
3. Almost topological QFT property in turn requires the reduction of effective boundary terms to Chern-Simons terms: this is achieved by boundary conditions expressing weak form of electric magnetic duality. If one generalizes the weak form of electric magnetic duality to $J = \Phi * J$ one has $B = d\Phi$ and j has a vanishing divergence for 3-D CP_2 projection. This is clearly a more general solution ansatz than the one based on proportionality of j with instanton current and would reduce the field equations in concise notation to $Tr(TH^k) = 0$.
4. Any of the alternative properties of the Kähler current implies that the field equations reduce to $Tr(TH^k) = 0$, where T and H^k are shorthands for Maxwellian energy momentum tensor and second fundamental form and the product of tensors is obvious generalization of matrix product involving index contraction.

Could Einstein's equations emerge dynamically?

For j^α satisfying one of the three conditions, the field equations have the same form as the equations for minimal surfaces except that the metric g is replaced with Maxwell energy momentum tensor T .

1. This raises the question about dynamical generation of small cosmological constant Λ : $T = \Lambda g$ would reduce equations to those for minimal surfaces. For $T = \Lambda g$ modified gamma matrices would reduce to induced gamma matrices and the modified Dirac operator would be proportional to ordinary Dirac operator defined by the induced gamma matrices. One can also consider weak form for $T = \Lambda g$ obtained by restricting the consideration to sub-space of tangent space so that space-time surface is only "partially" minimal surface but this option is not so elegant although necessary for other than CP_2 type vacuum extremals.

2. What is remarkable is that $T = \Lambda g$ implies that the divergence of T which in the general case equals to $j^\beta J_\beta^\alpha$ vanishes. This is guaranteed by one of the conditions for the Kähler current. Since also Einstein tensor has a vanishing divergence, one can ask whether the condition to $T = \kappa G + \Lambda g$ could be the general condition. This would give Einstein's equations with cosmological term besides the generalization of the minimal surface equations. GRT would emerge dynamically from the non-linear Maxwell's theory although in slightly different sense as conjectured [K85]! Note that the expression for G involves also second derivatives of the imbedding space coordinates so that actually a partial differential equation is in question. If field equations reduce to purely algebraic ones, as the basic conjecture states, it is possible to have $Tr(GH^k) = 0$ and $Tr(gH^k) = 0$ separately so that also minimal surface equations would hold true.

What is amusing that the first guess for the action of TGD was curvature scalar. It gave analogs of Einstein's equations as a definition of conserved four-momentum currents. The recent proposal would give the analog of ordinary Einstein equations as a dynamical constraint relating Maxwellian energy momentum tensor to Einstein tensor and metric.

3. Minimal surface property is physically extremely nice since field equations can be interpreted as a non-linear generalization of massless wave equation: something very natural for non-linear variant of Maxwell action. The theory would be also very "stringy" although the fundamental action would not be space-time volume. This can however hold true only for Euclidian signature. Note that for CP_2 type vacuum extremals Einstein tensor is proportional to metric so that for them the two options are equivalent. For their small deformations situation changes and it might happen that the presence of G is necessary. The GRT limit of TGD discussed in [K85] [L8] indeed suggests that CP_2 type solutions satisfy Einstein's equations with large cosmological constant and that the small observed value of the cosmological constant is due to averaging and small volume fraction of regions of Euclidian signature (lines of generalized Feynman diagrams).
4. For massless extremals and their deformations $T = \Lambda g$ cannot hold true. The reason is that for massless extremals energy momentum tensor has component T^{vv} which actually quite essential for field equations since one has $H_{vv}^k = 0$. Hence for massless extremals and their deformations $T = \Lambda g$ cannot hold true if the induced metric has Hamilton-Jacobi structure meaning that g^{uu} and g^{vv} vanish. A more general relationship of form $T = \kappa G + \Lambda G$ can however be consistent with non-vanishing T^{vv} but require that deformation has at most 3-D CP_2 projection (CP_2 coordinates do not depend on v).
5. The non-determinism of vacuum extremals suggest for their non-vacuum deformations a conflict with the conservation laws. In, also massless extremals are characterized by a non-determinism with respect to the light-like coordinate but like-likeness saves the situation. This suggests that the transformation of a properly chosen time coordinate of vacuum extremal to a light-like coordinate in the induced metric combined with Einstein's equations in the induced metric of the deformation could allow to handle the non-determinism.

Are complex structure of CP_2 and Hamilton-Jacobi structure of M^4 respected by the deformations?

The complex structure of CP_2 and Hamilton-Jacobi structure of M^4 could be central for the understanding of the preferred extremal property algebraically.

1. There are reasons to believe that the Hermitian structure of the induced metric ((1,1) structure in complex coordinates) for the deformations of CP_2 type vacuum extremals could be crucial property of the preferred extremals. Also the presence of light-like direction is also an essential elements and 3-dimensionality of M^4 projection could be essential. Hence a good guess is that allowed deformations of CP_2 type vacuum extremals are such that (2,0) and (0,2) components the induced metric and/or of the energy momentum tensor vanish. This gives rise to the conditions implying Virasoro conditions in string models in quantization:

$$g_{\xi^i \xi^j} = 0 \quad , \quad g_{\bar{\xi}^i \bar{\xi}^j} = 0 \quad , \quad i, j = 1, 2 \quad . \quad (2.10.1)$$

Holomorphisms of CP_2 preserve the complex structure and Virasoro conditions are expected to generalize to 4-dimensional conditions involving two complex coordinates. This means that the generators have two integer valued indices but otherwise obey an algebra very similar to the Virasoro algebra. Also the super-conformal variant of this algebra is expected to make sense.

These Virasoro conditions apply in the coordinate space for CP_2 type vacuum extremals. One expects similar conditions hold true also in field space, that is for M^4 coordinates.

2. The integrable decomposition $M^4(m) = M^2(m) + E^2(m)$ of M^4 tangent space to longitudinal and transversal parts (non-physical and physical polarizations) - Hamilton-Jacobi structure- could be a very general property of preferred extremals and very natural since non-linear Maxwellian electrodynamics is in question. This decomposition led rather early to the introduction of the analog of complex structure in terms of what I called Hamilton-Jacobi coordinates (u, v, w, \bar{w}) for M^4 . (u, v) defines a pair of light-like coordinates for the local longitudinal space $M^2(m)$ and (w, \bar{w}) complex coordinates for $E^2(m)$. The metric would not contain any cross terms between $M^2(m)$ and $E^2(m)$: $g_{uw} = g_{vw} = g_{u\bar{w}} = g_{v\bar{w}} = 0$.

A good guess is that the deformations of massless extremals respect this structure. This condition gives rise to the analog of the constraints leading to Virasoro conditions stating the vanishing of the non-allowed components of the induced metric. $g_{uu} = g_{vv} = g_{ww} = g_{\bar{w}\bar{w}} = g_{uv} = g_{vw} = g_{u\bar{w}} = g_{v\bar{w}} = 0$. Again the generators of the algebra would involve two integers and the structure is that of Virasoro algebra and also generalization to super algebra is expected to make sense. The moduli space of Hamilton-Jacobi structures would be part of the moduli space of the preferred extremals and analogous to the space of all possible choices of complex coordinates. The analogs of infinitesimal holomorphic transformations would preserve the modular parameters and give rise to a 4-dimensional Minkowskian analog of Virasoro algebra. The conformal algebra acting on CP_2 coordinates acts in field degrees of freedom for Minkowskian signature.

Field equations as purely algebraic conditions

If the proposed picture is correct, field equations would reduce basically to purely algebraically conditions stating that the Maxwellian energy momentum tensor has no common index pairs with the second fundamental form. For the deformations of CP_2 type vacuum extremals T is a complex tensor of type (1,1) and second fundamental form H^k a tensor of type (2,0) and (0,2) so that $Tr(TH^k) = 0$ is true. This requires that second light-like coordinate of M^4 is constant so that the M^4 projection is 3-dimensional. For Minkowskian signature of the induced metric Hamilton-Jacobi structure replaces conformal structure. Here the dependence of CP_2 coordinates on second light-like coordinate of $M^2(m)$ only plays a fundamental role. Note that now T^{vv} is non-vanishing (and light-like). This picture generalizes to the deformations of cosmic strings and even to the case of vacuum extremals.

2.10.2 What small deformations of CP_2 type vacuum extremals could be?

I was led to these arguments when I tried find preferred extremals of Kähler action, which would have 4-D CP_2 and M^4 projections - the Maxwell phase analogous to the solutions of Maxwell's equations that I conjectured long time ago. It however turned out that the dimensions of the projections can be $(D_{M^4} \leq 3, D_{CP_2} = 4)$ or $(D_{M^4} = 4, D_{CP_2} \leq 3)$. What happens is essentially breakdown of linear superposition so that locally one can have superposition of modes which have 4-D wave vectors in the same direction. This is actually very much like quantization of radiation field to photons now represented as separate space-time sheets and one can say that Maxwellian superposition corresponds to union of separate photonic space-time sheets in TGD. In the following I shall restrict the consideration to the deformations of CP_2 type vacuum extremals.

Solution ansatz

I proceed by the following arguments to the ansatz.

1. Effective 3-dimensionality for action (holography) requires that action decomposes to vanishing $j^\alpha A_\alpha$ term + total divergence giving 3-D "boundary" terms. The first term certainly vanishes (giving effective 3-dimensionality) for

$$D_{\beta} J^{\alpha\beta} = j^{\alpha} = 0 .$$

Empty space Maxwell equations, something extremely natural. Also for the proposed GRT limit these equations are true.

2. How to obtain empty space Maxwell equations $j^{\alpha} = 0$? The answer is simple: assume self duality or its slight modification:

$$J = *J$$

holding for CP_2 type vacuum extremals or a more general condition

$$J = k * J ,$$

In the simplest situation k is some constant not far from unity. $*$ is Hodge dual involving 4-D permutation symbol. $k = \text{constant}$ requires that the determinant of the induced metric is apart from constant equal to that of CP_2 metric. It does not require that the induced metric is proportional to the CP_2 metric, which is not possible since M^4 contribution to metric has Minkowskian signature and cannot be therefore proportional to CP_2 metric.

One can consider also a more general situation in which k is scalar function as a generalization of the weak electric-magnetic duality. In this case the Kähler current is non-vanishing but divergenceless. This also guarantees the reduction to $Tr(TH^k) = 0$. In this case however the proportionality of the metric determinant to that for CP_2 metric is not needed. This solution ansatz becomes therefore more general.

3. Field equations reduce with these assumptions to equations differing from minimal surfaces equations only in that metric g is replaced by Maxwellian energy momentum tensor T . Schematically:

$$Tr(TH^k) = 0 ,$$

where T is the Maxwellian energy momentum tensor and H^k is the second fundamental form - asymmetric 2-tensor defined by covariant derivative of gradients of imbedding space coordinates.

How to satisfy the condition $Tr(TH^k) = 0$?

It would be nice to have minimal surface equations since they are the non-linear generalization of massless wave equations. It would be also nice to have the vanishing of the terms involving Kähler current in field equations as a consequence of this condition. Indeed, $T = \kappa G + \Lambda g$ implies this. In the case of CP_2 vacuum extremals one cannot distinguish between these options since CP_2 itself is constant curvature space with $G \propto g$. Furthermore, if G and g have similar tensor structure the algebraic field equations for G and g are satisfied separately so that one obtains minimal surface property also now. In the following minimal surface option is considered.

1. The first option is achieved if one has

$$T = \Lambda g .$$

Maxwell energy momentum tensor would be proportional to the metric! One would have dynamically generated cosmological constant! This begins to look really interesting since it appeared also at the proposed GRT limit of TGD [L8]. Note that here also non-constant value of Λ can be considered and would correspond to a situation in which k is scalar function: in this case the the determinant condition can be dropped and one obtains just the minimal surface equations.

2. Very schematically and forgetting indices and being sloppy with signs, the expression for T reads as

$$T = JJ - g/4Tr(JJ) .$$

Note that the product of tensors is obtained by generalizing matrix product. This should be proportional to metric.

Self duality implies that $Tr(JJ)$ is just the instanton density and does not depend on metric and is constant.

For CP_2 type vacuum extremals one obtains

$$T = -g + g = 0 .$$

Cosmological constant would vanish in this case.

3. Could it happen that for deformations a small value of cosmological constant is generated?

The condition would reduce to

$$JJ = (\Lambda - 1)g .$$

Λ must relate to the value of parameter k appearing in the generalized self-duality condition. For the most general ansatz Λ would not be constant anymore.

This would generalize the defining condition for Kähler form

$$JJ = -g \quad (i^2 = -1 \text{ geometrically})$$

stating that the square of Kähler form is the negative of metric. The only modification would be that index raising is carried out by using the induced metric containing also M^4 contribution rather than CP_2 metric.

4. Explicitly:

$$J_{\alpha\mu}J^{\mu}_{\beta} = (\Lambda - 1)g_{\alpha\beta} .$$

Cosmological constant would measure the breaking of Kähler structure. By writing $g = s+m$ and defining index raising of tensors using CP_2 metric and their product accordingly, this condition can be also written as

$$Jm = (\Lambda - 1)mJ .$$

If the parameter k is constant, the determinant of the induced metric must be proportional to the CP_2 metric. If k is scalar function, this condition can be dropped. Cosmological constant would not be constant anymore but the dependence on k would drop out from the field equations and one would hope of obtaining minimal surface equations also now. It however seems that the dimension of M^4 projection cannot be four. For 4-D M^4 projection the contribution of the M^2 part of the M^4 metric gives a non-holomorphic contribution to CP_2 metric and this spoils the field equations.

For $T = \kappa G + \Lambda g$ option the value of the cosmological constant is large - just as it is for the proposed GRT limit of TGD [K85] [L8]. The interpretation in this case is that the average value of cosmological constant is small since the portion of space-time volume containing generalized Feynman diagrams is very small.

More detailed ansatz for the deformations of CP_2 type vacuum extremals

One can develop the ansatz to a more detailed form. The most obvious guess is that the induced metric is apart from constant conformal factor the metric of CP_2 . This would guarantee self-duality apart from constant factor and $j^\alpha = 0$. Metric would be in complex CP_2 coordinates tensor of type (1,1) whereas CP_2 Riemann connection would have only purely holomorphic or anti-holomorphic indices. Therefore CP_2 contributions in $Tr(TH^k)$ would vanish identically. M^4 degrees of freedom however bring in difficulty. The M^4 contribution to the induced metric should be proportional to CP_2 metric and this is impossible due to the different signatures. The M^4 contribution to the induced metric breaks its Kähler property but would preserve Hermitian structure.

A more realistic guess based on the attempt to construct deformations of CP_2 type vacuum extremals is following.

1. Physical intuition suggests that M^4 coordinates can be chosen so that one has integrable decomposition to longitudinal degrees of freedom parametrized by two light-like coordinates u and v and to transversal polarization degrees of freedom parametrized by complex coordinate w and its conjugate. M^4 metric would reduce in these coordinates to a direct sum of longitudinal and transverse parts. I have called these coordinates Hamilton Jacobi coordinates.
2. w would be holomorphic function of CP_2 coordinates and therefore satisfy massless wave equation. This would give hopes about rather general solution ansatz. u and v cannot be holomorphic functions of CP_2 coordinates. Unless wither u or v is constant, the induced metric would receive contributions of type (2,0) and (0,2) coming from u and v which would break Kähler structure and complex structure. These contributions would give no-vanishing contribution to all minimal surface equations. Therefore either u or v is constant: the coordinate line for non-constant coordinate -say u - would be analogous to the M^4 projection of CP_2 type vacuum extremal.
3. With these assumptions the induced metric would remain (1,1) tensor and one might hope that $Tr(TH^k)$ contractions vanishes for all variables except u because the there are no common index pairs (this if non-vanishing Christoffel symbols for H involve only holomorphic or anti-holomorphic indices in CP_2 coordinates). For u one would obtain massless wave equation expressing the minimal surface property.
4. If the value of k is constant the determinant of the induced metric must be proportional to the determinant of CP_2 metric. The induced metric would contain only the contribution from the transversal degrees of freedom besides CP_2 contribution. Minkowski contribution has however rank 2 as CP_2 tensor and cannot be proportional to CP_2 metric. It is however enough that its determinant is proportional to the determinant of CP_2 metric with constant proportionality coefficient. This condition gives an additional non-linear condition to the solution. One would have wave equation for u (also w and its conjugate satisfy massless wave equation) and determinant condition as an additional condition.

The determinant condition reduces by the linearity of determinant with respect to its rows to sum of conditions involved 0,1,2 rows replaced by the transversal M^4 contribution to metric given if M^4 metric decomposes to direct sum of longitudinal and transversal parts. Derivatives with respect to derivative with respect to particular CP_2 complex coordinate appear linearly in this expression they can depend on u via the dependence of transversal metric components on u . The challenge is to show that this equation has (or does not have) non-trivial solutions.

5. If the value of k is scalar function the situation changes and one has only the minimal surface equations and Virasoro conditions.

What makes the ansatz attractive is that special solutions of Maxwell empty space equations are in question, equations reduces to non-linear generalizations of Euclidian massless wave equations, and possibly space-time dependent cosmological constant pops up dynamically. These properties are true also for the GRT limit of TGD [L8].

2.10.3 Hamilton-Jacobi conditions in Minkowskian signature

The maximally optimistic guess is that the basic properties of the deformations of CP_2 type vacuum extremals generalize to the deformations of other known extremals such as massless extremals, vacuum

extremals with 2-D CP_2 projection which is Lagrangian manifold, and cosmic strings characterized by Minkowskian signature of the induced metric. These properties would be following.

1. The recomposition of M^4 tangent space to longitudinal and transversal parts giving Hamilton-Jacobi structure. The longitudinal part has hypercomplex structure but the second light-like coordinate is constant: this plays a crucial role in guaranteeing the vanishing of contractions in $Tr(TH^k)$. It is the algebraic properties of g and T which are crucial. T can however have light-like component T^{vv} . For the deformations of CP_2 type vacuum extremals (1,1) structure is enough and is guaranteed if second light-like coordinate of M^4 is constant whereas w is holomorphic function of CP_2 coordinates.
2. What could happen in the case of massless extremals? Now one has 2-D CP_2 projection in the initial situation and CP_2 coordinates depend on light-like coordinate u and single real transversal coordinate. The generalization would be obvious: dependence on single light-like coordinate u and holomorphic dependence on w for complex CP_2 coordinates. The constraint is $T = \Lambda g$ cannot hold true since T^{vv} is non-vanishing (and light-like). This property restricted to transversal degrees of freedom could reduce the field equations to minimal surface equations in transversal degrees of freedom. The transversal part of energy momentum tensor would be proportional to metric and hence covariantly constant. Gauge current would remain light-like but would not be given by $j = *d\phi \wedge J$. $T = \kappa G + \Lambda g$ seems to define the attractive option.

It therefore seems that the essential ingredient could be the condition

$$T = \kappa G + \lambda g \quad ,$$

which has structure (1,1) in both $M^2(m)$ and $E^2(m)$ degrees of freedom apart from the presence of T^{vv} component with deformations having no dependence on v . If the second fundamental form has (2,0)+(0,2) structure, the minimal surface equations are satisfied provided Kähler current satisfies on of the proposed three conditions and if G and g have similar tensor structure.

One can actually pose the conditions of metric as complete analogs of stringy constraints leading to Virasoro conditions in quantization to give

$$g_{uu} = 0 \quad , \quad g_{vv} = 0 \quad , \quad g_{ww} = 0 \quad , \quad g_{\bar{w}\bar{w}} = 0 \quad . \quad (2.10.2)$$

This brings in mind the generalization of Virasoro algebra to four-dimensional algebra for which an identification in terms of non-local Yangian symmetry has been proposed [K92]. The number of conditions is four and the same as the number of independent field equations. One can consider similar conditions also for the energy momentum tensor T but allowing non-vanishing component T^{vv} if deformations has no v -dependence. This would solve the field equations if the gauge current vanishes or is light-like. On this case the number of equations is 8. First order differential equations are in question and they can be also interpreted as conditions fixing the coordinates used since there is infinite number of manners to choose the Hamilton-Jacobi coordinates.

One can try to apply the physical intuition about general solutions of field equations in the linear case by writing the solution as a superposition of left and right propagating solutions:

$$\xi^k = f_+^k(u, w) + f_-^k(v, w) \quad . \quad (2.10.3)$$

This could guarantee that second fundamental form is of form (2,0)+(0,2) in both M^2 and E^2 part of the tangent space and these terms if $Tr(TH^k)$ vanish identically. The remaining terms involve contractions of T^{uw} , $T^{u\bar{w}}$ and T^{vw} , $T^{v\bar{w}}$ with second fundamental form. Also these terms should sum up to zero or vanish separately. Second fundamental form has components coming from f_+^k and f_-^k

Second fundamental form H^k has as basic building bricks terms \hat{H}^k given by

$$\hat{H}_{\alpha\beta}^k = \partial_\alpha \partial_\beta h^k + \binom{k}{l \ m} \partial_\alpha h^l \partial_\beta h^m \quad . \quad (2.10.4)$$

For the proposed ansatz the first terms give vanishing contribution to H_{uv}^k . The terms containing Christoffel symbols however give a non-vanishing contribution and one can allow only f_+^k or f_-^k as in the case of massless extremals. This reduces the dimension of CP_2 projection to $D = 3$.

What about the condition for Kähler current? Kähler form has components of type $J_{w\bar{w}}$ whose contravariant counterpart gives rise to space-like current component. J_{uw} and $J_{u\bar{w}}$ give rise to light-like currents components. The condition would state that the $J^{w\bar{w}}$ is covariantly constant. Solutions would be characterized by a constant Kähler magnetic field. Also electric field is present. The interpretation both radiation and magnetic flux tube makes sense.

2.10.4 Deformations of cosmic strings

In the physical applications it has been assumed that the thickening of cosmic strings to Kähler magnetic flux tubes takes place. One indeed expects that the proposed construction generalizes also to the case of cosmic strings having the decomposition $X^4 = X^2 \times Y^2 \subset M^4 \times CP_2$, where X^2 is minimal surface and Y^2 a complex homologically non-trivial sub-manifold of CP_2 . Now the starting point structure is Hamilton-Jacobi structure for $M_m^2 \times Y^2$ defining the coordinate space.

1. The deformation should increase the dimension of either CP_2 or M^4 projection or both. How this thickening could take place? What comes in mind that the string orbits X^2 can be interpreted as a distribution of longitudinal spaces $M^2(x)$ so that for the deformation w coordinate becomes a holomorphic function of the natural Y^2 complex coordinate so that M^4 projection becomes 4-D but CP_2 projection remains 2-D. The new contribution to the X^2 part of the induced metric is vanishing and the contribution to the Y^2 part is of type $(1, 1)$ and the ansatz $T = \kappa G + \Lambda g$ might be needed as a generalization of the minimal surface equations. The ratio of κ and G would be determined from the form of the Maxwellian energy momentum tensor and be fixed at the limit of undeformed cosmic string to $T = (ag(Y^2) - bg(Y^2))$. The value of cosmological constant is now large, and overall consistency suggests that $T = \kappa G + \Lambda g$ is the correct option also for the CP_2 type vacuum extremals.
2. One could also imagine that remaining CP_2 coordinates could depend on the complex coordinate of Y^2 so that also CP_2 projection would become 4-dimensional. The induced metric would receive holomorphic contributions in Y^2 part. As a matter of fact, this option is already implied by the assumption that Y^2 is a complex surface of CP_2 .

2.10.5 Deformations of vacuum extremals?

What about the deformations of vacuum extremals representable as maps from M^4 to CP_2 ?

1. The basic challenge is the non-determinism of the vacuum extremals. One should perform the deformation so that conservation laws are satisfied. For massless extremals there is also non-determinism but it is associated with the light-like coordinate so that there are no problems with the conservation laws. This would suggest that a properly chosen time coordinate consistent with Hamilton-Jacobi decomposition becomes light-like coordinate in the induced metric. This poses a conditions on the induced metric.
2. Physical intuition suggests that one cannot require $T = \Lambda g$ since this would mean that the rank of T is maximal whereas the original situation corresponds to the vanishing of T . For small deformations rank two for T looks more natural and one could think that T is proportional to a projection of metric to a 2-D subspace. The vision about the long length scale limit of TGD is that Einstein's equations are satisfied and this would suggest $T = kG$ or $T = \kappa G + \Lambda g$. The rank of T could be smaller than four for this ansatz and this conditions binds together the values of κ and G .
3. These extremals have CP_2 projection which in the generic case is 2-D Lagrangian sub-manifold Y^2 . Again one could assume Hamilton-Jacobi coordinates for X^4 . For CP_2 one could assume Darboux coordinates (P_i, Q_i) , $i = 1, 2$, in which one has $A = P_i dQ_i$, and that $Y^2 \subset CP_2$ corresponds to $Q_i = \text{constant}$. In principle P_i would depend on arbitrary manner on M^4 coordinates. It might be more convenient to use as coordinates (u, v) for M^2 and (P_1, P_2) for Y^2 . This covers also the situation when M^4 projection is not 4-D. By its 2-dimensionality Y^2

allows always a complex structure defined by its induced metric: this complex structure is not consistent with the complex structure of CP_2 (Y^2 is not complex sub-manifold).

Using Hamilton-Jacobi coordinates the pre-image of a given point of Y^2 is a 2-dimensional sub-manifold X^2 of X^4 and defines also 2-D sub-manifold of M^4 . The following picture suggests itself. The projection of X^2 to M^4 can be seen for a suitable choice of Hamilton-Jacobi coordinates as an analog of Lagrangian sub-manifold in M^4 that is as surface for which v and $Im(w)$ vary and u and $Re(w)$ are constant. X^2 would be obtained by allowing u and $Re(w)$ to vary: as a matter fact, (P_1, P_2) and $(u, Re(w))$ would be related to each other. The induced metric should be consistent with this picture. This would require $g_{uRe(w)} = 0$.

For the deformations Q_1 and Q_2 would become non-constant and they should depend on the second light-like coordinate v only so that only g_{uu} and g_{uv} and $g_{u\bar{v}}$ receive contributions which vanish. This would give rise to the analogs of Virasoro conditions guaranteeing that T is a tensor of form $(1, 1)$ in both M^2 and E^2 indices and that there are no cross components in the induced metric. A more general formulation states that energy momentum tensor satisfies these conditions. The conditions on T might be equivalent with the conditions for g and G separately.

4. Einstein's equations provide an attractive manner to achieve the vanishing of effective 3-dimensionality of the action. Einstein equations would be second order differential equations and the idea that a deformation of vacuum extremal is in question suggests that the dynamics associated with them is in directions transversal to Y^2 so that only the deformation is dictated partially by Einstein's equations.
5. Lagrangian manifolds do not involve complex structure in any obvious manner. One could however ask whether the deformations could involve complex structure in a natural manner in CP_2 degrees of freedom so that the vanishing of $g_{w\bar{w}}$ would be guaranteed by holomorphy of CP_2 complex coordinate as function of w .

One should get the complex structure in some natural manner: in other words, the complex structure should relate to the geometry of CP_2 somehow. The complex coordinate defined by say $z = P_1 + iQ^1$ for the deformation suggests itself. This would suggest that at the limit when one puts $Q_1 = 0$ one obtains $P_1 = P_1(Re(w))$ for the vacuum extremals and the deformation could be seen as an analytic continuation of real function to region of complex plane. This is in spirit with the algebraic approach. The vanishing of Kähler current requires that the Kähler magnetic field is covariantly constant: $D_z J^{z\bar{z}} = 0$ and $D_{\bar{z}} J^{z\bar{z}} = 0$.

6. One could consider the possibility that the resulting 3-D sub-manifold of CP_2 can be regarded as contact manifold with induced Kähler form non-vanishing in 2-D section with natural complex coordinates. The third coordinate variable- call it s - of the contact manifold and second coordinate of its transversal section would depend on time space-time coordinates for vacuum extremals. The coordinate associated with the transversal section would be continued to a complex coordinate which is holomorphic function of w and u .
7. The resulting thickened magnetic flux tubes could be seen as another representation of Kähler magnetic flux tubes: at this time as deformations of vacuum flux tubes rather than cosmic strings. For this ansatz it is however difficult to imagine deformations carrying Kähler electric field.

2.10.6 About the interpretation of the generalized conformal algebras

The long-standing challenge has been finding of the direct connection between the super-conformal symmetries assumed in the construction of the geometry of the "world of classical worlds" (WCW) and possible conformal symmetries of field equations. 4-dimensionality and Minkowskian signature have been the basic problems. The recent construction provides new insights to this problem.

1. In the case of string models the quantization of the Fourier coefficients of coordinate variables of the target space gives rise to Kac-Moody type algebra and Virasoro algebra generators are quadratic in these. Also now Kac-Moody type algebra is expected. If one were to perform a

quantization of the coefficients in Laurents series for complex CP_2 coordinates, one would obtain interpretation in terms of $su(3) = u(2) + t$ decomposition, where t corresponds to CP_3 : the oscillator operators would correspond to generators in t and their commutator would give generators in $u(2)$. $SU(3)/SU(2)$ coset representation for Kac-Moody algebra would be in question. Kac-Moody algebra would be associated with the generators in both M^4 and CP_2 degrees of freedom. This kind of Kac-Moody algebra appears in quantum TGD.

2. The constraints on induced metric imply a very close resemblance with string models and a generalization of Virasoro algebra emerges. An interesting question is how the two algebras acting on coordinate and field degrees of freedom relate to the super-conformal algebras defined by the symplectic group of $\delta M_+^4 \times CP_2$ acting on space-like 3-surfaces at boundaries of CD and to the Kac-Moody algebras acting on light-like 3-surfaces. It has been conjectured that these algebras allow a continuation to the interior of space-time surface made possible by its slicing by 2-surfaces parametrized by 2-surfaces. The proposed construction indeed provides this kind of slicings in both M^4 and CP_2 factor.
3. In the recent case, the algebras defined by the Fourier coefficients of field variables would be Kac-Moody algebras. Virasoro algebra acting on preferred coordinates would be expressed in terms of the Kac-Moody algebra in the standard Sugawara construction applied in string models. The algebra acting on field space would be analogous to the conformal algebra assignable to the symplectic algebra so that also symplectic algebra is present. Stringy pragmatist could imagine quantization of symplectic algebra by replacing CP_2 coordinates in the expressions of Hamiltonians with oscillator operators. This description would be counterpart for the construction of spinor harmonics in WCW and might provide some useful insights.
4. For given type of space-time surface either CP_2 or M^4 corresponds to Kac-Moody algebra but not both. From the point of view of quantum TGD it looks as that something were missing. An analogous problem was encountered at GRT limit of TGD [L8]. When Euclidian space-time regions are allowed Einstein-Maxwell action is able to mimic standard model with a surprising accuracy but there is a problem: one obtains either color charges or M^4 charges but not both. Perhaps it is not enough to consider either CP_2 type vacuum extremal or its exterior but both to describe particle: this would give the direct product of the Minkowskian and Euclidian algebras acting on tensor product. This does not however seem to be consistent with the idea that the two descriptions are duality related (the analog of T-duality).

2.11 Do geometric invariants of preferred extremals define topological invariants of space-time surface and code for quantum physics?

The recent progress in the understanding of preferred extremals [K11] led to a reduction of the field equations to conditions stating for Euclidian signature the existence of Kähler metric. The resulting conditions are a direct generalization of corresponding conditions emerging for the string world sheet and stating that the 2-metric has only non-diagonal components in complex/hypercomplex coordinates. Also energy momentum of Kähler action and has this characteristic (1,1) tensor structure. In Minkowskian signature one obtains the analog of 4-D complex structure combining hyper-complex structure and 2-D complex structure.

The construction lead also to the understanding of how Einstein's equations with cosmological term follow as a consistency condition guaranteeing that the covariant divergence of the Maxwell's energy momentum tensor assignable to Kähler action vanishes. This gives $T = kG + \Lambda g$. By taking trace a further condition follows from the vanishing trace of T :

$$R = \frac{4\Lambda}{k} . \quad (2.11.1)$$

That any preferred extremal should have a constant Ricci scalar proportional to cosmological constant is very strong prediction. Note that the accelerating expansion of the Universe would support positive

value of Λ . Note however that both Λ and $k \propto 1/G$ are both parameters characterizing one particular preferred extremal. One could of course argue that the dynamics allowing only constant curvature space-times is too simple. The point is however that particle can topologically condense on several space-time sheets meaning effective superposition of various classical fields defined by induced metric and spinor connection.

The following considerations demonstrate that preferred extremals can be seen as canonical representatives for the constant curvature manifolds playing central role in Thurston's geometrization theorem [A34] known also as hyperbolization theorem implying that geometric invariants of space-time surfaces transform to topological invariants. The generalization of the notion of Ricci flow to Maxwell flow in the space of metrics and further to Kähler flow for preferred extremals in turn gives a rather detailed vision about how preferred extremals organize to one-parameter orbits. It is quite possible that Kähler flow is actually discrete. The natural interpretation is in terms of dissipation and self organization.

Quantum classical correspondence suggests that this line of thought could be continued even further: could the geometric invariants of the preferred extremals code not only for space-time topology but also for quantum physics? How to calculate the correlation functions and coupling constant evolution has remained a basic unresolved challenge of quantum TGD. Could the correlation functions be reduced to statistical geometric invariants of preferred extremals? The latest (means the end of 2012) and perhaps the most powerful idea hitherto about coupling constant evolution is quantum classical correspondence in statistical sense stating that the statistical properties of a preferred extremal in quantum superposition of them are same as those of the zero energy state in question. This principle would be quantum generalization of ergodic theorem stating that the time evolution of a single member of ensemble represents the ensemble statistically. This principle would allow to deduce correlation functions and S-matrix from the statistical properties of single preferred extremal alone using classical intuition. Also coupling constant evolution would be coded by the statistical properties of the representative preferred extremal.

2.11.1 Preferred extremals of Kähler action as manifolds with constant Ricci scalar whose geometric invariants are topological invariants

An old conjecture inspired by the preferred extremal property is that the geometric invariants of space-time surface serve as topological invariants. The reduction of Kähler action to 3-D Chern-Simons terms [K11] gives support for this conjecture as a classical counterpart for the view about TGD as almost topological QFT. The following arguments give a more precise content to this conjecture in terms of existing mathematics.

1. It is not possible to represent the scaling of the induced metric as a deformation of the space-time surface preserving the preferred extremal property since the scale of CP_2 breaks scale invariance. Therefore the curvature scalar cannot be chosen to be equal to one numerically. Therefore also the parameter $R = 4\Lambda/k$ and also Λ and k separately characterize the equivalence class of preferred extremals as is also physically clear.

Also the volume of the space-time sheet closed inside causal diamond CD remains constant along the orbits of the flow and thus characterizes the space-time surface. Λ and even $k \propto 1/G$ can indeed depend on space-time sheet and p-adic length scale hypothesis suggests a discrete spectrum for Λ/k expressible in terms of p-adic length scales: $\Lambda/k \propto 1/L_p^2$ with $p \simeq 2^k$ favored by p-adic length scale hypothesis. During cosmic evolution the p-adic length scale would increase gradually. This would resolve the problem posed by cosmological constant in GRT based theories.

2. One could also see the preferred extremals as 4-D counterparts of constant curvature 3-manifolds in the topology of 3-manifolds. An interesting possibility raised by the observed negative value of Λ is that most 4-surfaces are constant negative curvature 4-manifolds. By a general theorem coset spaces H^4/Γ , where $H^4 = SO(1,4)/SO(4)$ is hyperboloid of M^5 and Γ a torsion free discrete subgroup of $SO(1,4)$ [A11]. It is not clear to me, whether the constant value of Ricci scalar implies constant sectional curvatures and therefore hyperbolic space property. It could happen that the space of spaces with constant Ricci curvature contain a hyperbolic manifold as an especially symmetric representative. In any case, the geometric invariants of hyperbolic metric are topological invariants.

By Mostow rigidity theorem [A20] finite-volume hyperbolic manifold is unique for $D > 2$ and determined by the fundamental group of the manifold. Since the orbits under the Kähler flow preserve the curvature scalar the manifolds at the orbit must represent different imbeddings of one and hyperbolic 4-manifold. In 2-D case the moduli space for hyperbolic metric for a given genus $g > 0$ is defined by Teichmueller parameters and has dimension $6(g - 1)$. Obviously the exceptional character of $D = 2$ case relates to conformal invariance. Note that the moduli space in question plays a key role in p-adic mass calculations [K21].

In the recent case Mostow rigidity theorem could hold true for the Euclidian regions and maybe generalize also to Minkowskian regions. If so then both "topological" and "geometro" in "Topological Geometrodynamics" would be fully justified. The fact that geometric invariants become topological invariants also conforms with "TGD as almost topological QFT" and allows the notion of scale to find its place in topology. Also the dream about exact solvability of the theory would be realized in rather convincing manner.

These conjectures are the main result independent of whether the generalization of the Ricci flow discussed in the sequel exists as a continuous flow or possibly discrete sequence of iterates in the space of preferred extremals of Kähler action. My sincere hope is that the reader could grasp how far reaching these result really are.

2.11.2 Is there a connection between preferred extremals and AdS₄/CFT correspondence?

The preferred extremals satisfy Einstein Maxwell equations with a cosmological constant and have negative scalar curvature for negative value of Λ . 4-D space-times with hyperbolic metric provide canonical representation for a large class of four-manifolds and an interesting question is whether these spaces are obtained as preferred extremals and/or vacuum extremals.

4-D hyperbolic space with Minkowski signature is locally isometric with AdS₄. This suggests at connection with AdS₄/CFT correspondence of M-theory. The boundary of AdS would be now replaced with 3-D light-like orbit of partonic 2-surface at which the signature of the induced metric changes. The metric 2-dimensionality of the light-like surface makes possible generalization of 2-D conformal invariance with the light-like coordinate taking the role of complex coordinate at light-like boundary. AdS could represent a special case of a more general family of space-time surfaces with constant Ricci scalar satisfying Einstein-Maxwell equations and generalizing the AdS₄/CFT correspondence. There is however a strong objection from cosmology: the accelerated expansion of the Universe requires positive value of Λ and favors De Sitter Space dS_4 instead of AdS_4 .

These observations provide motivations for finding whether AdS₄ and/or dS_4 allows an imbedding as a vacuum extremal to $M^4 \times S^2 \subset M^4 \times CP_2$, where S^2 is a homologically trivial geodesic sphere of CP_2 . It is easy to guess the general form of the imbedding by writing the line elements of, M^4 , S^2 , and AdS₄.

1. The line element of M^4 in spherical Minkowski coordinates (m, r_M, θ, ϕ) reads as

$$ds^2 = dm^2 - dr_M^2 - r_M^2 d\Omega^2 . \quad (2.11.2)$$

2. Also the line element of S^2 is familiar:

$$ds^2 = -R^2(d\Theta^2 + \sin^2(\theta)d\Phi^2) . \quad (2.11.3)$$

3. By visiting in Wikipedia one learns that in spherical coordinate the line element of AdS₄/ dS_4 is given by

$$\begin{aligned}
 ds^2 &= A(r)dt^2 - \frac{1}{A(r)}dr^2 - r^2d\Omega^2 , \\
 A(r) &= 1 + \epsilon y^2 , \quad y = \frac{r}{r_0} , \\
 \epsilon &= 1 \text{ for } AdS_4 , \quad \epsilon = -1 \text{ for } dS_4 .
 \end{aligned}
 \tag{2.11.4}$$

4. From these formulas it is easy to see that the ansatz is of the same general form as for the imbedding of Schwarzschild-Nordstöm metric:

$$\begin{aligned}
 m &= \Lambda t + h(y) , \quad r_M = r , \\
 \Theta &= s(y) , \quad \Phi = \omega(t + f(y)) .
 \end{aligned}
 \tag{2.11.5}$$

The non-trivial conditions on the components of the induced metric are given by

$$\begin{aligned}
 g_{tt} &= \Lambda^2 - x^2 \sin^2(\Theta) = A(r) , \\
 g_{tr} &= \frac{1}{r_0} \left[\Lambda \frac{dh}{dy} - x^2 \sin^2(\theta) \frac{df}{dr} \right] = 0 , \\
 g_{rr} &= \frac{1}{r_0^2} \left[\left(\frac{dh}{dy} \right)^2 - 1 - x^2 \sin^2(\theta) \left(\frac{df}{dy} \right)^2 - R^2 \left(\frac{d\Theta}{dy} \right)^2 \right] = -\frac{1}{A(r)} , \\
 x &= R\omega .
 \end{aligned}
 \tag{2.11.6}$$

By some simple algebraic manipulations one can derive expressions for $\sin(\Theta)$, df/dr and dh/dr .

1. For $\Theta(r)$ the equation for g_{tt} gives the expression

$$\begin{aligned}
 \sin(\Theta) &= \pm \frac{P^{1/2}}{x} , \\
 P &= \Lambda^2 - A = \Lambda^2 - 1 - \epsilon y^2 .
 \end{aligned}
 \tag{2.11.7}$$

The condition $0 \leq \sin^2(\Theta) \leq 1$ gives the conditions

$$\begin{aligned}
 (\Lambda^2 - x^2 - 1)^{1/2} \leq y &\leq (\Lambda^2 - 1)^{1/2} && \text{for } \epsilon = 1 \text{ (} AdS_4 \text{)} , \\
 (-\Lambda^2 + 1)^{1/2} \leq y &\leq (x^2 + 1 - \Lambda^2)^{1/2} && \text{for } \epsilon = -1 \text{ (} dS_4 \text{)} .
 \end{aligned}
 \tag{2.11.8}$$

Only a spherical shell is possible in both cases. The model for the final state of star considered in [K85] predicted similar layer layer like structure and inspired the proposal that stars quite generally have an onionlike structure with radii of various shells characterize by p-adic length scale hypothesis and thus coming in some powers of $\sqrt{2}$. This brings in mind also Titius-Bode law.

2. From the vanishing of g_{tr} one obtains

$$\frac{dh}{dy} = \frac{P}{\Lambda} \frac{df}{dy} .
 \tag{2.11.9}$$

3. The condition for g_{rr} gives

$$\left(\frac{df}{dy}\right)^2 = \frac{r_0^2}{AP} [A^{-1} - R^2 \left(\frac{d\Theta}{dy}\right)^2] . \quad (2.11.10)$$

Clearly, the right-hand side is positive if $P \geq 0$ holds true and $Rd\Theta/dy$ is small. One can express $d\Theta/dy$ using chain rule as

$$\left(\frac{d\Theta}{dy}\right)^2 = \frac{x^2 y^2}{P(P-x^2)} . \quad (2.11.11)$$

One obtains

$$\left(\frac{df}{dy}\right)^2 = \Lambda r_0^2 \frac{y^2}{AP} \left[\frac{1}{1+y^2} - x^2 \left(\frac{R}{r_0}\right)^2 \frac{1}{P(P-x^2)} \right] . \quad (2.11.12)$$

The right hand side of this equation is non-negative for certain range of parameters and variable y . Note that for $r_0 \gg R$ the second term on the right hand side can be neglected. In this case it is easy to integrate $f(y)$.

The conclusion is that both AdS_4 and dS^4 allow a local imbedding as a vacuum extremal. Whether also an imbedding as a non-vacuum preferred extremal to $M^4 \times S^2$, S^2 a homologically non-trivial geodesic sphere is possible, is an interesting question.

2.11.3 Generalizing Ricci flow to Maxwell flow for 4-geometries and Kähler flow for space-time surfaces

The notion of Ricci flow has played a key part in the geometrization of topological invariants of Riemann manifolds. I certainly did not have this in mind when I choose to call my unification attempt "Topological Geometrodynamics" but this title strongly suggests that a suitable generalization of Ricci flow could play a key role in the understanding of also TGD.

Ricci flow and Maxwell flow for 4-geometries

The observation about constancy of 4-D curvature scalar for preferred extremals inspires a generalization of the well-known volume preserving Ricci flow [A26] introduced by Richard Hamilton. Ricci flow is defined in the space of Riemann metrics as

$$\frac{dg_{\alpha\beta}}{dt} = -2R_{\alpha\beta} + 2\frac{R_{avg}}{D} g_{\alpha\beta} . \quad (2.11.13)$$

Here R_{avg} denotes the average of the scalar curvature, and D is the dimension of the Riemann manifold. The flow is volume preserving in average sense as one easily checks ($\langle g^{\alpha\beta} dg_{\alpha\beta}/dt \rangle = 0$). The volume preserving property of this flow allows to intuitively understand that the volume of a 3-manifold in the asymptotic metric defined by the Ricci flow is topological invariant. The fixed points of the flow serve as canonical representatives for the topological equivalence classes of 3-manifolds. These 3-manifolds (for instance hyperbolic 3-manifolds with constant sectional curvatures) are highly symmetric. This is easy to understand since the flow is dissipative and destroys all details from the metric.

What happens in the recent case? The first thing to do is to consider what might be called Maxwell flow in the space of all 4-D Riemann manifolds allowing Maxwell field.

1. First of all, the vanishing of the trace of Maxwell's energy momentum tensor codes for the volume preserving character of the flow defined as

$$\frac{dg_{\alpha\beta}}{dt} = T_{\alpha\beta} . \quad (2.11.14)$$

Taking covariant divergence on both sides and assuming that d/dt and D_α commute, one obtains that $T^{\alpha\beta}$ is divergenceless.

This is true if one assumes Einstein's equations with cosmological term. This gives

$$\frac{dg_{\alpha\beta}}{dt} = kG_{\alpha\beta} + \Lambda g_{\alpha\beta} = kR_{\alpha\beta} + \left(-\frac{kR}{2} + \Lambda\right)g_{\alpha\beta} . \quad (2.11.15)$$

The trace of this equation gives that the curvature scalar is constant. Note that the value of the Kähler coupling strength plays a highly non-trivial role in these equations and it is quite possible that solutions exist only for some critical values of α_K . Quantum criticality should fix the allow value triplets (G, Λ, α_K) apart from overall scaling

$$(G, \Lambda, \alpha_K) \rightarrow (xG, \Lambda/x, x\alpha_K) .$$

Fixing the value of G fixes the values remaining parameters at critical points. The rescaling of the parameter t induces a scaling by x .

2. By taking trace one obtains the already mentioned condition fixing the curvature to be constant, and one can write

$$\frac{dg_{\alpha\beta}}{dt} = kR_{\alpha\beta} - \Lambda g_{\alpha\beta} . \quad (2.11.16)$$

Note that in the recent case $R_{avg} = R$ holds true since curvature scalar is constant. The fixed points of the flow would be Einstein manifolds [A4, A40] satisfying

$$R_{\alpha\beta} = \frac{\Lambda}{k} g_{\alpha\beta} \quad (2.11.17)$$

3. It is by no means obvious that continuous flow is possible. The condition that Einstein-Maxwell equations are satisfied might pick up from a completely general Maxwell flow a discrete subset as solutions of Einstein-Maxwell equations with a cosmological term. If so, one could assign to this subset a sequence of values t_n of the flow parameter t .
4. I do not know whether 3-dimensionality is somehow absolutely essential for getting the topological classification of closed 3-manifolds using Ricci flow. This ignorance allows me to pose some innocent questions. Could one have a canonical representation of 4-geometries as spaces with constant Ricci scalar? Could one select one particular Einstein space in the class four-metrics and could the ratio Λ/k represent topological invariant if one normalizes metric or curvature scalar suitably. In the 3-dimensional case curvature scalar is normalized to unity. In the recent case this normalization would give $k = 4\Lambda$ in turn giving $R_{\alpha\beta} = g_{\alpha\beta}/4$. Does this mean that there is only single fixed point in local sense, analogous to black hole toward which all geometries are driven by the Maxwell flow? Does this imply that only the 4-volume of the original space would serve as a topological invariant?

Maxwell flow for space-time surfaces

One can consider Maxwell flow for space-time surfaces too. In this case Kähler flow would be the appropriate term and provides families of preferred extremals. Since space-time surfaces inside CD are the basic physical objects in TGD framework, a possible interpretation of these families would be as flows describing physical dissipation as a four-dimensional phenomenon polishing details from the space-time surface interpreted as an analog of Bohr orbit.

1. The flow is now induced by a vector field $j^k(x, t)$ of the space-time surface having values in the tangent bundle of imbedding space $M^4 \times CP_2$. In the most general case one has Kähler flow without the Einstein equations. This flow would be defined in the space of all space-time surfaces or possibly in the space of all extremals. The flow equations reduce to

$$h_{kl}D_\alpha j^k(x, t)D_\beta h^l = \frac{1}{2}T_{\alpha\beta} . \quad (2.11.18)$$

The left hand side is the projection of the covariant gradient $D_\alpha j^k(x, t)$ of the flow vector field $j^k(x, t)$ to the tangent space of the space-time surface. D_{alpha} is covariant derivative taking into account that j^k is imbedding space vector field. For a fixed point space-time surface this projection must vanish assuming that this space-time surface reachable. A good guess for the asymptotia is that the divergence of Maxwell energy momentum tensor vanishes and that Einstein's equations with cosmological constant are well-defined.

Asymptotes corresponds to vacuum extremals. In Euclidian regions CP_2 type vacuum extremals and in Minkowskian regions to any space-time surface in any 6-D sub-manifold $M^4 \times Y^2$, where Y^2 is Lagrangian sub-manifold of CP_2 having therefore vanishing induced Kähler form. Symplectic transformations of CP_2 combined with diffeomorphisms of M^4 give new Lagrangian manifolds. One would expect that vacuum extremals are approached but never reached at second extreme for the flow.

If one assumes Einstein's equations with a cosmological term, allowed vacuum extremals must be Einstein manifolds. For CP_2 type vacuum extremals this is the case. It is quite possible that these fixed points do not actually exist in Minkowskian sector, and could be replaced with more complex asymptotic behavior such as limit, chaos, or strange attractor.

2. The flow could be also restricted to the space of preferred extremals. Assuming that Einstein Maxwell equations indeed hold true, the flow equations reduce to

$$h_{kl}D_\alpha j^k(x, t)\partial_\beta h^l = \frac{1}{2}(kR_{\alpha\beta} - \Lambda g_{\alpha\beta}) . \quad (2.11.19)$$

Preferred extremals would correspond to a fixed sub-manifold of the general flow in the space of all 4-surfaces.

3. One can also consider a situation in which $j^k(x, t)$ is replaced with $j^k(h, t)$ defining a flow in the entire imbedding space. This assumption is probably too restrictive. In this case the equations reduce to

$$(D_r j_l(x, t) + D_l j_r)\partial_\alpha h^r \partial_\beta h^l = kR_{\alpha\beta} - \Lambda g_{\alpha\beta} . \quad (2.11.20)$$

Here D_r denotes covariant derivative. Asymptotia is achieved if the tensor $D_k j_l + D_l j_k$ becomes orthogonal to the space-time surface. Note for that Killing vector fields of H the left hand side vanishes identically. Killing vector fields are indeed symmetries of also asymptotic states.

It must be made clear that the existence of a continuous flow in the space of preferred extremals might be too strong a condition. Already the restriction of the general Maxwell flow in the space of metrics to solutions of Einstein-Maxwell equations with cosmological term might lead to discretization, and the assumption about representability as 4-surface in $M^4 \times CP_2$ would give a further condition reducing the number of solutions. On the other hand, one might consider a possibility of a continuous flow in the space of constant Ricci scalar metrics with a fixed 4-volume and having hyperbolic spaces as the most symmetric representative.

Dissipation, self organization, transition to chaos, and coupling constant evolution

A beautiful connection with concepts like dissipation, self-organization, transition to chaos, and coupling constant evolution suggests itself.

1. It is not at all clear whether the vacuum extremal limits of the preferred extremals can correspond to Einstein spaces except in special cases such as CP_2 type vacuum extremals isometric with CP_2 . The imbeddability condition however defines a constraint force which might well force asymptotically more complex situations such as limit cycles and strange attractors. In ordinary dissipative dynamics an external energy feed is essential prerequisite for this kind of non-trivial self-organization patterns.

In the recent case the external energy feed could be replaced by the constraint forces due to the imbeddability condition. It is not too difficult to imagine that the flow (if it exists!) could define something analogous to a transition to chaos taking place in a stepwise manner for critical values of the parameter t . Alternatively, these discrete values could correspond to those values of t for which the preferred extremal property holds true for a general Maxwell flow in the space of 4-metrics. Therefore the preferred extremals of Kähler action could emerge as one-parameter (possibly discrete) families describing dissipation and self-organization at the level of space-time dynamics.

2. For instance, one can consider the possibility that in some situations Einstein's equations split into two mutually consistent equations of which only the first one is independent

$$\begin{aligned} xJ^\alpha{}_\nu J^{\nu\beta} &= R^{\alpha\beta} , \\ L_K &= xJ^\alpha{}_\nu J^{\nu\beta} = 4\Lambda , \\ x &= \frac{1}{16\pi\alpha_K} . \end{aligned} \tag{2.11.21}$$

Note that the first equation indeed gives the second one by tracing. This happens for CP_2 type vacuum extremals.

Kähler action density would reduce to cosmological constant which should have a continuous spectrum if this happens always. A more plausible alternative is that this holds true only asymptotically. In this case the flow equation could not lead arbitrary near to vacuum extremal, and one can think of situation in which $L_K = 4\Lambda$ defines an analog of limiting cycle or perhaps even strange attractor. In any case, the assumption would allow to deduce the asymptotic value of the action density which is of utmost importance from calculational point of view: action would be simply $S_K = 4\Lambda V_4$ and one could also say that one has minimal surface with Λ taking the role of string tension.

3. One of the key ideas of TGD is quantum criticality implying that Kähler coupling strength is analogous to critical temperature. Second key idea is that p-adic coupling constant evolution represents discretized version of continuous coupling constant evolution so that each p-adic prime would correspond a fixed point of ordinary coupling constant evolution in the sense that the 4-volume characterized by the p-adic length scale remains constant. The invariance of the geometric and thus geometric parameters of hyperbolic 4-manifold under the Kähler flow would conform with the interpretation as a flow preserving scale assignable to a given p-adic prime. The continuous evolution in question (if possible at all!) might correspond to a fixed p-adic

prime. Also the hierarchy of Planck constants relates to this picture naturally. Planck constant $\hbar_{eff} = n\hbar$ corresponds to a multi-furcation generating n-sheeted structure and certainly affecting the fundamental group.

4. One can of course question the assumption that a continuous flow exists. The property of being a solution of Einstein-Maxwell equations, imbeddability property, and preferred extremal property might allow only discrete sequences of space-time surfaces perhaps interpretable as orbit of an iterated map leading gradually to a fractal limit. This kind of discrete sequence might be also be selected as preferred extremals from the orbit of Maxwell flow without assuming Einstein-Maxwell equations. Perhaps the discrete p-adic coupling constant evolution could be seen in this manner and be regarded as an iteration so that the connection with fractality would become obvious too.

Does a 4-D counterpart of thermodynamics make sense?

The interpretation of the Kähler flow in terms of dissipation, the constancy of R , and almost constancy of L_K suggest an interpretation in terms of 4-D variant of thermodynamics natural in zero energy ontology (ZEO), where physical states are analogs for pairs of initial and final states of quantum event are quantum superpositions of classical time evolutions. Quantum theory becomes a "square root" of thermodynamics so that 4-D analog of thermodynamics might even replace ordinary thermodynamics as a fundamental description. If so this 4-D thermodynamics should be qualitatively consistent with the ordinary 3-D thermodynamics.

1. The first naive guess would be the interpretation of the action density L_K as an analog of energy density $e = E/V_3$ and that of R as the analog to entropy density $s = S/V_3$. The asymptotic states would be analogs of thermodynamical equilibria having constant values of L_K and R .
2. Apart from an overall sign factor ϵ to be discussed, the analog of the first law $de = Tds - pdV/V$ would be

$$dL_K = kdR + \Lambda \frac{dV_4}{V_4} .$$

One would have the correspondences $S \rightarrow \epsilon RV_4$, $e \rightarrow \epsilon L_K$ and $k \rightarrow T$, $p \rightarrow -\Lambda$. $k \propto 1/G$ indeed appears formally in the role of temperature in Einstein's action defining a formal partition function via its exponent. The analog of second law would state the increase of the magnitude of ϵRV_4 during the Kähler flow.

3. One must be very careful with the signs and discuss Euclidian and Minkowskian regions separately. Concerning purely thermodynamic aspects at the level of vacuum functional Euclidian regions are those which matter.
 - (a) For CP_2 type vacuum extremals $L_K \propto E^2 + B^2$, $R = \Lambda/k$, and Λ are positive. In thermodynamical analogy for $\epsilon = 1$ this would mean that pressure is negative.
 - (b) In Minkowskian regions the value of $R = \Lambda/k$ is negative for $\Lambda < 0$ suggested by the large abundance of 4-manifolds allowing hyperbolic metric and also by cosmological considerations. The asymptotic formula $L_K = 4\Lambda$ considered above suggests that also Kähler action is negative in Minkowskian regions for magnetic flux tubes dominating in TGD inspired cosmology: the reason is that the magnetic contribution to the action density $L_K \propto E^2 - B^2$ dominates.

Consider now in more detail the 4-D thermodynamics interpretation in Euclidian and Minkowskian regions assuming that the the evolution by quantum jumps has Kähler flow as a space-time correlate.

1. In Euclidian regions the choice $\epsilon = 1$ seems to be more reasonable one. In Euclidian regions $-\Lambda$ as the analog of pressure would be negative, and asymptotically (that is for CP_2 type vacuum extremals) its value would be proportional to $\Lambda \propto 1/GR^2$, where R denotes CP_2 radius defined by the length of its geodesic circle.

A possible interpretation for negative pressure is in terms of string tension effectively inducing negative pressure (note that the solutions of the modified Dirac equation indeed assign a string to the wormhole contact). The analog of the second law would require the increase of RV_4 in quantum jumps. The magnitudes of L_K , R , V_4 and Λ would be reduced and approach their asymptotic values. In particular, V_4 would approach asymptotically the volume of CP_2 .

2. In Minkowskian regions Kähler action contributes to the vacuum functional a phase factor analogous to an imaginary exponent of action serving in the role of Morse function so that thermodynamics interpretation can be questioned. Despite this one can check whether thermodynamic interpretation can be considered. The choice $\epsilon = -1$ seems to be the correct choice now. $-\Lambda$ would be analogous to a negative pressure whose gradually decreases. In 3-D thermodynamics it is natural to assign negative pressure to the magnetic flux tube like structures as their effective string tension defined by the density of magnetic energy per unit length. $-R \geq 0$ would entropy and $-L_K \geq 0$ would be the analog of energy density.

$R = \Lambda/k$ and the reduction of Λ during cosmic evolution by quantum jumps suggests that the larger the volume of CD and thus of (at least) Minkowskian space-time sheet the smaller the negative value of Λ .

Assume the recent view about state function reduction explaining how the arrow of geometric time is induced by the quantum jump sequence defining experienced time [K6]. According to this view zero energy states are quantum superpositions over CD s of various size scales but with common tip, which can correspond to either the upper or lower light-like boundary of CD . The sequence of quantum jumps the gradual increase of the average size of CD in the quantum superposition and therefore that of average value of V_4 . On the other hand, a gradual decrease of both $-L_K$ and $-R$ looks physically very natural. If Kähler flow describes the effect of dissipation by quantum jumps in ZEO then the space-time surfaces would gradually approach nearly vacuum extremals with constant value of entropy density $-R$ but gradually increasing 4-volume so that the analog of second law stating the increase of $-RV_4$ would hold true.

3. The interpretation of $-R > 0$ as negentropy density assignable to entanglement is also possible and is consistent with the interpretation in terms of second law. This interpretation would only change the sign factor ϵ in the proposed formula. Otherwise the above arguments would remain as such.

2.11.4 Could correlation functions, S-matrix, and coupling constant evolution be coded the statistical properties of preferred extremals?

Quantum classical correspondence states that all aspects of quantum states should have correlates in the geometry of preferred extremals. In particular, various elementary particle propagators should have a representation as properties of preferred extremals. This would allow to realize the old dream about being able to say something interesting about coupling constant evolution although it is not yet possible to calculate the M-matrices and U-matrix. Hitherto everything that has been said about coupling constant evolution has been rather speculative arguments except for the general vision that it reduces to a discrete evolution defined by p-adic length scales. General first principle definitions are however much more valuable than ad hoc guesses even if the latter give rise to explicit formulas.

In quantum TGD and also at its QFT limit various correlation functions in given quantum state should code for its properties. By quantum classical correspondence these correlation functions should have counterparts in the geometry of preferred extremals. Even more: these classical counterparts for a given preferred extremal ought to be identical with the quantum correlation functions for the superposition of preferred extremals. This correspondence could be called quantum ergodicity by its analogy with ordinary ergodicity stating that the member of ensemble becomes representative of ensemble.

1. The marvelous implication of quantum ergodicity would be that one could calculate everything solely classically using the classical intuition - the only intuition that we have. Quantum ergodicity would also solve the paradox raised by the quantum classical correspondence for momentum eigenstates. Any preferred extremal in their superposition defining momentum eigenstate should code for the momentum characterizing the superposition itself. This is indeed possible if every

extremal in the superposition codes the momentum to the properties of classical correlation functions which are identical for all of them.

2. The only manner to possibly achieve quantum ergodicity is in terms of the statistical properties of the preferred extremals. It should be possible to generalize the ergodic theorem stating that the properties of statistical ensemble are represented by single space-time evolution in the ensemble of time evolutions. Quantum superposition of classical worlds would effectively reduce to single classical world as far as classical correlation functions are considered. The notion of finite measurement resolution suggests that one must state this more precisely by adding that classical correlation functions are calculated in a given UV and IR resolutions meaning UV cutoff defined by the smallest CD and IR cutoff defined by the largest CD present.
3. The skeptic inside me immediately argues that TGD Universe is 4-D spin glass so that this quantum ergodic theorem must be broken. In the case of the ordinary spin classes one has not only statistical average for a fixed Hamiltonian but a statistical average over Hamiltonians. There is a probability distribution over the coupling parameters appearing in the Hamiltonian. Maybe the quantum counterpart of this is needed to predict the physically measurable correlation functions.

Could this average be an ordinary classical statistical average over quantum states with different classical correlation functions? This kind of average is indeed taken in density matrix formalism. Or could it be that the square root of thermodynamics defined by ZEO actually gives automatically rise to this average? The eigenvalues of the "hermitian square root" of the density matrix would code for components of the state characterized by different classical correlation functions. One could assign these contributions to different "phases".

4. Quantum classical correspondence in statistical sense would be very much like holography (now individual classical state represents the entire quantum state). Quantum ergodicity would pose a rather strong constraint on quantum states. This symmetry principle could actually fix the spectrum of zero energy states to a high degree and fix therefore the M-matrices given by the product of hermitian square root of density matrix and unitary S-matrix and unitary U-matrix having M-matrices as its orthonormal rows.
5. In TGD inspired theory of consciousness the counterpart of quantum ergodicity is the postulate that the space-time geometry provides a symbolic representation for the quantum states and also for the contents of consciousness assignable to quantum jumps between quantum states. Quantum ergodicity would realize this strongly self-referential looking condition. The positive and negative energy parts of zero energy state would be analogous to the initial and final states of quantum jump and the classical correlation functions would code for the contents of consciousness like written formulas code for the thoughts of mathematician and provide a sensory feedback.

How classical correlation functions should be defined?

1. General Coordinate Invariance and Lorentz invariance are the basic constraints on the definition. These are achieved for the space-time regions with Minkowskian signature and 4-D M^4 projection if linear Minkowski coordinates are used. This is equivalent with the contraction of the indices of tensor fields with the space-time projections of M^4 Killing vector fields representing translations. Accepting this generalization, there is no need to restrict oneself to 4-D M^4 projection and one can also consider also Euclidian regions identifiable as lines of generalized Feynman diagrams.

Quantum ergodicity very probably however forces to restrict the consideration to Minkowskian and Euclidian space-time regions and various phases associated with them. Also CP_2 Killing vector fields can be projected to space-time surface and give a representation for classical gluon fields. These in turn can be contracted with M^4 Killing vectors giving rise to gluon fields as analogs of graviton fields but with second polarization index replaced with color index.

2. The standard definition for the correlation functions associated with classical time evolution is the appropriate starting point. The correlation function $G_{XY}(\tau)$ for two dynamical variables $X(t)$ and $Y(t)$ is defined as the average $G_{XY}(\tau) = \int_T X(t)Y(t+\tau)dt/T$ over an interval of length

T , and one can also consider the limit $T \rightarrow \infty$. In the recent case one would replace τ with the difference $m_1 - m_2 = m$ of M^4 coordinates of two points at the preferred extremal and integrate over the points of the extremal to get the average. The finite time interval T is replaced with the volume of causal diamond in a given length scale. Zero energy state with given quantum numbers for positive and negative energy parts of the state defines the initial and final states between which the fields appearing in the correlation functions are defined.

3. What correlation functions should be considered? Certainly one could calculate correlation functions for the induced spinor connection given electro-weak propagators and correlation functions for CP_2 Killing vector fields giving correlation functions for gluon fields using the description in terms of Killing vector fields. If one can uniquely separate from the Fourier transform uniquely a term of form $Z/(p^2 - m^2)$ by its momentum dependence, the coefficient Z can be identified as coupling constant squared for the corresponding gauge potential component and one can in principle deduce coupling constant evolution purely classically. One can imagine of calculating spinorial propagators for string world sheets in the same manner. Note that also the dependence on color quantum numbers would be present so that in principle all that is needed could be calculated for a single preferred extremal without the need to construct QFT limit and to introduce color quantum numbers of fermions as spin like quantum numbers (color quantum numbers corresponds to CP_2 partial wave for the tip of the CD assigned with the particle).
4. What about Higgs field? TGD in principle allows scalar and pseudo-scalars which could be called Higgs like states. These states are however not necessary for particle massivation although they can represent particle massivation and must do so if one assumes that QFT limit exist. p-Adic thermodynamics however describes particle massivation microscopically.

The problem is that Higgs like field does not seem to have any obvious space-time correlate. The trace of the second fundamental form is the obvious candidate but vanishes for preferred extremals which are both minimal surfaces and solutions of Einstein Maxwell equations with cosmological constant. If the string world sheets at which all spinor components except right handed neutrino are localized for the general solution ansatz of the modified Dirac equation, the corresponding second fundamental form at the level of imbedding space defines a candidate for classical Higgs field. A natural expectation is that string world sheets are minimal surfaces of space-time surface. In general they are however not minimal surfaces of the imbedding space so that one might achieve a microscopic definition of classical Higgs field and its vacuum expectation value as an average of one point correlation function over the string world sheet.

Many detailed speculations about coupling constant evolution to be discussed in the sections below must be taken as innovative guesses doomed to have the eventual fate of guesses. The notion of quantum ergodicity could however be one of the really deep ideas about coupling constant evolution comparable to the notion of p-adic coupling constant evolution. Quantum Ergodicity (briefly QE) would also state something extremely non-trivial also about the construction of correlation functions and S-matrix. Because this principle is so new, the rest of the chapter does not yet contain any applications of QE. This should not lead the reader to under-estimate the potential power of QE.

2.12 Does thermodynamics have a representation at the level of space-time geometry?

R. Kiehn has proposed what he calls Topological Thermodynamics (TTD) [B47] as a new formulation of thermodynamics. The basic vision is that thermodynamical equations could be translated to differential geometric statements using the notions of differential forms and Pfaffian system [A23]. That TTD differs from TGD by a single letter is not enough to ask whether some relationship between them might exist. Quantum TGD can however in a well-defined sense be regarded as a square root of thermodynamics in zero energy ontology (ZEO) and this leads leads to ask seriously whether TTD might help to understand TGD at deeper level. The thermodynamical interpretation of space-time dynamics would obviously generalize black hole thermodynamics to TGD framework and already earlier some concrete proposals have been made in this direction.

One can raise several questions. Could the preferred extremals of Kähler action code for the square root of thermodynamics? Could induced Kähler gauge potential and Kähler form (essentially Maxwell

field) have formal thermodynamic interpretation? The vacuum degeneracy of Kähler action implies 4-D spin glass degeneracy and strongly suggests the failure of strict determinism for the dynamics of Kähler action for non-vacuum extremals too. Could thermodynamical irreversibility and preferred arrow of time allow to characterize the notion of preferred extremal more sharply?

It indeed turns out that one can translate Kiehn's notions to TGD framework rather straightforwardly.

1. Kiehn's work 1- form corresponds to induced Kähler gauge potential implying that the vanishing of instanton density for Kähler form becomes a criterion of reversibility and irreversibility is localized on the (4-D) "lines" of generalized Feynman diagrams, which correspond to space-like signature of the induced metric. The localization of heat production to generalized Feynman diagrams conforms nicely with the kinetic equations of thermodynamics based on reaction rates deduced from quantum mechanics. It also conforms with Kiehn's vision that dissipation involves topology change.
2. Heat produced in a given generalized Feynman diagram is just the integral of instanton density and the condition that the arrow of geometric time has definite sign classically fixes the sign of produced heat to be positive. In this picture the preferred extremals of Kähler action would allow a trinity of interpretations as non-linear Maxwellian dynamics, thermodynamics, and integrable hydrodynamics.
3. The 4-D spin glass degeneracy of TGD breaking of ergodicity suggests that the notion of global thermal equilibrium is too naive. The hierarchies of Planck constants and of p-adic length scales suggests a hierarchical structure based on *CDs* withing *CDs* at imbedding space level and space-time sheets topologically condensed at larger space-time sheets at space-time level. The arrow of geometric time for quantum states could vary for sub-*CDs* and would have thermodynamical space-time correlates realized in terms of distributions of arrows of geometric time for sub-*CDs*, sub-sub-*CDs*, etc...

The hydrodynamical character of classical field equations of TGD means that field equations reduce to local conservation laws for isometry currents and Kähler gauge current. This requires the extension of Kiehn's formalism to include besides forms and exterior derivative also induced metric, index raising operation transforming 1-forms to vector fields, duality operation transforming k- forms to n-k forms, and divergence which vanishes for conserved currents.

2.12.1 Motivations and background

It is good to begin by discussing the motivations for the geometrization of thermodynamics and by introducing the existing mathematical framework identifying space-time surfaces as preferred extremals of Kähler action.

ZEO and the need for the space-time correlates for square root of thermodynamics

Quantum classical correspondence is basic guiding principle of quantum TGD. In ZEO TGD can be regarded as a complex square root of thermodynamics so that the thermodynamics should have correlates at the level of the geometry of space-time.

1. Zero energy states consist of pairs of positive and negative energy states assignable to opposite boundaries of a causal diamond (*CD*). There is entire hierarchy of *CDs* characterized by their scale coming as an integer multiple of a basic scale (also their Poincare transforms are allowed).
2. In ZEO zero energy states are automatically time-irreversible in the sense that either end of the causal diamond (*CD*) corresponds to a state consisting of single particle states with well-defined quantum numbers. In other words, this end of *CD* carries a prepared state. The other end corresponds to a superposition of states which can have even different particle numbers: this is the case in particle physics experiment typically. State function reduction reduces the second end of *CD* to a prepared state. This process repeats itself. This suggests that the arrow of time or rather, its geometric counterpart which we experience, alternates. This need not however be the case if quantum classical correspondence holds true.

3. To illustrate what I have in mind consider a path towel, which has been been folded forth and back. Assume that the direction in which folding is carried is time direction. Suppose that the inhabitant of bath towel Universe is like the habitant of the famous Flatland and therefore not able to detect the folding of the towel. If the classical dynamics of towel is time irreversible (time corresponds to the direction in which the folding takes place), the inhabitant sees ever lasting irreversible time evolution with single arrow of geometric time identified as time coordinate for the towel: no changes in the arrow of geometric time. If the inhabitant is able to make measurements about 3-D space the situation he or she might be able to see that his time evolution takes place forth and back with respect to the time coordinate of higher-dimensional imbedding space.
4. One might understand the arrow of time - albeit differently as in normal view about the situation - if classical time evolution for the preferred extremals of Kähler action defines a geometric correlate for quantum irreversibility of zero energy states. There are of course other space-time sheets and other *CDs* present and it might be possible to detect the alternation of the arrow of geometric time at imbedding space level by making measurements giving information about their geometric arrows of time [K6].

By quantum classical correspondence one expects that the geometric arrow of time - irreversibility - for zero energy states should have classical counterparts at the level of the dynamics of preferred extremals of Kähler action. What could be this counterpart? Thermodynamical evolution by quantum jumps does not obey ordinary variational principle that would make it deterministic: Negentropy Maximization Principle (NMP) [K51] for state function reductions of system is analogous to Second Law for an ensemble of copies of system and actually implies it. Could one mimic irreversibility by single classical evolution defined by a preferred extremal? Note that the dynamics of preferred extremals is not actually strictly deterministic in the ordinary sense of the word: the reason is the enormous vacuum degeneracy implying 4-D spin glass degeneracy. This makes it possible to mimic not only quantum states but also sequences of quantum jumps by piece-wise deterministic evolution.

Preferred extremals of Kähler action

In Quantum TGD the basic arena of quantum dynamics is "world of classical worlds" (WCW) [K68]. Purely classical spinor fields in this infinite-dimensional space define quantum states of the Universe. General Coordinate Invariance (GCI) implies that classical worlds can be regarded as either 3-surfaces or 4-D space-time surfaces analogous to Bohr orbits. Strong form of GCI implies in ZEO strong form of holography in the sense that the points of WCW effectively correspond to collections of partonic 2-surfaces belonging to both ends of causal diamonds (*CDs*) plus their 4-D tangent space-time data.

Kähler geometry reduces to the notion of Kähler function [K40] and by quantum classical correspondence a good guess is that Kähler function corresponds to so called Kähler action for Euclidian space-time regions. Minkowskian space-time regions give a purely imaginary to Kähler action (square root of metric determinant is imaginary) and this contribution plays the role of Morse function for WCW. Stationary phase approximation implies that in first the approximation the extremals of the Kähler *function* (to be distinguished from preferred extremals of Kähler *action*!) select one particular 3-surface and corresponding classical space-time surface (Bohr orbit) as that defining "classical physics".

GCI implies holography and holography suggests that action reduces to 3-D terms. This is true if one has $j^\mu A_\mu = 0$ in the interior of space-time. If one assumes so called weak form of electric-magnetic duality [K31] at the real and effective boundaries of space-time surface (3-D surfaces at the ends of *CDs* and the light-like 3-surfaces at which the signature of induced 4-metric changes so that 4-metric is degenerate), one obtains a reduction of Kähler action to Chern-Simons terms at the boundaries. TGD reduces to almost topological QFT. "Almost" means that the induced metric does not disappear completely from the theory since it appears in the conditions expressing weak form of electric magnetic duality and in the condition $j^\mu A_\mu = 0$.

The strong form of holography implies effective 2-dimensionality and this suggests the reduction of Chern-Simons terms to 2-dimensional areas of string world sheets and possible of partonic 2-surfaces. This would mean almost reduction to string theory like theory with string tension becoming a dynamic quantity.

Under additional rather general conditions the contributions from Minkowskian and Euclidian regions of space-time surface are apart from the value of coefficient identical at light-like 3-surfaces. At space-like 3-surfaces at the ends of space-time surface they need not be identical.

Quantum classical correspondence suggests that space-time surfaces provide a representation for the square root of thermodynamics and therefore also for thermodynamics. In general relativity black hole thermodynamics suggests the same. This idea is not new in TGD framework. For instance, Hawking-Bekenstein formula for blackbody entropy [B3] allows a p-adic generalization in terms of area of partonic 2-surfaces [K58]. The challenge is to deduce precise form of this correspondence and here Kiehn's topological thermodynamics might help in this task.

2.12.2 Kiehn's topological thermodynamics (TTD)

The basic in the work of Kiehn is that thermodynamics allows a topological formulation in terms of differential geometry.

1. Kiehn introduces also the notions of <http://www22.pair.com/csdc/pdf/irevtors.pdf> Pfaff system and Pfaff dimension as the number of non-vanishing forms in the sequence for given 1-form such as W or Q : $W, dW, W \wedge dW, dW \wedge dW$. Pfaff dimension $D \leq 4$ tells that one can describe W as sum $W = \sum W_k dx^k$ of gradients of D variables. $D = 4$ corresponds to open system, $D = 3$ to a closed system and $W \wedge dW \neq 0$ defines what can be regarded as a chirality. For $D = 2$ chirality vanishes no spontaneous parity breaking.
2. Kiehn's king idea that Pfaffian systems provide a universal description of thermodynamical reversibility. Kiehn introduces heat 1-form Q . System is thermodynamically reversible if Q is integrable. In other words, the condition $Q \wedge dQ = 0$ holds true which implies that one can write $Q = TdS$: Q allows an integrable factor T and is expressible in terms of the gradient of entropy. $Q = TdS$ condition implies that Q correspond to a global flow defined by the coordinate lines of S . This in turn implies that it is possible define phase factors depending on S along the flow line: this relates to macroscopic quantum coherence for macroscopic quantum phases.
3. The first law expressing the work 1-form W as $W = Q - dU = TdS - dU$ for reversible processes. This gives $dW \wedge dW = 0$. The condition $dW \wedge dW \neq 0$ therefore characterizes irreversible processes.
4. Symplectic transformations are natural in Kiehn's framework but not absolutely essential.

Reader is encouraged to get familiar with Kiehn's examples [B47] about the description of various simple thermodynamical systems in this conceptual framework. Kiehn has also worked with the differential topology of electrodynamics and discussed concepts like integrable flows known as Beltrami flows. These flows generalized to TGD framework and are in key role in the construction of proposals for preferred extremals of Kähler action: the basic idea would be that various conserved isometry currents define Beltrami flows so that their flow lines can be associated with coordinate lines.

2.12.3 Attempt to identify TTD in TGD framework

Let us now try to identify TTD or its complex square root in TGD framework.

The role of symplectic transformations

Symplectic transformations are important in Kiehn's approach although they are not a necessary ingredient of it and actually impossible to realize in Minkowski space-time.

1. Symplectic symmetries of WCW induced by symplectic symmetries of CP_2 and light-like boundary of CD are important also in TGD framework [K20] and define the isometries of WCW. As a matter fact, symplectic group parameterizes the quantum fluctuating degrees of freedom and zero modes defining classical variables are symplectic invariants. One cannot assign to entire space-time surfaces symplectic structure although this is possible for partonic 2-surfaces.

2. The symplectic transformations of CP_2 act on the Kähler gauge potential as $U(1)$ gauge transformations formally but modify the shape of the space-time surface. These symplectic transformations are symmetries of Kähler action only in the vacuum sector which as such does not belong to WCW whereas small deformations of vacua belong. Therefore genuine gauge symmetries are not in question. One can of course formally assign to Kähler gauge potential a separate $U(1)$ gauge invariance.
3. Vacuum extremals with at most 2-D CP_2 projection (Lagrangian sub-manifold) form an infinite-dimensional space. Both M^4 diffeomorphisms and symplectic transformations of CP_2 produce new vacuum extremals, whose small deformations are expected to correspond preferred extremals. This gives rise to 4-D spin glass degeneracy [K58] to be distinguished from 4-D gauge degeneracy.

Identification of basic 1-forms of TTD in TGD framework

Consider next the identification of the basic variables which are forms of various degrees in TTD.

1. Kähler gauge potential is analogous to work 1-form W . In classical electrodynamics vector potential indeed has this interpretation. $dW \wedge dW$ is replaced with $J \wedge J$ defining instanton density ($E_K \cdot B_K$ in physicist's notation) for Kähler form and its non-vanishing - or equivalently 4-dimensionality of CP_2 projection of space-time surface - would be the signature of irreversibility. $dJ = 0$ holds true only locally and one can have magnetic monopoles since CP_2 has non-trivial homology. Therefore the non-trivial topology of CP_2 implying that the counterpart of W is not globally defined, brings in non-trivial new element to Kiehn's theory.
2. Chirality $C - S = A \wedge J$ is essentially Chern-Simons 3-form and in ordinary QFT non-vanishing of $C - S$ if present in action - means parity breaking in ordinary quantum field theories. Now one must be very cautious since parity is a symmetry of the imbedding space rather than that of space-time sheet.
3. Pfaff dimension equals to the dimension of CP_2 projection and has been used to classify existing preferred extremals. I have called the extremals with 4-D CP_2 projection chaotic and so called CP_2 vacuum extremals with 4-D CP_2 projection correspond to such extremals. Massless extremals or topological light rays correspond to $D = 2$ as do also cosmic strings. In Euclidian regions preferred extremals with $D = 4$ are possible but not in Minkowskian regions if one accepts effective 3-dimensionality. Here one must keep mind open.

Irreversibility identified as a non-vanishing of the instanton density $J \wedge J$ has a purely geometrical and topological description in TGD Universe if one accepts effective 3-dimensionality.

1. The effective 3-dimensionality for space-time sheets (holography implied by general coordinate invariance) implies that Kähler action reduces to Chern-Simons terms so that the Pfaff dimension is at most $D = 3$ for Minkowskian regions of space-time surface so that they are thermodynamically reversible.
2. For Euclidian regions (say deformations of CP_2 type vacuum extremals) representing orbits of elementary particles and lines of generalized Feynman diagrams $D = 4$ is possible. Therefore Euclidian space-like regions of space-time would be solely responsible for the irreversibility. This is quite strong conclusion but conforms with the standard quantum view about thermodynamics according to which various particle reaction rates deduced from quantum theory appear in kinetic equations giving rise to irreversible dynamics at the level of ensembles. The presence of Morse function coming from Minkowskian regions is natural since square root of thermodynamics is in question. Morse function is analogous to the action in QFTs whereas Kähler function is analogous to Hamiltonian in thermodynamics. Also this conforms with the square root of TTD interpretation.

Instanton current, instanton density, and irreversibility

Classical TGD has the structure of hydrodynamics in the sense that field equations are conservation laws for isometry currents and Kähler current. These are vector fields although induced metric allows to transform them to forms. This aspect should be visible also in thermodynamic interpretation and forces to add to the Kiehn's formulation involving only forms and exterior derivative also induced metric transforming 1-forms to vector fields, the duality mapping 4-k forms and k-forms to each other, and divergence operation.

It was already found that irreversibility and dissipation corresponds locally to a non-vanishing instanton density $J \wedge J$. This form can be regarded as exterior derivative of Chern-Simons 3-form or equivalently as divergence of instanton current.

1. The dual of C-S 3-form given by $*(A \wedge J)$ defines what I have called instanton current. This current is not conserved in general and the interpretation as a heat current would be natural. The exterior derivative of C-S gives instanton density $J \wedge J$. Equivalently, the divergence of instanton current gives the dual of $J \wedge J$ and the integral of instanton density gives the analog of instanton number analogous to the heat generated in a given space-time volume. Note that in Minkowskian regions one can multiply instanton current with a function of CP_2 coordinates without losing closedness property so that infinite number similar conserved currents is possible.

The heat 3-form is expressible in terms of Chern-Simons 3-form and for preferred extremals it would be proportional to the weight sum of Kähler actions from Minkowskian and Euclidian regions (coefficients are purely imaginary and real in these two regions). Instead of single real quantity one would have complex quantity characterizing irreversibility. Complexity would conform with the idea that quantum TGD is complex square root of thermodynamics.

2. The integral of heat 3-form over effective boundaries associated with a given space-time region define the net heat flow from that region. Only the regions defining the lines of generalized Feynman diagrams give rise to non-vanishing heat fluxes. Second law states that one has $\Delta Q \geq 0$. Generalized second law means at the level of quantum classical correspondence would mean that depending on the arrow of geometric time for zero energy state ΔQ is defined as difference between upper and lower or lower and upper boundaries of CD . This condition applied to CD and sub- CD :s would generalize the conditions familiar from hydrodynamics (stating for instance that for shock waves the branch of bifurcation for which the entropy increases is selected). Note that the field equations of TGD are hydrodynamical in the sense that they express conservation of various isometry currents. The naive picture about irreversibility is that classical dynamics generates CP_2 type vacuum extremals so that the number of outgoing lines of generalized Feynman diagram is higher than that of incoming ones. Therefore that the number of space-like 3-surfaces giving rise to Chern-Simons contribution is larger at the end of CD corresponding to the final (negative energy) state.

3. A more precise characterization of the irreversible states involves several non-trivial questions.

- (a) By the failure of strict classical determinism the condition that for a given CD the number outgoing lines is not smaller than incoming lines need not provide a unique manner to fix the preferred extremal when partonic 2-surfaces at the ends are fixed. Could the arrow of geometric time depend on sub- CD as the model for living matter suggests (recall also phase conjugate light rays)?

In ordinary quantum mechanical approach to kinetic equations also the reactions, which decrease entropy are allowed but their weight is smaller in thermal equilibrium. Could this fact be described as a probability distribution for the arrow of time associated for the sub- CD s, sub-sub- CD s, etc... ? Space-time correlates for quantal thermodynamics would be probability distributions for space-time sheets and hierarchy of sub- CD s.

- (b) 4-D spin glass degeneracy suggests breaking of ergodic hypothesis: could this mean that one does not have thermodynamical equilibrium but very large number of spin glass states caused by the frustration for which induced Kähler form provides a representation? Could these states correspond to a varying arrow of geometric time for sub- CD s? Or could different deformed vacuum extremals correspond to different space-time sheets in thermal equilibrium with different thermal parameters.

Also Kähler current and isometry currents are needed

The conservation Kähler current and of isometry currents imply the hydrodynamical character of TGD.

1. The conserved Kähler current j_K is defined as 3-form $j_K = *(d * J)$, where $d * J$ is closed 3-form and defines the counterpart of $d * dW$. Field equations for preferred extremals require $*j_K \wedge A = 0$ satisfied if one Kähler current is proportional to instanton current: $*j_K \propto A \wedge J$. As a consequence Kähler action reduces to 3-dimensional Chern-Simons terms (classical holography) and Minkowskian space-time regions have at most 3-D CP_2 projection (Pfaff dimension $D \leq 3$) so that one has $J \wedge J = 0$ and reversibility. This condition holds true for preferred extremals representing macroscopically the propagation of massless quanta but not Euclidian regions representing quanta themselves and identifiable as basic building bricks of wormhole contacts between Minkowskian space-time sheets.
2. A more general proposal is that all conserved currents transformed to 1-forms using the induced metric (classical gravitation comes into play!) are integrable: in other words, one has $j \wedge dj = 0$ for both isometry currents and Kähler current. This would mean that they are analogous to heat 1-forms in the reversible case and therefore have a representation analogous to $Q = TdS$, $W = PdV$, μdN and the coordinate along flowline defines the analog of S , V , or N (note however that dS, dV, dN would more naturally correspond to 3-forms than 1-forms, see below) A stronger form corresponds to the analog of hydrodynamics for one particle species: all one-forms are proportional (by scalar function) to single 1-form which is $A \wedge J$ (all quantum number flows are parallel to each other).

Questions

There are several questions to be answered.

1. In Darboux coordinates in which one has $A = P_1 dQ^1 + P_2 dQ_2$. The identification of A as counterpart for $W = PdV - \mu dN$ comes first in mind. For thermodynamical equilibria one would have $TdS = dU + W$ translating to $TdS = dU + A$ so that Q for reversible processes would be apart from $U(1)$ gauge transformation equal to the Kähler gauge potential. Symplectic transformations of CP_2 generate $U(1)$ gauge transformations and dU might have interpretation in terms of energy flow induced by this kind of transformation. Recall however that symplectic transformations are not symmetries of space-time surfaces but only of the WCW metric and act on partonic 2-surfaces and their tangent space data as such.
2. Does the conserved Kähler current j_K have any thermodynamical interpretation? Clearly the counterparts of conserved (and also non-conserved quantities) in Kiehn's formulation would be 3-forms with vanishing curl $d(*j_K) = 0$ in conserved case. Therefore it seems impossible to reduce them to 1-forms unless one introduces divergence besides exterior derivative as a basic differential operation.

The hypothesis that the flow lines of these 1-forms associated with j_K vector field are integrable implies that they are gradients apart from the presence of integrating factor. Reduction to a gradient ($j = dU$) means that U satisfies massless d'Alembert equation $d * dU = 0$. Note that local polarization and light-like momentum are gradients of scalar functions which satisfy massless d'Alembert equation for the Minkowskian space-time regions representing propagating of massless quanta.

3. In genuinely 3-dimensional context S, V, N are integrals of 3-forms over 3-surfaces for some current defining 3-form. This is in conflict with Kiehn's description where they are 0-forms. One can imagine three cures and first two ones look
 - (a) The integrability of the flows allows to see them as superposition of independent 1-dimensional flows. This picture would make it natural to regard the TGD counterparts of S, V, N as 0-forms rather than 2-forms. This would also allow to deduce $J \wedge J = 0$ as a reversibility condition using Kiehn's argument.

- (b) Unless one requires integrable flows, one must consider the replacement of $Q = TdS$ resp. $W = PdV$ resp. μdN $Q = TdS$ resp. $W = PdV$ resp. μdN where W , Q , dS , dV , and dN with 3-forms. So that S , V , N would be 2-forms and the 3-integrals of dS , dV , dN over 3-surfaces would reduce to integrals over partonic 2-surfaces, which is of course highly non-trivial but physically natural implication of the effective 2-dimensionality. First law should now read as $*W = T*dS - *dU$ and would give $d*W = dT \wedge *dS + Td*dS + d*dU$. If S and U as 2-forms satisfy massless d'Alembert equation, one obtains $d*W = dT \wedge *dS$ giving $d*W \wedge d*W = 0$ as the reversibility condition. If one replaces $W \leftrightarrow A$ correspondence with $*W \leftrightarrow A$ correspondence, one obtains the vanishing of instanton density as a condition for reversibility. For the preferred extremals having interpretation as massless modes the massless d'Alembert equations are satisfied and it might that this option makes sense and be equivalent with the first option.
- (c) In accordance with the idea that finite measurement resolution is realized at the level of modified Dirac equation, its solutions at lightlike 3-surfaces reduces to solutions restricted to lines connecting partonic 2-surfaces. Could one regard W , Q , dS , dV , and dN as singular one-forms restricted to these lines? The vanishing of instanton density would be obtained as a condition for reversibility only at the braid strands, and one could keep the original view of Kiehn. Note however that the instanton density could be non-vanishing elsewhere unless one develops a separate argument for its vanishing. For instance, the condition that isometries of imbedding space say translations produce braid ends points for which instanton density also vanishes for the reversible situation might be enough.

To sum up, it seems that TTD allows to develop considerable insights about how classical space-time surfaces could code for classical thermodynamics. An essential ingredient seems to be the reduction of the hydrodynamical flows for isometry currents to what might be called perfect flows decomposing to 1-dimensional flows with conservation laws holding true for individual flow lines. An interesting challenge is to find expressions for total heat in terms of temperature and entropy. Blackhole-elementary particle analogy suggest the reduction as well as effective 2-dimensionality suggest the reduction of the integrals of Chern-Simons terms defining total heat flux to two 2-D volume integrals over string world sheets and/or partonic 2-surfaces and this would be quite near to Hawking-Bekenstein formula.

2.13 Robert Kiehn's ideas about Falaco solitons and generation of turbulent wake from TGD perspective

I have been reading two highly interesting articles by Robert Kiehn. The first article has the title "Hydrodynamics wakes and minimal surfaces with fractal boundaries" [B45]. Second article is titled "Instability patterns, wakes and topological limit sets" [B46]. There are very many contacts on TGD inspired vision and its open interpretational problems.

The notion of Falaco soliton has surprisingly close resemblance with Kähler magnetic flux tubes defining fundamental structures in TGD Universe. Fermionic strings are also fundamental structures of TGD accompanying magnetic flux tubes and this supports the vision that these string like objects could allow reduction of various condensed matter phenomena such as sound waves -usually regarded as emergent phenomena allowing only highly phenomenological description - to the fundamental microscopic level in TGD framework. This can be seen as the basic outcome of this article.

Kiehn proposed a new description for the generation of various instability patterns of hydrodynamics flows (Kelvin-Helmholtz and Rayleigh-Taylor instabilities) in terms of hyperbolic dynamics so that a connection with wave phenomena like interference and diffraction would emerge. The role of characteristic surfaces as surfaces of tangential and also normal discontinuities is central for the approach. In TGD framework the characteristic surfaces have as analogs light-like wormhole throats at which the signature of the induced 4-metric changes and these surfaces indeed define boundaries of two phases and of material objects in general. This inspires a more detailed comparison of Kiehn's approach with TGD.

2.13.1 Falaco solitons and TGD

In the first article [B45] Kiehn tells about his basic motivations. The first motivating observations were related to so called Falaco solitons. Second observation was related to the so called mushroom pattern associated with RayleighTaylor instability or fingering instability [B13], which appears in very many contexts, the most familiar being perhaps the mushroom shaped cloud created by a nuclear explosion. The idea was that both structures whose stability is not easy to understand in standard hydrodynamics, could have topological description.

Falaco solitons are very fascinating objects. Kiehn describes in detail the formation and properties in [B45]: anyone possessing swimming pool can repeat these elegant and simple experiments. The vortex string connecting the end singularities - dimpled indentations at the surface of water - is the basic notion. Kiehn asks whether there might be a deeper connection with a model of mesons in which strings connecting quark and antiquark appear. The formation of spiral structures around the end gaps in the initial formative states of Falaco soliton is emphasized and compared to the structure of spiral galaxies. The suggestion is that galaxies could appear as pairs connected by strings.

Kähler magnetic tubes carrying monopole flux are central in TGD and have several interesting resemblances with Falaco solutions.

1. In TGD framework so called cosmic strings fundamental primordial objects. They have 2-D Minkowski space projection and 2-D CP_2 projection so that one can say that there is no space-time in ordinary sense present during the primordial phase. During cosmic evolution their time= constant M^4 projection gradually thickens from ideal string to a magnetic flux tube. Among other things this explains the presence of magnetic fields in all cosmic scale not easy to understand in standard view. The decay of cosmic strings generates visible and dark matter much in the same manner as the decay of inflaton field does in inflationary scenario. One however avoids the many problems of inflationary scenario.

Cosmic strings would contain ordinary matter and dark matter around them like necklace contains pearls along it. Cosmic strings carry Kähler magnetic monopole flux which stabilizes them. The magnetic field energy explains dark energy. Magnetic tension explains the negative "pressure" explaining accelerated expansion. The linear distribution of field energy along cosmic strings gives rise to logarithmic gravitational potential, which explains the constant velocity spectrum of distant stars around galaxy and therefore galactic dark matter.

2. Magnetic flux tubes form a fractal structure and the notion of Falaco soliton has also an analogy in TGD based description of elementary particles. In TGD framework the ends caps of vortices correspond to pairs of wormhole throats connected by short wormhole contact and there is a magnetic flux tube carrying monopole flux at both space-time sheets.

So called modified Dirac equation assigns with this flux tube 1-D closed string and to it string world sheets, which might be 2-D minimal surface of space-time surface [K94]. Rather surprisingly, string model in 4-D space-time emerges naturally in TGD framework and has also very special properties due to the knotting of strings as 1-knots and knotting of string world sheets as 2-knots. Braiding and linking of strings is also involved and make dimension $D=4$ for space-time completely unique.

Both elementary particles and hadron like state are describable in terms of these string like objects. Wormhole throats are the basic building brick of particles which are in the simplest situation two-sheeted structure with wormhole contact structures connecting the sheets and giving rise to one or more closed flux tubes accompanied by closed strings.

2.13.2 Stringy description of condensed matter physics and chemistry?

What is important that magnetic flux tubes and associated string world sheets can also connect wormhole throats associated with different elementary particles in the sense that their boundaries are along light-like wormhole throats assignable to different elementary particles. These string worlds sheets therefore mediate interactions between elementary particles.

1. What these interactions are? *Could string world sheets could provide a microscopic first principle description of condensed matter phenomena* - in particular of sound waves and various waves

analogs of sound waves usually regarded as emergent phenomena requiring phenomenological models of condensed matter?

The hypothesis that this is the case would allow to test basic assumptions of quantum TGD at the level of condensed matter physics. String model in 4-D space-time could describe concrete experimental everyday reality rather than esoteric Planck length scale physics! The phenomena of condensed matter physics often thought to be high level emergent phenomena would have first principle microscopic description at the level of space-time geometry.

2. The idea about stringy reductionism extends also to chemistry. One of the poorly understanding basic notions of molecular chemistry is the formation of valence bond as pairing of two valence electrons belonging to different atoms. Could this pairing correspond to a formation of a closed Kähler magnetic flux tube with two wormhole contacts carrying quantum numbers of electron? Could also Cooper pairs be regarded as this kind of structure with long connecting pair of flux tubes between electron carrying wormhole contacts as has been suggested already earlier?
3. The proposal indeed is that TGD inspired biochemistry and neuroscience indeed has magnetic flux tubes and flux sheets as a key element. For instance, the notion of magnetic body plays a key role in TGD inspired view about EEG and magnetic flux tubes represent braid strands in the model for DNA-cell membrane system as topological quantum computer [K29].

One can argue that this is not a totally new idea: basically one particular variant of holography¹ is in question and follows in TGD framework from general coordinate invariance alone: the geometry of world of classical worlds must assign to a given 3-surface a unique space-time surface.

1. The fashionable manner to realize holography is by replacing 4-D space-time with 10-D one. String world sheets in 10-D space-time $AdS_5 - S_5$ connecting the points of 4+5-D boundary of $AdS_5 - S_5$ are hoped to provide a dual description of even condensed matter phenomena in the case that the system is described by a theory enjoying conformal invariance in 4-D sense.
2. In TGD framework holography is much more concrete: 3-D light-like 3-surfaces (giving rise to generalized conformal invariance by their metric 2-dimensionality) are enough. One has actually a strong form of holography stating that 2-D partonic 2-surfaces plus their 4-D tangent space data are enough. Partonic 2-surfaces define the ends of light-like 3-surfaces at the ends of space-time surface at the light-like 7-D boundaries of causal diamonds. 10-D space is replaced with the familiar 4-D space-time and 4+5-D boundary with end 2-D ends of 3-D light-like wormhole orbits (plus 4-D tangent space data). These partonic 2-surfaces are highly analogous to the 2-D sections of your characteristic surfaces.

Consider now how sound waves as and various oscillations of this kind could be understood in terms of string world sheets. String world sheets have both geometric and fermionic degrees of freedom.

1. A good first guess is that string world sheet is minimal surface in space-time - this does not mean minimal surface property in imbedding space and the non-vanishing second fundamental form in particular its CP_2 part should have physical meaning - maybe the parameter that would be called Higgs vacuum expectation in QFT limit of TGD could relate to it.
2. Another possibility that I have proposed is that a minimal surface of imbedding space (not the minimal surface is geometric analog for a solution of massless wave equation) but in the effective metric defined by the anti-commutators of modified gamma matrices defined by the canonical momentum densities of Kähler action is in question: in this case one might even dream about the possibility that the analog of light-velocity defined by the effective metric has interpretation as sound velocity.

For string world sheets as minimal surfaces of X^4 (the first option) oscillations would propagate with light-velocity but as one adds massive particle momenta at wormhole throats defining their ends the situation changes due to the additional inertia making impossible propagation with light-velocity.

¹The equivalent of holography emerged from the construction of the Kähler geometry of "world of classical worlds" as an implication of general coordinate invariance around 1990, about five years before it was introduced by t'Hooft and Susskind.

Consideration of the situation for ordinary non-relativistic condensed matter string with masses at ends as a simple example, the velocity of propagation is in the first naive estimate just square root of the ratio of the magnetic energy of string portion to its total energy which also concludes the mass at its ends. Kähler magnetic energy is given by string tension which has a spectrum determined by p-adic length scale hypothesis so that one ends up with a rough quantitative picture and coil understand the dependence of the sound velocity on temperature.

In TGD framework massless quanta moving in different directions correspond to different space-time sheets: linear superposition for fields is replaced with a set theoretic union and effects superpose instead of fields. This would hold true also for sound waves which would always be restricted at stringy world sheets: superposition can make sense only for wave moving in exactly the same direction. This of course conforms with the properties of phonons so that Bohr orbitology would be realized for sound waves and ordinary description of sound waves would be only an approximation. The fundamental difference between light and sound defining fundamental qualia would be the dimension of the quanta as geometric structures.

2.13.3 New manner to understand the generation of turbulent wake

Kiehn proposes a new manner to understand the generation of turbulent wake [B46]. The dynamics generating it would be that of hyperbolic wave equation rather than diffusive parabolic or elliptic dynamics. The decay of the turbulence would however obey the diffusive parabolic dynamics. Therefore sound velocity and supersonic velocities would be involved with the generation of the turbulence.

Kiehn considers Landau's nonlinear model for a scalar potential of velocity in the case of 2-D compressible isentropic fluid as an example. The wave equation is given by

$$(c^2 - \Phi_x^2)\Phi_{xx} + (c^2 - \Phi_y^2)\Phi_{yy} - 2\Phi_x\Phi_y\Phi_{xy} = 0 . \quad (2.13.1)$$

Here c denotes sound velocity and velocity is given by $v = \nabla\Phi$. 3-D generalization is obvious. This partial differential equation for the velocity potential is quasi-linear equation of the form

$$A\Phi_{\eta\eta} + 2B\Phi_{\eta\xi} + C\Phi_{\xi\xi} = 0 . \quad (2.13.2)$$

The characteristic surfaces contain imbedded curves which are given by solutions to ordinary differential equations

$$\frac{d\eta}{d\xi} = \frac{B \pm (B^2 - AC)^{1/2}}{C} . \quad (2.13.3)$$

Real solutions are possible when the argument of the square root is positive. This is true when the local velocity exceeds the local characteristic speed c . These characteristic lines combine to form characteristic surfaces.

Velocity field would be compressible ($\nabla \cdot v \neq 0$) but irrotational ($\nabla \times v = 0$) in this approach whereas in standard approach velocity field would be incompressible ($\nabla \cdot v = 0$) but irrotational ($\nabla \times v \neq 0$). There would be two phases in which these two different options would be realized and at the boundary the dynamics would be both in-compressible and irrotational and these boundaries would correspond to characteristic surfaces which are minimal surfaces which evolve with time somehow. The presence of scalar function satisfying Laplace equation ($\nabla^2\Phi = 0$) would serve as a signature of this.

The emergence of this hyperbolic dynamics would explain the sharpness and long-lived character of the singular structures. Kiehn also proposes that the formation of wake could have analogies with diffraction and interference - basic aspects of wave motion. This picture does not conform with standard view which assumes diffusive parabolic or elliptic dynamics as the origin of the wake turbulence.

Characteristic surfaces and light-like wormhole throat orbits

Characteristic surface is key notion in Kiehn's approach and he suggests that the creation of wakes relies on hyperbolic dynamics in restricted regions [B46]. If I have understood correctly, the boundaries of vortices created in the process could be seen as this kind of characteristic surfaces: some physical quantities would have tangential discontinuities at them since a boundary between different phases (fluid and air) would be in question.

Another situation corresponds to a shock wave in which case there is a flow of matter through the characteristic surface. Also boundary patterns associated with Kelvin-Helmholtz instability (formation of waves due to wind and their breaking) and Rayleigh-Taylor instability (the formation of mushroom like fingers of heavier substance resting above lighter one).

The proposal of Kiehn is that the characteristic minimal surfaces have the following general form:

$$\begin{aligned} u &= \frac{d\eta}{ds} = A(\rho) \times \sin(Q(s)) \quad , \quad v = \frac{d\eta}{ds} = -A(\rho) \times \cos(Q(s)) \quad , \\ w &= F(u, v) = Q(u/v = s) \text{ per,} \quad Q(s) = \arctan(s) \quad . \end{aligned} \quad (2.13.4)$$

If $F(u, v)$ satisfies the equation

$$(1 + F_v^2)F_{uu} + (1 + F_u^2)F_{vv} - 2F_u F_v F_{uv} = 0 \quad . \quad (2.13.5)$$

This expresses the vanishing of the trace of the second fundamental form, actually the component corresponding to the coordinate w . The minimal surface in question is known as right helicoid.

In TGD framework light-like 3-surfaces defined by wormhole throats are the counterparts of characteristic surfaces.

1. By their light-likeness the light-like wormhole throats are analogous to characteristic surfaces (In TGD context light-velocity of course replace local sound velocity). Since the signature of the metric changes at wormhole throats, the 4-D tangent space reduces to 3-D in metric sense at them so that they indeed are singular in a unique sense. Gravitational effects imply that they need not look expanding in Minkowski coordinates. The light-velocity in the induced metric is in general smaller than maximal signal velocity in Minkowski space and can be arbitrarily small.
2. In TGD framework light-like 3-surfaces would be naturally associated with phase boundaries defining boundaries of physical objects. They would be light-like metrically degenerate 3-surfaces in space-time along which the space-time sheet assignable to fluid flow meets the space-time sheet assignable to say air. The generation of wake turbulence would in TGD framework mean the decay of a large 3-surface representing a laminar flow to sheet of separate cylindrical 3-surfaces representing vortex sheet. Also the amalgamation of vortices can be considered as a reverse process.
3. Interesting question related to the time evolution of these 2-D boundaries. In TGD framework it should give rise to 3-D light-like surface. The simulations for the evolution of Kelvin-Helmholtz instability and Rayleigh-Taylor mushroom pattern in Wikipedia and it seems that at the initial stages there is period of growth bringing in mind expanding light-front: the velocity of expansion is not its value in Minkowski space but corresponds to that assignable to the induced metric and can be much smaller. Recall also that in TGD framework gravitational effects are large near the singularity so that growth is not with the light-velocity in vacuum.

The proposal of Kiehn that very special minimal surfaces (right helicoids) are in question would in TGD framework correspond to a light-like 3-surfaces representing light-like orbits of these minimal surfaces presumably expanding at least in the beginning of the time evolution.

Minkowskian hydrodynamics/Maxwellian dynamics as hyperbolic dynamics and Euclidian hydrodynamics as elliptic dynamics

In Kiehn's proposal both the hyperbolic wave dynamics (about which Maxwell's equations provide a simple linear example) and diffusive elliptic or parabolic dynamics are present. In TGD framework

both aspects are present at the level of field equations and correspond to the hyperbolic dynamics in Minkowskian space-time regions and elliptic dynamics in Euclidian space-time regions.

The dynamics of preferred extremals can be seen in two manners. Either as hydrodynamics or as Maxwellian dynamics with Bohr rules expressing the decomposition of the field to quanta- magnetic flux quanta or massless radiation quanta.

1. Maxwellian hydrodynamics involves a considerable restriction: superposition of modes moving in different directions is not allowed: one has just left-movers or right-movers in given direction, not both. Preferred extremals are "Bohr orbit like" and resemble outcomes of state function reduction measuring polarization and wave vector. The linear superposition of fields is replaced with the superposition of effects. The test particle topologically condenses to several space-time sheets simultaneously and experiences the sum of the forces of classical fields associated with the space-time sheets. Therefore one avoids the worst objection against TGD that I have been able to invent. Only four primary field like variables would replace the multitude of primary fields encountered in a typical unification. Besides this one has second quantized induced spinor fields.
2. Field equations are hydrodynamical in the sense that the field equations state classical conservation laws of four-momentum and color charges. In fermionic sector conservation of electromagnetic charge (in quantum sense so that different charge states for spinor mode do not mix) requires the localization of solutions to 2-D string world sheets for all states except right-handed neutrino. This leads to 2-D conformal invariance. A possible identification of string world sheet is as 2-D minimal surface of space-time (rather than that of imbedding space).

What is remarkable that in Minkowskian space-time regions most preferred extremals (magnetic flux tube structures define an exception to this) are locally analogous to the modes of massless field with polarization direction and light-like momentum direction which in the general case can depend on position so that one has curvilinear light-like curve as analog of light-ray. The curvilinear light-like orbits results when two parallel preferred extremals with constant light-like direction form bound states via the formation of magnetically charged wormhole contact structures identifiable as elementary particles. Total momentum is conserved and is time-like for this kind of states, and the hypothesis is that the values of mass squared are given by p-adic thermodynamics. The conservation of Kähler current holds true as also its integrability in the sense of Frobenius giving $j = \Psi \nabla \Phi$. Besides this massless wave equations hold true for both Ψ and Φ . This looks like 4-D generalization of your equations at the characteristic defined by phase boundary.

3. In Euclidian regions one has naturally elliptic "hydrodynamics". Euclidian regions correspond for 4-D CP_2 projection to the 4-D "lines" of generalized Feynman diagrams. Their M^4 projections can be arbitrary large and the proposal is that the space-time sheet characterizing the macroscopic objects is actually Euclidian. In $AdS_5 - S^5$ correspondence the corresponding idea is that macroscopic object is described as a blackhole in 10-D space. Now blackhole interiors have Euclidian signature as lines of generalized Feynman diagrams and blackhole interior does not differ from the interior of any system in any dramatical manner. Whether the Euclidian and Minkowskian dynamics are dual of each other or whether both are necessary is an open question.

Chapter 3

General View About Physics in Many-Sheeted Space-Time: Part I

3.1 Introduction

The concept of topological condensation unifies two disparate approaches to TGD, namely TGD as a Poincare invariant theory of gravitation and TGD as a generalization of the string model. The idea is that classical 3- space with matter can be regarded as a 3-surface obtained by "gluing" particle like 3-surfaces to the background 3-surface with possibly macroscopic size: resulting topological in-homogenities correspond to matter. The "gluing" of two n -manifolds together by topological sum means the following operation: drill spherical holes to both n -manifolds and connect the resulting boundary components S^{n-1} with a tube $D^1 \times S^{n-1}$ (see Fig. 3.1.1). Of course, several $\#$ contacts, which are tiny 'wormholes' connecting two parallel space-time sheets, are expected to be present in the general case.

3.1.1 Various types of topological condensation

One can in fact distinguish between three kinds of topological condensation.

- (a) 3-dimensional topological condensation, which is expected to give rise to the formation of bound states (not necessary all possible bound states).
- (b) 4-dimensional topological condensation, which results from the properties of the Kähler action: the minimizing four surface associated with a given set of 3-surfaces is in general connected so that long range interactions are generated between the 3-surfaces. This mechanism is in principle all what is needed to generate the so called classical space-time. Although the physical state can consist of arbitrarily many disjoint 3-surfaces, the space-time associated with these surfaces is connected and resembles the "classical" space-time, when topological inhomogenities are smoothed out. It should be noticed that 4-dimensional topological condensation corresponds to unstable 3-dimensional topological condensation. For the visualization purposes, one can consider a simplified example: instead of 3-surfaces consider strings so that space-time is replaced with a two-surface having strings as its boundaries.
- (c) 2-dimensional topological condensation: boundaries of the 3- surfaces are joined together by a tube $D^1 \times D^2$. This process will be referred as a formation of join along boundaries bonds.

There are also reasons to suspect that the actual macroscopic 3-space is not connected but corresponds to a large macroscopic 3-surface, classical 3-space, plus a gas of small particle like

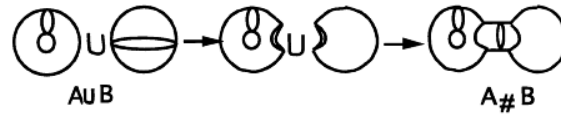

Figure 3.1: Topological sum of two manifolds

3-surfaces, "Baby Universes". It is to be expected that the effects related to the vapor phase particles are very small. An idealization is obviously needed in order to obtain something resembling the topologically trivial 3-space of the standard theories: topological inhomogeneities of size smaller than a given length scale L are smoothed out and their presence is described using various currents, such as energy momentum tensor, gauge currents and particle number currents. To be precise, this works only provided one takes the limit $L \rightarrow \infty$ since TGD space-time could well be many sheeted in arbitrarily long length scales.

3.1.2 Implications of the topological non-triviality of macroscopic space-time

If one accepts that 3-space is topologically nontrivial, one must sooner or later end up asking following questions. What does 3-space actually look like in various scales? What are the general physical consequences of the new space time concept? Are they seen at elementary particle level only or perhaps at atomic, molecular, etc. levels? What is the 3-topology of the solid/liquid/gas state? What about macroscopic bodies: what do they correspond topologically?

In the following the general ideas about the topological condensation are discussed. These ideas have developed gradually in parallel with the development of the configuration space geometry and Quantum TGD, through the study of the extremals of Kähler action and through the attempts to apply TGD inspired ideas to many not so well understood phenomena like Higgs mechanism or more generally, particle massivation, color confinement, super fluidity, super conductivity, hydrodynamic turbulence, etc.. The ideas to be represented may look rather wild, when encountered outside the context defined by twenty years of personal work with many trials and errors and moments of discovery. It is the internal consistency rather than quantitative details, as well as the radically new approach provided to the problems of even macroscopic physics, which makes the scenario so exciting.

3.1.3 Topics of the chapter

The topics to be discussed in the sequel will be following:

- (a) The question what 3-space looks like in various scales and end up to a purely topological description for the generation of structures. Topological arguments imply a finite size for non-vacuum 3-surfaces and the conservation of the gauge and gravitational fluxes requires that 3-surface feeds these fluxes to a larger 3-surface via $\#$ contacts situated near the boundaries of the 3-surface. Renormalization group invariance (RGI) hypothesis suggests that 3-surfaces with all sizes are important in the functional integral and this leads to the idea of the many-sheeted space-time with hierarchical, fractal like structure such that each level of the hierarchy corresponds to a characteristic length scale.
- (b) The general space-time picture suggested by RGI hypothesis can be justified mathematically. Due to the compactness of CP_2 , a general space-time surface representable as a map $M^4 \rightarrow CP_2$ decomposes into regions, "topological field quanta", characterized by certain vacuum quantum numbers and 3-surface is in general unstable against the decay to disjoint components along the boundaries of the field quanta. Topological field quanta have finite

size depending on the values of the vacuum quantum numbers: the size increases as the values of the vacuum quantum numbers increase. Topological field quantum is therefore a good candidate for a quantum coherent system provided some Bose Einstein condensate or quantum coherent state is available. The BE condensate or coherent state of the light # contacts near the boundaries of the topological field quantum is a good candidate in this respect.

The requirement of the gauge charge conservation in turn implies the hierarchical structure of the topological condensate: gauge fluxes must go somewhere from the outer boundaries of the topological field quantum with finite size and this 'somewhere' must be a larger topological field quantum, which in turn feeds its gauge fluxes to a larger topological field quantum,... Of course, the nonlinearity of the theory could allow vacuum charge densities which can cancel the net charge near boundaries.

Most importantly, topological field quanta allow discrete scalings as a dynamical symmetry. p-Adic length scale hypothesis states that the allowed scaling factors correspond to powers of $\sqrt[p]{p}$, where the prime p satisfies $p \simeq 2^k$, k integer with prime values favored. p-Adic fractality (actually multi-p-fractality) can be justified more rigorously by a precise formulation for the fusion of real and various p-adic physics based on the generalization of the notion of number [K80] .

The physical consequences of the new space-time picture are nontrivial at all length scales.

- i. A natural interpretation for the hierarchical structure is in terms of bound state formation. Quarks condense to form hadrons, nucleons condense to form atomic nuclei, nuclei and electrons condense to form atoms, how atoms condense to form molecules, and so on. One ends up with a general picture for the topology of 3-space associated with, say, solid state and with the idea that even the macroscopic bodies of the everyday world correspond to topologically condensed 3-surfaces.
- ii. The join of 3-surfaces along their boundaries defines a new kind of interaction, which in fact has been used in phenomenological modelling of and usually believed to result from Schrödinger equation. At the macroscopic level this interaction is rather familiar to us since it means that two macroscopic bodies just touch each other!
- iii. The possibility to understand general qualitative features of the charge renormalization topologically in the proposed scenario for space-time, is considered. This rough vision represents one of the oldest strata in the evolution of TGD: in [K5] the recent view about space-time correlates of gauge charges is developed.
- iv. In TGD context there are purely topological necessary conditions for quantum coherence and a topological description for dissipative phenomena. The formation of the join along boundaries bonds plays a decisive role in the description and this process provides a universal manner to generate macroscopic quantum systems.
- v. There is also a topological description for the formation of the supra phases and the phase of the order parameter of the supra phase ground state contains information about the homotopy of the join along boundaries condensate.

The proper understanding of the concepts of gauge charges and fluxes and their gravitational counterparts in TGD space-time has taken a lot of efforts. At the fundamental level gauge charges assignable to light-like 3-D elementary particle horizons surrounding a topologically condensed CP_2 type extremals can be identified as the quantum numbers assignable to fermionic oscillator operators generating the state associated with horizon identifiable as a parton. Quantum classical correspondence requires that commuting classical gauge charges are quantized and this is expected to be true by the generalized Bohr orbit property of the space-time surface.

The most dramatic prediction obvious from the beginning but mis-interpreted for about 26 years is the presence of long ranged classical electro-weak and color gauge fields in the length scale of the space-time sheet. The only interpretation consistent with quantum classical correspondence is in terms of a hierarchy of scaled up copies of standard model physics corresponding to p-adic length scale hierarchy and dark matter hierarchy labelled by arbitrarily large values of dynamical quantized Planck constant. Chirality selection in the bio-systems provides direct experimental evidences for this fractal hierarchy of standard model physics.

- (c) There are some non-trivial questions. Do vacuum charge densities give rise to renormalization effects or imply non-conservation so that weak charges would be screened above intermediate boson length scale? Could one assign the non-conservation of gauge fluxes to the wormhole (#) contacts, which are identifiable as pieces of CP_2 extremals and for which electro-weak gauge currents are not conserved so that weak gauge fluxes would be non-vanishing but more or less random so that long range correlations would be lost? After almost two decades after posing these questions it has become clear that vacuum currents are light-like for preferred extremals of Kähler action and do not give rise to renormalization effects in given p-adic length scale so that coupling constant evolution reduces to discrete p-adic coupling constant evolution also at classical level.
- (d) # (or wormhole-) contacts feeding gauge fluxes from a given sheet of the 3-space to a larger one are a necessary concomitant of the many-sheeted space-time concept. Their physical interpretation remained unclear for a long time.
- i. # contacts can be regarded as particles carrying classical charges defined by the gauge fluxes but behaving as extremely tiny dipoles quantum mechanically in the case that gauge charge is conserved. # contacts must be light, which suggests that they can form Bose-Einstein condensates and coherent states. The real surprise (after 27 years of TGD) was that Higgs boson can be identified as a wormhole contact so that the generation of vacuum expectation value of Higgs field would correspond to a formation of coherent state of wormhole contacts with quantum numbers of Higgs particle.
 - ii. It took some time to realize that all gauge bosons could be regarded as wormhole contacts and that fermions correspond naturally to wormhole throats of topologically condensed CP_2 type extremals. Graviton in turn would correspond to a pair of wormhole contacts connected by flux tubes so that stringlike object is in question. This picture follows unavoidably from the assumption that fermions are free at partonic level and leads to a detailed understanding of particle massivation at the level of first principles.

I have not discussed in this chapter the most recent developments in quantum TGD in detail except by references to the next chapter, where these developments are summarized.

3.2 What do space-like 3-surfaces look like?

This section provides a general picture of space-like 3-surfaces starting renormalization group invariance from spin glass analogy, the selection of preferred extremals of the Kähler action as generalized Bohr orbits, and from the special properties of the induced gauge fields implied by the compactness of CP_2 .

This summary does not consider light-like 3-surfaces associated with wormhole throats and light-like boundaries of space-time sheets are much more suitable for the formulation of quantum TGD. In principle the two notions are dual to each other. Light-like 3-surfaces can be seen as a generalization of Feynman diagrams with lines represented by light-like 3-manifolds meeting along their 2-D ends representing vertices.

3.2.1 Renormalization group invariance, quantum criticality and topology of 3-space

Renormalization group invariance, quantum criticality, and spin glass analogy are basic notions of quantum TGD but it is far from clear what these notions really mean at the level of space-time physics.

What quantum criticality means?

RGI (Renormalization group invariance) hypothesis states essentially that TGD Universe is quantum critical meaning that quantum theory is mathematically equivalent with a statisti-

cal system at critical point. S-matrix elements are analogous to thermal averages of observables, α_K corresponds to critical temperature and the vacuum functional $\exp(K)$ corresponds to $\exp(-H/T)$. The physical interpretation of the Kähler function suggests that $\alpha_K(\text{phys})$ might correspond to a critical temperature at which spontaneous Kähler magnetization and formation of Kähler electric fields compete.

The analogy with spin glass phase in four-dimensional sense is an additional characteristic feature. This allows the critical value of the α_K to depend on the zero modes of the configuration space metric.

The naive idealized interpretation for the quantum criticality would be that 3-surfaces with all possible sizes contribute to the functional integral. In realistic situations there is some upper bound for the size and duration of quantum fluctuations and the size of the largest space-time sheet involved would define the scales in question.

Spin glass analogy leads to the idea that configuration space decomposes into regions D_p characterized by the p-adic prime p such that one can associate a hierarchy of p-adic length scales $L_p(n) = \sqrt{p}^{n-1} l$, $l \sim 10^4 \sqrt{G}$ to each value of p [K58]. The critical value of α_K can in principle depend on p but the recent view is that α_K and perhaps also the gravitational constant are invariant under p-adic coupling constant evolution. p-Adic length scales define natural upper bounds for the scale of quantum fluctuations associated with the quantum critical space-time sheet. Dark matter hierarchy in turn assigns to each p-adic length scale a hierarchy of further length scales scaled up by the values of \hbar/\hbar_0 . The typical duration of quantum fluctuation would correspond to the typical geometric duration of maximal deterministic region inside space-time sheet.

What are the competing phases?

Quite generally, critical systems are characterized by long range correlations (correlation length ξ diverges) for the competing phases present in the system. Physically this means the coexistence of arbitrarily large volumes of the two phases. Both Kähler magnetized 3-surfaces and 3-surfaces containing predominantly Kähler electric fields contribute significantly to the functional integral and are present. At the infinite volume limit the Kähler action per volume must vanish since otherwise the vacuum functional vanishes: TGD cosmology [K73] is in accordance with this picture.

The problem of identifying the preferred extremals of Kähler action has been one of the most longstanding challenges of TGD. The solution of the problem came via the formulation of configuration space geometry from the notion of number theoretical compactification [K81] in terms of second quantized induced spinor field at light-like 3-surfaces [K19]. The original hypothesis was that preferred extremals correspond to absolute minima of Kähler action. The recent formulation in terms of boundary conditions at light-like surfaces is consistent with what is known about extremals of Kähler action [K11]. This formulation does not exclude absolute minimization or some variant of it. Note however that for the absolute minimization of Kähler action Kähler electric fields dominate and it is not clear whether there are solutions for which the Kähler action of the entire Universe is finite.

How quantum fluctuations and thermal fluctuations relate to each other?

An experimental fact is that quantum critical systems such as high temperature superconductors [K15, K16] exist in a rather narrow parameter range, and one can say that quantum criticality becomes visible only when quantum fluctuations are not masked by thermal fluctuations. One should express this fact using TGD based notions.

p-Adic and dark matter hierarchies correspond also to hierarchies for quantum jumps with time scales given the average geometric duration for quantum jump. This hierarchy means quantum parallel dissipation about which hadrons as quantum systems containing quarks as dissipating subsystem at shorter p-adic length and time scale give a basic example.

At given space-time sheet short scale thermal fluctuations would have interpretation as quantum parallel fluctuations at smaller space-time sheets topologically condensed to the space-time sheet

in question whereas the quantum critical fluctuations would correspond to the quantum fluctuations in the scale of the space-time sheet. The duration of maximal deterministic space-time region would correspond to the duration of single quantum state in the sequence of quantum jumps. The interpretation would be that only at quantum criticality the quantum fluctuations in long time scales can mask the thermal fluctuations in shorter scales.

How quantum measurement theory relates to quantum criticality?

A further question is how quantum measurement theory relates to this picture. Configuration space zero modes represent non-quantum fluctuating classical observables correlating with quantum numbers and in quantum measurement a localization in zero modes occurs. Does this mean that the localization in zero modes breaks quantum criticality above the time scale corresponding to the typical geometric time duration of quantum jump by selecting precise values of zero modes?

Formation of join along boundaries condensates and visible-to-dark phase transitions as mechanisms giving rise to quantum critical systems

The phase transition from visible to dark matter, and more generally, the transitions increasing the value of Planck constant define the first mechanism leading to the formation of larger quantum critical system and long range quantum fluctuations can be assigned to dark matter.

The formation of a join along boundaries condensate means also a formation of a quantum critical system. The 3-surfaces with a typical size of order L_p combine together by join along boundaries bonds to form larger surfaces. Above criticality there are no bonds, below criticality all 3-surfaces combine to form larger condensates and at criticality there are join along boundaries condensates with all possible sizes up to the cutoff length scale. Note that, at least for small values of p , the surfaces with typical sizes $\sqrt{p}^n L_p$, $n = .0, 1, 2, \dots$ correspond to the presence of all surface sizes related by a fractal scaling for a given p . A more precise formulation for what the fusion of p-adic and real [H3] [K81] means supports the view that topological field quanta allow a discrete scaling symmetry identifiable as scalings by powers of \sqrt{p} .

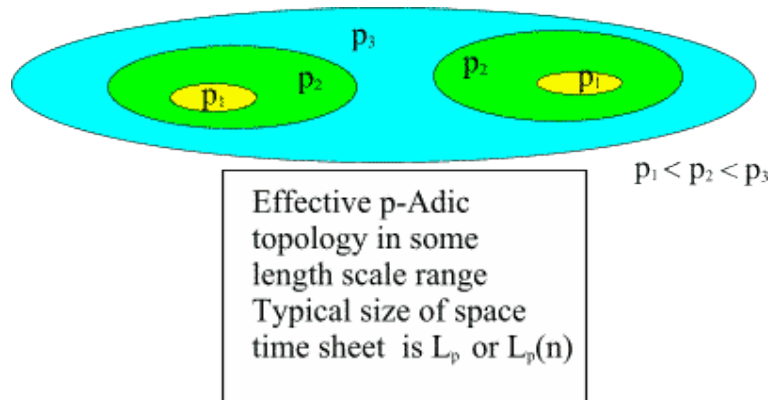

Figure 3.2: Hierarchical, fractal like structure of topological condensate predicted by RGI hypothesis: 2-dim. visualization

3.2.2 3-surfaces can have outer boundaries

In length scales larger than hadronic length scale 3-surface with size L means roughly a condensate of smaller scale 3-surfaces on a piece of Minkowski space of size L . It is quite essential that these surfaces have finite size and therefore have outer boundary. The finite size of the

3-surfaces follows from the minimization of the Kähler action and from the compactness of CP_2 . The argument goes as follows.

The matter inside a 3-surface creates gauge fields. In particular, the minimization of the absolute value of Kähler action in a region with definite sign of action density implies that matter serves as a source of either Kähler magnetic or Kähler electric fields. For instance, the Kähler electric field created by a constant mass distribution increases without bound. The smooth imbeddings of the gauge fields are however not possible globally and space-time decomposes into topological field quanta and their boundaries correspond to edges of space time. The elimination of the edges leads to a 3-space consisting of disjoint components. Simple examples are provided by a cylindrically symmetric imbedding of a constant magnetic field and the Kähler electric field created by a constant mass distribution, which fail for certain critical radii.

One can understand at general level how the compactness of CP_2 enters into the game. The point is that the gauge potentials associated with the induced gauge fields are bounded functions of CP_2 coordinates. For instance, for a geodesic sphere S^2 of CP_2 gauge potentials are just proportional to $A = \sin(\Theta)d\Phi$. For a generic gauge field the gauge potential is not bounded (as an example consider gauge potentials of the Coulomb field or Kähler electric field created by a constant charge distribution or by a constant magnetic field). Therefore for certain values of CP_2 coordinates the representation of the gauge potential as an induced gauge potential fails. The failure takes place at some 3-surface of X^4 . One can continue the embedding by changing the values of vacuum quantum numbers but certain CP_2 coordinates possess discontinuous or even infinite derivatives on the boundary so that undesirable edges of space time result. The manner to get rid of edges is to allow boundary for X^3 so that a region, where the representation of the gauge potential as induced gauge potential works defines a natural unit of space-time, which might be called topological field quantum. In the sequel this phenomenon will be considered in more detail.

An obvious question is what happens to the gauge fluxes of long range gauge fields near the boundaries of the topological field quantum. Same question applies also to the gravitational flux associated with the Newtonian potential at the non-relativistic limit. One possibility is the appearance of neutralizing vacuum gauge charges and negative gravitational masses near the boundaries of the field quantum, perhaps related to vacuum polarization: this alternative must be realized for the particles of vapor phase. Second possibility is topological condensation on a larger topological field quantum so that gauge and gravitational fluxes flow to the larger topological field quantum via # contacts. The larger field quantum in turn must feed its gauge fluxes in a similar manner to larger field quantum so that the hierarchical structure of topological condensate is implied by the compactness of CP_2 and gauge flux conservation. Criticality implies only that 3-surfaces of arbitrarily large size are possible and therefore the number of the condensate levels and corresponding length scales $L(n)$ is infinite. Without criticality there would be some upper bound for 3-surfaces and only vapor phase would be possible.

The # contacts feeding the gauge fluxes from level p_n to level p_{n+1} are located near the boundaries of topological field quanta: otherwise long range gauge fields would not be possible inside the topological field quanta. A more quantitative hypothesis is that # contacts are located in the boundary layer having thickness of order L_{p_n} . If topological field quantum at level n has the minimum size of order L_{p_n} then the # contacts neutralize the physical gauge charges on the average.

A natural identification for wormhole contacts is as slightly deformed pieces of CP_2 type vacuum extremals having Euclidian signature of induced metric. Wormhole throats are identified as 3-surfaces at which the signature of induced metric changes and are therefore light-like 3-surfaces. The realization that these surfaces are ideal for the formulation of quantum TGD meant breakthrough in the construction of quantum TGD. The interpretation of the wormhole contacts as elementary bosons was crucial for understanding boson massivation and Higgs mechanism [K48]

3.2.3 Topological field quantization

Topological field quantization is a very general phenomenon differentiating between the TGD based and Maxwellian field concepts and results from the compactness of CP_2 only, being independent of any dynamical assumptions.

Topological field quantization occurs for surfaces representable as maps from M^4 to CP_2 and means that space time surface decomposes into regions characterized by certain vacuum quantum numbers characterizing the dependence of the phase angles Ψ and Φ associated with the two complex coordinates ξ_1 and ξ_2 of CP_2 . There are two frequency type vacuum quantum numbers ω_1 and ω_2 characterizing the time dependence, two wave vector like quantum numbers k_1, k_2 characterizing the z-dependence and two integer valued vacuum quantum numbers n_1, n_2 characterizing the angle dependence of these phase angles. Topological field quantization fixes unique M^4 and CP_2 coordinates inside the field quantum and is analogous to a choice of a quantization axis.

Topological field quanta

Before considering the general form of the surfaces representable as maps $M^4 \rightarrow CP_2$ some comments about CP_2 coordinates are needed:

- (a) The so called Eguchi-Hanson coordinates for CP_2 are given $(r, u, \Psi, \Phi) \in [0, \infty] \times [-1, 1] \times [0, 4\pi] \times [0, 2\pi]$ (see Appendix [L1], [L1]). Ψ and Φ are angle like coordinates closely related to the phases of the two complex coordinates of CP_2 and are the interesting variables in the sequel.
- (b) There are following types of coordinate singularities.
 - i. For $r = 0$ all values of Ψ and Φ correspond to same point of CP_2 .
 - ii. For $r = \infty$ all values of Ψ correspond to same point of CP_2 . For $u = 1$ and $u = -1$ also all values of Φ correspond to same point of CP_2 .

Consider now the space-time surface representable as a graph of a map $M^4 \rightarrow CP_2$. The general form of the angle coordinates Ψ and Φ as functions of M^4 cylindrical coordinates (t, z, ρ, ϕ) is given by the expression

$$\begin{aligned}\Phi &= \omega_1 t + k_1 z + n_1 \phi + \text{Fourier expansion} \ , \\ \Psi &= \omega_2 t + k_2 z + n_2 \phi + \text{Fourier expansion} \ .\end{aligned}\tag{3.2.1}$$

There always exists a rest frame, where k_1 or k_2 vanishes. The Fourier expansion is single valued in ϕ and finite in z and t . The vacuum quantum numbers ω_1 and ω_2 are frequency type vacuum quantum numbers to be referred as "electric" quantum numbers. The quantum numbers (n_1, n_2) are integer valued and will be referred to as "magnetic" quantum numbers.

The values of the vacuum quantum numbers can change at the boundaries of the regions of space-time determined by the conditions

- i) $r = 0$ and $(r = \infty, u = \pm 1)$: here all vacuum quantum numbers can change
- ii) $r = \infty$: here only ω_2, n_2 and k_2 can change.

Also the choice of CP_2 coordinates and M^4 coordinates can in principle change: different CP_2 coordinates are related by color rotation and different M^4 coordinates by Lorentz transformation.

In general, the boundaries of the regions correspond to edges of space-time in the sense that CP_2 coordinates possess discontinuous or infinite derivatives at the boundaries of the field quanta. A natural manner to get rid of the edges is to consider 3- surfaces consisting of a single region only so that single region of this kind, topological field quantum, is a natural unit of 3-space. There is however an important exception to this. The join along boundaries interaction very probably

means the gluing of two topological field quanta together along their boundaries and provides a manner to construct coherent quantum systems from smaller units.

The sizes of the topological field quanta are indeed finite so that the boundary of 3-space (quite essential for the ideas described before) is an unavoidable consequence of the compactness of CP_2 and the minimization of the Kähler action. The dependence of the size of the 3-surface on the vacuum quantum numbers is in accordance with the proposed interpretation: at the limit of large vacuum quantum numbers the size of the topological field quantum becomes macroscopic and at small vacuum quantum number limit the size of the surface becomes small.

Very complicated hierarchical structures predicted by the RGI are in principle possible since topological field quanta can suffer topological condensation on larger field quanta. Field quanta can become nested and both spatial and temporal structures (nesting in time like direction) are possible.

The vacuum quantum numbers associated with vacuum extremals

Vacuum extremals define a reasonable starting point for TGD based model for gravitational interactions. For vacuum extremals classical em and Z^0 fields are proportional to each other (see the Appendix of the book):

$$\begin{aligned} Z^0 &= 2e^0 \wedge e^3 = \frac{r}{F^2}(k+u) \frac{\partial r}{\partial u} du \wedge d\Phi = (k+u) du \wedge d\Phi , \\ r &= \sqrt{\frac{X}{1-X}} , \quad X = D|k+u| , \\ \gamma &= -\frac{p}{2} Z^0 . \end{aligned} \tag{3.2.2}$$

For a vanishing value of Weinberg angle ($p = \sin^2(\theta_w) = 0$) em field vanishes and only Z^0 field remains as a long range gauge field.

The study of the imbeddings of the Schwarzschild metric as vacuum extremals (gravitational mass is non-vanishing but inertial mass vanishes) shows that astrophysical length scales correspond to large vacuum quantum number limit of TGD. Any mass vacuum extremal is necessarily accompanied by long ranged electro-weak and color fields and from the requirement that the corresponding force is weaker than the gravitational force one obtains that the value of the parameter ω_1 is of the order of $1/R \sim 10^{-4}\sqrt{G}$.

A simple example about the decomposition of space-time into topological field quanta is obtained by considering the cylindrically symmetric imbedding of a constant magnetic field in the z -direction as a vacuum extremal. Electromagnetic field can be written as $F_{\rho\phi}^{em} = B_0\rho$ and using the general results from the Appendix of the book one can write

$$\begin{aligned} u &= u(\rho) , \quad \Phi = n_1\phi , \\ r &= \sqrt{\frac{X}{1-X}} , \quad X = D|k+u| , \\ A_\phi^{em} &= \frac{B_0\rho^2}{2} = -\frac{p}{2}n_1(k+u)\partial_\rho u . \end{aligned} \tag{3.2.3}$$

Assuming that $(r, u) = (0, 0)$ holds true at z -axis, the equation for em gauge potential A^{em} fixes the relationship between ρ and u as

$$u = -k \pm \sqrt{k^2 - \frac{2B_0\rho^3}{3n_1p}} . \tag{3.2.4}$$

The finite value range $0 \leq u \leq 1$ implies that the imbedding fails for certain values of ρ . Also the requirement that u is real implies an upper bound for ρ : the larger the value of n_1 the larger the critical radius. Imbedding can fail also for $X < 0$ and $X > 1$ corresponding to critical values of u equal $u_0 = -k$ and $D|(k + u_1)| = 1$.

3.2.4 Comparison of Maxwellian and TGD views about classical gauge fields

In TGD Universe gauge fields are replaced with topological field quanta. Examples are topological light rays, magnetic flux tubes and sheets, and electric flux quanta carrying both magnetic and electric fields. Flux quanta form a fractal hierarchy in the sense that there are flux quanta inside flux quanta. It is natural to assume quantization of Kähler magnetic flux. Braiding and reconnection are basic topological operations for flux quanta.

One important example is the description of non-perturbative aspects of strong interactions in terms of reconnection of color magnetic flux quanta carrying magnetic monopole fluxes [K38, K52]. These objects are string like structures and one can indeed assign to them string world sheets. The transitions in which the thickness of flux tube increases so that flux conservation implies that part of magnetic energy is liberated unless the length of the flux quantum increases, are central in TGD inspired cosmology and astrophysics. The magnetic energy of flux quantum is interpreted as dark energy and magnetic tension as negative "pressure" causing accelerated expansion.

This picture is beautiful and extremely general but raises challenges. How to describe interference and linear superposition for classical gauge fields in terms of topologically quantized classical fields? How the interference and superposition of Maxwellian magnetic fields is realized in the situation when magnetic fields decompose to flux quanta? How to describe simple systems such as solenoidal current generating constant magnetic field using the language of flux quanta?

Superposition of fields in terms of flux quanta

The basic question concerns the elegant description of superposition of classical fields in terms of topological field quanta. What it means that magnetic fields superpose.

- (a) In Maxwell's linear theory the answer would be trivial but not now. Linear superposition holds true only inside topological light rays for signals propagating in fixed direction with light velocity and with same local polarization. The easy solution would be to say that one considers small perturbations of background space-time sheet and linearizes the theory. Linearization would apply also to induced gauge fields and metric and one would obtain linear superposition approximately. This does not look elegant. Rather, quantum classical correspondence requires the space-time counterpart for the expansion of quantum fields as sum of modes in terms of topological field quanta. Topological field quanta should not lose their identity in the superposition.
- (b) In the spirit of topological field quantization it would be nice to have topological representation for the superposition and interference without any linearization. To make progress one must return to the roots and ask how the fields are operationally defined. One has test particle and it experiences a gauge force in the field. From the acceleration of the test particle the value of field is deduced. What one observes is the superposition of gauge forces, not of gauge fields.
 - i. Let us just assume that we have two space-time sheets representing field configurations to be effectively superposed. Suppose that they are "on top" of each other with respect to CP_2 degrees of freedom so that their M^4 volumes overlap. The points of the sheets representing the field values that would sum in Maxwell's theory are typically at distance of CP_2 radius of about 10^4 Planck lengths. Wormhole contacts representing the interaction between the field configurations are formed. Hence the analog of linear superposition does not hold true exactly. For instance, amplitude modulation becomes possible. This is however not essential for the argument.

- ii. Test particle could be taken to be fermion which is simultaneously topologically condensed to both sheets. In other words, fermionic CP_2 type almost vacuum extremal touches both sheets and wormhole throats at which the signature of the induced metric changes is formed. Fermion experiences the sum of gauge forces from the two space-time sheets through its wormhole throats. From this one usually concludes that superposition holds true for the induced gauge fields. This assumption is however not true and is also un-necessary in the recent case. In case of topological light rays the representation of modes in given direction in terms of massless extremals makes possible to realize the analogy for the representation of quantum field as sum of modes. The representation does not depend on approximate linearity as in the case of quantum field theories and therefore removes a lot of fuzziness related to the quantum theory. In TGD framework the bosonic action is indeed extremely non-linear.
- (c) This view about linear superposition has interesting implications. In effective superposition the superposed field patterns do not lose their identity which means that the information about the sources is not lost - this is true at least mathematically. This is nothing but quantum classical correspondence: it is the decomposition of radiation into quanta which allows to conclude that the radiation arrives from a particular astrophysical object. It is also possible to have superposition of fields to zero field in Maxwellian sense but in the sense of TGD both fields patterns still exist. Linear superposition in TGD sense might allow testing using time dependent magnetic fields. In the critical situation in which the magnetic field created by AC current passes through zero, flux quanta have macroscopic size and the direction of the flux quantum changes to opposite.

The basic objection against TGD

The basic objection against TGD is that induced metrics for space-time surfaces in $M^4 \times CP_2$ form an extremely limited set in the space of all space-time metrics appearing in the path integral formulation of General Relativity. Even special metrics like the metric of a rotating black hole fail to be imbeddable as an induced metric. For instance, one can argue that TGD cannot reproduce the post-Newtonian approximation to General Relativity since it involves linear superposition of gravitational fields of massive objects. As a matter fact, Holger B. Nielsen - one of the very few colleagues who has shown interest in my work - made this objection for at least two decades ago in some conference and I remember vividly the discussion in which I tried to defend TGD with my poor English.

The objection generalizes also to induced gauge fields expressible solely in terms of CP_2 coordinates and their gradients. This argument is not so strong as one might think first since in standard model only classical electromagnetic field plays an important role.

- (a) Any electromagnetic gauge potential has in principle a local imbedding in some region. Preferred extremal property poses strong additional constraints and the linear superposition of massless modes possible in Maxwell's electrodynamics is not possible.
- (b) There are also global constraints leading to topological quantization playing a central role in the interpretation of TGD and leads to the notions of field body and magnetic body having non-trivial application even in non-perturbative hadron physics. For a very large class of preferred extremals space-time sheets decompose into regions having interpretation as geometric counterparts for massless quanta characterized by local polarization and momentum directions. Therefore it seems that TGD space-time is very quantal. Is it possible to obtain from TGD what we have used to call classical physics at all?

The imbeddability constraint has actually highly desirable implications in cosmology. The enormously tight constraints from imbeddability imply that imbeddable Robertson-Walker cosmologies with infinite duration are sub-critical so that the most pressing problem of General Relativity disappears. Critical and over-critical cosmologies are unique apart from a parameter characterizing their duration and critical cosmology replaces both inflationary cosmology and cosmology characterized by accelerating expansion. In inflationary theories the situation is just the opposite of this: one ends up with fine tuning of inflaton potential in order to obtain recent day cosmology.

Despite these and many other nice implications of the induced field concept and of sub-manifold gravity the basic question remains. Is the imbeddability condition too strong physically? What about linear superposition of fields which is exact for Maxwell's electrodynamics in vacuum and a good approximation central also in gauge theories. Can one obtain linear superposition in some sense?

- (a) Linear superposition for small deformations of gauge fields makes sense also in TGD but for space-time sheets the field variables would be the deformations of CP_2 coordinates which are scalar fields. One could use preferred complex coordinates determined about $SU(3)$ rotation to do perturbation theory but the idea about perturbations of metric and gauge fields would be lost. This does not look promising. Could linear superposition for fields be replaced with something more general but physically equivalent?
- (b) This is indeed possible. The basic observation is utterly simple: what we know is that the *effects* of gauge fields superpose. The assumption that fields superpose is un-necessary! This is a highly non-trivial lesson in what operationalism means for theoreticians tending to take these kind of considerations as mere "philosophy".
- (c) The hypothesis is that the superposition of effects of gauge fields occurs when the M^4 projections of space-time sheets carrying gauge and gravitational fields intersect so that the sheets are extremely near to each other and can touch each other (CP_2 size is the relevant scale).

A more detailed formulation goes as follows.

- (a) One can introduce common M^4 coordinates for the space-time sheets. A test particle (or real particle) is identifiable as a wormhole contact and is therefore pointlike in excellent approximation. In the intersection region for M^4 projections of space-time sheets the particle forms topological sum contacts with all the space-time sheets for which M^4 projections intersect.
- (b) The test particle experiences the sum of various gauge potentials of space-time sheets involved. For Maxwellian gauge fields linear superposition is obtained. For non-Abelian gauge fields gauge fields contain interaction terms between gauge potentials associated with different space-time sheets. Also the quantum generalization is obvious. The sum of the fields induces quantum transitions for states of individual space time sheets in some sense stationary in their internal gauge potentials.
- (c) The linear superposition applies also in the case of gravitation. The induced metric for each space-time sheet can be expressed as a sum of Minkowski metric and CP_2 part having interpretation as gravitational field. The natural hypothesis that in the above kind of situation the effective metric is sum of Minkowski metric with the sum of the CP_2 contributions from various sheets. The effective metric for the system is well-defined and one can calculate a curvature tensor for it among other things and it contains naturally the interaction terms between different space-time sheets. At the Newtonian limit one obtains linear superposition of gravitational potentials. One can also postulate that test particles moving along geodesics in the effective metric. These geodesics are not geodesics in the metrics of the space-time sheets.
- (d) This picture makes it possible to interpret classical physics as the physics based on effective gauge and gravitational fields and applying in the regions where there are many space-time sheets which M^4 intersections are non-empty. The loss of quantum coherence would be due to the effective superposition of very many modes having random phases.

The effective superposition of the CP_2 parts of the induced metrics gives rise to an effective metric which is not in general imbeddable to $M^4 \times CP_2$. Therefore many-sheeted space-time makes possible a rather wide repertoire of 4-metrics realized as effective metrics as one might have expected and the basic objection can be circumvented In asymptotic regions where one can expect single sheetedness, only a rather narrow repertoire of "archetypal" field patterns of gauge fields and gravitational fields defined by topological field quanta is possible.

The skeptic can argue that this still need not make possible the imbedding of a rotating black hole metric as induced metric in any physically natural manner. This might be the case but need of course not be a catastrophe. We do not really know whether rotating blackhole metric is realized in Nature. I have indeed proposed that TGD predicts new physics new physics in rotating systems. Unfortunately, gravity probe B could not check whether this new physics is there since it was located at equator where the new effects vanish.

Time varying magnetic fields described in terms of flux quanta

An interesting challenge to describe time dependent fields in terms of topological field quanta which are in many respects static structures (for instance, flux is constant). The magnetic fields created by time dependent currents serves as a good example from which one can generalize. In the simplest situation the magnetic field strength experiences time dependent scaling. How to describe this scaling?

Consider first the scaling of the magnetic field strength in flux tube quantization.

- (a) Intuitively it seems clear that the field decomposes into flux quanta, whose M^4 projections can partially overlap. To get a connection to Maxwell's theory one can assume that the average field intensity is defined in terms of the flux of the magnetic field over a surface with area S . For simplicity consider constant magnetic field so tht one has $B_{ave}S = \Phi = n\Phi_0$, where Φ_0 is the quantized flux for a flux tube assumed to have minimum value Φ_0 . Integer n is proportional to the average magnetic field B_{ave} . B_{ave} must be reasonably near to the typical local value of the magnetic field which manifest itself quantum mechanically as cyclotron frequency.
- (b) What happens in the scaling $B \rightarrow B/x$. If the transversal area of flux quantum is scaled up by x the flux quantum is conserved. To get the total flux correctly, the number of flux quanta must scale down: $n \rightarrow n/x$. One indeed has $(n/x) \times xS = nS$. This implies that the total area associated with flux quanta within total area S is preserved in the scaling.
- (c) The condition that the flux is exact integer multiple of Φ_0 would pose additional conditions leading to the quantization of magnetic flux if the total area can be regarded as fixed. This need not to be true.

Consider as the first example slowly varying magnetic field created by an alternating running in current in cylindrical solenoid. There are flux tubes inside the cylindrical solenoid and return flux tubes outside it flowing in opposite direction. Flux tubes get thicker as magnetic field weakens and shift from the interior of solenoid outside. For some value x of the time dependent scaling $B \rightarrow B/x$ the elementary flux quantum Φ_0 reaches the radius of the solenoid. Quantum effects must become important and make possible the change of the sign of the elementary flux quantum. Perhaps quantum jump turning the flux quantum around takes place. After this the size of the flux quantum begins to decrease as the magnitude of the magnetic field increases. At the maximum value the size of the flux quantum is minimum.

This example generalizes to the magnetic field created by a linear alternating current. In this case flux quanta are cylindrical flux sheets for which magnetic field strength and thickness oscillators with time. Also in this case the maximum transversal area to the system defines a critical situation in which there is just single flux sheet in the system carrying elementary flux. This flux quantum changes its sign as the sign of the current changes.

The notion of conscious hologram

In TGD inspired theory of consciousness the idea about living system as a conscious hologram [K13] is central. It is of course far from clear what this notion means. The notions of interference and superposition of fields are crucial for the description of the ordinary hologram. Therefore the proposed general description for the TGD counterpart for the superposition of fields is a natural starting point for the more precise formulation of the notion of conscious hologram.

- (a) Consider ordinary hologram first. Reference wave and reflected wave interfere and produce an interference pattern to which the substrate of the hologram reacts so that its absorption coefficient is affected. When the substrate is illuminated with the conjugate of the reference wave, the original reflected wave is generated. The modification of the absorption coefficient is assumed to be proportional to the modulus squared from the sum of the reflected and reference waves. This implies that the wave reflected from the hologram is in good approximation identical with the original reflected wave.
- (b) Conscious hologram would be dynamical rather than static. It would be also quantal: the quantum transitions of particles in the fields defined by the hologram would be responsible for the realization of the interference pattern as a conscious experience. The previous considerations actually leave only this option since the interference of classical fields does not happen. Reference wave and reflected wave correspond now to any field configurations. The charged particles having wormhole contacts to the space-time sheets representing the field configurations experience the sum of the fields involved, and this induces quantum jumps between the quantum states associated with the situation in which only the reference wave is present.

This would induce a conscious experience representing an interference pattern. The reference wave can also correspond to a flux tube of magnetic body carrying a static magnetic field and defining cyclotron states as stationary state. External time dependent magnetic field can replace reflected wave and induces cyclotron transitions. Also radiation fields represented by MEs can represent the reference wave and reflected wave. If there is need for the "reading" of the hologram it would correspond to the addition of a space-time sheet carrying fields which in good approximation have opposite sign and same magnitude as those in the sheet representing reference wave so that the effect on the charged particles reduces to that of the "reflected wave". This step might be un-necessary since already the formation of hologram would give rise to a conscious experience. The conscious holograms created when the hologram is created and when the conjugate of the reference wave is added give rise to two different conscious representations. This might have something to do with holistic and reductionistic views about the same situation.

- (c) One can imagine several realizations for the conscious hologram. It seems that the realization at the macroscopic level is essentially four-dimensional. By quantum holography it would reduce at microscopic level to a hologram realized at the 3-D light-like surfaces defining the surfaces at which the signature of induce metric changes (generalized Feynman diagrams having also macroscopic size - anyons [K63]) or space-like 3-surfaces at the ends of space-time sheets at the two light-like boundaries of CD . Strong form of holography implied by the strong form of general coordinate invariance requires that holograms correspond to collections of partonic 2-surfaces in given measurement resolution. This could be understood in the sense that the charged particles defining the substrate can be described mathematically in terms of the ends of the corresponding light-like 3-surfaces at the ends of CD s. The cyclotron transitions could be thought of as occurring for particles represent as partonic 2-surfaces topologically condensed at several space-time sheets.

One can imagine several applications in TGD inspired quantum biology.

- (a) One can develop a model for how certain aspects of sensory experience could be understood in terms of interference patterns for signals sent from the biological body to the magnetic body. The information about the relative position of the magnetic body and biological body would be coded by the interference patterns giving rise to conscious sensory percepts. This information would represent geometric qualia [K37] giving information about distances and angles basically. There would be a magnetic flux tube representing the analog of the reference wave and magnetic flux tube carrying the analog of reflected wave which could represent the effect of neural activity. When the signal changes with time, cyclotron transitions are induced and conscious percept is generated. In principle it there is no need not compensate for the reference wave although also this is possible.
- (b) The natural first guess is that EEG rhythms (and those for its fractal generalization) represent reference waves and that the frequencies in question are either harmonics of

cyclotron frequencies or linear combinations of these and Josephson frequency assignable to cell membrane (and possibly its harmonics). The modulation of membrane potential would induce modulations of Josephson frequency and if large enough would generate nerve pulses. These modulations would define the counterpart of the reflected wave. The flux tubes representing unperturbed magnetic field would represent reference waves.

- (c) For instance, the motion of the biological body changes the signal at the space-time sheets carrying the signal and this generates cyclotron transitions giving rise to a conscious experience. Perhaps the sensation of having a body is based in this mechanism. The signals could emerge from directly from cells: it could be that this sensation corresponds to lower level selves rather than us. Second option is that nerve pulses to brain induce the signals sent to the our magnetic body.
- (d) The motion of biological body relative to biological body generates virtual sensory experience which could be responsible for the illusions like train illusion and the unpleasant sensory experience about falling down from cliff by just imagining it. OBEs could be also due to the virtual sensory experiences of the magnetic body. One interesting illusion results when one swims long time in windy sea. When one returns to the shore one has rather long lasting experience of being in sea. Magnetic body gradually learns to compensate the motion of sea so that the perception of the wavy motion is reduced. At the shore this compensation mechanism however continues to work. This mechanism represents an example of adaptation and could be a very general mechanism. Since also magnetic body uses metabolic energy, this mechanism could have justification in terms of metabolic economy. Also thinking as internal, silent speech might be assigned with magnetic body and would represent those aspects of the sensory experience of ordinary speech which involve quantum jumps at magnetic body. This speech would be internal speech since there would be no real sound signal or virtual sound signal from brain to cochlea.
- (e) Conscious hologram would make possible to represent phase information. This information is especially important for hearing. The mere power spectrum is not enough since it is same for speech and its time reversal. Cochlea performs an analysis of sounds to frequencies. It is not easy to imagine how this process could preserve the phase information associated with the Fourier components. It is believed that both right and left cochlea are needed to abstract the phase difference between the signals arriving to right and left ear allowing to deduce the direction of the source neural mechanisms for this has been proposed but these mechanism are not enough in case of speech. Could there exists a separate holistic representation in which sound wave as a whole generates a single signal interfering with the reference wave at the magnetic body and in this manner represents as a conscious experience the phase?
- (f) Also the control and reference signals from the magnetic body to biological body could create time dependent interference patterns giving rise to neural response initiating motor actions and other responses. Basically the quantum interference should reduce the magnitude of membrane resting potentials so that nerve pulses would be generated and give rise to motor action. Similar mechanism would be at work at the level of sensory receptors - at least retina. The generation of nerve pulses would mean kind of emergency situation at the neuronal level. Frequency modulation of Josephson radiation would be the normal situation.

Topology of fields and topological field quantization

3.3 Basic phenomenology of topological condensation

The notions of topological condensate and p-adic length scale hierarchy are in a central role in TGD and for a long time it seemed that the physical interpretation of these notions is relatively straightforward. The evolution of number theoretical ideas however forced to suspect that the implications for physics might be much deeper and involve not only a solution to the mysteries of dark matter but also force to bring basic notions of TGD inspired theory of consciousness.

At this moment the proper interpretation of the mathematical structures involving typically infinite hierarchies generalizing considerably the mathematical framework of standard physics is far from established so that it is better to represent just questions with some plausible looking answers.

3.3.1 Basic concepts

It is good to discuss the basic notions before discussing the definition of gauge charges and gauge fluxes.

CP_2 type vacuum extremals

CP_2 type extremals behave like elementary particles (in particular, light-likeness of M^4 projection gives rise to Virasoro conditions). CP_2 type vacuum extremals have however vanishing four-momentum although they carry classical color charges. This raises the question how they can gain elementary particle quantum numbers.

In topological condensation of CP_2 type vacuum extremal a light-like causal horizon is created. Number theoretical considerations strongly suggest that the horizon carries elementary particle numbers and can be identified as a parton. The quantum numbers or parton would serve as sources of the classical gauge fields created by the causal horizon.

In topological evaporation CP_2 type vacuum extremal carrying only classical color charges is created. This would suggest that the scattering of CP_2 type vacuum extremals defines a topological quantum field theory resulting as a limit of quantum gravitation (CP_2 is gravitational instanton) and that CP_2 type extremals define the counterparts of vacuum lines appearing in the formulation of generalized Feynman diagrams.

contacts as parton pairs

The earlier view about # contacts as passive mediators of classical gauge and gravitational fluxes is not quite correct. The basic modification is due to the fact that one can assign parton or parton pair to the # contact so that it becomes a particle like entity. This means that an entire p-adic hierarchy of new physics is predicted.

- (a) Formally # contact can be constructed by drilling small spherical holes S^2 in the 3-surfaces involved and connecting the spherical boundaries by a tube $S^2 \times D^1$. For instance, CP_2 type extremal can be glued to space-time sheet with Minkowskian signature or space-time sheets with Minkowskian signature can be connected by # contact having Euclidian signature of the induced metric. Also more general contacts are possible since S^2 can be replaced with a 2-surface of arbitrary genus and family replication phenomenon can be interpreted in terms of the genus.

The # contact connecting two space-time sheets with Minkowskian signature of metric is accompanied by two "elementary particle horizons", which are light-like 3-surfaces at which the induced 4-metric becomes degenerate. Since these surfaces are causal horizons, it is not clear whether # contacts can mediate classical gauge interactions. If there is an electric gauge flux associated with elementary particle horizon it tends to be either infinite by the degeneracy of the induced metric. It is not clear whether boundary conditions allow to have finite gauge fluxes of electric type. A similar difficulty is encountered when one tries to assign gravitational flux to the # contact: in this case even the existence of flux in non-singular case is far from obvious. Hence the naive extrapolation of Newtonian picture might not be quite correct.

- (b) Number theoretical considerations suggests that the two light-like horizons associated with # contacts connecting space-time sheets act as dynamical units analogous to shock waves or light fronts carrying quantum numbers so that the identification as partons is natural. Quantum holography would suggest itself in the sense that the quantum numbers associated with causal horizons would determine the long range fields inside space-time sheets involved.

- (c) $\#$ contacts can be modelled in terms of CP_2 type extremals topologically condensed simultaneously to the two space-time sheets involved. The topological condensation of CP_2 type extremal creates only single parton and this encourages the interpretation as elementary particle. The gauge currents for CP_2 type vacuum extremals have a vanishing covariant divergence so that there are no conserved charges besides Kähler charge. Hence electro-weak gauge charges are not conserved classically in the region between causal horizons whereas color gauge charges are. This could explain the vacuum screening of electro-weak charges at space-time level. This is required since for the known solutions of field equations other than CP_2 type extremals vacuum screening does not occur.
- (d) In the special case space-time sheets have opposite time orientations and the causal horizons carry opposite quantum numbers (with four-momentum included) the $\#$ contact would serve the passive role of flux mediator and one could assign to the contact generalized gauge fluxes as quantum numbers associated with the causal horizons. This is the case if the contact is created from vacuum in topological condensation so that the quantum numbers associated with the horizons define naturally generalized gauge fluxes. Kind of generalized quantum dipoles living in two space-times simultaneously would be in question. $\#$ contacts in the ground state for space-time sheets with opposite time orientation can be also seen as zero energy parton-antiparton pairs bound together by a piece of CP_2 type extremal.
- (e) When space-time sheets have same time orientation, the two-parton state associated with the $\#$ contact has non-vanishing energy and it is not clear whether it can be stable.

$\#_B$ contacts as bound parton pairs

Besides $\#$ contacts also join along boundaries bonds (JABs, $\#_B$ contacts) are possible. They can connect outer boundaries of space-time sheets or the boundaries of small holes associated with the interiors of two space-time sheets which can have Minkowskian signature of metric and can mediate classical gauge fluxes and are excellent candidates for mediators of gauge interactions between space-time sheet glued to a larger space-time sheet by topological sum contacts and join along boundaries contacts. The size scale of the causal horizons associated with parton pairs can be arbitrary whereas the size scale of $\#$ contacts is given by CP_2 radius.

The existence of the holes for real space-time surfaces is a natural consequence of the induced gauge field concept: for sufficiently strong gauge fields the imbeddability of gauge field as an induced gauge field fails and hole in space-time appears as a consequence. The holes connected by $\#_B$ contacts obey field equations, and a good guess is that they are light-like 3-surfaces and carry parton quantum numbers. This would mean that both $\#$ and $\#_B$ contacts allow a fundamental description in terms of pair of partons.

Magnetic flux tubes provide a representative example of $\#_B$ contact. Instead of $\#_B$ contact also more descriptive terms such as join along boundaries bond (JAB), color bond, and magnetic flux tube are used. $\#_B$ contacts serve also as a space-time correlate for bound state formation and one can even consider the possibility that entanglement might have braiding of bonds defined by $\#$ contacts as a space-time correlate [K88].

It seems difficult to exclude join along boundaries contacts between between holes associated with the two space-time sheets at different levels of p-adic hierarchy. If these contacts are possible, a transfer of conserved gauge fluxes would be possible between the two space-time sheets and one could speak about interaction in conventional sense.

Topological condensation and evaporation

Topological condensation corresponds to a formation of $\#$ or $\#_B$ contacts between space-time sheets. Topological evaporation means the splitting of $\#$ or $\#_B$ contacts. In the case of elementary particles the process changes almost nothing since the causal horizon carrying parton quantum numbers does not disappear. The evaporated CP_2 type vacuum extremal having interpretation as a gravitational instanton can carry only color quantum numbers.

As $\#$ contact splits partons are created at the two space-time sheets involved. This process can obviously generate from vacuum space-time sheets carrying particles with opposite signs of energies and other quantum numbers. Positive energy matter and negative energy anti-matter could be thus created by the formation of $\#$ contacts with zero net quantum numbers which then split to produce pair of positive and negative energy particles at different space-time sheets having opposite time orientations. This mechanism would allow a creation of positive energy matter and negative energy antimatter with an automatic separation of matter and antimatter at space-time sheets having different time orientation. This might resolve elegantly the puzzle posed by matter-antimatter asymmetry.

The creation of $\#$ contact leads to an appearance of radial gauge field in condensate and this seems to be impossible at the limit of infinitely large space-time sheet since it involves a radical instantaneous change in field line topology. The finite size of the space-time sheet can however resolve the difficulty.

If all quantum numbers of elementary particle are expressible as gauge fluxes, the quantum numbers of topologically evaporated particles should vanish. In the case of color quantum numbers and Poincare quantum numbers there is no obvious reason why this should be the case. Despite this the cancellation of the interior quantum numbers by those at boundaries or light-like causal determinants could occur and would conform with the effective 2-dimensionality stating that quantum states are characterized by partonic boundary states associated with causal determinants. This could be also seen as a holographic duality of interior and boundary degrees of freedom [K76].

3.3.2 Gauge charges and gauge fluxes

The concepts of mass and gauge charge in TGD has been a source of a chronic headache. There are several questions waiting for a definite answer. How to define gauge charge? What is the microscopic physics behind the gauge charges necessarily accompanying long range gravitational fields? Are these gauge charges quantized in elementary particle level? Can one associate to elementary particles classical electro-weak gauge charges equal to its quantized value or are all electro-weak charges screened at intermediate boson length scale? Is the generation of the vacuum gauge charges, allowed in principle by the induced gauge field concept, possible in macroscopic length scales? What happens to the gauge charges in topological evaporation? Should Equivalence Principle be modified in order to understand the fact that Robertson-Walker metrics are inertial but not gravitational vacua.

How to define the notion of gauge charge?

In TGD gauge fields are not primary dynamical variables but induced from the spinor connection of CP_2 . There are two manners to define gauge charges.

- (a) In purely group theoretical approach one can associate non-vanishing gauge charge to a 3-surface of finite size and quantization of the gauge charge follows automatically. This definition should work at Planck length scales, when particles are described as 3-surfaces of CP_2 size and classical space-time mediating long range interactions make no sense. Gauge interactions are mediated by gauge boson exchange, which in TGD has topological description in terms of CP_2 type vacuum extremals [K11].
- (b) Second definition of gauge charge is as a gauge flux over a closed surface. In this case quantization is not obvious nor perhaps even possible at classical level except perhaps for Abelian charges. For a closed 3-surface gauge charge vanishes and one might well argue that this is the case for finite 3-surface with boundary since the boundary conditions might well generate gauge charge near the boundary cancelling the gauge charge created by particles condensed on 3-surface. This would mean that at low energies (photon wavelength large than size of the 3-surfaces) the 3-surfaces in vapor phase look like neutral particles. Only at high energies the evaporated particles would behave as ordinary elementary particles. Furthermore, particle leaves in topological evaporation its gauge charge in the condensate.

The alternative possibility that the long range $\frac{1}{r^2}$ gauge field associated with particle disappears in the evaporation, looks topologically impossible at the limit when larger space-time sheet has infinite size: only the simultaneous evaporation of opposite gauge charges might be possible in this manner at this limit. Topological evaporation provides a possible mechanism for the generation of vacuum gauge charges, which is one basic difference between TGD and standard gauge theories.

There is a strong temptation to draw a definite conclusion but it is better to be satisfied with a simplifying working hypothesis that gauge charges are in long length scales definable as gauge fluxes and vanish for macroscopic 3-surfaces of finite size in vapor phase. This would mean that the topological evaporation of say electron as an electromagnetically charged particle would not be possible except at CP_2 length scale: in the evaporation from secondary condensation level electron would leave its gauge charges in the condensate. Vapor phase particle still looks electromagnetically charged in length scales smaller than the size of the particle surface if the neutralizing charge density is near (or at) the boundary of the surface and gauge and gravitational interactions are mediated by the exchange of CP_2 type extremals.

In what sense could # contacts feed gauge fluxes?

One can associate with the # throats magnetic gauge charges $\pm Q_i$ defined as gauge flux running to or from the throat. The magnetic charges are of opposite sign and equal magnitude on the two space-time sheets involved. For Kähler form the value of magnetic flux is quantized and non-vanishing only if the $t = \text{constant}$ section of causal horizon corresponds to a non-trivial homology equivalence class in CP_2 so that # contact can be regarded as a homological magnetic monopole. In this case # contacts can be regarded as extremely small magnetic dipoles formed by tightly bound # throats possessing opposite magnetic gauge charges. # contacts couple to the difference of the classical gauge fields associated with the two space-time sheets and matter-# contact and # contact-# contact interaction energies are in general non-vanishing.

Electric gauge fluxes through # throat evaluated at the light-like elementary particle horizon X_l^3 tend to be either zero or infinite. The reason is that without appropriate boundary conditions the normal component of electric $F^{tn} \sqrt{(g_4)}/g^2$ either diverges or is infinite since g^{tt} diverges by the effective three-dimensionality of the induced metric at X_l^3 . In the gravitational case an additional difficulty is caused by the fact that it is not at all clear whether the notion of gravitational flux is well defined. It is however possible to assign gravitational mass to a given space-time sheets as will be found in the section about space-time description of charge renormalization.

The simplest conclusion would be that the notions of gauge and gravitational fluxes through # contacts do not make sense and that # contacts mediate interactions in a more subtle manner. For instance, for a space-time sheet topologically condensed at a larger space-time sheet the larger space-time sheet would characterize the basic coupling constants appearing in the S-matrix associated with the topologically condensed space-time sheets. In particular, the value of \hbar would characterize the relation between the two space-time sheets. A stronger hypothesis would be that the value of \hbar is coded partially by the Jones inclusion between the state spaces involved. The larger space-time sheet would correspond to dark matter from the point of view of smaller space-time sheet [K90, K27].

One can however try to find loopholes in the argument.

- (a) It might be possible to pose the finiteness of $F^{tn} \sqrt{g_4}/g^2$ as a boundary condition. The variation principle determining space-time surfaces implies that space-time surfaces are analogous to Bohr orbits so that there are also hopes that gauge fluxes are quantized.
- (b) Another way out of this difficulty could be based on the basic idea behind renormalization in TGD framework. Gauge coupling strengths are allowed to depend on space-time point so that the gauge currents are conserved. Gauge coupling strengths $g^2/4\pi$ could become infinite at causal horizon. The infinite values of gauge couplings at causal horizons might be a TGD counterpart for the infinite values of bare gauge couplings in quantum field theories. There are however several objections against this idea. The values of coupling constants should depend on space-time sheet only so that the situation is not improved by this trick

in CP_2 length scale. Dependence of g^2 on space-time point means also that in the general case the definition of gauge charge as gauge flux is lost so that gauge charges do not reduce to fluxes.

It seems that the notion of a finite electric gauge flux through the causal horizon need not make sense as such. Same applies to the notion of gravitational gauge flux. The notion of gauge flux seems however to have a natural quantal generalization. The creation of a $\#$ contact between two space-time sheets creates two causal horizons identifiable as partons and carrying conserved charges assignable with the states created using the fermionic oscillator operators associated with the second quantized induced spinor field. These charges must be of opposite sign so that electric gauge fluxes through causal horizons are replaced by quantal gauge charges. For opposite time orientations also four-momenta cancel each other. The particle states can of course transform by interactions with matter at the two-space-time sheets so that the resulting contact is not a zero energy state always.

This suggests that for gauge fluxes at the horizon are identifiable as opposite quantized gauge charges of the partons involved. If the net gauge charges of $\#$ contact do not vanish, it can be said to possess net gauge charge and does not serve as a passive flux mediator anymore. The possibly screened classical gauge fields in the region faraway from the contact define the classical correlates for gauge fluxes. A similar treatment applies to gravitational flux in the case that the time orientations are opposite and gravitational flux is identifiable as gravitational mass at the causal horizon.

Internal consistency would mildly suggest that $\#$ contacts are possible only between space-time sheets of opposite time orientation so that gauge fluxes between space-time sheets of same time orientation would flow along $\#_B$ bonds.

Are the gauge fluxes through $\#$ and $\#_B$ contacts quantized?

There are good reasons (criticality of the Kähler action plus maximization of the Kähler function) to expect that the gauge fluxes through $\#$ (if well-defined) and $\#_B$ contacts are quantized. The most natural guess would be that the unit of electric electromagnetic flux for $\#_B$ contact is $1/3$ since this makes it possible for the electromagnetic gauge flux of quarks to flow to larger space-time sheets. Anyons could however mean more general quantization rules [K88]. The quantization of electromagnetic gauge flux could serve as a unique experimental signature for $\#$ and $\#_B$ contacts and their currents. The contacts can carry also magnetic fluxes. In the case of $\#_B$ contacts the flux quantization would be dynamical and analogous to that appearing in super conductors.

Hierarchy of gauge and gravitational interactions

The observed elementary particles are identified as CP_2 type extremals topologically condensed at space-time sheets with Minkowski signature of induced metric with elementary particle horizon being responsible for the parton aspect. This suggests that at CP_2 length scale gauge and gravitational interactions correspond to the exchanges of CP_2 type extremals with light-like M^4 projection with branching of CP_2 type extremal serving as the basic vertex as discussed first in the earliest attempt to construct [K1] and years later in terms of generalized Feynman diagrams. The gravitational and gauge interactions between the partons assignable to the two causal horizons associated with $\#$ contact would be mediated by the $\#$ contact, which can be regarded as a gravitational instanton and the interaction with other particles at space-time sheets via classical gravitational fields.

Gauge fluxes flowing through the $\#_B$ contacts would mediate higher level gauge and interactions between space-time sheets rather than directly between CP_2 type extremals. The hierarchy of flux tubes defining string like objects strongly suggests a p-adic hierarchy of "strong gravities" with gravitational constant of order $G \sim L_p^2$, and these strong gravities might correspond to gravitational fluxes mediated by the flux tubes.

3.3.3 Can one regard $\#$ resp. $\#_B$ contacts as particles resp. string like objects?

$\#$ -contacts have obvious particle like aspects identifiable as either partons or parton pairs. $\#_B$ contacts in turn behave like string like objects. Using the terminology of M-theory, $\#_B$ contacts connecting the boundaries of space-time sheets could be also seen as string like objects connecting two branes. Again the ends holes at the ends of $\#_B$ contacts carry well defined gauge charges.

$\#$ contacts as particles and $\#_B$ contacts as string like objects?

The fact that $\#$ contacts correspond to parton pairs raises the hope that it is possible to apply p-adic thermodynamics to calculate the masses of $\#$ contact and perhaps even the masses of the partons. If this the case, one has an order of magnitude estimate for the first order contribution to the mass of the parton as $m \sim 1/L(p_i)$, $i = 1, 2$. It can of course happen that the first order contribution vanishes: in this case an additional factor $1/\sqrt{p_i}$ appears in the estimate and makes the mass extremely small.

For $\#$ contacts connecting space-time sheets with opposite time orientations the vanishing of the net four-momentum requires $p_1 = p_2$. According to the number theoretic considerations below it is possible to assign several p-adic primes to a given space-time sheet and the largest among them, call it p_{max} , determines the p-adic mass scale. The milder condition is that p_{max} is same for the two space-time sheets.

There are some motivations for the working hypothesis that $\#$ contacts and the ends of $\#_B$ contacts feeding the gauge fluxes to the lower condensate levels or vice versa tend to be located near the boundaries of space-time sheets. For gauge charges which are not screened by vacuum charges (em and color charges) the imbedding of the gauge fields created by the interior gauge charges becomes impossible near the boundaries and the only possible manner to satisfy boundary conditions is that gauge fluxes flow to the larger space-time sheet and space-time surface becomes a vacuum extremal of the Kähler action near the boundary.

For gauge bosons the density of boundary $\#_B$ contacts should be very small in length scales, where matter is essentially neutral. For gravitational $\#_B$ contacts the situation is different. One might well argue that there is some upper bound for the gravitational flux associated with single $\#$ or $\#_B$ contact (or equivalently the gravitational mass associated with causal horizon) given by Planck mass or CP_2 mass so that the number of gravitational contacts is proportional to the mass of the system.

Could $\#$ and $\#_B$ contacts form macroscopic quantum phases?

The description as $\#$ contact as a parton pair suggests that it is possible to assign to $\#$ contacts inertial mass, say of order $1/L(p)$, they should be describable using d'Alembert type equation for a scalar field. $\#$ contacts couple dynamically to the geometry of the space-time since the induced metric defines the d'Alembertian. There is a mass gap and hence $\#$ contacts could form a Bose-Einstein (BE) condensate to the ground state. If $\#$ contacts are located near the boundary of the space-time surface, the d'Alembert equation would be 3-dimensional. One can also ask whether $\#$ contacts define a particular form of dark matter having only gravitational interactions with the ordinary matter.

Also coherent states of $\#$ contacts are possible and as will be found, Higgs mechanism could be understood as a generation of coherent state of neutral Higgs particles identified as worm-hole contacts having quantum numbers of left (right) handed fermion and right (left) handed antifermion.

Also the probability amplitudes for the positions of the ends of $\#_B$ contacts located at the boundary of the space-time sheet could be described using an order parameter satisfying d'Alembert equation with some mass parameter and whether the notion of Bose-Einstein condensate makes sense also now. The model for atomic nucleus assigns to the ends of the $\#_B$ contact realized as a color magnetic flux tube having at its ends quark and anti-quark with mass scale given by $k = 127$ (MeV scale) [K77].

3.3.4 TGD based description of external fields

The description of a system in external field provides a nontrivial challenge for TGD since the system corresponds now to a p-adic space-time sheet k_1 condensed on background 3-surface $k_2 > k_1$. The problem is to understand how external fields penetrate into the smaller space-time sheet and also how the gauge fluxes inside the smaller space-time sheet flow to the external space-time sheet. One should also understand how the penetrating magnetic or electric field manages to preserve its value (if it does so). A good example is provided by the description of system, such as atom or nucleus, in external magnetic or electric field. There are several mechanisms of field penetration:

Induction mechanism

In the case of induction fields are mediated from level k_1 to levels $k_2 \neq k_1$. The external field at given level k_1 acts on $\#$ and $\#_B$ throats (both accompanied by a pair of partons) connecting levels k_2 and k_1 . The motion of $\#$ and $\#_B$ contacts, induced by the gauge and gravitational couplings of partons involved to classical gauge and gravitational fields, creates gauge currents serving as sources of classical gauge field at the space-time sheets involved. This mechanism involves "dark" partons not predicted by standard model.

A good example is provided by the rotation of charged $\#$ throats induced by a constant magnetic field, which in turn creates constant magnetic field inside a cylindrical condensate space-time sheet. A second example is the polarization of the charge density associated with the $\#$ throats in the external electric field, which in turn creates a constant electric field inside the smaller space-time sheet.

One can in principle formulate general field equations governing the penetration of a classical gauge field from a given condensate level to other levels. The simplified description is based on the introduction of series of fields associated with various condensate levels as analogs of H and B and D and E fields in the ordinary description of the external fields. The simplest assumption is that the fields are linearly related. A general conclusion is that due to the delicacies of the induced field concept, the fields on higher levels appear in the form of flux quanta and typically the field strengths at the higher condensate levels are stronger so that the penetration of field from lower levels to the higher ones means a decomposition into separate flux tubes.

The description of magnetization in terms of the effective field theory of Weiss introduces effective field H , which is un-physically strong: a possible explanation as a field consisting of flux quanta at higher condensate levels. A general order of magnitude estimate for field strength of magnetic flux quantum at condensate level k is as $1/L^2(k)$.

Penetration of magnetic fluxes via $\#$ contacts

At least magnetic gauge flux can flow from level p_1 to level p_2 via $\#$ contacts. These surfaces are of the form $X^2 \times D^1$, where X^2 is a closed 2-surface. The simplest topology for X^2 is that of sphere S^2 . This leads to the first nontrivial result. If a nontrivial magnetic flux flows through the contact, it is quantized. The reason is that magnetic flux is necessarily over a closed surface.

The concept of induced gauge field implies that magnetic flux is nontrivial only if the surface X^2 is homologically nontrivial: CP_2 indeed allows homologically nontrivial sphere. Ordinary magnetic field can be decomposed into co-homologically trivial term plus a term proportional to Kähler form and the flux of ordinary magnetic field comes only from the part of the magnetic field proportional to the Kähler form and the magnetic flux is an integer multiple of some basic flux.

The proposed mechanism predicts that magnetic flux can change only in multiples of basic flux quantum. In super conductors this kind of behavior has been observed. Dipole magnetic fields can be transported via several $\#$ contacts: the minimum is one for ingoing and one for return flux so that magnetic dipoles are actual finite sized dipoles on the condensed surface. Also the transfer of magnetic dipole field of, say neutron inside nucleus, to lower condensate level leads to similar magnetic dipole structure on condensate level. For this mechanism the topological

condensation of elementary particle, say charged lepton space-time sheet, would involve at least two $\#$ contacts and the magnetic moment is proportional to the distance between these contacts. The requirement that the magnetic dipole formed by the $\#$ contacts gives the magnetic moment of the particle gives an estimate for the distance d between $\#$ throats: by flux quantization the general order of magnitude is given by $d \sim \frac{\alpha_{em} 2\pi}{m}$.

Penetration of electric gauge fluxes via $\#$ contacts

For $\#$ contact for the opposite gauge charges of partons define the value of generalized gauge electric flux between the two space-time sheets. In this case it is also possible to interpret the partons as sources of the fields at the two space-time sheets. If the $\#$ contacts are near the boundary of the smaller space-time sheet the interpretation as a flow of gauge flux to a larger space-time sheet is perfectly sensible. The partons near the boundary can be also seen as generators of a gauge field compensating the gauge fluxes from interior.

The distance between partons can be much larger than p-adic cutoff length $L(k)$ and a proper spatial distribution guarantees homogeneity of the magnetic or electric field in the interior. The distances of the magnetic monopoles are however large in this kind of situation and it is an open problem whether this kind of mechanism is consistent with experimental facts.

An estimate for the electric gauge flux Q_{em} flowing through the $\#$ contact is obtained as $n \sim \frac{E}{QL(k)}$: $Q \sim EL^2(k)$, which is of same order of magnitude as electric gauge flux over surface of area $L^2(k)$. In magnetic case the estimate gives $Q_M \sim BL^2(k)$: the quantization of Q_M is consistent with homogeneity requirement only provided the condition $B > \frac{\Phi_0}{L^2(k)}$, where Φ_0 is elementary flux quantum, holds true. This means that flux quantization effects cannot be avoided in weak magnetic fields. The second consequence is that too weak magnetic field cannot penetrate at all to the condensed surface: this is certainly the case if the total magnetic flux is smaller than elementary flux quantum. A good example is provided by the penetration of magnetic field into cylindrical super conductor through the end of the cylinder. Unless the field is strong enough the penetrating magnetic field decomposes into vortex like flux tubes or does not penetrate at all.

The penetration of flux via dipoles formed by $\#$ contacts from level to a second level in the interior of condensed surface implies phenomena analogous to the generation of polarization (magnetization) in dielectric (magnetic) materials. The conventional description in terms of fields H, B, M and D, E, P has nice topological interpretation (which does not mean that the mechanism is actually at work in condensed matter length scales). Magnetization M (polarization P) can be regarded as the density of fictitious magnetic (electric) dipoles in the conventional theory: the proposed topological picture suggests that these quantities essentially as densities for $\#$ contact pairs. The densities of M and P are of opposite sign on the condensed surface and condensate. $B = H - M$ corresponds to the magnetic field at condensing surface level reduced by the density $-M$ of $\#$ contact dipoles in the interior. H denotes the external field at condensate level outside the condensing surface, M ($-M$) is the magnetic field created by the $\#$ contact dipoles at condensate (condensed) level. Similar interpretation can be given for D, E, P fields. The penetrating field is homogenous only above length scales larger than the distance between $\#$ throats of dipoles: p-adic cutoff scale $L(k)$ gives natural upper bound for this distance: if this is the case and the density of the contacts is at least of order $n \sim \frac{1}{L^3(k)}$ the penetrating field can be said to be constant also inside the condensed surface.

In condensed matter systems the generation of ordinary polarization and magnetization fields might be related to the permanent $\#$ contacts of atomic surfaces with, say, $k = 139$ level. The field created by the neutral atom contains only dipole and higher multipoles components and therefore at least two $\#$ contacts per atom is necessary in gas phase, where join along boundaries contacts between atoms are absent. In the absence of external field these dipoles tend to have random directions. In external field $\#$ throats behave like opposite charges and their motion in external field generates dipole field. The expression of the polarization field is proportional to the density of these static dipole pairs in static limit. $\#$ contacts make possible the penetration of external field to atom, where it generates atomic transitions and leads to the emission of dipole type radiation field, which gives rise to the frequency dependent part of dielectric constant.

Penetration via $\#_B$ contacts

The field can also through $\#_B$ contacts through the boundary of the condensed surface or through the small holes in its interior. The quantization of electric charge quantization would reduce to the quantization of electric gauge flux in $\#_B$ contacts. If there are partons at the ends of contact they affect the gauge gauge flux.

The penetration via $\#_B$ contacts necessitates the existence of join along boundaries bonds starting from the boundary of the condensed system and ending to the boundary component of a hole in the background surface. The field flux flows simply along the 3-dimensional stripe $X^2 \times D^1$: since X^2 has boundary no flux quantization is necessary. This mechanism guarantees automatically the homogeneity of the penetrating field inside the condensed system.

An important application for the theory of external fields is provided by bio-systems in which the penetration of classical electromagnetic fields between different space-time sheets should play central role: what makes the situation so interesting is that the order parameter describing the $\#$ and $\#_B$ Bose-Einstein condensates carries also phase information besides the information about the strength of the normal component of the penetrating field.

3.3.5 Number theoretical considerations

Number theoretical considerations allow to develop more quantitative vision about the how p-adic length scale hypothesis relates to the ideas just described.

How to define the notion of elementary particle?

p-Adic length scale hierarchy forces to reconsider carefully also the notion of elementary particle. p-Adic mass calculations led to the idea that particle can be characterized uniquely by single p-adic prime characterizing its mass squared. It however turned out that the situation is probably not so simple.

The work with modelling dark matter suggests that particle could be characterized by a collection of p-adic primes to which one can assign weak, color, em, gravitational interactions, and possibly also other interactions. It would also seem that only the space-time sheets containing common primes in this collection can interact. This leads to the notions of relative and partial darkness. An entire hierarchy of weak and color physics such that weak bosons and gluons of given physics are characterized by a given p-adic prime p and also the fermions of this physics contain space-time sheet characterized by same p-adic prime, say M_{89} as in case of weak interactions. In this picture the decay widths of weak bosons do not pose limitations on the number of light particles if weak interactions for them are characterized by p-adic prime $p \neq M_{89}$. Same applies to color interactions.

The p-adic prime characterizing the mass of the particle would perhaps correspond to the largest p-adic prime associated with the particle. Graviton which corresponds to infinitely long ranged interactions, could correspond to the same p-adic prime or collection of them common to all particles. This might apply also to photons. Infinite range might mean that the join along boundaries bonds mediating these interactions can be arbitrarily long but their transversal sizes are characterized by the p-adic length scale in question.

The natural question is what this collection of p-adic primes characterizing particle means? The hint about the correct answer comes from the number theoretical vision, which suggests that at fundamental level the branching of boundary components or more generally wormhole throats to two or more components, completely analogous to the branching of line in Feynman diagram, defines vertices [K22, K18].

- (a) If space-time sheets correspond holographically to multi-p p-adic topology such that largest p determines the mass scale, the description of particle reactions in terms of branchings indeed makes sense. This picture allows also to understand the existence of different scaled up copies of QCD and weak physics. Multi-p p-adicity could number theoretically correspond to q-adic topology for $q = m/n$ a rational number consistent with p-adic topologies

associated with prime factors of m and n ($1/p$ -adic topology is homeomorphic with p -adic topology).

- (b) One could also imagine that different p -adic primes in the collection correspond to different space-time sheets condensed at a larger space-time sheet or boundary components of a given space-time sheet. If the boundary topologies for gauge bosons are completely mixed, as the model of hadrons forces to conclude, this picture is consistent with the topological explanation of the family replication phenomenon and the fact that only charged weak currents involve mixing of quark families. The problem is how to understand the existence of different copies of say QCD. The second difficult question is why the branching leads always to an emission of gauge boson characterized by a particular p -adic prime, say M_{89} , if this p -adic prime does not somehow characterize also the particle itself.

What effective p -adic topology really means?

The need to characterize elementary particle p -adically leads to the question what p -adic effective topology really means. p -Adic mass calculations leave actually a lot of room concerning the answer to this question.

- (a) The naivest option is that each space-time sheet corresponds to single p -adic prime. A more general possibility is that the boundary components of space-time sheet correspond to different p -adic primes. This view is not favored by the view that each particle corresponds to a collection of p -adic primes each characterizing one particular interaction that the particle in question participates.
- (b) A more abstract possibility is that a given space-time sheet or boundary component can correspond to several p -adic primes. Indeed, a power series in powers of given integer n gives rise to a well-defined power series with respect to all prime factors of n and effective multi- p -adicity could emerge at the level of field equations in this manner.

One could say that space-time sheet or boundary component corresponds to several p -adic primes through its effective p -adic topology in a hologram like manner. This option is the most flexible one as far as physical interpretation is considered. It is also supported by the number theoretical considerations predicting the value of gravitational coupling constant [K79] .

An attractive hypothesis is that only space-time sheets characterized by integers n_i having common prime factors can be connected by join along boundaries bonds and can interact by particle exchanges and that each prime p in the decomposition corresponds to a particular interaction mediated by an elementary boson characterized by this prime.

The physics of quarks and hadrons provides an immediate test for this interpretation. The surprising and poorly understood conclusion from the p -adic mass calculations was that the p -adic primes characterizing light quarks u,d,s satisfy $k_q < 107$, where $k = 107$ characterizes hadronic space-time sheet [K56] .

- (a) The interpretation of $k = 107$ space-time sheet as a hadronic space-time sheet implies that quarks topologically condense at this space-time sheet so that $k = 107$ cannot belong to the collection of primes characterizing quark.
- (b) Quark space-time sheets must satisfy $k_q < 107$ unless \hbar is large for the hadronic space-time sheet so that one has $k_{eff} = 107 + 22 = 129$. This predicts two kinds of hadrons. Low energy hadrons consists of u, d, and s quarks with $k_q < 107$ so that hadronic space-time sheet must correspond to $k_{eff} = 129$ and large value of \hbar . One can speak of confined phase. This allows also $k = 127$ light variants of quarks appearing in the model of atomic nucleus [K77] . The hadrons consisting of c,t,b and the p -adically scaled up variants of u,d,s having $k_q > 107$, \hbar has its ordinary value in accordance with the idea about asymptotic freedom and the view that the states in question correspond to short-lived resonances.

3.4 The new space time picture and some of its consequences

The previous considerations suggest that TGD space-time has a hierarchical, fractal like structure consisting of an infinite number of condensate levels n characterized by length scale $L(n) < L(n+1)$ identifiable as a typical size for 3-surface at level n . Spin glass analogy suggests that the label n corresponds to preferred primes characterizing p-adic length scales and to values of Planck constant labelling levels of dark matter hierarchy. p-Adic fractality means that for each p there is actually a length scale hierarchy coming in powers of \sqrt{p} . An infinite hierarchy of copies of standard model physics is an unavoidable prediction if quantum classical correspondence is taken seriously and can be identified as dark matter hierarchy.

3.4.1 Topological condensation and formation of bound states

It is tempting to identify the physical counterpart of the topological condensate in the length scale L as a bound state with size L . If this assumption is accepted then one ends up to the rather beautiful general scenario for the hierarchical structure of the 3-space. Quarks (3-surface of size of CP_2 length, so called CP_2 type extremals to be discussed later) condense around the hadronic 3-surfaces, hadrons condense around a piece of Minkowski space with size of order $10^{-14} - 10^{-15}$ meters to form nuclei, nuclei and electrons condense to form atoms of size of the order 10^{-10} meters or larger, atoms condense to form molecules, etc.

Generalizing the previous ideas, one ends up to a rather exciting possibility for a topological description of the macroscopic states of matter. Consider solids as an example. Solids correspond to a regular lattice of atomic or molecular 3-surfaces condensed to background 3-space. There are two kinds of forces binding the structure together.

- i) There are interactions mediated via the the fields of the background 3-space and these correspond to the ordinary electric forces.
- ii) There is interaction resulting from the "contacts" between the boundaries of the neighboring atoms (for a two-dimensional visualization see Fig. 3.4.1). Join along boundaries bond means mathematically a tube $D^2 \times D^1$ connecting the boundaries together or equivalently, topological condensation for the boundaries. This interaction is completely new and has as its counterpart the forces generated by the electron exchange between atoms believed to explain the binding between the atoms of certain solids. It is however clear that something quite new is introduced so that the conventional belief that Schrödinger equation in a flat 3-space alone explains these interactions would not be correct in TGD context. That the approach based on Schrödinger equation have not lead to contradictions can be understood also: what join along boundaries bond makes is to select among possible solutions of Schrödinger equation those realized in Nature by forcing the Schrödinger amplitude to the bridges connecting different structural units.

The topological description of the liquid state goes along similar lines. Now however the contacts between neighboring atoms are not so rigid the reason being that thermal noise continually splits these contacts. A completely new element is the emergence of the vacuum quantum numbers and should lead to effects differentiating between TGD and more conventional approaches.

3.4.2 3-topology and chemistry

The practical models for chemical systems rely on the assumption that a chemical element has a well defined geometric shape. If this assumption is made then Schrödinger equation in electronic degrees of freedom combined with symmetry considerations gives satisfactory results. The general belief is that the complete Schrödinger equation treating quantum mechanically also the positions of the atoms predicts also the geometric structure of the chemical compounds. Unfortunately, in practice it is not possible to check numerically the correctness of this belief.

The "join along boundaries" interaction is a second standard phenomenological concept in the chemistry. What happens that reactants join along a part of their boundaries together to form a transition state (or a final state) and the reaction takes place in the new geometry. The

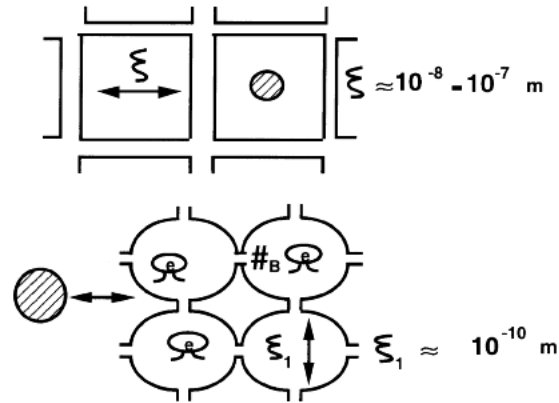

Figure 3.3: How one could understand the solid state topologically in terms of the join along boundaries interaction: 2-dim. visualization

chemistry of the biological systems relies heavily on this concept. For example, the catalytic action of the enzymes is often understood on the basis of key and lock principle: enzyme acts on the protein only provided the surfaces of the protein and enzyme fit together like lock and key. Usually it is believed that the association of a geometric form to chemical compounds and the "join along boundaries" mechanism provide an easy short hand description, which is in principle derivable from the complete Schrödinger equations. TGD suggests that this is not be the case.

What is exciting that this kind of idea leads to a completely fresh approach to the understanding of bio-systems: the basic principles of the underlying the biochemistry could be formulated in terms of the 3-topology. The biological information processing could involve the manipulation of the 3-topology or more precisely: the manipulation of the boundary topology if "join along boundaries" is indeed the basic mechanism. It should noticed also that the emergence of the vacuum quantum numbers is characteristic feature of TGD and provides a possible means for realizing the Universe as Computer idea in biological systems. xc

3.4.3 3-topology and super-conductivity

The #-contacts (wormholes) feeding the gauge fluxes from a given sheet of the 3-space to a larger one, can be regarded as particles carrying classical charges defined by the gauge fluxes. These particles must be light, which suggests that #-contacts can form Bose-Einstein condensate or coherent state identifiable in terms of Higgs vacuum expectation value. This BE condensate provides a possible explanation of so called Comorosan effect [I6] observed in organic molecules. A related effect is the formation of exotic atoms, when some valence electrons drop from the atomic space-time sheet to a larger space-time sheet. This process is accompanied by the generation of #-contacts. The process leads to the effective lowering of the valence of the original atom and thus to "electronic alchemy". The claimed peculiar properties of so called ORMES [H6] could have explanation as exotic atoms as suggested in [K15, K16].

I have also suggested that the basic mechanism of super-conductivity somehow involves quantum coherent states of wormhole contacts. This might be the case although not quite in the original sense. There are two poorly understood problems involved with super-conductivity.

- (a) Super-conductor is often modelled as a coherent state of Cooper pairs. The conceptual problem is that the electric charge of this state is not well-defined and this is definitely in conflict with the conservation of electromagnetic charge.

- (b) The massivation of photons is a second poorly understood basic aspect of super-conductivity. The obvious question is whether this process could be interpreted in terms of a vacuum expectation value of a charged Higgs field and whether the charge of the Higgs field resolve the paradox otherwise created by the non-conservation of electromagnetic charge.

The obvious guess is that superconductor corresponds to superposition of quantum states with a well-defined total em charge such that electronic electromagnetically charge of some electronic Cooper pairs has been transferred to neutral wormhole contacts having quantum numbers of charged left/right handed positron and neutral right/left handed neutrino so that some Cooper pairs themselves have been transmuted to neutrino Cooper pairs.

In ordinary phase a space-time sheet carrying N Cooper pairs would feed em charge to a larger space-time sheet by $2N$ wormhole contacts consisting of e^+e^- parton pair. Super-conducting phase would correspond to a superposition of states for which $2M \leq 2N$ wormhole contacts have become electromagnetically charged and $2M$ electrons have transformed to neutrinos. Coherent state would thus correspond to a superposition of states with $M \leq N$ neutrino pairs, $N - M$ Cooper pairs, and $2M$ charged wormhole contacts.

The presence of exotic W bosons mediating weak interactions in the scale of the space-time sheet would make possible this kind of states (which involved entanglement between wormhole contacts and Cooper pairs). The model would require that neutrinos and electrons in the superconducting phase have nearly identical masses and thus correspond to $p = M_{127}$, the largest Mersenne prime which corresponds to non-super-astronomical p-adic length scale. This conforms also with the absence of electro-weak symmetry breaking below the p-adic length scale characterizing the size of the Cooper pair. Also the quantum model for hearing [K65] requires that exotic neutrinos with mass very near to electron mass are involved. The TGD based model for atomic nucleus [K77] in turn predicts that quarks with mass near to electron mass appear at the ends of the color bonds connecting nucleons.

3.4.4 Macroscopic bodies as a topology of 3-space

The natural generalization of the foregoing ideas is that even the macroscopic bodies of the everyday world correspond to 3-surfaces, which have suffered topological condensation to the background 3-space. The outer surfaces of the macroscopic bodies would correspond to the boundaries of a particular space-time sheet. When macroscopic bodies touch each other, a partial join along boundaries would take place. We would live in the middle of a wild science fiction without realizing it!

Paradoxically, this new interaction is extremely familiar for us. The surface of the Earth corresponds to a boundary of a rather big 3-surface. At smaller length scales we see flowers, trees and all kinds of things and also these are 3-surfaces, which have joined along their boundaries to the surface of the Earth. Our biological bodies correspond to 3-surfaces having boundaries. We have however the special ability to cut this contact rather easily and to move quite freely although the gravitational force acting in the background 3-space takes care that the join along the boundaries with the surface of Earth is the usual state of affairs. When I touch the surface of the table by finger, a join along boundaries interaction takes place: we even recognize different objects just by touching them. We also smell and taste and at the microscopic level these senses are based on the join along boundaries interaction. Despite all this it has not been explicitly recognized that the formation of the join along boundaries bond might be a fundamental physical interaction!

What is also amusing that the implicit assumptions of any physical model of the macroscopic world is based on the assumptions about the geometric form of the physical objects and also the join along boundaries interaction is introduced implicitly into the description. For example, in order to describe solid state one draws lattice: one draws atoms in this lattice and bonds between the atoms. A second example is provided by the description of mechanical system consisting of rigid bodies.

In present picture this description is obtained by projecting the boundary of the 3-space to flat space E^3 : matter in the conventional sense corresponds to the shadow of the boundary-topology

of 3-surface (for a 2-dimensional illustration see Fig.3.4.4). The fact that this kind of description is so obvious masks the fact that it is far from trivial whether one can actually deduce this kind of description starting from wave mechanics or QED.

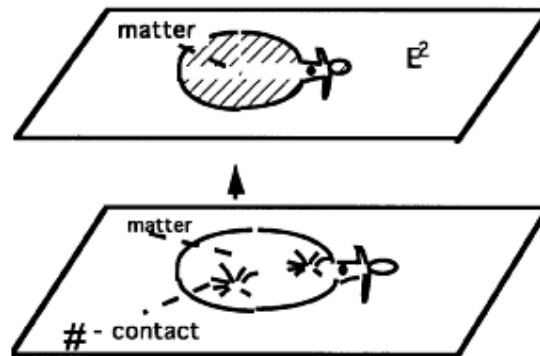

Figure 3.4: 3-dimensional matter as projection of the boundary of 3-surface to E^3 : 2-dim. visualization

What is so exciting that we can deduce the rough features of the topology of the surrounding 3-space just by looking it in various scales! Single glance shows that this topology is extremely complicated and contains boundaries everywhere and in all scales. In any case, it is in principle possible to make a map of a 3-surface in H both by observation of the form of macroscopic bodies and by measuring the ordinary physical observables like electromagnetic fields. Note that the fractal properties of the world are in accordance with the prediction of RGI hypothesis that topological condensate has hierarchical structure containing 3-surfaces of all possible sizes.

To summarize, topological condensation seems to provide a purely topological description for the generation of structures. The concept of matter in topologically trivial, almost flat 3-space is replaced with an empty but topologically highly nontrivial 3-space. The idea leads to a concrete program of actually finding out what is the topology of a given form of matter and understanding the physical properties matter in terms of this topology! And it would be surprising if this kind of understanding would not increase our abilities to control and manipulate the properties of the matter.

Topological field quantum as a coherent quantum system

There are several arguments suggesting that topological field quanta are good candidates for coherent quantum systems and that join along boundaries provides basic means for constructing larger quantum systems from smaller units.

- (a) The choice of the coordinates inside a given field quantum is analogous to the choice of the quantization axis. This suggests that the topological field quanta might provide a topological description of certain aspects of quantum phenomena. The choice of the quantization axis could indeed correspond to that taking place in quantum measurement. The fact that the quantization axes associated with different connected 3-surfaces need not be the same is in accordance with the idea that quantum coherence is possible for a connected 3-surface only. An exception is provided by a system consisting of several topological field quanta connected by "bridges" (join along boundaries bonds), for which quantization axes are the same and which therefore can be regarded as a coherent quantum system. As an example consider a spinning particle in a constant magnetic field. To describe the situation one must construct the imbedding of the magnetic field on the particle 3-surface by requiring that the resulting 4-surfaces corresponds to a preferred extremals of

Kähler action. The simplest manner to achieve this is to assume that the quantization axis defining the vacuum quantum numbers n_1 and n_2 is in the direction of the magnetic field so that one say that the external magnetic field fixes the quantization axis.

- (b) 3-surfaces consisting of several field quanta are in general unstable in accordance with that fact that the formation of macroscopic quantum systems is also a rare phenomenon. The argument goes as follows.
- i) CP_2 coordinates tend to have discontinuous or have even infinite derivatives at the boundaries of the topological field quanta if one poses some rather sensible physical requirements like the requirement that the 3-surface provides an imbedding for the Kähler electric field created by the mass distribution. As a consequence, Einstein tensor contains delta function type singularities and this is not nice. The best manner to avoid the edges is to allow boundaries.
 - ii) The boundaries of a 3-surface consisting of several field quanta are in general carriers of surface Kähler (Z^0) charge as the following argument shows. The embedding of the Kähler electric field associated with a given matter distribution has certain critical radius, which corresponds to the boundary of a field quantum. In general, one cannot continue the imbedding to a neighboring field quantum without allowing infinite derivatives of CP_2 coordinates.
 - iii) The 3-surface consisting of several field quanta is not stable unless the condition $u = \cos(\Theta) = \pm 1$ is satisfied on $r = \infty$ surfaces. The point is that the excitations of Φ coordinate in general imply discontinuity of 3-surface at the boundary unless they are strongly correlated for neighboring field quanta.
- (c) The gluing of topological field quanta is probably possible by the join along boundaries bonds. The tube $D^2 \times D^1$ or the "bridge" between the two topological field quanta corresponds to a topological field quantum. The most probable "hot spots", where the gluing is possible correspond to parts of the surface, where the normal component of the Kähler electric field is vanishing. Now however the stability of the join along boundaries bond is not obvious. It can also happen that the directions of the induced Kähler fields are same on some portions of the boundaries and in this case the gluing by joining along boundaries bond serving as a Kähler electric flux tube is possible: in this case the stability of the bond is obvious. The color electric flux tubes between valence quarks provide a good example of this.

Topological description of supra phases

The topological construction recipe of a supra phase could be following. Take volumes of ordinary phase with a size of order of coherence length ξ , topologically condense them to the background 3-space and construct "bridges" between the boundaries of these structures. Supra phase is destroyed if the bridges are cut either thermally or by external magnetic field: the introduction of an external magnetic field indeed destroys the bridge since it implies that the quantum numbers n_1 and n_2 become in general non-vanishing inside the field quanta and bridge so that the order parameter ψ becomes discontinuous on the boundaries of bridges.

In the ground state of the supra phase the order parameter describing the supra phase is covariantly constant. Since the topology of the join along boundaries condensate is extremely complicated, the first homotopy group of the condensate is nontrivial. This means that one in general cannot find a global gauge transformation gauging the gauge potential associated with a vanishing magnetic field away. This implies that the phase increment of the order parameter along a closed homotopically nontrivial loop is in general nontrivial. These increments obviously contain information coded into the order parameter about the topology of the join along boundaries condensate.

The BE condensate of the charged $\#$ contacts, giving rise to pseudo super conductivity, played a key role in the earlier TGD inspired model of brain as a macroscopic quantum system. In the model discussed in this chapter the coherent state of Cooper pairs is replaced with an entangled state involving product states of $2M$ charged wormhole contacts, $N - M$ electronic Cooper pairs, and M neutrino cooper pairs. One can also ask whether the vacuum quantum numbers

might provide a realization for the idea about Universe as Computer. Biological information processing might be based on the manipulation of the vacuum quantum numbers. These ideas will be developed in some detail in the last part of the book.

Topological description of dissipation

The previous topological ideas lead to a general ideas about how structures are generated at macroscopic level. There is however a standard approach to the description of the generation of structures [B35] and in this approach dissipative mechanisms play central role. The basic idea is that dissipation takes care that an open system ends up to some asymptotic state, which need not be thermal equilibrium but can be a complicated dynamic, non-equilibrium state.

The topological definition of the quantum coherence suggests that these approaches are in fact very closely related. Dissipation means certainly a loss of quantum coherence since for a coherent quantum system density matrix develops unitarily so that dissipation is impossible. Quantum coherence is lost at a given level of condensation hierarchy if the condensate consists of several 3-surfaces interacting through standard interactions only. The formation of the join along boundaries bonds however creates quantum coherence. Therefore the breaking of the join along boundaries bonds provides a good candidate for a fundamental dissipation mechanism.

To make the idea more concrete consider as an example liquid flow, assuming that there is a velocity gradient in a direction orthogonal to the velocity. What one wants to understand is the friction or how the energy of the liquid is dissipated. Liquid molecules have typically join along boundaries contacts (tube $D^2 \times D^1$) with the neighboring molecules (and due to thermal motion these contacts are continuously splitting and rejoining. The average age of a typical contact is much smaller than the time scale associated with the motion of a liquid so that the contact between two neighboring molecules suffers several thermally induced splittings and re-joinings, when the neighboring molecule pass by. A natural assumption is that the contact between two neighboring molecules is like a rubber band: energy is needed to stretch it. Assume that contact is formed between neighboring atoms moving with certain relative velocity so that the contact gets longer and splits after certain average time. The energy needed to stretch the contact longer is taken from the energy of the translational motion so that the relative motion becomes slightly slower.

As a second example, consider the understanding of the finite conductivity in metals. The neighboring atoms in the metal form a lattice and there are contacts between the neighboring atoms. These contacts are not completely stable but suffer splittings now and then. The large conductivity of the metal results from these contacts since they provide for the conduction electrons the bridges to move from one atomic 3-surface to a another one. The finiteness of the conductivity results from the fact that now and then a bridge between two neighboring atoms is broken. In the last part of the book it will be found that this kind of argument leads to a correct order of magnitude estimate for the metallic conductivity using a TGD inspired modification of the Drude model.

The concept of topological condensate affords also a second new point of view concerning the description of dissipation. The standard description of dissipation is in terms of inelastic collisions of particles. This description generalizes: particles at the condensate level n correspond to topological field quanta of level $n - 1$ with typical size $L(n - 1)$. In inelastic collisions of these particles join along boundaries contacts are created and split and part of kinetic energy is transferred to the kinetic energy of topological field quanta of level $n - 2$ condensed on level $n - 1$ field quanta. This mechanism makes possible the gradual transfer of the kinetic energy to the atomic length scales, where the collisions of ordinary particles take care of the further dissipation. Some potential applications of this picture are provided by hydrodynamics: ordinary hydrodynamics generalizes to a hierarchy of hydrodynamics, one for each condensate level plus a model for the energy and momentum transfer between two subsequent levels.

3.5 Topological condensation and color confinement

In this section a simple semiclassical model of color confinement is constructed as an application of the previous ideas. Also a view about color confinement being based on the same mechanism as the generation of macroscopic and macro-temporal quantum coherence (crucial for the TGD inspired theory of consciousness [K43]) is discussed. These two arguments are separated by a temporal distance longer than decade and their different style reflects the development of my own thinking about TGD.

3.5.1 Explanation of color confinement using quantum classical correspondence

One can understand color confinement from the properties of the Kähler action by applying quantum classical correspondence.

- (a) The classical color gauge field is proportional to $H^A J_{\alpha\beta}$, where H^A is color Hamiltonian. This implies that the color holonomy group is Abelian. This suggests strongly that the physical states correspond states of color multiplets having vanishing color hyper charge and isospin. This would mean a weak form of color confinement.
- (b) The proportionality of the gluon field to the induced Kähler field, approximately satisfying free Maxwell equations, implies that the direction of the classical color field in M^4 is not random and that gluon field behaves in this sense as a massless field giving rise to long range interactions. The approximate canonical invariance of the Maxwell phase, which corresponds to the exact canonical gauge invariance of the configuration space geometry, is realized as approximately local $U(1)$ transformations which become constant color rotations below a cutoff scale identifiable as the size of space-time sheet carrying color charge.
- (c) The fact that the classical color field is proportional to a color Hamiltonian and Kähler field implies that the direction of the gluon field in the color algebra is random above the cutoff length scale so that color cannot propagate in length scales longer than the cutoff scale. Since color gauge currents are conserved for CP_2 type extremals representing wormhole contacts, color gauge flux is conserved in wormhole contacts which are therefore color neutral as particles so that colored variant of Higgs mechanism is not possible. The finite range of color interaction therefore leaves only the possibility that the net color charge of the elementary particles topologically condensed at the hadronic space-time sheet vanishes.

3.5.2 Hadrons as color magnetic/electric flux tubes

In this model quarks and gluons correspond to small M^4 type surfaces containing topologically condensed CP_2 type extremals and these surfaces are in turn condensed on a larger hadronic M^4 type surface. Valence quarks (at least) are connected by color electric or magnetic flux tubes (join along boundaries bonds) to form color singlets.

At elementary particle level, topological condensation means the condensation of the CP_2 type extremals around M^4 type surfaces. The condensed CP_2 type extremals perform zitterbewegung with a velocity of light although cm is at rest. The 3-space surrounding the condensed elementary particle has a finite size of the order of Compton radius (natural guess at this stage). At length scales $r \ll r_c$ (r_c denotes the Compton radius of the particle), condensed particles look essentially like massless particles whereas at length scales $r \gg r_c$ they look like pieces of M^4 condensed to the background and moving with a velocity smaller than light velocity. CP_2 type extremals can be regarded as Kähler magnetic monopoles, whose magnetic flux runs in the internal degrees of freedom so that no long range $1/r^2$ magnetic field is generated. The fact that elementary particles are in a well defined sense Kähler magnetic monopoles supports criticality hypothesis: the strong Kähler coupling phase for the electric charges must be identical with the weak coupling phase for the magnetic monopoles and therefore Kähler action must correspond to a fixed point of the coupling constant evolution (this does not exclude the p-adic coupling constant evolution with respect to the zero modes of the Kähler metric).

The construction of the configuration space geometry and of quantum TGD lead to the conclusion that the description of the non-perturbative aspects of the color interaction must be based on the flux variables defined by the induced Kähler form. These variables include as a special case the generalized classical color fluxes. Since the low energy limit of TGD is expected to be more or less equivalent with the standard model, one can ask whether color confinement is signalled also by the divergence of the color coupling strength at low energies. p -Adic length scale hypothesis makes it possible to quantitatively understand the confinement scale.

There are good reasons to expect that the quantum average space-time associated with a hadron could be regarded as an orbit of a 3-surface obtained by connecting the 3-surfaces (of size smaller than hadronic size) associated with the valence quarks with color electric flux tubes to get a color singlet state. Color singletness results from the randomness of the direction of the color field above hadronic length scales implying that the average radial color gauge flux emanating from the hadron vanishes. This structure in turn has suffered a topological condensation on a larger hadronic 3-surface. The cutting of one or more color electric flux tube leads automatically to a generation of compensating color charges so that only color singlets can be created in the decays of the hadron. Also the topological evaporation of only color singlet objects is possible.

Color magnetic or electric flux tubes or both?

Both color magnetic and electric flux tubes have been used to model hadrons in TGD framework as well as in QCD, and one might wonder which of these options is the correct one. For absolute minimization of Kähler action Kähler electric fields are favored so that color electric flux tubes would be in a preferred position as models of hadron. For the more general variational principle discussed in [K81] the absolute value of Kähler action for space-time region with a definite sign of action density is either minimized or maximized (these options define dual dynamics and are consistent with the fact that 3-surfaces rather than 4-surfaces are fundamental dynamical objects). Therefore both Kähler magnetic and electric flux tubes are possible so that both color electric and magnetic models can be said to be correct.

The simplest model for the color flux tube connecting two quarks is based on the following picture.

- (a) The CP_2 type extremals with quark quantum numbers are topologically condensed at M^4 type 3-surfaces with size smaller than the hadronic size. These 2-surfaces are in turn condensed on the hadronic 3-surface. Quark like 3-surfaces are connected by join along boundaries contacts, which are color flux tubes connecting the boundaries of the quark 3-surfaces. These color flux tubes are the counterparts of the hadronic string.
- (b) The color magnetic/electric flux tube is a deformation of a vacuum extremal of type $M^2 \times D^2$ ("spring"), where D^2 is a disk orthogonal to M^2 . This surface indeed looks like a tube of cross section D^2 . The disk has an area of order $1/T$, where T is hadronic string tension.
- (c) The quarks at the ends of the flux tube serve as sources of approximately constant Kähler magnetic/electric fields (giving rise to chromo-electric fields of confining type), which generate the hadronic string tension. Since color field is proportional to Kähler field, also the Kähler charge of quark and gluon is of order $q \simeq 1$. The proportionality of the induced Kähler field and classical color field implies that hadrons can be regarded as chromo-electric flux tubes. Also QCD [B57, B54] affords this kind of descriptions for color confinement.

A model for color electric flux tube

Consider now in a more detail the model for the Kähler electric flux tube understood as a preferred extremal of the Kähler action. Since the actual situation is rather complicated it is useful to consider a simplified situation that is solution of the field equations with essentially constant Kähler electric field in the axial direction inside a cylinder of M^4 .

The join along boundaries contact (color electric flux tube) corresponds to a surface of representable as a map from $M^4 = M^2 \times D^2$ to the homologically nontrivial geodesic sphere of type II . Here D^2 is a disk corresponding to the transversal section of the color flux tube and has size

not much smaller than a typical hadronic length. One expects the Kähler action to be lowered by the generation of the Kähler electric fields. Field equations for the small deformations reduce in the lowest order to free Maxwell equations

$$D_\beta J^{\alpha\beta} = 0 . \quad (3.5.1)$$

Topologically condensed valence quarks at the ends of the flux tube serve as sources for the Kähler electric field.

The solution ansatz describing a constant Kähler electric field is obtained as a map from $M^4 = M^2 \times D^2$ to the geodesic sphere of type *II*:

$$\begin{aligned} \cos(\Theta) &= u(z) , \\ \Phi &= \omega t . \end{aligned} \quad (3.5.2)$$

The interesting components of the induced metric and induced Kähler form are given by the expressions

$$\begin{aligned} g_{tt} &= 1 - \frac{R^2 \omega^2}{4} (1 - u^2) , \\ g_{zz} &= -1 - \frac{R^2}{4} \frac{u_{,z}^2}{(1 - u^2)} , \\ J_{tz} &= \frac{u_{,z} \omega}{4} . \end{aligned} \quad (3.5.3)$$

Field equations are obtained from the conservation of four-momentum and the conservation condition for the z -component of momentum gives

$$u_{,z}^2 (g_{zz}^3 g_{tt})^{-1/2} = \frac{E}{\omega^2} , \quad (3.5.4)$$

where E can be interpreted as the constant field strength.

The lowest order solution is obtained by approximating the induced metric with a flat metric so that one has

$$\Theta = \arccos\left(\frac{Ez}{\omega}\right) . \quad (3.5.5)$$

The solution obtained is well defined only for the values of z having absolute value smaller than $2\pi/E$ and the g_{zz} component of the induced metric becomes infinite at the critical values of z . One might think that the appearance of the singularity is an artefact of the approximation used but this is not the case. The closer examination of the field equations shows that the singularity is unavoidable and results from the compactness of CP_2 (vector potential is proportional to $u = \cos(\Theta)$) and that one cannot continue the solution in any manner for larger values of z . The nice thing is that boundary conditions are satisfied due to the singularity of the metric in the direction of the Kähler electric field. The result implies that the length of the string, and therefore the size of the hadron, is of order

$$L \sim \frac{2\pi\omega}{E} .$$

The hadronic string tension is generated dynamically. One can obtain an estimate for the string tension by noticing that the situation is to a good approximation one-dimensional. This means that the Kähler electric field of the point charge is constant. Since the Kähler charges of quarks serve as sources of the Kähler field the order of magnitude for the Kähler electric field is given from Gauss theorem

$$E = \frac{q}{S} . \quad (3.5.6)$$

where $q \simeq 1$ is the Kähler charge of quark and S is the transverse area of the string. The order of magnitude estimate $q \simeq 1$ follows from the requirement that the color charges for quarks have this order of magnitude and from the fact that classical gluon field is proportional to the Kähler field. Hadronic string tension is obtained by integrating the energy momentum density over the transversal degrees of freedom

$$T \simeq \frac{1}{8\pi\alpha_K} \int E^2 dS \simeq \frac{1}{8\pi\alpha_K} \frac{q^2}{S} . \quad (3.5.7)$$

This implies that the transversal size of the hadronic string is of the order of $S \simeq 1/GeV^2$. For ground state hadrons the length of the string is therefore of same order as the transversal size of the string. Despite this, hadrons are string like objects in a well defined sense: their topology is $D^1 \times S^2$ instead of $D^1 \times D^2$.

As already found, the imbedding of the constant Kähler electric field associated with the flux tube becomes singular for values $z = \pm 2\pi\omega/E$ of the coordinate variable z in the direction of E (ω is the frequency associated with the solution). The study of the spherically symmetric extremal revealed that the parameter ω has value of order $10^{-4}m_{Pl}$ in long length scales. For the hadronic space-time sheet ω must of the order $\omega \sim 1/L$, where L is a typical hadronic length in order to get reasonable length for the string like object.

3.5.3 Color confinement and generation of macro-temporal quantum coherence

How macroscopic quantum coherence is possible in macroscopic time scales? This pressing problem of quantum consciousness theories involves both the question what coherence and de-coherence really mean and what really happens in quantum jump, as well as the question how the de-coherence times in living matter could be much longer than predicted by standard physics. Color confinement is the pressing problem of particle physics apparently put under the rug during last two decades. There might be a close connection between these seemingly totally un-related puzzles as the following little argument tends to show.

Classical argument: the time spent in color bound states is very long

The TGD based solution to the problem how to achieve macro-temporal quantum coherence relies on the new physics predicted by quantum TGD. The decisive factor is the gigantic almost degeneracy of states due to the fact that CP_2 canonical transformations, which effectively act as $U(1)$ gauge transformations, are approximate symmetries of the Kähler action broken only by the classical gravitation.

The argument goes as follows.

- (a) The increment of the psychological time in single quantum jump is estimated to be about CP_2 time, that is about 10^4 Planck times. During this time interval quantum coherence is destroyed in zero mode degrees freedom representing macroscopic degrees of freedom as well as in all degrees of freedom in which there is no bound state entanglement. This time interval is extremely brief as compared to the actual de-coherence times, which standard quantum theory allows to estimate.

- (b) The formation of bound states can save the situation since bound state entanglement is not reduced during state preparation phase of the quantum jump consisting of self measurements. The transformation of the zero modes (macroscopic classical degrees of freedom in which localization occurs in each quantum jump) to quantum fluctuating degrees of freedom, when join along boundaries bonds are formed between two space-time sheets representing binding systems accompanies the formation of bound states. The reason is that only over all center of mass zero modes remain zero modes. This means that the generation of macroscopic quantum fluctuating degrees of freedom and the formation of bound states accompany each other.
- (c) When bound state entanglement is generated, state function reduction and state preparation cease to occur in these degrees of freedom and one has macro-temporal quantum coherence. The sequence of quantum jumps effectively binds to a single quantum jump just like elementary particles bind to form atom behaving effectively as single elementary particle. The lifetime of the bound state defines the de-coherence time.
- (d) This does not yet explain why the lifetimes of the bound states, or more precisely, why the time spent in bound states, is much longer than predicted by the standard physics. New physics is required for this, and spin glass degeneracy provides it. What happens is following. When a bound state is formed, the space-time sheets representing the free particles are connected by join along boundaries bonds. By quantum spin glass degeneracy the number of bound states is huge as compared to the number of free states, since there is extremely large number of join along boundaries bond configurations and differing only by the classical gravitational energy. Accordingly, the time spent in bound states, and thus also de-coherence time, is much longer than that predicted by standard physics.

How could one understand color confinement in this picture? The idea is simple: when quarks form color bound states, they are connected by color flux tubes (this is the aspect of confinement which goes outside QCD). Also color flux tubes possess huge spin glass degeneracy. Free quark states do not possess this degeneracy since join along boundaries bonds are absent. Thus the time spent in free states in which color flux tubes are absent is negligible to the time time spent in color bound states so that the states consisting of free quarks are unobservable. If this picture is correct, the divergence of the color coupling strength in confinement length scale reflects mathematically the fact that number of bound states is overwhelmingly large as compared that for the free states.

Color confinement from unitarity and spin glass degeneracy

A more precise phrasing of the idea about the connection between spin glass degeneracy and color confinement relies on unitarity conditions and the assumptions $T_{MN} \simeq T$ and $T_{Mr} \simeq T_r$. Here capital subscripts refer to degenerate hadronic states and small letter subscripts to free many-quark states. In this idealization hadronic degenerate states are stable against decay to free many-quark states with only single exception. The exceptional state should act as a doorway making possible the transition to quark-gluon plasma phase.

The S-matrix can be written as sum of unit matrix and reaction matrix T : $S = 1 + iT$.

- (a) The unitarity conditions $SS^\dagger = 1$ read in terms of T-matrix as

$$i(T - T^\dagger) = TT^\dagger . \quad (3.5.8)$$

For diagonal elements one has

$$2 \times \text{Im}(T_{mm}) = \sum_r |T_{mr}|^2 \geq 0 . \quad (3.5.9)$$

What is essential that the right hand side is non-negative and closely related to the total rate of transitions. If this rate is high also the imaginary part at the left hand side of the

equation is large and therefore also the rate for the diagonal transition. For instance, in the case of low energy strong interactions this implies that the total reaction rates are high but transitions occur mostly in the forward direction. In this case the mere large number of final many-hadron states implies that most transitions occur in the forward direction.

In the recent case one must consider both free many quark states and their bound states. Let us use capitals M, N as labels for bound states and small letters m, n as labels for free states.

- (b) The diagonal unitarity conditions can be written for both of these states as

$$\begin{aligned} 2Im(T_{mm}) &= \sum_r |T_{mr}|^2 + \sum_R |T_{mR}|^2 \geq 0 \ , \\ 2Im(T_{MM}) &= \sum_R |T_{MR}|^2 + \sum_r |T_{Mr}|^2 \geq 0 \ . \end{aligned} \quad (3.5.10)$$

In both cases there is a large number of the degenerate states involved at the right hand side so that one expects that the right hand side has a large value. For bound states the number of degenerate states is much higher due to the additional degeneracy brought in by the join along boundaries bonds (color flux tubes). Thus the lifetime and de-coherence time should be considerably longer than expected on basis of standard physics.

- (c) For the non-diagonal transitions from bound states to free states one has

$$i(T_{Mm} - \bar{T}_{mM}) = \sum_r T_{Mr} \bar{T}_{mr} + \sum_R T_{MR} \bar{T}_{mR} \ . \quad (3.5.11)$$

The right hand side is not positive definite and since a large number of amplitudes between widely different free and bound states of quarks are involved, one expects that a destructive interference occurs. This is consistent with a small value of the non-diagonal amplitudes T_{Mm} and with the long lifetime of bound states.

- (d) What happens for non-diagonal transitions between degenerate states? The unitarity conditions read as

$$\begin{aligned} i(T_{mn} - \bar{T}_{nm}) &= \sum_r T_{mr} \bar{T}_{nr} + \sum_r T_{mR} \bar{T}_{nR} \ , \\ i(T_{MN} - \bar{T}_{NM}) &= \sum_R T_{MR} \bar{T}_{NR} + \sum_r T_{Mr} \bar{T}_{Nr} \ . \end{aligned} \quad (3.5.12)$$

The right hand side is not anymore positive definite and there is a very large number of summands present. Hence a destructive interference could occur and the amplitude would be very strongly restricted in the forward direction. This need not however be true in the case of degenerate states since they are expected to be very similar to each other.

- (e) One can indeed play with the idealization that the transition amplitudes between degenerate states are identical $T_{MN} = T$ and that the amplitudes T_{Mr} are independent of M and given by $T_{Mr} = T_r$.

In this case T-matrix would have the form $T = t \times X$, where X is a matrix for which all elements are equal to one. t can be written as $|t| \exp(i\phi)$. T -matrix is maximally degenerate and the diagonalized form T^D of T-matrix has only a single non-vanishing element equal to Nt , N the number of degenerate states. t must satisfy the unitarity condition $|t| = 2 \times \sin(\phi)/N$. S-matrix would reduce to an almost unit matrix for the diagonalized bound states.

What about the stability of the bound states in this case? The decay amplitudes for bound states corresponding to the vanishing eigen values of T are given by $T^D(M, r) = \sum c_M T_{Mr} = \sum_M c_M \times T_r = 0$ by the orthogonality of these states with the state with a non-vanishing eigen value. Thus the lifetimes of all bound states except the one with the non-vanishing eigen value of T are infinitely long in this idealization.

Chapter 4

General View About Physics in Many-Sheeted Space-Time: Part II

4.1 Introduction

In previous chapter "General View About Physics in Many-Sheeted Space-Time" the notion of many-sheeted space-time concept and the understanding of coupling constant evolution at space-time level were discussed without reference to the newest developments in quantum TGD. In this chapter this picture is completed by a summary of the new rather dramatic developments in TGD that have occurred during last few years (the year I am writing this is 2007). The most important steps of progress are following ones.

4.1.1 Parton level formulation of quantum TGD

The formulation of quantum TGD at partonic level identifying fundamental objects as light-like 3-surfaces having also interpretation as random light-like orbits of 2-D partons having arbitrarily large size. This picture reduces quantum TGD to an almost-topological quantum field theory and leads to a dramatic understanding of S-matrix. A generalization of Feynman diagrams emerges obtained by replacing lines of Feynman diagram with light-like 3-surfaces meeting along their ends at vertices. This picture is different from that of string models and means also a generalization of the view about space-time and 3-surface since these surfaces cannot be assumed to be a smooth manifold anymore.

Extended super-conformal invariance involving the fusion of ordinary Super-Kac Moody symmetries and so called super-symplectic invariance generalizing the Kac-Moody algebra by replacing the Lie algebra of finite-dimensional Lie group with that for symplectic transformations of $\delta M_{\pm}^4 \times CP_2$ plays a key role in this framework. The help of professionals in this branch of mathematics would be badly needed in order to develop a detailed understanding about the predicted particle spectrum.

4.1.2 Zero energy ontology

The notion of zero energy ontology emerged implicitly in cosmological context from the observation that the imbeddings of Robertson-Walker metrics are always vacuum extremals. In fact, practically all solutions of Einstein's equations have this property very naturally. The explicit formulation emerged with the progress in the formulation of quantum TGD. In zero energy ontology physical states are creatable from vacuum and have vanishing net quantum numbers, in particular energy. Zero energy states can be decomposed to positive and negative energy

parts with definite geometro-temporal separation, call it T , and having interpretation in terms of initial and final states of particle reactions. Zero energy ontology is consistent with ordinary positive energy ontology at the limit when the time scale of the perception of observer is much shorter than T . One of the implications is a new view about fermions and bosons allowing to understand Higgs mechanism among other things.

Zero energy ontology leads to the view about S-matrix as a characterizer of time-like entanglement associated with the zero energy state and a generalization of S-matrix to what might be called M-matrix emerges. M-matrix is complex square root of density matrix expressible as a product of real valued "modulus" and unitary matrix representing phase and can be seen as a matrix valued generalization of Schrödinger amplitude. Also thermodynamics becomes an inherent element of quantum theory in this approach.

4.1.3 Fusion of real and p-adic physics to single one

The fusion of p-adic physics and real physics to single coherent whole requires generalization of the number concept obtained by gluing reals and various p-adic number fields along common algebraic numbers. This leads to a completely new vision about how cognition and intentionality make themselves visible in real physics via long range correlations realized via the effective p-adicity of real physics. The success of p-adic length scale hypothesis and p-adic mass calculations suggest that cognition and intentionality are present already at elementary particle level. This picture leads naturally to an effective discretization of the real physics at the level of S-matrix and relying on the notion of umber theoretic braid.

4.1.4 Dark matter hierarchy and hierarchy of Planck constants

The idea about hierarchy of Planck constants relying on generalization of the imbedding space was inspired both by empirical input (Bohr quantization of planetary orbits and anomalies of biology) and by the mathematics of hyper-finite factors of type II_1 combined with the quantum classical correspondence. Consider first the mathematical structure in question.

- (a) The Clifford algebra of World of Classical Worlds (WCW) creating many fermion states is a standard example of an algebra expressible as a direct integral of copies of von Neumann algebras known as hyper-finite factor of type II_1 (HFFs). The inclusions of HFFs relate very intimately to the notion of finite measurement resolution. There is a canonical hierarchy of Jones inclusions [A2] labeled by finite subgroups of $SU(2)$ [A55]. Quantum classical correspondence suggests that these inclusions have space-time correlates [K90, K30] and the generalization of imbedding space would provide these correlates.
- (b) The space $CD \times CP_2$, where $CD \subset M^4$ is so called causal diamond identified as the intersection of future and past directed light-cones defines the basic geometric structure in zero energy ontology. The positive (negative) energy part of the zero energy state is located to the lower (upper) light-like boundaries of $CD \times CP_2$ and has interpretation as the initial (final) state of the physical event in standard positive energy ontology. p-Adic length scale hypothesis follows if one assumes that the temporal distance between the tips of CD comes as an octave of fundamental time scale defined by the size of CP_2 . The "world of classical worlds" (WCW) is union of sub-WCWs associated with spaces $CD \times CP_2$ with different locations in $M^4 \times CP_2$.
- (c) One can say that causal diamond CD and the space CP_2 appearing as factors in $CD \times CP_2$ forms the basic geometric structure in zero energy ontology, is replaced with a book like structure obtained by gluing together infinite number of singular coverings and factor spaces of CD resp. CP_2 together. The copies are glued together along a common "back" $M^2 \subset M^2$ of the book in the case of CD . In the case of CP_2 the most general option allows two backs corresponding to the two non-isometric geodesic spheres S_i^2 , $i = I, II$, represented as sub-manifolds $\xi^1 = \bar{\xi}^2$ and $\xi^1 = \xi^2$ in complex coordinates transforming linearly under $U(2) \subset SU(3)$. Color rotations in CP_2 produce different choices of this pair.

- (d) The selection of geodesic spheres S^2 and M^2 is an imbedding space correlate for the fixing of quantization axes and means symmetry breaking at the level of imbedding space geometry. WCW is union over all possible choices of CD and pairs of geodesic spheres so that at the level no symmetry breaking takes place. The points of M^2 and S^2 have a physical interpretation in terms of quantum criticality with respect to the phase transition changing Planck constant (leakage to another page of the book through the back of the book).
- (e) The pages of the singular coverings are characterized by finite subgroups G_a and G_b of $SU(2)$ and these groups act in covering or leave the points of factor space invariant. The pages are labeled by Planck constants $\hbar(CD) = n_a \hbar_0$ and $\hbar(CP_2) = n_b \hbar_0$, where n_a and n_b are integers characterizing the orders of maximal cyclic subgroups of G_a and G_b . For singular factor spaces one has $\hbar(CD) = \hbar_0/n_a$ and $\hbar(CP_2) = \hbar_0/n_b$. The observed Planck constant corresponds to $\hbar = (\hbar(CD)/\hbar(CP_2)) \times \hbar_0$. What is also important is that $(\hbar/\hbar_0)^2$ appears as a scaling factor of M^4 covariant metric so that Kähler action via its dependence on induced metric codes for radiative corrections coming in powers of ordinary Planck constant: therefore quantum criticality and vanishing of radiative corrections to functional integral over WCW does not mean vanishing of radiative corrections.

The interpretation in terms of dark matter comes as follows.

- (a) Large values of \hbar make possible macroscopic quantum phase since all quantum scales are scaled upwards by \hbar/\hbar_0 . Anyonic and charge fractionization effects allow to "measure" $\hbar(CD)$ and $\hbar(CP_2)$ rather than only their ratio. $\hbar(CD) = \hbar(CP_2) = \hbar_0$ corresponds to what might be called standard physics without any anyonic effects and visible matter is identified as this phase.
- (b) Particle states belonging to different pages of the book can interact via classical fields and by exchanging particles, such as photons, which leak between the pages of the book. This leakage means a scaling of frequency and wavelength in such a manner that energy and momentum of photon are conserved. Direct interactions in which particles from different pages appear in the same vertex of generalized Feynman diagram are impossible. This seems to be enough to explain what is known about dark matter. This picture differs in many respects from more conventional models of dark matter making much stronger assumptions and has far reaching implications for quantum biology, which also provides support for this view about dark matter.

All this is a work in progress and there are many uncertainties involved. Despite this it seems that it is good to sum up the recent view in order to make easier to refer to the new developments in the existing chapters.

4.2 The new developments in quantum TGD

This section summarizes the developments in quantum TGD which have taken place during last few years.

4.2.1 Reduction of quantum TGD to parton level

It took surprisingly long time before the realization that quantum TGD can be reduced to parton level in the sense that fundamental objects are light-like 3-surfaces (of arbitrary size). This identification follows from 4-D general coordinate invariance. Light-likeness in turn implies effective 2-dimensionality of the fermionic dynamics. 4-D space-time sheets are identified as preferred extrema of Kähler action. A stronger form of holography is that modified Dirac action and Chern-Simons action for light-like partonic 3-surfaces defined the Kähler action as a logarithm of the fermionic determinant.

Magic properties of 3-D light-like surfaces and generalization of super-conformal symmetries

The very special conformal properties of both boundary δM_{\pm}^4 of 4-D light-cone and of light-like partonic 3-surfaces X^3 imply a generalization and extension of the super-conformal symmetries of super-string models to 3-D context [K20, K23]. Both the Virasoro algebras associated with the light-like coordinate r and to the complex coordinate z transversal to it define super-conformal algebras so that the structure of conformal symmetries is much richer than in string models.

- (a) The symplectic transformations of $\delta M_{\pm}^4 \times CP_2$ give rise to an infinite-dimensional symplectic/symplectic algebra having naturally a structure of Kac-Moody type algebra with respect to the light-like coordinate of $\delta M_{\pm}^4 = S^2 \times R_+$ and with finite-dimensional Lie group G replaced with the symplectic group. The conformal transformations of S^2 localized with respect to the light like coordinate act as conformal symmetries analogous to those of string models. The super-symplectic algebra, call it SC, made local with respect to partonic 2-surface can be regarded as a Kac-Moody algebra associated with an infinite-dimensional Lie algebra.
- (b) The light-likeness of partonic 3-surfaces is respected by conformal transformations of H made local with respect to the partonic 3-surface and gives to a generalization of bosonic Kac-Moody algebra, call it KM, Also now the longitudinal and transversal Virasoro algebras emerge. The commutator $[KM, SC]$ annihilates physical states.
- (c) Fermionic Kac-Moody algebras act as algebras of left and right handed spinor rotations in M^4 and CP_2 degrees of freedom. Also the modified Dirac operator allows super-conformal symmetries as gauge symmetries of its generalized eigen modes.

Quantum TGD as almost topological quantum field theory at parton level

The original belief was that the light-like character of basic dynamical objects X_l^3 at which the signature of the induced metric changes implies that Chern-Simons action for the induced Kähler gauge potential of CP_2 determines the classical dynamics of partonic 3-surfaces [K19]. This turned out to be a wrong guess: Kähler action and corresponding modified Dirac action is enough.

- (a) Number theoretical compactification and the properties of known extremals of Kähler action suggests strongly the slicing of space-time surface by 3-D light-like surfaces Y_l^3 parallel to X_l^3 . The surfaces Y_l^3 behave as independent dynamical units in the sense that conserved currents flow along them so that quantum holography is realized. Number theoretic compactification allows also dual slicings of $X^4(X_l^3)$ by string world sheets Y^2 and partonic 2-surfaces X^2 .
- (b) The modified Dirac action obtained as the super-symmetric counterpart Kähler action fixes the dynamics of the second quantized free fermionic fields in terms of which configuration space gamma matrices and configuration space spinors can be constructed. The essential difference to the ordinary massless Dirac action is that induced gamma matrices are replaced by the contractions of the symplectic momentum densities Kähler action with imbedding space gamma matrices. Therefore the effective metric defined by the modified gamma matrices replaces ordinary gamma matrices and the corresponding effective metric can be non-singular even when induced metric is degenerate. Effective 3-dimensionality means that the modes of the induced spinor field are constant with respect to the light-like coordinate labeling the slices Y_l^3 .
- (c) Modified Dirac action is consistent with the symmetries of Kähler action provided its first variation with respect to H coordinates vanishes - or equivalently- the second variation of Kähler action varies. This would realize quantum criticality at space-time level. One can consider also the possibility that second variation vanishes only for those deformations which correspond to conserved currents.

- (d) Modified Dirac operator decomposes as $D_K = D_K(Y^2) + D_K(X^2)$ and its zero modes for effectively 3-D solutions can be chosen to be generalized eigenmodes of $D_K(X^2)$. The product of the generalized eigenvalues of $D_K(X^2)$ defines the exponent of Kähler function conjectured to reduce to Kähler action for the preferred extremal.

Fermionic statistics is geometrized in terms of spinor geometry of WCW since gamma matrices are linear combinations of fermionic oscillator operators identifiable also as super-symplectic generators [K19]. Only the light-likeness property involving the notion of induced metric breaks the topological QFT property of the theory so that the theory is as close to a physically trivial theory as it can be.

The resulting generalization of $N = 4$ super-conformal symmetry [A51] involves super-symplectic algebra (SC) and super Kac-Moody algebra (SKM) [K23]. There are considerable differences as compared to string models. Super generators carry fermion number, no sparticles are predicted (at least super Poincare invariance is not obtained), SKM algebra and corresponding Virasoro algebra associated with light-like coordinates of X^3 and δM_{\pm}^{\pm} do not annihilate physical states which justifies p-adic thermodynamics used in p-adic mass calculations, four-momentum does not appear in Virasoro generators so that there are no problems with Lorentz invariance, and mass squared is p-adic thermal expectation of conformal weight.

4.2.2 Quantum measurement theory with finite measurement resolution

Infinite-dimensional Clifford algebra of CH can be regarded as a canonical example of a von Neumann algebra known as a hyper-finite factor of type II_1 [A46, A55] (shortly HFF) characterized by the defining condition that the trace of infinite-dimensional unit matrix equals to unity: $Tr(Id) = 1$. In TGD framework the most obvious implication is the absence of fermionic normal ordering infinities whereas the absence of bosonic divergences is guaranteed by the basic properties of the configuration space Kähler geometry, in particular the non-locality of the Kähler function as a functional of 3-surface.

The special properties of this algebra, which are very closely related to braid and knot invariants [A54, A67], quantum groups [A55], non-commutative geometry [A43], spin chains, integrable models [B27], topological quantum field theories [A60], conformal field theories, and at the level of concrete physics to anyons [D12], generate several new insights and ideas about the structure of quantum TGD.

Jones inclusions $\mathcal{N} \subset \mathcal{M}$ [A2, A55] of these algebras lead to quantum measurement theory with a finite measurement resolution characterized by \mathcal{N} [K90, K30]. Quantum Clifford algebra \mathcal{M}/\mathcal{N} interpreted as \mathcal{N} -module creates physical states modulo measurement resolution. Complex rays of the state space resulting in the ordinary state function reduction are replaced by \mathcal{N} -rays and the notions of unitarity, hermiticity, and eigenvalue generalize [K22, K30].

The notion of entanglement generalizes so that entanglement coefficients are N -valued. Generalized eigenvalues are in turn N -valued hermitian operators. S- and U-matrices become N valued and probabilities are obtained from N -valued probabilities as traces.

Non-commutative physics would be interpreted in terms of a finite measurement resolution rather than something emerging below Planck length scale. An important implication is that a finite measurement sequence can never completely reduce quantum entanglement so that entire universe would necessarily be an organic whole. Topologically condensed space-time sheets could be seen as correlates for sub-factors which correspond to degrees of freedom below measurement resolution. Topological condensation in turn corresponds to the inclusion $\mathcal{N} \subset \mathcal{M}$. This is however not the only possible interpretation.

4.2.3 Hierarchy of Planck constants

The idea about hierarchy of Planck constants relying on generalization of the imbedding space was inspired both by empirical input (Bohr quantization of planetary orbits) and by the mathematics of hyper-finite factors of type II_1 combined with the quantum classical correspondence.

The generalization of imbedding space concept and hierarchy of Planck constants

Quantum classical correspondence suggests that Jones inclusions [A2] have space-time correlates [K90, K30]. There is a canonical hierarchy of Jones inclusions labeled by finite subgroups of $SU(2)$ [A55]. This leads to a generalization of the imbedding space obtained by gluing an infinite number of copies of H regarded as singular bundles over $H/G_a \times G_b$, where $G_a \times G_b$ is a subgroup of $SU(2) \times SU(2) \subset SL(2, C) \times SU(3)$. Gluing occurs along a factor for which the group is same. The generalized imbedding space has clearly a book like structure with pages of books intersecting along 4-D sub-manifold $M^2 \times S^2$, S^2 a geodesic sphere of CP_2 characterizing the choice of quantization axes. Entire configuration space is union over "books" corresponding to various choices of this sub-manifold.

The groups in question define in a natural manner the direction of quantization axes for various isometry charges and this hierarchy seems to be an essential element of quantum measurement theory. Ordinary Planck constant, as opposed to Planck constants $\hbar_a = n_a \hbar_0$ and $\hbar_b = n_b \hbar_0$ appearing in the commutation relations of symmetry algebras assignable to M^4 and CP_2 , is naturally quantized as $\hbar = (n_a/n_b) \hbar_0$, where n_i is the order of maximal cyclic subgroup of G_i . The hierarchy of Planck constants is interpreted in terms of dark matter hierarchy [K30]. What is also important is that $(n_a/n_b)^2$ appear as a scaling factor of M^4 metric so that Kähler action via its dependence on induced metric codes for radiative corrections coming in powers of ordinary Planck constant: therefore quantum criticality and vanishing of radiative corrections to functional integral over WCW does not mean vanishing of radiative corrections.

G_a would correspond directly to the observed symmetries of visible matter induced by the underlying dark matter [K30]. For instance, in living matter molecules with 5- and 6-cycles could directly reflect the fact that free electron pairs associated with these cycles correspond to $n_a = 5$ and $n_a = 6$ dark matter possibly responsible for anomalous conductivity of DNA [K30, K15] and recently reported strange properties of graphene [D11]. Also the tetrahedral and icosahedral symmetries of water molecule clusters could have similar interpretation [K27], [D10].

A further fascinating possibility is that the observed indications for Bohr orbit quantization of planetary orbits [E175] could have interpretation in terms of gigantic Planck constant for underlying dark matter [K72] so that macroscopic and -temporal quantum coherence would be possible in astrophysical length scales manifesting itself in many manners: say as preferred directions of quantization axis (perhaps related to the CMB anomaly) or as anomalously low dissipation rates.

Since the gravitational Planck constant is proportional to the product of the gravitational masses of interacting systems, it must be assigned to the field body of the two systems and characterizes the interaction between systems rather than systems themselves. This observation applies quite generally and each field body of the system (em, weak, color, gravitational) is characterized by its own Planck constant.

In the gravitational case the order of G_a is gigantic and at least $GM_1 m/v_0$, $v_0 = 2^{-11}$ the favored value. The natural interpretation is as a discrete rotational symmetry of the gravitational field body of the system having both gravimagnetic and gravi-electric parts. The subgroups of G_a for which order is a divisor of the order of G_a define broken symmetries at the lower levels of dark matter hierarchy, in particular symmetries of visible matter.

The number theoretically simple ruler-and-compass integers having as factors only first powers of Fermat primes and power of 2 would define a physically preferred sub-hierarchy of quantum criticality for which subsequent levels would correspond to powers of 2: a connection with p-adic length scale hypothesis suggests itself. Ruler and compass hypothesis implies that besides p-adic length scales also their 3- and 5- multiples should be important. Note that in the structure of chromosomes p-adic length scale $L(151) \simeq 10$ characterizes beads-on-string structure of DNA whereas the length scale $3L(151)$ appears in the coiling of this structure.

Implications of dark matter hierarchy

The basic implication of dark matter hierarchy is hierarchy of macroscopic quantum coherent systems covering all length scales. The presence of this hierarchy is visible as exact discrete

symmetries of field bodies reflecting at the level of visible matter as broken symmetries. In case of gravitational interaction these symmetries are highest and also the scale of quantum coherence is astrophysical. Together with ruler-and-compass hypothesis and p-adic length scale hypothesis this leads to very powerful predictions and p-adic length scale hypothesis might reduce to the ruler-and-compass hypothesis.

At the level of condensed matter one application is nuclear string model explaining also the selection rules of cold fusion and predicting that dark copy of weak physics with atomic scale defining the range of weak interaction is involved. Note that cold fusion has recently gained considerable support. High T_c super-conductivity is second application of dark matter hierarchy.

The 5- and 6-fold symmetries of the sugar backbone of DNA suggest that corresponding cyclic groups or cyclic groups having these groups as factors are symmetries of dark matter part of DNA presumably consisting of what is called as free electron pairs assignable to 5- and 6-cycles. The model allows to understand the observed high conductivity of DNA not consistent with the insulator property of DNA at the level of visible matter.

Dark matter and bio-control

The hierarchy of dark matters provides rather concrete realization for the vision about living matter as quantum critical system. This vision will be discussed in more detail later.

The large Planck constants characterize various field bodies of physical system. This gives justification to the notion of (magnetic) field body which plays key role in TGD inspired model of living matter serving as intentional agent controlling the behavior of field body. For instance, the model of EEG relies and of bio-control relies on this notion. The large value of the Planck constant is absolutely essential since for a given low frequency it allows to have gauge boson energy above thermal threshold. Large value of Planck constant is essential for time mirror mechanism which is behind the models of metabolism, long term memory, and intentional action.

The huge values of gravitational Planck constant supports the vision of Penrose [J6] about the special role of quantum gravitation in living matter. In TGD framework the proposal of Penrose and Hameroff for the emergence of consciousness known as Orch-Or (Orchestrated Objective Reduction [J4]) is however too restricted since it gives a very special role to micro-tubules.

A reasonable guess - based on the hypothesis that transition to dark matter phase occurs when perturbation theory for standard value of Planck constant fails - is that $GMm > 1$ is the criterion for the transition to dark phase for the gravitational field body characterizing the interaction between the two masses so that Planck mass becomes the critical mass for this transition. For the density of water this means size scale of .1 mm, the size of large neuron.

4.2.4 Zero energy ontology

Zero energy ontology has roots in TGD inspired cosmology [K73] . The problem has been that the imbeddings of Robertson-Walker cosmologies have vanishing densities of Poincare momenta identified as inertial momenta whereas gravitational energy density is non-vanishing. This led to the conclusion that one must allow space-time sheets with both time orientations such that the signs of Poincare energies are different for them and total density of inertial energy vanishes. Gravitational momenta can be identified as difference of the Poincare momenta and need not be conserved.

Construction of S-matrix and zero energy ontology

The construction of S-matrix allows to formulate this picture more sharply. Zero energy states have positive and negative energy parts located in geometric past and future and S-matrix can be identified as time-like entanglement coefficients between these states. Positive energy ontology is a good approximation in time scales shorter than the temporal distance between positive and negative energy states. This picture leads also to a generalization of Feynman graphs obtained by gluing light-like partonic 3-surfaces together along their ends at vertices. These Feynman

cobordisms become a basic element of quantum TGD having interpretation as almost topological QFT and category theoretical formulation of quantum TGD emerges.

Elementary particles and zero energy ontology

At the level of elementary particles zero energy ontology means that fermionic quantum numbers are located at the light-like throats of wormhole contacts connecting CP_2 type extremals with Euclidian signature of induced metric to space-time sheets with Minkowskian signature of induced metric. Gauge bosons in turn correspond to pieces of CP_2 type extremals connecting positive and negative energy space-time sheets with fermion and antifermion quantum numbers at the throats of the wormhole contact. Depending on the sign of net energy one has ordinary boson or its phase conjugate. Gravitons correspond to pairs of fermion or gauge boson pair with particle and antiparticle connected by flux tube. This string picture emerges automatically if one assumes that the fermions of the conformal field theory associated with partonic 3-surface are free. It is also possible to have gauge bosons corresponding to single wormhole throat: these particles correspond to bosonic generators of super-symplectic algebra and excitations which correspond to genuine configuration space degrees of freedom so that description in terms of quantum field theory in fixed background space-time need not work.

4.2.5 U- and S-matrices

In quite early stage physical arguments led to the conclusion that the universal U-matrix associated with quantum jump must be distinguished from the S-matrix characterizing the rates of particle reactions. The notion of zero energy ontology was however needed before it became possible to characterize the difference between these matrices in a more precise manner.

Some distinctions between U- and S-matrices

The distinctions between U- and S-matrices have become rather clearer.

- (a) U-matrix is the universal unitary matrix assignable to quantum jump between zero energy states whereas S-matrix can be identified as time-like entanglement coefficients between positive and negative energy parts of the zero energy state. Thus S-matrix characterizes zero energy states.
- (b) U-matrix is always between zero energy states and the corresponding state function reduction reduces entanglement between zero energy states. State function reduction for S-matrix elements reduces the entanglement between positive and negative energy parts of a given zero energy state and is completely analogous to ordinary quantum measurement reducing entanglement between systems having space-like separation.
- (c) U-matrix is unitary whereas S-matrix can be unitary only for HFFs of type II_1 . In the most general case S-matrix can be regarded as a "square" root of the density matrix assignable to time like entanglement: this hypothesis would unify the notions of S-matrix and density matrix and one could regard quantum states as matrix analogs of Schrödinger amplitudes expressible as products of its modulus (square root of probability density replaced with square root of density matrix) and phase (possibly universal unitary S-matrix). Thermal S-matrices define an important special case and thermodynamics becomes an integral part of quantum theory in zero energy ontology.
- (d) U-matrix can have elements between different number fields. In this case one must however assume number theoretical universality meaning that U-matrix has rational or at most algebraic matrix elements. In the case of HFFs of type II_1 this might imply triviality. U-matrix between p-adic and real number fields would relate to intentional action and the almost triviality would be a blessing meaning that the realization of intentional action occurs in a very precise manner and is restricted only by cutoff due to the algebraic character of number theoretic braids.

S-matrix as time-like entanglement matrix is diagonal with respect to number field and number theoretical universality is not absolutely essential for its definition.

Number theoretic universality and S-matrix

The fact that zero energy states are created by p-adic to-real transitions and must be number theoretically universal suggests strongly that the data about partonic 2-surfaces contributing to S-matrix elements come from the intersection of real partonic 2-surface and its p-adic counterpart satisfying same algebraic equations. The intersection consists of algebraic points and contains as subset number theoretic braids central for the proposed construction of S-matrix.

The question is whether also states for which S-matrix receives data from non-algebraic points should be allowed or whether the data can come even from continuous string like structures at partonic 2-surfaces as standard conformal field theory picture would suggest. If also S-matrix is algebraic, one can wonder whether there is any difference between p-adic and real physics at all. The latter option would mean that intentional action is followed by a unitarity process U analogous to a dispersion of completely localized particle implied by Schrödinger equation.

The algebraic universality of S-matrix could mean that S-matrix is obtained as algebraic continuation of rational S-matrix by replacing incoming momenta and other continuous quantum numbers with real ones. Similar continuation should make sense in p-adic sector. S-matrix and U-matrix in a given algebraic extension of rationals or p-adics are not in general diagonalizable. Thus number theory would allow to avoid the paradoxical conclusion that S-matrix is always diagonal in a suitable basis.

4.2.6 Number theoretic ideas

p-Adic physics emerged roughly at the same time via p-adic mass calculations. The interpretation of p-adic physics as physics of cognition and intentionality emerged. The basic idea was that bosonic p-adic space-time sheets provide representations for intentions and the transformation of intention to action corresponds to a transformation of p-adic space-time sheet to a real one. Gauge bosons identified as pairs of wormhole throats carrying fermion and antifermion numbers so that a more precise characterization of "bosonic" would be as "purely bosonic" meaning wormhole throat associated with CP_2 type extremal. These bosons would be exotic and correspond to states of super-symplectic representations. If one accepts the hypothesis that fermionic Fock algebra represents Boolean cognition, one ends up the idea that fermions and their p-adic counterparts appear as pairs and that p-adic partonic 2-surface has interpretation as cognitive representation of fermion. This picture conforms nicely with interpretation in terms of infinite primes.

Cognition and intentionality would be present already at elementary particle level and p-adic fractality would be the experimental signature of it making itself visible in elementary particle mass spectrum among other things. The success of p-adic mass calculations provides strong support for the hypothesis.

This led gradually to the vision about physics as generalized number theory. It involves three separate aspects.

- (a) The p-adic approach led eventually to the program of fusing real physics and various p-adic physics to a single coherent whole by generalizing the number concept by gluing reals and various p-adics to a larger structure along common rationals and algebraics. This inspired the notion of algebraic universality stating that for instance S-matrix should result by algebraic continuation from rational or at most algebraic valued S-matrix.

The notion of number theoretic braid belonging to the algebraic intersection of real and p-adic partonic 2-surface obeying same algebraic equations emerged also and gives a further connection with topological QFT:s. The perturbation theoretic definition of S-matrix is definitely excluded in this approach and TGD indeed leads to the understanding of coupling constant evolution at the level of "free" theory as a discrete p-adic coupling constant evolution so that radiative corrections are not needed for this purpose.

- (b) Also the classical number fields relate closely to TGD and the vision is that imbedding space $M^4 \times CP_2$ emerges from the physics based on hyper-octonionic 8-space with associativity as the fundamental dynamical principle both at classical and quantum level. Hyper-octonion

space M^8 with space-time surface identified as hyper-quaternionic sub-manifolds or their duals and $M^4 x CP_2$ would provide in this framework dual manners to describe physics and this duality would provide TGD counterpart for compactification.

- (c) The construction of infinite primes is analogous to repeated second quantization of supersymmetric arithmetic quantum field theory. This notion implies a further generalization of real and p-adic numbers allowing space-time points to have infinitely complex number theoretic structure not visible at the level of real physics. The idea is that space-time points define the Platonia able to represent in its structure arbitrarily complex mathematical structures and that space-time points could be seen as evolving structures becoming quantum jump by quantum jump increasingly complex number theoretically. Even the world of classical worlds (light-like 3-surfaces) and quantum states of Universe might be represented in terms of the number theoretic anatomy of space-time points (number theoretic Brahman=Atman and algebraic holography).

S-matrix as a functor and the groupoid structure formed by S-matrices

In zero energy ontology S-matrix can be seen as a functor from the category of Feynman cobordisms to the category of operators. S-matrix can be identified as a "square root" of the positive energy density matrix $S = \rho_+^{1/2} S_0$, where S_0 is a unitary matrix and ρ_+ is the density matrix for positive energy part of the zero energy state. Obviously one has $SS^\dagger = \rho_+$. $S^\dagger S = \rho_-$ gives the density matrix for negative energy part of zero energy state. Clearly, S-matrix can be seen as matrix valued generalization of Schrödinger amplitude. Note that the "indices" of the S-matrices correspond to configuration space spinors (fermions and their bound states giving rise to gauge bosons and gravitons) and to configuration space degrees of freedom (world of classical worlds). For hyper-finite factor of II_1 it is not strictly speaking possible to speak about indices since the matrix elements are traces of the S-matrix multiplied by projection operators to infinite-dimensional subspaces from right and left.

The functor property of S-matrices implies that they form a multiplicative structure analogous but not identical to groupoid [A10]. Recall that groupoid has associative product and there exist always right and left inverses and identity in the sense that ff^{-1} and $f^{-1}f$ are always defined but not identical and one has $fgg^{-1} = f$ and $f^{-1}fg = g$.

The reason for the groupoid like property is that S-matrix is a map between state spaces associated with initial and final sets of partonic surfaces and these state spaces are different so that inverse must be replaced with right and left inverse. The defining conditions for groupoid are replaced with more general ones. Also now associativity holds but the role of inverse is taken by hermitian conjugate. Thus one has the conditions $fgg^\dagger = f\rho_{g,+}$ and $f^\dagger fg = \rho_{f,-}g$, and the conditions $ff^\dagger = \rho_+$ and $f^\dagger f = \rho_-$ are satisfied. Here ρ_\pm is density matrix associated with positive/negative energy parts of zero energy state. If the inverses of the density matrices exist, groupoid axioms hold true since $f_L^{-1} = f^\dagger \rho_{f,+}^{-1}$ satisfies $ff_L^{-1} = Id_+$ and $f_R^{-1} = \rho_{f,-}^{-1} f^\dagger$ satisfies $f_R^{-1} f = Id_-$.

There are good reasons to believe that also tensor product of its appropriate generalization to the analog of co-product makes sense with non-triviality characterizing the interaction between the systems of the tensor product. If so, the S-matrices would form very beautiful mathematical structure bringing in mind the corresponding structures for 2-tangles and N-tangles. Knowing how incredibly powerful the group like structures have been in physics, one has good reasons to hope that groupoid like structure might help to deduce a lot of information about the quantum dynamics of TGD.

A word about nomenclature is in order. S has strong associations to unitarity and it might be appropriate to replace S with some other letter. The interpretation of S-matrix as a generalized Schrödinger amplitude would suggest Ψ -matrix. Since the interaction with Kea's M-theory blog (with M denoting Monad or Motif in this context) was crucial for the realization of the the connection with density matrix, also M -matrix might work. S-matrix as a functor from the category of Feynman cobordisms in turn suggests C or F. Or could just Matrix denoted by M in formulas be enough?

Number theoretic braids

The notion of number theoretic braid has gradually evolved to a fundamental notion in quantum TGD and both number theoretical universality (p-adicization), TGD as almost-TQFT, and the notion of finite measurement resolution lead to this notion. The decisive proof of the notion came from the observation that the special properties of Kähler action imply this concept. In the quantization of induced spinor fields the number of fermionic oscillators is finite so that anti-commutation relations can hold true only for a finite point set defining the points of the number theoretic braid. The natural identification of the number theoretic braid is as the intersection of M^4 (CP_2) projection of X_l^3 with the back M^2 of M^4 book (back S_i^2 , $i = I, II$, of CP_2 book) so that the points of braid would be always quantum critical. Both homologically trivial ($i = I$) and non-trivial geodesic sphere ($i = II$) can be considered in the case of CP_2 so that there would be three possibly equivalent braidings defining kind of holy trinity.

The notion of number theoretic braid is especially interesting from the point of view of quantum biology. Generalized Feynman diagrams obtained by gluing light-like partonic 3-surfaces (whose sizes can be arbitrarily large) along their ends and define what might be called Feynman cobordisms. The first expectation was that number theoretic braids replicate in the vertices identifiable as partonic 2-surfaces at which the incoming and outgoing lines of generalized Feynman diagram meet. This would be nice but is not the case since by the lacking anti-commutativity of the incoming and outgoing oscillator operators the lines need not meet in this manner. This suggested an attractive information theoretic interpretation of generalized Feynman diagrams. Incoming and outgoing "lines" would give rise to topological quantum computations characterized by corresponding M-matrices, vertices would represent the replication of number theoretic braids analogous to DNA replication, and internal lines would be analogous to quantum communications. One could generalize this simple view about computation by allowing creation of new strands instead of mere replication.

Number theoretic braids are associated with light-like 3-surfaces and can be said to have both dynamical and static characteristics. Partonic 2-surfaces as sub-manifolds of space-like 3-surface can also become linked and knotted and would naturally define space-like counterparts of tangles. Number theoretic braids could define dynamical topological quantum computation like operations whereas partonic 2-surfaces associated with say RNA could define as their space-like counterparts tangles and in the special case braids analogous to printed quantum programs so that there is duality between space-like and light-like braids [K29]. In terms of dance metaphor the dynamical braiding defined by the light like braid points interpreted as dancers has as a dual space-like braiding resulting as the threads connecting the feet of the dancers get tangled. An interesting question is how light-like and space-like braidings are transformed to each other: could this process correspond to a conscious reading like process and how closely DNA relates to language so that reading and writing would be fundamental processes appearing in all scales.

It came as a pleasant surprise that the idea about duality of space-like and light-like braidings inspired by DNA as topological quantum computer [J3] [K29] is realized at the level of basic quantum TGD [K19]. The dual slicings of $X^4(X_l^3)$ to string world sheets Y^2 and partonic 2-surfaces X^2 generalize the original picture in the sense that one can speak either about partons or string world sheets as basic objects. The strings connecting points of braid strands in X_l^3 would define space-like braidings whereas time like braidings are associated with X_l^3 . The light-like braiding at X_l^3 induces the space-like braiding of strings connecting the points of the strands to the strands of other braids.

Dark matter hierarchy and hierarchy of quantum critical systems in modular degrees of freedom

Dark matter hierarchy corresponds to a hierarchy of conformal symmetries Z_n of partonic 2-surfaces with genus $g \geq 1$ such that factors of n define subgroups of conformal symmetries of Z_n . By the decomposition $Z_n = \prod_{p|n} Z_p$, where $p|n$ tells that p divides n , this hierarchy corresponds to an hierarchy of increasingly quantum critical systems in modular degrees of freedom. For a given prime p one has a sub-hierarchy $Z_p, Z_{p^2} = Z_p \times Z_p$, etc... such that the moduli at $n+1$:th level are contained by n :th level. In the similar manner the moduli of Z_n are sub-moduli for each

prime factor of n . This mapping of integers to quantum critical systems conforms nicely with the general vision that biological evolution corresponds to the increase of quantum criticality as Planck constant increases. This hierarchy would also define a hierarchy of conscious entities and could relate directly to mathematical cognition.

The group of conformal symmetries could be also non-commutative discrete group having Z_n as a subgroup. This inspires a very short-lived conjecture that only the discrete subgroups of $SU(2)$ allowed by Jones inclusions are possible as conformal symmetries of Riemann surfaces having $g \geq 1$. Besides Z_n one could have tetrahedral and icosahedral groups plus cyclic group Z_{2n} with reflection added but not Z_{2n+1} nor the symmetry group of cube. The conjecture is wrong. Consider the orbit of the subgroup of rotational group on standard sphere of E^3 , put a handle at one of the orbits such that it is invariant under rotations around the axis going through the point, and apply the elements of subgroup. You obtain a Riemann surface having the subgroup as its isometries. Hence all discrete subgroups of $SU(2)$ can act even as isometries for some value of g .

The number theoretically simple ruler-and-compass integers having as factors only first powers of Fermat primes and power of 2 would define a physically preferred sub-hierarchy of quantum criticality for which subsequent levels would correspond to powers of 2: a connection with p-adic length scale hypothesis suggests itself.

Spherical topology is exceptional since in this case the space of conformal moduli is trivial and conformal symmetries correspond to the entire $SL(2, C)$. This would suggest that only the fermions of lowest generation corresponding to the spherical topology are maximally quantum critical. This brings in mind Jones inclusions for which the defining subgroup equals to $SU(2)$ and Jones index equals to $\mathcal{M}/\mathcal{N} = 4$. In this case all discrete subgroups of $SU(2)$ label the inclusions. These inclusions would correspond to fiber space $CP_2 \rightarrow CP_2/U(2)$ consisting of geodesic spheres of CP_2 . In this case the discrete subgroup might correspond to a selection of a subgroup of $SU(2) \subset SU(3)$ acting non-trivially on the geodesic sphere. Cosmic strings $X^2 \times Y^2 \subset M^4 \times CP_2$ having geodesic spheres of CP_2 as their ends could correspond to this phase dominating the very early cosmology.

4.3 Identification of elementary particles and the role of Higgs in particle massivation

The development of the recent view about the identification of elementary particles and particle massivation has taken fifteen years since the discovery of p-adic thermodynamics around 1993. p-Adic thermodynamics worked excellently from the beginning for fermions. Only the understanding of gauge boson masses turned out to be problematic and group theoretical arguments led to the proposal that Higgs boson should be present and give the dominating contribution to the masses of gauge bosons whereas the contribution to fermion masses should be small and even negligible. The detailed understanding of quantum TGD at partonic level eventually led to the realization that the coupling to Higgs is not needed after all. The deviation Δh of the ground state conformal weight from negative integer has interpretation as effective Higgs contribution since Higgs vacuum expectation is naturally proportional to Δh but the coupling to Higgs does not cause massivation. In the following I summarize the basic identification of elementary particles and massivation.

4.3.1 Identification of elementary particles

The developments in the formulation of quantum TGD which have taken place during the period 2005-2007 [K23, K22] suggest dramatic simplifications of the general picture discussed in the earlier version of this chapter. p-Adic mass calculations [K55, K56, K52] leave a lot of freedom concerning the detailed identification of elementary particles.

Elementary fermions and bosons

The basic open question is whether the *theory is on some sense free at parton level* as suggested by the recent view about the construction of S-matrix (actually its generalization M-matrix) and by the almost topological QFT property of quantum TGD at parton level [K22]. If partonic 2-surfaces at elementary particle level carry only free many-fermion states, no bi-local composites of second quantized induced spinor field would be needed in the construction of the quantum states and this would simplify the theory enormously.

If this is the case, the basic conclusion would be that light-like 3-surfaces - in particular the ones at which the signature of induced metric changes from Minkowskian to Euclidian - are carriers of fermionic quantum numbers. These regions are associated naturally with CP_2 type vacuum extremals identifiable as correlates for elementary fermions if only fermion number ± 1 is allowed for the stable states. The question however arises about the identification of elementary bosons.

Wormhole contacts with two light-like wormhole throats carrying fermion and anti-fermion quantum numbers are the first thing that comes in mind. The wormhole contact connects two space-time sheets with induced metric having Minkowski signature. Wormhole contact itself has an Euclidian metric signature so that there are two wormhole throats which are light-like 3-surfaces and would carry fermion and anti-fermion number. In this case a delicate question is whether the space-time sheets connected by wormhole contacts have opposite time orientations or not. If this the case the two fermions would correspond to positive and negative energy particles.

I considered first the identification of only Higgs as a wormhole contact but there is no reason why this identification should not apply also to gauge bosons (certainly not to graviton). This identification would imply quite a dramatic simplification since the theory would be free at single parton level and the only stable parton states would be fermions and anti-fermions.

This picture allows to understand the difference between fermions and gauge bosons and Higgs particle. For fermions topological explanation of family replication predicts three fermionic generations [K21] corresponding to handle numbers $g = 0, 1, 2$ for the partonic 2-surface. In the case of gauge bosons and Higgs this replication is not visible. This could be due to the fact that gauge bosons form singlet and octet representation of the dynamical $SU(3)$ group associated with the handle number $g = 0, 1, 2$ since bosons correspond to pairs of handles. If octet representation is heavy the experimental absence of family replication for bosons can be understood.

Graviton and other stringy states

Fermion and anti-fermion can give rise to only single unit of spin since it is impossible to assign angular momentum with the relative motion of wormhole throats. Hence the identification of graviton as single wormhole contact is not possible. The only conclusion is that graviton must be a superposition of fermion-anti-fermion pairs and boson-anti-boson pairs with coefficients determined by the coupling of the parton to graviton. Graviton-graviton pairs might emerge in higher orders. Fermion and anti-fermion would reside at the same space-time sheet and would have a non-vanishing relative angular momentum. Also bosons could have non-vanishing relative angular momentum and Higgs bosons must indeed possess it.

Gravitons are stable if the throats of wormhole contacts carry non-vanishing gauge fluxes so that the throats of wormhole contacts are connected by flux tubes carrying the gauge flux. The mechanism producing gravitons would be the splitting of partonic 2-surfaces via the basic vertex. A connection with string picture emerges with the counterpart of string identified as the flux tube connecting the wormhole throats. Gravitational constant would relate directly to the value of the string tension.

The development of the understanding of gravitational coupling has had many twists and it is perhaps to summarize the basic misunderstandings.

- (a) CP_2 length scale R , which is roughly $10^{3.5}$ times larger than Planck length $l_P = \sqrt{\hbar G}$, defines a fundamental length scale in TGD. The challenge is to predict the value of Planck length $\sqrt{\hbar G}$. The outcome was an identification of a formula for $R^2/\hbar G$ predicting that

the magnitude of Kähler coupling strength α_K is near to fine structure constant in electron length scale (for ordinary value of Planck constant should be added here).

- (b) The emergence of the parton level formulation of TGD finally demonstrated that G actually appears in the fundamental parton level formulation of TGD as a fundamental constant characterizing the M^4 part of CP_2 Kähler gauge potential [K19, K63]. This part is pure gauge in the sense of standard gauge theory but necessary to guarantee that the theory does not reduce to topological QFT. Quantum criticality requires that G remains invariant under p-adic coupling constant evolution and is therefore predictable in principle at least.
- (c) The TGD view about coupling constant evolution predicts the proportionality $G \propto L_p^2$, where L_p is p-adic length scale. Together with input from p-adic mass calculations one ends up to two conclusions. The correct conclusion was that Kähler coupling strength is equal to the fine structure constant in the p-adic length scale associated with Mersenne prime $p = M_{127} = 2^{127} - 1$ assignable to electron. I have considered also the possibility that α_K would be equal to electro-weak $U(1)$ coupling in this scale.
- (d) The additional - wrong- conclusion was that gravitons must always correspond to the p-adic prime M_{127} since G would otherwise vary as function of p-adic length scale. As a matter fact, the question was for years whether it is G or g_K^2 which remains invariant under p-adic coupling constant evolution. I found both options unsatisfactory until I realized that RG invariance is possible for both g_K^2 and G ! The point is that the exponent of the Kähler action associated with the piece of CP_2 type vacuum extremal assignable with the elementary particle is exponentially sensitive to the volume of this piece and logarithmic dependence on the volume fraction is enough to compensate the $L_p^2 \propto p$ proportionality of G and thus guarantee the constancy of G .

The explanation for the small value of the gravitational coupling strength serves as a test for the proposed picture. The exchange of ordinary gauge boson involves the exchange of single CP_2 type extremal giving the exponent of Kähler action compensated by state normalization. In the case of graviton exchange two wormhole contacts are exchanged and this gives second power for the exponent of Kähler action which is not compensated. It would be this additional exponent that would give rise to the huge reduction of gravitational coupling strength from the naive estimate $G \sim L_p^2$.

Gravitons are obviously not the only stringy states. For instance, one obtains spin 1 states when the ends of string correspond to gauge boson and Higgs. Also non-vanishing electro-weak and color quantum numbers are possible and stringy states couple to elementary partons via standard couplings in this case. TGD based model for nuclei as nuclear strings having length of order $L(127)$ [K77] suggests that the strings with light M_{127} quark and anti-quark at their ends identifiable as companions of the ordinary graviton are responsible for the strong nuclear force instead of exchanges of ordinary mesons or color van der Waals forces.

Also the TGD based model of high T_c super-conductivity involves stringy states connecting the space-time sheets associated with the electrons of the exotic Cooper pair [K15, K16]. Thus stringy states would play a key role in nuclear and condensed matter physics, which means a profound departure from stringy wisdom, and breakdown of the standard reductionistic picture.

Spectrum of non-stringy states

The 1-throat character of fermions is consistent with the generation-genus correspondence. The 2-throat character of bosons predicts that bosons are characterized by the genera (g_1, g_2) of the wormhole throats. Note that the interpretation of fundamental fermions as wormhole contacts with second throat identified as a Fock vacuum is excluded.

The general bosonic wave-function would be expressible as a matrix M_{g_1, g_2} and ordinary gauge bosons would correspond to a diagonal matrix $M_{g_1, g_2} = \delta_{g_1, g_2}$ as required by the absence of neutral flavor changing currents (say gluons transforming quark genera to each other). 8 new gauge bosons are predicted if one allows all 3×3 matrices with complex entries orthonormalized with respect to trace meaning additional dynamical $SU(3)$ symmetry. Ordinary gauge bosons would be $SU(3)$ singlets in this sense. The existing bounds on flavor changing neutral currents

give bounds on the masses of the boson octet. The 2-throat character of bosons should relate to the low value $T = 1/n \ll 1$ for the p-adic temperature of gauge bosons as contrasted to $T = 1$ for fermions.

If one forgets the complications due to the stringy states (including graviton), the spectrum of elementary fermions and bosons is amazingly simple and almost reduces to the spectrum of standard model. In the fermionic sector one would have fermions of standard model. By simple counting leptonic wormhole throat could carry $2^3 = 8$ states corresponding to 2 polarization states, 2 charge states, and sign of lepton number giving $8+8=16$ states altogether. Taking into account phase conjugates gives $16+16=32$ states.

In the non-stringy boson sector one would have bound states of fermions and phase conjugate fermions. Since only two polarization states are allowed for massless states, one obtains $(2+1) \times (3+1) = 12$ states plus phase conjugates giving $12+12=24$ states. The addition of color singlet states for quarks gives 48 gauge bosons with vanishing fermion number and color quantum numbers. Besides 12 electro-weak bosons and their 12 phase conjugates there are 12 exotic bosons and their 12 phase conjugates. For the exotic bosons the couplings to quarks and leptons are determined by the orthogonality of the coupling matrices of ordinary and boson states. For exotic counterparts of W bosons and Higgs the sign of the coupling to quarks is opposite. For photon and Z^0 also the relative magnitudes of the couplings to quarks must change. Altogether this makes $48+16+16=80$ states. Gluons would result as color octet states. Family replication would extend each elementary boson state into $SU(3)$ octet and singlet and elementary fermion states into $SU(3)$ triplets.

What about light-like boundaries and macroscopic wormhole contacts?

Light-like boundaries of the space-time sheet as also wormhole throats can have macroscopic size and can carry free many-fermion states but not elementary bosons. Number theoretic braids and anyons might be assignable to these structures. Deformations of cosmic strings to magnetic flux tubes with a light-like outer boundary are especially interesting in this respect.

If the ends of a string like object move with light velocity as implied by the usual stringy boundary conditions they indeed define light-like 3-surfaces. Many-fermion states could be assigned at the ends of string. One could also connect in pairwise manner the ends of two time-like strings having opposite time orientation using two space-like strings so that the analog of boson state consisting of two wormhole contacts and analogous to graviton would result. "Wormhole throats" could have arbitrarily long distance in M^4 .

Wormhole contacts can be regarded as slightly deformed CP_2 type extremals only if the size of M^4 projection is not larger than CP_2 size. The natural question is whether one can construct macroscopic wormhole contacts at all.

- (a) The throats of wormhole contacts cannot belong to vacuum extremals. One might however hope that small deformations of macroscopic vacuum extremals could yield non-vacuum wormhole contacts of macroscopic size.
- (b) A large class of macroscopic wormhole contacts which are vacuum extremals consists of surfaces of form $X_1^2 \times X_2^2 \subset (M^1 \times Y^2) \times E^3$, where Y^2 is Lagrangian manifold of CP_2 (induced Kähler form vanishes) and $M^4 = M^1 \times E^3$ represents decomposition of M^1 to time-like and space-like sub-spaces. X_2^2 is a stationary surface of E^3 . Both $X_1^2 \subset M^1 \times CP_2$ and X_2^2 have an Euclidian signature of metric except at light-like boundaries $X_a^1 \times X_2^2$ and $X_b^1 \times X_2^2$ defined by ends of X_1^2 defining the throats of the wormhole contact.
- (c) This kind of vacuum extremals could define an extremely general class of macroscopic wormhole contacts as their deformations. These wormhole contacts describe an interaction of wormhole throats regarded as closed strings as is clear from the fact that X^2 can be visualized as an analog of closed string world sheet X_1^2 in $M^1 \times Y^2$ describing a reaction leading from a state with a given number of incoming closed strings to a state with a given number of outgoing closed strings which correspond to wormhole throats at the two space-time sheets involved.

If one accepts the hierarchy of Planck constants [K30] leading to the generalization of the notion of imbedding space, the identification of anyonic phases in terms of macroscopic light-like surfaces emerges naturally. In this kind of states large fermion numbers are possible. Dark matter would correspond to this kind of phases and "partonic" 2-surfaces could have even astrophysical size. Also black holes can be identified as dark matter at light-like 3-surfaces analogous to black hole horizons and possessing gigantic value of Planck constant [K63].

4.3.2 New view about the role of Higgs boson in massivation

The proposed identifications challenge the standard model view about particle massivation.

- (a) The standard model inspired interpretation would be that Higgs vacuum expectation associated with the coherent state of neutral Higgs wormhole contacts generates gauge boson mass. Higgs could not however contribute to fermion mass since Higgs condensate cannot accompany fermionic space-time sheets. Fermionic mass would be solely to p-adic thermodynamics. This assumption is consistent with experimental facts but means asymmetry between fermions and bosons.
- (b) The alternative interpretation inspired by p-adic thermodynamics. Besides the thermodynamical contribution to the particle mass there can be a small contribution from the ground state conformal weight unless this weight is not negative integer. Gauge boson mass would correspond to the ground state conformal weight present in both fermionic and bosonic states and in the case of gauge bosons this contribution would dominate due to the small value of p-adic temperature. For fermions p-adic thermodynamics for super Virasoro algebra would give the dominating contribution to the mass. Higgs vacuum expectation value would be proportional to the square root of ground state conformal weight for the simple reason that it is the only natural dimensional parameter available. Therefore the causal relation between Higgs and massivation would have been misunderstood in standard model inspired framework. As will be found, the generalized eigen values of the modified Dirac operator having dimension of mass have a natural interpretation as square roots of ground state conformal weight and eigenvalues reflect directly the dynamics of Kähler action.
- (c) The remaining problem is to understand how the negative value of the ground state conformal weight emerges. This negative conformal weight compensated by the action of Super Virasoro generators is necessary for the success of p-adic mass calculations. Also this problem finds a natural solution. The generalized eigenvalues of the modified Dirac operator are purely imaginary if the effective metric associated with the modified Dirac operator has Euclidian signature. Ground state conformal would be negative and if it is not integer, an effective Higgs contribution to the mass squared is implied. For fermions the deviation from negative integer would be small. Hence p-adic thermodynamics is able to describe the massivation without the introduction of coupling to Higgs, which in TGD framework would be necessarily only a phenomenological description.

4.3.3 Microscopic identification of Weinberg angle

Only after the discovery how the information about preferred extremal of Kähler action can be feeded to the spectrum of modified Dirac operator (see the discussion about modified Dirac action), a real understanding of TGD invariant of Higgs mechanism emerged.

- (a) The generalized eigenvalues of the transverse part $D_K(X^2)$ of the modified Dirac operator D_K are simply square roots of ground state conformal weights and by analogy with cyclotron energies the conformal weights are in reasonable approximation given by $h = -n - 1/2$ giving the desired $h \simeq -1/2$ for lowest state plus finite number of additional ground states. The deviation Δh of h from half odd integer value cannot be compensated by the action of Virasoro generators and it is this contribution which has interpretation as Higgs contribution to mass squared. Higgs zero phase thus corresponds to integer value for h which is highly improbable since the induced ew magnetic field at X_l^3 does not correspond

exactly to constant magnetic field. Δh is present for both fermions and bosons, should be small for fermions and dominate for gauge bosons. The vacuum expectation of Higgs is indeed naturally proportional to Δh but the presence of Higgs condensate does not cause the massivation.

- (b) One must also understand the relationship $M_W^2 = M_Z^2 \cos^2(\theta_W)$ requiring $\Delta h(W)/\Delta h(Z) = \cos^2(\theta_W)$. Essentially, one should understand the dependence of the quantum averaged the spectrum of modified Dirac operator on the quantum numbers of elementary particle over configuration space degrees of freedom. Suppose that the zero energy state describing particle is proportional to a phase factor depending on electro-weak and color quantum numbers of the particle. This phase factor would be simply $\exp[i \int Tr(gQA_\mu)(dx^\mu/ds)ds]$ assignable to the strand of the number theoretic braid: gQ is the diagonal charge matrix characterizing the particle and A_μ represents gauge potential: in the electro-weak case components of the induced spinor connection and the case of color interactions the space-time projection of Killing forms j_k^A of color isometries. Stationary phase approximation selects a preferred light-like 3-surface X_l^3 for given quantum numbers and boundary conditions assign to this preferred extremal of Kähler action defining the exponent of Kähler function so that also Δh depends on quantum numbers of the particle.

Second challenge is to understand how the mixing of neutral gauge bosons B_3 and B_0 relates to the group theoretic factor $\cos^2(\theta_W)$. The condition that the Higgs expectation value for gauge boson B is proportional to $\Delta h(B)$ and that the coherent state of Higgs couples gauge bosons regarded as fermion anti-fermion pairs should explain the mixing.

- (a) If gauge bosons and Higgs correspond to wormhole contacts, the discussion reduces to one-fermion level. The value of Δh should be different for different charge states $F_{\pm 1/2}$ of elementary fermion (in the following I will drop from discussion delicacies due to the fact that both quarks and leptons and fermion families are involved). The values of λ of fermion and anti-fermion assignable to gauge boson are naturally identical

$$\Delta\lambda(F_{\pm 1/2}) = \Delta\lambda(\bar{F}_{\pm 1/2}) \equiv x_{\pm 1/2} . \quad (4.3.1)$$

This implies

$$\begin{aligned} \Delta h(Z, W) &\equiv \Delta h(Z) - \Delta h(W) = m_Z^2 - m_W^2 = m_Z^2 \sin^2(\theta) , \\ \Delta h(Z) &= 1/2 \sum_{\pm} (\Delta\lambda(F_{\pm 1/2}) + \Delta\lambda(\bar{F}_{\mp 1/2}))^2 = 2 \sum_{\pm} x_{\pm 1/2}^2 , \\ \Delta h(W) &= 1/2 \sum_{\pm} (\Delta\lambda(F_{\pm 1/2}) + \Delta\lambda(\bar{F}_{\pm 1/2}))^2 = (x_{1/2} + x_{-1/2})^2 . \end{aligned} \quad (4.3.2)$$

This gives

$$\Delta h(Z, W) = (x_{1/2} - x_{-1/2})^2 \quad (4.3.3)$$

giving the condition

$$(x_{1/2} - x_{-1/2})^2 = (x_{1/2} + x_{-1/2})^2 \sin^2(\theta_W) . \quad (4.3.4)$$

The interpretation is as breaking of electro-weak $SU(2)_L$ symmetry coded by the geometry of CP_2 in the structure of spinor connection so that the symmetry breaking is expected to take place. One can *define* the value of Weinberg angle from the formula

$$\sin(\theta_W) \equiv \pm \frac{x_{1/2} - x_{-1/2}}{x_{1/2} + x_{-1/2}} . \quad (4.3.5)$$

- (b) This definition of Weinberg angle should be consistent with the identification of Weinberg angle coming from the couplings of Z^0 and photon to fermions. Also here the reduction of couplings to one-fermion level might help to understand the symmetry breaking. Z^0 and γ decompose as $Z^0 = \cos(\theta_W)B_3 + \sin(\theta_W)B_0$ and $\gamma = -\sin(\theta_W)B_3 + \cos(\theta_W)B_0$, where B_3 corresponds to the gauge potential in $SU(2)_L$ triplet and B_0 the gauge potential in $SU(2)_L$ singlet. Why this mixing should be induced by the splitting of the conformal weights? What induces the mixing of electro-weak triplet with singlet?
- (c) Could it be the coherent state of Higgs field which transforms left handed and right handed fermions to each other and hence also B_3 to B_0 and vice versa? If the Higgs expectation value associated with the coherent state is proportional to Δh , it would not be too surprising if the mixing between B_3 and B_0 caused by the coherent Higgs state were proportional to $(x_{1/2} - x_{-1/2})/(x_{1/2} + x_{-1/2})$. The reason would be that B_3 is antisymmetric with respect to the exchange of weak isospins whereas B_0 is symmetric. Therefore also the mixing amplitude should be antisymmetric with respect to the exchange of isospins and proportional to $(x_{1/2} - x_{-1/2})$. The presence of the numerator is needed to make the amplitude dimensionless. Under this assumption the two identifications of the Weinberg angle are equivalent.
- (d) It is important to notice that Weinberg angle is a quantity assignable operationally to the wormhole contacts at the light-like boundaries of $CD \times CP_2$ but not to the generalized light-like 3-surfaces Y_l^3 parallel X_l^3 . This suggest that Weinberg angle is necessarily constant for given CD and its evolution reduces to discrete p-adic coupling constant evolution labeled by the scales of CD s coming as powers of 2.

This - admittedly oversimplified - picture obviously changes considerably what-causes-what's in the description of gauge boson massivation and the basic argument should be developed into a more precise form.

4.4 Super-symplectic degrees of freedom

4.4.1 What could happen in the transition to non-perturbative QCD?

What happens mathematically in the transition to non-perturbative QCD has remained more or less a mystery. The number theoretical considerations of [K88] inspired the idea that Planck constant is dynamical and has a spectrum given as $\hbar(n) = n\hbar_0$, where n characterizes the quantum phase $q = \exp(i2\pi/n)$ associated with Jones inclusion. The strange finding that the orbits of planets seem to obey Bohr quantization rules with a gigantic value of Planck constant inspired the hypothesis that the increase of Planck constant provides a unique mechanism allowing strongly interacting system to stay in perturbative phase [K72, K30]. The resulting model allows to understand dark matter as a macroscopic quantum phase in astrophysical length and time scales, and strongly suggest a connection with dark matter and biology.

The phase transition increasing Planck constant could provide a model for the transition to confining phase in QCD. When combined with the recent ideas about value spectrum of Kähler coupling strength one ends up with a rather explicit model about non-perturbative aspects of hadron physics already successfully applied in hadron mass calculations [K56]. Mersenne primes seem to define the p-adic length scales of gauge bosons and of hadronic space-time sheets. The quantization of Planck constant provides additional insight to p-adic length scales hypothesis and to the preferred role of Mersenne primes.

Super-symplectic gluons and non-perturbative aspects of hadron physics

According to the model of hadron masses [K56], in the case of light pseudoscalar mesons the contribution of quark masses to the mass squared of meson dominates whereas spin 1 mesons contain a large contribution identified as color interaction conformal weight (color magnetic spin-spin interaction conformal weight and color Coulombic conformal weight). This conformal weight cannot however correspond to the ordinary color interactions alone and is negative for pseudo-scalars and compensated by some unknown contribution in the case of pion in order to avoid tachyonic mass. Quite generally this realizes the idea about light pseudoscalar mesons as Goldstone bosons. Analogous mass formulas hold for baryons but in this case the additional contribution which dominates.

The unknown contribution can be assigned to the $k = 107$ hadronic space-time sheet and must correspond to the non-perturbative aspects of QCD and the failure of the quantum field theory approach at low energies. In TGD the failure of QFT picture corresponds to the presence of configuration space degrees of freedom ("world of classical worlds") in which super-symplectic algebra acts. The failure of the approximation assuming single fixed background space-time is in question.

The purely bosonic generators carry color and spin quantum numbers: spin has however the character of orbital angular momentum. The only electro-weak quantum numbers of super-generators are those of right-handed neutrino. If the super-generators degrees carry the quark spin at high energies, a solution of proton spin puzzle emerges.

The presence of these degrees of freedom means that there are two contributions to color interaction energies corresponding to the ordinary gluon exchanges and exchanges of super-symplectic gluons. It turns out the model assuming same topological mixing of super-symplectic bosons identical to that experienced by U type quarks leads to excellent understanding of hadron masses assuming that hadron spin correlates with the super-symplectic particle content of the hadronic space-time sheet.

According to the argument already discussed, at the hadronic $k = 107$ space electro-weak interactions would be absent and classical $U(1)$ action should vanish. This is guaranteed if $\alpha_{U(1)}$ diverges. This would give

$$\alpha_s = \alpha_K = \frac{1}{4} .$$

This would give also a quantitative articulation for the statement that strong interactions are charge independent.

This α_s would correspond to the interaction via super-symplectic colored gluons and would lead to the failure of perturbation theory. By the general criterion stating that the failure of perturbation theory leads to a phase transition increasing the value of Planck constant one expects that the value of \hbar increases [K30]. The value leaving the value of α_K invariant would be $\hbar \rightarrow 26\hbar$ and would mean that p-adic length scale L_{107} is replaced with length scale $26L_{107} = 46$ fm, the size of large nucleus so that also the basic length scale nuclear physics would be implicitly coded into the structure of hadrons.

Why Mersenne primes should label a fractal hierarchy of physics?

There are motivations for the working hypothesis stating that there is fractal hierarchy of copies of standard model physics, and that Mersenne primes label both hadronic space-time sheets and gauge bosons. The reason for this is not yet well understood and I have considered several speculative explanations.

1. First picture

The first thing to come in mind is that Mersenne primes correspond to fixed points of the discrete p-adic coupling constant evolution, most naturally to the maxima of the color coupling constant

strength. This would mean that gluons are emitted with higher probability than in other p-adic length scales.

There is however an objection against this idea. If one accepts the new vision about non-perturbative aspects of QCD, it would seem that super-symplectic bosons or the interaction between super-symplectic bosons and quarks for some reason favors Mersenne primes. However, if color coupling strength corresponds to $\alpha_K = \alpha_s = 1/4$ scaled down by the increase of the Planck constant, the evolution of super-symplectic color coupling strength does not seem to play any role. What becomes large should be a geometric "form factor", when the boson in the vertex corresponds to Mersenne prime rather than "bare" coupling.

The resolution of the problem could be that boson emission vertices $g(p_1, p_2, p_3)$ are functions of p-adic primes labeling the particles of the vertices so that actually three p-adic length scales are involved instead of single length scale as in the ordinary coupling constant evolution. Hence one can imagine that the interaction between particles corresponding to primes near powers of 2 and Mersenne primes is especially strong and analogous to a resonant interaction. The geometric resonance due to the fact that the length scales involved are related by a fractal scaling by a power of 2 would make the form factors $F(p_1 \simeq 2^{k_1}, p_2 \simeq 2^{k_2}, M_n)$ large. The selection of primes near powers of two and Mersenne bosons would be analogous to evolutionary selection of a population consisting of species able to interact strongly.

Since $k = 113$ quarks are possible for $k = 107$ hadron physics, it seems that quarks can have join along boundaries bonds directed to M_n space-times with $n < k$. This suggests that neighboring Mersenne primes compete for join along boundaries bonds of quarks. For instance, when the p-adic length scale characterizing quark of M_{107} hadron physics begins to approach M_{89} quarks tend to feed their gauge flux to M_{89} space-time sheet and M_{89} hadron physics takes over and color coupling strength begins to increase. This would be the space-time correlate for the loss of asymptotic freedom.

2. Second picture

Preferred values of Planck constants could play a key role in the selection of Mersenne primes. Ruler-and-compass hypothesis predicts that Planck constants, which correspond to ratios of ruler and compass integers proportional to a product of distinct Fermat primes (four of them are known) and any power of two are favored. As a special case one obtains ruler and compass integers. As a consequence, p-adic length scales have satellites obtained by multiplying them with ruler-and-compass integers, and entire fractal hierarchy of power-of-two multiples of a given p-adic length scale results.

Mersenne length scales would be special since their satellites would form a subset of satellites of shorter Mersenne length scales. The copies of standard model physics associated with Mersenne primes would define a kind of resonating subset of physics since corresponding wavelengths and frequencies would coincide. This would also explain why fermions labeled by primes near power of two couple strongly with Mersenne primes.

4.4.2 Super-symplectic bosons as a particular kind of dark matter

Super-symplectic bosons

TGD predicts also exotic bosons which are analogous to fermion in the sense that they correspond to single wormhole throat associated with CP_2 type vacuum extremal whereas ordinary gauge bosons corresponds to a pair of wormhole contacts assignable to wormhole contact connecting positive and negative energy space-time sheets. These bosons have super-conformal partners with quantum numbers of right handed neutrino and thus having no electro-weak couplings. The bosons are created by the purely bosonic part of super-symplectic algebra [K20, K19], whose generators belong to the representations of the color group and 3-D rotation group but have vanishing electro-weak quantum numbers. Their spin is analogous to orbital angular momentum whereas the spin of ordinary gauge bosons reduces to fermionic spin. Recall that super-symplectic algebra is crucial for the construction of configuration space Kähler geometry. If one assumes that super-symplectic gluons suffer topological mixing identical with that suffered

by say U type quarks, the conformal weights would be (5,6,58) for the three lowest generations. The application of super-symplectic bosons in TGD based model of hadron masses is discussed in [K56] and here only a brief summary is given.

As explained in [K56], the assignment of these bosons to hadronic space-time sheet is an attractive idea.

- (a) Quarks explain only a small fraction of the baryon mass and that there is an additional contribution which in a good approximation does not depend on baryon. This contribution should correspond to the non-perturbative aspects of QCD. A possible identification of this contribution is in terms of super-symplectic gluons. Baryonic space-time sheet with $k = 107$ would contain a many-particle state of super-symplectic gluons with net conformal weight of 16 units. This leads to a model of baryons masses in which masses are predicted with an accuracy better than 1 per cent.
- (b) Hadronic string model provides a phenomenological description of non-perturbative aspects of QCD and a connection with the hadronic string model indeed emerges. Hadronic string tension is predicted correctly from the additivity of mass squared for $J = 2$ bound states of super-symplectic quanta. If the topological mixing for super-symplectic bosons is equal to that for U type quarks then a 3-particle state formed by 2 super-symplectic quanta from the first generation and 1 quantum from the second generation would define baryonic ground state with 16 units of conformal weight. A very precise prediction for hadron masses results by assuming that the spin of hadron correlates with its super-symplectic particle content.
- (c) Also the baryonic spin puzzle caused by the fact that quarks give only a small contribution to the spin of baryons, could find a natural solution since these bosons could give to the spin of baryon an angular momentum like contribution having nothing to do with the angular momentum of quarks.
- (d) Super-symplectic bosons suggest a solution to several other anomalies related to hadron physics. The events observed for a couple of years ago in RHIC [C15] suggest a creation of a black-hole like state in the collision of heavy nuclei and inspire the notion of color glass condensate of gluons, whose natural identification in TGD framework would be in terms of a fusion of hadronic space-time sheets containing super-symplectic matter materialized also from the collision energy. In the collision, valence quarks connected together by color bonds to form separate units would evaporate from their hadronic space-time sheets in the collision, and would define TGD counterpart of Pomeron, which experienced a reincarnation for few years ago [C22]. The strange features of the events related to the collisions of high energy cosmic rays with hadrons of atmosphere (the particles in question are hadron like but the penetration length is anomalously long and the rate for the production of hadrons increases as one approaches surface of Earth) could be also understood in terms of the same general mechanism.

Topological evaporation, quark gluon plasma and Pomeron

Topological evaporation of elementary particles means nothing if CP_2 type vacuum extremal evaporates so that one must assume that it is quark space-time sheet or join along boundaries block of quark space-time sheets which evaporates. Second new element is the identification of valence quarks as dark matter in the sense of having large \hbar : $\hbar_s \simeq (n/v_0)\hbar$, $v_0 \simeq 2^{-11}$, $n = 1$ so that Compton length is scaled by the same factor. Quark gluon plasma would correspond to a phase with ordinary value \hbar and possibly also sea partons can be regarded as this kind of phase. Color bonds between partons are possible also in this phase.

Concerning the evaporation there are two options.

- (a) The space-time sheets of sea partons are condensed at much larger space-time sheets defined by the space-time sheets of valence quarks connected by color bonds. Topological evaporation of the parton sea would correspond to the splitting of $\#$ contacts connecting sea partons space-time sheets to valence quark space-time sheets.

- (b) Sea partons condensed at a larger space-time sheet which in turn condenses at the space-time sheet of valence quarks. In this case topological evaporation occurs for the entire sea parton space-time sheet.

One can consider two possible scenarios for topological evaporation of quarks and gluons.

- (a) Color gauge charge is not identified as gauge flux and single secondarily condensed quark space-time sheet can suffer topological evaporation. In this case quark gluon plasma could be identified as vapor phase state for quarks and gluons.
- (b) Color gauge charge is identified as gauge flux and only join along boundaries blocks formed from quarks can evaporate. Join along boundaries contacts are naturally identified as color flux tubes between quarks. These tubes need not be static. Quark gluon plasma corresponds to condensed state in which the join along boundaries contacts between quark like 3-surfaces are broken. The evaporation of single quark is possible but as a consequence a compensating color charge develops on the interior of the outer boundary of the evaporated quark and the process probably can be interpreted as an emission of meson from hadron. The production of hadrons in hadron collision could be interpreted as a topological evaporation process for sea and valence quarks.

The problematic feature of scenario 1) is the understanding of color confinement. In scenario 2) color confinement of the vapor phase particles is an automatic consequence of the assumption that color charge corresponds to gauge flux classically (gauge field is $H^A J_{\alpha\beta}$, H^A being the Hamiltonian of the color isometry. This does not however exclude the possibility that hadron might feed part of its color isospin or hypercharge gauge flux to surrounding condensate. The concept of anomalous hypercharge introduced in earlier work as proportional to electromagnetic charge indeed suggests this kind of possibility. It should be noticed that for the vacuum extremals of Kähler action induced Kähler field and thus also color fields vanish identically.

The alternatives a) and b) have an additional nice feature that they lead to elegant description for the mysterious concept of Pomeron originally introduced to describe hadronic diffractive scattering as the exchange of Pomeron Regge trajectory [C26]. No hadrons belonging to Pomeron trajectory were however found and via the advent of QCD Pomeron was almost forgotten. Pomeron has recently experienced reincarnation [C22, C13, C14]. In Hera [C22] $e - p$ collisions, in which proton scatters essentially elastically whereas jets in the direction of incoming virtual photon emitted by electron are observed. These events can be understood by assuming that proton emits color singlet particle carrying a small fraction of proton's momentum. This particle in turn collides with the virtual photon (antiproton) whereas proton scatters essentially elastically.

The identification of the color singlet particle as Pomeron looks natural since Pomeron emission describes nicely the diffractive scattering of hadrons. Analogous hard diffractive scattering events in pX diffractive scattering with $X = \bar{p}$ [C13] or $X = p$ [C14] have also been observed. What happens is that proton scatters essentially elastically and the emitted Pomeron collides with X and suffers hard scattering so that large rapidity gap jets in the direction of X are observed. These results suggest that Pomeron is real and consists of ordinary partons.

The TGD identification of Pomeron is as sea partons in vapor phase. In TGD inspired phenomenology events involving Pomeron correspond to pX collisions, where incoming X collides with proton, when sea quarks have suffered coherent simultaneous (by color confinement) evaporation into vapor phase. System X sees only the sea left behind in the evaporation and scatters from it whereas dark valence quarks continue without noticing X and condense later to form quasi-elastically scattered proton. If X suffers hard scattering from the sea, the peculiar hard diffractive scattering events are observed. The fraction of these events is equal to the fraction f of time spent by sea quarks in vapor phase.

Dimensional arguments suggest a rough order of magnitude estimate for $f \sim \alpha_K \sim 1/137 \sim 10^{-2}$ for f . The fraction of the peculiar deep inelastic scattering events at Hera is about 5 percent, which suggest that f is about 6.8 times larger and of same order of magnitude as QCD α_s . The time spent in condensate is by dimensional arguments of the order of the p-adic length scale $L(M_{107})$, not far from proton Compton length. Time dilation effects at high collision energies guarantee that valence quarks indeed stay in vapor phase during the collision. The identification

of Pomeron as sea explains also why Pomeron Regge trajectory does not correspond to actual on mass shell particles.

The existing detailed knowledge about the properties of sea structure functions provides a stringent test for the TGD based scenario. According to [C13] Pomeron structure function seems to consist of soft $((1-x)^5)$, hard $((1-x))$ and super-hard component (delta function like component at $x = 1$). The peculiar super hard component finds explanation in TGD based picture. The structure function $q_P(x, z)$ of parton in Pomeron contains the longitudinal momentum fraction z of the Pomeron as a parameter and $q_P(x, z)$ is obtained by scaling from the sea structure function $q(x)$ for proton $q_P(x, z) = q(zx)$. The value of structure function at $x = 1$ is non-vanishing: $q_P(x = 1, z) = q(z)$ and this explains the necessity to introduce super hard delta function component in the fit of [C13].

Simulating big bang in laboratory

An important steps in the development of ideas were stimulated by the findings made during period 2002-2005 in Relativist Heavy Ion Collider (RHIC) in Brookhaven compared with the finding of America and for full reason.

- (a) The first was finding of longitudinal Lorentz invariance at single particle level suggesting a collective behavior. This was around 2002.
- (b) The collective behavior which was later interpreted in terms of color glass condensate meaning the presence of a blob of liquid like phase decaying later to quark gluon plasma since it was found that the density of what was expected to be quark gluon plasma was about ten times higher than expected.
- (c) The last finding is that this object seems to absorb partons like black hole and behaves like evaporating black hole.

In my personal Theory Universe the history went as follows.

- (a) I proposed 2002 a model for Gold-Gold collision as a mini big bang identified as a scaled down variant of TGD inspired cosmology. This makes sense because in TGD based critical cosmology the initial state has vanishing mass per comoving volume instead of being infinite as in radiation dominated cosmology. Any phase transition involving a generation of a new space-time sheet might proceed in this universal manner.
- (b) Cosmic string soup in the primordial stage is replaced by a tangle of color flux tubes containing the color glass condensate. CGC is made macroscopic quantum phase by conformal confinement (the conformal weights of partons are complex and relate to zeros of zeta) and only the net conformal weight is real in this phase). Flux tubes correspond to flow lines of incompressible liquid flow and non-perturbative phase with a very large \hbar is in question. Gravitational constant is replaced by strong gravitational constant defined by the relevant p-adic length scale squared since color flux tubes are analogs of hadronic strings. Presumably $L_p, p = M_{107} = 2^{107} - 1$, is the p-adic length scale since Mersenne prime M_{107} labels the space-time sheet at which partons feed their color gauge fluxes. Temperature during this phase could correspond to Hagedorn temperature for strings and is determined by string tension. Density would be maximal.
- (c) Next phase is critical phase in which the notion of space-time in ordinary sense makes sense and 3-space is flat since there is no length scale in critical system (so that curvature vanishes). During this critical phase a transition to quark gluon plasma occurs. The duration of this phase fixes all relevant parameters such as temperature (which is the analog of Hagedorn temperature corresponding since critical density is maximal density of gravitational mass in TGD Universe).
- (d) The next phase is radiation dominated quark gluon plasma phase and then follows hadronization to matter dominated phase provided cosmological picture still applies.

Since black hole formation and evaporation is very much like formation big crunch followed by big bang, the picture is more or less equivalent with the picture in which black hole like object consisting of string like objects (mass is determined by string length just as it is determined by the radius for black holes) is formed and then evaporates. Black hole temperature corresponds to Hagedorn temperature and to the duration of critical period of the mini cosmology.

Are ordinary black-holes replaced with super-symplectic black-holes in TGD Universe?

Some variants of super string model predict the production of small black-holes at LHC. I have never taken this idea seriously but in a well-defined sense TGD predicts black-holes associated with super-symplectic gravitons with strong gravitational constant defined by the hadronic string tension. The proposal is that super-symplectic black-holes have been already seen in Hera, RHIC, and the strange cosmic ray events.

Baryonic super-symplectic black-holes of the ordinary M_{107} hadron physics would have mass 934.2 MeV, very near to proton mass. The mass of their M_{89} counterparts would be 512 times higher, about 478 GeV if quark masses scale also by this factor. This need not be the case: if one has $k = 113 \rightarrow 103$ instead of 105 one has 434 GeV mass. "Ionization energy" for Pomeron, the structure formed by valence quarks connected by color bonds separating from the space-time sheet of super-symplectic black-hole in the production process, corresponds to the total quark mass and is about 170 MeV for ordinary proton and 87 GeV for M_{89} proton. This kind of picture about black-hole formation expected to occur in LHC differs from the stringy picture since a fusion of the hadronic mini black-holes to a larger black-hole is in question.

An interesting question is whether the ultrahigh energy cosmic rays having energies larger than the GZK cut-off of 5×10^{10} GeV are baryons, which have lost their valence quarks in a collision with hadron and therefore have no interactions with the microwave background so that they are able to propagate through long distances.

In neutron stars the hadronic space-time sheets could form a gigantic super-symplectic black-hole and ordinary black-holes would be naturally replaced with super-symplectic black-holes in TGD framework (only a small part of black-hole interior metric is representable as an induced metric). This obviously means a profound difference between TGD and string models.

- (a) Hawking-Bekenstein black-hole entropy would be replaced with its p-adic counterpart given by

$$S_p = \left(\frac{M}{m(CP_2)}\right)^2 \times \log(p) , \quad (4.4.1)$$

where $m(CP_2)$ is CP_2 mass, which is roughly 10^{-4} times Planck mass. M is the contribution of p-adic thermodynamics to the mass. This contribution is extremely small for gauge bosons but for fermions and super-symplectic particles it gives the entire mass.

- (b) If p-adic length scale hypothesis $p \simeq 2^k$ holds true, one obtains

$$S_p = k \log(2) \times \left(\frac{M}{m(CP_2)}\right)^2, \quad (4.4.2)$$

$m(CP_2) = \hbar/R$, R the "radius" of CP_2 , corresponds to the standard value of \hbar_0 for all values of \hbar .

- (c) Hawking-Bekenstein area law gives in the case of Schwarzschild black-hole

$$S = \frac{A}{4G} \times \hbar = \pi G M^2 \times \hbar . \quad (4.4.3)$$

For the p-adic variant of the law Planck mass is replaced with CP_2 mass and $k \log(2) \simeq \log(p)$ appears as an additional factor. Area law is obtained in the case of elementary

particles if k is prime and wormhole throats have M^4 radius given by p-adic length scale $L_k = \sqrt{k}R$ which is exponentially smaller than L_p . For macroscopic super-symplectic black-holes modified area law results if the radius of the large wormhole throat equals to Schwarzschild radius. Schwarzschild radius is indeed natural: in [K85] I have shown that a simple deformation of the Schwarzschild exterior metric to a metric representing rotating star transforms Schwarzschild horizon to a light-like 3-surface at which the signature of the induced metric is transformed from Minkowskian to Euclidian.

- (d) The formula for the gravitational Planck constant appearing in the Bohr quantization of planetary orbits and characterizing the gravitational field body mediating gravitational interaction between masses M and m [K72] reads as

$$\hbar_{gr} = \frac{GMm}{v_0} \hbar_0 .$$

$v_0 = 2^{-11}$ is the preferred value of v_0 . One could argue that the value of gravitational Planck constant is such that the Compton length \hbar_{gr}/M of the black-hole equals to its Schwarzschild radius. This would give

$$\hbar_{gr} = \frac{GM^2}{v_0} \hbar_0 , \quad v_0 = 1/2 . \quad (4.4.4)$$

The requirement that \hbar_{gr} is a ratio of ruler-and-compass integers expressible as a product of distinct Fermat primes (only four of them are known) and power of 2 would quantize the mass spectrum of black hole [K72]. Even without this constraint M^2 is integer valued using p-adic mass squared unit and if p-adic length scale hypothesis holds true this unit is in an excellent approximation power of two.

- (e) The gravitational collapse of a star would correspond to a process in which the initial value of v_0 , say $v_0 = 2^{-11}$, increases in a stepwise manner to some value $v_0 \leq 1/2$. For a supernova with solar mass with radius of 9 km the final value of v_0 would be $v_0 = 1/6$. The star could have an onion like structure with largest values of v_0 at the core as suggested by the model of planetary system. Powers of two would be favored values of v_0 . If the formula holds true also for Sun one obtains $1/v_0 = 3 \times 17 \times 2^{13}$ with 10 per cent error.
- (f) Black-hole evaporation could be seen as means for the super-symplectic black-hole to get rid of its electro-weak charges and fermion numbers (except right handed neutrino number) as the antiparticles of the emitted particles annihilate with the particles inside super-symplectic black-hole. This kind of minimally interacting state is a natural final state of star. Ideal super-symplectic black-hole would have only angular momentum and right handed neutrino number.
- (g) In TGD light-like partonic 3-surfaces are the fundamental objects and space-time interior defines only the classical correlates of quantum physics. The space-time sheet containing the highly entangled cosmic string might be separated from environment by a wormhole contact with size of black-hole horizon.

This looks the most plausible option but one can of course ask whether the large partonic 3-surface defining the horizon of the black-hole actually contains all super-symplectic particles so that super-symplectic black-hole would be single gigantic super-symplectic parton. The interior of super-symplectic black-hole would be a space-like region of space-time, perhaps resulting as a large deformation of CP_2 type vacuum extremal. Black-hole sized wormhole contact would define a gauge boson like variant of the black-hole connecting two space-time sheets and getting its mass through Higgs mechanism. A good guess is that these states are extremely light.

4.5 Number theoretic compactification and $M^8 - H$ duality

This section summarizes the basic vision about number theoretic compactification reducing the classical dynamics to number theory. In strong form $M^8 - H$ duality boils down to the

assumption that space-time surfaces can be regarded either as surfaces of H or as surfaces of M^8 composed of hyper-quaternionic and co-hyper-quaternionic regions identifiable as regions of space-time possessing Minkowskian *resp.* Euclidian signature of the induced metric.

4.5.1 Basic idea behind $M^8 - M^4 \times CP_2$ duality

The hopes of giving $M^4 \times CP_2$ hyper-octonionic structure are meager. This circumstance forces to ask whether four-surfaces $X^4 \subset M^8$ could under some conditions define 4-surfaces in $M^4 \times CP_2$ indirectly so that the spontaneous compactification of super string models would correspond in TGD to two different manners to interpret the space-time surface. The following arguments suggest that this is indeed the case.

The hard mathematical fact behind number theoretical compactification is that the quaternionic sub-algebras of octonions with fixed complex structure (that is complex sub-space) are parameterized by CP_2 just as the complex planes of quaternion space are parameterized by $CP_1 = S^2$. Same applies to hyper-quaternionic sub-spaces of hyper-octonions. $SU(3)$ would thus have an interpretation as the isometry group of CP_2 , as the automorphism sub-group of octonions, and as color group.

- (a) The space of complex structures of the octonion space is parameterized by S^6 . The subgroup $SU(3)$ of the full automorphism group G_2 respects the a priori selected complex structure and thus leaves invariant one octonionic imaginary unit, call it e_1 . Hyper-quaternions can be identified as $U(2)$ Lie-algebra but it is obvious that hyper-octonions do not allow an identification as $SU(3)$ Lie algebra. Rather, octonions decompose as $1 \oplus 1 \oplus 3 \oplus \bar{3}$ to the irreducible representations of $SU(3)$.
- (b) Geometrically the choice of a preferred complex (quaternionic) structure means fixing of complex (quaternionic) sub-space of octonions. The fixing of a hyper-quaternionic structure of hyper-octonionic M^8 means a selection of a fixed hyper-quaternionic sub-space $M^4 \subset M^8$ implying the decomposition $M^8 = M^4 \times E^4$. If M^8 is identified as the tangent space of $H = M^4 \times CP_2$, this decomposition results naturally. It is also possible to select a fixed hyper-complex structure, which means a further decomposition $M^4 = M^2 \times E^2$.
- (c) The basic result behind number theoretic compactification and $M^8 - H$ duality is that hyper-quaternionic sub-spaces $M^4 \subset M^8$ containing a fixed hyper-complex sub-space $M^2 \subset M^4$ or its light-like line M_{\pm} are parameterized by CP_2 . The choices of a fixed hyper-quaternionic basis $1, e_1, e_2, e_3$ with a fixed complex sub-space (choice of e_1) are labeled by $U(2) \subset SU(3)$. The choice of e_2 and e_3 amounts to fixing $e_2 \pm \sqrt{-1}e_3$, which selects the $U(2) = SU(2) \times U(1)$ subgroup of $SU(3)$. $U(1)$ leaves 1 invariant and induced a phase multiplication of e_1 and $e_2 \pm e_3$. $SU(2)$ induces rotations of the spinor having e_2 and e_3 components. Hence all possible completions of $1, e_1$ by adding e_2, e_3 doublet are labeled by $SU(3)/U(2) = CP_2$.
- (d) Space-time surface $X^4 \subset M^8$ is by the standard definition hyper-quaternionic if the tangent spaces of X^4 are hyper-quaternionic planes. Co-hyper-quaternionicity means the same for normal spaces. The presence of fixed hyper-complex structure means at space-time level that the tangent space of X^4 contains fixed M^2 at each point. Under this assumption one can map the points $(m, e) \in M^8$ to points $(m, s) \in H$ by assigning to the point (m, e) of X^4 the point (m, s) , where $s \in CP_2$ characterize $T(X^4)$ as hyper-quaternionic plane. This definition is not the only one and even the appropriate one in TGD context the replacement of the tangent plane with the 4-D plane spanned by modified gamma matrices defined by Kähler action is a more natural choice. This plane is not parallel to tangent plane in general. In the sequel $T(X^4)$ denotes the preferred 4-plane which co-incides with tangent plane of X^4 only if the action defining modified gamma matrices is 4-volume.
- (e) The choice of M^2 can be made also local in the sense that one has $T(X^4) \supset M^2(x) \subset M^4 \subset H$. It turns out that strong form of number theoretic compactification requires this kind of generalization. In this case one must be able to fix the convention how the point of CP_2 is assigned to a hyper-quaternionic plane so that it applies to all possible choices of $M^2 \subset M^4$. Since $SO(3)$ hyper-quaternionic rotation relates the hyper-quaternionic

planes to each other, the natural assumption is hyper-quaternionic planes related by $SO(3)$ rotation correspond to the same point of CP_2 . Under this assumption it is possible to map hyper-quaternionic surfaces of M^8 for which $M^2 \subset M^4$ depends on point of X^4 to H .

4.5.2 Hyper-octonionic Pauli "matrices" and modified definition of hyper-quaternionicity

Hyper-octonionic Pauli matrices suggest an interesting possibility to define precisely what hyper-quaternionicity means at space-time level (for background see [K89]).

- (a) According to the standard definition space-time surface X^4 is hyper-quaternionic if the tangent space at each point of X^4 in $X^4 \subset M^8$ picture is hyper-quaternionic. What raises worries is that this definition involves in no manner the action principle so that it is far from obvious that this identification is consistent with the vacuum degeneracy of Kähler action. It also unclear how one should formulate hyper-quaternionicity condition in $X^4 \subset M^4 \times CP_2$ picture.
- (b) The idea is to map the modified gamma matrices $\Gamma^\alpha = \frac{\partial L_K}{\partial h_k^\alpha} \Gamma^k$, $\Gamma_k = e_k^A \gamma_A$, to hyper-octonionic Pauli matrices σ^α by replacing γ_A with hyper-octonion unit. Hyper-quaternionicity would state that the hyper-octonionic Pauli matrices σ^α obtained in this manner span complexified quaternion sub-algebra at each point of space-time. These conditions would provide a number theoretic manner to select preferred extremals of Kähler action. Remarkably, this definition applies both in case of M^8 and $M^4 \times CP_2$.
- (c) Modified Pauli matrices span the tangent space of X^4 if the action is four-volume because one has $\frac{\partial L_K}{\partial h_k^\alpha} = \sqrt{g} g^{\alpha\beta} \partial h_\beta^l h_{kl}$. Modified gamma matrices reduce to ordinary induced gamma matrices in this case: 4-volume indeed defines a super-conformally symmetric action for ordinary gamma matrices since the mass term of the Dirac action given by the trace of the second fundamental form vanishes for minimal surfaces.
- (d) For Kähler action the hyper-quaternionic sub-space does not coincide with the tangent space since $\frac{\partial L_K}{\partial h_k^\alpha}$ contains besides the gravitational contribution coming from the induced metric also the "Maxwell contribution" from the induced Kähler form not parallel to space-time surface. Modified gamma matrices are required by super conformal symmetry for the extremals of Kähler action and they also guarantee that vacuum extremals defined by surfaces in $M^4 \times Y^2$, Y^2 a Lagrange sub-manifold of CP_2 , are trivially hyper-quaternionic surfaces. The modified definition of hyper-quaternionicity does not affect in any manner $M^8 \leftrightarrow M^4 \times CP_2$ duality allowing purely number theoretic interpretation of standard model symmetries.

A side comment not strictly related to hyper-quaternionicity is in order. The anticommutators of the modified gamma matrices define an effective Riemann metric and one can assign to it the counterparts of Riemann connection, curvature tensor, geodesic line, volume, etc... One would have two different metrics associated with the space-time surface. Only if the action defining space-time surface is identified as the volume in the ordinary metric, these metrics are equivalent. The index raising for the effective metric could be defined also by the induced metric and it is not clear whether one can define Riemann connection also in this case. Could this effective metric have concrete physical significance and play a deeper role in quantum TGD? For instance, AdS-CFT duality leads to ask whether interactions be coded in terms of the gravitation associated with the effective metric.

4.5.3 Minimal form of $M^8 - H$ duality

The basic problem in the construction of quantum TGD has been the identification of the preferred extremals of Kähler action playing a key role in the definition of the theory. The most elegant manner to do this is by fixing the 4-D tangent space $T(X^4(X_i^3))$ of $X^4(X_i^3)$ at each point of X_i^3 so that the boundary value problem is well defined. What I called number theoretical

compactification allows to achieve just this although I did not fully realize this in the original vision. The minimal picture is following.

- (a) The basic observations are following. Let M^8 be endowed with hyper-octonionic structure. For hyper-quaternionic space-time surfaces in M^8 tangent spaces are by definition hyper-quaternionic. If they contain a preferred plane $M^2 \subset M^4 \subset M^8$ in their tangent space, they can be mapped to 4-surfaces in $M^4 \times CP_2$. The reason is that the hyper-quaternionic planes containing preferred the hyper-complex plane M^2 of $M_{\pm} \subset M^2$ are parameterized by points of CP_2 . The map is simply $(m, e) \rightarrow (m, s(m, e))$, where m is point of M^4 , e is point of E^4 , and $s(m, 2)$ is point of CP_2 representing the hyperquaternionic plane. The inverse map assigns to each point (m, s) in $M^4 \times CP_2$ point m of M^4 , undetermined point e of E^4 and 4-D plane. The requirement that the distribution of planes containing the preferred M^2 or M_{\pm} corresponds to a distribution of planes for 4-D surface is expected to fix the points e . The physical interpretation of M^2 is in terms of plane of non-physical polarizations so that gauge conditions have purely number theoretical interpretation.
- (b) In principle, the condition that $T(X^4)$ contains M^2 can be replaced with a weaker condition that either of the two light-like vectors of M^2 is contained in it since already this condition assigns to $T(X^4)$ M^2 and the map $H \rightarrow M^8$ becomes possible. Only this weaker form applies in the case of massless extremals [K11] as will be found.
- (c) The original idea was that hyper-quaternionic 4-surfaces in M^8 containing $M^2 \subset M^4$ in their tangent space could correspond to preferred extremals of Kähler action. This condition does not seem to be consistent with what is known about the extremals of Kähler action. The weaker form of the hypothesis is that hyper-quaternionicity holds only for 4-D tangent spaces of $X_l^3 \subset H = M^4 \times CP_2$ identified as wormhole throats or boundary components lifted to 3-surfaces in 8-D tangent space M^8 of H . The minimal hypothesis would be that only $T(X^4(X_l^3))$ at X_l^3 is associative that is hyper-quaternionic for fixed M^2 . $X_l^3 \subset M^8$ and $T(X^4(X_l^3))$ at X_l^3 can be mapped to $X_l^3 \subset H$ if tangent space contains also $M_{\pm} \subset M^2$ or $M^2 \subset M^4 \subset M^8$ itself having interpretation as preferred hyper-complex plane. This condition is not satisfied by all surfaces X_l^3 as is clear from the fact that the inverse map involves local E^4 translation. The requirements that the distribution of hyper-quaternionic planes containing M^2 corresponds to a distribution of 4-D tangent planes should fix the E^4 translation to a high degree.
- (d) A natural requirement is that the image of $X_l^3 \subset H$ in M^8 is light-like. The condition that the determinant of induced metric vanishes gives an additional condition reducing the number of free parameters by one. This condition cannot be formulated as a condition on CP_2 coordinate characterizing the hyper-quaternionic plane. Since M^4 projections are same for the two representations, this condition is satisfied if the contributions from CP_2 and E^4 and projections to the induced metric are identical: $s_{kl}\partial_{\alpha}s^k\partial_{\beta}s^l = e_{kl}\partial_{\alpha}e^k\partial_{\beta}e^l$. This condition means that only a subset of light-like surfaces of M^8 are realized physically. One might argue that this is as it must be since the volume of E^4 is infinite and that of CP_2 finite: only an infinitesimal portion of all possible light-like 3-surfaces in M^8 can have H counterparts. The conclusion would be that number theoretical compactification is 4-D isometry between $X^4 \subset H$ and $X^4 \subset M^8$ at X_l^3 . This unproven conjecture is unavoidable.
- (e) $M^2 \subset T(X^4(X_l^3))$ condition fixes $T(X^4(X_l^3))$ in the generic case by extending the tangent space of X_l^3 , and the construction of configuration space spinor structure fixes boundary conditions completely by additional conditions necessary when X_l^3 corresponds to a light-like 3 surfaces defining wormhole throat at which the signature of induced metric changes. What is especially beautiful that only the data in $T(X^4(X_l^3))$ at X_l^3 is needed to calculate the vacuum functional of the theory as Dirac determinant: the only remaining conjecture (strictly speaking un-necessary but realistic looking) is that this determinant gives exponent of Kähler action for the preferred extremal and there are excellent hopes for this by the structure of the basic construction.

The basic criticism relates to the condition that light-like 3-surfaces are mapped to light-like 3-surfaces guaranteed by the condition that $M^8 - H$ duality is isometry at X_l^3 .

4.5.4 Strong form of $M^8 - H$ duality

The proposed picture is the minimal one. One can of course ask whether the original much stronger conjecture that the preferred extrema of Kähler action correspond to hyper-quaternionic surfaces could make sense in some form. One can also wonder whether one could allow the choice of the plane M^2 of non-physical polarization to be local so that one would have $M^2(x) \subset M^4 \subset M^4 \times E^4$, where M^4 is fixed hyper-quaternionic sub-space of M^8 and identifiable as M^4 factor of H .

- (a) If M^2 is same for all points of X_l^3 , the inverse map $X_l^3 \subset H \rightarrow X_l^3 \subset M^8$ is fixed apart from possible non-uniqueness related to the local translation in E^4 from the condition that hyper-quaternionic planes represent light-like tangent 4-planes of light-like 3-surfaces. The question is whether not only X_l^3 but entire four-surface $X^4(X_l^3)$ could be mapped to the tangent space of M^8 . By selecting suitably the local E^4 translation one might hope of achieving this. The conjecture would be that the preferred extrema of Kähler action are those for which the distribution integrates to a distribution of tangent planes.
- (b) There is however a problem. What is known about extremals of Kähler action is not consistent with the assumption that fixed M^2 of $M_\pm \subset M^2$ is contained in the tangent space of X^4 . This suggests that one should relax the condition that $M^2 \subset M^4 \subset M^8$ is a fixed hyper-complex plane associated with the tangent space or normal space X^4 and allow M^2 to vary from point to point so that one would have $M^2 = M^2(x)$. In $M^8 \rightarrow H$ direction the justification comes from the observation (to be discussed below) that it is possible to uniquely fix the convention assigning CP_2 point to a hyper-quaternionic plane containing varying hyper-complex plane $M^2(x) \subset M^4$.

Number theoretic compactification fixes naturally $M^4 \subset M^8$ so that it applies to any $M^2(x) \subset M^4$. Under this condition the selection is parameterized by an element of $SO(3)/SO(2) = S^2$. Note that M^4 projection of X^4 would be at least 2-dimensional in hyper-quaternionic case. In co-hyper-quaternionic case E^4 projection would be at least 2-D. $SO(2)$ would act as a number theoretic gauge symmetry and the $SO(3)$ valued chiral field would approach to constant at X_l^3 invariant under global $SO(2)$ in the case that one keeps the assumption that M^2 is fixed ad X_l^3 .

- (c) This picture requires a generalization of the map assigning to hyper-quaternionic plane a point of CP_2 so that this map is defined for all possible choices of $M^2 \subset M^4$. Since the $SO(3)$ rotation of the hyper-quaternionic unit defining M^2 rotates different choices parameterized by S^2 to each other, a natural assumption is that the hyper-quaternionic planes related by $SO(3)$ rotation correspond to the same point of CP_2 . Denoting by M^2 the standard representative of M^2 , this means that for the map $M^8 \rightarrow H$ one must perform $SO(3)$ rotation of hyper-quaternionic plane taking $M^2(x)$ to M^2 and map the rotated plane to CP_2 point. In $M^8 \rightarrow H$ case one must first map the point of CP_2 to hyper-quaternionic plane and rotate this plane by a rotation taking $M^2(x)$ to M^2 .
- (d) In this framework local M^2 can vary also at the surfaces X_l^3 , which considerably relaxes the boundary conditions at wormhole throats and light-like boundaries and allows much more general variety of light-like 3-surfaces since the basic requirement is that M^4 projection is at least 1-dimensional. The physical interpretation would be that a local choice of the plane of non-physical polarizations is possible everywhere in $X^4(X_l^3)$. This does not seem to be in any obvious conflict with physical intuition.

These observation provide support for the conjecture that (classical) $S^2 = SO(3)/SO(2)$ conformal field theory might be relevant for (classical) TGD.

- (a) General coordinate invariance suggests that the theory should allow a formulation using any light-like 3-surface X^3 inside $X^4(X_l^3)$ besides X_l^3 identified as union of wormhole throats and boundary components. For these surfaces the element $g(x) \in SO(3)$ would vary also at partonic 2-surfaces X^2 defined as intersections of $\delta CD \times CP_2$ and X^3 (here CD denotes causal diamond defined as intersection of future and past directed light-cones). Hence one could have $S^2 = SO(3)/SO(2)$ conformal field theory at X^2 (regarded as quantum fluctuating so that also $g(x)$ varies) generalizing to WZW model for light-like surfaces X^3 .

- (b) The presence of E^4 factor would extend this theory to a classical $E^4 \times S^2$ WZW model bringing in mind string model with 6-D Euclidian target space extended to a model of light-like 3-surfaces. A further extension to X^4 would be needed to integrate the WZW models associated with 3-surfaces to a full 4-D description. General Coordinate Invariance however suggests that X_l^3 description is enough for practical purposes.
- (c) The choices of $M^2(x)$ in the interior of X_l^3 is dictated by dynamics and the first optimistic conjecture is that a classical solution of $SO(3)/SO(2)$ Wess-Zumino-Witten model obtained by coupling $SO(3)$ valued field to a covariantly constant $SO(2)$ gauge potential characterizes the choice of $M^2(x)$ in the interior of $M^8 \supset X^4(X_l^3) \subset H$ and thus also partially the structure of the preferred extremal. Second optimistic conjecture is that the Kähler action involving also E^4 degrees of freedom allows to assign light-like 3-surface to light-like 3-surface.
- (d) The best that one can hope is that $M^8 - H$ duality could allow to transform the extremely non-linear classical dynamics of TGD to a generalization of WZW-type model. The basic problem is to understand how to characterize the dynamics of CP_2 projection at each point.

In H picture there are two basic types of vacuum extremals: CP_2 type extremals representing elementary particles and vacuum extremals having CP_2 projection which is at most 2-dimensional Lagrange manifold and representing say hadron. Vacuum extremals can appear only as limiting cases of preferred extremals which are non-vacuum extremals. Since vacuum extremals have so decisive role in TGD, it is natural to require that this notion makes sense also in M^8 picture. In particular, the notion of vacuum extremal makes sense in M^8 .

This requires that Kähler form exist in M^8 . E^4 indeed allows full S^2 of covariantly constant Kähler forms representing quaternionic imaginary units so that one can identify Kähler form and construct Kähler action. The obvious conjecture is that hyper-quaternionic space-time surface is extremal of this Kähler action and that the values of Kähler actions in M^8 and H are identical. The elegant manner to achieve this, as well as the mapping of vacuum extremals to vacuum extremals and the mapping of light-like 3-surfaces to light-like 3-surfaces is to assume that $M^8 - H$ duality is Kähler isometry so that induced Kähler forms are identical.

This picture contains many speculative elements and some words of warning are in order.

- (a) Light-likeness conjecture would boil down to the hypothesis that $M^8 - H$ correspondence is Kähler isometry so that the metric and Kähler form of X^4 induced from M^8 and H would be identical. This would guarantee also that Kähler actions for the preferred extremal are identical. This conjecture is beautiful but strong.
- (b) The slicing of $X^4(X_l^3)$ by light-like 3-surfaces is very strong condition on the classical dynamics of Kähler action and does not make sense for pieces of CP_2 type vacuum extremals.

Minkowskian-Euclidian \leftrightarrow associative-co-associative

The 8-dimensionality of M^8 allows to consider both associativity (hyper-quaternionicity) of the tangent space and associativity of the normal space- let us call this co-associativity of tangent space- as alternative options. Both options are needed as has been already found. Since space-time surface decomposes into regions whose induced metric possesses either Minkowskian or Euclidian signature, there is a strong temptation to propose that Minkowskian regions correspond to associative and Euclidian regions to co-associative regions so that space-time itself would provide both the description and its dual.

The proposed interpretation of conjectured associative-co-associative duality relates in an interesting manner to p-adic length scale hypothesis selecting the primes $p \simeq 2^k$, k positive integer as preferred p-adic length scales. $L_p \propto \sqrt{p}$ corresponds to the p-adic length scale defining the size of the space-time sheet at which elementary particle represented as CP_2 type extremal is topologically condensed and is of order Compton length. $L_k \propto \sqrt{k}$ represents the p-adic length scale of the wormhole contacts associated with the CP_2 type extremal and CP_2 size is the natural length unit now. Obviously the quantitative formulation for associative-co-associative duality would be in terms $p \rightarrow k$ duality.

Are the known extremals of Kähler action consistent with the strong form of $M^8 - H$ duality

It is interesting to check whether the known extremals of Kähler action [K11] are consistent with strong form of $M^8 - H$ duality assuming that M^2 or its light-like ray is contained in $T(X^4)$ or normal space.

- (a) CP_2 type vacuum extremals correspond cannot be hyper-quaternionic surfaces but co-hyper-quaternionicity is natural for them. In the same manner canonically imbedded M^4 can be only hyper-quaternionic.
- (b) String like objects are associative since tangent space obviously contains $M^2(x)$. Objects of form $M^1 \times X^3 \subset M^4 \times CP_2$ do not have M^2 either in their tangent space or normal space in H . So that the map from $H \rightarrow M^8$ is not well defined. There are no known extremals of Kähler action of this type. The replacement of M^1 random light-like curve however gives vacuum extremal with vanishing volume, which need not mean physical triviality since fundamental objects of the theory are light-like 3-surfaces.
- (c) For canonically imbedded CP_2 the assignment of $M^2(x)$ to normal space is possible but the choice of $M^2(x) \subset N(CP_2)$ is completely arbitrary. For a generic CP_2 type vacuum extremals M^4 projection is a random light-like curve in $M^4 = M^1 \times E^3$ and $M^2(x)$ can be defined uniquely by the normal vector $n \in E^3$ for the local plane defined by the tangent vector dx^μ/dt and acceleration vector d^2x^μ/dt^2 assignable to the orbit.
- (d) Consider next massless extremals. Let us fix the coordinates of X^4 as $(t, z, x, y) = (m^0, m^2, m^1, m^2)$. For simplest massless extremals CP_2 coordinates are arbitrary functions of variables $u = k \cdot m = t - z$ and $v = \epsilon \cdot m = x$, where $k = (1, 1, 0, 0)$ is light-like vector of M^4 and $\epsilon = (0, 0, 1, 0)$ a polarization vector orthogonal to it. Obviously, the extremals defines a decomposition $M^4 = M^2 \times E^2$. Tangent space is spanned by the four H -vectors $\nabla_\alpha h^k$ with M^4 part given by $\nabla_\alpha m^k = \delta_\alpha^k$ and CP_2 part by $\nabla_\alpha s^k = \partial_u s^k k_\alpha + \partial_v s^k \epsilon_\alpha$.
The normal space cannot contain M^4 vectors since the M^4 projection of the extremal is M^4 . To realize hyper-quaternionic representation one should be able to from these vector two vectors of M^2 , which means linear combinations of tangent vectors for which CP_2 part vanishes. The vector $\partial_t h^k - \partial_z h^k$ has vanishing CP_2 part and corresponds to M^4 vector $(1, -1, 0, 0)$ fix assigns to each point the plane M^2 . To obtain M^2 one would need $(1, 1, 0, 0)$ too but this is not possible. The vector $\partial_y h^k$ is M^4 vector orthogonal to ϵ but M^2 would require also $(1, 0, 0, 0)$. The proposed generalization of massless extremals allows the light-like line M_\pm to depend on point of M^4 [K11], and leads to the introduction of Hamilton-Jacobi coordinates involving a local decomposition of M^4 to $M^2(x)$ and its orthogonal complement with light-like coordinate lines having interpretation as curved light rays. $M^2(x) \subset T(X^4)$ assumption fails fails also for vacuum extremals of form $X^1 \times X^3 \subset M^4 \times CP_2$, where X^1 is light-like random curve. In the latter case, vacuum property follows from the vanishing of the determinant of the induced metric.
- (e) The deformations of string like objects to magnetic flux quanta are basic conjectural extremals of Kähler action and the proposed picture supports this conjecture. In hyper-quaternionic case the assumption that local 4-D plane of X^3 defined by modified gamma matrices contains $M^2(x)$ but that $T(X^3)$ does not contain it, is very strong. It states that $T(X^4)$ at each point can be regarded as a product $M^2(x) \times T^2$, $T^2 \subset T(CP_2)$, so that hyper-quaternionic X^4 would be a collection of Cartesian products of infinitesimal 2-D planes $M^2(x) \subset M^4$ and $T^2(x) \subset CP_2$. The extremals in question could be seen as local variants of string like objects $X^2 \times Y^2 \subset M^4 \times CP_2$, where X^2 is minimal surface and Y^2 holomorphic surface of CP_2 . One can say that X^2 is replaced by a collection of infinitesimal pieces of $M^2(x)$ and Y^2 with similar pieces of homologically non-trivial geodesic sphere $S^2(x)$ of CP_2 , and the Cartesian products of these pieces are glued together to form a continuous surface defining an extremal of Kähler action. Field equations would pose conditions on how $M^2(x)$ and $S^2(x)$ can depend on x . This description applies to magnetic flux quanta, which are the most important must-be extremals of Kähler action.

Geometric interpretation of strong $M^8 - H$ duality

In the proposed framework $M^8 - H$ duality would have a purely geometric meaning and there would be nothing magical in it.

- (a) $X^4(X_l^3) \subset H$ could be seen as a curve representing the orbit of a light-like 3-surface defining a 4-D surface. The question is how to determine the notion of tangent vector for the orbit of X_l^3 . Intuitively the tangent vector is a one-dimensional arrow tangential to the curve at point X_l^3 . The identification of the hyper-quaternionic surface $X^4(X_l^3) \subset M^8$ as a tangent vector conforms with this intuition.
- (b) One could argue that M^8 representation of space-time surface is a kind of chart of the real space-time surface obtained by replacing a real curve by its tangent line. If so, one cannot avoid the question under which conditions this kind of chart is faithful. An alternative interpretation is that a representation making possible to realize number theoretical universality is in question.
- (c) An interesting question is whether $X^4(X_l^3)$ as an orbit of a light-like 3-surface is analogous to a geodesic line -possibly light-like- so that its tangent vector would be parallel translated in the sense that $X^4(X^3)$ for any light-like surface at the orbit is the same as $X^4(X_l^3)$. This would give justification for the possibility to interpret space-time surfaces as a geodesic of configuration space: this is one of the first -and practically forgotten- speculations inspired by the construction of configuration space geometry. The light-likeness of the geodesic could correspond at the level of X^4 to the possibility to decompose the tangent space to a direct sum of two light-like spaces and a 2-D transversal space producing the foliation of X^4 to light-like 3-surfaces X_l^3 along light-like curves.
- (d) $M^8 - H$ duality would assign to X_l^3 a classical orbit and its tangent vector at X_l^3 as a generalization of a Bohr orbit. This picture differs from the wave-particle duality of wave mechanics stating that once the position of a particle is known its momentum is completely unknown. The outcome is however the same: for X_l^3 corresponding to wormhole throats and light-like boundaries of X^4 , canonical momentum densities in the normal direction vanish identically by conservation laws and one can say that the analog of (q, p) phase space as the space carrying wave functions is replaced with the analog of a subspace consisting of points $(q, 0)$. The dual description in M^8 would not be analogous to wave functions in momentum space but to those in the space of unique tangents of curves at their initial points.

The Kähler and spinor structures of M^8

If one introduces M^8 as dual to H , one cannot avoid the idea that hyper-quaternionic surfaces obtained as images of the preferred extremals of Kähler action in H are also extremals of M^8 Kähler action with the same value of Kähler action. As found, this leads to the conclusion that the $M^8 - H$ duality is Kähler isometry. Coupling of spinors to Kähler potential is the next step and this in turn leads to the introduction of spinor structure so that quantum TGD in H should have full M^8 dual.

There are strong physical constraints on M^8 dual and they could kill the hypothesis. The basic constraint to the spinor structure of M^8 is that it reproduces basic facts about electro-weak interactions. This includes neutral electro-weak couplings to quarks and leptons identified as different H -chiralities and parity breaking.

- (a) By the flatness of the metric of E^4 its spinor connection is trivial. E^4 however allows full S^2 of covariantly constant Kähler forms so that one can accommodate free independent Abelian gauge fields assuming that the independent gauge fields are orthogonal to each other when interpreted as realizations of quaternionic imaginary units.
- (b) One should be able to distinguish between quarks and leptons also in M^8 , which suggests that one introduce spinor structure and Kähler structure in E^4 . The Kähler structure of E^4 is unique apart from $SO(3)$ rotation since all three quaternionic imaginary units and the

unit vectors formed from them allow a representation as an antisymmetric tensor. Hence one must select one preferred Kähler structure, that is fix a point of S^2 representing the selected imaginary unit. It is natural to assume different couplings of the Kähler gauge potential to spinor chiralities representing quarks and leptons: these couplings can be assumed to be same as in case of H .

- (c) Electro-weak gauge potential has vectorial and axial parts. Em part is vectorial involving coupling to Kähler form and Z^0 contains both axial and vector parts. The free Kähler forms could thus allow to produce M^8 counterparts of these gauge potentials possessing same couplings as their H counterparts. This picture would produce parity breaking in M^8 picture correctly.
- (d) Only the charged parts of classical electro-weak gauge fields would be absent. This would conform with the standard thinking that charged classical fields are not important. The predicted classical W fields is one of the basic distinctions between TGD and standard model and in this framework. A further prediction is that this distinction becomes visible only in situations, where H picture is necessary. This is the case at high energies, where the description of quarks in terms of $SU(3)$ color is convenient whereas $SO(4)$ QCD would require large number of E^4 partial waves. At low energies large number of $SU(3)$ color partial waves are needed and the convenient description would be in terms of $SO(4)$ QCD. Proton spin crisis might relate to this.
- (e) Also super-symmetries of quantum TGD crucial for the construction of configuration space geometry force this picture. In the absence of coupling to Kähler gauge potential all constant spinor fields and their conjugates would generate super-symmetries so that M^8 would allow $N = 8$ super-symmetry. The introduction of the coupling to Kähler gauge potential in turn means that all covariantly constant spinor fields are lost. Only the representation of all three neutral parts of electro-weak gauge potentials in terms of three independent Kähler gauge potentials allows right-handed neutrino as the only super-symmetry generator as in the case of H .
- (f) The $SO(3)$ element characterizing $M^2(x)$ is fixed apart from a local $SO(2)$ transformation, which suggests an additional $U(1)$ gauge field associated with $SO(2)$ gauge invariance and representable as Kähler form corresponding to a quaternionic unit of E^4 . A possible identification of this gauge field would be as a part of electro-weak gauge field.

M^8 dual of configuration space geometry and spinor structure?

If one introduces M^8 spinor structure and preferred extremals of M^8 Kähler action, one cannot avoid the question whether it is possible or useful to formulate the notion of configuration space geometry and spinor structure for light-like 3-surfaces in M^8 using the exponent of Kähler action as vacuum functional.

- (a) The isometries of the configuration space in M^8 and H formulations would correspond to symplectic transformation of $\delta M_{\pm}^4 \times E^4$ and $\delta M_{\pm}^4 \times CP_2$ and the Hamiltonians involved would belong to the representations of $SO(4)$ and $SU(3)$ with 2-dimensional Cartan subalgebras. In H picture color group would be the familiar $SU(3)$ but in M^8 picture it would be $SO(4)$. Color confinement in both $SU(3)$ and $SO(4)$ sense could allow these two pictures without any inconsistency.
- (b) For $M^4 \times CP_2$ the two spin states of covariantly constant right handed neutrino and antineutrino spinors generate super-symmetries. This super-symmetry plays an important role in the proposed construction of configuration space geometry. As found, this symmetry would be present also in M^8 formulation so that the construction of M^8 geometry should reduce more or less to the replacement of CP_2 Hamiltonians in representations of $SU(3)$ with E^4 Hamiltonians in representations of $SO(4)$. These Hamiltonians can be taken to be proportional to functions of E^4 radius which is $SO(4)$ invariant and these functions bring in additional degree of freedom.
- (c) The construction of Dirac determinant identified as a vacuum functional can be done also in M^8 picture and the conjecture is that the result is same as in the case of H . In this

framework the construction is much simpler due to the flatness of E^4 . In particular, the generalized eigen modes of the Dirac operator $D_K(Y_l^3)$ restricted to the X_l^3 correspond to a situation in which one has fermion in induced Maxwell field mimicking the neutral part of electro-weak gauge field in H as far as couplings are considered. Induced Kähler field would be same as in H . Eigen modes are localized to regions inside which the Kähler magnetic field is non-vanishing and apart from the fact that the metric is the effective metric defined in terms of canonical momentum densities via the formula $\hat{\Gamma}^\alpha = \partial L_K / \partial h_\alpha^k \Gamma_k$ for effective gamma matrices. This in fact, forces the localization of modes implying that their number is finite so that Dirac determinant is a product over finite number eigenvalues. It is clear that M^8 picture could dramatically simplify the construction of configuration space geometry.

- (d) The eigenvalue spectra of the transversal parts of D_K operators in M^8 and H should be identical. This motivates the question whether it is possible to achieve a complete correspondence between H and M^8 pictures also at the level of spinor fields at X^3 by performing a gauge transformation eliminating the classical W gauge boson field altogether at X_l^3 and whether this allows to transform the modified Dirac equation in H to that in M^8 when restricted to X_l^3 . That something like this might be achieved is supported by the fact that in Coulombic gauge the component of gauge potential in the light-like direction vanishes so that the situation is effectively 2-dimensional and holonomy group is Abelian.

Why $M^8 - H$ duality is useful?

Skeptic could of course argue that $M^8 - H$ duality produces only an inflation of unproven conjectures. There are however strong reasons for $M^8 - H$ duality: both theoretical and physical.

- (a) The map of $X_l^3 \subset H \rightarrow X_l^3 \subset M^8$ and corresponding map of space-time surfaces would allow to realize number theoretical universality. $M^8 = M^4 \times E^4$ allows linear coordinates as natural coordinates in which one can say what it means that the point of imbedding space is rational/algebraic. The point of $X^4 \subset H$ is algebraic if it is mapped to an algebraic point of M^8 in number theoretic compactification. This of course restricts the symmetry groups to their rational/algebraic variants but this does not have practical meaning. Number theoretical compactification could in fact be motivated by the number theoretical universality.
- (b) $M^8 - H$ duality could provide much simpler description of preferred extremals of Kähler action since the Kähler form in E^4 has constant components. If the spinor connection in E^4 is combination of the three Kähler forms mimicking neutral part of electro-weak gauge potential, the eigenvalue spectrum for the modified Dirac operator would correspond to that for a fermion in $U(1)$ magnetic field defined by an Abelian magnetic field whereas in $M^4 \times CP_2$ picture $U(2)_{ew}$ magnetic fields would be present.
- (c) $M^8 - H$ duality provides insights to low energy hadron physics. M^8 description might work when H -description fails. For instance, perturbative QCD which corresponds to H -description fails at low energies whereas M^8 description might become perturbative description at this limit. Strong $SO(4) = SU(2)_L \times SU(2)_R$ invariance is the basic symmetry of the phenomenological low energy hadron models based on conserved vector current hypothesis (CVC) and partially conserved axial current hypothesis (PCAC). Strong $SO(4) = SU(2)_L \times SU(2)_R$ relates closely also to electro-weak gauge group $SU(2)_L \times U(1)$ and this connection is not well understood in QCD description. $M^8 - H$ duality could provide this connection. Strong $SO(4)$ symmetry would emerge as a low energy dual of the color symmetry. Orbital $SO(4)$ would correspond to strong $SU(2)_L \times SU(2)_R$ and by flatness of E^4 spin like $SO(4)$ would correspond to electro-weak group $SU(2)_L \times U(1)_R \subset SO(4)$. Note that the inclusion of coupling to Kähler gauge potential is necessary to achieve respectable spinor structure in CP_2 . One could say that the orbital angular momentum in $SO(4)$ corresponds to strong isospin and spin part of angular momentum to the weak isospin.

4.5.5 $M^8 - H$ duality and low energy hadron physics

The description of $M^8 - H$ at the configuration space level can be applied to gain a view about color confinement and its dual for electro-weak interactions at short distance limit. The basic idea is that $SO(4)$ and $SU(3)$ provide provide dual descriptions of quark color using E^4 and CP_2 partial waves and low energy hadron physics corresponds to a situation in which M^8 picture provides the perturbative approach whereas H picture works at high energies. The basic prediction is that $SO(4)$ should appear as dynamical symmetry group of low energy hadron physics and this is indeed the case.

Consider color confinement at the long length scale limit in terms of $M^8 - H$ duality.

- (a) At high energy limit only lowest color triplet color partial waves for quarks dominate so that QCD description becomes appropriate whereas very higher color partial waves for quarks and gluons are expected to appear at the confinement limit. Since configuration space degrees of freedom begin to dominate, color confinement limit transcends the descriptive power of QCD.
- (b) The success of $SO(4)$ sigma model in the description of low lying hadrons would directly relate to the fact that this group labels also the E^4 Hamiltonians in M^8 picture. Strong $SO(4)$ quantum numbers can be identified as orbital counterparts of right and left handed electro-weak isospin coinciding with strong isospin for lowest quarks. In sigma model pion and sigma boson form the components of E^4 valued vector field or equivalently collection of four E^4 Hamiltonians corresponding to spherical E^4 coordinates. Pion corresponds to S^3 valued unit vector field with charge states of pion identifiable as three Hamiltonians defined by the coordinate components. Sigma is mapped to the Hamiltonian defined by the E^4 radial coordinate. Excited mesons corresponding to more complex Hamiltonians are predicted.
- (c) The generalization of sigma model would assign to quarks E^4 partial waves belonging to the representations of $SO(4)$. The model would involve also 6 $SO(4)$ gluons and their $SO(4)$ partial waves. At the low energy limit only lowest representations would be important whereas at higher energies higher partial waves would be excited and the description based on CP_2 partial waves would become more appropriate.
- (d) The low energy quark model would rely on quarks moving $SO(4)$ color partial waves. Left *resp.* right handed quarks could correspond to $SU(2)_L$ *resp.* $SU(2)_R$ triplets so that spin statistics problem would be solved in the same manner as in the standard quark model.
- (e) Family replication phenomenon is described in TGD framework the same manner in both cases so that quantum numbers like strangeness and charm are not fundamental. Indeed, p-adic mass calculations allowing fractally scaled up versions of various quarks allow to replace Gell-Mann mass formula with highly successful predictions for hadron masses [K56]

To my opinion these observations are intriguing enough to motivate a concrete attempt to construct low energy hadron physics in terms of $SO(4)$ gauge theory.

4.5.6 The notion of number theoretical braid

Braids -not necessary number theoretical- provide a realization discretization as a space-time correlate for the finite measurement resolution. The notion of braid was inspired by the idea about quantum TGD as almost topological quantum field theory. Although the original form of this idea has been buried, the notion of braid has survived: in the decomposition of space-time sheets to string world sheets, the ends of strings define representatives for braid strands at light-like 3-surfaces.

The notion of number theoretic universality inspired the much more restrictive notion of number theoretic braid requiring that the points in the intersection of the braid with the partonic 2-surface correspond to rational or at most algebraic points of H in preferred coordinates fixed by symmetry considerations. The challenge has been to find a unique identification of the number

theoretic braid or at least of the end points of the braid. The following consideration suggest that the number theoretic braids are not a useful notion in the generic case but make sense and are needed in the intersection of real and p-adic worlds which is in crucial role in TGD based vision about living matter [K51] .

It is only the braiding that matters in topological quantum field theories used to classify braids. Hence braid should require only the fixing of the end points of the braids at the intersection of the braid at the light-like boundaries of CDs and the braiding equivalence class of the braid itself. Therefore it is enough is to specify the topology of the braid and the end points of the braid in accordance with the attribute "number theoretic". Of course, the condition that all points of the strand of the number theoretic braid are algebraic is impossible to satisfy.

The situation in which the equations defining X^2 make sense both in real sense and p-adic sense using appropriate algebraic extension of p-adic number field is central in the TGD based vision about living matter [K51] . The reason is that in this case the notion of number entanglement theoretic entropy having negative values makes sense and entanglement becomes information carrying. This motivates the identification of life as something in the intersection of real and p-adic worlds. In this situation the identification of the ends of the number theoretic braid as points belonging to the intersection of real and p-adic worlds is natural. These points -call them briefly algebraic points- belong to the algebraic extension of rationals needed to define the algebraic extension of p-adic numbers. This definition however makes sense also when the equations defining the partonic 2-surfaces fail to make sense in both real and p-adic sense. In the generic case the set of points satisfying the conditions is discrete. For instance, according to Fermat's theorem the set of rational points satisfying $X^n + Y^n = Z^n$ reduces to the point $(0, 0, 0)$ for $n = 3, 4, \dots$. Hence the constraint might be quite enough in the intersection of real and p-adic worlds where the choice of the algebraic extension is unique.

One can however criticize this proposal.

- (a) One must fix the the number of points of the braid and outside the intersection and the non-uniqueness of the algebraic extension makes the situation problematic. Physical intuition suggests that the points of braid define carriers of quantum numbers assignable to second quantized induced spinor fields so that the total number of fermions antifermions would define the number of braids. In the intersection the highly non-trivial implication is that this number cannot exceed the number of algebraic points.
- (b) In the generic case one expects that even the smallest deformation of the partonic 2-surface can change the number of algebraic points and also the character of the algebraic extension of rational numbers needed. The restriction to rational points is not expected to help in the generic case. If the notion of number theoretical braid is meant to be practical, must be able to decompose WCW to open sets inside which the numbers of algebraic points of braid at its ends are constant. For real topology this is expected to be impossible and it does not make sense to use p-adic topology for WCW whose points do not allow interpretation as p-adic partonic surfaces.
- (c) In the intersection of real and p-adic worlds which corresponds to a discrete subset of WCW, the situation is different. Since the coefficients of polynomials involved with the definition of the partonic 2-surface must be rational or at most algebraic, continuous deformations are not possible so that one avoids the problem.
- (d) This forces to ask the reason why for the number theoretic braids. In the generic case they seem to produce only troubles. In the intersection of real and p-adic worlds they could however allow the construction of the elements of M -matrix describing quantum transitions changing p-adic to real surfaces and vice versa as realizations of intentions and generation of cognitions. In this the case it is natural that only the data from the intersection of the two worlds are used. In [K51] I have sketched the idea about number theoretic quantum field theory as a description of intentional action and cognition.

There is also the the problem of fixing the interior points of the braid modulo deformations not affecting the topology of the braid.

- (a) Infinite number of non-equivalent braidings are possible. Should one allow all possible braidings for a fixed light-like 3-surface and say that their existence is what makes the dynamics essentially three-dimensional even in the topological sense? In this case there would be no problems with the condition that the points at both ends of braid are algebraic.
- (b) Or should one try to characterize the braiding uniquely for a given partonic 2-surfaces and corresponding 4-D tangent space distributions? The slicing of the space-time sheet by partonic 2-surfaces and string world sheets suggests that the ends of string world sheets could define the braid strands in the generic context when there is no algebraicity condition involved. This could be taken as a very natural manner to fix the topology of braid but leave the freedom to choose the representative for the braid. In the intersection of real and p-adic worlds there is no good reason for the end points of strands in this case to be algebraic at both ends of the string world sheet. One can however start from the braid defined by the end points of string world sheets, restrict the end points to be algebraic at the end with a smaller number of algebraic points and then perform a topologically non-trivial deformation of the braid so that also the points at the other end are algebraic? Non-trivial deformations need not be possible for all possible choices of algebraic braid points at the other end of braid and different choices of the set of algebraic points would give rise to different braidings. A further constraint is that only the algebraic points at which one has assign fermion or antifermion are used so that the number of braid points is not always maximal.
- (c) One can also ask whether one should perform the gauge fixing for the strands of the number theoretic braid using algebraic functions making sense both in real and p-adic context. This question does not seem terribly relevant since since it is only the topology of the braid that matters.

4.5.7 Connection with string model and Equivalence Principle at space-time level

Coset construction allows to generalize Equivalence Principle and understand it at quantum level. This is however not quite enough: a precise understanding of Equivalence Principle is required also at the classical level. Also the mechanism selecting via stationary phase approximation a preferred extremal of Kähler action providing a correlation between quantum numbers of the particle and geometry of the preferred extremals is still poorly understood.

Is stringy action principle coded by the geometry of preferred extremals?

It seems very difficult to deduce Equivalence Principle as an identity of gravitational and inertial masses identified as Noether charges associated with corresponding action principles. Since string model is an excellent theory of quantum gravitation, one can consider a less direct approach in which one tries to deduce a connection between classical TGD and string model and hope that the bridge from string model to General Relativity is easier to build. Number theoretical compactification gives good hopes that this kind of connection exists.

- (a) Number theoretic compactification implies that the preferred extremals of Kähler action have the property that one can assign to each point of M^4 projection $P_{M^4}(X^4(X_l^3))$ of the preferred extremal $M^2(x)$ identified as the plane of non-physical polarizations and also as the plane in which local massless four-momentum lies.
- (b) If the distribution of the planes $M^2(x)$ is integrable, one can slice $P_{M^4}(X^4(X_l^3))$ to string world-sheets. The intersection of string world sheets with $X^3 \subset \delta M_{\pm}^4 \times CP_2$ corresponds to a light-like curve having tangent in local tangent space $M^2(x)$ at light-cone boundary. This is the first candidate for the definition of number theoretic braid. Second definition assumes M^2 to be fixed at δCD : in this case the slicing is parameterized by the sphere S^2 defined by the light rays of δM_{\pm}^4 .
- (c) One can assign to the string world sheet -call it Y^2 - the standard area action

$$S_G(Y^2) = \int_{Y^2} T \sqrt{g_2} d^2 y , \quad (4.5.1)$$

where g_2 is either the induced metric or only its M^4 part. The latter option looks more natural since M^4 projection is considered. T is string tension.

- (d) The naivest guess would be $T = 1/\hbar G$ apart from some numerical constant but one must be very cautious here since $T = 1/L_p^2$ apart from a numerical constant is also a good candidate if one accepts the basic argument identifying G in terms of p-adic length L_p and Kähler action for two pieces of CP_2 type vacuum extremals representing propagating graviton. The formula reads $G = L_p^2 \exp(-2a S_K(CP_2))$, $a \leq 1$ [K5, K30]. The interaction strength which would be L_p^2 without the presence of CP_2 type vacuum extremals is reduced by the exponential factor coming from the exponent of Kähler function of configuration space.
- (e) One would have string model in either $CD \times CP_2$ or $CD \subset M^4$ with the constraint that stringy world sheet belongs to $X^4(X_i^3)$. For the extremals of $S_G(Y^2)$ gravitational four-momentum defined as Noether charge is conserved. The extremal property of string world sheet need not however be consistent with the preferred extremal property. This constraint might bring in coupling of gravitons to matter. The natural guess is that graviton corresponds to a string connecting wormhole contacts. The strings could also represent formation of gravitational bound states when they connect wormhole contacts separated by a large distance. The energy of the string is roughly $E \sim \hbar T L$ and for $T = 1/\hbar G$ gives $E \sim L/G$. Macroscopic strings are not allowed except as models of black holes. The identification $T \sim 1/L_p^2$ gives $E \sim \hbar L/L_p^2$, which does not favor long strings for large values of \hbar . The identification $G_p = L_p^2/\hbar_0$ gives $T = 1/\hbar G_p$ and $E \sim \hbar_0 L/L_p^2$, which makes sense and allows strings with length not much longer than p-adic length scale. Quantization - that is the presence of configuration space degrees of freedom- would bring in massless gravitons as deformations of string whereas strings would carry the gravitational mass.
- (f) The exponent $\exp(iS_G)$ can appear as a phase factor in the definition of quantum states for preferred extremals. S_G is not however enough. One can assign also to the points of number theoretic braid action describing the interaction of a point like current $Q dx^\mu/ds$ with induced gauge potentials A_μ . The corresponding contribution to the action is

$$S_{braid} = \int_{braid} i Tr(Q \frac{dx^\mu}{ds} A_\mu) dx . \quad (4.5.2)$$

In stationary phase approximation subject to the additional constraint that a preferred extremal of Kähler action is in question one obtains the desired correlation between the geometry of preferred extremal and the quantum numbers of elementary particle. This interaction term carries information only about the charges of elementary particle. It is quite possible that the interaction term is more complex: for instance, it could contain spin dependent terms (Stern-Gerlach experiment).

- (g) The constraint coming from preferred extremal property of Kähler action can be expressed in terms of Lagrange multipliers

$$S_c = \int_{Y^2} \lambda^k D_\alpha (\frac{\partial L_K}{\partial \alpha h^k}) \sqrt{g_2} d^2 y . \quad (4.5.3)$$

- (h) The action exponential reads as

$$\exp(iS_G + S_{braid} + S_c) . \quad (4.5.4)$$

The resulting field equations couple stringy M^4 degrees of freedom to the second variation of Kähler action with respect to M^4 coordinates and involve third derivatives of M^4 coordinates at the right hand side. If the second variation of Kähler action with respect to M^4 coordinates vanishes, free string results. This is trivially the case if a vacuum extremal of Kähler action is in question.

- (i) An interesting question is whether the preferred extremal property boils down to the condition that the second variation of Kähler action with respect to M^4 coordinates or actually all coordinates vanishes so that gravitonic string is free. As a matter of fact, the stronger condition is required that the Noether currents associated with the modified Dirac action are conserved. The physical interpretation would be in terms of quantum criticality which is the basic conjecture about the dynamics of quantum TGD. This is clear from the fact that in 1-D system criticality means that the potential $V(x) = ax + bx^2 + \dots$ has $b = 0$. In field theory criticality corresponds to the vanishing of the term $m^2\phi^2/2$ so that massless situation corresponds to massless theory and criticality and long range correlations. For more than one dynamical variable there is a hierarchy of criticalities corresponding to the gradual reduction of the rank of the matrix of the matrix defined by the second derivatives of $V(x)$ and this gives rise to a classification of criticalities. Maximum criticality would correspond to the total vanishing of this matrix. In infinite-D case this hierarchy is infinite.

What does the equality of gravitational and inertial masses mean?

Consider next the question in what form Equivalence Principle could be realized in this framework.

- (a) Coset construction inspires the conjecture that gravitational and inertial four-momenta are identical. Also some milder form of it would make sense. What is clear is that the construction of preferred extremal involving the distribution of $M^2(x)$ implies that conserved four-momentum associated with Kähler action can be expressed formally as stringy four-momentum. The integral of the conserved inertial momentum current over X^3 indeed reduces to an integral over the curve defining string as one integrates over other two degrees of freedom. It would not be surprising if a stringy expression for four-momentum would result but with string tension depending on the point of string and possibly also on the component of four-momentum. If the dependence of string tension on the point of string and on the choice of the stringy world sheet is slow, the interpretation could be in terms of coupling constant evolution associated with the stringy coordinates. An alternative interpretation is that string tension corresponds to a scalar field. A quite reasonable option is that for given X_i^3 T defines a scalar field and that the observed T corresponds to the average value of T over deformations of X_i^3 .
- (b) The minimum option is that Kähler mass is equal to the sum gravitational masses assignable to strings connecting points of wormhole throat or two different wormhole throats. This hypothesis makes sense even for wormhole contacts having size of order Planck length.
- (c) The condition that gravitational mass equals to the inertial mass (rest energy) assigned to Kähler action is the most obvious condition that one can imagine. The breaking of Poincaré invariance to Lorentz invariance with respect to the tip of CD supports this form of Equivalence Principle. This would predict the value of the ratio of the parameter R^2T and p-adic length scale hypothesis would allow only discrete values for this parameter. $p \simeq 2^k$ following from the quantization of the temporal distance $T(n)$ between the tips of CD as $T(n) = 2^n T_0$ would suggest string tension $T_n = 2^n R^2$ apart from a numerical factor. $G_p \propto 2^n R^2 / \hbar_0$ would emerge as a prediction of the theory. G can be seen either as a prediction or RG invariant input parameter fixed by quantum criticality. The arguments related to p-adic coupling constant evolution suggest $R^2 / \hbar_0 G = 3 \times 2^{23}$ [K5, K30].
- (d) The scalar field property of string tension should be consistent with the vacuum degeneracy of Kähler action. For instance, for the vacuum extremals of Kähler action stringy action is non-vanishing. The simplest possibility is that one includes the integral of the scalar $J^{\mu\nu} J_{\mu\nu}$ over the degrees transversal to M^2 to the stringy action so that string tension vanishes for vacuum extremals. This would be nothing but dimensional reduction of 4-D theory to a 2-D theory using the slicing of $X^4(X_i^3)$ to partonic 2-surfaces and stringy world sheets. For cosmic strings Kähler action reduces to stringy action with string tension $T \propto 1/g_K^2 R^2$ apart from a numerical constant. If one wants consistency with $T \propto 1/L_p^2$, one must have $T \propto 1/g_K^2 2^n R^2$ for the cosmic strings deformed to Kähler magnetic flux tubes. This looks

rather plausible if the thickness of deformed string in M^4 degrees of freedom is given by p-adic length scale.

4.6 Weak form electric-magnetic duality and its implications

The notion of electric-magnetic duality [B11] was proposed first by Olive and Montonen and is central in $\mathcal{N} = 4$ supersymmetric gauge theories. It states that magnetic monopoles and ordinary particles are two different phases of theory and that the description in terms of monopoles can be applied at the limit when the running gauge coupling constant becomes very large and perturbation theory fails to converge. The notion of electric-magnetic self-duality is more natural since for CP_2 geometry Kähler form is self-dual and Kähler magnetic monopoles are also Kähler electric monopoles and Kähler coupling strength is by quantum criticality renormalization group invariant rather than running coupling constant. The notion of electric-magnetic (self-)duality emerged already two decades ago in the attempts to formulate the Kähler geometric of world of classical worlds. Quite recently a considerable step of progress took place in the understanding of this notion [K20]. What seems to be essential is that one adopts a weaker form of the self-duality applying at partonic 2-surfaces. What this means will be discussed in the sequel.

Every new idea must be of course taken with a grain of salt but the good sign is that this concept leads to precise predictions. The point is that elementary particles do not generate monopole fields in macroscopic length scales: at least when one considers visible matter. The first question is whether elementary particles could have vanishing magnetic charges: this turns out to be impossible. The next question is how the screening of the magnetic charges could take place and leads to an identification of the physical particles as string like objects identified as pairs magnetic charged wormhole throats connected by magnetic flux tubes.

- (a) The first implication is a new view about electro-weak massivation reducing it to weak confinement in TGD framework. The second end of the string contains particle having electroweak isospin neutralizing that of elementary fermion and the size scale of the string is electro-weak scale would be in question. Hence the screening of electro-weak force takes place via weak confinement realized in terms of magnetic confinement.
- (b) This picture generalizes to the case of color confinement. Also quarks correspond to pairs of magnetic monopoles but the charges need not vanish now. Rather, valence quarks would be connected by flux tubes of length of order hadron size such that magnetic charges sum up to zero. For instance, for baryonic valence quarks these charges could be $(2, -1, -1)$ and could be proportional to color hyper charge.
- (c) The highly non-trivial prediction making more precise the earlier stringy vision is that elementary particles are string like objects in electro-weak scale: this should become manifest at LHC energies.
- (d) The weak form electric-magnetic duality together with Beltrami flow property of Kähler leads to the reduction of Kähler action to Chern-Simons action so that TGD reduces to almost topological QFT and that Kähler function is explicitly calculable. This has enormous impact concerning practical calculability of the theory.
- (e) One ends up also to a general solution ansatz for field equations from the condition that the theory reduces to almost topological QFT. The solution ansatz is inspired by the idea that all isometry currents are proportional to Kähler current which is integrable in the sense that the flow parameter associated with its flow lines defines a global coordinate. The proposed solution ansatz would describe a hydrodynamical flow with the property that isometry charges are conserved along the flow lines (Beltrami flow). A general ansatz satisfying the integrability conditions is found. The solution ansatz applies also to the extremals of Chern-Simons action and to the conserved currents associated with the modified Dirac equation defined as contractions of the modified gamma matrices between the solutions of the modified Dirac equation. The strongest form of the solution ansatz states that various classical and quantum currents flow along flow lines of the Beltrami flow

defined by Kähler current (Kähler magnetic field associated with Chern-Simons action). Intuitively this picture is attractive. A more general ansatz would allow several Beltrami flows meaning multi-hydrodynamics. The integrability conditions boil down to two scalar functions: the first one satisfies massless d'Alembert equation in the induced metric and the the gradients of the scalar functions are orthogonal. The interpretation in terms of momentum and polarization directions is natural.

- (f) The general solution ansatz works for induced Kähler Dirac equation and Chern-Simons Dirac equation and reduces them to ordinary differential equations along flow lines. The induced spinor fields are simply constant along flow lines of induced spinor field for Dirac equation in suitable gauge. Also the generalized eigen modes of the modified Chern-Simons Dirac operator can be deduced explicitly if the throats and the ends of space-time surface at the boundaries of CD are extremals of Chern-Simons action. Chern-Simons Dirac equation reduces to ordinary differential equations along flow lines and one can deduce the general form of the spectrum and the explicit representation of the Dirac determinant in terms of geometric quantities characterizing the 3-surface (eigenvalues are inversely proportional to the lengths of strands of the flow lines in the effective metric defined by the modified gamma matrices).

4.6.1 Could a weak form of electric-magnetic duality hold true?

Holography means that the initial data at the partonic 2-surfaces should fix the configuration space metric. A weak form of this condition allows only the partonic 2-surfaces defined by the wormhole throats at which the signature of the induced metric changes. A stronger condition allows all partonic 2-surfaces in the slicing of space-time sheet to partonic 2-surfaces and string world sheets. Number theoretical vision suggests that hyper-quaternionicity *resp.* co-hyperquaternionicity constraint could be enough to fix the initial values of time derivatives of the imbedding space coordinates in the space-time regions with Minkowskian *resp.* Euclidian signature of the induced metric. This is a condition on modified gamma matrices and hyper-quaternionicity states that they span a hyper-quaternionic sub-space.

Definition of the weak form of electric-magnetic duality

One can also consider alternative conditions possibly equivalent with this condition. The argument goes as follows.

- (a) The expression of the matrix elements of the metric and Kähler form of WCW in terms of the Kähler fluxes weighted by Hamiltonians of δM_{\pm}^4 at the partonic 2-surface X^2 looks very attractive. These expressions however carry no information about the 4-D tangent space of the partonic 2-surfaces so that the theory would reduce to a genuinely 2-dimensional theory, which cannot hold true. One would like to code to the WCW metric also information about the electric part of the induced Kähler form assignable to the complement of the tangent space of $X^2 \subset X^4$.
- (b) Electric-magnetic duality of the theory looks a highly attractive symmetry. The trivial manner to get electric magnetic duality at the level of the full theory would be via the identification of the flux Hamiltonians as sums of of the magnetic and electric fluxes. The presence of the induced metric is however troublesome since the presence of the induced metric means that the simple transformation properties of flux Hamiltonians under symplectic transformations -in particular color rotations- are lost.
- (c) A less trivial formulation of electric-magnetic duality would be as an initial condition which eliminates the induced metric from the electric flux. In the Euclidian version of 4-D YM theory this duality allows to solve field equations exactly in terms of instantons. This approach involves also quaternions. These arguments suggest that the duality in some form might work. The full electric magnetic duality is certainly too strong and implies that space-time surface at the partonic 2-surface corresponds to piece of CP_2 type vacuum extremal and can hold only in the deep interior of the region with Euclidian signature. In

the region surrounding wormhole throat at both sides the condition must be replaced with a weaker condition.

- (d) To formulate a weaker form of the condition let us introduce coordinates (x^0, x^3, x^1, x^2) such (x^1, x^2) define coordinates for the partonic 2-surface and (x^0, x^3) define coordinates labeling partonic 2-surfaces in the slicing of the space-time surface by partonic 2-surfaces and string world sheets making sense in the regions of space-time sheet with Minkowskian signature. The assumption about the slicing allows to preserve general coordinate invariance. The weakest condition is that the generalized Kähler electric fluxes are apart from constant proportional to Kähler magnetic fluxes. This requires the condition

$$J^{03}\sqrt{g_4} = KJ_{12} . \quad (4.6.1)$$

A more general form of this duality is suggested by the considerations of [K40] reducing the hierarchy of Planck constants to basic quantum TGD and also reducing Kähler function for preferred extremals to Chern-Simons terms [B5] at the boundaries of CD and at light-like wormhole throats. This form is following

$$J^{n\beta}\sqrt{g_4} = K\epsilon \times \epsilon^{n\beta\gamma\delta} J_{\gamma\delta}\sqrt{g_4} . \quad (4.6.2)$$

Here the index n refers to a normal coordinate for the space-like 3-surface at either boundary of CD or for light-like wormhole throat. ϵ is a sign factor which is opposite for the two ends of CD . It could be also opposite of opposite at the opposite sides of the wormhole throat. Note that the dependence on induced metric disappears at the right hand side and this condition eliminates the potentials singularity due to the reduction of the rank of the induced metric at wormhole throat.

- (e) Information about the tangent space of the space-time surface can be coded to the configuration space metric with loosing the nice transformation properties of the magnetic flux Hamiltonians if Kähler electric fluxes or sum of magnetic flux and electric flux satisfying this condition are used and K is symplectic invariant. Using the sum

$$J_e + J_m = (1 + K)J , \quad (4.6.3)$$

where J can denotes the Kähler magnetic flux, makes it possible to have a non-trivial configuration space metric even for $K = 0$, which could correspond to the ends of a cosmic string like solution carrying only Kähler magnetic fields. This condition suggests that it can depend only on Kähler magnetic flux and other symplectic invariants. Whether local symplectic coordinate invariants are possible at all is far from obvious, If the slicing itself is symplectic invariant then K could be a non-constant function of X^2 depending on string world sheet coordinates. The light-like radial coordinate of the light-cone boundary indeed defines a symplectically invariant slicing and this slicing could be shifted along the time axis defined by the tips of CD .

Electric-magnetic duality physically

What could the weak duality condition mean physically? For instance, what constraints are obtained if one assumes that the quantization of electro-weak charges reduces to this condition at classical level?

- (a) The first thing to notice is that the flux of J over the partonic 2-surface is analogous to magnetic flux

$$Q_m = \frac{e}{\hbar} \oint B dS = n .$$

n is non-vanishing only if the surface is homologically non-trivial and gives the homology charge of the partonic 2-surface.

- (b) The expressions of classical electromagnetic and Z^0 fields in terms of Kähler form [L1] , [L1] read as

$$\begin{aligned}\gamma &= \frac{eF_{em}}{\hbar} = 3J - \sin^2(\theta_W)R_{03} \ , \\ Z^0 &= \frac{g_Z F_Z}{\hbar} = 2R_{03} \ .\end{aligned}\tag{4.6.4}$$

Here R_{03} is one of the components of the curvature tensor in vielbein representation and F_{em} and F_Z correspond to the standard field tensors. From this expression one can deduce

$$J = \frac{e}{3\hbar}F_{em} + \sin^2(\theta_W)\frac{g_Z}{6\hbar}F_Z \ .\tag{4.6.5}$$

- (c) The weak duality condition when integrated over X^2 implies

$$\begin{aligned}\frac{e^2}{3\hbar}Q_{em} + \frac{g_Z^2 p}{6}Q_{Z,V} &= K \oint J = Kn \ , \\ Q_{Z,V} &= \frac{I_V^3}{2} - Q_{em} \ , \quad p = \sin^2(\theta_W) \ .\end{aligned}\tag{4.6.6}$$

Here the vectorial part of the Z^0 charge rather than as full Z^0 charge $Q_Z = I_L^3 + \sin^2(\theta_W)Q_{em}$ appears. The reason is that only the vectorial isospin is same for left and right handed components of fermion which are in general mixed for the massive states.

The coefficients are dimensionless and expressible in terms of the gauge coupling strengths and using $\hbar = r\hbar_0$ one can write

$$\begin{aligned}\alpha_{em}Q_{em} + p\frac{\alpha_Z}{2}Q_{Z,V} &= \frac{3}{4\pi} \times rnK \ , \\ \alpha_{em} &= \frac{e^2}{4\pi\hbar_0} \ , \quad \alpha_Z = \frac{g_Z^2}{4\pi\hbar_0} = \frac{\alpha_{em}}{p(1-p)} \ .\end{aligned}\tag{4.6.7}$$

- (d) There is a great temptation to assume that the values of Q_{em} and Q_Z correspond to their quantized values and therefore depend on the quantum state assigned to the partonic 2-surface. The linear coupling of the modified Dirac operator to conserved charges implies correlation between the geometry of space-time sheet and quantum numbers assigned to the partonic 2-surface. The assumption of standard quantized values for Q_{em} and Q_Z would be also seen as the identification of the fine structure constants α_{em} and α_Z . This however requires weak isospin invariance.

The value of K from classical quantization of Kähler electric charge

The value of K can be deduced by requiring classical quantization of Kähler electric charge.

- (a) The condition that the flux of $F^{03} = (\hbar/g_K)J^{03}$ defining the counterpart of Kähler electric field equals to the Kähler charge g_K would give the condition $K = g_K^2/\hbar$, where g_K is Kähler coupling constant which should invariant under coupling constant evolution by quantum criticality. Within experimental uncertainties one has $\alpha_K = g_K^2/4\pi\hbar_0 = \alpha_{em} \simeq 1/137$, where α_{em} is finite structure constant in electron length scale and \hbar_0 is the standard value of Planck constant.
- (b) The quantization of Planck constants makes the condition highly non-trivial. The most general quantization of r is as rationals but there are good arguments favoring the quantization as integers corresponding to the allowance of only singular coverings of CD and CP_2 . The point is that in this case a given value of Planck constant corresponds to a finite number pages of the "Big Book". The quantization of the Planck constant implies a further

quantization of K and would suggest that K scales as $1/r$ unless the spectrum of values of Q_{em} and Q_Z allowed by the quantization condition scales as r . This is quite possible and the interpretation would be that each of the r sheets of the covering carries (possibly same) elementary charge. Kind of discrete variant of a full Fermi sphere would be in question. The interpretation in terms of anyonic phases [K63] supports this interpretation.

- (c) The identification of J as a counterpart of eB/\hbar means that Kähler action and thus also Kähler function is proportional to $1/\alpha_K$ and therefore to \hbar . This implies that for large values of \hbar Kähler coupling strength $g_K^2/4\pi$ becomes very small and large fluctuations are suppressed in the functional integral. The basic motivation for introducing the hierarchy of Planck constants was indeed that the scaling $\alpha \rightarrow \alpha/r$ allows to achieve the convergence of perturbation theory: Nature itself would solve the problems of the theoretician. This of course does not mean that the physical states would remain as such and the replacement of single particles with anyonic states in order to satisfy the condition for K would realize this concretely.
- (d) The condition $K = g_K^2/\hbar$ implies that the Kähler magnetic charge is always accompanied by Kähler electric charge. A more general condition would read as

$$K = n \times \frac{g_K^2}{\hbar}, n \in Z . \quad (4.6.8)$$

This would apply in the case of cosmic strings and would allow vanishing Kähler charge possible when the partonic 2-surface has opposite fermion and antifermion numbers (for both leptons and quarks) so that Kähler electric charge should vanish. For instance, for neutrinos the vanishing of electric charge strongly suggests $n = 0$ besides the condition that abelian Z^0 flux contributing to em charge vanishes.

It took a year to realize that this value of K is natural at the Minkowskian side of the wormhole throat. At the Euclidian side much more natural condition is

$$K = \frac{1}{\hbar c} . \quad (4.6.9)$$

In fact, the self-duality of CP_2 Kähler form favours this boundary condition at the Euclidian side of the wormhole throat. Also the fact that one cannot distinguish between electric and magnetic charges in Euclidian region since all charges are magnetic can be used to argue in favor of this form. The same constraint arises from the condition that the action for CP_2 type vacuum extremal has the value required by the argument leading to a prediction for gravitational constant in terms of the square of CP_2 radius and α_K the effective replacement $g_K^2 \rightarrow 1$ would spoil the argument.

The boundary condition $J_E = J_B$ for the electric and magnetic parts of Kähler form at the Euclidian side of the wormhole throat inspires the question whether all Euclidian regions could be self-dual so that the density of Kähler action would be just the instanton density. Self-duality follows if the deformation of the metric induced by the deformation of the canonically imbedded CP_2 is such that in CP_2 coordinates for the Euclidian region the tensor $(g^{\alpha\beta}g^{\mu\nu} - g^{\alpha\nu}g^{\mu\beta})/\sqrt{g}$ remains invariant. This is certainly the case for CP_2 type vacuum extremals since by the light-likeness of M^4 projection the metric remains invariant. Also conformal scalings of the induced metric would satisfy this condition. Conformal scaling is not consistent with the degeneracy of the 4-metric at the wormhole throat. Full self-duality is indeed an un-necessarily strong condition.

Reduction of the quantization of Kähler electric charge to that of electromagnetic charge

The best manner to learn more is to challenge the form of the weak electric-magnetic duality based on the induced Kähler form.

- (a) Physically it would seem more sensible to pose the duality on electromagnetic charge rather than Kähler charge. This would replace induced Kähler form with electromagnetic field, which is a linear combination of induced Kähler field and classical Z^0 field

$$\begin{aligned}\gamma &= 3J - \sin^2\theta_W R_{03} \ , \\ Z^0 &= 2R_{03} \ .\end{aligned}\tag{4.6.10}$$

Here $Z_0 = 2R_{03}$ is the appropriate component of CP_2 curvature form [L1]. For a vanishing Weinberg angle the condition reduces to that for Kähler form.

- (b) For the Euclidian space-time regions having interpretation as lines of generalized Feynman diagrams Weinberg angle should be non-vanishing. In Minkowskian regions Weinberg angle could however vanish. If so, the condition guaranteeing that electromagnetic charge of the partonic 2-surfaces equals to the above condition stating that the em charge assignable to the fermion content of the partonic 2-surfaces reduces to the classical Kähler electric flux at the Minkowskian side of the wormhole throat. One can argue that Weinberg angle must increase smoothly from a vanishing value at both sides of wormhole throat to its value in the deep interior of the Euclidian region.
- (c) The vanishing of the Weinberg angle in Minkowskian regions conforms with the physical intuition. Above elementary particle length scales one sees only the classical electric field reducing to the induced Kähler form and classical Z^0 fields and color gauge fields are effectively absent. Only in phases with a large value of Planck constant classical Z^0 field and other classical weak fields and color gauge field could make themselves visible. Cell membrane could be one such system [K66]. This conforms with the general picture about color confinement and weak massivation.

The GRT limit of TGD suggests a further reason for why Weinberg angle should vanish in Minkowskian regions.

- (a) The value of the Kähler coupling strength must be very near to the value of the fine structure constant in electron length scale and these constants can be assumed to be equal.
- (b) GRT limit of TGD with space-time surfaces replaced with abstract 4-geometries would naturally correspond to Einstein-Maxwell theory with cosmological constant which is non-vanishing only in Euclidian regions of space-time so that both Reissner-Nordström metric and CP_2 are allowed as simplest possible solutions of field equations [K85]. The extremely small value of the observed cosmological constant needed in GRT type cosmology could be equal to the large cosmological constant associated with CP_2 metric multiplied with the 3-volume fraction of Euclidian regions.
- (c) Also at GRT limit quantum theory would reduce to almost topological QFT since Einstein-Maxwell action reduces to 3-D term by field equations implying the vanishing of the Maxwell current and of the curvature scalar in Minkowskian regions and curvature scalar + cosmological constant term in Euclidian regions. The weak form of electric-magnetic duality would guarantee also now the preferred extremal property and prevent the reduction to a mere topological QFT.
- (d) GRT limit would make sense only for a vanishing Weinberg angle in Minkowskian regions. A non-vanishing Weinberg angle would make sense in the deep interior of the Euclidian regions where the approximation as a small deformation of CP_2 makes sense.

The weak form of electric-magnetic duality has surprisingly strong implications for the basic view about quantum TGD as following considerations show.

4.6.2 Magnetic confinement, the short range of weak forces, and color confinement

The weak form of electric-magnetic duality has surprisingly strong implications if one combines it with some very general empirical facts such as the non-existence of magnetic monopole fields in macroscopic length scales.

How can one avoid macroscopic magnetic monopole fields?

Monopole fields are experimentally absent in length scales above order weak boson length scale and one should have a mechanism neutralizing the monopole charge. How electroweak interactions become short ranged in TGD framework is still a poorly understood problem. What suggests itself is the neutralization of the weak isospin above the intermediate gauge boson Compton length by neutral Higgs bosons. Could the two neutralization mechanisms be combined to single one?

- (a) In the case of fermions and their super partners the opposite magnetic monopole would be a wormhole throat. If the magnetically charged wormhole contact is electromagnetically neutral but has vectorial weak isospin neutralizing the weak vectorial isospin of the fermion only the electromagnetic charge of the fermion is visible on longer length scales. The distance of this wormhole throat from the fermionic one should be of the order weak boson Compton length. An interpretation as a bound state of fermion and a wormhole throat state with the quantum numbers of a neutral Higgs boson would therefore make sense. The neutralizing throat would have quantum numbers of $X_{-1/2} = \nu_L \bar{\nu}_R$ or $X_{1/2} = \bar{\nu}_L \nu_R$. $\nu_L \bar{\nu}_R$ would not be neutral Higgs boson (which should correspond to a wormhole contact) but a super-partner of left-handed neutrino obtained by adding a right handed neutrino. This mechanism would apply separately to the fermionic and anti-fermionic throats of the gauge bosons and corresponding space-time sheets and leave only electromagnetic interaction as a long ranged interaction.
- (b) One can of course wonder what is the situation for the bosonic wormhole throats feeding gauge fluxes between space-time sheets. It would seem that these wormhole throats must always appear as pairs such that for the second member of the pair monopole charges and I_V^3 cancel each other at both space-time sheets involved so that one obtains at both space-time sheets magnetic dipoles of size of weak boson Compton length. The proposed magnetic character of fundamental particles should become visible at TeV energies so that LHC might have surprises in store!

Magnetic confinement and color confinement

Magnetic confinement generalizes also to the case of color interactions. One can consider also the situation in which the magnetic charges of quarks (more generally, of color excited leptons and quarks) do not vanish and they form color and magnetic singles in the hadronic length scale. This would mean that magnetic charges of the state $q_{\pm 1/2} - X_{\mp 1/2}$ representing the physical quark would not vanish and magnetic confinement would accompany also color confinement. This would explain why free quarks are not observed. To how degree then quark confinement corresponds to magnetic confinement is an interesting question.

For quark and antiquark of meson the magnetic charges of quark and antiquark would be opposite and meson would correspond to a Kähler magnetic flux so that a stringy view about meson emerges. For valence quarks of baryon the vanishing of the net magnetic charge takes place provided that the magnetic net charges are $(\pm 2, \mp 1, \mp 1)$. This brings in mind the spectrum of color hyper charges coming as $(\pm 2, \mp 1, \mp 1)/3$ and one can indeed ask whether color hypercharge correlates with the Kähler magnetic charge. The geometric picture would be three strings connected to single vertex. Amusingly, the idea that color hypercharge could be proportional to color hyper charge popped up during the first year of TGD when I had not yet discovered CP_2 and believed on $M^4 \times S^2$.

p-Adic length scale hypothesis and hierarchy of Planck constants defining a hierarchy of dark variants of particles suggest the existence of scaled up copies of QCD type physics and weak physics. For p-adically scaled up variants the mass scales would be scaled by a power of $\sqrt{2}$ in the most general case. The dark variants of the particle would have the same mass as the original one. In particular, Mersenne primes $M_k = 2^k - 1$ and Gaussian Mersennes $M_{G,k} = (1 + i)^k - 1$ has been proposed to define zoomed copies of these physics. At the level of magnetic confinement this would mean hierarchy of length scales for the magnetic confinement.

One particular proposal is that the Mersenne prime M_{89} should define a scaled up variant of the ordinary hadron physics with mass scaled up roughly by a factor $2^{(107-89)/2} = 512$. The size scale of color confinement for this physics would be same as the weak length scale. It would look more natural that the weak confinement for the quarks of M_{89} physics takes place in some shorter scale and M_{61} is the first Mersenne prime to be considered. The mass scale of M_{61} weak bosons would be by a factor $2^{(89-61)/2} = 2^{14}$ higher and about 1.6×10^4 TeV. M_{89} quarks would have virtually no weak interactions but would possess color interactions with weak confinement length scale reflecting themselves as new kind of jets at collisions above TeV energies.

In the biologically especially important length scale range 10 nm -2500 nm there are as many as four Gaussian Mersennes corresponding to $M_{G,k}$, $k = 151, 157, 163, 167$. This would suggest that the existence of scaled up scales of magnetic-, weak- and color confinement. An especially interesting possibly testable prediction is the existence of magnetic monopole pairs with the size scale in this range. There are recent claims about experimental evidence for magnetic monopole pairs [D8] .

Magnetic confinement and stringy picture in TGD sense

The connection between magnetic confinement and weak confinement is rather natural if one recalls that electric-magnetic duality in super-symmetric quantum field theories means that the descriptions in terms of particles and monopoles are in some sense dual descriptions. Fermions would be replaced by string like objects defined by the magnetic flux tubes and bosons as pairs of wormhole contacts would correspond to pairs of the flux tubes. Therefore the sharp distinction between gravitons and physical particles would disappear.

The reason why gravitons are necessarily stringy objects formed by a pair of wormhole contacts is that one cannot construct spin two objects using only single fermion states at wormhole throats. Of course, also super partners of these states with higher spin obtained by adding fermions and anti-fermions at the wormhole throat but these do not give rise to graviton like states [K32] . The upper and lower wormhole throat pairs would be quantum superpositions of fermion anti-fermion pairs with sum over all fermions. The reason is that otherwise one cannot realize graviton emission in terms of joining of the ends of light-like 3-surfaces together. Also now magnetic monopole charges are necessary but now there is no need to assign the entities X_{\pm} with gravitons.

Graviton string is characterized by some p-adic length scale and one can argue that below this length scale the charges of the fermions become visible. Mersenne hypothesis suggests that some Mersenne prime is in question. One proposal is that gravitonic size scale is given by electronic Mersenne prime M_{127} . It is however difficult to test whether graviton has a structure visible below this length scale.

What happens to the generalized Feynman diagrams is an interesting question. It is not at all clear how closely they relate to ordinary Feynman diagrams. All depends on what one is ready to assume about what happens in the vertices. One could of course hope that zero energy ontology could allow some very simple description allowing perhaps to get rid of the problematic aspects of Feynman diagrams.

- (a) Consider first the recent view about generalized Feynman diagrams which relies zero energy ontology. A highly attractive assumption is that the particles appearing at wormhole throats are on mass shell particles. For incoming and outgoing elementary bosons and their super partners they would be positive it resp. negative energy states with parallel on mass shell momenta. For virtual bosons they the wormhole throats would have opposite sign of energy and the sum of on mass shell states would give virtual net momenta. This would make possible twistor description of virtual particles allowing only massless particles (in 4-D sense usually and in 8-D sense in TGD framework). The notion of virtual fermion makes sense only if one assumes in the interaction region a topological condensation creating another wormhole throat having no fermionic quantum numbers.
- (b) The addition of the particles X^{\pm} replaces generalized Feynman diagrams with the analogs of stringy diagrams with lines replaced by pairs of lines corresponding to fermion and $X_{\pm 1/2}$.

The members of these pairs would correspond to 3-D light-like surfaces glued together at the vertices of generalized Feynman diagrams. The analog of 3-vertex would not be splitting of the string to form shorter strings but the replication of the entire string to form two strings with same length or fusion of two strings to single string along all their points rather than along ends to form a longer string. It is not clear whether the duality symmetry of stringy diagrams can hold true for the TGD variants of stringy diagrams.

- (c) How should one describe the bound state formed by the fermion and X^\pm ? Should one describe the state as superposition of non-parallel on mass shell states so that the composite state would be automatically massive? The description as superposition of on mass shell states does not conform with the idea that bound state formation requires binding energy. In TGD framework the notion of negentropic entanglement has been suggested to make possible the analogs of bound states consisting of on mass shell states so that the binding energy is zero [K51]. If this kind of states are in question the description of virtual states in terms of on mass shell states is not lost. Of course, one cannot exclude the possibility that there is infinite number of this kind of states serving as analogs for the excitations of string like object.
- (d) What happens to the states formed by fermions and $X_{\pm 1/2}$ in the internal lines of the Feynman diagram? Twistor philosophy suggests that only the higher on mass shell excitations are possible. If this picture is correct, the situation would not change in an essential manner from the earlier one.

The highly non-trivial prediction of the magnetic confinement is that elementary particles should have stringy character in electro-weak length scales and could behaving to become manifest at LHC energies. This adds one further item to the list of non-trivial predictions of TGD about physics at LHC energies [K52].

Should $J + J_1$ appear in Kähler action?

The presence of the S^2 Kähler form J_1 in the weak form of electric-magnetic duality was originally suggested by an erratic argument about the reduction to almost topological QFT to be described in the next subsection. In any case this argument raises the question whether one could replace J with $J + J_1$ in the Kähler action. This would not affect the basic non-vacuum extremals but would modify the vacuum degeneracy of the Kähler action. Canonically imbedded M^4 would become a monopole configuration with an infinite magnetic energy and Kähler action due to the monopole singularity at the line connecting tips of the CD . Action and energy can be made small by drilling a small hole around origin. This is however not consistent with the weak form of electro-weak duality. Amusingly, the modified Dirac equation reduces to ordinary massless Dirac equation in M^4 .

This extremal can be transformed to a vacuum extremal by assuming that the solution is also a CP_2 magnetic monopole with opposite contribution to the magnetic charge so that $J + J_1 = 0$ holds true. This is achieved if one can regard space-time surface as a map $M^4 \rightarrow CP_2$ reducing to a map $(\Theta, \Phi) = (\theta, \pm\phi)$ with the sign chosen by properly projecting the homologically non-trivial $r_M = \text{constant}$ spheres of CD to the homologically non-trivial geodesic sphere of CP_2 . Symplectic transformations of $S^2 \times CP_2$ produce new vacuum extremals of this kind. Using Darboux coordinates in which one has $J = \sum_{k=1,2} P_k dQ^k$ and assuming that (P_1, Q_1) corresponds to the CP_2 image of S^2 , one can take Q_2 to be arbitrary function of P^2 , which in turn is an arbitrary function of M^4 coordinates to obtain even more general vacuum extremals with 3-D CP_2 projection. Therefore the spectrum of vacuum extremals, which is very relevant for the TGD based description of gravitation in long length scales because it allows to satisfy Einstein's equations as an additional condition, looks much richer than for the original option, and it is natural to ask whether this option might make sense.

An objection is that J_1 is a radial monopole field and this breaks Lorentz invariance to $SO(3)$. Lorentz invariance is broken to $SO(3)$ for a given CD also by the presence of the preferred time direction defined by the time-like line connecting the tips of the CD becoming carrying the monopole charge but is compensated since Lorentz boosts of CD s are possible. Could one

consider similar compensation also now? Certainly the extremely small breaking of Lorentz invariance and the vanishing of the monopole charge for the vacuum extremals is all that is needed at the space-time level. No new gauge fields would be introduced since only the Kähler field part of photon and Z^0 boson would receive an additional contribution.

The ultimate fate of the modification depends on whether it is consistent with the general relativistic description of gravitation. Since a breaking of spherical symmetry is involved, it is not at all clear whether one can find vacuum extremals which represent small deformations of the Reissner-Nordström metric and Robertson-Walker metric. The argument below shows that this option does not allow the imbedding of small deformations of physically plausible space-time metrics as vacuum extremals.

The basic vacuum extremal whose deformations should give vacuum extremals allowing interpretation as solutions of Einstein's equations is given by a map $M^4 \rightarrow CP_2$ projecting the r_M constant spheres S^2 of M^2 to the homologically non-trivial geodesic sphere of CP_2 . The winding number of this map is -1 in order to achieve vanishing of the induced Kähler form $J + J_1$. For instance, the following two canonical forms of the map are possible

$$\begin{aligned} (\Theta, \Psi) &= (\theta_M, -\phi_M) , \\ (\Theta, \Psi) &= (\pi - \theta_M, \phi_M) . \end{aligned} \tag{4.6.11}$$

Here (Θ, Ψ) refers to the geodesic sphere of CP_2 and (θ_M, ϕ_M) to the sphere of M^4 .

The resulting space-time surface is not flat and Einstein tensor is non-vanishing. More complex metrics can be constructed from this metric by a deformation making the CP_2 projection 3-dimensional.

Using the expression of the CP_2 line element in Eguchi-Hanson coordinates [L5]

$$\frac{ds^2}{R^2} = \frac{dr^2}{F^2} + \frac{r^2}{F} (d\Psi + \cos\Theta d\Phi)^2 + \frac{r^2}{4F} (d\Theta^2 + \frac{r^2}{4F} \sin^2\Theta d\Phi^2) \tag{4.6.12}$$

and using the relationship $r = \tan(\Theta)$, one obtains following expression for the CP_2 metric

$$\frac{ds^2}{R^2} = d\theta_M^2 + \sin^2(\theta_M) \left[(d\phi_M + \cos(\theta) d\Phi)^2 + \frac{1}{4} (d\theta^2 + \sin^2(\theta) d\Phi^2) \right] . \tag{4.6.13}$$

The resulting metric is obtained from the metric of S^2 by replacing $d\phi^2$ which 3-D line element. The factor $\sin^2(\theta_M)$ implies that the induced metric becomes singular at North and South poles of S^2 . In particular, the gravitational potential is proportional to $\sin^2(\theta_M)$ so that gravitational force in the radial direction vanishes at equators. It is very difficult to imagine any manner to produce a small deformation of Reissner-Nordström metric or Robertson-Walker metric. Hence it seems that the vacuum extremals produce by $J + J_1$ option are not physical.

4.6.3 Could Quantum TGD reduce to almost topological QFT?

There seems to be a profound connection with the earlier unrealistic proposal that TGD reduces to almost topological quantum theory in the sense that the counterpart of Chern-Simons action assigned with the wormhole throats somehow dictates the dynamics. This proposal can be formulated also for the modified Dirac action action. I gave up this proposal but the following argument shows that Kähler action with weak form of electric-magnetic duality effectively reduces to Chern-Simons action plus Coulomb term.

- (a) Kähler action density can be written as a 4-dimensional integral of the Coulomb term $j_K^\alpha A_\alpha$ plus and integral of the boundary term $J^{n\beta} A_\beta \sqrt{g_4}$ over the wormhole throats and of the quantity $J^{0\beta} A_\beta \sqrt{g_4}$ over the ends of the 3-surface.
- (b) If the self-duality conditions generalize to $J^{n\beta} = 4\pi\alpha_K \epsilon^{n\beta\gamma\delta} J_{\gamma\delta}$ at throats and to $J^{0\beta} = 4\pi\alpha_K \epsilon^{0\beta\gamma\delta} J_{\gamma\delta}$ at the ends, the Kähler function reduces to the counterpart of Chern-Simons action evaluated at the ends and throats. It would have same value for each branch and the replacement $\hbar_0 \rightarrow r\hbar_0$ would effectively describe this. Boundary conditions would however give $1/r$ factor so that \hbar would disappear from the Kähler function! The original attempt to realize quantum TGD as an almost topological QFT was in terms of Chern-Simons action but was given up. It is somewhat surprising that Kähler action gives Chern-Simons action in the vacuum sector defined as sector for which Kähler current is light-like or vanishes.

Holography encourages to ask whether also the Coulomb interaction terms could vanish. This kind of dimensional reduction would mean an enormous simplification since TGD would reduce to an almost topological QFT. The attribute "almost" would come from the fact that one has non-vanishing classical Noether charges defined by Kähler action and non-trivial quantum dynamics in M^4 degrees of freedom. One could also assign to space-time surfaces conserved four-momenta which is not possible in topological QFTs. For this reason the conditions guaranteeing the vanishing of Coulomb interaction term deserve a detailed analysis.

- (a) For the known extremals j_K^α either vanishes or is light-like ("massless extremals" for which weak self-duality condition does not make sense [K11]) so that the Coulombic term vanishes identically in the gauge used. The addition of a gradient to A induces terms located at the ends and wormhole throats of the space-time surface but this term must be cancelled by the other boundary terms by gauge invariance of Kähler action. This implies that the M^4 part of WCW metric vanishes in this case. Therefore massless extremals as such are not physically realistic: wormhole throats representing particles are needed.
- (b) The original naive conclusion was that since Chern-Simons action depends on CP_2 coordinates only, its variation with respect to Minkowski coordinates must vanish so that the WCW metric would be trivial in M^4 degrees of freedom. This conclusion is in conflict with quantum classical correspondence and was indeed too hasty. The point is that the allowed variations of Kähler function must respect the weak electro-magnetic duality which relates Kähler electric field depending on the induced 4-metric at 3-surface to the Kähler magnetic field. Therefore the dependence on M^4 coordinates creeps via a Lagrange multiplier term

$$\int \Lambda_\alpha (J^{n\alpha} - K \epsilon^{n\alpha\beta\gamma} J_{\beta\gamma}) \sqrt{g_4} d^3 x . \quad (4.6.14)$$

The (1,1) part of second variation contributing to M^4 metric comes from this term.

- (c) This erratic conclusion about the vanishing of M^4 part WCW metric raised the question about how to achieve a non-trivial metric in M^4 degrees of freedom. The proposal was a modification of the weak form of electric-magnetic duality. Besides CP_2 Kähler form there would be the Kähler form assignable to the light-cone boundary reducing to that for $r_M = \text{constant}$ sphere - call it J^1 . The generalization of the weak form of self-duality would be $J^{n\beta} = \epsilon^{n\beta\gamma\delta} K (J_{\gamma\delta} + \epsilon J_{\gamma\delta}^1)$. This form implies that the boundary term gives a non-trivial contribution to the M^4 part of the WCW metric even without the constraint from electric-magnetic duality. Kähler charge is not affected unless the partonic 2-surface contains the tip of CD in its interior. In this case the value of Kähler charge is shifted by a topological contribution. Whether this term can survive depends on whether the resulting vacuum extremals are consistent with the basic facts about classical gravitation.
- (d) The Coulombic interaction term is not invariant under gauge transformations. The good news is that this might allow to find a gauge in which the Coulomb term vanishes. The vanishing condition fixing the gauge transformation ϕ is

$$j_K^\alpha \partial_\alpha \phi = -j^\alpha A_\alpha . \quad (4.6.15)$$

This differential equation can be reduced to an ordinary differential equation along the flow lines j_K by using $dx^\alpha/dt = j_K^\alpha$. Global solution is obtained only if one can combine the flow parameter t with three other coordinates- say those at the either end of CD to form space-time coordinates. The condition is that the parameter defining the coordinate differential is proportional to the covariant form of Kähler current: $dt = \phi j_K$. This condition in turn implies $d^2t = d(\phi j_K) = d(\phi j_K) = d\phi \wedge j_K + \phi dj_K = 0$ implying $j_K \wedge dj_K = 0$ or more concretely,

$$\epsilon^{\alpha\beta\gamma\delta} j_\beta^K \partial_\gamma j_\delta^K = 0 . \quad (4.6.16)$$

j_K is a four-dimensional counterpart of Beltrami field [B49] and could be called generalized Beltrami field.

The integrability conditions follow also from the construction of the extremals of Kähler action [K11] . The conjecture was that for the extremals the 4-dimensional Lorentz force vanishes (no dissipation): this requires $j_K \wedge J = 0$. One manner to guarantee this is the topologization of the Kähler current meaning that it is proportional to the instanton current: $j_K = \phi j_I$, where $j_I = *(J \wedge A)$ is the instanton current, which is not conserved for 4-D CP_2 projection. The conservation of j_K implies the condition $j_I^\alpha \partial_\alpha \phi = \partial_\alpha j^\alpha \phi$ and from this ϕ can be integrated if the integrability condition $j_I \wedge dj_I = 0$ holds true implying the same condition for j_K . By introducing at least 3 or CP_2 coordinates as space-time coordinates, one finds that the contravariant form of j_I is purely topological so that the integrability condition fixes the dependence on M^4 coordinates and this selection is coded into the scalar function ϕ . These functions define families of conserved currents $j_K^\alpha \phi$ and $j_I^\alpha \phi$ and could be also interpreted as conserved currents associated with the critical deformations of the space-time surface.

- (e) There are gauge transformations respecting the vanishing of the Coulomb term. The vanishing condition for the Coulomb term is gauge invariant only under the gauge transformations $A \rightarrow A + \nabla\phi$ for which the scalar function the integral $\int j_K^\alpha \partial_\alpha \phi$ reduces to a total divergence a giving an integral over various 3-surfaces at the ends of CD and at throats vanishes. This is satisfied if the allowed gauge transformations define conserved currents

$$D_\alpha(j^\alpha \phi) = 0 . \quad (4.6.17)$$

As a consequence Coulomb term reduces to a difference of the conserved charges $Q_\phi^e = \int j^0 \phi \sqrt{g_4} d^3x$ at the ends of the CD vanishing identically. The change of the imons type term is trivial if the total weighted Kähler magnetic flux $Q_\phi^m = \sum \int J \phi dA$ over wormhole throats is conserved. The existence of an infinite number of conserved weighted magnetic fluxes is in accordance with the electric-magnetic duality. How these fluxes relate to the flux Hamiltonians central for WCW geometry is not quite clear.

- (f) The gauge transformations respecting the reduction to almost topological QFT should have some special physical meaning. The measurement interaction term in the modified Dirac interaction corresponds to a critical deformation of the space-time sheet and is realized as an addition of a gauge part to the Kähler gauge potential of CP_2 . It would be natural to identify this gauge transformation giving rise to a conserved charge so that the conserved charges would provide a representation for the charges associated with the infinitesimal critical deformations not affecting Kähler action. The gauge transformed Kähler potential couples to the modified Dirac equation and its effect could be visible in the value of Kähler function and therefore also in the properties of the preferred extremal. The effect on WCW metric would however vanish since K would transform only by an addition of a real part of a holomorphic function. Kähler function is identified as a Dirac determinant for Chern-Simons Dirac action and the spectrum of this operator should not be invariant under these gauge transformations if this picture is correct. This is achieved if the gauge transformation is carried only in the Dirac action corresponding to the Chern-Simons term: this assumption is motivated by the breaking of time reversal invariance induced by quantum measurements. The modification of Kähler action can be guessed to correspond just to the Chern-Simons contribution from the instanton term.

- (g) A reasonable looking guess for the explicit realization of the quantum classical correspondence between quantum numbers and space-time geometry is that the deformation of the preferred extremal due to the addition of the measurement interaction term is induced by a $U(1)$ gauge transformation induced by a transformation of $\delta CD \times CP_2$ generating the gauge transformation represented by ϕ . This interpretation makes sense if the fluxes defined by Q_ϕ^m and corresponding Hamiltonians affect only zero modes rather than quantum fluctuating degrees of freedom.

To sum up, one could understand the basic properties of WCW metric in this framework. Effective 2-dimensionality would result from the existence of an infinite number of conserved charges in two different time directions (genuine conservation laws plus gauge fixing). The infinite-dimensional symmetric space for given values of zero modes corresponds to the Cartesian product of the WCWs associated with the partonic 2-surfaces at both ends of CD and the generalized Chern-Simons term decomposes into a sum of terms from the ends giving single particle Kähler functions and to the terms from light-like wormhole throats giving interaction term between positive and negative energy parts of the state. Hence Kähler function could be calculated without any knowledge about the interior of the space-time sheets and TGD would reduce to almost topological QFT as speculated earlier. Needless to say this would have immense boost to the program of constructing WCW Kähler geometry.

4.6.4 Kähler action for Euclidian regions as Kähler function and Kähler action for Minkowskian regions as Morse function?

One of the nasty questions about the interpretation of Kähler action relates to the square root of the metric determinant. If one proceeds completely straightforwardly, the only reason conclusion is that the square root is imaginary in Minkowskian space-time regions so that Kähler action would be complex. The Euclidian contribution would have a natural interpretation as positive definite Kähler function but how should one interpret the imaginary Minkowskian contribution? Certainly the path integral approach to quantum field theories supports its presence. For some mysterious reason I was able to forget this nasty question and serious consideration of the obvious answer to it. Only when I worked between possible connections between TGD and Floer homology [K93] I realized that the Minkowskian contribution is an excellent candidate for Morse function whose critical points give information about WCW homology. This would fit nicely with the vision about TGD as almost topological QFT.

Euclidian regions would guarantee the convergence of the functional integral and one would have a mathematically well-defined theory. Minkowskian contribution would give the quantal interference effects and stationary phase approximation. The analog of Floer homology would represent quantum superpositions of critical points identifiable as ground states defined by the extrema of Kähler action for Minkowskian regions. Perturbative approach to quantum TGD would rely on functional integrals around the extrema of Kähler function. One would have maxima also for the Kähler function but only in the zero modes not contributing to the WCW metric.

There is a further question related to almost topological QFT character of TGD. Should one assume that the reduction to Chern-Simons terms occurs for the preferred extremals in *both* Minkowskian and Euclidian regions or only in Minkowskian regions?

- (a) All arguments for this have been represented for Minkowskian regions [K31] involve local light-like momentum direction which does not make sense in the Euclidian regions. This does not however kill the argument: one can have non-trivial solutions of Laplacian equation in the region of CP_2 bounded by wormhole throats: for CP_2 itself only covariantly constant right-handed neutrino represents this kind of solution and at the same time supersymmetry. In the general case solutions of Laplacian represent broken super-symmetries and should be in one-one correspondences with the solutions of the modified Dirac equation. The interpretation for the counterparts of momentum and polarization would be in terms of classical representation of color quantum numbers.

- (b) If the reduction occurs in Euclidian regions, it gives in the case of CP_2 two 3-D terms corresponding to two 3-D gluing regions for three coordinate patches needed to define coordinates and spinor connection for CP_2 so that one would have two Chern-Simons terms. I have earlier claimed that without any other contributions the first term would be identical with that from Minkowskian region apart from imaginary unit and different coefficient. This statement is wrong since the space-like parts of the corresponding 3-surfaces are disjoint for Euclidian and Minkowskian regions.
- (c) There is also another very delicate issue involved. Quantum classical correspondence requires that the quantum numbers of partonic states must be coded to the space-time geometry, and this is achieved by adding to the action a measurement interaction term which reduces to what is almost a gauge term present only in Chern-Simons-Dirac equation but not at space-time interior [K31]. This term would represent a coupling to Poincare quantum numbers at the Minkowskian side and to color and electro-weak quantum numbers at CP_2 side. Therefore the net Chern-Simons contributions would be different.
- (d) There is also a very beautiful argument stating that Dirac determinant for Chern-Simons-Dirac action equals to Kähler function, which would be lost if Euclidian regions would not obey holography. The argument obviously generalizes and applies to both Morse and Kähler function which are definitely not proportional to each other.

The Minkowskian contribution of Kähler action is imaginary due to the negative of the metric determinant and gives a phase factor to vacuum functional reducing to Chern-Simons terms at wormhole throats. Ground state degeneracy due to the possibility of having both signs for Minkowskian contribution to the exponent of vacuum functional provides a general view about the description of CP breaking in TGD framework.

- (a) In TGD framework path integral is replaced by inner product involving integral over WCV. The vacuum functional and its conjugate are associated with the states in the inner product so that the phases of vacuum functionals cancel if only one sign for the phase is allowed. Minkowskian contribution would have no physical significance. This of course cannot be the case. The ground state is actually degenerate corresponding to the phase factor and its complex conjugate since \sqrt{g} can have two signs in Minkowskian regions. Therefore the inner products between states associated with the two ground states define 2×2 matrix and non-diagonal elements contain interference terms due to the presence of the phase factor. At the limit of full CP_2 type vacuum extremal the two ground states would reduce to each other and the determinant of the matrix would vanish.
- (b) A small mixing of the two ground states would give rise to CP breaking and the first principle description of CP breaking in systems like $K-\bar{K}$ and of CKM matrix should reduce to this mixing. K^0 mesons would be CP even and odd states in the first approximation and correspond to the sum and difference of the ground states. Small mixing would be present having exponential sensitivity to the actions of CP_2 type extremals representing wormhole throats. This might allow to understand qualitatively why the mixing is about 50 times larger than expected for B^0 mesons.
- (c) There is a strong temptation to assign the two ground states with two possible arrows of geometric time. At the level of M-matrix the two arrows would correspond to state preparation at either upper or lower boundary of CD. Do long- and shortlived neutral K mesons correspond to almost fifty-fifty orthogonal superpositions for the two arrow of geometric time or almost completely to a fixed arrow of time induced by environment? Is the dominant part of the arrow same for both or is it opposite for long and short-lived neutral mesons? Different lifetimes would suggest that the arrow must be the same and apart from small leakage that induced by environment. CP breaking would be induced by the fact that CP is performed only K^0 but not for the environment in the construction of states. One can probably imagine also alternative interpretations.

4.7 How to define generalized Feynman diagrams?

S-matrix codes to a high degree the predictions of quantum theories. The longstanding challenge of TGD has been to construct or at least demonstrate the mathematical existence of S-matrix- or actually M-matrix which generalizes this notion in zero energy ontology (ZEO) [K69]. This work has led to the notion of generalized Feynman diagram and the challenge is to give a precise mathematical meaning for this object. The attempt to understand the counterpart of twistors in TGD framework [K89] has inspired several key ideas in this respect but it turned out that twistors themselves need not be absolutely necessary in TGD framework.

- (a) The notion of generalized Feynman diagram defined by replacing lines of ordinary Feynman diagram with light-like 3-surfaces (elementary particle sized wormhole contacts with throats carrying quantum numbers) and vertices identified as their 2-D ends - I call them partonic 2-surfaces is central. Speaking somewhat loosely, generalized Feynman diagrams (plus background space-time sheets) define the "world of classical worlds" (WCW). These diagrams involve the analogs of stringy diagrams but the interpretation is different: the analogs of stringy loop diagrams have interpretation in terms of particle propagating via two different routes simultaneously (as in the classical double slit experiment) rather than as a decay of particle to two particles. For stringy diagrams the counterparts of vertices are singular as manifolds whereas the entire diagrams are smooth. For generalized Feynman diagrams vertices are smooth but entire diagrams represent singular manifolds just like ordinary Feynman diagrams do. String like objects however emerge in TGD and even ordinary elementary particles are predicted to be magnetic flux tubes of length of order weak gauge boson Compton length with monopoles at their ends as shown in accompanying article. This stringy character should become visible at LHC energies.
- (b) Zero energy ontology (ZEO) and causal diamonds (intersections of future and past directed lightcones) is second key ingredient. The crucial observation is that in ZEO it is possible to identify off mass shell particles as pairs of on mass shell particles at throats of wormhole contact since both positive and negative signs of energy are possible. The propagator defined by modified Dirac action does not diverge (except for incoming lines) although the fermions at throats are on mass shell. In other words, the generalized eigenvalue of the modified Dirac operator containing a term linear in momentum is non-vanishing and propagator reduces to $G = i/\lambda\gamma$, where γ is so called modified gamma matrix in the direction of stringy coordinate [K19]. This means opening of the black box of the off mass shell particle-something which for some reason has not occurred to anyone fighting with the divergences of quantum field theories.
- (c) A powerful constraint is number theoretic universality requiring the existence of Feynman amplitudes in all number fields when one allows suitable algebraic extensions: roots of unity are certainly required in order to realize p-adic counter parts of plane waves. Also imbedding space, partonic 2-surfaces and WCW must exist in all number fields and their extensions. These constraints are enormously powerful and the attempts to realize this vision have dominated quantum TGD for last two decades.
- (d) Representation of 8-D gamma matrices in terms of octonionic units and 2-D sigma matrices is a further important element as far as twistors are considered [K89]. Modified gamma matrices at space-time surfaces are quaternionic/associative and allow a genuine matrix representation. As a matter fact, TGD and WCW can be formulated as study of associative local sub-algebras of the local Clifford algebra of 8-D imbedding space parameterized by quaternionic space-time surfaces. Central conjecture is that quaternionic 4-surfaces correspond to preferred extremals of Kähler action [K19] identified as critical ones (second variation of Kähler action vanishes for infinite number of deformations defining super-conformal algebra) and allow a slicing to string worldsheets parametrized by points of partonic 2-surfaces.
- (e) As far as twistors are considered, the first key element is the reduction of the octonionic twistor structure to quaternionic one at space-time surfaces and giving effectively 4-D spinor and twistor structure for quaternionic surfaces.

Quite recently quite a dramatic progress took place in this approach [K89] .

- (a) The progress was stimulated by the simple observation that on mass shell property puts enormously strong kinematic restrictions on the loop integrations. With mild restrictions on the number of parallel fermion lines appearing in vertices (there can be several since fermionic oscillator operator algebra defining SUSY algebra generates the parton states)-all loops are manifestly finite and if particles has always mass -say small p-adic thermal mass also in case of massless particles and due to IR cutoff due to the presence largest CD- the number of diagrams is finite. Unitarity reduces to Cutkosky rules [B26] automatically satisfied as in the case of ordinary Feynman diagrams.
- (b) Ironically, twistors which stimulated all these development do not seem to be absolutely necessary in this approach although they are of course possible. Situation changes if one does not assume small p-adically thermal mass due to the presence of massless particles and one must sum infinite number of diagrams. Here a potential problem is whether the infinite sum respects the algebraic extension in question.

This is about fermionic and momentum space aspects of Feynman diagrams but not yet about the functional (not path-) integral over small deformations of the partonic 2-surfaces. The basic challenges are following.

- (a) One should perform the functional integral over WCW degrees of freedom for fixed values of on mass shell momenta appearing in the internal lines. After this one must perform integral or summation over loop momenta. Note that the order is important since the space-time surface assigned to the line carries information about the quantum numbers associated with the line by quantum classical correspondence realized in terms of modified Dirac operator.
- (b) One must define the functional integral also in the p-adic context. p-Adic Fourier analysis relying on algebraic continuation raises hopes in this respect. p-Adicity suggests strongly that the loop momenta are discretized and ZEO predicts this kind of discretization naturally.

It indeed seems that the functional integrals over WCW could be carried out at general level both in real and p-adic context. This is due to the symmetric space property (maximal number of isometries) of WCW required by the mere mathematical existence of Kähler geometry [K40] in infinite-dimensional context already in the case of much simpler loop spaces [A49] .

- (a) The p-adic generalization of Fourier analysis allows to algebraize integration- the horrible looking technical challenge of p-adic physics- for symmetric spaces for functions allowing the analog of discrete Fourier decomposition. Symmetric space property is indeed essential also for the existence of Kähler geometry for infinite-D spaces as was learned already from the case of loop spaces. Plane waves and exponential functions expressible as roots of unity and powers of p multiplied by the direct analogs of corresponding exponent functions are the basic building bricks and key functions in harmonic analysis in symmetric spaces. The physically unavoidable finite measurement resolution corresponds to algebraically unavoidable finite algebraic dimension of algebraic extension of p-adics (at least some roots of unity are needed). The cutoff in roots of unity is very reminiscent to that occurring for the representations of quantum groups and is certainly very closely related to these as also to the inclusions of hyper-finite factors of type II_{sub*λ*1}/sub*λ* defining the finite measurement resolution.
- (b) WCW geometrization reduces to that for a single line of the generalized Feynman diagram defining the basic building brick for WCW. Kähler function decomposes to a sum of "kinetic" terms associated with its ends and interaction term associated with the line itself. p-Adicization boils down to the condition that Kähler function, matrix elements of Kähler form, WCW Hamiltonians and their super counterparts, are rational functions of complex WCW coordinates just as they are for those symmetric spaces that I know of. This allows straightforward continuation to p-adic context.

- (c) As far as diagrams are considered, everything is manifestly finite as the general arguments (non-locality of Kähler function as functional of 3-surface) developed two decades ago indeed allow to expect. General conditions on the holomorphy properties of the generalized eigenvalues λ of the modified Dirac operator can be deduced from the conditions that propagator decomposes to a sum of products of harmonics associated with the ends of the line and that similar decomposition takes place for exponent of Kähler action identified as Dirac determinant. This guarantees that the convolutions of propagators and vertices give rise to products of harmonic functions which can be Glebsch-Gordanized to harmonics and only the singlet contributes to the WCW integral in given vertex. The still unproven central conjecture is that Dirac determinant equals the exponent of Kähler function.

In the following this vision about generalized Feynman diagrams is discussed in more detail.

4.7.1 Questions

The goal is a proposal for how to perform the integral over WCW for generalized Feynman diagrams and the best manner to proceed to this goal is by making questions.

What does finite measurement resolution mean?

The first question is what finite measurement resolution means.

- (a) One expects that the algebraic continuation makes sense only for a finite measurement resolution in which case one obtains only finite sums of what one might hope to be algebraic functions. The finiteness of the algebraic extension would be in fact equivalent with the finite measurement resolution.
- (b) Finite measurement resolution means a discretization in terms of number theoretic braids. p-Adicization condition suggests that that one must allow only the number theoretic braids. For these the ends of braid at boundary of CD are algebraic points of the imbedding space. This would be true at least in the intersection of real and p-adic worlds.
- (c) The question is whether one can localize the points of the braid. The necessity to use momentum eigenstates to achieve quantum classical correspondence in the modified Dirac action [K19] suggests however a delocalization of braid points, that is wave function in space of braid points. In real context one could allow all possible choices for braid points but in p-adic context only algebraic points are possible if one wants to replace integrals with sums. This implies finite measurement resolution analogous to that in lattice. This is also the only possibility in the intersection of real and p-adic worlds.

A non-trivial prediction giving a strong correlation between the geometry of the partonic 2-surface and quantum numbers is that the total number $n_F + n_{\bar{F}}$ of fermions and antifermions is bounded above by the number n_{alg} of algebraic points for a given partonic 2-surface: $n_F + n_{\bar{F}} \leq n_{alg}$. Outside the intersection of real and p-adic worlds the problematic aspect of this definition is that small deformations of the partonic 2-surface can radically change the number of algebraic points unless one assumes that the finite measurement resolution means restriction of WCW to a sub-space of algebraic partonic surfaces.

- (d) One has also a discretization of loop momenta if one assumes that virtual particle momentum corresponds to ZEO defining rest frame for it and from the discretization of the relative position of the second tip of CD at the hyperboloid isometric with mass shell. Only the number of braid points and their momenta would matter, not their positions. The measurement interaction term in the modified Dirac action gives coupling to the space-time geometry and Kähler function through generalized eigenvalues of the modified Dirac operator with measurement interaction term linear in momentum and in the color quantum numbers assignable to fermions [K19].

How to define integration in WCW degrees of freedom?

The basic question is how to define the integration over WCW degrees of freedom.

- (a) What comes mind first is Gaussian perturbation theory around the maxima of Kähler function. Gaussian and metric determinants cancel each other and only algebraic expressions remain. Finiteness is not a problem since the Kähler function is non-local functional of 3-surface so that no local interaction vertices are present. One should however assume the vanishing of loops required also by algebraic universality and this assumption look unrealistic when one considers more general functional integrals than that of vacuum functional since free field theory is not in question. The construction of the inverse of the WCW metric defining the propagator is also a very difficult challenge. Duistermaat-Hecke theorem states that something like this known as localization might be possible and one can also argue that something analogous to localization results from a generalization of mean value theorem.
- (b) Symmetric space property is more promising since it might reduce the integrations to group theory using the generalization of Fourier analysis for group representations so that there would be no need for perturbation theory in the proposed sense. In finite measurement resolution the symmetric spaces involved would be finite-dimensional. Symmetric space structure of WCW could also allow to define p-adic integration in terms of p-adic Fourier analysis for symmetric spaces. Essentially algebraic continuation of the integration from the real case would be in question with additional constraints coming from the fact that only phase factors corresponding to finite algebraic extensions of rationals are used. Cutoff would emerge automatically from the cutoff for the dimension of the algebraic extension.

How to define generalized Feynman diagrams?

Integration in symmetric spaces could serve as a model at the level of WCW and allow both the understanding of WCW integration and p-adicization as algebraic continuation. In order to get a more realistic view about the problem one must define more precisely what the calculation of the generalized Feynman diagrams means.

- (a) WCW integration must be carried out separately for all values of the momenta associated with the internal lines. The reason is that the spectrum of eigenvalues λ_i of the modified Dirac operator D depends on the momentum of line and momentum conservation in vertices translates to a correlation of the spectra of D at internal lines.
- (b) For tree diagrams algebraic continuation to the p-adic context if the expression involves only the replacement of the generalized eigenvalues of D as functions of momenta with their p-adic counterparts besides vertices. If these functions are algebraically universal and expressible in terms of harmonics of symmetric space, there should be no problems.
- (c) If loops are involved, one must integrate/sum over loop momenta. In p-adic context difficulties are encountered if the spectrum of the momenta is continuous. The integration over on mass shell loop momenta is analogous to the integration over sub-CDs, which suggests that internal line corresponds to a *sub-CD* in which it is at rest. There are excellent reasons to believe that the moduli space for the positions of the upper tip is a discrete subset of hyperboloid of future light-cone. If this is the case, the loop integration indeed reduces to a sum over discrete positions of the tip. p-Adicization would thus give a further good reason why for zero energy ontology.
- (d) Propagator is expressible in terms of the inverse of generalized eigenvalue and there is a sum over these for each propagator line. At vertices one has products of WCW harmonics assignable to the incoming lines. The product must have vanishing quantum numbers associated with the phase angle variables of WCW. Non-trivial quantum numbers of the WCW harmonic correspond to WCW quantum numbers assignable to excitations of ordinary elementary particles. WCW harmonics are products of functions depending on the "radial" coordinates and phase factors and the integral over the angles leaves the product of the first ones analogous to Legendre polynomials $P_{l,m}$. These functions are expected to be rational functions or at least algebraic functions involving only square roots.

- (e) In ordinary QFT incoming and outgoing lines correspond to propagator poles. In the recent case this would mean that the generalized eigenvalues $\lambda = 0$ characterize them. Internal lines coming as pairs of throats of wormhole contacts would be on mass shell with respect to momentum but off shell with respect to λ .

4.7.2 Generalized Feynman diagrams at fermionic and momentum space level

Negative energy ontology has already led to the idea of interpreting the virtual particles as pairs of positive and negative energy wormhole throats. Hitherto I have taken it as granted that ordinary Feynman diagrammatics generalizes more or less as such. It is however far from clear what really happens in the vertices of the generalized Feynmann diagrams. The safest approach relies on the requirement that unitarity realized in terms of Cutkosky rules in ordinary Feynman diagrammatics allows a generalization. This requires loop diagrams. In particular, photon-photon scattering can take place only via a fermionic square loop so that it seems that loops must be present at least in the topological sense.

One must be however ready for the possibility that something unexpectedly simple might emerge. For instance, the vision about algebraic physics allows naturally only finite sums for diagrams and does not favor infinite perturbative expansions. Hence the true believer on algebraic physics might dream about finite number of diagrams for a given reaction type. For simplicity generalized Feynman diagrams without the complications brought by the magnetic confinement since by the previous arguments the generalization need not bring in anything essentially new.

The basic idea of duality in early hadronic models was that the lines of the dual diagram representing particles are only re-arranged in the vertices. This however does not allow to get rid of off mass shell momenta. Zero energy ontology encourages to consider a stronger form of this principle in the sense that the virtual momenta of particles could correspond to pairs of on mass shell momenta of particles. If also interacting fermions are pairs of positive and negative energy throats in the interaction region the idea about reducing the construction of Feynman diagrams to some kind of lego rules might work.

Virtual particles as pairs of on mass shell particles in ZEO

The first thing is to try to define more precisely what generalized Feynman diagrams are. The direct generalization of Feynman diagrams implies that both wormhole throats and wormhole contacts join at vertices.

- (a) A simple intuitive picture about what happens is provided by diagrams obtained by replacing the points of Feynman diagrams (wormhole contacts) with short lines and imagining that the throats correspond to the ends of the line. At vertices where the lines meet the incoming on mass shell quantum numbers would sum up to zero. This approach leads to a straightforward generalization of Feynman diagrams with virtual particles replaced with pairs of on mass shell throat states of type $++$, $--$, and $+-$. Incoming lines correspond to $++$ type lines and outgoing ones to $--$ type lines. The first two line pairs allow only time like net momenta whereas $+-$ line pairs allow also space-like virtual momenta. The sign assigned to a given throat is dictated by the the sign of the on mass shell momentum on the line. The condition that Cutkosky rules generalize as such requires $++$ and $--$ type virtual lines since the cut of the diagram in Cutkosky rules corresponds to on mass shell outgoing or incoming states and must therefore correspond to $++$ or $--$ type lines.
- (b) The basic difference as compared to the ordinary Feynman diagrammatics is that loop integrals are integrals over mass shell momenta and that all throats carry on mass shell momenta. In each vertex of the loop mass incoming on mass shell momenta must sum up to on mass shell momentum. These constraints improve the behavior of loop integrals dramatically and give excellent hopes about finiteness. It does not however seem that only a finite number of diagrams contribute to the scattering amplitude besides tree diagrams. The point is that if a the reactions $N_1 \rightarrow N_2$ and $N_2 \rightarrow N_3$, where N_i denote particle

numbers, are possible in a common kinematical region for N_2 -particle states then also the diagrams $N_1 \rightarrow N_2 \rightarrow N_2 \rightarrow N_3$ are possible. The virtual states N_2 include all all states in the intersection of kinematically allow regions for $N_1 \rightarrow N_2$ and $N_2 \rightarrow N_3$. Hence the dream about finite number possible diagrams is not fulfilled if one allows massless particles. If all particles are massive then the particle number N_2 for given N_1 is limited from above and the dream is realized.

- (c) For instance, loops are not possible in the massless case or are highly singular (bringing in mind twistor diagrams) since the conservation laws at vertices imply that the momenta are parallel. In the massive case and allowing mass spectrum the situation is not so simple. As a first example one can consider a loop with three vertices and thus three internal lines. Three on mass shell conditions are present so that the four-momentum can vary in 1-D subspace only. For a loop involving four vertices there are four internal lines and four mass shell conditions so that loop integrals would reduce to discrete sums. Loops involving more than four vertices are expected to be impossible.
- (d) The proposed replacement of the elementary fermions with bound states of elementary fermions and monopoles X_{\pm} brings in the analog of stringy diagrammatics. The 2-particle wave functions in the momentum degrees of freedom of fermions and X_{\pm} might allow more flexibility and allow more loops. Note however that there are excellent hopes about the finiteness of the theory also in this case.

Loop integrals are manifestly finite

One can make also more detailed observations about loops.

- (a) The simplest situation is obtained if only 3-vertices are allowed. In this case conservation of momentum however allows only collinear momenta although the signs of energy need not be the same. Particle creation and annihilation is possible and momentum exchange is possible but is always light-like in the massless case. The scattering matrices of supersymmetric YM theories would suggest something less trivial and this raises the question whether something is missing. Magnetic monopoles are an essential element of also these theories as also massivation and symmetry breaking and this encourages to think that the formation of massive states as fermion X_{\pm} pairs is needed. Of course, in TGD framework one has also high mass excitations of the massless states making the scattering matrix non-trivial.
- (b) In YM theories on mass shell lines would be singular. In TGD framework this is not the case since the propagator is defined as the inverse of the 3-D dimensional reduction of the modified Dirac operator D containing also coupling to four-momentum (this is required by quantum classical correspondence and guarantees stringy propagators),

$$\begin{aligned} D &= i\hat{\Gamma}^{\alpha} p_{\alpha} + \hat{\Gamma}^{\alpha} D_{\alpha} \ , \\ p_{\alpha} &= p_k \partial_{\alpha} h^k \ . \end{aligned} \tag{4.7.1}$$

The propagator does not diverge for on mass shell massless momenta and the propagator lines are well-defined. This is of course of essential importance also in general case. Only for the incoming lines one can consider the possibility that 3-D Dirac operator annihilates the induced spinor fields. All lines correspond to generalized eigenstates of the propagator in the sense that one has $D_3 \Psi = \lambda \gamma \Psi$, where γ is modified gamma matrix in the direction of the stringy coordinate emanating from light-like surface and D_3 is the 3-dimensional dimensional reduction of the 4-D modified Dirac operator. The eigenvalue λ is analogous to energy. Note that the eigenvalue spectrum depends on 4-momentum as a parameter.

- (c) Massless incoming momenta can decay to massless momenta with both signs of energy. The integration measure $d^2k/2E$ reduces to dx/x where $x \geq 0$ is the scaling factor of massless momentum. Only light-like momentum exchanges are however possible and scattering matrix is essentially trivial. The loop integrals are finite apart from the possible delicacies related to poles since the loop integrands for given massless wormhole contact are proportional to dx/x^3 for large values of x .

- (d) Irrespective of whether the particles are massless or not, the divergences are obtained only if one allows too high vertices as self energy loops for which the number of momentum degrees of freedom is $3N - 4$ for N -vertex. The construction of SUSY limit of TGD in [K32] led to the conclusion that the parallelly propagating N fermions for given wormhole throat correspond to a product of N fermion propagators with same four-momentum so that for fermions and ordinary bosons one has the standard behavior but for $N > 2$ non-standard so that these excitations are not seen as ordinary particles. Higher vertices are finite only if the total number N_F of fermions propagating in the loop satisfies $N_F > 3N - 4$. For instance, a 4-vertex from which $N = 2$ states emanate is finite.

Taking into account magnetic confinement

What has been said above is not quite enough. The weak form of electric-magnetic duality [B11] leads to the picture about elementary particles as pairs of magnetic monopoles inspiring the notions of weak confinement based on magnetic monopole force. Also color confinement would have magnetic counterpart. This means that elementary particles would behave like string like objects in weak boson length scale. Therefore one must also consider the stringy case with wormhole throats replaced with fermion- X_{\pm} pairs (X_{\pm} is electromagnetically neutral and \pm refers to the sign of the weak isospin opposite to that of fermion) and their super partners.

- (a) The simplest assumption in the stringy case is that fermion- X_{\pm} pairs behave as coherent objects, that is scatter elastically. In more general case only their higher excitations identifiable in terms of stringy degrees of freedom would be created in vertices. The massivation of these states makes possible non-collinear vertices. An open question is how the massivation fermion- X_{\pm} pairs relates to the existing TGD based description of massivation in terms of Higgs mechanism and modified Dirac operator.
- (b) Mass renormalization could come from self energy loops with negative energy lines as also vertex normalization. By very general arguments supersymmetry implies the cancellation of the self energy loops but would allow non-trivial vertex renormalization [K32].
- (c) If only 3-vertices are allowed, the loops containing only positive energy lines are possible if on mass shell fermion- X_{\pm} pair (or its superpartner) can decay to a pair of positive energy pair particles of same kind. Whether this is possible depends on the masses involved. For ordinary particles these decays are not kinematically possible below intermediate boson mass scale (the decays $F_1 \rightarrow F_2 + \gamma$ are forbidden kinematically or by the absence of flavor changing neutral currents whereas intermediate gauge bosons can decay to on mass shell fermion-antifermion pair).
- (d) The introduction of IR cutoff for 3-momentum in the rest system associated with the largest CD (causal diamond) looks natural as scale parameter of coupling constant evolution and p-adic length scale hypothesis favors the inverse of the size scale of CD coming in powers of two. This parameter would define the momentum resolution as a discrete parameter of the p-adic coupling constant evolution. This scale does not have any counterpart in standard physics. For electron, d quark, and u quark the proper time distance between the tips of CD corresponds to frequency of 10 Hz, 1280 Hz, and 160 Hz: all these frequencies define fundamental bio-rhythms [K26].

These considerations have left completely untouched one important aspect of generalized Feynman diagrams: the necessity to perform a functional integral over the deformations of the partonic 2-surfaces at the ends of the lines- that is integration over WCW. Number theoretical universality requires that WCW and these integrals make sense also p-adically and in the following these aspects of generalized Feynman diagrams are discussed.

4.7.3 How to define integration and p-adic Fourier analysis, integral calculus, and p-adic counterparts of geometric objects?

p-Adic differential calculus exists and obeys essentially the same rules as ordinary differential calculus. The only difference from real context is the existence of p-adic pseudoconstants:

any function which depends on finite number of binary digits has vanishing p-adic derivative. This implies non-determinism of p-adic differential equations. One can define p-adic integral functions using the fact that indefinite integral is the inverse of differentiation. The basis problem with the definite integrals is that p-adic numbers are not well-ordered so that the crucial ordering of the points of real axis in definite integral is not unique. Also p-adic Fourier analysis is problematic since direct counterparts of $\exp(ix)$ and trigonometric functions are not periodic. Also $\exp(-x)$ fails to converge exponentially since it has p-adic norm equal to 1. Note also that these functions exist only when the p-adic norm of x is smaller than 1.

The following considerations support the view that the p-adic variant of a geometric object, integration and p-adic Fourier analysis exists but only when one considers highly symmetric geometric objects such as symmetric spaces. This is welcome news from the point of view of physics. At the level of space-time surfaces this is problematic. The field equations associated with Kähler action and modified Dirac equation make sense. Kähler action defined as integral over p-adic space-time surface fails to exist. If however the Kähler function identified as Kähler for a preferred extremal of Kähler action is rational or algebraic function of preferred complex coordinates of WCW with rational coefficients, its p-adic continuation is expected to exist.

Circle with rotational symmetries and its hyperbolic counterparts

Consider first circle with emphasis on symmetries and Fourier analysis.

- (a) In this case angle coordinate ϕ is the natural coordinate. It however does not make sense as such p-adically and one must consider either trigonometric functions or the phase $\exp(i\phi)$ instead. If one wants to do Fourier analysis on circle one must introduce roots $U_{n,N} = \exp(in2\pi/N)$ of unity. This means discretization of the circle. Introducing all roots $U_{n,p} = \exp(i2\pi n/p)$, such that p divides N , one can represent all $U_{k,n}$ up to $n = N$. Integration is naturally replaced with sum by using discrete Fourier analysis on circle. Note that the roots of unity can be expressed as products of powers of roots of unity $\exp(in2\pi/p^k)$, where p^k divides N .
- (b) There is a number theoretical delicacy involved. By Fermat's theorem $a^{p-1} \bmod p = 1$ for $a = 1, \dots, p-1$ for a given p-adic prime so that for any integer M divisible by a factor of $p-1$ the M :th roots of unity exist as ordinary p-adic numbers. The problem disappears if these values of M are excluded from the discretization for a given value of the p-adic prime. The manner to achieve this is to assume that N contains no divisors of $p-1$ and is consistent with the notion of finite measurement resolution. For instance, $N = p^n$ is an especially natural choice guaranteeing this.
- (c) The p-adic integral defined as a Fourier sum does not reduce to a mere discretization of the real integral. In the real case the Fourier coefficients must approach to zero as the wave vector $k = n2\pi/N$ increases. In the p-adic case the condition consistent with the notion of finite measurement resolution for angles is that the p-adic valued Fourier coefficients approach to zero as n increases. This guarantees the p-adic convergence of the discrete approximation of the integral for large values of N as n increases. The map of p-adic Fourier coefficients to real ones by canonical identification could be used to relate p-adic and real variants of the function to each other.

This finding would suggest that p-adic geometries -in particular the p-adic counterpart of CP_2 , are discrete. Variables which have the character of a radial coordinate are in natural manner p-adically continuous whereas phase angles are naturally discrete and described in terms of algebraic extensions. The conclusion is disappointing since one can quite well argue that the discrete structures can be regarded as real. Is there any manner to escape this conclusion?

- (a) Exponential function $\exp(ix)$ exists p-adically for $|x|_p \leq 1/p$ but is not periodic. It provides representation of p-adic variant of circle as group $U(1)$. One obtains actually a hierarchy of groups $U(1)_{p,n}$ corresponding to $|x|_p \leq 1/p^n$. One could consider a generalization of phases as products $\text{Exp}_p(N, n2\pi/N + x) = \exp(in2\pi n/N)\exp(ix)$ of roots of unity and exponent functions with an imaginary exponent. This would assign to each root of unity

p-adic continuum interpreted as the analog of the interval between two subsequent roots of unity at circle. The hierarchies of measurement resolutions coming as $2\pi/p^n$ would be naturally accompanied by increasingly smaller p-adic groups $U(1)_{p,n}$.

- (b) p-Adic integration would involve summation plus possibly also an integration over each p-adic variant of discretization interval. The summation over the roots of unity implies that the integral of $\int \exp(ix)dx$ would appear for $n = 0$. Whatever the value of this integral is, it is compensated by a normalization factor guaranteeing orthonormality.
- (c) If one interprets the p-adic coordinate as p-adic integer without the identification of points differing by a multiple of n as different points the question whether one should require p-adic continuity arises. Continuity is obtained if $U_n(x + mp^m) = U_n(x)$ for large values of m . This is obtained if one has $n = p^k$. In the spherical geometry this condition is not needed and would mean quantization of angular momentum as $L = p^k$, which does not look natural. If representations of translation group are considered the condition is natural and conforms with the spirit of the p-adic length scale hypothesis.

The hyperbolic counterpart of circle corresponds to the orbit of point under Lorentz group in two 2-D Minkowski space. Plane waves are replaced with exponentially decaying functions of the coordinate η replacing phase angle. Ordinary exponent function $\exp(x)$ has unit p-adic norm when it exists so that it is not a suitable choice. The powers p^n existing for p-adic integers however approach to zero for large values of $x = n$. This forces discretization of η or rather the hyperbolic phase as powers of p^x , $x = n$. Also now one could introduce products of $\text{Exp}_p(n \log(p) + z) = p^n \exp(x)$ to achieve a p-adic continuum. Also now the integral over the discretization interval is compensated by orthonormalization and can be forgotten. The integral of exponential function would reduce to a sum $\int \text{Exp}_p dx = \sum_k p^k = 1/(1-p)$. One can also introduce finite-dimensional but non-algebraic extensions of p-adic numbers allowing e and its roots $e^{1/n}$ since e^p exists p-adically.

Plane with translational and rotational symmetries

Consider first the situation by taking translational symmetries as a starting point. In this case Cartesian coordinates are natural and Fourier analysis based on plane waves is what one wants to define. As in the previous case, this can be done using roots of unity and one can also introduce p-adic continuum by using the p-adic variant of the exponent function. This would effectively reduce the plane to a box. As already noticed, in this case the quantization of wave vectors as multiples of $1/p^k$ is required by continuity.

One can take also rotational symmetries as a starting point. In this case cylindrical coordinates (ρ, ϕ) are natural.

- (a) Radial coordinate can have arbitrary values. If one wants to keep the connection $\rho = \sqrt{x^2 + y^2}$ with the Cartesian picture square root allowing extension is natural. Also the values of radial coordinate proportional to odd power of p are problematic since one should introduce \sqrt{p} : is this extension internally consistent? Does this mean that the points $\rho \propto p^{2n+1}$ are excluded so that the plane decomposes to annuli?
- (b) As already found, angular momentum eigen states can be described in terms of roots of unity and one could obtain continuum by allowing also phases defined by p-adic exponent functions.
- (c) In radial direction one should define the p-adic variants for the integrals of Bessel functions and they indeed might make sense by algebraic continuation if one consistently defines all functions as Fourier expansions. Delta-function renormalization causes technical problems for a continuum of radial wave vectors. One could avoid the problem by using exponentially decaying variants of Bessel function in the regions far from origin, and here the already proposed description of the hyperbolic counterparts of plane waves is suggestive.
- (d) One could try to understand the situation also using Cartesian coordinates. In the case of sphere this is achieved by introducing two coordinate patches with Cartesian coordinates. Pythagorean phases are rational phases (orthogonal triangles for which all sides are integer

valued) and form a dense set on circle. Complex rationals (orthogonal triangles with integer valued short sides) define a more general dense subset of circle. In both cases it is difficult to imagine a discretized version of integration over angles since discretization with constant angle increment is not possible.

The case of sphere and more general symmetric space

In the case of sphere spherical coordinates are favored by symmetry considerations. For spherical coordinates $\sin(\theta)$ is analogous to the radial coordinate of plane. Legendre polynomials expressible as polynomials of $\sin(\theta)$ and $\cos(\theta)$ are expressible in terms of phases and the integration measure $\sin^2(\theta)d\theta d\phi$ reduces the integral of S^2 to summation. As before one can introduce also p-adic continuum. Algebraic cutoffs in both angular momentum l and m appear naturally. Similar cutoffs appear in the representations of quantum groups and there are good reasons to expect that these phenomena are correlated.

Exponent of Kähler function appears in the integration over configuration space. From the expression of Kähler gauge potential given by $A_\alpha = J_\alpha^\theta \partial_\theta K$ one obtains using $A_\alpha = \cos(\theta)\delta_{\alpha,\phi}$ and $J_{\theta\phi} = \sin(\theta)$ the expression $\exp(K) = \sin(\theta)$. Hence the exponent of Kähler function is expressible in terms of spherical harmonics.

The completion of the discretized sphere to a p-adic continuum- and in fact any symmetric space- could be performed purely group theoretically.

- (a) Exponential map maps the elements of the Lie-algebra to elements of Lie-group. This recipe generalizes to arbitrary symmetric space G/H by using the Cartan decomposition $g = t + h$, $[h, h] \subset h, [h, t] \subset t, [t, t] \subset h$. The exponentiation of t maps t to G/H in this case. The exponential map has a p-adic generalization obtained by considering Lie algebra with coefficients with p-adic norm smaller than one so that the p-adic exponent function exists. As a matter fact, one obtains a hierarchy of Lie-algebras corresponding to the upper bounds of the p-adic norm coming as p^{-k} and this hierarchy naturally corresponds to the hierarchy of angle resolutions coming as $2\pi/p^k$. By introducing finite-dimensional transcendental extensions containing roots of e one obtains also a hierarchy of p-adic Lie-algebras associated with transcendental extensions.
- (b) In particular, one can exponentiate the complement of the $SO(2)$ sub-algebra of $SO(3)$ Lie-algebra in p-adic sense to obtain a p-adic completion of the discrete sphere. Each point of the discretized sphere would correspond to a p-adic continuous variant of sphere as a symmetric space. Similar construction applies in the case of CP_2 . Quite generally, a kind of fractal or holographic symmetric space is obtained from a discrete variant of the symmetric space by replacing its points with the p-adic symmetric space.
- (c) In the N-fold discretization of the coordinates of M-dimensional space t one $(N - 1)^M$ discretization volumes which is the number of points with non-vanishing t -coordinates. It would be nice if one could map the p-adic discretization volumes with non-vanishing t -coordinates to their positive valued real counterparts by applying canonical identification. By group invariance it is enough to show that this works for a discretization volume assignable to the origin. Since the p-adic numbers with norm smaller than one are mapped to the real unit interval, the p-adic Lie algebra is mapped to the unit cell of the discretization lattice of the real variant of t . Hence by a proper normalization this mapping is possible.

The above considerations suggest that the hierarchies of measurement resolutions coming as $\Delta\phi = 2\pi/p^n$ are in a preferred role. One must be however cautious in order to avoid too strong assumptions. The following arguments however support this identification.

- (a) The vision about p-adicization characterizes finite measurement resolution for angle measurement in the most general case as $\Delta\phi = 2\pi M/N$, where M and N are positive integers having no common factors. The powers of the phases $\exp(i2\pi M/N)$ define identical Fourier basis irrespective of the value of M unless one allows only the powers $\exp(i2\pi kM/N)$ for which $kM < N$ holds true: in the latter case the measurement resolutions with different

values of M correspond to different numbers of Fourier components. Otherwise the measurement resolution is just $\Delta\phi = 2\pi/p^n$. If one regards N as an ordinary integer, one must have $N = p^n$ by the p-adic continuity requirement.

- (b) One can also interpret N as a p-adic integer and assume that state function reduction selects one particular prime (no superposition of quantum states with different p-adic topologies). For $N = p^n M$, where M is not divisible by p , one can express $1/M$ as a p-adic integer $1/M = \sum_{k \geq 0} M_k p^k$, which is infinite as a real integer but effectively reduces to a finite integer $K(p) = \sum_{k=0}^{N-1} M_k p^k$. As a root of unity the entire phase $\exp(i2\pi M/N)$ is equivalent with $\exp(i2\pi R/p^n)$, $R = K(p)M \pmod{p^n}$. The phase would non-trivial only for p-adic primes appearing as factors in N . The corresponding measurement resolution would be $\Delta\phi = R2\pi/N$. One could assign to a given measurement resolution all the p-adic primes appearing as factors in N so that the notion of multi-p p-adicity would make sense. One can also consider the identification of the measurement resolution as $\Delta\phi = |N/M|_p = 2\pi/p^k$. This interpretation is supported by the approach based on infinite primes [K79].

What about integrals over partonic 2-surfaces and space-time surface?

One can of course ask whether also the integrals over partonic 2-surfaces and space-time surface could be p-adicized by using the proposed method of discretization. Consider first the p-adic counterparts of the integrals over the partonic 2-surface X^2 .

- (a) WCW Hamiltonians and Kähler form are expressible using flux Hamiltonians defined in terms of X^2 integrals of JH_A , where H_A is $\delta CD \times CP_2$ Hamiltonian, which is a rational function of the preferred coordinates defined by the exponentials of the coordinates of the sub-space t in the appropriate Cartan algebra decomposition. The flux factor $J = \epsilon^{\alpha\beta} J_{\alpha\beta} \sqrt{g_2}$ is scalar and does not actually depend on the induced metric.
- (b) The notion of finite measurement resolution would suggest that the discretization of X^2 is somehow induced by the discretization of $\delta CD \times CP_2$. The coordinates of X^2 could be taken to be the coordinates of the projection of X^2 to the sphere S^2 associated with δM_{\pm}^4 or to the homologically non-trivial geodesic sphere of CP_2 so that the discretization of the integral would reduce to that for S^2 and to a sum over points of S^2 .
- (c) To obtain an algebraic number as an outcome of the summation, one must pose additional conditions guaranteeing that both H_A and J are algebraic numbers at the points of discretization (recall that roots of unity are involved). Assume for definiteness that S^2 is $r_M = \text{constant}$ sphere. If the remaining preferred coordinates are functions of the preferred S^2 coordinates mapping phases to phases at discretization points, one obtains the desired outcome. These conditions are rather strong and mean that the various angles defining CP_2 coordinates -at least the two cyclic angle coordinates- are integer multiples of those assignable to S^2 at the points of discretization. This would be achieved if the preferred complex coordinates of CP_2 are powers of the preferred complex coordinate of S^2 at these points. One could say that X^2 is algebraically continued from a rational surface in the discretized variant of $\delta CD \times CP_2$. Furthermore, if the measurement resolutions come as $2\pi/p^n$ as p-adic continuity actually requires and if they correspond to the p-adic group $G_{p,n}$ for which group parameters satisfy $|t|_p \leq p^{-n}$, one can precisely characterize how a p-adic prime characterizes the real partonic 2-surface. This would be a fulfilment of one of the oldest dreams related to the p-adic vision.

An even more ambitious dream would be that even the integral of the Kähler action for preferred extremals could be defined using a similar procedure. The conjectured slicing of Minkowskian space-time sheets by string world sheets and partonic 2-surfaces encourages these hopes.

- (a) One could introduce local coordinates of H at both ends of CD by introducing a continuous slicing of $M^4 \times CP_2$ by the translates of $\delta M_{\pm}^4 \times CP_2$ in the direction of the time-like vector connecting the tips of CD . As space-time coordinates one could select four of the eight coordinates defining this slicing. For instance, for the regions of the space-time sheet representable as maps $M^4 \rightarrow CP_2$ one could use the preferred M^4 time coordinate, the radial coordinate of δM_{\pm}^4 , and the angle coordinates of $r_M = \text{constant}$ sphere.

- (b) Kähler action density should have algebraic values and this would require the strengthening of the proposed conditions for X^2 to apply to the entire slicing meaning that the discretized space-time surface is a rational surface in the discretized $CD \times CP_2$. If this condition applies to the entire space-time surface it would effectively mean the discretization of the classical physics to the level of finite geometries. This seems quite strong implication but is consistent with the preferred extremal property implying the generalized Bohr rules. The reduction of Kähler action to 3-dimensional boundary terms is implied by rather general arguments. In this case only the effective algebraization of the 3-surfaces at the ends of CD and of wormhole throats is needed [K40]. By effective 2-dimensionality these surfaces cannot be chosen freely.
- (c) If Kähler function and WCW Hamiltonians are rational functions, this kind of additional conditions are not necessary. It could be that the integrals of defining Kähler action flux Hamiltonians make sense only in the intersection of real and p-adic worlds assumed to be relevant for the physics of living systems.

Tentative conclusions

These findings suggest following conclusions.

- (a) Exponent functions play a key role in the proposed p-adicization. This is not an accident since exponent functions play a fundamental role in group theory and p-adic variants of real geometries exist only under symmetries- possibly maximal possible symmetries- since otherwise the notion of Fourier analysis making possible integration does not exist. The inner product defined in terms of integration reduce for functions representable in Fourier basis to sums and can be carried out by using orthogonality conditions. Convolution involving integration reduces to a product for Fourier components. In the case of imbedding space and WCW these conditions are satisfied but for space-time surfaces this is not possible.
- (b) There are several manners to choose the Cartan algebra already in the case of sphere. In the case of plane one can consider either translations or rotations and this leads to different p-adic variants of plane. Also the realization of the hierarchy of Planck constants leads to the conclusion that the extended imbedding space and therefore also WCW contains sectors corresponding to different choices of quantization axes meaning that quantum measurement has a direct geometric correlate.
- (c) The above described 2-D examples represent symplectic geometries for which one has natural decomposition of coordinates to canonical pairs of cyclic coordinate (phase angle) and corresponding canonical conjugate coordinate. p-Adicization depends on whether the conjugate corresponds to an angle or noncompact coordinate. In both cases it is however possible to define integration. For instance, in the case of CP_2 one would have two canonically conjugate pairs and one can define the p-adic counterparts of CP_2 partial waves by generalizing the procedure applied to spherical harmonics. Products of functions expressible using partial waves can be decomposed by tensor product decomposition to spherical harmonics and can be integrated. In particular inner products can be defined as integrals. The Hamiltonians generating isometries are rational functions of phases: this inspires the hope that also WCW Hamiltonians also rational functions of preferred WCW coordinates and thus allow p-adic variants.
- (d) Discretization by introducing algebraic extensions is unavoidable in the p-adicization of geometrical objects but one can have p-adic continuum as the analog of the discretization interval and in the function basis expressible in terms of phase factors and p-adic counterparts of exponent functions. This would give a precise meaning for the p-adic counterparts of the imbedding space and WCW if the latter is a symmetric space allowing coordinatization in terms of phase angles and conjugate coordinates.
- (e) The intersection of p-adic and real worlds would be unique and correspond to the points defining the discretization.

4.7.4 Harmonic analysis in WCW as a manner to calculate WCW functional integrals

Previous examples suggest that symmetric space property, Kähler and symplectic structure and the use of symplectic coordinates consisting of canonically conjugate pairs of phase angles and corresponding "radial" coordinates are essential for WCW integration and p-adicization. Kähler function, the components of the metric, and therefore also metric determinant and Kähler function depend on the "radial" coordinates only and the possible generalization involves the identification the counterparts of the "radial" coordinates in the case of WCW.

Conditions guaranteing the reduction to harmonic analysis

The basic idea is that harmonic analysis in symmetric space allows to calculate the functional integral over WCW.

- (a) Each propagator line corresponds to a symmetric space defined as a coset space G/H of the symplectic group and Kac-Moody group and one might hope that the proposed p-adicization works for it- at least when one considers the hierarchy of measurement resolutions forced by the finiteness of algebraic extensions. This coset space is as a manifold Cartesian product $(G/H) \times (G/H)$ of symmetric spaces G/H associated with ends of the line. Kähler metric contains also an interaction term between the factors of the Cartesian product so that Kähler function can be said to reduce to a sum of "kinetic" terms and interaction term.
- (b) Effective 2-dimensionality and ZEO allow to treat the ends of the propagator line independently. This means an enormous simplification. Each line contributes besides propagator a piece to the exponent of Kähler action identifiable as interaction term in action and depending on the propagator momentum. This contribution should be expressible in terms of generalized spherical harmonics. Essentially a sum over the products of pairs of harmonics associated with the ends of the line multiplied by coefficients analogous to $1/(p^2 - m^2)$ in the case of the ordinary propagator would be in question. The optimal situation is that the pairs are harmonics and their conjugates appear so that one has invariance under G analogous to momentum conservation for the lines of ordinary Feynman diagrams.
- (c) Momentum conservation correlates the eigenvalue spectra of the modified Dirac operator D at propagator lines [K19]. G -invariance at vertex dictates the vertex as the singlet part of the product of WCW harmonics associated with the vertex and one sums over the harmonics for each internal line. p-Adicization means only the algebraic continuation to real formulas to p-adic context.
- (d) The exponent of Kähler function depends on both ends of the line and this means that the geometries at the ends are correlated in the sense that that Kähler form contains interaction terms between the line ends. It is however not quite clear whether it contains separate "kinetic" or self interaction terms assignable to the line ends. For Kähler function the kinetic and interaction terms should have the following general expressions as functions of complex WCW coordinates:

$$\begin{aligned}
 K_{kin,i} &= \sum_n f_{i,n}(Z_i) \overline{f_{i,n}(Z_i)} + c.c. , \\
 K_{int} &= \sum_n g_{1,n}(Z_1) \overline{g_{2,n}(Z_2)} + c.c. , i = 1, 2 .
 \end{aligned}
 \tag{4.7.2}$$

Here $K_{kin,i}$ define "kinetic" terms and K_{int} defines interaction term. One would have what might be called holomorphic factorization suggesting a connection with conformal field theories.

Symmetric space property -that is isometry invariance- suggests that one has

$$f_{i,n} = f_{2,n} \equiv f_n , \quad g_{1,n} = g_{2,n} \equiv g_n
 \tag{4.7.3}$$

such that the products are invariant under the group H appearing in G/H and therefore have opposite H quantum numbers. The exponent of Kähler function does not factorize although the terms in its Taylor expansion factorize to products whose factors are products of holomorphic and antiholomorphic functions.

- (e) If one assumes that the exponent of Kähler function reduces to a product of eigenvalues of the modified Dirac operator eigenvalues must have the decomposition

$$\lambda_k = \prod_{i=1,2} \exp \left[\sum_n c_{k,n} g_n(Z_i) \overline{g_n(Z_i)} + c.c \right] \times \exp \left[\sum_n d_{k,n} g_n(Z_1) \overline{g_n(Z_2)} + c.c \right] \quad (4.4)$$

Hence also the eigenvalues coming from the Dirac propagators have also expansion in terms of G/H harmonics so that in principle WCW integration would reduce to Fourier analysis in symmetric space.

Generalization of WCW Hamiltonians

This picture requires a generalization of the view about configuration space Hamiltonians since also the interaction term between the ends of the line is present not taken into account in the previous approach.

- (a) The proposed representation of WCW Hamiltonians as flux Hamiltonians [K20, K19]

$$\begin{aligned} Q(H_A) &= \int H_A(1 + K) J d^2x \ , \\ J &= e^{\alpha\beta} J_{\alpha\beta} \ , \ J^{03} \sqrt{g_4} = K J_{12} \ . \end{aligned} \quad (4.7.5)$$

works for the kinetic terms only since J cannot be the same at the ends of the line. The formula defining K assumes weak form of self-duality (⁰³ refers to the coordinates in the complement of X^2 tangent plane in the 4-D tangent plane). K is assumed to be symplectic invariant and constant for given X^2 . The condition that the flux of $F^{03} = (\hbar/g_K) J^{03}$ defining the counterpart of Kähler electric field equals to the Kähler charge g_K gives the condition $K = g_K^2/\hbar$, where g_K is Kähler coupling constant. Within experimental uncertainties one has $\alpha_K = g_K^2/4\pi\hbar_0 = \alpha_{em} \simeq 1/137$, where α_{em} is finite structure constant in electron length scale and \hbar_0 is the standard value of Planck constant.

The assumption that Poisson bracket of WCW Hamiltonians reduces to the level of imbedding space - in other words $\{Q(H_A), Q(H_B)\} = Q(\{H_A, H_B\})$ - can be justified. One starts from the representation in terms of say flux Hamiltonians $Q(H_A)$ and defines $J_{A,B}$ as $J_{A,B} \equiv Q(\{H_A, H_B\})$. One has $\partial H_A/\partial t_B = \{H_B, H_A\}$, where t_B is the parameter associated with the exponentiation of H_B . The inverse $J^{A,B}$ of $J_{A,B} = \partial H_B/\partial t_A$ is expressible as $J^{A,B} = \partial t_A/\partial H_B$. From these formulas one can deduce by using chain rule that the bracket $\{Q(H_A), Q(H_B)\} = \partial t_C Q(H_A) J^{CD} \partial t_D Q(H_B)$ of flux Hamiltonians equals to the flux Hamiltonian $Q(\{H_A, H_B\})$.

- (b) One should be able to assign to WCW Hamiltonians also a part corresponding to the interaction term. The symplectic conjugation associated with the interaction term permutes the WCW coordinates assignable to the ends of the line. One should reduce this apparently non-local symplectic conjugation (if one thinks the ends of line as separate objects) to a non-local symplectic conjugation for $\delta CD \times CP_2$ by identifying the points of lower and upper end of CD related by time reflection and assuming that conjugation corresponds to time reflection. Formally this gives a well defined generalization of the local Poisson brackets between time reflected points at the boundaries of CD . The connection of Hermitian conjugation and time reflection in quantum field theories is in accordance with this picture.

- (c) The only manner to proceed is to assign to the flux Hamiltonian also a part obtained by the replacement of the flux integral over X^2 with an integral over the projection of X^2 to a sphere S^2 assignable to the light-cone boundary or to a geodesic sphere of CP_2 , which come as two varieties corresponding to homologically trivial and non-trivial spheres. The projection is defined as by the geodesic line orthogonal to S^2 and going through the point of X^2 . The hierarchy of Planck constants assigns to CD a preferred geodesic sphere of CP_2 as well as a unique sphere S^2 as a sphere for which the radial coordinate r_M or the light-cone boundary defined uniquely is constant: this radial coordinate corresponds to spherical coordinate in the rest system defined by the time-like vector connecting the tips of CD . Either spheres or possibly both of them could be relevant.

Recall that also the construction of number theoretic braids and symplectic QFT [K22] led to the proposal that braid diagrams and symplectic triangulations could be defined in terms of projections of braid strands to one of these spheres. One could also consider a weakening for the condition that the points of the number theoretic braid are algebraic by requiring only that the S^2 coordinates of the projection are algebraic and that these coordinates correspond to the discretization of S^2 in terms of the phase angles associated with θ and ϕ .

This gives for the corresponding contribution of the WCW Hamiltonian the expression

$$Q(H_A)_{int} = \int_{S^2_{\pm}} H_A X \delta^2(s_+, s_-) d^2 s_{\pm} = \int_{P(X^2_{\pm}) \cap P(X^2)} \frac{\partial(s^1, s^2)}{\partial(x^1_{\pm}, x^2_{\pm})} d^2 x_{\pm} . \quad (4.7.6)$$

Here the Poisson brackets between ends of the line using the rules involve delta function $\delta^2(s_+, s_-)$ at S^2 and the resulting Hamiltonians can be expressed as a similar integral of $H_{[A,B]}$ over the upper or lower end since the integral is over the intersection of S^2 projections.

The expression must vanish when the induced Kähler form vanishes for either end. This is achieved by identifying the scalar X in the following manner:

$$\begin{aligned} X &= J_+^{kl} J_{kl}^- , \\ J_{\pm}^{kl} &= (1 + K_{\pm}) \partial_{\alpha} s^k \partial_{\beta} s^l J_{\pm}^{\alpha\beta} . \end{aligned} \quad (4.7.7)$$

The tensors are lifts of the induced Kähler form of X^2_{\pm} to S^2 (not CP_2).

- (d) One could of course ask why these Hamiltonians could not contribute also to the kinetic terms and why the brackets with flux Hamiltonians should vanish. This relate to how one *defines* the Kähler form. It was shown above that in case of flux Hamiltonians the definition of Kähler form as brackets gives the basic formula $\{Q(H_A), Q(H_B)\} = Q(\{H_A, H_B\})$ and same should hold true now. In the recent case $J_{A,B}$ would contain an interaction term defined in terms of flux Hamiltonians and the previous argument should go through also now by identifying Hamiltonians as sums of two contributions and by introducing the doubling of the coordinates t_A .
- (e) The quantization of the modified Dirac operator must be reconsidered. It would seem that one must add to the super-Hamiltonian completely analogous term obtained by replacing $(1+K)J$ with $X \partial(s^1, s^2) / \partial(x^1_{\pm}, x^2_{\pm})$. Besides the anticommutation relations defining correct anticommutators to flux Hamiltonians, one should pose anticommutation relations consistent with the anticommutation relations of super Hamiltonians. In these anticommutation relations $(1+K)J \delta^2(x, y)$ would be replaced with $X \delta^2(s^+, s^-)$. This would guarantee that the oscillator operators at the ends of the line are not independent and that the resulting Hamiltonian reduces to integral over either end for $H_{[A,B]}$.
- (f) In the case of CP_2 the Hamiltonians generating isometries are rational functions. This should hold true also now so that p-adic variants of Hamiltonians as functions in WCW would make sense. This in turn would imply that the components of the WCW Kähler form are rational functions. Also the exponentiation of Hamiltonians make sense p-adically if one allows the exponents of group parameters to be functions $Exp_p(t)$.

Does the expansion in terms of partial harmonics converge?

The individual terms in the partial wave expansion seem to be finite but it is not at all clear whether the expansion in powers of K actually converges.

- (a) In the proposed scenario one performs the expansion of the vacuum functional $exp(K)$ in powers of K and therefore in negative powers of α_K . In principle an infinite number of terms can be present. This is analogous to the perturbative expansion based on using magnetic monopoles as basic objects whereas the expansion using the contravariant Kähler metric as a propagator would be in positive powers of α_K and analogous to the expansion in terms of magnetically bound states of wormhole throats with vanishing net value of magnetic charge. At this moment one can only suggest various approaches to how one could understand the situation.
- (b) Weak form of self-duality and magnetic confinement could change the situation. Performing the perturbation around magnetic flux tubes together with the assumed slicing of the space-time sheet by stringy world sheets and partonic 2-surfaces could mean that the perturbation corresponds to the action assignable to the electric part of Kähler form proportional to α_K by the weak self-duality. Hence by $K = 4\pi\alpha_K$ relating Kähler electric field to Kähler magnetic field the expansion would come in powers of a term containing sum of terms proportional to α_K^0 and α_K . This would leave to the scattering amplitudes the exponents of Kähler function at the maximum of Kähler function so that the non-analytic dependence on α_K would not disappear.

A further reason to be worried about is that the expansion containing infinite number of terms proportional to α_K^0 could fail to converge.

- (a) This could be also seen as a reason for why magnetic singlets are unavoidable except perhaps for $\hbar < \hbar_0$. By the holomorphic factorization the powers of the interaction part of Kähler action in powers of $1/\alpha_K$ would naturally correspond to increasing and opposite net values of the quantum numbers assignable to the WCW phase coordinates at the ends of the propagator line. The magnetic bound states could have similar expansion in powers of α_K as pairs of states with arbitrarily high but opposite values of quantum numbers. In the functional integral these quantum numbers would compensate each other. The functional integral would leave only an expansion containing powers of α_K starting from some finite possibly negative (unless one assumes the weak form of self-duality) power. Various gauge coupling strengths are expected to be proportional to α_K and these expansions should reduce to those in powers of α_K .
- (b) Since the number of terms in the fermionic propagator expansion is finite, one might hope on basis of super-symmetry that the same is true in the case of the functional integral expansion. By the holomorphic factorization the expansion in powers of K means the appearance of terms with increasingly higher quantum numbers. Quantum number conservation at vertices would leave only a finite number of terms to tree diagrams. In the case of loop diagrams pairs of particles with opposite and arbitrarily high values of quantum numbers could be generated at the vertex and magnetic confinement might be necessary to guarantee the convergence. Also super-symmetry could imply cancellations in loops.

Could one do without flux Hamiltonians?

The fact that the Kähler functions associated with the propagator lines can be regarded as interaction terms inspires the question whether the Kähler function could contain only the interaction terms so that Kähler form and Kähler metric would have components only between the ends of the lines.

- (a) The basic objection is that flux Hamiltonians too beautiful objects to be left without any role in the theory. One could also argue that the WCW metric would not be positive definite if only the non-diagonal interaction term is present. The simplest example is Hermitian 2×2 -matrix with vanishing diagonal for which eigenvalues are real but of opposite sign.

- (b) One could of course argue that the expansions of $\exp(K)$ and λ_k give in the general powers $(f_n f_n)^m$ analogous to diverging tadpole diagrams of quantum field theories due to local interaction vertices. These terms do not produce divergences now but the possibility that the exponential series of this kind of terms could diverge cannot be excluded. The absence of the kinetic terms would allow to get rid of these terms and might be argued to be the symmetric space counterpart for the vanishing of loops in WCW integral.
- (c) In zero energy ontology this idea does not look completely non-sensical since physical states are pairs of positive and negative energy states. Note also that in quantum theory only creation operators are used to create positive energy states. The manifest non-locality of the interaction terms and absence of the counterparts of kinetic terms would provide a trivial manner to get rid of infinities due to the presence of local interactions. The safest option is however to keep both terms.

Summary

The discussion suggests that one must treat the entire Feynman graph as single geometric object with Kähler geometry in which the symmetric space is defined as product of what could be regarded as analogs of symmetric spaces with interaction terms of the metric coming from the propagator lines. The exponent of Kähler function would be the product of exponents associated with all lines and contributions to lines depend on quantum numbers (momentum and color quantum numbers) propagating in line via the coupling to the modified Dirac operator. The conformal factorization would allow the reduction of integrations to Fourier analysis in symmetric space. What is of decisive importance is that the entire Feynman diagrammatics at WCW level would reduce to the construction of WCW geometry for a single propagator line as a function of quantum numbers propagating on the line.

Chapter 5

Coupling Constant Evolution in Quantum TGD

5.1 Introduction

In quantum TGD two kinds of discrete coupling constant evolutions emerge. p-Adic coupling constant evolution is with respect to the discrete hierarchy of p-adic length scales and p-adic length scale hypothesis suggests that only the length scales coming as half octaves of a fundamental length scale are relevant here. Second coupling constant evolution corresponds to hierarchy of Planck constants requiring a generalization of the notion of imbedding space. One can assign this evolution with angle resolution in number theoretic approach.

The notion of zero energy ontology allows to justify p-adic length scale hypothesis and formulate the discrete coupling constant evolution at fundamental level. Configuration space would consist of sectors which correspond to causal diamonds (*CDs*) identified as intersections of future and past directed light-cones. If the sizes of *CDs* come in powers of 2^n , p-adic length scale hypothesis emerges, and coupling constant evolution is discrete provided RG invariance holds true inside *CDs* for space-time evolution of coupling constants defined in some sense to be defined. In this chapter arguments supporting this conclusion are given by starting from a detailed vision about the basic properties of preferred extremals of Kähler action.

How to calculate the correlation functions and coupling constant evolution has remained a basic unresolved challenge. The latest (means the end of 2012) and perhaps the most powerful idea hitherto is quantum classical correspondence in statistical sense stating that the statistical properties of a preferred extremal in quantum superposition of them are same as those of the zero energy state in question. This principle would be quantum generalization of ergodic theorem stating that the time evolution of a single member of ensemble represents the ensemble statistically. This principle would allow to deduce correlation functions and S-matrix from the statistical properties of single preferred extremal alone using classical intuition. Also coupling constant evolution would be coded by the statistical properties of the representative preferred extremal.

The chapter decomposes into two parts. In the first part basic notions are introduced and a general vision about p-adic coupling constant evolution is introduced. After that a general formulation of coupling constant evolution at space-time level and related interpretational issues are considered. In the second part quantitative predictions involving some far from rigorous arguments, which I however dare to take rather seriously, are discussed. It must be emphasized that this chapter like many others is more like a still continuing story about development of ideas - not a brief summary about a solution of a precisely defined problem. There are many ad hoc ideas and conflicting views. These books are just lab note books - nothing more.

5.1.1 Geometric ideas

TGD relies heavily on geometric ideas, which have gradually generalized during the years. Symmetries play a key role as one might expect on basis of general definition of geometry as a structure characterized by a given symmetry.

Physics as infinite-dimensional Kähler geometry

- (a) The basic idea is that it is possible to reduce quantum theory to configuration space geometry and spinor structure. The geometrization of loop spaces inspires the idea that the mere existence of Riemann connection fixes configuration space Kähler geometry uniquely. Accordingly, configuration space can be regarded as a union of infinite-dimensional symmetric spaces labeled by zero modes labeling classical non-quantum fluctuating degrees of freedom.

The huge symmetries of the configuration space geometry deriving from the light-likeness of 3-surfaces and from the special conformal properties of the boundary of 4-D light-cone would guarantee the maximal isometry group necessary for the symmetric space property. Quantum criticality is the fundamental hypothesis allowing to fix the Kähler function and thus dynamics of TGD uniquely. Quantum criticality leads to surprisingly strong predictions about the evolution of coupling constants.

- (b) Configuration space spinors correspond to Fock states and anti-commutation relations for fermionic oscillator operators correspond to anti-commutation relations for the gamma matrices of the configuration space. Configuration space gamma matrices contracted with Killing vector fields give rise to a super-algebra which together with Hamiltonians of the configuration space forms what I have used to called super-symplectic algebra.

Super-symplectic degrees of freedom represent completely new degrees of freedom and have no electroweak couplings. In the case of hadrons super-symplectic quanta correspond to what has been identified as non-perturbative sector of QCD they define TGD correlate for the degrees of freedom assignable to hadronic strings. They are responsible for the most of the mass of hadron and resolve spin puzzle of proton.

Besides super-symplectic symmetries there are Super-Kac Moody symmetries assignable to light-like 3-surfaces and together these algebras extend the conformal symmetries of string models to dynamical conformal symmetries instead of mere gauge symmetries. The construction of the representations of these symmetries is one of the main challenges of quantum TGD. The assumption that the commutator algebra of these super-symplectic and super Kac-Moody algebras annihilates physical states gives rise to Super Virasoro conditions which could be regarded as analogs of configuration space Dirac equation.

Modular invariance is one aspect of conformal symmetries and plays a key role in the understanding of elementary particle vacuum functionals and the description of family replication phenomenon in terms of the topology of partonic 2-surfaces.

- (c) Configuration space spinors define a von Neumann algebra known as hyper-finite factor of type II_1 (HFFs). This realization has led also to a profound generalization of quantum TGD through a generalization of the notion of imbedding space to characterize quantum criticality. The resulting space has a book like structure with various almost-copies of imbedding space representing the pages of the book meeting at quantum critical sub-manifolds. The outcome of this approach is that the exponents of Kähler function and Chern-Simons action are not fundamental objects but reduce to the Dirac determinant associated with the modified Dirac operator assigned to the light-like 3-surfaces.

p-Adic physics as physics of cognition and intentionality

p-Adic mass calculations relying on p-adic length scale hypothesis led to an understanding of elementary particle masses using only super-conformal symmetries and p-adic thermodynamics. The need to fuse real physics and various p-adic physics to single coherent whole led to a generalization of the notion of number obtained by gluing together reals and p-adics together

along common rationals and algebraics. The interpretation of p-adic space-time sheets is as correlates for cognition and intentionality. p-Adic and real space-time sheets intersect along common rationals and algebraics and the subset of these points defines what I call number theoretic braid in terms of which both configuration space geometry and S-matrix elements should be expressible. Thus one would obtain number theoretical discretization which involves no adhoc elements and is inherent to the physics of TGD.

Perhaps the most dramatic implication relates to the fact that points, which are p-adically infinitesimally close to each other, are infinitely distant in the real sense (recall that real and p-adic imbedding spaces are glued together along rational imbedding space points). This means that any open set of p-adic space-time sheet is discrete and of infinite extension in the real sense. This means that cognition is a cosmic phenomenon and involves always discretization from the point of view of the real topology. The testable physical implication of effective p-adic topology of real space-time sheets is p-adic fractality meaning characteristic long range correlations combined with short range chaos.

Also a given real space-time sheets should correspond to a well-defined prime or possibly several of them. The classical non-determinism of Kähler action should correspond to p-adic non-determinism for some prime(s) p in the sense that the effective topology of the real space-time sheet is p-adic in some length scale range. p-Adic space-time sheets with same prime should have many common rational points with the real space-time and be easily transformable to the real space-time sheet in quantum jump representing intention-to-action transformation. The concrete model for the transformation of intention to action leads to a series of highly non-trivial number theoretical conjectures assuming that the extensions of p-adics involved are finite-dimensional and can contain also transcendentals.

An ideal realization of the space-time sheet as a cognitive representation results if the CP_2 coordinates as functions of M_+^4 coordinates have the same functional form for reals and various p-adic number fields and that these surfaces have discrete subset of rational numbers with upper and lower length scale cutoffs as common. The hierarchical structure of cognition inspires the idea that S-matrices form a hierarchy labeled by primes p and the dimensions of algebraic extensions.

The number-theoretic hierarchy of extensions of rationals appears also at the level of configuration space spinor fields and allows to replace the notion of entanglement entropy based on Shannon entropy with its number theoretic counterpart having also negative values in which case one can speak about genuine information. In this case case entanglement is stable against Negentropy Maximization Principle stating that entanglement entropy is minimized in the self measurement and can be regarded as bound state entanglement. Bound state entanglement makes possible macro-temporal quantum coherence. One can say that rationals and their finite-dimensional extensions define islands of order in the chaos of continua and that life and intelligence correspond to these islands.

TGD inspired theory of consciousness and number theoretic considerations inspired for years ago the notion of infinite primes [K79] . It came as a surprise, that this notion might have direct relevance for the understanding of mathematical cognition. The ideas is very simple. There is infinite hierarchy of infinite rationals having real norm one but different but finite p-adic norms. Thus single real number (complex number, (hyper-)quaternion, (hyper-)octonion) corresponds to an algebraically infinite-dimensional space of numbers equivalent in the sense of real topology. Space-time and imbedding space points ((hyper-)quaternions, (hyper-)octonions) become infinitely structured and single space-time point would represent the Platonia of mathematical ideas. This structure would be completely invisible at the level of real physics but would be crucial for mathematical cognition and explain why we are able to imagine also those mathematical structures which do not exist physically. Space-time could be also regarded as an algebraic hologram. The connection with Brahman=Atman idea is also obvious.

Hierarchy of Planck constants and dark matter hierarchy

The work with hyper-finite factors of type II_1 (HFFs) combined with experimental input led to the notion of hierarchy of Planck constants interpreted in terms of dark matter [K30] . The

hierarchy is realized via a generalization of the notion of imbedding space obtained by gluing infinite number of its variants along common lower-dimensional quantum critical sub-manifolds. These variants of imbedding space are characterized by discrete subgroups of $SU(2)$ acting in M^4 and CP_2 degrees of freedom as either symmetry groups or homotopy groups of covering. Among other things this picture implies a general model of fractional quantum Hall effect.

This framework also leads to the identification of number theoretical braids as points of partonic 2-surface which correspond to the minima of a generalized eigenvalue of Dirac operator, a scalar field to which Higgs vacuum expectation is proportional to. Higgs vacuum expectation has thus a purely geometric interpretation. The outcome is an explicit formula for the Dirac determinant consistent with the vacuum degeneracy of Kähler action and its finiteness and algebraic number property required by p-adicization requiring number theoretic universality. The zeta function associated with the eigenvalues (rather than Riemann Zeta as believed originally) in turn defines the super-symplectic conformal weights as its zeros so that a highly coherent picture result.

What is especially remarkable is that the construction gives also the 4-D space-time sheets associated with the light-like orbits of the partonic 2-surfaces: it remains to be shown whether they correspond to preferred extremals of Kähler action. It is clear that the hierarchy of Planck constants has become an essential part of the construction of quantum TGD and of mathematical realization of the notion of quantum criticality rather than a possible generalization of TGD.

Number theoretical symmetries

TGD as a generalized number theory vision leads to the idea that also number theoretical symmetries are important for physics.

- (a) There are good reasons to believe that the strands of number theoretical braids can be assigned with the roots of a polynomial which suggests the interpretation corresponding Galois groups as purely number theoretical symmetries of quantum TGD. Galois groups are subgroups of the permutation group S_∞ of infinitely many objects acting as the Galois group of algebraic numbers. The group algebra of S_∞ is HFF which can be mapped to the HFF defined by configuration space spinors. This picture suggests a number theoretical gauge invariance stating that S_∞ acts as a gauge group of the theory and that global gauge transformations in its completion correspond to the elements of finite Galois groups represented as diagonal groups of $G \times G \times \dots$ of the completion of S_∞ . The groups G should relate closely to finite groups defining inclusions of HFFs.
- (b) HFFs inspire also an idea about how entire TGD emerges from classical number fields, actually their complexifications. In particular, $SU(3)$ acts as subgroup of octonion automorphisms leaving invariant preferred imaginary unit and $M^4 \times CP_2$ can be interpreted as a structure related to hyper-octonions which is a subspace of complexified octonions for which metric has naturally Minkowski signature. This would mean that TGD could be seen also as a generalized number theory. This conjecture predicts the existence of two dual formulations of TGD based on the identification space-times as 4-surfaces in hyper-octonionic space M^8 *resp.* $M^4 \times CP_2$.
- (c) The vision about TGD as a generalized number theory involves also the notion of infinite primes. This notion leads to a further generalization of the ideas about geometry: this time the notion of space-time point generalizes so that it has an infinitely complex number theoretical anatomy not visible in real topology.

Could quantum ergodicity allow to calculate correlation functions and coupling constant evolution from the statistical properties of preferred extremals?

How to calculate the correlation functions and coupling constant evolution has remained a basic unresolved challenge. Generalized Feynman diagrams provide a powerful vision which however does not help in practical calculations. Some big idea has been lacking.

The latest (means the end of year 2012) and perhaps the most powerful idea hitherto is quantum classical correspondence in statistical sense stating that the statistical properties of a preferred

extremal in quantum superposition of them are same as those of the zero energy state in question. All preferred extremals in the superposition would have same correlation functions coding for S-matrix. This principle would be a quantum generalization of ergodic theorem stating that the time evolution of a single member of ensemble represents the ensemble statistically. This symmetry principle analogous to holography might allow to fix S-matrix uniquely even in the case that the hermitian square root of the density matrix appearing in the M-matrix would lead to a breaking of quantum ergodicity as also 4-D spin glass degeneracy suggests.

This principle would allow to deduce correlation functions from the statistical properties of single preferred extremal alone using just classical intuition. Also coupling constant evolution would be coded by the statistical properties of preferred extremals. Quantum ergodicity would mean an enormous simplification since one could avoid the horrible conceptual complexities involved with the functional integrals over WCW.

5.1.2 The construction of M-matrix

The construction of S-matrix involves several ideas that have emerged during last years and involve symmetries in an essential manner.

Zero energy ontology

Zero energy ontology motivated originally by TGD inspired cosmology means that physical states have vanishing conserved net quantum numbers and are decomposable to positive and negative energy parts separated by a temporal distance characterizing the system as a space-time sheet of finite size in time direction. The particle physics interpretation is as initial and final states of a particle reaction. Obviously a profound modification of existing views about realization of symmetries is in question.

S-matrix and density matrix are unified to the notion of M-matrix defining time-like entanglement and expressible as a product of square root of density matrix and of unitary S-matrix. Thermodynamics becomes therefore a part of quantum theory. One must distinguish M-matrix from U-matrix defined between zero energy states and analogous to S-matrix and characterizing the unitary process associated with quantum jump. U-matrix is most naturally related to the description of intentional action since in a well-defined sense it has elements between physical systems corresponding to different number fields.

Quantum TGD as almost topological QFT

Light-likeness of the basic fundamental objects suggests that TGD is almost topological QFT so that the formulation in terms of category theoretical notions is expected to work. The original proposal that Chern-Simons action for light-like 3-surfaces defined by the regions at which the signature of the induced metric changes its sign however failed and one must use Kähler action and corresponding modified Dirac action with measurement term to define the fundamental theory. At the limit when the momenta of particles vanish, the theory reduces to topological QFT defined by Kähler action and corresponding modified Dirac action. The imaginary exponent of the instanton term associated with the induced Kähler form defines the counterpart of Chern-Simons action as a phase of the vacuum functional and contributes also to modified Dirac equation.

M-matrices form in a natural manner a functor from the category of cobordisms to the category of pairs of Hilbert spaces and this gives additional strong constraints on the theory. Superconformal symmetries implied by the light-likeness pose very strong constraints on both state construction and on M-matrix and U-matrix. The notions of n-category and n-groupoid which represents a generalization of the notion of group could be very relevant to this view about M-matrix.

Quantum measurement theory with finite measurement resolution

The notion of measurement resolution represented in terms of inclusions $\mathcal{N} \subset \mathcal{M}$ of HFFs is an essential element of the picture. Measurement resolution corresponds to the action of the included sub-algebra creating zero energy states in time scales shorter than the cutoff scale. This means that complex rays of state space are effectively replaced with \mathcal{N} rays. The condition that the action of \mathcal{N} commutes with the M-matrix is a powerful symmetry and implies that the time-like entanglement characterized by M-matrix is consistent with Connes tensor product. This does not fix the M-matrix as was the original belief but only realizes mathematically the notion of finite measurement resolution. Together with super-conformal symmetries this constraint should fix possible M-matrices to a very high degree if one assumes the existence of universal M-matrix from which M-matrices with finite measurement resolution are obtained.

The notion of number theoretical braid realizes the notion of finite measurement resolution at space-time level and gives a direct connection to topological QFTs describing braids. The connection with quantum groups is highly suggestive since already the inclusions of HFFs involve these groups. Effective non-commutative geometry for the quantum critical sub-manifolds $M^2 \subset M^4$ and $S^2 \subset CP_2$ might provide an alternative notion for the reduction of stringy anti-commutation relations for induced spinor fields to anti-commutations at the points of braids.

Generalization of Feynman diagrams

An essential difference between TGD and string models is the replacement of stringy diagrams with generalized Feynman diagrams obtained by gluing 3-D light-like surfaces (instead of lines) together at their ends represented as partonic 2-surfaces. This makes the construction of vertices very simple. The notion of number theoretic braid in turn implies discretization having also interpretation in terms of non-commutativity due to finite measurement resolution replacing anti-commutativity along stringy curves with anti-commutativity at points of braids. Braids can replicate at vertices which suggests an interpretation in terms of topological quantum computation combined with non-faithful copying and communication of information. The analogs of stringy diagrams have quite different interpretation in TGD for instance, photons traveling via two different paths in double slit experiment are represented in terms of stringy branching of the photonic 2-surface.

Symplectic variant of QFT as basic building block of construction

The latest discovery related to the construction of M-matrix was the realization that a symplectic variant of conformal field theories might be a further key element in the concrete construction of n-point functions and M-matrix in zero energy ontology. Although I have known super-symplectic (super-symplectic) symmetries to be fundamental symmetries of quantum TGD for almost two decades, I failed for some reason to realize the existence of symplectic QFT, and discovered it while trying to understand quite different problem - the fluctuations of cosmic microwave background! The symplectic contribution to the n-point function satisfies fusion rules and involves only variables which are symplectic invariants constructed using geodesic polygons assignable to the sub-polygons of n-polygon defined by the arguments of n-point function. Fusion rules lead to a concrete recursive formula for n-point functions and M-matrix in contrast to the iterative construction of n-point functions used in perturbative QFT.

Bosonic emergence, extended space-time supersymmetry, and generalized twistors

During year 2009 several new ideas emerged and give hopes about a concrete construction of M-matrix.

- (a) The notion of bosonic emergence [K62] follows from the fact that gauge bosons are identifiable as pairs of fermion and anti-fermion at opposite light-like throats of wormhole contact. As a consequence, bosonic propagators and vertices are generated radiatively from a fundamental action for fermions and their super partners. At QFT limit without

super-symmetry this means that Dirac action coupled to gauge bosons is the fundamental action and the counterpart of YM action is generated radiatively. All coupling constants follow as predictions as they indeed must do on basis of the general structure of quantum TGD.

- (b) Whether the counterparts of space-time supersymmetries are possible in TGD Universe has remained a long-standing open question and my cautious belief has been that the super partners do not exist. The resolution of the problem came with the introduction of the measurement interaction term to the modified Dirac action defined by Kähler action [K31, K32], which meant a theoretical breakthrough in many respects. The oscillator operators associated with the modes of the induced spinor field satisfy the anticommutation relations defining the generalization of space-time super-symmetry algebra and these oscillator operators serve as the building blocks of various super-conformal algebras. The number of super-symmetry generators is very large, perhaps even infinite. This forces a generalization of the standard super field concept. The action for chiral super-fields emerges as a generalization of the Dirac action to include all possible super-partners. The huge super-symmetry gives excellent hopes about cancelation of UV divergences. The counterpart of super-symmetric YM action emerges radiatively. This formalism works at the QFT limit. The generalization of the formalism to quantum TGD proper is yet to be carried out.
- (c) Twistor program has become one of the most promising approaches to gauge theories. This inspired the question whether TGD could allow twistorialization [K89]. Massive states - both real and virtual- are the basic problem of twistor approach. In TGD framework the obvious idea is that massive on mass shell states can be interpreted as massless states in 8-D sense. Massive off-mass shell states in turn could be regarded as pairs of positive and negative on mass shell states. This means opening of the black box of virtual state attempted already in the model for bosonic propagators inspired by the bosonic emergence [K62], and one can even hope that individual loop integrals are finite and that Wick rotation is not needed. The third observation is that 8-dimensional gamma matrices allow a representation in terms of octonions (matrices are not in question anymore). If the modified gamma "matrices" associated with space-time surface define a quaternionic sub-algebra of the complexified octonion algebra, they allow a matrix representation defined by octonionic structure constants. This holds true for hyper-quaternionic space-time surfaces so that a connection with number theoretic vision emerges. This would more or less reduce the notion of twistor to its 4-dimensional counterpart.

5.1.3 Could correlation functions, S-matrix, and coupling constant evolution be coded the statistical properties of preferred extremals?

Quantum classical correspondence states that all aspects of quantum states should have correlates in the geometry of preferred extremals. In particular, various elementary particle propagators should have a representation as properties of preferred extremals. This would allow to realize the old dream about being able to say something interesting about coupling constant evolution although it is not yet possible to calculate the M-matrices and U-matrix. Hitherto everything that has been said about coupling constant evolution has been rather speculative arguments except for the general vision that it reduces to a discrete evolution defined by p-adic length scales. General first principle definitions are however much more valuable than ad hoc guesses even if the latter give rise to explicit formulas.

In quantum TGD and also at its QFT limit various correlation functions in given quantum state should code for its properties. By quantum classical correspondence these correlation functions should have counterparts in the geometry of preferred extremals. Even more: these classical counterparts for a given preferred extremal ought to be identical with the quantum correlation functions for the superposition of preferred extremals. This correspondence could be called quantum ergodicity by its analogy with ordinary ergodicity stating that the member of ensemble becomes representative of ensemble.

- (a) The marvelous implication of quantum ergodicity would be that one could calculate everything solely classically using the classical intuition - the only intuition that we have.

Quantum ergodicity would also solve the paradox raised by the quantum classical correspondence for momentum eigenstates. Any preferred extremal in their superposition defining momentum eigenstate should code for the momentum characterizing the superposition itself. This is indeed possible if every extremal in the superposition codes the momentum to the properties of classical correlation functions which are identical for all of them.

- (b) The only manner to possibly achieve quantum ergodicity is in terms of the statistical properties of the preferred extremals. It should be possible to generalize the ergodic theorem stating that the properties of statistical ensemble are represented by single space-time evolution in the ensemble of time evolutions. Quantum superposition of classical worlds would effectively reduce to single classical world as far as classical correlation functions are considered. The notion of finite measurement resolution suggests that one must state this more precisely by adding that classical correlation functions are calculated in a given UV and IR resolutions meaning UV cutoff defined by the smallest CD and IR cutoff defined by the largest CD present.

- (c) The skeptic inside me immediately argues that TGD Universe is 4-D spin glass so that this quantum ergodic theorem must be broken. In the case of the ordinary spin classes one has not only statistical average for a fixed Hamiltonian but a statistical average over Hamiltonians. There is a probability distribution over the coupling parameters appearing in the Hamiltonian. Maybe the quantum counterpart of this is needed to predict the physically measurable correlation functions.

Could this average be an ordinary classical statistical average over quantum states with different classical correlation functions? This kind of average is indeed taken in density matrix formalism. Or could it be that the square root of thermodynamics defined by ZEO actually gives automatically rise to this average? The eigenvalues of the "hermitian square root" of the density matrix would code for components of the state characterized by different classical correlation functions. One could assign these contributions to different "phases".

- (d) Quantum classical correspondence in statistical sense would be very much like holography (now individual classical state represents the entire quantum state). Quantum ergodicity would pose a rather strong constraint on quantum states. This symmetry principle could actually fix the spectrum of zero energy states to a high degree and fix therefore the M-matrices given by the product of hermitian square root of density matrix and unitary S-matrix and unitary U-matrix having M-matrices as its orthonormal rows.
- (e) In TGD inspired theory of consciousness the counterpart of quantum ergodicity is the postulate that the space-time geometry provides a symbolic representation for the quantum states and also for the contents of consciousness assignable to quantum jumps between quantum states. Quantum ergodicity would realize this strongly self-referential looking condition. The positive and negative energy parts of zero energy state would be analogous to the initial and final states of quantum jump and the classical correlation functions would code for the contents of consciousness like written formulas code for the thoughts of mathematician and provide a sensory feedback.

How classical correlation functions should be defined?

- (a) General Coordinate Invariance and Lorentz invariance are the basic constraints on the definition. These are achieved for the space-time regions with Minkowskian signature and 4-D M^4 projection if linear Minkowski coordinates are used. This is equivalent with the contraction of the indices of tensor fields with the space-time projections of M^4 Killing vector fields representing translations. Accepting this generalization, there is no need to restrict oneself to 4-D M^4 projection and one can also consider also Euclidian regions identifiable as lines of generalized Feynman diagrams.

Quantum ergodicity very probably however forces to restrict the consideration to Minkowskian and Euclidian space-time regions and various phases associated with them. Also CP_2 Killing vector fields can be projected to space-time surface and give a representation for classical gluon fields. These in turn can be contracted with M^4 Killing vectors giving rise

to gluon fields as analogs of graviton fields but with second polarization index replaced with color index.

- (b) The standard definition for the correlation functions associated with classical time evolution is the appropriate starting point. The correlation function $G_{XY}(\tau)$ for two dynamical variables $X(t)$ and $Y(t)$ is defined as the average $G_{XY}(\tau) = \int_T X(t)Y(t + \tau)dt/T$ over an interval of length T , and one can also consider the limit $T \rightarrow \infty$. In the recent case one would replace τ with the difference $m_1 - m_2 = m$ of M^4 coordinates of two points at the preferred extremal and integrate over the points of the extremal to get the average. The finite time interval T is replaced with the volume of causal diamond in a given length scale. Zero energy state with given quantum numbers for positive and negative energy parts of the state defines the initial and final states between which the fields appearing in the correlation functions are defined.
- (c) What correlation functions should be considered? Certainly one could calculate correlation functions for the induced spinor connection given electro-weak propagators and correlation functions for CP_2 Killing vector fields giving correlation functions for gluon fields using the description in terms of Killing vector fields. If one can uniquely separate from the Fourier transform uniquely a term of form $Z/(p^2 - m^2)$ by its momentum dependence, the coefficient Z can be identified as coupling constant squared for the corresponding gauge potential component and one can in principle deduce coupling constant evolution purely classically. One can imagine of calculating spinorial propagators for string world sheets in the same manner. Note that also the dependence on color quantum numbers would be present so that in principle all that is needed could be calculated for a single preferred extremal without the need to construct QFT limit and to introduce color quantum numbers of fermions as spin like quantum numbers (color quantum numbers corresponds to CP_2 partial wave for the tip of the CD assigned with the particle).
- (d) What about Higgs field? TGD in principle allows scalar and pseudo-scalars which could be called Higgs like states. These states are however not necessary for particle massivation although they can represent particle massivation and must do so if one assumes that QFT limit exist. p-Adic thermodynamics however describes particle massivation microscopically. The problem is that Higgs like field does not seem to have any obvious space-time correlate. The trace of the second fundamental form is the obvious candidate but vanishes for preferred extremals which are both minimal surfaces and solutions of Einstein Maxwell equations with cosmological constant. If the string world sheets at which all spinor components except right handed neutrino are localized for the general solution ansatz of the modified Dirac equation, the corresponding second fundamental form at the level of imbedding space defines a candidate for classical Higgs field. A natural expectation is that string world sheets are minimal surfaces of space-time surface. In general they are however not minimal surfaces of the imbedding space so that one might achieve a microscopic definition of classical Higgs field and its vacuum expectation value as an average of one point correlation function over the string world sheet.

Many detailed speculations about coupling constant evolution to be discussed in the sections below must be taken as innovative guesses doomed to have the eventual fate of guesses. The notion of quantum ergodicity could however be one of the really deep ideas about coupling constant evolution comparable to the notion of p-adic coupling constant evolution. Quantum Ergodicity (briefly QE) would also state something extremely non-trivial also about the construction of correlation functions and S-matrix. Because this principle is so new, the rest of the chapter does not yet contain any applications of QE. This should not lead the reader to under-estimate the potential power of QE.

5.1.4 Vision about coupling constant evolution

The following summarizes the basic vision about coupling constant evolution.

p-Adic evolution in phase resolution and the spectrum of values for Planck constants

The quantization of Planck constant has been the basic theme of TGD for about five years now. The basic idea is that the different values of Planck constant correspond to evolution in angular resolution in p-adic context characterized by quantum phase $q = \exp(i\pi/n)$ characterizing Jones inclusion is. The higher the value of n , the better the angular resolution since the number of different complex phases in extension of p-adic numbers increases with n .

The breakthrough became with the realization that standard type Jones inclusions lead to a detailed understanding of what is involved and predict very simple spectrum for Planck constants associated with M^4 and CP_2 degrees of freedom. This picture allows to understand also gravitational Planck constant and coupling constant evolution and leads also to the understanding of ADE correspondences (index $\beta \leq 4$ and $\beta = 4$) from the point of view of Jones inclusions.

The most recent view about coupling constant evolution

Zero energy ontology, the construction of M -matrix as time like entanglement coefficients defining Connes tensor product characterizing finite measurement resolution in terms of inclusion of hyper-finite factors of type II_1 , the realization that symplectic invariance of N-point functions provides a detailed mechanism eliminating UV divergences, and the understanding of the relationship between super-symplectic and super Kac-Moody symmetries: these are the pieces of the puzzle whose combination makes possible a rather concrete vision about coupling constant evolution in TGD Universe and one can even speak about rudimentary form of generalized Feynman rules.

Equivalence Principle and evolution of gravitational constant

Before saying anything about evolution of gravitational constant one must understand whether it is a fundamental constant or prediction of quantum TGD. Also one should understand whether Equivalence Principle holds true and if so, in what sense. Also the identification of gravitational and inertial masses seems to be necessary.

- (a) The coset construction for super-symplectic and super Kac-Moody algebras implies Equivalence Principle in the sense that four-momenta assignable to the Super Virasoro generators of the two algebras are identical. The challenge is to understand this result in more concrete terms.
- (b) The progress made in the understanding of number theoretical compactification led to a dramatic progress in the construction of configuration space geometry and spinor structure in terms of the modified Dirac operator associated with light-like 3-surfaces appearing in the slicing of the preferred extremal $X(X_l^3)$ of Kähler action to light-like 3-surfaces Y_l^3 "parallel" to X_l^3 . Even more the M^4 projection is predicted to have a slicing into 2-dimensional stringy worldsheets having $M^2(x) \subset M^4$ as a tangent space at point x .
- (c) By dimensional reduction one can assign to any stringy slice Y^2 a stringy action obtained by integrating Kähler action over the transversal degrees of freedom labeling the copies of Y^2 . One can assign length scale evolution to the string tension $T(x)$, which in principle can depend on the point of the string world sheet and thus evolves. $T(x)$ is not identifiable as inverse of gravitational constant but by general arguments proportional to $1/L_p^2$, where L_p is p-adic length scale.
- (d) Gravitational constant can be understood as a product of L_p^2 with the exponential of the Kähler action for the two pieces of CP_2 type vacuum extremals representing wormhole contacts assignable to graviton connected by the string world sheets. The volume of the typical CP_2 type extremal associated with the graviton increases with L_p so that the exponential factor decreases reducing the growth due to the increase of L_p . Hence G could be RG invariant in p-adic coupling constant evolution. It does not make sense to formulate evolution of gravitational constant at space-time level and gravitational constant characterizes given CD .

- (e) Gravitational mass is assigned to the stringy world sheet and should be identical with the inertial mass identified as Noether charge assignable to the preferred extremal. By construction there are good hopes that for a proper choice of G gravitational and inertial masses are identical.

The RG invariance of gauge couplings inside causal diamond

Quantum classical correspondence suggests that the notion of p-adic coupling constant evolution should have space-time correlate. Zero energy ontology suggests that this counterpart is realized in terms of CD s in the sense that coupling constant evolution has formulation at space-time level inside CD of given size scale and that RG invariance holds true for this evolution. Number theoretic compactification forces to conclude that space-time surfaces has slicing into light-like 3-surfaces Y_l^3 : this prediction is consistent with that is known about the extremals. General Coordinate Invariance requires that basic theory can be formulated by replacing the light-like 3-surface X_l^3 associated with wormhole throats with any surface Y_l^3 appearing in the associated slicing.

The natural identification for the renormalization group parameter is as the light-like coordinate labeling different light-like slices. The light-likeness of the RG parameter suggests RG invariance. Quantum classical correspondence requires that the classical gauge fluxes to X_l^3 selected by stationary phase approximation correspond to the expectation values of gQ_g , where g is coupling constant and Q_g the expectation (eigen) value of corresponding charge matrix in the state in question. If the gauge currents are light-like and in direction of Y_l^3 as they are for known extremals under proper selection of X_l^3 , RG invariance follows because Abelian gauge fluxes are conserved due to the absence of the component of vacuum current in the direction of slicing.

In principle TGD predicts the values of all coupling constants including also the value of Kähler coupling strength which follows from the identification of Kähler action of the preferred extremal $X^4(X_l^3)$ of Kähler action as Dirac determinant associated with modified Dirac action. Hence Kähler coupling strength could have several values. Quantum criticality in the strongest form however motivates the hypothesis that g_K^2 is invariant under p-adic coupling constant evolution and evolution under evolution associated with the hierarchy of Planck constants.

Quantitative predictions for the values of coupling constants

The latest progress in the understanding of p-adic coupling constant evolution comes from a formula for Kähler coupling strength α_K in terms of Dirac determinant of the modified Dirac operator.

The formula for α_K fixes its number theoretic anatomy and also that of other coupling strengths. The assumption that simple rationals (p-adicization) are involved can be combined with the input from p-adic mass calculations and with an old conjecture for the formula of gravitational constant allowing to express it in terms of CP_2 length scale and Kähler action of topologically condensed CP_2 type vacuum extremal. The prediction is that α_K is renormalization group invariant and equals to the value of fine structure constant at electron length scale characterized by M_{127} . Newton's constant is proportional to p-adic length scale squared and ordinary gravitons correspond to M_{127} . The number theoretic anatomy of R^2/G allows to consider two options. For the first one only M_{127} gravitons are possible number theoretically. For the second option gravitons corresponding to $p \simeq 2^k$ are possible.

A relationship between electromagnetic and color coupling constant evolutions based on the formula $1/\alpha_{em} + 1/\alpha_s = 1/\alpha_K$ is suggested by the induced gauge field concept, and would mean that the otherwise hard-to-calculate evolution of color coupling strength is fixed completely. The predicted value of α_s at intermediate boson length scale is correct.

p-Adic length scale evolution of gauge couplings

Understanding the dependence of gauge couplings constants on p-adic prime is one of the basic challenges of quantum TGD. The problem has been poorly understood even at the conceptual

level to say nothing about concrete calculations. The generalization of the motion of S-matrix to that of M-matrix changed however the situation [K22]. M-matrix is always defined with respect to measurement resolution characterized in terms of an inclusion of von Neumann algebra. Coupling constant evolution reduces to a discrete evolution involving only octaves of $T(k) = 2^k T_0$ of the fundamental time scale $T_0 = R$, where R CP₂ scale. p-Adic length scale $L(k)$ is related to $T(k)$ by $L^2(k) = T(k)T_0$. p-Adic length scale hypothesis $p \simeq 2^k$, k integer, is automatic prediction of the theory. There is also a close connection with the description of coupling constant evolution in terms of radiative corrections.

If RG invariance at given space-time sheet holds true, the question arises whether it is possible to understand p-adic coupling constant evolution at space-time level and why certain p-adic primes are favored.

- (a) Simple considerations lead to the idea that M^4 scalings of the intersections of 3-surfaces defined by the intersections of space-time surfaces with light-cone boundary induce transformations of space-time surface identifiable as RG transformations. If sufficiently small they leave gauge charges invariant: this seems to be the case for known extremals which form scaling invariant families. When the scaling corresponds to a ratio p_2/p_1 , $p_2 > p_1$, bifurcation would become possible replacing p_1 -adic effective topology with p_2 -adic one.
- (b) Stability considerations determine whether p_2 -adic topology is actually realized and could explain why primes near powers of 2 are favored. The renormalization of coupling constant would be dictated by the requirement that Q_i/g_i^2 remains invariant.

5.2 General vision about real and p-adic coupling constant evolution

The unification of super-symplectic and Super Kac-Moody symmetries allows new view about p-adic aspects of the theory forcing a considerable modification and refinement of the almost decade old first picture about color coupling constant evolution.

Perhaps the most important questions about coupling constant evolution relate to the basic hypothesis about preferred role of primes $p \simeq 2^k$, k an integer. Why integer values of k are favored, why prime values are even more preferred, and why Mersenne primes $M_n = 2^n - 1$ and Gaussian Mersennes seem to be at the top of the hierarchy?

Second bundle of questions relates to the color coupling constant evolution. Do Mersenne primes really define a hierarchy of fixed points of color coupling constant evolution for a hierarchy of asymptotically non-free QCD type theories both in quark and lepton sector of the theory? How the transitions $M_n \rightarrow M_{n(next)}$ occur? What are the space-time correlates for the coupling constant evolution and for for these transitions and how space-time description relates to the usual description in terms of parton loops? How the condition that p-adic coupling constant evolution reflects the real coupling constant evolution can be satisfied and how strong conditions it poses on the coupling constant evolution?

5.2.1 A general view about coupling constant evolution

Zero energy ontology

In zero energy ontology one replaces positive energy states with zero energy states with positive and negative energy parts of the state at the boundaries of future and past direct light-cones forming a causal diamond. All conserved quantum numbers of the positive and negative energy states are of opposite sign so that these states can be created from vacuum. "Any physical state is creatable from vacuum" becomes thus a basic principle of quantum TGD and together with the notion of quantum jump resolves several philosophical problems (What was the initial state of universe?, What are the values of conserved quantities for Universe, Is theory building completely useless if only single solution of field equations is realized?).

At the level of elementary particle physics positive and negative energy parts of zero energy state are interpreted as initial and final states of a particle reaction so that quantum states become physical events. Equivalence Principle would hold true in the sense that the classical gravitational four-momentum of the vacuum extremal whose small deformations appear as the argument of configuration space spinor field is equal to the positive energy of the positive energy part of the zero energy quantum state. Equivalence Principle is expected to hold true for elementary particles and their composites but not for the quantum states defined around non-vacuum extremals.

Does the finiteness of measurement resolution dictate the laws of physics?

The hypothesis that the mere finiteness of measurement resolution could determine the laws of quantum physics [K22] completely belongs to the category of not at all obvious first principles. The basic observation is that the Clifford algebra spanned by the gamma matrices of the "world of classical worlds" represents a von Neumann algebra [A46] known as hyperfinite factor of type II_1 (HFF) [K22, K90, K30]. HFF [A43, A54] is an algebraic fractal having infinite hierarchy of included subalgebras isomorphic to the algebra itself [A2]. The structure of HFF is closely related to several notions of modern theoretical physics such as integrable statistical physical systems [A64], anyons [D12], quantum groups and conformal field theories [A55], and knots and topological quantum field theories [A60, A67].

Zero energy ontology is second key element. In zero energy ontology these inclusions allow an interpretation in terms of a finite measurement resolution: in the standard positive energy ontology this interpretation is not possible. Inclusion hierarchy defines in a natural manner the notion of coupling constant evolution and p-adic length scale hypothesis follows as a prediction. In this framework the extremely heavy machinery of renormalized quantum field theory involving the elimination of infinities is replaced by a precisely defined mathematical framework. More concretely, the included algebra creates states which are equivalent in the measurement resolution used. Zero energy states are associated with causal diamond formed by a pair of future and past directed light-cones having positive and negative energy parts of state at their boundaries. Zero energy state can be modified in a time scale shorter than the time scale of the zero energy state itself.

One can imagine two kinds of measurement resolutions. The element of the included algebra can leave the quantum numbers of the positive and negative energy parts of the state invariant, which means that the action of subalgebra leaves M-matrix invariant. The action of the included algebra can also modify the quantum numbers of the positive and negative energy parts of the state such that the zero energy property is respected. In this case the Hermitian operators subalgebra must commute with M-matrix.

The temporal distance between the tips of light-cones corresponds to the secondary p-adic time scale $T_{p,2} = \sqrt{p}T_p$ by a simple argument based on the observation that light-like randomness of light-like 3-surface is analogous to Brownian motion. This gives the relationship $T_p = L_p^2/Rc$, where R is CP_2 size. The action of the included algebra corresponds to an addition of zero energy parts to either positive or negative energy part of the state and is like addition of quantum fluctuation below the time scale of the measurement resolution. The natural hierarchy of time scales is obtained as $T_n = 2^{-n}T$ since these insertions must belong to either upper or lower half of the causal diamond. This implies that preferred p-adic primes are near powers of 2. For electron the time scale in question is .1 seconds defining the fundamental biorhythm of 10 Hz.

M-matrix representing a generalization of S-matrix and expressible as a product of a positive square root of the density matrix and unitary S-matrix would define the dynamics of quantum theory [K22]. The notion of thermodynamical state would cease to be a theoretical fiction and in a well-defined sense quantum theory could be regarded as a square root of thermodynamics. The original hope was that Connes tensor product realizing mathematically the finite measurement resolution could fix M-matrix to high degree turned out to be too optimistic.

How do p-adic coupling constant evolution and p-adic length scale hypothesis emerge?

Zero energy ontology in which zero energy states have as imbedding space correlates causal diamonds for which the distance between the tips of future and past directed light-cones are power of 2 multiples of fundamental time scale ($T_n = 2^n T_0$) implies in a natural manner coupling constant evolution. One must however emphasize that also the weaker condition $T_p = pT_0$, p prime, is possible, and would assign all p-adic time scales to the size scale hierarchy of CDs .

Could the coupling constant evolution in powers of 2 implying time scale hierarchy $T_n = 2^n T_0$ induce p-adic coupling constant evolution and explain why p-adic length scales correspond to $L_p \propto \sqrt{p}R$, $p \simeq 2^k$, $R CP_2$ length scale? This looks attractive but there is a problem. p-Adic length scales come as powers of $\sqrt{2}$ rather than 2 and the strongly favored values of k are primes and thus odd so that $n = k/2$ would be half odd integer. This problem can be solved.

- (a) The observation that the distance traveled by a Brownian particle during time t satisfies $r^2 = Dt$ suggests a solution to the problem. p-Adic thermodynamics applies because the partonic 3-surfaces X^2 are as 2-D dynamical systems random apart from light-likeness of their orbit. For CP_2 type vacuum extremals the situation reduces to that for a one-dimensional random light-like curve in M^4 . The orbits of Brownian particle would now correspond to light-like geodesics γ_3 at X^3 . The projection of γ_3 to a time=constant section $X^2 \subset X^3$ would define the 2-D path γ_2 of the Brownian particle. The M^4 distance r between the end points of γ_2 would be given $r^2 = Dt$. The favored values of t would correspond to $T_n = 2^n T_0$ (the full light-like geodesic). p-Adic length scales would result as $L^2(k) = DT(k) = D2^k T_0$ for $D = R^2/T_0$. Since only CP_2 scale is available as a fundamental scale, one would have $T_0 = R$ and $D = R$ and $L^2(k) = T(k)R$.
- (b) p-Adic primes near powers of 2 would be in preferred position. p-Adic time scale would not relate to the p-adic length scale via $T_p = L_p/c$ as assumed implicitly earlier but via $T_p = L_p^2/R_0 = \sqrt{p}L_p$, which corresponds to secondary p-adic length scale. For instance, in the case of electron with $p = M_{127}$ one would have $T_{127} = .1$ second which defines a fundamental biological rhythm. Neutrinos with mass around .1 eV would correspond to $L(169) \simeq 5 \mu\text{m}$ (size of a small cell) and $T(169) \simeq 1. \times 10^4$ years. A deep connection between elementary particle physics and biology becomes highly suggestive.
- (c) In the proposed picture the p-adic prime $p \simeq 2^k$ would characterize the thermodynamics of the random motion of light-like geodesics of X^3 so that p-adic prime p would indeed be an inherent property of X^3 .

5.2.2 Both symplectic and conformal field theories are needed in TGD framework

Before one can say anything quantitative about coupling constant evolution, one must have a formulation for its TGD counterpart and thus also a more detailed formulation for how to calculate M-matrix elements. There is also the question about infinities. By very general arguments infinities of quantum field theories are predicted to cancel in TGD Universe - basically by the non-locality of Kähler function as a functional of 3-surface and by the general properties of the vacuum functional identified as the exponent of Kähler function. The precise mechanism leading to the cancellation of infinities of local quantum field theories has remained unspecified. Only the realization that the symplectic invariance of quantum TGD provides a mechanism regulating the short distance behavior of N-point functions changed the situation in this respect. This also leads to concrete view about the generalized Feynman diagrams giving M-matrix elements and rather close resemblance with ordinary Feynman diagrammatics.

Symplectic invariance

Symplectic (or canonical as I have called them) symmetries of $\delta M_+^4 \times CP_2$ (light-cone boundary briefly) act as isometries of the "world of classical worlds". One can see these symmetries as analogs of Kac-Moody type symmetries with symplectic transformations of $S^2 \times CP_2$, where

S^2 is $r_M = \text{constant}$ sphere of lightcone boundary, made local with respect to the light-like radial coordinate r_M taking the role of complex coordinate. Thus finite-dimensional Lie group G is replaced with infinite-dimensional group of symplectic transformations. This inspires the question whether a symplectic analog of conformal field theory at $\delta M^4_{\pm} \times CP_2$ could be relevant for the construction of n-point functions in quantum TGD and what general properties these n-point functions would have. This section appears already in the previous chapter about symmetries of quantum TGD [K23] but because the results of the section provide the first concrete construction recipe of M-matrix in zero energy ontology, it is included also in this chapter.

Symplectic QFT at sphere

Actually the notion of symplectic QFT emerged as I tried to understand the properties of cosmic microwave background which comes from the sphere of last scattering which corresponds roughly to the age of 5×10^5 years [K61]. In this situation vacuum extremals of Kähler action around almost unique critical Robertson-Walker cosmology imbeddable in $M^4 \times S^2$, where there is homologically trivial geodesic sphere of CP_2 . Vacuum extremal property is satisfied for any space-time surface which is surface in $M^4 \times Y^2$, Y^2 a Lagrangian sub-manifold of CP_2 with vanishing induced Kähler form. Symplectic transformations of CP_2 and general coordinate transformations of M^4 are dynamical symmetries of the vacuum extremals so that the idea of symplectic QFT emerges natural. Therefore I shall consider first symplectic QFT at the sphere S^2 of last scattering with temperature fluctuation $\Delta T/T$ proportional to the fluctuation of the metric component g_{aa} in Robertson-Walker coordinates.

- (a) In quantum TGD the symplectic transformation of the light-cone boundary would induce action in the "world of classical worlds" (light-like 3-surfaces). In the recent situation it is convenient to regard perturbations of CP_2 coordinates as fields at the sphere of last scattering (call it S^2) so that symplectic transformations of CP_2 would act in the field space whereas those of S^2 would act in the coordinate space just like conformal transformations. The deformation of the metric would be a symplectic field in S^2 . The symplectic dimension would be induced by the tensor properties of R-W metric in R-W coordinates: every S^2 coordinate index would correspond to one unit of symplectic dimension. The symplectic invariance in CP_2 degrees of freedom is guaranteed if the integration measure over the vacuum deformations is symplectic invariant. This symmetry does not play any role in the sequel.
- (b) For a symplectic scalar field $n \geq 3$ -point functions with a vanishing anomalous dimension would be functions of the symplectic invariants defined by the areas of geodesic polygons defined by subsets of the arguments as points of S^2 . Since n-polygon can be constructed from 3-polygons these invariants can be expressed as sums of the areas of 3-polygons expressible in terms of symplectic form. n-point functions would be constant if arguments are along geodesic circle since the areas of all sub-polygons would vanish in this case. The decomposition of n-polygon to 3-polygons brings in mind the decomposition of the n-point function of conformal field theory to products of 2-point functions by using the fusion algebra of conformal fields (very symbolically $\Phi_k \Phi_l = c_{kl}^m \Phi_m$). This intuition seems to be correct.
- (c) Fusion rules stating the associativity of the products of fields at different points should generalize. In the recent case it is natural to assume a non-local form of fusion rules given in the case of symplectic scalars by the equation

$$\Phi_k(s_1)\Phi_l(s_2) = \int c_{kl}^m f(A(s_1, s_2, s_3))\Phi_m(s) d\mu_s \quad (5.2.1)$$

Here the coefficients c_{kl}^m are constants and $A(s_1, s_2, s_3)$ is the area of the geodesic triangle of S^2 defined by the symplectic measure and integration is over S^2 with symplectically invariant measure $d\mu_s$ defined by symplectic form of S^2 . Fusion rules pose powerful conditions on n-point functions and one can hope that the coefficients are fixed completely.

- (d) The application of fusion rules gives at the last step an expectation value of 1-point function of the product of the fields involves unit operator term $\int c_{kl} f(A(s_1, s_2, s)) I dd\mu_s$ so that one has

$$\langle \Phi_k(s_1) \Phi_l(s_2) \rangle = \int c_{kl} f(A(s_1, s_2, s)) d\mu_s . \quad (5.2.2)$$

Hence 2-point function is average of a 3-point function over the third argument. The absence of non-trivial symplectic invariants for 1-point function means that $n = 1$ - an are constant, most naturally vanishing, unless some kind of spontaneous symmetry breaking occurs. Since the function $f(A(s_1, s_2, s_3))$ is arbitrary, 2-point correlation function can have both signs. 2-point correlation function is invariant under rotations and reflections.

Symplectic QFT with spontaneous breaking of rotational and reflection symmetries

CMB data suggest breaking of rotational and reflection symmetries of S^2 . A possible mechanism of spontaneous symmetry breaking is based on the observation that in TGD framework the hierarchy of Planck constants assigns to each sector of the generalized imbedding space a preferred quantization axes. The selection of the quantization axis is coded also to the geometry of "world of classical worlds", and to the quantum fluctuations of the metric in particular. Clearly, symplectic QFT with spontaneous symmetry breaking would provide the sought-for really deep reason for the quantization of Planck constant in the proposed manner.

- (a) The coding of angular momentum quantization axis to the generalized imbedding space geometry allows to select South and North poles as preferred points of S^2 . To the three arguments s_1, s_2, s_3 of the 3-point function one can assign two squares with the added point being either North or South pole. The difference

$$\Delta A(s_1, s_2, s_3) \equiv A(s_1, s_2, s_3, N) - A(s_1, s_2, s_3, S) \quad (5.2.3)$$

of the corresponding areas defines a simple symplectic invariant breaking the reflection symmetry with respect to the equatorial plane. Note that ΔA vanishes if arguments lie along a geodesic line or if any two arguments co-incide. Quite generally, symplectic QFT differs from conformal QFT in that correlation functions do not possess singularities.

- (b) The reduction to 2-point correlation function gives a consistency conditions on the 3-point functions

$$\begin{aligned} \langle (\Phi_k(s_1) \Phi_l(s_2)) \Phi_m(s_3) \rangle &= c_{kl}^r \int f(\Delta A(s_1, s_2, s)) \langle \Phi_r(s) \Phi_m(s_3) \rangle d\mu_s \\ &= \end{aligned} \quad (5.2.4)$$

$$c_{kl}^r c_{rm} \int f(\Delta A(s_1, s_2, s)) f(\Delta A(s, s_3, t)) d\mu_s d\mu_t . \quad (5.2.5)$$

Associativity requires that this expression equals to $\langle \Phi_k(s_1) (\Phi_l(s_2) \Phi_m(s_3)) \rangle$ and this gives additional conditions. Associativity conditions apply to $f(\Delta A)$ and could fix it highly uniquely.

- (c) 2-point correlation function would be given by

$$\langle \Phi_k(s_1) \Phi_l(s_2) \rangle = c_{kl} \int f(\Delta A(s_1, s_2, s)) d\mu_s \quad (5.2.6)$$

- (d) There is a clear difference between $n > 3$ and $n = 3$ cases: for $n > 3$ also non-convex polygons are possible: this means that the interior angle associated with some vertices of the polygon is larger than π . $n = 4$ theory is certainly well-defined, but one can argue that so are also $n > 4$ theories and skeptic would argue that this leads to an inflation of theories. TGD however allows only finite number of preferred points and fusion rules could eliminate the hierarchy of theories.

- (e) To sum up, the general predictions are following. Quite generally, for $f(0) = 0$ n-point correlation functions vanish if any two arguments co-incide which conforms with the spectrum of temperature fluctuations. It also implies that symplectic QFT is free of the usual singularities. For symmetry breaking scenario 3-point functions and thus also 2-point functions vanish also if s_1 and s_2 are at equator. All these are testable predictions using ensemble of CMB spectra.

Generalization to quantum TGD

Since number theoretic braids are the basic objects of quantum TGD, one can hope that the n-point functions assignable to them could code the properties of ground states and that one could separate from n-point functions the parts which correspond to the symplectic degrees of freedom acting as symmetries of vacuum extremals and isometries of the 'world of classical worlds'.

- (a) This approach indeed seems to generalize also to quantum TGD proper and the n-point functions associated with partonic 2-surfaces can be decomposed in such a manner that one obtains coefficients which are symplectic invariants associated with both S^2 and CP_2 Kähler form.
- (b) Fusion rules imply that the gauge fluxes of respective Kähler forms over geodesic triangles associated with the S^2 and CP_2 projections of the arguments of 3-point function serve basic building blocks of the correlation functions. The North and South poles of S^2 and three poles of CP_2 can be used to construct symmetry breaking n-point functions as symplectic invariants. Non-trivial 1-point functions vanish also now.
- (c) The important implication is that n-point functions vanish when some of the arguments co-incide. This might play a crucial role in taming of the singularities: the basic general prediction of TGD is that standard infinities of local field theories should be absent and this mechanism might realize this expectation.

Next some more technical but elementary first guesses about what might be involved.

- (a) It is natural to introduce the moduli space for n-tuples of points of the symplectic manifold as the space of symplectic equivalence classes of n-tuples. In the case of sphere S^2 convex n-polygon allows $n + 1$ 3-sub-polygons and the areas of these provide symplectically invariant coordinates for the moduli space of symplectic equivalence classes of n-polygons (2^n -D space of polygons is reduced to $n + 1$ -D space). For non-convex polygons the number of 3-sub-polygons is reduced so that they seem to correspond to lower-dimensional sub-space. In the case of CP_2 n-polygon allows besides the areas of 3-polygons also 4-volumes of 5-polygons as fundamental symplectic invariants. The number of independent 5-polygons for n-polygon can be obtained by using induction: once the numbers $N(k, n)$ of independent $k \leq n$ -simplices are known for n-simplex, the numbers of $k \leq n + 1$ -simplices for $n + 1$ -polygon are obtained by adding one vertex so that by little visual gymnastics the numbers $N(k, n + 1)$ are given by $N(k, n + 1) = N(k - 1, n) + N(k, n)$. In the case of CP_2 the allowance of 3 analogs $\{N, S, T\}$ of North and South poles of S^2 means that besides the areas of polygons (s_1, s_2, s_3) , (s_1, s_2, s_3, X) , (s_1, s_2, s_3, X, Y) , and (s_1, s_2, s_3, N, S, T) also the 4-volumes of 5-polygons (s_1, s_2, s_3, X, Y) , and of 6-polygon (s_1, s_2, s_3, N, S, T) , $X, Y \in \{N, S, T\}$ can appear as additional arguments in the definition of 3-point function.
- (b) What one really means with symplectic tensor is not clear since the naive first guess for the n-point function of tensor fields is not manifestly general coordinate invariant. For instance, in the model of CMB, the components of the metric deformation involving S^2 indices would be symplectic tensors. Tensorial n-point functions could be reduced to those for scalars obtained as inner products of tensors with Killing vector fields of $SO(3)$ at S^2 . Again a preferred choice of quantization axis would be introduced and special points would correspond to the singularities of the Killing vector fields.

The decomposition of Hamiltonians of the "world of classical worlds" expressible in terms of Hamiltonians of $S^2 \times CP_2$ to irreps of $SO(3)$ and $SU(3)$ could define the notion of symplectic

tensor as the analog of spherical harmonic at the level of configuration space. Spin and gluon color would have natural interpretation as symplectic spin and color. The infinitesimal action of various Hamiltonians on n-point functions defined by Hamiltonians and their super counterparts is well-defined and group theoretical arguments allow to deduce general form of n-point functions in terms of symplectic invariants.

- (c) The need to unify p-adic and real physics by requiring them to be completions of rational physics, and the notion of finite measurement resolution suggest that discretization of also fusion algebra is necessary. The set of points appearing as arguments of n-point functions could be finite in a given resolution so that the p-adically troublesome integrals in the formulas for the fusion rules would be replaced with sums. Perhaps rational/algebraic variants of $S^2 \times CP_2 = SO(3)/SO(2) \times SU(3)/U(2)$ obtained by replacing these groups with their rational/algebraic variants are involved. Tetrahedra, octahedra, and dodecahedra suggest themselves as simplest candidates for these discretized spaces. Also the symplectic moduli space would be discretized to contain only n-tuples for which the symplectic invariants are numbers in the allowed algebraic extension of rationals. This would provide an abstract looking but actually very concrete operational approach to the discretization involving only areas of n-tuples as internal coordinates of symplectic equivalence classes of n-tuples. The best that one could achieve would be a formulation involving nothing below measurement resolution.
- (d) This picture based on elementary geometry might make sense also in the case of conformal symmetries. The angles associated with the vertices of the S^2 projection of n-polygon could define conformal invariants appearing in n-point functions and the algebraization of the corresponding phases would be an operational manner to introduce the space-time correlates for the roots of unity introduced at quantum level. In CP_2 degrees of freedom the projections of n-tuples to the homologically trivial geodesic sphere S^2 associated with the particular sector of CH would allow to define similar conformal invariants. This framework gives dimensionless areas (unit sphere is considered). p-Adic length scale hypothesis and hierarchy of Planck constants would bring in the fundamental units of length and time in terms of CP_2 length.

The recent view about M-matrix described in [K22] is something almost unique determined by Connes tensor product providing a formal realization for the statement that complex rays of state space are replaced with \mathcal{N} rays where \mathcal{N} defines the hyper-finite sub-factor of type II_1 defining the measurement resolution. M-matrix defines time-like entanglement coefficients between positive and negative energy parts of the zero energy state and need not be unitary. It is identified as square root of density matrix with real expressible as product of of real and positive square root and unitary S-matrix. This S-matrix is what is measured in laboratory. There is also a general vision about how vertices are realized: they correspond to light-like partonic 3-surfaces obtained by gluing incoming and outgoing partonic 3-surfaces along their ends together just like lines of Feynman diagrams. Note that in string models string world sheets are non-singular as 2-manifolds whereas 1-dimensional vertices are singular as 1-manifolds. These ingredients we should be able to fuse together. So we try once again!

- (a) *Iteration* starting from vertices and propagators is the basic approach in the construction of n-point function in standard QFT. This approach does not work in quantum TGD. Symplectic and conformal field theories suggest that *recursion* replaces iteration in the construction. One starts from an n-point function and reduces it step by step to a vacuum expectation value of a 2-point function using fusion rules. Associativity becomes the fundamental dynamical principle in this process. Associativity in the sense of classical number fields has already shown its power and led to a hyper-octonionic formulation of quantum TGD promising a unification of various visions about quantum TGD [K81] .
- (b) Let us start from the representation of a zero energy state in terms of a causal diamond defined by future and past directed light-cones. Zero energy state corresponds to a quantum superposition of light-like partonic 3-surfaces each of them representing possible particle reaction. These 3-surfaces are very much like generalized Feynman diagrams with lines replaced by light-like 3-surfaces coming from the upper and lower light-cone boundaries and

glued together along their ends at smooth 2-dimensional surfaces defining the generalized vertices.

- (c) It must be emphasized that the generalization of ordinary Feynman diagrammatics arises and conformal and symplectic QFTs appear only in the calculation of single generalized Feynman diagram. Therefore one could still worry about loop corrections. The fact that no integration over loop momenta is involved and there is always finite cutoff due to discretization together with recursive instead of iterative approach gives however good hopes that everything works. Note that this picture is in conflict with one of the earlier approaches based on positive energy ontology in which the hope was that only single generalized Feynman diagram could define the U-matrix thought to correspond to physical S-matrix at that time.
- (d) One can actually simplify things by identifying generalized Feynman diagrams as maxima of Kähler function with functional integration carried over perturbations around it. Thus one would have conformal field theory in both fermionic and configuration space degrees of freedom. The light-like time coordinate along light-like 3-surface is analogous to the complex coordinate of conformal field theories restricted to some curve. If it is possible continue the light-like time coordinate to a hyper-complex coordinate in the interior of 4-D space-time sheet, the correspondence with conformal field theories becomes rather concrete. Same applies to the light-like radial coordinates associated with the light-cone boundaries. At light-cone boundaries one can apply fusion rules of a symplectic QFT to the remaining coordinates. Conformal fusion rules are applied only to point pairs which are at different ends of the partonic surface and there are no conformal singularities since arguments of n-point functions do not co-incide. By applying the conformal and symplectic fusion rules one can eventually reduce the n-point function defined by the various fermionic and bosonic operators appearing at the ends of the generalized Feynman diagram to something calculable.
- (e) Finite measurement resolution defining the Connes tensor product is realized by the discretization applied to the choice of the arguments of n-point functions so that discretion is not only a space-time correlate of finite resolution but actually defines it. No explicit realization of the measurement resolution algebra \mathcal{N} seems to be needed. Everything should boil down to the fusion rules and integration measure over different 3-surfaces defined by exponent of Kähler function and by imaginary exponent of Chern-Simons action. The continuation of the configuration space Clifford algebra for 3-surfaces with cm degrees of freedom fixed to a hyper-octonionic variant of gamma matrix field of super-string models defined in M^8 (hyper-octonionic space) and $M^8 \leftrightarrow M^4 \times CP_2$ duality leads to a unique choice of the points, which can contribute to n-point functions as intersection of M^4 subspace of M^8 with the counterparts of partonic 2-surfaces at the boundaries of light-cones of M^8 . Therefore there are hopes that the resulting theory is highly unique. Symplectic fusion algebra reduces to a finite algebra for each space-time surface if this picture is correct.
- (f) Consider next some of the details of how the light-like 3-surface codes for the fusion rules associated with it. The intermediate partonic 2- surfaces must be involved since otherwise the construction would carry no information about the properties of the light-like 3-surface, and one would not obtain perturbation series in terms of the relevant coupling constants. The natural assumption is that partonic 2-surfaces belong to future/past directed light-cone boundary depending on whether they are on lower/upper half of the causal diamond. Hyper-octonionic conformal field approach fixes the n_{int} points at intermediate partonic two-sphere for a given light-like 3-surface representing generalized Feynman diagram, and this means that the contribution is just N -point function with $N = n_{out} + n_{int} + n_{in}$ calculable by the basic fusion rules. Coupling constant strengths would emerge through the fusion coefficients, and at least in the case of gauge interactions they must be proportional to Kähler coupling strength since n-point functions are obtained by averaging over small deformations with vacuum functional given by the exponent of Kähler function. The first guess is that one can identify the spheres $S^2 \subset \delta M_{\pm}^4$ associated with initial, final and, and intermediate states so that symplectic n-points functions could be calculated using single sphere.

These findings raise the hope that quantum TGD is indeed a solvable theory. The coupling constant evolution is based on the same mechanism as in QFT and symplectic invariance replaces ad hoc UV cutoff with a genuine dynamical regulation mechanism. Causal diamond itself defines the physical IR cutoff. p-Adic and real coupling constant evolutions reflect the underlying evolution in powers of two for the temporal distance between the tips of the light-cones of the causal diamond and the association of macroscopic time scale as secondary p-adic time scale to elementary particles (.1 seconds for electron) serves as a first test for the picture. Even if one is not willing to swallow any bit of TGD, the classification of the symplectic QFTs remains a fascinating mathematical challenge in itself. A further challenge is the fusion of conformal QFT and symplectic QFT in the construction of n-point functions. One might hope that conformal and symplectic fusion rules could be treated independently.

More detailed view about the construction of M-matrix elements

After three decades there are excellent hopes of building an explicit recipe for constructing M-matrix elements but the devil is in the details.

1. Elimination of infinities and coupling constant evolution

The elimination of infinities would follow from the symplectic QFT part of the theory. The symplectic contribution to n-point functions vanishes when two arguments co-incide. The UV cancellation mechanism has nothing to do with the finite measurement resolution which corresponds to the size of the causal diamonds inside which the space-time sheets representing radiative corrections are. There is also IR cutoff due to the presence of largest causal diamond.

One can decompose the radiative corrections into two types. First kind of corrections appear both at the level of positive/and negative energy parts of zero energy states. Second kind of corrections appear at the level of interactions between them. This decomposition is standard in quantum field theories and corresponds to the renormalization constants of fields *resp.* renormalization of coupling constants. The corrections due to the increase of measurement resolution in time comes as very specific corrections to positive and negative energy states involving gluing of smaller causal diamonds to the upper and lower boundaries of causal diamonds along any radial light-like ray. The radiative corrections correspond to the interactions correspond to the addition of smaller causal diamonds in the interior of the larger causal diamond. Scales for the corrections come as scalings in powers of 2 rather than as continuous scaling of measurement resolution.

2. Conformal symmetries

The basic questions are the following ones. How hyper-octonionic/-quaternionic/-complex super-conformal symmetry relates to the super-symplectic conformal symmetry at the imbedding space level and the super Kac-Moody symmetry associated with the light-like 3-surfaces? How do the dual $HO = M^8$ and $H = M^4 \times CP_2$ descriptions (number theoretic compactification) relate?

Concerning the understanding of these issues, the earlier construction of physical states poses strong constraints [K23].

- (a) The state construction utilizes both super-symplectic and super Kac-Moody algebras. super-symplectic algebra has negative conformal weights and creates tachyonic ground states from which Super Kac-Moody algebra generates states with non-negative conformal weight determining the mass squared value of the state. The commutator of these two algebras annihilates the physical states. This requires that both super conformal algebras must allow continuation to hyper-octonionic algebras, which are independent.
- (b) The light-like radial coordinate at δM_{\pm}^4 can be continued to a hyper-complex coordinate in M_{\pm}^2 defined the preferred commutative plane of non-physical polarizations, and also to a hyper-quaternionic coordinate in M_{\pm}^4 . Hence it would seem that super-symplectic algebra can be continued to an algebra in M_{\pm}^2 or perhaps in the entire M_{\pm}^4 . This would allow to continue also the operators G , L and other super-symplectic operators to operators in hyper-quaternionic M_{\pm}^4 needed in stringy perturbation theory.

- (c) Also the super KM algebra associated with the light-like 3-surfaces should be continuable to hyper-quaternionic M_{\pm}^4 . Here $HO - H$ duality comes in rescue. It requires that the preferred hyper-complex plane M^2 is contained in the tangent plane of the space-time sheet at each point, in particular at light-like 3-surfaces. We already know that this allows to assign a unique space-time surface to a given collection of light-like 3-surfaces as hyper-quaternionic 4-surface of HO hypothesized to correspond to (an obviously preferred) extremal of Kähler action. An equally important implication is that the light-like coordinate of X^3 can be continued to hyper-complex coordinate M^2 coordinate and thus also to hyperquaternionic M^4 coordinate.
- (d) The four-momentum appears in super generators G_n and L_n . It seems that the formal Fourier transform of four-momentum components to gradient operators to M_{\pm}^4 is needed and defines these operators as particular elements of the CH Clifford algebra elements extended to fields in imbedding space.

3. What about stringy perturbation theory?

The analog of stringy perturbation theory does not seem only a highly attractive but also an unavoidable outcome since a generalization of massless fermionic propagator is needed. The inverse for the sum of super Kac-Moody and super-symplectic super-Virasoro generators G (L) extended to an operator acting on the difference of the M^4 coordinates of the end points of the propagator line connecting two partonic 2-surfaces should appear as fermionic (bosonic) propagator in stringy perturbation theory. Virasoro conditions imply that only G_0 and L_0 appear as propagators. Momentum eigenstates are not strictly speaking possible since discretization is present due to the finite measurement resolution. One can however represent these states using Fourier transform as a superposition of momentum eigenstates so that standard formalism can be applied.

Symplectic QFT gives an additional multiplicative contribution to n-point functions and there would be also braiding S-matrices involved with the propagator lines in the case that partonic 2-surface carries more than 1 point. This leaves still modular degrees of freedom of the partonic 2-surfaces describable in terms of elementary particle vacuum functionals and the proper treatment of these degrees of freedom remains a challenge.

4. What about non-hermiticity of the CH super-generators carrying fermion number?

TGD represents also a rather special challenge, which actually represents the fundamental difference between quantum TGD and super string models. The assignment of fermion number to CH gamma matrices and thus also to the super-generator G is unavoidable. Also M^4 and H gamma matrices carry fermion number. This has been a long-standing interpretational problem in quantum TGD and I have been even ready to give up the interpretation of four-momentum operator appearing in G_n and L_n as actual four-momenta. The manner to get rid of this problem would be the assumption of Majorana property but this would force to give up the interpretation of different imbedding space chiralities in terms of conserved lepton and quark numbers and would also lead to super-string theory with critical dimension 10 or 11. A further problem is how to obtain amplitudes which respect fermion number conservation using string perturbation theory if $1/G = G^\dagger/L_0$ carries fermion number.

The recent picture does not leave many choices so that I was forced to face the truth and see how everything falls down to this single nasty detail! It became as a total surprise that gamma matrices carrying fermion number do not cause any difficulties in zero energy ontology and make sense even in the ordinary Feynman diagrammatics.

- (a) Non-hermiticity of G means that the center of mass terms CH gamma matrices must be distinguished from their Hermitian conjugates. In particular, one has $\gamma_0 \neq \gamma_0^{agger}$. One can interpret the fermion number carrying M^4 gamma matrices of the complexified quaternion space.
- (b) One might think that $M^4 \times CP_2$ gamma matrices carrying fermion number is a catastrophe but this is not the case in massless theory. Massless momentum eigen states can be created

by the operator $p^k \gamma_k^\dagger$ from a vacuum annihilated by gamma matrices and satisfying massless Dirac equation. The conserved fermion number defined by the integral of $\bar{\Psi} \gamma^0 \Psi$ over 3-space gives just its standard value. A further experimentation shows that Feynman diagrams with non-hermitian gamma matrices give just the standard results since fermionic propagator and boson-emission vertices give compensating fermion numbers.

- (c) If the theory would contain massive fermions or a coupling to a scalar Higgs, a catastrophe would result. Hence ordinary Higgs mechanism is not possible in this framework. Of course, also the quantization of fermions is totally different. In TGD fermion mass is not a scalar in H . Part of it is given by CP_2 Dirac operator, part by p-adic thermodynamics for L_0 , and part by Higgs field which behaves like vector field in CP_2 degrees of freedom, so that the catastrophe is avoided.
- (d) In zero energy ontology zero energy states are characterized by M-matrix elements constructed by applying the combination of stringy and symplectic Feynman rules and fermionic propagator is replaced with its super-conformal generalization reducing to an ordinary fermionic propagator for massless states. The norm of a single fermion state is given by a propagator connecting positive energy state and its conjugate with the propagator G_0/L_0 and the standard value of the norm is obtained by using Dirac equation and the fact that Dirac operator appears also in G_0 .
- (e) The hermiticity of super-generators G would require Majorana property and one would end up with superstring theory with critical dimension $D = 10$ or $D = 11$ for the imbedding space. Hence the new interpretation of gamma matrices, proposed already years ago, has very profound consequences and convincingly demonstrates that TGD approach is indeed internally consistent.

In this framework coupling constant evolution would have interpretation in terms of addition of intermediate zero energy states corresponding to the generalized Feynman diagrams obtained by the insertion of causal diamonds with a new shorter time scale $T = T_{prev}/2$ to the previous Feynman diagram. p-Adic length scale hypothesis follows naturally. A very close correspondence with ordinary Feynman diagrammatics arises and ordinary vision about coupling constant evolutions arises. The absence of infinities follows from the symplectic invariance which is genuinely new element. p-Adic and real coupling constant evolutions can be seen as completions of coupling constant evolutions for physics based on rationals and their algebraic extensions.

5.3 Does the evolution of gravitational coupling make sense at space-time level?

Coset construction for super-symplectic and super Kac-Moody algebras discussed in [K19, K23, K48] allows to generalize Equivalence Principle and understand it at quantum level. This is however not quite enough: a precise understanding of Equivalence Principle is required also at the classical level. In the following the notion of gravitational mass and its equivalence with inertial mass is discussed first. The strategy is to deduce connection with string model type description rather than trying to show that General Relativity emerges from TGD. This connection emerges through dimensional reduction of the dynamics defined by Kähler action to stringy dynamics. If one believes that string model description implies General Relativity in long scales, the situation is settled. The determination of gravitational mass as flux does not apply generally so that one cannot identify GM as a gravitational flux assignable to a wormhole throat. Hence one cannot formulate the evolution of G at space-time level as evolution of gravitational fluxes and it seems that only p-adic coupling constant evolution makes sense for G .

5.3.1 Is stringy action principle coded by the geometry of preferred extremals?

It seems very difficult to deduce Equivalence Principle as an identity of gravitational and inertial masses identified as Noether charges associated with corresponding action principles. Since string

model is an excellent theory of quantum gravitation, one can consider a less direct approach in which one tries to deduce a connection between classical TGD and string model and hope that the bridge from string model to General Relativity is easier to build. Number theoretic compactification gives good hopes that this kind of connection exists.

- (a) Number theoretic compactification implies that the preferred extremals of Kähler action have the property that one can assign to each point of M^4 projection $P_{M^4}(X^4(X_l^3))$ of the preferred extremal $M^2(x)$ identified as the plane of non-physical polarizations and also as the plane in which local massless four-momentum lies.
- (b) If the distribution of the planes $M^2(x)$ is integrable, one can slice $P_{M^4}(X^4(X_l^3))$ to string world-sheets. The intersection of string world sheets with $X^3 \subset \delta M_{\pm}^4 \times CP_2$ corresponds to a light-like curve having tangent in local tangent space $M^2(x)$ at light-cone boundary. This is the first candidate for the definition of number theoretic braid. Second definition assumes M^2 to be fixed at δCD : in this case the slicing is parameterized by the sphere S^2 defined by the light rays of δM_{\pm}^4 .
- (c) One can assign to the string world sheet -call it Y^2 - the standard area action

$$S_G(Y^2) = \int_{Y^2} T \sqrt{g_2} d^2 y \ , \quad (5.3.1)$$

where g_2 is either the induced metric or only its M^4 part. The latter option looks more natural since M^4 projection is considered. T is string tension.

- (d) The naivest guess would be $T = 1/\hbar G$ apart from some numerical constant but one must be very cautious here since $T = 1/L_p^2$ apart from a numerical constant is also a good candidate if one accepts the basic argument identifying G in terms of p-adic length L_p and Kähler action for two pieces of CP_2 type vacuum extremals representing propagating graviton. The formula reads $G = L_p^2 \exp(-2a S_K(CP_2))$, $a \leq 1$. The interaction strength which would be L_p^2 without the presence of CP_2 type vacuum extremals is reduced by the exponential factor coming from the exponent of Kähler function of configuration space.
- (e) One would have string model in either $CD \times CP_2$ or $CD \subset M^4$ with the constraint that stringy world sheet belongs to $X^4(X_l^3)$. For the extremals of $S_G(Y^2)$ gravitational four-momentum defined as Noether charge is conserved. The extremal property of string world sheet need not however be consistent with the preferred extremal property. This constraint might bring in coupling of gravitons to matter. The natural guess is that graviton corresponds to a string connecting wormhole contacts. The strings could also represent formation of gravitational bound states when they connect wormhole contacts separated by a large distance. The energy of the string is roughly $E \sim \hbar T L$ and for $T = 1/\hbar G$ gives $E \sim L/G$. Macroscopic strings are not allowed except as models of black holes. The identification $T \sim 1/L_p^2$ gives $E \sim \hbar L/L_p^2$, which does not favor long strings for large values of \hbar . The identification $G_p = L_p^2/\hbar_0$ gives $T = 1/\hbar G_p$ and $E \sim \hbar_0 L/L_p^2$, which makes sense and allows strings with length not much longer than p-adic length scale. Quantization - that is the presence of configuration space degrees of freedom- would bring in massless gravitons as deformations of string whereas strings would carry the gravitational mass.
- (f) The exponent $\exp(iS_G)$ can appear as a phase factor in the definition of quantum states for preferred extremals. S_G is not however enough. One can assign also to the points of number theoretic braid action describing the interaction of a point like current $Q dx^\mu/ds$ with induced gauge potentials A_μ . The corresponding contribution to the action is

$$S_{braid} = \int_{braid} i Tr(Q \frac{dx^\mu}{ds} A_\mu) dx \ . \quad (5.3.2)$$

In stationary phase approximation subject to the additional constraint that a preferred extremal of Kähler action is in question one obtains the desired correlation between the geometry of preferred extremal and the quantum numbers of elementary particle. This interaction term carries information only about the charges of elementary particle. It is

quite possible that the interaction term is more complex: for instance, it could contain spin dependent terms (Stern-Gerlach experiment).

- (g) The constraint coming from preferred extremal property of Kähler action can be expressed in terms of Lagrange multipliers

$$S_c = \int_{Y^2} \lambda^k D_\alpha \left(\frac{\partial L_K}{\partial_\alpha h^k} \right) \sqrt{g_2} d^2 y . \quad (5.3.3)$$

- (h) The action exponential reads as

$$\exp(iS_G + S_{\text{braid}} + S_c) . \quad (5.3.4)$$

The resulting field equations couple stringy M^4 degrees of freedom to the second variation of Kähler action with respect to M^4 coordinates and involve third derivatives of M^4 coordinates at the right hand side. If the second variation of Kähler action with respect to M^4 coordinates vanishes, free string results. This is trivially the case if a vacuum extremal of Kähler action is in question.

- (i) An interesting question is whether the preferred extremal property boils down to the condition that the second variation of Kähler action with respect to M^4 coordinates vanishes so that gravitonic string is free. The physical interpretation would be in terms of quantum criticality which is the basic conjecture about the dynamics of quantum TGD. This is clear from the fact that in 1-D system criticality means that the potential $V(x) = ax + bx^2 + ..$ has $b = 0$. In field theory criticality corresponds to the vanishing of the term $m^2 \phi^2/2$ so that massless situation corresponds to massless theory and criticality and long range correlations.

5.3.2 What does the equality of gravitational and inertial masses mean?

Consider next the question in what form Equivalence Principle could be realized in this framework.

- (a) Coset construction inspires the conjecture that gravitational and inertial four-momenta are identical. Also some milder form of it would make sense. What is clear is that the construction of preferred extremal involving the distribution of $M^2(x)$ implies that conserved four-momentum associated with Kähler action can be expressed formally as stringy four-momentum. The integral of the conserved inertial momentum current over X^3 indeed reduces to an integral over the curve defining string as one integrates over other two degrees of freedom. It would not be surprising if a stringy expression for four-momentum would result but with string tension depending on the point of string and possibly also on the component of four-momentum. If the dependence of string tension on the point of string and on the choice of the stringy world sheet is slow, the interpretation could be in terms of coupling constant evolution associated with the stringy coordinates. An alternative interpretation is that string tension corresponds to a scalar field. A quite reasonable option is that for given X_l^3 T defines a scalar field and that the observed T corresponds to the average value of T over deformations of X_l^3 .
- (b) The minimum option is that Kähler mass is equal to the sum gravitational masses assignable to strings connecting points of wormhole throat or two different wormhole throats. This hypothesis makes sense even for wormhole contacts having size of order Planck length.
- (c) The condition that gravitational mass equals to the inertial mass (rest energy) assigned to Kähler action is the most obvious condition that one can imagine. The breaking of Poincare invariance to Lorentz invariance with respect to the tip of CD supports this form of Equivalence Principle. This would predict the value of the ratio of the parameter $R^2 T$ and p-adic length scale hypothesis would allow only discrete values for this parameter. $p \simeq 2^k$ following from the quantization of the temporal distance $T(n)$ between the tips of

CD as $T(n) = 2^n T_0$ would suggest string tension $T_n = 2^n R^2$ apart from a numerical factor. $G_p \propto 2^n R^2 / \hbar_0$ would emerge as a prediction of the theory. G could be seen as a prediction or RG invariant input parameter fixed by quantum criticality. The arguments related to p-adic coupling constant evolution suggest $R^2 / \hbar_0 G = 3 \times 2^{23}$ [K30].

- (d) The scalar field property of string tension should be consistent with the vacuum degeneracy of Kähler action. For instance, for the vacuum extremals of Kähler action stringy action is non-vanishing. The simplest possibility is that one includes the integral of the scalar $J^{\mu\nu} J_{\mu\nu}$ over the degrees transversal to M^2 to the stringy action so that string tension vanishes for vacuum extremals. This would be nothing but dimensional reduction of 4-D theory to a 2-D theory using the slicing of $X^4(X_1^3)$ to partonic 2-surfaces and stringy world sheets. For cosmic strings Kähler action reduces to stringy action with string tension $T \propto 1/g_K^2 R^2$ apart from a numerical constant. If one wants consistency with $T \propto 1/L_p^2$, one must have $T \propto 1/g_K^2 2^n R^2$ for the cosmic strings deformed to Kähler magnetic flux tubes. This looks rather plausible if the thickness of deformed string in M^4 degrees of freedom is given by p-adic length scale.

Should one introduce induced spinor fields at string world sheets?

In the previous section it was found that TGD should allow also dimensionally reduced descriptions in terms of either string world sheets or partonic 2-surfaces. This raises the question whether it makes sense to introduce induced spinor fields at string world sheets. This is indeed the case. The modified Dirac action would in this case correspond to the Dirac operator for the dimensionally reduced Kähler action. The effective minimal surface property of Y^2 would guarantee the conservation of the super current. The realization of the effective 3-dimensionality in turn means that the stringy coordinate u corresponds to a gauge degree of freedom or to the condition $D_u \Psi = 0$. There would no spinor waves propagating along this direction of string and only the deformations of string represented by symplectic and Kac-Moody algebras present also in the dynamics of Kähler action responsible for the p-adic thermodynamics would be present. Besides this there would be the fermionic excitations associated with the ends of the string and correspond to the eigenmodes of $D_K(X^2)$ or equivalently with $D_K(Y^1)$ so that the Dirac determinant would be the same as obtained for D_K . For the description in terms of partonic 2-surfaces the Dirac operator would be just $D_K(X^2)$ and also now the equivalence with the 4-D description follows trivially.

5.3.3 What is the connection with General Relativity?

The connection with the stringy description makes it easier to believe that General Relativity gives a reasonable approximate description of gravitational interactions in long length scales also in TGD framework. The vacuum degeneracy of Kähler action is in key role here. The topological condensation of CP_2 type vacuum extremals representing fermions and pieces of CP_2 type extremals (wormhole contacts) identified as gauge bosons deforms the vacuum extremals to non-vacuum extremals, and the resulting density of inertial momentum equals to the density of gravitational momentum in stringy sense. If stringy gravitational energy momentum density is proportional to $1/L_p^2$ and if G relates to L_p^2 in the proposed manner, the natural hypothesis is that Einstein tensor provides a good approximation for the density of gravitational four-momentum as non-conserved Noether currents for the curvature scalar action associated with the induced metric. In zero energy ontology the non-conservation of the density of gravitational momentum does not lead to a contradiction with the conservation of inertial four-momentum since inertial four-momentum is defined only for CD in given scale so that conservation laws hold also only in this scale and in finite measurement resolution.

5.3.4 What does one mean with the evolution of gravitational constant?

From above it is clear that although it is possible to speak about the evolution of string tension $T(x)$ for string space-time sheets inside given CD , it does not makes sense to speak about

evolution of G inside CD s because the relationship between T and G is not so simple as one might naively expect. One can of course consider the possibility that $T(x)$ is RG invariant and thus constant for the preferred extremals of Kähler action. This could hold modulo finite measurement resolution for M^4 coordinates defined by the size of the sub- CD s of a given CD . Hence string model description would be exact under quantum criticality assumption in the sense that the second variation of Kähler action with respect to M^4 coordinates vanishes.

As found, gravitational constant can be understood as a product of L_p^2 with the exponential of Kähler action for the two pieces of CP_2 type vacuum extremals representing wormhole contacts assignable to graviton connected by string world sheet. The volume of the typical CP_2 type extremals associated with the graviton increases with L_p so that the exponential factor decreases reducing the growth due to the increase of L_p . Hence G could be RG invariant in p-adic coupling constant evolution: this requires that volume depends on logarithmically on L_p . This point will be discussed in more detail later.

5.4 RG invariance of gauge couplings inside CD

The first question is whether the RG evolution of all gauge couplings could have interpretation as a flow at space-time level and what the flow in question could be. Second question is how the p-adic coupling constant evolution suggesting that coupling constants are piece constant functions of length scale is realized at space-time level. The obvious guess would be that RG invariance holds true for given CD . This would conform with the fact that partonic wormhole throats associated with the light-like boundaries of CD s can be regarded as carriers of quantum numbers in zero energy ontology.

5.4.1 Are all gauge couplings RG invariants within given CD ?

No extremals for which the gauge currents would have non-vanishing ordinary divergence are known at this moment (gauge currents are light-like always). Therefore one cannot exclude the possibility that all gauge coupling constants are renormalization group invariants within given CD , so that the hypothesis that RG evolution reduces to a discrete p-adic coupling constant evolution would be correct.

This requires that also Weinberg angle, being determined by the ratio of $SU(2)$ and $U(1)$ couplings, is constant inside a given space-time sheet. Its value in this case is determined most naturally by the requirement that the net vacuum em charge of the space-time sheet vanishes.

A further hypothesis is Kähler coupling strength is invariant also under p-adic coupling constant evolution. Kähler coupling strength is in principle prediction of the theory if Dirac determinant gives Kähler action so that this hypothesis can in principle be checked.

5.4.2 Slicing of space-time surface by light-like 3-surfaces

The basic question concerns the identification of the geometric parameter identifiable as the space-time counterpart of the scale associated with RG evolution. Number theoretical compactification gives clues concerning the identification of this kind of parameter.

- (a) Number theoretic compactification implies that the preferred extremals of Kähler action have the property that one can assign to each point of M^4 projection $P_{M^4}(X^4(X_l^3))$ of the preferred extremal $M^2(x)$ identified as the plane of non-physical polarizations and also as the plane in which local massless four-momentum lies.
- (b) If the distribution of the planes $M^2(x)$ is integrable, one can slice $P_{M^4}(X^4(X_l^3))$ to string world-sheets. The intersection of string world sheets with $X^3 \subset \delta M_{\pm}^4 \times CP_2$ corresponds to a light-like curve having tangent in local tangent space $M^2(x)$ at light-cone boundary. This is the first candidate for the definition of number theoretic braid. Second definition assumes M^2 to be fixed at δCD : in this case the slicing is parameterized by the sphere S^2 defined by the light rays of δM_{\pm}^4 .

- (c) Another slicing is based on the use of light-like 3-surfaces for which second light-like coordinate associated with M^2 - call it u - is constant for a given slice. By general coordinate invariance it should be a matter of taste whether deduced the predictions of the theory using any of these light-like 3-surfaces. In particular the value of Kähler function remains invariant. The conditions guaranteeing under what conditions this is true are discussed in [K19, K23]

The natural identification of the RG group parameter would be as the light-like coordinate u of M^4 . This parameter corresponds roughly to radial motion away from wormhole throat and in this sense scaling. Light-likeness however means that M^4 length along this coordinate line is zero so that the length of RG parameter does not increase during RG evolution. Hence RG invariance looks natural.

5.4.3 Coupling constant evolution as evolution of classical gauge fluxes

Wormhole throats are in special role in the evolution as fixed points which is obvious from the fact that the determinant of induced metric approaches to zero. At the wormhole throats one must pose the conditions $g_{ui} = 0$ and $J_{ui} = 0$ in order to guarantee that the normal components of conserved currents vanish. This guarantees standard conservation laws for space-like 3-surfaces and is also required by zero energy ontology. The condition J_{ui} does not imply that the flux of Kähler electric field associated with 2-surface at wormhole throat vanishes. The point is that J^{uv} diverges whereas $\sqrt{g_4}$ vanishes at this limit and the limiting value of the flux defined by $J^{ub}\sqrt{g_4}$ can be finite and should be so unless there is Kähler charge density associated with vacuum, or more precisely, $j^u = D_i J^{ui}$ is non-vanishing. j^v can be non-vanishing and would mean that there are light-like currents along the light-like 3-surfaces Y_l^3 associated with the slicing. This of course conforms with the idea that any light-like 3-surface can be regarded as a carrier of quantum numbers. The only known extremals of Kähler action for which gauge currents are non-vanishing are indeed those for which they are light-like. If $j^v = 0$ holds for Kähler current it holds true for all gauge currents and it would not be surprising that the gauge fluxes vanish.

Consider first electro-weak coupling constant evolution.

- (a) It is natural to restrict the coupling constant evolution to the neutral part F_{nc} of the electro-weak gauge field consisting of γ and Z^0 , whose expressions in terms of Kähler form and R_{03} component of spinor curvature are given by

$$\begin{aligned} F_{nc} &= \gamma Q_{em} + Z^0 (I_L^3 - \sin^2 \theta_W Q_{em}) , \\ \gamma &= 3J - \sin^2 \theta_W R_{03} , \\ Z^0 &= 2R_{03} . \end{aligned} \tag{5.4.1}$$

These expressions are discussed in more detail in Appendix.

- (b) One must find a gauge field which is Abelian in order that the notion of gauge flux is well-defined. If one restricts the consideration to right-handed parts Z^0 and γ this is achieved since W has only left handed part. The fluxes are determined by γ and Z^0 and the charge matrices multiplied with $(1 - \gamma_5)$ and I_L^3 is dropped from the charge matrix of Z^0 .
- (c) Quantum classical correspondence suggests a quantization of classical gauge charged. This can be understood as resulting from the presence of phase factors of form $\exp(i(dx^{mu}/dv)Tr(QA_\mu))$ associated with braid strands at X_l^3 . In stationary phase approximation an extremal with classical charges equal to those associated with positive (negative) energy part of zero energy state is selected. This extremal should have the property that classical gauge flux equals to the appropriate diagonal element of charge matrix multiplied by the corresponding coupling constant. This boils down to the conditions

$$\begin{aligned}
e\langle Q_{em} \rangle &= \int \gamma da = (3J - \sin^2(\theta_W)R_{03})da \ , \\
-g_Z \sin^2(\theta_W)\langle Q_{em} \rangle &= \int Z_0 da = 2 \int R_{03} da \ .
\end{aligned}
\tag{5.4.2}$$

The most natural possibility is that the diagonal charge matrix element is between positive and negative energy parts of the zero energy state associated with CD . A stronger form of quantum classical correspondence would require that similar equations hold true also for the fluxes of W bosons. The expectation values would be vanishing in charge eigen states so that also the classical fluxes should vanish.

- (d) Since the fluxes of J and R_{03} remain constant by the previous assumption e and g_Z are RG invariants if $\sin^2(\theta_W)$ is RG invariant. There is no natural manner for $\sin^2(\theta)$ to evolve since it is determined in terms of quantities associated with the throats associated with gauge boson wormhole contact.

The RG evolution of α_s inside CD can be discussed along similar lines.

- (a) Color gauge field is given by $G^A = kH^A J_{\alpha\beta}$, where k is numerical constant and H^A is a Hamiltonian of color isometry. Color gauge field has Abelian holonomy, which suggests that one can reduce the situation to Abelian one by performing a local gauge rotation rotating the color gauge field to a fixed direction. This is however somewhat tricky point since strictly local color rotations are not symmetries of Kähler action. The naive guess would be

$$g_s\langle T^A \rangle = k \int H^A J da \ , \tag{5.4.3}$$

Also no expectation would be naturally between positive and negative energy parts of zero energy state. Only the fluxes associated with I_3 and Y_A would be non-vanishing so that additional conditions of color fluxes would be obtained.

- (b) The formula

$$\frac{1}{\alpha_{em}} + \frac{1}{\alpha_s} = \frac{1}{\alpha_K}$$

proposed in previous section would fix the p-adic evolution of color coupling and imply the RG invariance of α_s within given CD .

5.4.4 Questions related to the physical interpretation

This picture raises several interesting questions related to the physical interpretation.

- (a) What is the TGD counterpart of Higgs=0 phase? The dimension of CP_2 projection is analogous to temperature and one can argue that massivation is analogous to a loss of correlations due to the increase of D bringing in additional degrees of freedom. Massless extremals having $D = 2$ all induced gauge fields are massless so that they are excellent candidates for Higgs=0 phase. Indeed, the construction of S-matrix leads to the interpretation that MEs allow massless particle exchanges with arbitrary long range but the very fact that the scattering is limited to massless momentum exchanges it is difficult to detect. Note that this scattering is not possible in two-particle system. Does the result mean that already $D = 3$ space-time sheets correspond to a massive phase?
- (b) Why electro-weak length scale corresponding to Mersenne prime M_{89} is preferred [K48] ? Are there also other length scales in which electro-weak massivation occurs and thus scaled copies of electro-weak bosons? These questions reduce to the questions about the stability of the proposed bifurcations.

- (c) The basic problem of TGD based model of condensed matter is to explain why classical long range gauge fields do not give rise to large parity breaking effects in atomic length scale but do so in cell length length scale at least in the case of living matter (bio-catalysis). The proposal has been that particles feed electro-weak and em gauge fluxes to different space-time sheets. Could it be that blocks of bio-matter with size larger than cell the space-time sheets at which em and weak charges are feeded can be in Higgs=0 phase whereas for smaller blocks screening occurs already at quark and lepton level.

This would be consistent with the fact that the dimension D of CP_2 projection tends to decrease with the size of the space-time sheet: the larger the space-time sheet, the nearer it is to a vacuum extremal. Robertson-Walker cosmologies are exact vacuum extremals carrying however non-vanishing gravitational 4-momentum densities. By previous argument W and Z masses are identical in this kind of phase if the vanishing of vacuum em field is used to fix p . The weakening of correlations caused by classical non-determinism might imply massivation.

- (d) Do long ranged non-screened vacuum Z^0 and W gauge fields have some quantum counterparts as quantum-classical correspondence would suggest? Does dark matter identified as a phase with large value of \hbar [K25] correspond to a phase in which electro-weak symmetry breaking is absent in the bosonic sector?

This phase would differ from the ordinary one in that the weak charges of dark counterparts of leptons and quarks are not screened in electro-weak length scale but that their masses are very nearly the same as in Higgs=0 phase since the dominant contribution to the masses of elementary fermions is not given by a coupling to Higgs type particle but determined by p-adic thermodynamics [K48, K48]. According to the TGD based model of condensed matter developed in [K27], em charges would be feeded to space-time sheets of order atomic size in this phase.

Does bio-matter involve this kind of phase at larger space-time sheets as chirality selection suggests [K27]? Does this phase of condensed matter emerge only above length scale defined by the cell size or cell membrane thickness?

The possibility to assign separate spectrum of values of M^4 and CP_2 Planck constants means also spectrum of scale factors of metric for both M^4 and CP_2 with scaling of covariant metric given by the square of integer n characterizing the quantum phase. If gravitational Planck constant can be identified as CP_2 Planck constant, gigantic values of CP_2 radius are possible in the sectors of the imbedding space corresponding to the dark matter.

Even if one does not accept this identification, the conclusion would seem to be that CP_2 radius can be very large in these phases. Obviously the ranges of weak and color interactions in this kind of phases would be macroscopic and even astrophysical. Second implication would be the presence of precise quantal lattice like structure involving strict quantum correlations in macroscopic length scales. The unavoidable question is whether the extremely tiny size of CP_2 could be scaled up to a macroscopic length scale even at the level of living matter and whether even the science fictive notion of hyper-space travel (which I have never liked!) might make sense after all.

- (e) An interesting question relates to the predicted presence of long ranged classical color gauge fields in all length scales suggesting a hierarchy of QCD type physics if quantum classical correspondence is taken seriously. The possibility to define the color Hamiltonians apart from an additive constant in principle makes possible to have vanishing classical color isospin and hyper charges at a given space-time sheet without affecting the color transformation properties of Hamiltonians. It is however far from clear whether this trick is enough. A more natural approach is to take seriously the prediction of infinite p-adic hierarchy of QCD type physics and look what the implications are.

5.5 Quantitative predictions for the values of coupling constants

This focus of attention in this section is in quantitative for the p-adic evolution of couplings constants obtained by combining information coming from p-adic mass calculations with number theoretic constraints and general formula for gravitational constant inspired by simple physical picture.

5.5.1 A revised view about coupling constant evolution

The development of the ideas related to number theoretic aspects has been rather tortuous and based on guess work since basic theory has been lacking.

- (a) The original hypothesis was that Kähler coupling strength is invariant under p-adic coupling constant evolution. Later I gave up this hypothesis and replaced it with the invariance of gravitational coupling since otherwise the prediction would have been that gravitational coupling strength is proportional to p-adic length scale squared. Second first guess was that Kähler coupling strength equals to the value of fine structure constant at electron length scale corresponding to Mersenne prime M_{127} . Later I replaced fine structure constant with electro-weak U(1) coupling strength at this length scale. The recent discussion returns back to the roots in both aspects.
- (b) The recent discussion relies on the progress made in the understanding of quantum TGD at partonic level [K19]. What comes out is an explicit formula for Kähler couplings strength in terms of Dirac determinant involving only a finite number of eigenvalues of the modified Dirac operator. This formula dictates the number theoretical anatomy of g_K^2 and also of other coupling constants: the most general option is that α_K is a root of rational. The requirement that the rationals involved are simple combined with simple experimental inputs leads to very powerful predictions for the coupling parameters.
- (c) A further simplification is due to the discreteness of p-adic coupling constant evolution allowing to consider only length scales coming as powers of $\sqrt{2}$. This kind of discretization is necessary also number theoretically since logarithms can be replaced with 2-adic logarithms for powers of 2 giving integers. This raises the question whether $p \simeq 2^k$ should be replaced with 2^k in all formulas as the recent view about quantum TGD suggests.
- (d) The prediction is that Kähler coupling strength α_K is invariant under p-adic coupling constant evolution and from the constraint coming from electron and top quark masses very near to fine structure constant so that the identification as fine structure constant is natural. Gravitational constant is predicted to be proportional to p-adic length scale squared and corresponds to the largest Mersenne prime (M_{127}), which does not correspond to a completely super-astronomical p-adic length scale. For the parameter R^2/G p-adicization program allows to consider two options: either this constant is of form e^q or 2^q : in both cases q is rational number. $R^2/G = \exp(q)$ allows only M_{127} gravitons if number theory is taken completely seriously. $R^2/G = 2^q$ allows all p-adic length scales for gravitons and thus both strong and weak variants of ordinary gravitation.
- (e) A relationship between electromagnetic and color coupling constant evolutions based on the formula $1/\alpha_{em} + 1/\alpha_s = 1/\alpha_K$ is suggested by the induced gauge field concept, and would mean that the otherwise hard-to-calculate evolution of color coupling strength is fixed completely. The predicted value of α_s at intermediate boson length scale is correct.

It seems fair to conclude that the attempts to understand the implications of p-adicization for coupling constant evolution have begun to bear fruits.

General formula for the Kähler coupling strength

The identification of exponent of Kähler function as Dirac determinant leads to a formula relating Kähler action for the preferred extremal to the Dirac determinant. The eigenvalues are proportional to $1/\alpha_K$ since the matrices $\hat{\Gamma}^\alpha$ have this proportionality. This gives the formula

$$\exp\left(\frac{S_{K,R}(X^4(X^3))}{2g_K^2}\right) = \prod_i \lambda_i = \frac{\prod_i \lambda_{0,i}}{(g_K)^{2N}} . \tag{5.5.1}$$

Here $\lambda_{0,i}$ by definition corresponds to $g_K^2 = 4\pi\alpha_K = 1$. $S_{K,R} = \int J^*J$ is the reduced Kähler action.

For $S_{K,R} = 0$, which might correspond to so called massless extremals [K11] one obtains the formula

$$g_K^2 = \left(\prod_i \lambda_{0,i}\right)^{1/N} . \tag{5.5.2}$$

Thus for $S_{K,R} = 0$ extremals one has an explicit formula for g_K^2 having interpretation as the geometric mean of the eigenvalues $\lambda_{0,i}$. Several values of α_K are in principle possible.

p-Adicization suggests that $\lambda_{0,i}$ are rational or at most algebraic numbers. This would mean that g_K^2 is N :th root of this kind of number. $S_{K,R}$ in turn would be

$$S_{K,R} = 2g_K^2 \log\left(\frac{\prod_i \lambda_{0,i}}{g_K^{2N}}\right) . \tag{5.5.3}$$

so that the reduced Kähler action $S_{K,R}$ would be expressible as a product N :th root of rational, and logarithm of rational. This result would provide a general answer to the question about number theoretical anatomy of Kähler coupling strength and S_K .

For CP_2 type vacuum extremal one would have $S_{K,R} = \frac{\pi^2}{2}$ in apparent conflict with the above result. The conflict is of course only apparent since topological condensation of CP_2 type vacuum extremal generates a hole in CP_2 having light-like wormhole throat as boundary so that the value of the action is modified.

Identifications of Kähler coupling strength and gravitational coupling strength

To construct an expression for gravitational constant one can use the following ingredients.

- (a) The exponent $\exp(S_K(CP_2))$ defining vacuum functional and thus the value of Kähler function in terms of the Kähler action $S_K(CP_2)$ of CP_2 type extremal representing elementary particle expressible as

$$S_K(CP_2) = \frac{S_{K,R}(CP_2)}{8\pi\alpha_K} = \frac{\pi}{8\alpha_K} . \tag{5.5.4}$$

Since CP_2 type extremals suffer topological condensation, one expects that the action is modified:

$$S_K(CP_2) \rightarrow a \times S_K(CP_2) . \tag{5.5.5}$$

$a < 1$ conforms with the idea that a piece of CP_2 type extremal defining a wormhole contact is in question. One must however keep mind open in this respect.

- (b) The p-adic length scale L_p assignable to the space-time sheet along which gravitational interactions are mediated. Since Mersenne primes seem to characterized elementary bosons and since the Mersenne prime $M_{127} = 2^{127} - 1$ defining electron length scale is the largest non-super-astronomical length scale it is natural to guess that M_{127} characterizes these space-time sheets.

1. The formula for the gravitational constant

A long standing basic conjecture has been that gravitational constant satisfies the following formula

$$\begin{aligned} \hbar G &\equiv r\hbar_0 G = L_p^2 \times \exp(-2aS_K(CP_2)) , \\ L_p &= \sqrt{p}R . \end{aligned} \quad (5.5.6)$$

Here R is CP_2 radius defined by the length $2\pi R$ of the geodesic circle. What was noticed before is that this relationship allows even constant value of G if a has appropriate dependence on p .

This formula seems to be correct but the argument leading to it was based on two erratic assumptions compensating each other.

- (a) I assumed that modulus squared for vacuum functional is in question: hence the factor $2a$ in the exponent. The interpretation of zero energy state as a generalized Feynman diagram requires the use of vacuum functional so that the replacement $2a \rightarrow a$ is necessary.
- (b) Second wrong assumption was that graviton corresponds to CP_2 type vacuum extremal—that is wormhole contact in the recent picture. This does allow graviton to have spin 2. Rather, two wormhole contacts represented by CP_2 vacuum extremals and connected by fluxes associated with various charges at their throats are needed so that graviton is string like object. This saves the factor $2a$ in the exponent.

The highly non-trivial implication to be discussed later is that ordinary coupling constant strengths should be proportional to $\exp(-aS_K(CP_2))$.

The basic constraint to the coupling constant evolution comes for the invariance of g_K^2 in p-adic coupling constant evolution:

$$\begin{aligned} g_K^2 &= \frac{a(p,r)\pi^2}{\log(pK)} , \\ K &= \frac{R^2}{\hbar G(p)} = \frac{1}{r} \frac{R^2}{\hbar_0 G(p)} \equiv \frac{K_0(p)}{r} . \end{aligned} \quad (5.5.7)$$

2. How to guarantee that g_K^2 is RG invariant and N :th root of rational?

Suppose that g_K^2 is N :th root of rational number and invariant under p-adic coupling constant evolution.

- (a) The most general manner to guarantee the expressibility of g_K^2 as N :th root of rational is guaranteed for both options by the condition

$$a(p,r) = \frac{g_K^2}{\pi^2} \log\left(\frac{pK_0}{r}\right) . \quad (5.5.8)$$

That a would depend logarithmically on p and $r = \hbar/\hbar_0$ looks rather natural. Even the invariance of G under p-adic coupling constant evolution can be considered.

- (b) The condition

$$\frac{r}{p} < K_0(p) . \quad (5.5.9)$$

must hold true to guarantee the condition $a > 0$. Since the value of gravitational Planck constant is very large, also the value of corresponding p-adic prime must very large to guarantee this condition. The condition $a < 1$ is guaranteed by the condition

$$\frac{r}{p} > \exp\left(-\frac{\pi^2}{g_K^2}\right) \times K_0(p) . \quad (5.5.10)$$

The condition implies that for very large values of p the value of Planck constant must be larger than \hbar_0 .

- (c) The two conditions are summarized by the formula

$$K_0(p) \times \exp\left(-\frac{\pi^2}{g_K^2}\right) < \frac{r}{p} < K_0(p) \quad (5.5.11)$$

characterizing the allowed interval for r/p . If G does not depend on p , the minimum value for r/p is constant. The factor $\exp\left(-\frac{\pi^2}{g_K^2}\right)$ equals to 1.8×10^{-47} for $\alpha_K = \alpha_{em}$ so that $r > 1$ is required for $p \geq 4.2 \times 10^{-40}$. $M_{127} \sim 10^{38}$ is near the upper bound for p allowing $r = 1$. The constraint on r would be roughly $r \geq 2^{k-131}$ and $p \simeq 2^{131}$ is the first p-adic prime for which $\hbar > 1$ is necessarily. The corresponding p-adic length scale is .1 Angstroms.

This conclusion need not apply to elementary particles such as neutrinos but only to the space-time sheets mediating gravitational interaction so that in the minimal scenario it would be gravitons which must become dark above this scale. This would bring a new aspect to vision about the role of gravitation in quantum biology and consciousness.

The upper bound for r behaves roughly as $r < 2.3 \times 10^7 p$. This condition becomes relevant for gravitational Planck constant $GM_1 M_2 / v_0$ having gigantic values. For Earth-Sun system and for $v_0 = 2^{-11}$ the condition gives the rough estimate $p > 6 \times 10^{63}$. The corresponding p-adic length scale would be of around $L(215) \sim 40$ meters.

- (d) p-Adic mass calculations predict the mass of electron as $m_e^2 = (5 + Y_e)2^{-127}/R^2$ where $Y_e \in [0, 1)$ parameterizes the not completely known second order contribution. Top quark mass favors a small value of Y_e (the original experimental estimates for m_t were above the range allowed by TGD but the recent estimates are consistent with small value Y_e [K56]). The range $[0, 1)$ for Y_e restricts $K_0 = R^2/\hbar_0 G$ to the range $[2.3683, 2.5262] \times 10^7$.
- (e) The best value for the inverse of the fine structure constant is $1/\alpha_{em} = 137.035999070(98)$ and would correspond to $1/g_K^2 = 10.9050$ and to the range $(0.9757, 0.9763)$ for a for $\hbar = \hbar_0$ and $p = M_{127}$. Hence one can seriously consider the possibility that $\alpha_K = \alpha_{em}(M_{127})$ holds true. As a matter fact, this was the original hypothesis but was replaced later with the hypothesis that α_K corresponds to electro-weak $U(1)$ coupling strength in this length scale. The fact that M_{127} defines the largest Mersenne prime, which does not correspond to super-astrophysical length scale might relate to this co-incidence.

To sum up, the recent view about coupling constant evolution differs strongly from previous much more speculative scenarios. It implies that g_K^2 is root of rational number, possibly even rational, and can be assumed to be equal to e^2 . Also $R^2/\hbar G$ could be rational. The new element is that G need not be proportional to p and can be even invariant under coupling constant evolution since the the parameter a can depend on both p and r . An unexpected constraint relating p and r for space-time sheets mediating gravitation emerges.

Are the color and electromagnetic coupling constant evolutions related?

Classical theory should be also able to say something non-trivial about color coupling strength α_s too at the general level. The basic observations are following.

- (a) Both classical color YM action and electro-weak $U(1)$ action reduce to Kähler action.
- (b) Classical color holonomy is Abelian which is consistent also with the fact that the only signature of color that induced spinor fields carry is anomalous color hyper charge identifiable as an electro-weak hyper charge.

Suppose that α_K is a strict RG invariant. One can consider two options.

- (a) The original idea was that the sum of classical color action and electro-weak $U(1)$ action is RG invariant and thus equals to its asymptotic value obtained for $\alpha_{U(1)} = \alpha_s = 2\alpha_K$. Asymptotically the couplings would approach to a fixed point defined by $2\alpha_K$ rather than to zero as in asymptotically free gauge theories.

Thus one would have

$$\frac{1}{\alpha_{U(1)}} + \frac{1}{\alpha_s} = \frac{1}{\alpha_K} . \quad (5.5.12)$$

The relationship between $U(1)$ and em coupling strengths is

$$\begin{aligned} \alpha_{U(1)} &= \frac{\alpha_{em}}{\cos^2(\theta_W)} \simeq \frac{1}{104.1867} , \\ \sin^2(\theta_W)|_{10 \text{ MeV}} &\simeq 0.2397(13) , \\ \alpha_{em}(M_{127}) &= 0.00729735253327 . \end{aligned} \quad (5.5.13)$$

Here Weinberg angle corresponds to 10 MeV energy is reasonably near to the value at electron mass scale. The value $\sin^2(\theta_W) = 0.2397(13)$ corresponding to 10 MeV mass scale [E193] is used. Note however that the previous argument implying $\alpha_K = \alpha_{em}(M_{127})$ excludes $\alpha = \alpha_{U(1)}(M_{127})$ option.

- (b) Second option is obtained by replacing $U(1)$ with electromagnetic gauge $U(1)_{em}$.

$$\frac{1}{\alpha_{em}} + \frac{1}{\alpha_s} = \frac{1}{\alpha_K} . \quad (5.5.14)$$

Possible justifications for this assumption are following. The notion of induced gauge field makes it possible to characterize the dynamics of classical electro-weak gauge fields using only the Kähler part of electro-weak action, and the induced Kähler form appears only in the electromagnetic part of the induced classical gauge field. A further justification is that em and color interactions correspond to unbroken gauge symmetries.

The following arguments are consistent with this conclusion.

- (a) In TGD framework coupling constant is discrete and comes as powers of $\sqrt{2}$ corresponding to p-adic primes $p \simeq 2^k$. Number theoretic considerations suggest that coupling constants g_i^2 are algebraic or perhaps even rational numbers, and that the logarithm of mass scale appearing as argument of the renormalized coupling constant is replaced with 2-based logarithm of the p-adic length scale so that one would have $g_i^2 = g_i^2(k)$. g_K^2 is predicted to be N :th root of rational but could also reduce to a rational. This would allow rational values for other coupling strengths too. This is possible if $\sin(\theta_W)$ and $\cos(\theta_W)$ are rational numbers which would mean that Weinberg angle corresponds to a Pythagorean triangle as proposed already earlier. This would mean the formulas $\sin(\theta_W) = (r^2 - s^2)/(r^2 + s^2)$ and $\cos(\theta_W) = 2rs/(r^2 + s^2)$.
- (b) A very strong prediction is that the beta functions for color and $U(1)$ degrees of freedom are apart from sign identical and the increase of $U(1)$ coupling compensates the decrease of the color coupling. This allows to predict the hard-to-calculate evolution of QCD coupling constant strength completely.
- (c) $\alpha(M_{127}) = \alpha_K$ implies that M_{127} defines the confinement length scale in which the sign of α_s becomes negative. TGD predicts that also M_{127} copy of QCD should exist and that M_{127} quarks should play a key role in nuclear physics [K77, L2] , [L2] . Hence one can argue that color coupling strength indeed diverges at M_{127} (the largest not completely super-astrophysical Mersenne prime) so that one would have $\alpha_K = \alpha(M_{127})$. Therefore the precise knowledge of $\alpha(M_{127})$ in principle fixes the value of parameter $K = R^2/G$ and thus also the second order contribution to the mass of electron.

- (d) $\alpha_s(M_{89})$ is predicted to be $1/\alpha_s(M_{89}) = 1/\alpha_K - 1/\alpha(M_{89})$. $\sin^2(\theta_W) = .23120$, $\alpha_{em}(M_{89}) \simeq 1/127$, and $\alpha_{U(1)} = \alpha_{em}/\cos^2(\theta_W)$ give $1/\alpha_{U(1)}(M_{89}) = 97.6374$. $\alpha = \alpha_{em}$ option gives $1/\alpha_s(M_{89}) \simeq 10$, which is consistent with experimental facts. $\alpha = \alpha_{U(1)}$ option gives $\alpha_s(M_{89}) = 0.1572$, which is larger than QCD value. Hence $\alpha = \alpha_{em}$ option is favored.

To sum up, the proposed formula would dictate the evolution of α_s from the evolution of the electro-weak parameters without any need for perturbative computations. Although the formula of proposed kind is encouraged by the strong constraints between classical gauge fields in TGD framework, it should be deduced in a rigorous manner from the basic assumptions of TGD before it can be taken seriously.

Can one deduce formulae for gauge couplings?

The improved physical picture behind gravitational constant allows also to consider a general formula for gauge couplings.

- (a) The natural guess for the general formula would be as

$$g^2(p, r) = kg_K^2 \times \exp[-a_g(p, r) \times S_K(CP_2)] . \quad (5.5.15)$$

here k is a numerical constant.

- (b) The condition

$g_K^2 = e^2(M_{127})$ fixes the value of k if it's value does not depend on the character of gauge interaction:

$$k = \exp[a_{gr}(M_{127}, r = 1) \times S_K(CP_2)] . \quad (5.5.16)$$

Hence the general formula reads as

$$g^2(p, r) = g_K^2 \times \exp[(-a_g(p, r) + a_{gr}(M_{127}, r = 1)) \times S_K(CP_2)] . \quad (5.5.17)$$

The value of $a(M_{127}, r = 1)$ is near to its maximum value so that the exponential factor tends to increase the value of g^2 from e^2 . The formula can reproduce α_s and various electro-weak couplings although it is quite possible that Weinberg angle corresponds to a group theoretic factor not representable in terms of $a_g(p, r)$. The volume of the CP_2 type vacuum extremal would characterize gauge bosons. Analogous formula should apply also in the case of Higgs.

- (c) α_{em} in very long length scales would correspond to

$$e^2(p \rightarrow \infty, r = 1) = e^2 \times \exp[(-1 + a(M_{127}, r = 1)) \times S_K(CP_2)] = e^2 x , \quad (5.5.18)$$

where x is in the range $[0.6549, 0.6609]$.

Formula relating v_0 to α_K and $R^2/\hbar G$

The parameter $v_0 = 2^{-11}$ plays a key role in the formula for gravitational Planck constant and can be also seen as a fundamental constant in TGD framework. As a matter, factor v_0 has interpretation as velocity parameter and is dimensionless when $c = 1$ is used.

If v_0 is identified as the rotation velocity of distant stars in galactic plane, one can use the Newtonian model for the motion of mass in the gravitational field of long straight string giving $v_0 = \sqrt{TG}$. String tension T can be expressed in terms of Kähler coupling strength as

$$T = \frac{b}{2\alpha_K R^2} ,$$

where R is the radius of geodesic circle. The factor $b \leq 1$ would explain reduction of string tension in topological condensation caused by the fact that not entire geodesic sphere contributes to the action.

This gives

$$\begin{aligned} v_0 &= \frac{b}{2\sqrt{\alpha_K K}} , \\ \alpha_K(p) &= \frac{a\pi}{4\log(pK)} , \\ K &= \frac{R^2}{\hbar G} . \end{aligned} \tag{5.5.19}$$

The condition that α_K has the desired value for $p = M_{127} = 2^{127} - 1$ defining the p-adic length scale of electron fixes the value of b for given value of a . The value of b should be smaller than 1 corresponding to the reduction of string tension in topological condensation.

The condition 5.5.19 for $v_0 = 2^{-m}$, say $m = 11$, allows to deduce the value of a/b as

$$\frac{a}{b} = \frac{4 * \log(pK)}{\pi} \frac{2^{2m-1}}{K} . \tag{5.5.20}$$

For both $K = e^q$ with $q = 17$ and $K = 2^q$ option with $q = 24 + 1/2$ $m = 10$ is the smallest integer giving $b < 1$. $K = e^q$ option gives $b = .3302$ (.0826) and $K = 2^q$ option gives $b = .3362$ (.0841) for $m = 10$ ($m = 11$).

$m = 10$ corresponds to one third of the action of free cosmic string. $m = 11$ corresponds to much smaller action smaller by a factor rather near $1/12$. The interpretation would be that as m increases the action of the topologically condensed cosmic string decreases. This would correspond to a gradual transformation of the cosmic string to a magnetic flux tube.

To sum up, the resulting overall vision seems to be internally consistent and is consistent with generalized Feynman graphics, predicts exactly the spectrum of α_K , suggests the identification of the inverse of p-adic temperature with k , allows to understand the differences between fermionic and bosonic massivation. One might hope that the additional objections (to be found sooner or later!) could allow to develop a more detailed picture.

5.5.2 Why gravitation is so weak as compared to gauge interactions?

The weakness of gravitational interaction in contrast to other gauge interactions is definitely a fundamental test for the proposed picture. The heuristic argument allowing to understand the value of gravitational constant is based on the assumption that graviton exchange corresponds to the exchange of CP_2 type extremal for which vacuum functional implies huge reduction of the gravitational constant from the value $\sim L_p^2$ implied by dimensional considerations based on p-adic length scale hypothesis to a value $G = \exp(-2S_K)L_p^2$ which for $p = M_{127}$ gives gravitational constant for $\alpha_K = \pi a/\log(M_{127} \times K)$, where a is near unity and $K = 2 \times 3 \times 5 \dots \times 23$ is a choice motivated by number theoretical arguments. The value of K is fixed rather precisely from electron mass scale and the proposed scenario for coupling constant evolution fixes both α_K and K completely in terms of electron mass (using p-adic mass calculations) and electro-magnetic coupling at electron length scale $L_{M_{127}}$ by the formula $\alpha_K = \alpha_{em}$ [K30]. The interpretation would be that gravitational masses are measured using p-adic mass scale $M_p = \pi/L_p$ as a natural unit.

Why gravitational interaction is weak?

The first problem is that CP_2 type extremal cannot represent the lowest order contribution to the interaction since otherwise the normalization of the configuration space vacuum functional would give $\exp[-2S_K(CP_2)]$ factor canceling the exponential in the propagator so that one would have $G = L_p^2$. The following observations allow to understand the solution of the problem.

- (a) As already found, the key feature of CP_2 type vacuum extremals distinguishing them from other 3-surfaces is their non-deterministic behavior allowing them to carry off mass shell four-momenta. Other 3-surfaces can give rise only to scattering involving exchange of on mass shell particles and for space-like momentum exchanges there is no contribution.
- (b) All possible light-like 3-surfaces must be allowed as propagator portions of surfaces X_V^3 but in absence of non-determinism they can give rise to massless exchanges which are typically non-allowed.
- (c) The contributions of CP_2 type vacuum extremals are suppressed by $\exp[-2NS_K(CP_2)]$ factor in presence of N CP_2 type extremals with maximal action. CP_2 type extremals are vacuum extremals and interact with surrounding world only via the topological condensation generating 3-D CP_2 projection near the throat of the wormhole contact. This motivates the assumption that the sector of the configuration space containing N CP_2 type extremals has the approximate structure $CH(N) = CH(0) \times CP^N$, where $CH(0)$ corresponds to the situation without CP_2 type extremals and CP to the degrees of freedom associated with single CP_2 type extremal. With this assumption the functional integral gives a result of form $X \times \exp(-2NS_K(CP_2))$ for N CP_2 type extremals. This factorization allows to forget all the complexities of the world of classical worlds which on the first sight seem to destroy all hopes about calculating something and the normalization factor is in lowest order equal to $X(0)$ whereas single CP_2 type extremal gives $\exp[-2S_K(CP_2)]$ factor. This argument generalizes also to the case when CP_2 type extremals are allowed to have varying value of action (the distance travelled by the virtual particle can vary).

Massless extremals (MEs) define a natural candidate for the lowest order contribution since for them Kähler action vanishes. MEs describes a dispersion free on-mass shell propagation of massless modes of both induced gauge fields and metric. Hence they can describe only on mass shell massless exchanges of bosons and gravitons which typically vanishes for kinematical reasons except for collinear scattering in the case of massless particles so that CP_2 type extremals would give the leading contribution to the S-matrix element.

There are however exceptional situations in which exchange of ordinary CP_2 type extremals makes kinematically possible the emission of MEs as brehmstrahlung in turn giving rise to exchange of light-like momentum. Since MEs carry also classical gravitational fields, one can wonder whether this kind of exchanges could make possible strong on mass shell gravitation made kinematically possible by ordinary gauge boson exchanges inside interacting systems.

If one takes absolutely seriously the number theoretic argument based on $R^2/G = \exp(q)$ ansatz then M_{127} is selected uniquely as the space-time sheet of gravitons and the predicted gravitational coupling strength is indeed weak.

What differentiates between gravitons and gauge bosons?

The simplest explanation for the difference between gauge bosons and gravitons is that for virtual gauge bosons the volume of CP_2 type extremals is reduced dramatically from its maximal value so that $\exp(-2S_K)$ brings in only a small reduction factor. The reason would be that for virtual gauge bosons the length of a typical CP_2 type extremal is far from the value giving rise to the saturation of the Kähler action. For gravitational interactions in astrophysical length scales CP_2 type extremals must indeed be very long.

Gravitational interaction should become strong sufficiently below the saturation length scale with gravitational constant approaching its stringy value L_p^2 . According to the argument discussed in [K30], this length scale corresponds to the Mersenne prime M_{127} characterizing gravitonic

space-time sheets so that gravitation should become strong below electron's Compton length. This suggests a connection with stringy description of graviton. M_{127} quarks connected by the corresponding strings are indeed a basic element of TGD based model of nuclei [K77]. TGD suggests also the existence of lepto-hadrons as bound state of color excited leptons in length scale M_{127} [K84]. Also gravitons corresponding to smaller Mersenne primes are possible but corresponding forces are much weaker than ordinary gravitation. On the other hand, M_{127} is the largest Mersenne prime which does not give rise to super-astronomical p-adic length scale so that stronger gravitational forces are not predicted in experimentally accessible length scales.

More generally, the saturation length scale should relate very closely to the p-adic length scale L_p characterizing the particle. The amount of zitterbewegung determines the amount dS_K/dl of Kähler action per unit length along the orbit of virtual particle. L_p would naturally define the length scale below which the particle moves in a good approximation along M^4 geodesic. The shorter this length scale is, the larger the value of dS_K/dl is.

If the Kähler action of CP_2 type extremal increases linearly with the distance (in a statistical sense at least), an exponential Yukawa screening results at distances much shorter than saturation length. Therefore CP_2 extremals would provide a fundamental description of particle massivation at space-time level. p-Adic thermodynamics would characterize what happens for a topologically condensed CP_2 type extremal carrying given quantum numbers at the resulting light-like CD. Besides p-adic length scale also the quantized value $T_p = 1/n$ of the p-adic temperature would be decisive. For weak bosons Mersenne prime M_{89} would define the saturation length scale. For photons the p-adic length scale defining the Yukawa screening should be rather long. An n-ary p-adic length scale $L_{M_{89}}(n) = p^{(n-1)/2} L_{M_{89}}$ would most naturally be in question so that the p-adic temperature associated with photon would be $T_p = 1/n$, $n > 1$ [K48]. In the case of gluons confinement length scale should be much shorter than the scale at which the Yukawa screening becomes visible. If also gluons correspond to $n > 1$ this is certainly the case.

All gauge interactions would give rise to ultra-weak long ranged interactions, which are extremely weak compared to the gravitational interaction: the ratio for the strengths of these interactions would be of order $\alpha Q_1 Q_2 m_e^2 / M_1 M_2$ and very small for particles whose masses are above electron mass. Note however that MEs give rise to arbitrarily unscreened long ranged weak and color interactions restricted to light-like momentum transfers and these interactions play a key role in the TGD based model of living matter [K25, K26]. This prediction is in principle testable.

5.6 p-Adic coupling constant evolution

p-Adic coupling constant evolution is one of the genuinely new elements of quantum TGD. In the following some aspects of the evolution will be discussed. The discussion is a little bit obsolete as far as the role of canonical identification is considered. The most recent view about p-adic coupling constant evolution is discussed at the end of the section.

5.6.1 p-Adic coupling constant evolution associated with length scale resolution at space-time level

If gauge couplings are indeed RG invariants inside a given space-time sheet, gauge couplings must be regarded as being characterized by the p-adic prime associated with the space-time sheet. The question is whether it is possible to understand also the p-adic coupling constant evolution at space-time level.

A natural view about p-adic length scale evolution is as an existence of a dynamical symmetry mapping the preferred extremal space-time sheet of Kähler action characterized by a p-adic prime p_1 to a space-time sheet characterized by p-adic prime $p_2 > p_1$ sufficiently near to p_1 . The simplest guess is that the symmetry transformation corresponds to a scaling of M^4 coordinates in the intersection X^3 of the space-time surface with light-cone boundary $\delta M_+^4 \times CP_2$ by a scaling factor p_2/p_1 , which in turn induces a transformation of $X^4(X^3)$, which in general does not reduce to M^4 scaling outside X^3 since scalings are not symmetries of the Kähler action.

This transformation induces a change of the vacuum gauge charges: $Q_i \rightarrow Q_i + \Delta Q_i$, and the renormalization group evolution boils down to the condition

$$\frac{Q_i + \Delta Q_i}{g_i^2 + \Delta g_i^2} = \frac{Q_i}{g_i^2} . \quad (5.6.1)$$

The problem is that this transformation has a continuous variant so that p-adic length scale evolution could reduce to continuous one.

A possible resolution of the problem is based on the observation that the values of the gauge charges depend on the initial values of the time derivatives of the imbedding space coordinates. RG invariance at space-time level suggests that small scalings leave the gauge charge and thus also coupling constant invariant. As a matter fact, this seems to be the case for all known extremals since they form scaling invariant families. The scalings by p_2/p_1 for some $p_2 > p_1$ would correspond to critical points in which bi-furcations occur in the sense that two space-time surfaces $X^4(X^3)$ satisfying the minimization conditions for Kähler action and with different gauge charges appear.

The new space-time surface emerging in the bifurcation would obey effective p_2 -adic topology in some length scale range instead of p_1 -adic topology. Stability considerations would dictate whether $p_1 \rightarrow p_2$ transition occurs and could also explain why primes $p \simeq 2^k$, k integer, are favored. This kind of bifurcations or even multi-furcations are certainly possible by the breaking of the classical determinism.

5.6.2 p-Adic evolution in angular resolution and dynamical Planck constant

Quantum phases $q = \exp(i\pi/n)$ characterized Jones inclusions which have turned out to play key role in the understanding of macroscopic quantum phases in TGD framework. The basic idea is that the different values of Planck constant correspond to evolution in angular resolution in p-adic context characterized by quantum phase $q = \exp(i\pi/n)$ characterizing Jones inclusion is. The higher the value of n , the better the angular resolution since the number of different complex phases in extension of p-adic numbers increases with n .

The quantization of Planck constant has been the basic them of TGD for more than one and half years. The breakthrough became with the realization that standard type Jones inclusions lead to a detailed understanding of what is involved and predict very simple spectrum for Planck constants associated with M^4 and CP_2 degrees of freedom. This picture allows to understand also gravitational Planck constant and coupling constant evolution and leads also to the understanding of ADE correspondences (index $\beta \leq 4$ and $\beta = 4$) from the point of view of Jones inclusions.

Jones inclusions and quantization of Planck constants

Jones inclusions combined with simple anyonic arguments turned out to be the key to the unification of existing heuristic ideas about the quantization of Planck constant.

- (a) The new view allows to understand how and why Planck constant is quantized and gives an amazingly simple formula for the separate Planck constants assignable to M^4 and CP_2 and appearing as scaling constants of their metrics. This in terms of a mild generalizations of standard Jones inclusions. The emergence of imbedding space means only that the scaling of these metrics have spectrum: their is no landscape.
- (b) In ordinary phase Planck constants of M^4 and CP_2 are same and have their standard values. Large Planck constant phases correspond to situations in which a transition to a phase in which quantum groups occurs. These situations correspond to standard Jones inclusions in which Clifford algebra is replaced with a sub-algebra of its G-invariant elements. G

is product $G_a \times G_b$ of subgroups of $SL(2, C)$ and $SU(2)_L \times U(1)$ which also acts as a subgroup of $SU(3)$. Space-time sheets are $n(G_b)$ -fold coverings of M^4 and $n(G_a)$ -fold coverings of CP_2 generalizing the picture which has emerged already. An elementary study of these coverings fixes the values of the scaling factors of M^4 and CP_2 Planck constants to orders of the maximal cyclic sub-groups: $\hbar(M^4) = n_a$ and $\hbar(CP_2) = n_b$ whereas scaling factors of M^4 and CP_2 metrics are n_b^2 and n_a^2 respectively.

At the level of Schrödinger equation this means that Planck constant \hbar corresponds to the effective Planck constant $\hbar_{eff} = (\hbar(M^4)/\hbar(CP_2))\hbar_0 = (n_a/n_b)\hbar_0$, which thus can have all possible positive rational values. For some time I believed on the scaling of metrics of M^4 resp. CP_2 as n_b^2 resp. n_a^2 : this would imply invariance of Schrödinger equation under the scalings but would not be consistent with the explanation of the quantization of radii of planetary orbits requiring huge Planck constant [K72]. Poincare invariance is however achieved in the sense that mass spectrum is invariant under the scalings of Planck constants. That the ratio n_a/n_b defines effective Planck constant conforms with the fact that the value of Kähler action involves only this ratio (quantum-classical correspondence). Also the value of gravitational constant is invariant under the scalings of Planck constant since one has $G \propto g_K^2 R^2$, R radius of CP_2 for $n_a = 1$.

- (c) This predicts automatically arbitrarily large values of effective Planck constant n_a/n_b and they correspond to coverings of CP_2 points by large number of M^4 points which can have large distance and have precisely correlated behavior due to the G_a symmetry. One can assign preferred values of Planck constant to quantum phases $q = \exp(i\pi/n)$ expressible in terms of iterated square roots of rationals: these correspond to polygons obtainable by compass and ruler construction. In particular, experimentally favored values of \hbar in living matter seem to correspond to these special values of Planck constants. This model reproduces also the other aspects of the general vision. The subgroups of $SL(2, C)$ in turn can give rise to re-scaling of $SU(3)$ Planck constant. The most general situation can be described in terms of Jones inclusions for fixed point subalgebras of number theoretic Clifford algebras defined by $G_a \times G_b \subset SL(2, C) \times SU(2)$.
- (d) These inclusions (apart from those for which G_a contains infinite number of elements) are represented by ADE or extended ADE diagrams depending on the value of index. The group algebras of these groups give rise to additional degrees of freedom which make possible to construct the multiplets of the corresponding gauge groups. For $\beta \leq 4$ the gauge groups A_n, D_{2n}, E_6, E_8 are possible so that TGD seems to be able to mimic these gauge theories. For $\beta = 4$ all ADE Kac Moody groups are possible and again mimicry becomes possible: TGD would be kind of universal physics emulator but it would be anyonic dark matter which would perform this emulation.

The values of gravitational Planck constant

The understanding of large Planck constants led to the detailed interpretation of what is involved with the emergence of gigantic gravitational Planck constant.

Gravitational Planck constant \hbar_{gr} can be interpreted as effective Planck constant $\hbar_{eff} = (n_a/n_b)\hbar_0$ so that the Planck constant associated with M^4 degrees of freedom (rather than CP_2 degrees of freedom as in the original wrong picture) must be very large in this kind of situation.

The detailed spectrum for Planck constants gives very strong constraints to the values of $\hbar_{gr} = GMm/v_0$ if ones assumes that favored values of Planck constant correspond to the Jones inclusions for which quantum phase corresponds to a simple algebraic number expressible in terms of square roots of rationals. These phases correspond to n -polygons with n equal to a product of power of two and Fermat primes, which are all different. The ratios of planetary masses obey the predictions with an accuracy of 10 percent and GMm/v_0 for Sun-Earth system is consistent with $v_0 = 2^{-11}$ if the fraction of visible matter of all matter is about 3 per cent in solar system to be compared with the accepted cosmological value of 4 per cent [K72].

If so, its huge value implies that also the von Neumann inclusions associated with M^4 degrees of freedom are involved meaning that dark matter cosmology has quantal lattice like structure

with lattice cell given by H_a/G , H_a the $a = \text{constant}$ hyperboloid of M_+^4 and G subgroup of $SL(2, \mathbb{C})$. The quantization of cosmic redshifts provides support for this prediction.

There is however strong objection based on the observation that the radius of CP_2 would become gigantic. Surprisingly, this need not have any dramatic implications as will be found. It is also quite possible that the biomolecules subgroups of rotation group as symmetries could correspond to $n_a > 1$. For instance, the tetrahedral and icosahedral molecular structures appearing in water would correspond to E_6 with $n_a = 3$ and E_8 with $n_a = 5$. Note that $n_a = 5$ is minimal value of n_a allowing universal topological quantum computation.

5.6.3 Large values of Planck constant and electro-weak and strong coupling constant evolution

Kähler coupling constant is the only coupling parameter in TGD. The original great vision is that Kähler coupling constant is analogous to critical temperature and thus uniquely determined. Later I concluded that Kähler coupling strength could depend on the p-adic length scale. The reason was that the prediction for the gravitational coupling strength was otherwise non-sensible. This motivated the assumption that gravitational coupling is RG invariant in the p-adic sense.

The expression of the basic parameter $v_0 = 2^{-11}$ appearing in the formula of $\hbar_{gr} = GMm/v_0$ in terms of basic parameters of TGD leads to the unexpected conclusion that α_K in electron length scale can be identified as electro-weak $U(1)$ coupling strength $\alpha_{U(1)}$. This identification is what group theory suggests but I had given it up since the resulting evolution for gravitational coupling was $G \propto L_p^2$ and thus completely un-physical. However, if gravitational interactions are mediated by space-time sheets characterized by Mersenne prime, the situation changes completely since M_{127} is the largest non-super-astrophysical p-adic length scale.

The second key observation is that all classical gauge fields and gravitational field are expressible using only CP_2 coordinates and classical color action and $U(1)$ action both reduce to Kähler action. Furthermore, electroweak group $U(2)$ can be regarded as a subgroup of color $SU(3)$ in a well-defined sense and color holonomy is abelian. Hence one expects a simple formula relating various coupling constants. Let us take α_K as a p-adic renormalization group invariant in strong sense that it does not depend on the p-adic length scale at all.

The relationship for the couplings must involve $\alpha_{U(1)}$, α_s and α_K . The formula $1/\alpha_{U(1)} + 1/\alpha_s = 1/\alpha_K$ states that the sum of $U(1)$ and color actions equals to Kähler action and is consistent with the decrease of the color coupling and the increase of the $U(1)$ coupling with energy and implies a common asymptotic value $2\alpha_K$ for both. The hypothesis is consistent with the known facts about color and electroweak evolution and predicts correctly the confinement length scale as p-adic length scale assignable to gluons. The hypothesis reduces the evolution of α_s to the calculable evolution of electro-weak couplings: the importance of this result is difficult to over-estimate.

5.6.4 Super-symplectic gluons and non-perturbative aspects of hadron physics

What happens mathematically in the transition to non-perturbative QCD has remained more or less a mystery. The number theoretical considerations of [K88] inspired the idea that Planck constant is dynamical and has a spectrum given as $\hbar(n) = n\hbar_0$, where n characterizes the quantum phase $q = \exp(i2\pi/n)$ associated with Jones inclusion. The strange finding that the orbits of planets seem to obey Bohr quantization rules with a gigantic value of Planck constant inspired the hypothesis that the increase of Planck constant provides a unique mechanism allowing strongly interacting system to stay in perturbative phase [K72, K30]. The resulting model allows to understand dark matter as a macroscopic quantum phase in astrophysical length and time scales, and strongly suggest a connection with dark matter and biology.

The phase transition increasing Planck constant could provide a model for the transition to confining phase in QCD. When combined with the recent ideas about value spectrum of Kähler

coupling strength one ends up with a rather explicit model about non-perturbative aspects of hadron physics already successfully applied in hadron mass calculations [K56] .

According to the model of hadron masses [K56] , in the case of light pseudoscalar mesons the contribution of quark masses to the mass squared of meson dominates whereas spin 1 mesons contain a large contribution identified as color interaction conformal weight (color magnetic spin-spin interaction conformal weight and color Coulombic conformal weight). This conformal weight cannot however correspond to the ordinary color interactions alone and is negative for pseudo-scalars and compensated by some unknown contribution in the case of pion in order to avoid tachyonic mass. Quite generally this realizes the idea about light pseudoscalar mesons as Goldstone bosons. Analogous mass formulas hold for baryons but in this case the additional contribution which dominates.

The unknown contribution can be assigned to the $k = 107$ hadronic space-time sheet and must correspond to the non-perturbative aspects of QCD and the failure of the quantum field theory approach at low energies. In TGD the failure of QFT picture corresponds to the presence of configuration space degrees of freedom ("world of classical worlds") in which super-symplectic algebra acts. The failure of the approximation assuming single fixed background space-time is in question.

The purely bosonic generators carry color and spin quantum numbers: spin has however the character of orbital angular momentum. The only electro-weak quantum numbers of super-generators are those of right-handed neutrino. If the super-generators degrees carry the quark spin at high energies, a solution of proton spin puzzle emerges.

The presence of these degrees of freedom means that there are two contributions to color interaction energies corresponding to the ordinary gluon exchanges and exchanges of super-symplectic gluons. It turns out the model assuming same topological mixing of super-symplectic bosons identical to that experienced by U type quarks leads to excellent understanding of hadron masses assuming that hadron spin correlates with the super-symplectic particle content of the hadronic space-time sheet.

According to the argument already discussed, at the hadronic $k = 107$ space electro-weak interactions would be absent and classical $U(1)$ action should vanish. This is guaranteed if $\alpha_{U(1)}$ diverges. This would give

$$\alpha_s = \alpha_K = \frac{1}{4} .$$

This would give also a quantitative articulation for the statement that strong interactions are charge independent.

This α_s would correspond to the interaction via super-symplectic colored gluons and would lead to the failure of perturbation theory. By the general criterion stating that the failure of perturbation theory leads to a phase transition increasing the value of Planck constant one expects that the value of \hbar increases [K30] . The value leaving the value of α_K invariant would be $\hbar \rightarrow 26\hbar$ and would mean that p-adic length scale L_{107} is replaced with length scale $26L_{107} = 46$ fm, the size of large nucleus so that also the basic length scale nuclear physics would be implicitly coded into the structure of hadrons.

5.6.5 Why Mersenne primes should label a fractal hierarchy of physics?

There are motivations for the working hypothesis stating that there is fractal hierarchy of copies of standard model physics, and that Mersenne primes label both hadronic space-time sheets and gauge bosons. The reason for this is not yet well understood and I have considered several speculative explanations.

First picture

The first thing to come in mind is that Mersenne primes correspond to fixed points of the discrete p-adic coupling constant evolution, most naturally to the maxima of the color coupling constant

strength. This would mean that gluons are emitted with higher probability than in other p-adic length scales.

There is however an objection against this idea. If one accepts the new vision about non-perturbative aspects of QCD, it would seem that super-symplectic bosons or the interaction between super-symplectic bosons and quarks for some reason favors Mersenne primes. However, if color coupling strength corresponds to $\alpha_K = \alpha_s = 1/4$ scaled down by the increase of the Planck constant, the evolution of super-symplectic color coupling strength does not seem to play any role. What becomes large should be a geometric "form factor", when the boson in the vertex corresponds to Mersenne prime rather than "bare" coupling.

The resolution of the problem could be that boson emission vertices $g(p_1, p_2, p_3)$ are functions of p-adic primes labeling the particles of the vertices so that actually three p-adic length scales are involved instead of single length scale as in the ordinary coupling constant evolution. Hence one can imagine that the interaction between particles corresponding to primes near powers of 2 and Mersenne primes is especially strong and analogous to a resonant interaction. The geometric resonance due to the fact that the length scales involved are related by a fractal scaling by a power of 2 would make the form factors $F(p_1 \simeq 2^{k_1}, p_2 \simeq 2^{k_2}, M_n)$ large. The selection of primes near powers of two and Mersenne bosons would be analogous to evolutionary selection of a population consisting of species able to interact strongly.

Since $k = 113$ quarks are possible for $k = 107$ hadron physics, it seems that quarks can have join along boundaries bonds directed to M_n space-times with $n < k$. This suggests that neighboring Mersenne primes compete for join along boundaries bonds of quarks. For instance, when the p-adic length scale characterizing quark of M_{107} hadron physics begins to approach M_{89} quarks tend to feed their gauge flux to M_{89} space-time sheet and M_{89} hadron physics takes over and color coupling strength begins to increase. This would be the space-time correlate for the loss of asymptotic freedom.

Second picture

Preferred values of Planck constants could play a key role in the selection of Mersenne primes. Ruler-and-compass hypothesis predicts that Planck constants, which correspond to ratios of ruler and compass integers proportional to a product of distinct Fermat primes (four of them are known) and any power of two are favored. As a special case one obtains ruler and compass integers. As a consequence, p-adic length scales have satellites obtained by multiplying them with ruler-and-compass integers, and entire fractal hierarchy of power-of-two multiples of a given p-adic length scale results.

Mersenne length scales would be special since their satellites would form a subset of satellites of shorter Mersenne length scales. The copies of standard model physics associated with Mersenne primes would define a kind of resonating subset of physics since corresponding wavelengths and frequencies would coincide. This would also explain why fermions labeled by primes near power of two couple strongly with Mersenne primes.

5.6.6 The formula for the hadronic string tension

It is far from clear whether the strong gravitational coupling constant has same relation to the parameter $M_0^2 = 16m_0^2 = 1/\alpha' = 2\pi T$ as it would have in string model.

- (a) One could estimate the strong gravitational constant from the fundamental formula for the gravitational constant expressed in terms of exponent of Kähler action in the case that one has $\alpha_K = 1/4$. The formula reads as

$$\frac{L_p^2}{G_p} = \exp(2aS_K(CP_2)) = \exp(\pi/4\alpha_K) = e^\pi . \quad (5.6.2)$$

a is a parameter telling which fraction the action of wormhole contact is about the full action for CP_2 type vacuum extremal and $a \sim 1/2$ holds true. The presence of a can take

care that the exponent is rational number. For $a = 1$ The number at the right hand side is Gelfond constant and one obtains

$$G_p = \exp(-\pi) \times L_p^2 . \quad (5.6.3)$$

- (b) One could relate the value of the strong gravitational constant to the parameter $M_0^2(k) = 16m(k)^2$, $p \simeq 2^k$ also assuming that string model formula generalizes as such. The basic formulas can be written in terms of gravitational constant G , string tension T , and $M_0^2(k)$ as

$$\frac{1}{8\pi G(k)} = \frac{1}{\alpha'} = 2\pi T(k) = \frac{1}{M_0^2(k)} = \frac{1}{16m(k)^2} . \quad (5.6.4)$$

This allows to express G in terms of the hadronic length scale $L(k) = 2\pi/m(k)$ as

$$G(k) = \frac{1}{16^2\pi^2} L(k)^2 \simeq 3.9 \times 10^{-4} L(k)^2 . \quad (5.6.5)$$

The value of gravitational coupling would be by two orders of magnitude smaller than for the first option.

5.6.7 How p-adic and real coupling constant evolutions are related to each other?

It must be emphasized that part of this section was written before the realization that the generalized eigenvalue equation for the modified Dirac operator provides a fundamental definition of the p-adic coupling constant evolution and some of the considerations are therefore only heuristic. For instance, the relationship between p-adic and real coupling constant evolutions more or less trivializes since S-matrix elements in the approach based on number theoretical braids are algebraic numbers and thus make sense in any number field. The real and p-adic coupling constants are thus identical algebraic numbers.

Questions

One can pose many questions about p-adic coupling constant evolution. How do p-adic and corresponding real coupling constant evolution relate to each other? Why Mersenne primes and primes near prime (integer) powers of two seem to be in a special position physically? Could one say something about phase transition between perturbative and non-perturbative phases of QCD?

How p-adic amplitudes are mapped to real ones?

Before the realization that p-adic and real amplitudes could be algebraic numbers the question of the title was very relevant. If the recent picture is correct, the following considerations are to some degree obsolete.

The real and p-adic coupling constant evolutions should be consistent with each other. This means that the coupling constants $g(p_1, p_2, p_3)$ as functions of p-adic primes characterizing particles of the vertex should have the same qualitative behavior as real and p-adic functions. Hence the p-adic norms of complex rational valued (or those in algebraic extension) amplitudes must give a good estimate for the behavior of the real vertex. Hence a restriction of a continuous correspondence between p-adics and reals to rationals is highly suggestive. The restriction of the canonical identification to rationals would define this kind of correspondence but this correspondence respects neither symmetries nor unitarity in its basic form. Some kind of compromise between correspondence via common rationals and canonical identification should be found.

The compromise might be achieved by using a modification of canonical identification $I_{R_p \rightarrow R}$. Generalized numbers would be regarded in this picture as a generalized manifold obtained by gluing different number fields together along rationals. Instead of a direct identification of real and p-adic rationals, the p-adic rationals in R_p are mapped to real rationals (or vice versa) using a variant of the canonical identification $I_{R \rightarrow R_p}$ in which the expansion of rational number $q = r/s = \sum r_n p^n / \sum s_n p^n$ is replaced with the rational number $q_1 = r_1/s_1 = \sum r_n p^{-n} / \sum s_n p^{-n}$ interpreted as a p-adic number:

$$q = \frac{r}{s} = \frac{\sum_n r_n p^n}{\sum_m s_m p^m} \rightarrow q_1 = \frac{\sum_n r_n p^{-n}}{\sum_m s_m p^{-m}} \quad (5.6.6)$$

This variant of canonical identification is not equivalent with the original one using the infinite expansion of q in powers of p since canonical identification does not commute with product and division. The variant is however unique in the recent context when r and s in $q = r/s$ have no common factors. For integers $n < p$ it reduces to direct correspondence. R_{p_1} and R_{p_2} are glued together along common rationals by an the composite map $I_{R \rightarrow R_{p_2}} I_{R_{p_1} \rightarrow R}$.

Instead of a re-interpretation of the p-adic number $g(p_1, p_2, p_3)$ as a real number or vice versa would be continued by using this variant of canonical identification. The nice feature of the map would be that continuity would be respected to high degree and something which is small in real sense would be small also in p-adic sense.

How to achieve consistency with the unitarity of topological mixing matrices and of CKM matrix?

It is easy to invent an objection against the proposed relationship between p-adic and real coupling constants. Topological mixing matrices U , D and CKM matrix $V = U^\dagger D$ define an important part of the electro-weak coupling constant structure and appear also in coupling constants. The problem is that canonical identification does not respect unitarity and does not commute with the matrix multiplication in the general case unlike gluing along common rationals. Even if matrices U and D which contain only ratios of integers smaller than p are constructed, the construction of V might be problematic since the products of two rationals can give a rational $q = r/s$ for which r or s or both are larger than p .

One might hope that the objection could be circumvented if the ratios of the integers of the algebraic extension defining the matrix elements of CKM matrix are such that the integer components of algebraic integers are smaller than p in U and D and even the products of integers in $U^\dagger D$ satisfy this condition so that modulo p arithmetics is avoided.

In the standard parametrization all matrix elements of the unitarity matrix can be expressed in terms of real and imaginary parts of complex phases ($p \bmod 4 = 3$ guarantees that $\sqrt{-1}$ is not an ordinary p-adic number involving infinite expansion in powers of p). These phases are expressible as products of Pythagorean phases and phases in some algebraic extension of rationals.

i) Pythagorean phases defined as complex rationals $[r^2 - s^2 + i2rs]/(r^2 + s^2)$ are an obvious source of potential trouble. However, if the products of complex integers appearing in the numerators and denominators of the phases have real and imaginary parts smaller than p it seems to be possible to avoid difficulties in the definition of $V = U^\dagger D$.

ii) Pythagorean phases are not periodic phases. Algebraic extensions allow to introduce periodic phases of type $\exp(i\pi m/n)$ expressible in terms of p-adic numbers in a finite-dimensional algebraic extension involving various roots of rationals. Also in this case the product $U^\dagger D$ poses conditions on the size of integers appearing in the numerators and denominators of the rationals involved.

If the expectation that topological mixing matrices and CKM matrix characterize the dynamics at the level $p \simeq 2^k$, $k = 107$, is correct, number theoretical constraints are not expected to bring much new to what is already predicted. Situation changes if these matrices appear already at

the level k . For $k = 89$ hadron physics the restrictions would be even stronger and might force much simpler U , D and CKM matrices.

k -adicity constraint would have even stronger implications for S-matrix and could give very powerful constraints to the S-matrix of color interactions. Quite generally, the constraints would imply a p-adic hierarchy of increasingly complex S-matrices: kind of a physical realization for number theoretic emergence. The work with CKM matrix has shown how powerful the number theoretical constraints are, and there are no reasons to doubt that this could not be the case also more generally since in the lowest order the construction would be carried out in finite (Galois) fields $G(p, k)$.

How generally the hybrid of canonical identification and identification via common rationals can apply?

The proposed gluing procedure, if applied universally, has non-trivial implications which need not be consistent with all previous ideas.

- (a) The basic objection against the new kind of identification is that it does not commute with symmetries. Therefore its application at imbedding space and space-time level is questionable.
- (b) The mapping of p-adic probabilities by canonical identification to their real counterparts requires a separate normalization of the resulting probabilities. Also the new variant of canonical identification requires this since it does not commute with the sum.
- (c) The direct correspondence of reals and p-adics by common rationals at space-time level implies that the intersections of cognitive space-time sheets with real space-time sheet have literally infinite size (p-adically infinitesimal corresponds to infinite in real sense for rational) and consist of discrete points in general. If the new gluing procedure is adopted also at space-time level, it would considerably de-dramatize the radical idea that the size for the space-time correlates of cognition is literally infinite and cognition is a literally cosmic phenomenon.

Of course, the new kind of correspondence could be also seen as a manner to construct cognitive representations by mapping rational points to rational points in the real sense and thus as a formation of cognitive representations at space-time level mapping points close to each other in real sense to points close to each other p-adically but arbitrarily far away in real sense. The image would be a completely chaotic looking set of points in the wrong topology and would realize the idea of Bohm about hidden order in a very concrete manner. This kind of mapping might be used to code visual information using the value of p as a part of the code key.

- (d) In p-adic thermodynamics p-adic particle mass squared is mapped to its real counterpart by canonical identification. The objection against the use of the new variant of canonical identification is that the predictions of p-adic thermodynamics for mass squared are not rational numbers but infinite power series. p-Adic thermodynamics itself however defines a unique representation of probabilities as ratios of generalized Boltzmann weights and partition function and thus the variant of canonical identification indeed generalizes and at the same time raises worries about the fate of the earlier predictions of the p-adic thermodynamics.

Quite generally, the thermodynamical contribution to the particle mass squared is in the lowest p-adic order of form rp/s , where r is the number of excitations with conformal weight 1 and s the number of massless excitations with vanishing conformal weight. The real counterpart of mass squared for the ordinary canonical identification is of order CP_2 mass by $r/s = R + r_1p + \dots$ with $R < p$ near to p . Hence the states for which massless state is degenerate become ultra heavy if r is not divisible by s . For the new variant of canonical identification these states would be light. It is not actually clear how many states of this kind the generalized construction unifying super-symplectic and super Kac-Moody algebras predicts.

A less dramatic implication would be that the second order contribution to the mass squared from p-adic thermodynamics is always very small unless the integer characterizing it is a considerable

fraction of p . When ordinary canonical identification is used, the second order term of form rp^2/s can give term of form Rp^2 , $R < p$ of order p . This occurs only in the case of left handed neutrinos.

The assumption that the second order term to the mass squared coming from other than thermodynamical sources gives a significant contribution is made in the most recent calculations of leptonic masses [K48]. It poses constraints on CP_2 mass which in turn are used as a guideline in the construction of a model for hadrons [K56]. This kind of contribution is possible also now and corresponds to a contribution Rp^2 , $R < p$ near p .

The new variant of the canonical correspondence resolves the long standing problems related to the calculation of Z and W masses. The mass squared for intermediate gauge bosons is smaller than one unit when m_0^2 is used as a fundamental mass squared unit. The standard form of the canonical identification requires $M^2 = (m/n)p^2$ whereas in the new approach $M^2 = (m/n)p$ is allowed. Second difficult problem has been the p-adic description of the group theoretical model for m_W^2/m_Z^2 ratio. In the new framework this is not a problem anymore [K48] since canonical identification respects the ratios of small integers.

On the other hand, the basic assumption of the successful model for topological mixing of quarks [K56] is that the modular contribution to the masses is of form np . This assumption loses its original justification for this option and some other justification is needed. The first guess is that the conditions on mass squared plus probability conservation might not be consistent with unitarity unless the modular contribution to the mass squared remains integer valued in the mixing (note that all integer values are not possible [K56]). Direct numerical experimentation however shows that that this is not the case.

5.6.8 How p-adic coupling constant evolution and p-adic length scale hypothesis emerge from quantum TGD proper?

What p-adic coupling constant evolution really means has remained for a long time more or less open. The progress made in the understanding of the S-matrix of theory has however changed the situation dramatically.

M-matrix and coupling constant evolution

The final breakthrough in the understanding of p-adic coupling constant evolution came through the understanding of S-matrix, or actually M-matrix defining entanglement coefficients between positive and negative energy parts of zero energy states in zero energy ontology [K22]. M-matrix has interpretation as a "complex square root" of density matrix and thus provides a unification of thermodynamics and quantum theory. S-matrix is analogous to the phase of Schrödinger amplitude multiplying positive and real square root of density matrix analogous to modulus of Schrödinger amplitude.

The notion of finite measurement resolution realized in terms of inclusions of von Neumann algebras allows to demonstrate that the irreducible components of M-matrix are unique and possesses huge symmetries in the sense that the hermitian elements of included factor $\mathcal{N} \subset \mathcal{M}$ defining the measurement resolution act as symmetries of M-matrix, which suggests a connection with integrable quantum field theories.

It is also possible to understand coupling constant evolution as a discretized evolution associated with time scales T_n , which come as octaves of a fundamental time scale: $T_n = 2^n T_0$. Number theoretic universality requires that renormalized coupling constants are rational or at most algebraic numbers and this is achieved by this discretization since the logarithms of discretized mass scale appearing in the expressions of renormalized coupling constants reduce to the form $\log(2^n) = n \log(2)$ and with a proper choice of the coefficient of logarithm $\log(2)$ dependence disappears so that rational number results. Recall that also the weaker condition $T_p = p T_0$, p prime, would assign secondary p-adic time scales to the size scale hierarchy of CDs: $p \simeq 2^n$ would result as an outcome of some kind of "natural selection" for this option. The highly satisfactory feature would be that p-adic time scales would reflect directly the geometry of imbedding space and configuration space.

p-Adic coupling constant evolution

An attractive conjecture is that the coupling constant evolution associated with CD s in powers of 2 implying time scale hierarchy $T_n = 2^n T_0$ induces p-adic coupling constant evolution and explain why p-adic length scales correspond to $L_p \propto \sqrt{p}R$, $p \simeq 2^k$, $R CP_2$ length scale? This looks attractive but there seems to be a problem. p-Adic length scales come as powers of $\sqrt{2}$ rather than 2 and the strongly favored values of k are primes and thus odd so that $n = k/2$ would be half odd integer. This problem can be solved.

- (a) The observation that the distance traveled by a Brownian particle during time t satisfies $r^2 = Dt$ suggests a solution to the problem. p-Adic thermodynamics applies because the partonic 3-surfaces X^2 are as 2-D dynamical systems random apart from light-likeness of their orbit. For CP_2 type vacuum extremals the situation reduces to that for a one-dimensional random light-like curve in M^4 . The orbits of Brownian particle would now correspond to light-like geodesics γ_3 at X^3 . The projection of γ_3 to a time=constant section $X^2 \subset X^3$ would define the 2-D path γ_2 of the Brownian particle. The M^4 distance r between the end points of γ_2 would be given $r^2 = Dt$. The favored values of t would correspond to $T_n = 2^n T_0$ (the full light-like geodesic). p-Adic length scales would result as $L^2(k) = DT(k) = D2^k T_0$ for $D = R^2/T_0$. Since only CP_2 scale is available as a fundamental scale, one would have $T_0 = R$ and $D = R$ and $L^2(k) = T(k)R$.
- (b) p-Adic primes near powers of 2 would be in preferred position. p-Adic time scale would not relate to the p-adic length scale via $T_p = L_p/c$ as assumed implicitly earlier but via $T_p = L_p^2/R_0 = \sqrt{p}L_p$, which corresponds to secondary p-adic length scale. For instance, in the case of electron with $p = M_{127}$ one would have $T_{127} = .1$ second which defines a fundamental biological rhythm. Neutrinos with mass around .1 eV would correspond to $L(169) \simeq 5 \mu\text{m}$ (size of a small cell) and $T(169) \simeq 1. \times 10^4$ years. A deep connection between elementary particle physics and biology becomes highly suggestive.
- (c) In the proposed picture the p-adic prime $p \simeq 2^k$ would characterize the thermodynamics of the random motion of light-like geodesics of X^3 so that p-adic prime p would indeed be an inherent property of X^3 . For the weaker condition would be $T_p = pT_0$, p prime, $p \simeq 2^n$ could be seen as an outcome of some kind of "natural selection". In this case, p would a property of CD and all light-like 3-surfaces inside it and also that corresponding sector of configuration space.
- (d) The fundamental role of 2-adicity suggests that the fundamental coupling constant evolution and p-adic mass calculations could be formulated also in terms of 2-adic thermodynamics. With a suitable definition of the canonical identification used to map 2-adic mass squared values to real numbers this is possible, and the differences between 2-adic and p-adic thermodynamics are extremely small for large values of for $p \simeq 2^k$. 2-adic temperature must be chosen to be $T_2 = 1/k$ whereas p-adic temperature is $T_p = 1$ for fermions. If the canonical identification is defined as

$$\sum_{n \geq 0} b_n 2^n \rightarrow \sum_{m \geq 1} 2^{-m+1} \sum_{(k-1)m \leq n < km} b_n 2^n ,$$

it maps all 2-adic integers $n < 2^k$ to themselves and the predictions are essentially same as for p-adic thermodynamics. For large values of $p \simeq 2^k$ 2-adic real thermodynamics with $T_R = 1/k$ gives essentially the same results as the 2-adic one in the lowest order so that the interpretation in terms of effective 2-adic/p-adic topology is possible.

Appendix: Identification of the electro-weak couplings

The delicacies of the spinor structure of CP_2 make it a unique candidate for space S . First, the coupling of the spinors to the $U(1)$ gauge potential defined by the Kähler structure provides the missing $U(1)$ factor in the gauge group. Secondly, it is possible to couple different H -chiralities independently to a half odd multiple of the Kähler potential. Thus the hopes of obtaining a

correct spectrum for the electromagnetic charge are considerable. In the following it will be demonstrated that the couplings of the induced spinor connection are indeed those of the GWS model [B42] and in particular that the right handed neutrinos decouple completely from the electro-weak interactions.

To begin with, recall that the space H allows to define three different chiralities for spinors. Spinors with fixed H -chirality $e = \pm 1$, CP_2 -chirality l, r and M^4 -chirality L, R are defined by the condition

$$\begin{aligned}\Gamma\Psi &= e\Psi, \\ e &= \pm 1,\end{aligned}\tag{5.6.7}$$

where Γ denotes the matrix $\Gamma_9 = \gamma_5 \times \gamma_5$, $1 \times \gamma_5$ and $\gamma_5 \times 1$ respectively. Clearly, for a fixed H -chirality CP_2 - and M^4 -chiralities are correlated.

The spinors with H -chirality $e = \pm 1$ can be identified as quark and lepton like spinors respectively. The separate conservation of baryon and lepton numbers can be understood as a consequence of generalized chiral invariance if this identification is accepted. For the spinors with a definite H -chirality one can identify the vielbein group of CP_2 as the electro-weak group: $SO(4) = SU(2)_L \times SU(2)_R$.

The covariant derivatives are defined by the spinorial connection

$$A = V + \frac{B}{2}(n_+1_+ + n_-1_-) .\tag{5.6.8}$$

Here V and B denote the projections of the vielbein and Kähler gauge potentials respectively and $1_{+(-)}$ projects to the spinor H -chirality $+(-)$. The integers n_{\pm} are odd from the requirement of a respectable spinor structure.

The explicit representation of the vielbein connection V and of B are given by the equations

$$\begin{aligned}V_{01} &= -\frac{e^1}{r}, & V_{23} &= \frac{e^1}{r}, \\ V_{02} &= -\frac{e^2}{r}, & V_{31} &= \frac{e^2}{r}, \\ V_{03} &= (r - \frac{1}{r})e^3, & V_{12} &= (2r + \frac{1}{r})e^3,\end{aligned}\tag{5.6.9}$$

and

$$B = 2re^3 ,\tag{5.6.10}$$

respectively. The explicit representation of the vielbein is not needed here.

Let us first show that the charged part of the spinor connection couples purely left handedly. Identifying Σ_3^0 and Σ_2^1 as the diagonal (neutral) Lie-algebra generators of $SO(4)$, one finds that the charged part of the spinor connection is given by

$$A_{ch} = 2V_{23}I_L^1 + 2V_{13}I_L^2 ,\tag{5.6.11}$$

where one have defined

$$\begin{aligned} I_L^1 &= \frac{(\Sigma_{01} - \Sigma_{23})}{2} , \\ I_L^2 &= \frac{(\Sigma_{02} - \Sigma_{13})}{2} . \end{aligned} \quad (5.6.12)$$

A_{ch} is clearly left handed so that one can perform the identification

$$W^\pm = \frac{2(e^1 \pm ie^2)}{r} , \quad (5.6.13)$$

where W^\pm denotes the charged intermediate vector boson.

Consider next the identification of the neutral gauge bosons γ and Z^0 as appropriate linear combinations of the two functionally independent quantities

$$\begin{aligned} X &= re^3 , \\ Y &= \frac{e^3}{r} , \end{aligned} \quad (5.6.14)$$

appearing in the neutral part of the spinor connection. We show first that the mere requirement that photon couples vectorially implies the basic coupling structure of the GWS model leaving only the value of Weinberg angle undetermined.

To begin with let us define

$$\begin{aligned} \bar{\gamma} &= aX + bY , \\ \bar{Z}^0 &= cX + dY , \end{aligned} \quad (5.6.15)$$

where the normalization condition

$$ad - bc = 1 ,$$

is satisfied. The physical fields γ and Z^0 are related to $\bar{\gamma}$ and \bar{Z}^0 by simple normalization factors.

Expressing the neutral part of the spinor connection in term of these fields one obtains

$$\begin{aligned} A_{nc} &= [(c+d)2\Sigma_{03} + (2d-c)2\Sigma_{12} + d(n_+1_+ + n_-1_-)]\bar{\gamma} \\ &+ [(a-b)2\Sigma_{03} + (a-2b)2\Sigma_{12} - b(n_+1_+ + n_-1_-)]\bar{Z}^0 . \end{aligned} \quad (5.6.16)$$

Identifying Σ_{12} and $\Sigma_{03} = 1 \times \gamma_5 \Sigma_{12}$ as vectorial and axial Lie-algebra generators, respectively, the requirement that γ couples vectorially leads to the condition

$$c = -d . \quad (5.6.17)$$

Using this result plus previous equations, one obtains for the neutral part of the connection the expression

$$A_{nc} = \gamma Q_{em} + Z^0(I_L^3 - \sin^2\theta_W Q_{em}) . \quad (5.6.18)$$

Here the electromagnetic charge Q_{em} and the weak isospin are defined by

$$\begin{aligned} Q_{em} &= \Sigma^{12} + \frac{(n_+1_+ + n_-1_-)}{6} , \\ I_L^3 &= \frac{(\Sigma^{12} - \Sigma^{03})}{2} . \end{aligned} \quad (5.6.19)$$

The fields γ and Z^0 are defined via the relations

$$\begin{aligned} \gamma &= 6d\bar{\gamma} = \frac{6}{(a+b)}(aX + bY) , \\ Z^0 &= 4(a+b)\bar{Z}^0 = 4(X - Y) . \end{aligned} \quad (5.6.20)$$

The value of the Weinberg angle is given by

$$\sin^2\theta_W = \frac{3b}{2(a+b)} , \quad (5.6.21)$$

and is not fixed completely. Observe that right handed neutrinos decouple completely from the electro-weak interactions.

The determination of the value of Weinberg angle is a dynamical problem. The angle is completely fixed once the YM action is fixed by requiring that action contains no cross term of type γZ^0 . Pure symmetry non-broken electro-weak YM action leads to a definite value for the Weinberg angle. One can however add a symmetry breaking term proportional to Kähler action and this changes the value of the Weinberg angle.

To evaluate the value of the Weinberg angle one can express the neutral part F_{nc} of the induced gauge field as

$$F_{nc} = 2R_{03}\Sigma^{03} + 2R_{12}\Sigma^{12} + J(n_+1_+ + n_-1_-) , \quad (5.6.22)$$

where one has

$$\begin{aligned} R_{03} &= 2(2e^0 \wedge e^3 + e^1 \wedge e^2) , \\ R_{12} &= 2(e^0 \wedge e^3 + 2e^1 \wedge e^2) , \\ J &= 2(e^0 \wedge e^3 + e^1 \wedge e^2) , \end{aligned} \quad (5.6.23)$$

in terms of the fields γ and Z^0 (photon and Z - boson)

$$F_{nc} = \gamma Q_{em} + Z^0(I_L^3 - \sin^2\theta_W Q_{em}) . \quad (5.6.24)$$

Evaluating the expressions above one obtains for γ and Z^0 the expressions

$$\begin{aligned}\gamma &= 3J - \sin^2\theta_W R_{03} \ , \\ Z^0 &= 2R_{03} \ .\end{aligned}\tag{5.6.25}$$

For the Kähler field one obtains

$$J = \frac{1}{3}(\gamma + \sin^2\theta_W Z^0) \ .\tag{5.6.26}$$

Part II

**MANY-SHEETED
COSMOLOGY, AND
ASTROPHYSICS**

Chapter 6

The Relationship Between TGD and GRT

6.1 Introduction

In this chapter the recent view about TGD as Poincare invariant theory of gravitation is discussed. It must be admitted that the development of the proper interpretation of the theory has been rather slow and involved rather weird twists motivated by conformist attitudes. Typically these attempts have brought into theory ad hoc identifications of say gravitational four-momentum although theory itself has from very beginning provided completely general formulas.

Perhaps the real problem has been that radically new views about ontology were necessary before it was possible to see what had been there all the time. Zero energy ontology states that all physical states have vanishing net quantum numbers. The hierarchy of dark matter identified as macroscopic quantum phases labeled by arbitrarily large values of Planck constant is second aspect of the new ontology.

6.1.1 Does Equivalence Principle hold true in TGD Universe?

The motivation for TGD as a Poincare invariant theory of gravitation was that the notion of four-momentum is poorly defined in curved space-time since corresponding Noether currents do not exist. There however seems to be a fundamental obstacle against the existence of a Poincare invariant theory of gravitation related to the notions of inertial and gravitational energy.

- (a) The conservation laws of inertial energy and momentum assigned to the fundamental action would be exact in this kind of a theory. Gravitational four-momentum can be assigned to the curvature scalar as Noether currents and is thus completely well-defined unlike in GRT. Equivalence Principle requires that inertial and gravitational four-momenta are identical. This is satisfied if curvature scalar defines the fundamental action principle crucial for the definition of quantum TGD. Curvature scalar as a fundamental action is however non-physical and had to be replaced with so called Kähler action.
- (b) One can question Equivalence Principle because the conservation of gravitational four-momentum seems to fail in cosmological scales.
- (c) For the extremals of Kähler action the Noether currents associated with curvature scalar are well-defined but non-conserved. Also for vacuum extremals satisfying Einstein's equations gravitational four-momentum fails to be conserved and non-conservation becomes large for small values of cosmic time. This looks fine but the problem is whether the possible failure of Equivalence Principle is so serious that it leads to conflict with experimental facts.

The failure of Equivalence Principle was something which I could not take seriously and I ended up with a long series of ad hoc constructs trying to save Equivalence Principle. Eventually I decided to take the possible failure seriously and to find out whether it has catastrophic consequences, and to look also for possible positive consequences by trying to relate the failure to the recent problems of cosmology, in particular the necessity to postulate somewhat mysterious dark energy characterized by cosmological constant.

My basic mistake looks now obvious. I tried to deduce the formulation of Equivalence Principle in the framework provided by General Relativity framework rather than in string model context. There were several steps in the enlightenment process.

- (a) First came the conviction that coset representation for super-symplectic and super Kac-Moody algebras provides extremely general formulation of Equivalence Principle in which inertial and gravitational four-momenta are replaced with Super Virasoro generators of two algebras whose differences annihilate physical states. This idea came for years before becoming aware of its importance and I simply forgot it.
- (b) Next came the realization of the fundamental role of number theoretical compactification providing a number theoretical interpretation of $M^4 \times CP_2$ and thus also of standard model quantum numbers. This led to the identification of the preferred extremals of Kähler action and to the formulation of quantum TGD in terms of second quantized induced spinors fields. One of conclusion was that dimensional reduction for preferred extremals of Kähler action- if they have the properties required by theoretic compactification- leads to string model with string tension which is however not proportional to the inverse of Newton's constant but to L_p^2 , p-adic length scale squared and thus gigantic. The connection between gravitational constant and L_p^2 comes from an old argument that I discovered about two decades ago and which allowed to predict the value of Kähler coupling strength by using as input electron mass and p-adic mass calculations. In this framework the role of Planck length as a fundamental length scale is taken by CP_2 size so that Planck length scale loses its magic role as a length scale in which usual views about space-time geometry cease to hold true.
- (c) The next step was the realization that zero energy ontology allows to avoid the paradox implied in positive energy ontology by the fact that gravitational energy is not conserved but inertial energy identified as Noether charge is. Energy conservation is always in some length scale in zero energy ontology.
- (d) As a matter fact, there was still one step. I had to become fully aware that the identification of gravitational four-momentum in terms of Einstein tensor makes sense only in long length scales. This is of course trivial but for some reason I did not realize that this fact resolves the paradoxes associated with objects like cosmic strings.

To sum up, the understanding of Equivalence Principle in TGD context required quite many discoveries of mostly mathematical character: the understanding of the super-conformal symmetries of quantum TGD, the discovery of zero energy ontology, the identification of preferred extremals of Kähler action by requiring number theoretical compactification, and the discovery that dimensional reduction allows to formulate quantum in terms of slicing of space-time surface by stringy word sheets.

6.1.2 Zero energy ontology

In zero energy ontology one replaces positive energy states with zero energy states with positive and negative energy parts of the state at the boundaries of future and past direct light-cones forming a causal diamond. All conserved quantum numbers of the positive and negative energy states are of opposite sign so that these states can be created from vacuum. "Any physical state is creatable from vacuum" becomes thus a basic principle of quantum TGD and together with the notion of quantum jump resolves several philosophical problems (What was the initial state of universe?, What are the values of conserved quantities for Universe, Is theory building completely useless if only single solution of field equations is realized?).

At the level of elementary particle physics positive and negative energy parts of zero energy state are interpreted as initial and final states of a particle reaction so that quantum states become physical events. Equivalence Principle would hold true in the sense that the classical gravitational four-momentum of the vacuum extremal whose small deformations appear as the argument of configuration space spinor field is equal to the positive energy of the positive energy part of the zero energy quantum state.

The vacuum extremals are absolutely essential for the TGD based view about long length scale limit about gravitation. Already the Kähler action defined by CP_2 Kähler form J allows enormous vacuum degeneracy: any four-surface having Lagrangian submanifold of CP_2 as its CP_2 projection is a vacuum extremal. The dimension of these sub-manifolds is at most two. Robertson-Walker cosmologies correspond to vacua with respect to inertial energy and in fact with respect to all quantum numbers. They are not vacua with respect to gravitational charges defined as Noether charges associated with the curvature scalar. Also more general imbeddings of Einstein's equations are typically vacuum extremals with respect to Noether charges assignable to Kähler action since otherwise one ends up with conflict between imbeddability and dynamics. This suggests that physical states have vanishing net quantum numbers quite generally. The construction of quantum theory [K36, K23] indeed leads naturally to zero energy ontology stating that everything is creatable from vacuum.

Zero energy states decompose into positive and negative energy parts having identification as initial and final states of particle reaction in time scales of perception longer than the geometro-temporal separation T of positive and negative energy parts of the state. If the time scale of perception is smaller than T , the usual positive energy ontology applies.

In zero energy ontology inertial four-momentum is a quantity depending on the temporal time scale T used and in time scales longer than T the contribution of zero energy states with parameter $T_1 < T$ to four-momentum vanishes. This scale dependence alone implies that it does not make sense to speak about conservation of inertial four-momentum in cosmological scales. Hence it would be in principle possible to identify inertial and gravitational four-momenta and achieve strong form of Equivalence Principle. It however seems that this is not the correct approach to follow.

The concept of negative potential energy is completely standard notion in physics. Perhaps so standard that physicists have begun to regard it as understood. The precise physical origin of the negative potential energy is however complete mystery, and one is forced to take the potential energy as a purely phenomenological concept deriving from quantum theory as an effective description.

In TGD framework topological field quantization leads to the hypothesis that quantum concepts should have geometric counterparts and also potential energy should have precise correlate at the level of description based on topological field quanta. This indeed seems to be the case. As already explained, TGD allows space-time sheets to have both positive and negative time orientations. This in turn implies that also the sign of energy can be also negative. This suggests that the generation of negative energy space-time sheets representing virtual gravitons together with energy conservation makes possible the generation of huge gravitationally induced kinetic energies and gravitational collapse. In this process inertial energy would be conserved since instead, of positive energy gravitons, the inertial energy would go to the energy of matter.

This picture has a direct correlate in quantum field theory where the exchange negative energy virtual bosons gives rise to the interaction potential. The gravitational red-shift of microwave background photons is the strongest support for the non-conservation of energy in General Relativity. In TGD it could have concrete explanation in terms of absorption of negative energy virtual gravitons by photons leading to gradual reduction of their energies. This explanation is consistent with the classical geometry based explanation of the red-shift based on the stretching of electromagnetic wave lengths. This explanation is also consistent with the intuition based on Feynman diagram description of gravitational acceleration in terms of graviton exchanges.

6.1.3 Dark matter hierarchy and hierarchy of Planck constants

The idea about hierarchy of Planck constants relying on generalization of the imbedding space was inspired both by empirical input (Bohr quantization of planetary orbits) and by the mathematics of hyper-finite factors of type II₁ combined with the quantum classical correspondence.

Quantum classical correspondence suggests that Jones inclusions [A2] have space-time correlates [K90, K30]. There is a symplectic hierarchy of Jones inclusions labeled by finite subgroups of SU(2) [A55]. This leads to a generalization of the imbedding space obtained by gluing an infinite number of copies of H regarded as singular bundles over $H/G_a \times G_b$, where $G_a \times G_b$ is a subgroup of $SU(2) \times SU(2) \subset SL(2, C) \times SU(3)$. Gluing occurs along a factor for which the group is same. The generalized imbedding space has clearly a book like structure with pages of books intersecting along 4-D sub-manifold $M^2 \times S^2$, S^2 a geodesic sphere of CP_2 characterizing the choice of quantization axes. Entire configuration space is union over "books" corresponding to various choices of this sub-manifold.

The groups in question define in a natural manner the direction of quantization axes for various isometry charges and this hierarchy seems to be an essential element of quantum measurement theory. Ordinary Planck constant, as opposed to Planck constants $\hbar_a = n_a \hbar_0$ and $\hbar_b = n_b \hbar_0$ appearing in the commutation relations of symmetry algebras assignable to M^4 and CP_2 , is naturally quantized as $\hbar = (n_a/n_b) \hbar_0$, where n_i is the order of maximal cyclic subgroup of G_i . The hierarchy of Planck constants is interpreted in terms of dark matter hierarchy [K30]. What is also important is that $(n_a/n_b)^2$ appear as a scaling factor of M^4 metric so that Kähler action via its dependence on induced metric codes for radiative corrections coming in powers of ordinary Planck constant: therefore quantum criticality and vanishing of radiative corrections to functional integral over WCW does not mean vanishing of radiative corrections.

G_a would correspond directly to the observed symmetries of visible matter induced by the underlying dark matter [K30]. For instance, in living matter molecules with 5- and 6-cycles could directly reflect the fact that free electron pairs associated with these cycles correspond to $n_a = 5$ and $n_a = 6$ dark matter possibly responsible for anomalous conductivity of DNA [K30, K15] and recently reported strange properties of graphene [D11]. Also the tetrahedral and icosahedral symmetries of water molecule clusters could have similar interpretation [K27], [D10].

A further fascinating possibility is that the observed indications for Bohr orbit quantization of planetary orbits [E175] could have interpretation in terms of gigantic Planck constant for underlying dark matter [K72] so that macroscopic and -temporal quantum coherence would be possible in astrophysical length scales manifesting itself in many manners: say as preferred directions of quantization axis (perhaps related to the CMB anomaly) or as anomalously low dissipation rates.

Since the gravitational Planck constant is proportional to the product of the gravitational masses of interacting systems, it must be assigned to the field body of the two systems and characterizes the interaction between systems rather than systems themselves. This observation applies quite generally and each field body of the system (em, weak, color, gravitational) is characterized by its own Planck constant.

In the gravitational case the order of G_a is gigantic and at least $GM_1 m/v_0$, $v_0 = 2^{-11}$ the favored value. The natural interpretation is as a discrete rotational symmetry of the gravitational field body of the system having both gravimagnetic and gravi-electric parts. The subgroups of G_a for which order is a divisor of the order of G_a define broken symmetries at the lower levels of dark matter hierarchy, in particular symmetries of visible matter.

The number theoretically simple ruler-and-compass integers having as factors only first powers of Fermat primes and power of 2 would define a physically preferred sub-hierarchy of quantum criticality for which subsequent levels would correspond to powers of 2: a connection with p-adic length scale hypothesis suggests itself. Ruler and compass hypothesis implies that besides p-adic length scales also their 3- and 5- multiples should be important. Note that in the structure of chromosomes p-adic length scale $L(151) \simeq 10$ characterizes beads-on-string structure of DNA whereas the length scale $3L(151)$ appears in the coiling of this structure.

It has turned that there are good hopes of reducing the hierarchy of Planck constants to the basic TGD [K11]. By the extreme non-linearity of the Kähler action the correspondence between

the time derivatives of the imbedding space coordinates and canonical momentum densities is many-to-one. This leads naturally to the introduction of covering spaces of $CD \times CP_2$, which are singular in the sense that the sheets of the covering co-incide at the ends of CD and at wormhole throats. One can say that quantum criticality means also the instability of the 3-surfaces defined by throats and ends against the decay to several space-time sheets and consequence charge fractionization. The interpretation is as an instability caused by too strong density of mass and making perturbative description possible since the matter density at various branches is reduced. The situation can be described mathematically either by using effectively only single sheet but an integer multiple of Planck constant or many-sheeted covering and ordinary value of Planck constant. In [K30] the argument that this indeed leads to hierarchy of Planck constants including charge fractionization is developed in detail. The restriction to singular coverings is consistent with the experimental constraints and means that only integer valued Planck constants are possible. A given value of Planck constant corresponds only to a finite number of the pages of the Big Book and that the evolution by quantum jumps is analogous to a diffusion at half-line and tends to increase the value of Planck constant.

6.1.4 The problem of cosmological constant

A further implication of dark matter hierarchy is that astrophysical systems correspond to stationary states analogous to atoms and do not participate to cosmic expansion in a continuous manner but via discrete quantum phase transitions in which gravitational Planck constant increases. By quantum criticality of these phase transitions critical cosmologies are excellent candidates for the modeling of these transitions. Imbeddable critical cosmologies are unique apart from a parameter determining their duration and represent accelerating cosmic expansion so that there is no need to introduce cosmological constant.

It indeed turns out possible to understand these critical phases in terms of quantum phase transition increasing the size of large modeled in terms of "big" cosmic strings with negative gravitational mass whose repulsive gravitation drives "galactic" cosmic strings with positive gravitational mass to the boundaries of the void. In this framework cosmological constant like parameter does not characterize the density of dark energy but that of dark matter identifiable as quantum phases with large Planck constant.

A further problem is that the naive estimate for the cosmological constant is predicted to be by a factor 10^{120} larger than its value deduced from the accelerated expansion of the Universe. In TGD framework the resolution of the problem comes naturally from the fact that large voids are quantum systems which follow the cosmic expansion only during the quantum critical phases.

p-Adic fractality predicting that cosmological constant is reduced by a power of 2 in phase transitions occurring at times $T(k) \propto 2^{k/2}$, which correspond to p-adic time scales. These phase transitions would naturally correspond to quantum phase transitions increasing the size of the large voids during which critical cosmology predicting accelerated expansion naturally applies. On the average $\Lambda(k)$ behaves as $1/a^2$, where a is the light-cone proper time. This predicts correctly the order of magnitude for observed value of Λ .

6.1.5 Topics of the chapter

The notion of many-sheeted space-time has been extensively discussed in the previous chapters [K35, K36] and is therefore left out from this chapter. The topics included in this chapter are following.

The first two sections are devoted to the general theoretical picture.

- (a) There is a discussion of General Coordinate Invariance, Equivalence Principle, and Machian Principle in TGD context with a special emphasis on the recent views about the relationship of inertial and gravitational masses, the zero energy ontology, and dark matter hierarchy.
- (b) The vacuum extremal imbeddings of Reissner-Nordström and Schwarzschild metric are studied. The interpretational problems involved were responsible for much of the tension

which eventually led to the recent understanding of Equivalence Principle in TGD framework.

The remaining sections are devoted to examples about applications.

- (a) A simple model for the final state of a star is proposed. The model indicates that Z^0 force, presumably created by dark matter, might have an important role in the dynamics of the compact objects. During year 2003, more than decade after the formulation of the model, the discovery of the connection between supernovas and gamma ray bursts [E177] provided strong support for the predicted axial magnetic and Z^0 magnetic flux tube structures predicted by the model for the final state of a rotating star. Two years later the interpretation of the predicted long range weak forces as being caused by dark matter emerged.

The recent progress in the understanding of hadronic mass calculations [K56] has led to the identification of so called super-symplectic bosons and their super-counterparts as basic building blocks of hadrons. This notion suggests also a microscopic description of neutron stars and black-holes in terms of highly entangled string like objects in Hagedorn temperature and in very precise sense analogous to gigantic hadrons.

- (b) In the remaining sections the role of cosmic strings in TGD Universe is summarized, Allais effect as a possible evidence for large \hbar dark gravitons is discussed, and a TGD inspired model of gravimagnetism is studied. Last section is devoted to miscellaneous topics including the time dilation effect caused by the warping of space-time sheet in absence of matter.

6.2 Basic principles of General Relativity from TGD point of view

General Coordinate Invariance, Equivalence Principle, and Machian Principle are the basic principles underlying General Relativity. One can say that TGD shares all of these basic principles albeit in different form.

6.2.1 General Coordinate Invariance

General Coordinate Invariance plays in the formulation of quantum TGD even deeper role than in that of GRT. Since the fundamental objects are 3-D surfaces, the construction of the geometry of the configuration space of 3-surfaces (the world of classical worlds, WCW) requires that the definition of the geometry assigns to a given 3-surface X^3 a unique space-time surface $X^4(X^3)$. This space-time surface is completely analogous to Bohr orbit, which means a completely unexpected connection with quantum theory.

General Coordinate Invariance is a gauge symmetry and requires gauge fixing. The definition assigning $X^4(X^3)$ to given X^3 must be such that the outcome is same for all 4-diffeomorphs of X^3 . This condition is highly non-trivial since $X^4(X^3) = X^4(Y^3)$ must hold true if X^3 and Y^3 are 4-diffeomorphs. One manner to satisfy this condition is by assuming quantum holography and weakened form of General Coordinate Invariance: there exists physically preferred 3-surfaces X^3 defining $X^4(X^3)$, and the 4-diffeomorphs Y^3 of X^3 at $X^4(X^3)$ provide classical holograms of X^3 : $X^4(Y^3) = X^4(X^3)$ is trivially true. Zero energy ontology allows to realize this form of General Coordinate Invariance.

- (a) In zero energy ontology configuration space decomposes into a union of sub-configuration spaces associated with causal diamonds $CD \times CP_2$ (CD denotes the intersection of future and past directed light-cones of M^4), and the intersections of space-time surface with the light-light boundaries of $CD \times CP_2$ are excellent candidates for preferred space-like 3-surfaces X^3 . The 3-surfaces at $\delta CD \times CP_2$ are indeed physically special since they carry the quantum numbers of positive and negative energy parts of the zero energy state.

- (b) Preferred 3-surfaces could be also identified as light-like 3-surfaces X_l^3 at which the Euclidian signature of the induced space-time metric changes to Minkowskian. Also light-like boundaries of X^4 can be considered. These 3-surfaces are assumed to carry elementary particle quantum numbers and their intersections with the space-like 3-surfaces X^3 are 2-dimensional partonic surfaces so that effective 2-dimensionality consistent with the conformal symmetries of X_l^3 results if the identifications of 3-surfaces are physically equivalent. Light-like 3-surfaces are identified as generalized Feynman diagrams and due to the presence of 2-D partonic 2-surfaces representing vertices fail to be 3-manifolds. Generalized Feynman diagrams could be also identified as Euclidian regions of space-time surface.
- (c) General Coordinate Invariance in minimal form requires that the slicing of $X^4(X_l^3)$ by light light 3-surfaces Y_l^3 "parallel" to X_l^3 predicted by number theoretic compactification gives rise to quantum holography in the sense that the data associated with any Y_l^3 allows an equivalent formulation of quantum TGD. This poses a strong condition on the spectra of the modified Dirac operator at Y_l^3 and thus to the preferred extremals of Kähler action since the configuration space Kähler functions defined by various choices of Y_l^3 can differ only by a sum of a holomorphic function and its conjugate [K19, K23] .

6.2.2 Equivalence Principle

Coset construction for super-symplectic and super Kac-Moody algebras discussed in [K19, K23, K48] allows to generalize Equivalence Principle and understand it at quantum level. This is however not quite enough: a precise understanding of Equivalence Principle is required also at the classical level. In the following the notion of gravitational mass and its equivalence with inertial mass is discussed first. The strategy is to deduce connection with string model type description rather than trying to show that General Relativity emerges from TGD. This connection emerges through dimensional reduction of the dynamics defined by Kähler action to stringy dynamics. If one believes that string model description implies General Relativity in long scales, the situation is settled. The determination of gravitational mass as flux does not apply generally so that one cannot identify GM as a gravitational flux assignable to a wormhole throat. Hence one cannot formulate the evolution of G at space-time level as evolution of gravitational fluxes and it seems that only p-adic coupling constant evolution makes sense for G .

Is stringy action principle coded by the geometry of preferred extremals?

It seems very difficult to deduce Equivalence Principle as an identity of gravitational and inertial masses identified as Noether charges associated with corresponding action principles. Since string model is an excellent theory of quantum gravitation, one can consider a less direct approach in which one tries to deduce a connection between classical TGD and string model and hope that the bridge from string model to General Relativity is easier to build. Number theoretical compactification gives good hopes that this kind of connection exists.

- (a) Number theoretic compactification implies that the preferred extremals of Kähler action have the property that one can assign to each point of M^4 projection $P_{M^4}(X^4(X_l^3))$ of the preferred extremal $M^2(x)$ identified as the plane of non-physical polarizations and also as the plane in which local massless four-momentum lies.
- (b) If the distribution of the planes $M^2(x)$ is integrable, one can slice $P_{M^4}(X^4(X_l^3))$ to string world-sheets. The intersection of string world sheets with $X^3 \subset \delta M_{\pm}^4 \times CP_2$ corresponds to a light-like curve having tangent in local tangent space $M^2(x)$ at light-cone boundary. This is the first candidate for the definition of number theoretic braid. Second definition assumes M^2 to be fixed at δCD : in this case the slicing is parameterized by the sphere S^2 defined by the light rays of δM_{\pm}^4 .
- (c) One can assign to the string world sheet -call it Y^2 - the standard area action

$$S_G(Y^2) = \int_{Y^2} T \sqrt{g_2} d^2 y \ , \quad (6.2.1)$$

where g_2 is either the induced metric or only its M^4 part. The latter option looks more natural since M^4 projection is considered. T is string tension.

- (d) The naivest guess would be $T = 1/\hbar G$ apart from some numerical constant but one must be very cautious here since $T = 1/L_p^2$ apart from a numerical constant is also a good candidate if one accepts the basic argument identifying G in terms of p-adic length L_p and Kähler action for two pieces of CP_2 type vacuum extremals representing propagating graviton. The formula reads $G = L_p^2 \exp(-2a S_K(CP_2))$, $a \leq 1$. The interaction strength which would be L_p^2 without the presence of CP_2 type vacuum extremals is reduced by the exponential factor coming from the exponent of Kähler function of configuration space.
- (e) One would have string model in either $CD \times CP_2$ or $CD \subset M^4$ with the constraint that stringy world sheet belongs to $X^4(X_l^3)$. For the extremals of $S_G(Y^2)$ gravitational four-momentum defined as Noether charge is conserved. The extremal property of string world sheet need not however be consistent with the preferred extremal property. This constraint might bring in coupling of gravitons to matter. The natural guess is that graviton corresponds to a string connecting wormhole contacts. The strings could also represent formation of gravitational bound states when they connect wormhole contacts separated by a large distance. The energy of the string is roughly $E \sim \hbar TL$ and for $T = 1/\hbar G$ gives $E \sim L/G$. Macroscopic strings are not allowed except as models of black holes. The identification $T \sim 1/L_p^2$ gives $E \sim \hbar L/L_p^2$, which does not favor long strings for large values of \hbar . The identification $G_p = L_p^2/\hbar_0$ gives $T = 1/\hbar G_p$ and $E \sim \hbar_0 L/L_p^2$, which makes sense and allows strings with length not much longer than p-adic length scale. Quantization - that is the presence of configuration space degrees of freedom- would bring in massless gravitons as deformations of string whereas strings would carry the gravitational mass.
- (f) The exponent $\exp(iS_G)$ can appear as a phase factor in the definition of quantum states for preferred extremals. S_G is not however enough. One can assign also to the points of number theoretic braid action describing the interaction of a point like current Qdx^μ/ds with induced gauge potentials A_μ . The corresponding contribution to the action is

$$S_{braid} = \int_{braid} iTr(Q \frac{dx^\mu}{ds} A_\mu) dx . \quad (6.2.2)$$

In stationary phase approximation subject to the additional constraint that a preferred extremal of Kähler action is in question one obtains the desired correlation between the geometry of preferred extremal and the quantum numbers of elementary particle. This interaction term carries information only about the charges of elementary particle. It is quite possible that the interaction term is more complex: for instance, it could contain spin dependent terms (Stern-Gerlach experiment).

- (g) The constraint coming from preferred extremal property of Kähler action can be expressed in terms of Lagrange multipliers

$$S_c = \int_{Y^2} \lambda^k D_\alpha \left(\frac{\partial L_K}{\partial_\alpha h^k} \right) \sqrt{g_2} d^2 y . \quad (6.2.3)$$

- (h) The action exponential reads as

$$\exp(iS_G + S_{braid} + S_c) . \quad (6.2.4)$$

The resulting field equations couple stringy M^4 degrees of freedom to the second variation of Kähler action with respect to M^4 coordinates and involve third derivatives of M^4 coordinates at the right hand side. If the second variation of Kähler action with respect to M^4 coordinates vanishes, free string results. This is trivially the case if a vacuum extremal of Kähler action is in question.

- (i) An interesting question is whether the preferred extremal property boils down to the condition that the second variation of Kähler action with respect to M^4 coordinates vanishes so that gravitonic string is free. The physical interpretation would be in terms of quantum criticality which is the basic conjecture about the dynamics of quantum TGD. This is clear from the fact that in 1-D system criticality means that the potential $V(x) = ax + bx^2 + ..$ has $b = 0$. In field theory criticality corresponds to the vanishing of the term $m^2\phi^2/2$ so that massless situation corresponds to massless theory and criticality and long range correlations.

What does the equality of gravitational and inertial masses mean?

Consider next the question in what form Equivalence Principle could be realized in this framework.

- (a) Coset construction inspires the conjecture that gravitational and inertial four-momenta are identical. Also some milder form of it would make sense. What is clear is that the construction of preferred extremal involving the distribution of $M^2(x)$ implies that conserved four-momentum associated with Kähler action can be expressed formally as stringy four-momentum. The integral of the conserved inertial momentum current over X^3 indeed reduces to an integral over the curve defining string as one integrates over other two degrees of freedom. It would not be surprising if a stringy expression for four-momentum would result but with string tension depending on the point of string and possibly also on the component of four-momentum. If the dependence of string tension on the point of string and on the choice of the stringy world sheet is slow, the interpretation could be in terms of coupling constant evolution associated with the stringy coordinates. An alternative interpretation is that string tension corresponds to a scalar field. A quite reasonable option is that for given X_l^3 T defines a scalar field and that the observed T corresponds to the average value of T over deformations of X_l^3 .
- (b) The minimum option is that Kähler mass is equal to the sum gravitational masses assignable to strings connecting points of wormhole throat or two different wormhole throats. This hypothesis makes sense even for wormhole contacts having size of order Planck length.
- (c) The condition that gravitational mass equals to the inertial mass (rest energy) assigned to Kähler action is the most obvious condition that one can imagine. The breaking of Poincare invariance to Lorentz invariance with respect to the tip of CD supports this form of Equivalence Principle. This would predict the value of the ratio of the parameter R^2T and p-adic length scale hypothesis would allow only discrete values for this parameter. $p \simeq 2^k$ following from the quantization of the temporal distance $T(n)$ between the tips of CD as $T(n) = 2^n T_0$ would suggest string tension $T_n = 2^n R^2$ apart from a numerical factor. $G_p \propto 2^n R^2 / \hbar_0$ would emerge as a prediction of the theory. G could be seen as a prediction or RG invariant input parameter fixed by quantum criticality. The arguments related to p-adic coupling constant evolution suggest $R^2 / \hbar_0 G = 3 \times 2^{23}$ [K30].
- (d) The scalar field property of string tension should be consistent with the vacuum degeneracy of Kähler action. For instance, for the vacuum extremals of Kähler action stringy action is non-vanishing. The simplest possibility is that one includes the integral of the scalar $J^{\mu\nu} J_{\mu\nu}$ over the degrees transversal to M^2 to the stringy action so that string tension vanishes for vacuum extremals. This would be nothing but dimensional reduction of 4-D theory to a 2-D theory using the slicing of $X^4(X_l^3)$ to partonic 2-surfaces and stringy word sheets. For cosmic strings Kähler action reduces to stringy action with string tension $T \propto 1/g_K^2 R^2$ apart from a numerical constant. If one wants consistency with $T \propto 1/L_p^2$, one must have $T \propto 1/g_K^2 2^n R^2$ for the cosmic strings deformed to Kähler magnetic flux tubes. This looks rather plausible if the thickness of deformed string in M^4 degrees of freedom is given by p-adic length scale.

Should one introduce induced spinor fields at string world sheets?

In the previous section it was found that TGD should allow also dimensionally reduced descriptions in terms of either string world sheets or partonic 2-surfaces. This raises the question whether it makes sense to introduce induced spinor fields at string world sheets. This is indeed the case. The modified Dirac action would in this case correspond to the Dirac operator for the dimensionally reduced Kähler action. The effective minimal surface property of Y^2 would guarantee the conservation of the super current. The realization of the effective 3-dimensionality in turn means that the stringy coordinate u corresponds to a gauge degree of freedom or to the condition $D_u \Psi = 0$. There would no spinor waves propagating along this direction of string and only the deformations of string represented by symplectic and Kac-Moody algebras present also in the dynamics of Kähler action responsible for the p-adic thermodynamics would be present. Besides this there would be the fermionic excitations associated with the ends of the string and correspond to the eigenmodes of $D_K(X^2)$ or equivalently with $D_K(Y^1)$ so that the Dirac determinant would be the same as obtained for D_K . For the description in terms of partonic 2-surfaces the Dirac operator would be just $D_K(X^2)$ and also now the equivalence with the 4-D description follows trivially.

What is the connection with General Relativity?

The connection with the stringy description makes it easier to believe that General Relativity gives a reasonable approximate description of gravitational interactions in long length scales also in TGD framework. In short length scales paradoxes are obtained if the description in terms of curvature scalar is assumed.

The vacuum degeneracy of Kähler action is in key role. The topological condensation of CP_2 type vacuum extremals representing fermions and pieces of CP_2 type extremals (wormhole contacts) identified as gauge bosons deforms the vacuum extremals to non-vacuum extremals, and the resulting density of inertial momentum equals to the density of gravitational momentum in stringy sense. If stringy gravitational energy momentum density is proportional to $1/L_p^2$ and if G relates to L_p^2 in the proposed manner, the natural hypothesis is that Einstein tensor provides a good approximation for the density of gravitational four-momentum as non-conserved Noether currents for the curvature scalar action associated with the induced metric. In zero energy ontology the non-conservation of the density of gravitational momentum does not lead to a contradiction with the conservation of inertial four-momentum since inertial four-momentum is defined only for CD in given scale so that conservation laws hold also only in this scale and in finite measurement resolution.

What does one mean with the evolution of gravitational constant?

From above it is clear that although it is possible to speak about the evolution of string tension $T(x)$ for string space-time sheets inside given CD , it does not makes sense to speak about evolution of G inside CD s because the relationship between T and G is not so simple as one might naively expect. One can of course consider the possibility that $T(x)$ is RG invariant and thus constant for the preferred extremals of Kähler action. This could hold module finite measurement resolution for M^4 coordinates defined by the size of the sub- CD s of a given CD . Hence string model description would be exact under quantum criticality assumption in the sense that the second variation of Kähler action with respect to M^4 coordinates vanishes.

As found, gravitational constant can be understood as a product of L_p^2 with the exponential of Kähler action for the two pieces of CP_2 type vacuum extremals representing wormhole contacts assignable to graviton connected by string world sheet. The volume of the typical CP_2 type extremals associated with the graviton increases with L_p so that the exponential factor decreases reducing the growth due to the increase of L_p . Hence G could be RG invariant in p-adic coupling constant evolution: this requires that volume depends on logarithmically on L_p . This point will be discussed in more detail later.

Can one predict the value of gravitational constant?

A lot remains to be understood. The value of gravitational constant is one important example in this respect. For a given space-time sheet defined as a preferred extremal of Kähler action one can in principle calculate the value of G_{class} . Physical gravitational constant G is however expected to quantum average of G_{class} for a given quantum state.

For years ago I found a nice formula relating G to CP_2 length scale, the p-adic prime p characterizing gravitons and equal to M_{127} in the case of ordinary graviton, and Kähler coupling strength [K36, K5]. Quantum formula is in question since the exponent for the Kähler action for CP_2 type vacuum extremals appears in it. The task would be to calculate explicitly the G_{class} and its quantum expectation value.

What seems clear is that G is state dependent. For instance, for quantum states concentrated around almost vacuum extremals (such as hadronic strings) G should be large since they are almost Kähler vacua and the model for hadrons indeed leads to the identification of strong gravitons with G_{strong} characterized by corresponding p-adic length scale.

One can write the basic hypothesis for the relationship between Kähler coupling strength, CP_2 size R and gravitational constant G [K36, K5] as

$$\frac{\exp(-2S_K(CP_2))}{G(p)} = \frac{1}{pR^2} . \quad (6.2.5)$$

$S_K(CP_2)$ is Kähler action for CP_2 type vacuum extremals with small renormalization reflecting the fact that entire free CP_2 type extremal is not in question topological condensation. The two sides of this equation suggest an interpretation in terms of two thermodynamics. The vacuum functional defined by Kähler function would define the thermodynamics of the left hand side and Planck mass $M_{Pl}(p) = 1/\sqrt{G(p)}$ defining the fundamental mass equal to Planck mass for $p = M_{127}$ but depending on p as $1/\sqrt{p}$. Right hand side would correspond to p-adic thermodynamics with CP_2 mass $M_{CP_2} = 1/R$ defining the fundamental mass in this case. Thus the formula could be interpreted as stating as equivalence of two different approaches to the calculation of particle masses.

Equivalence Principle and zero energy ontology

In TGD framework Equivalence Principle has several formulations.

- (a) The fundamental quantum formulation is in terms of coset representation for super-symplectic and super Kac-Moody algebras and identifies the four-momenta associated with these representations.
- (b) Second formulation is at space-time level and is based on the dimensional reduction of Kähler action to stringy action if preferred extremals possess the properties required by number theoretical compactification. It is essential that the information about preferred extremal is feeded into the eigenvalues spectrum of the modified Dirac action.
- (c) String tension is not however equal to gravitational constant which is identified as gravitational coupling and is equal to inverse of string tension multiplied by a factor corresponding to exponent of Kähler action for CP_2 type vacuum extremals representing graviton. The third formulation corresponds to long length scale limit at which it is possible to identify the density of gravitational four-momentum in terms of Einstein tensor. This formulation predicts that gravitational mass defined by Einstein tensor is identical with inertial mass defined by Kähler action but in some average sense since length scale resolution is not ideal.

To make this picture more concrete, it is good to list some examples about paradoxes implied by the naive application of Equivalence Principle identifying the four-momenta defined by the curvature scalar and Kähler action.

- (a) For the imbeddings of Robertson-Walker cosmologies inertial four-momentum density associated with Kähler action vanishes unlike gravitational four-momentum density, which for a long time remained quite a mystery. The solution of the paradox is that real space-time surface is a deformation of the vacuum extremal representing Robertson-Walker cosmology. The deformation obtained by glueing fermions as CP_2 type vacuum extremals. Also gauge bosons represented as wormhole contacts connecting the space-time surface to a space-time sheet with opposite arrow of geometric time (negative energy state) are present. The gravitational and inertial four-momenta of these particles are equal to the four-momentum density characterized by Einstein tensor. The density of Kähler four-momentum is not visible since it resides in the details which are smoothed out.
- (b) The empirical fact is that inertial 4-momentum as measurement in laboratory time scales is conserved whereas gravitational momentum is not. Zero energy ontology resolves this paradox. One can speak of positive energy states only in a given length scale characterizing the size of causal diamond (CD). Improved measurement resolution brings visible new zero energy states in shorter time scales. In principle zero energy ontology allows generation of entire galaxies from vacuum so that energy conservation holds true only inside given CD and within measurement resolution associated with it. Hence Robertson-Walker cosmologies in which gravitational four-momentum is not conserved provides a statistical description for how the energy of positive energy state changes. As a matter fact, TGD strongly suggests a hierarchy of Robertson-Walker cosmologies corresponding to p-adic length scale hierarchy and dark matter hierarchy.
- (c) For cosmic strings of form $X^2 \times Y^2 \subset M^4 \times CP_2$ Einstein's equations hold true but with wrong value of gravitational constant. TGD predicts also a huge variety of string like vacuum extremals of form $X^2 \times Y^2$ metrically. The dimension of M^4 projection is smaller than 4. The gravitational mass of the object -if given by Einstein tensor- depends on the genus of Y^2 and is negative if the genus is larger than 1. Einstein's equations do not make sense in these cases and there is no reason to expect this since the length scale associated with this objects is of order CP_2 length since M^4 projection is not 4-dimensional.

Equivalence Principle at elementary particle level

The following concrete example about interpretation of Equivalence Principle at elementary particle level is included to illustrate how ideas have gradually evolved and also to show that one must still keep mind open.

Topologically condensed CP_2 type vacuum extremals define a model for elementary particle. Their gravitational four-momentum -if defined by Noether current associated with curvature scalar- is non-vanishing, light-like, and non-conserved. For free CP_2 type extremal the inertial four-momentum vanishes since Kähler currents vanish in M^4 degrees of freedom. In topological condensation CP_2 type vacuum extremal is necessarily deformed to a non-vacuum extremal. The induced four-metric becomes degenerate at the light-like wormhole throat(s) in the case of fermions (gauge bosons) since the Euclidian signature of metric is changed to Minkowskian one.

The natural expectation is that the inertial four-momentum associated with topologically condensed CP_2 type vacuum extremal equals to the gravitational four-momentum assignable to CP_2 type extremal. The question was what this gravitational four-momentum means.

- (a) The Einstein tensor associated with CP_2 type extremal gives rise to a non-conserved light-like four-momentum in the direction of the tangent light-like curve. The identification of gravitational four-momentum in terms of Einstein tensor however leads to difficulties with cosmic strings. For instance, gravitational mass can be negative.
- (b) The attempt to realize gravitational four-momentum as Noether current in the framework of almost-topological QFT based on Chern-Simons action led also to a difficulty since the four-momentum Noether current associated with $C - S$ action vanishes identically. Same is true for the Noether current associated with the modified Dirac action associated with $C - S$ action. The proposed solution of the problem was the addition of pure gauge part $A_a = \text{constant}$ to the Kähler gauge potential of CP_2 , where a refers to the light-cone proper

time assignable to CD [K19] . This gives under some conditions constant mass squared but the four-momentum given by Noether current is of course non-conserved and the conserved four-momentum should correspond to average of this four-momentum (option I) or simply the integral over these four-momenta over 2-D sections of X_l^3 (option II). This approach led to a difficulty with the realization of the hierarchy of Planck constants in the most general sense.

- (c) After the realization that number theoretical compactification implies the slicing of preferred extremal $X^4(X_l^3)$ to light-like 3-surfaces Y_l^3 parallel to X_l^3 and also dual slicings to string worlds sheets Y^2 and partonic 2-surfaces X^2 , it became clear that preferred extremals have the property that the slices Y_l^3 behave like independent dynamical units so that 3-dimensional dynamical objects become effectively 2-dimensional [K19, K36] . This made it also clear how to code information about the preferred extremal of Kähler action to the eigenvalue spectrum associated with the modified Dirac operator D_K associated with the Kähler action for the preferred extremal. This spectrum codes also for the conserved charges associated with the preferred extremal so that there is not need to assign the four-momentum to $C - S$ action. One can also assign conserved charges to the modified Dirac action if the first variation of D_K with respect to the imbedding space coordinates vanishes which means that the second variation of Kähler action vanishes. It is actually enough that the second variations representing symmetries giving rise to the conserved charges vanish. This gives a rather precise content for the notion of quantum criticality and for the notion of preferred extremal.
- (d) In this framework $C - S$ action is replaced with the imaginary part of Kähler action expressible as instanton density proportional to $J \wedge J$. This contribution does not affect Kähler function but gives rise to $C - S$ term at surfaces X_l^3 . Modified Dirac operator receives an imaginary contribution from $J \wedge J$, and its spectrum becomes complex so that Dirac determinant can be equal to the exponent of Kähler action multiplied by the exponent imaginary instanton term. This provides a first principle explanation for CP breaking behind matter antimatter asymmetry and CKM mixing as well as anyonization and quantum Hall effect [K63] .
- (e) The discovery of dual slicings of $X^4(X_l^3)$ by stringy world sheets and partonic two-surfaces lead also to the realization that dimensional reduction allows to assign to Kähler action stringy action and Equivalence Principle naturally follows at elementary particle level. In this framework both Kähler coupling strength and gravitational constant emerge as predictions of the theory.

The random light-like motion of partonic 2-surface provides justification for p-adic thermodynamics. The original interpretation was however partially wrong.

- (a) The random zitterbewegung of CP_2 type vacuum extremal with light velocity allows to understand heuristically the massivation of fermions in terms of p-adic thermodynamics. The first guess was that four-momentum would be simply the average of or sum over the non-conserved four-momenta associated with partonic 2-surface and led to the vision about the role of $C - S$ action. This vision must be given up.
- (b) p-Adic thermodynamics corresponds to thermodynamics for conformal weight. The basic dynamical object must be therefore 2-dimensional partonic surface. Also Lorentz invariance requires that it is thermal conformal weight which is generated by p-adic thermodynamics and mass squared is proportional to this. Light-like randomness implies the thermalization of conformal weight. Conformal symmetry indeed allows to identify conformal weight as quantum number and the squares of generalized eigenvalues of D_{C-S} have identification as conformal weights. One must of course remember also that it is not at all clear whether the masses as predicted by p-adic thermodynamics are identical with classical masses.
- (c) The equivalence of mass squared identified as thermal conformal weight with the square of inertial or gravitational momentum remains to be proven rigorously. The understanding of this connection might lead to unexpected progress.

6.2.3 Long length scale limit of TGD as General Relativity with sub-manifold constraint

What is the precise relationship of the long length scale limit of TGD to General Relativity as a description of gravitational interactions has remained somewhat unclear. On basis of physical intuition it is clear that Einstein's equations hold true for the matter topologically condensed around vacuum extremals of Kähler action and that energy momentum tensor can be described as average description for small deformations of vacuum extremals. The question is what happens in case of non-vacuum extremals. Does a simple variational principle leading to Einstein's equations at long length scale limit exist and allow to identify the solutions as extremals of Kähler action?

The answer to the question is affirmative. It has been clear from the beginning that TGD in long length scales as a theory of gravitational interactions is General Relativity with a sub-manifold constraint. The problem is to formulate this statement so that extremals of Kähler action are consistent with Einstein's equations.

Consider first a simpler situation for which Kähler action is replaced with four-volume.

- (a) Let us start from an action containing curvature scalar and a part describing matter. The simplest that one can try is to add just a constraint term

$$\Lambda^{\alpha\beta}(g_{\alpha\beta} - h_{kl}\partial_\alpha h^k \partial_\beta h^l) \quad (6.2.6)$$

telling that the metric is induced metric.

- (b) The resulting gravitational field equations obtained by varying with respect to $g_{\alpha\beta}$ would be Einstein equations $T^{\alpha\beta} - kG^{\alpha\beta} = 0$ modified to

$$T^{\alpha\beta} - kG^{\alpha\beta} = \Lambda^{\alpha\beta} . \quad (6.2.7)$$

Einstein's equations would be modified by the vacuum energy term which satisfies an additional constraint equation following from the variation with respect to imbedding space coordinates.

- (c) The variation with respect to imbedding space coordinates gives

$$D_\beta(\Lambda^{\alpha\beta}\partial_\beta h^l) = 0 . \quad (6.2.8)$$

The latter equation is satisfied if space-time surface is an extremal of general coordinate invariant action constructed from the induced metric only. Volume term would be the simplest possibility and this would give

$$\Lambda^{\alpha\beta} = K g^{\alpha\beta} ,$$

and Eq. 6.2.7 would give Einstein's equations with cosmological constant. One can get rid of cosmological constant simply by adding to the curvature scalar part cosmological term compensating it. It is essential that the energy momentum current $T^{\alpha k} = K g^{\alpha\beta} \partial_\beta h^k$ is parallel to the space-time surfaces as an imbedding space-vector field: this is true for actions involving only the induced metric.

In the case Kähler action both induced metric and induced Kähler form appear as field variables expressible in terms of the imbedding space coordinates. The energy momentum currents $T_k^\alpha = \partial L_K / \partial_\alpha h^k$ appearing in the field equations for Kähler action contains a part orthogonal to the space-time surface so that one cannot have

$$T^{\alpha k} = T^{\alpha\beta} \partial_\beta h^k$$

since the right hand side is parallel to the space-time surface. This makes the situation more complex.

- (a) One can express the sub-manifold constraint using the projections of vielbein of H rather than metric so that one obtains the constraint term

$$\Lambda^{\alpha A}(e_{A\alpha} - e_{Ak}\partial_\alpha h^k) . \quad (6.2.9)$$

- (b) Besides this the action contains the constraint terms

$$\begin{aligned} & \Lambda^{\alpha\beta}(g_{\alpha\beta} - e_{A\alpha}e_\beta^A) , \\ & F^{\alpha\beta}(J_{\alpha\beta} - J_{AB}e_\alpha^A e_\beta^B) \end{aligned} \quad (6.2.10)$$

with an obvious interpretation.

- (c) One must also add to the action Kähler action density

$$L_K = \frac{1}{2g_K^2} J^{\alpha\beta} J_{\alpha\beta} \sqrt{g} , \quad (6.2.11)$$

where $J_{\alpha\beta}$ is treated as a primary gauge field in the variation.

The resulting field equations give field equations for an extremal of Kähler action and Einstein's equations.

- (a) The gravitational field equations are obtained by varying with respect to $g_{\alpha\beta}$ regarded as a primary field

$$\Lambda^{\alpha\beta} = T^{\alpha\beta} - kG^{\alpha\beta} + T_K^{\alpha\beta} . \quad (6.2.12)$$

Here $T_K^{\alpha\beta}$ is standard energy momentum tensor associated with Kähler action treating $J_{\alpha\beta}$ as a primary field.

- (b) The variation with respect to $J_{\alpha\beta}$ regarded as a primary field gives

$$F^{\alpha\beta} = J^{\alpha\beta} \sqrt{g} . \quad (6.2.13)$$

- (c) The variation with respect to $e_{A\alpha}$ gives

$$2\Lambda^{\alpha\beta} e_\beta^A + J^{\alpha\beta} J^{AB} e_{B\beta} + \Lambda^{A\alpha} = 0 . \quad (6.2.14)$$

- (d) Finally, the variation with respect to h^k gives

$$D_\beta(\Lambda^{A\alpha} e_A^k) = 0 . \quad (6.2.15)$$

These equations require a variational principle and are equivalent with those for the extremals of Kähler action if one make the identification

$$\Lambda^{A\alpha} = e_k^A T^{\alpha k} , \quad T^{\alpha k} = \frac{\partial L_K}{\partial_\alpha h^k} . \quad (6.2.16)$$

- (e) Substituting $\Lambda^{\alpha\beta}$ as given by Eq. 6.2.16 and $\Lambda^{\alpha\beta}$ as given by Eq. 6.2.12 to Eq. 6.2.14, one finds that the terms involving Kähler gauge field cancel each other neatly, and one obtains

$$(T^{\alpha\beta} - kG^{\alpha\beta})e_{\beta}^A = 0 . \quad (6.2.17)$$

This is equivalent with Einstein's equations. Note that the addition of Kähler action is necessary in order to compensate the terms orthogonal to the space-time surface and - somewhat paradoxically- implies that Kähler action does not contribute to the energy momentum tensor. This is as it should be.

This looks nice but in the following even more elegant manner to obtain Einstein's equations for preferred extremals is described.

6.2.4 Could preferred extremals of Kähler action satisfy Einstein's equations?

The view described above would assign Einstein's equations with the long length scale limit of the theory as a statistical description for deformations of vacuum extremals [K11]. It came as a total surprise that the preferred extremals could actually satisfy these equations in all scales as a consequence of the Bohr orbit property. This observation emerged from the consideration of possible deformations of the existing extremals, which can be regarded as degenerate special cases of more general solution families.

The basic ideas are following.

- (a) The field equations must reduce to purely algebraic statements saying that the contraction of the Maxwell's energy momentum tensor with the second fundamental form vanishes because the non-vanishing components do not have any common index pairs. For Minkowskian signature this requires that the Kähler gauge current either vanishes or is light-like. For Euclidian signature the condition can be achieved if the current vanishes or if the M^4 projection is 3-dimensional and the current is of form $j = *d\Phi \wedge J$, where Φ is a scalar function. This condition guarantees the vanishing of terms involving Kähler current in field equations and one obtains just $Tr(TH^k) = 0$ generalizing minimal surface equation.
- (b) The same conditions for Kähler gauge current also guarantee that Kähler action reduces to 3-D terms assignable to the ends of the space-time sheet at the light-like boundaries of the causal diamond, and to terms assignable to the light-like 3-surfaces at which the signature of the induced metric changes. The weak form of electric magnetic duality implies a reduction to Chern-Simons terms and one obtains almost topological QFT and holography at the level of Kähler action.
- (c) For the Euclidian signature of the induced metric the conditions $Tr(TH^k) = 0$ reduce to purely algebraic conditions if the induced metric is Hermitian. For Minkowskian signature these conditions generalize to a condition that the induced metric has a Hamilton-Jacobi structure generalizing the complex structure of CP_2 . Hamilton-Jacobi structure is essentially an integrable distribution for the products of hyper-complex structure and complex structure in the tangent spaces $M^4(m) = M^2(m) \times_{\text{times}} E^2(m)$ of M^4 . One has global coordinates (u, v, w, \bar{w}) for the distribution: here (u, v) defines a pair of light-like coordinates for 2-D surfaces defined by the distribution of $M^2(m)$ for fixed values of w and \bar{w} defining complex coordinates for the distribution of $E^2(m)$ for fixed values of (u, v) . The non-vanishing components of the induced metric are $(g_{uv}, g_{w\bar{w}})$. The counterpart of complex coordinates of CP_2 are Hamilton-Jacobi coordinates.
- (d) The superconformal symmetries of superstring models generalizes to four-dimensional symmetries as indeed conjectured. The of Hermitian/Hamilton-Jacobi structure implies that certain components of the induced metric vanish and these conditions are identical with the corresponding conditions for minimal surface solutions in strong model. A very elegant generalization of the algebraic structure of the string model emerges.

- (e) The conditions for the Kähler current imply that the divergence of the energy momentum tensor for Kähler action vanishes. This is achieved if Einstein's equations with cosmological term are satisfied. The reason is that Einstein tensor and metric define the only tensors which have identically vanishing divergence. This led Einstein to his equations. Now the same equations are necessary the reduction of field equations to the purely algebraic form.

6.2.5 The basic objection against TGD

The basic objection against TGD is that induced metrics for space-time surfaces in $M^4 \times CP_2$ form an extremely limited set in the space of all space-time metrics appearing in the path integral formulation of General Relativity. Even special metrics like the metric of a rotating black hole fail to be imbeddable as an induced metric. For instance, one can argue that TGD cannot reproduce the post-Newtonian approximation to General Relativity since it involves linear superposition of gravitational fields of massive objects. As a matter fact, Holger B. Nielsen - one of the very few colleagues who has shown interest in my work - made this objection for at least two decades ago in some conference and I remember vividly the discussion in which I tried to defend TGD with my poor English.

The objection generalizes also to induced gauge fields expressible solely in terms of CP_2 coordinates and their gradients. This argument is not so strong as one might think first since in standard model only classical electromagnetic field plays an important role.

- (a) Any electromagnetic gauge potential has in principle a local imbedding in some region. Preferred extremal property poses strong additional constraints and the linear superposition of massless modes possible in Maxwell's electrodynamics is not possible.
- (b) There are also global constraints leading to topological quantization playing a central role in the interpretation of TGD and leads to the notions of field body and magnetic body having non-trivial application even in non-perturbative hadron physics. For a very large class of preferred extremals space-time sheets decompose into regions having interpretation as geometric counterparts for massless quanta characterized by local polarization and momentum directions. Therefore it seems that TGD space-time is very quantal. Is it possible to obtain from TGD what we have used to call classical physics at all?

The imbeddability constraint has actually highly desirable implications in cosmology. The enormously tight constraints from imbeddability imply that imbeddable Robertson-Walker cosmologies with infinite duration are sub-critical so that the most pressing problem of General Relativity disappears. Critical and over-critical cosmologies are unique apart from a parameter characterizing their duration and critical cosmology replaces both inflationary cosmology and cosmology characterized by accelerating expansion. In inflationary theories the situation is just the opposite of this: one ends up with fine tuning of inflaton potential in order to obtain recent day cosmology.

Despite these and many other nice implications of the induced field concept and of sub-manifold gravity the basic question remains. Is the imbeddability condition too strong physically? What about linear superposition of fields which is exact for Maxwell's electrodynamics in vacuum and a good approximation central also in gauge theories. Can one obtain linear superposition in some sense?

- (a) Linear superposition for small deformations of gauge fields makes sense also in TGD but for space-time sheets the field variables would be the deformations of CP_2 coordinates which are scalar fields. One could use preferred complex coordinates determined about $SU(3)$ rotation to do perturbation theory but the idea about perturbations of metric and gauge fields would be lost. This does not look promising. Could linear superposition for fields be replaced with something more general but physically equivalent?
- (b) This is indeed possible. The basic observation is utterly simple: what we know is that the *effects* of gauge fields superpose. The assumption that fields superpose is un-necessary! This is a highly non-trivial lesson in what operationalism means for theoreticians tending to take these kind of considerations as mere "philosophy".

- (c) The hypothesis is that the superposition of effects of gauge fields occurs when the M^4 projections of space-time sheets carrying gauge and gravitational fields intersect so that the sheets are extremely near to each other and can touch each other (CP_2 size is the relevant scale).

A more detailed formulation goes as follows.

- (a) One can introduce common M^4 coordinates for the space-time sheets. A test particle (or real particle) is identifiable as a wormhole contact and is therefore pointlike in excellent approximation. In the intersection region for M^4 projections of space-time sheets the particle forms topological sum contacts with all the space-time sheets for which M^4 projections intersect.
- (b) The test particle experiences the sum of various gauge potentials of space-time sheets involved. For Maxwellian gauge fields linear superposition is obtained. For non-Abelian gauge fields gauge fields contain interaction terms between gauge potentials associated with different space-time sheets. Also the quantum generalization is obvious. The sum of the fields induces quantum transitions for states of individual space time sheets in some sense stationary in their internal gauge potentials.
- (c) The linear superposition applies also in the case of gravitation. The induced metric for each space-time sheet can be expressed as a sum of Minkowski metric and CP_2 part having interpretation as gravitational field. The natural hypothesis that in the above kind of situation the effective metric is sum of Minkowski metric with the sum of the CP_2 contributions from various sheets. The effective metric for the system is well-defined and one can calculate a curvature tensor for it among other things and it contains naturally the interaction terms between different space-time sheets. At the Newtonian limit one obtains linear superposition of gravitational potentials. One can also postulate that test particles moving along geodesics in the effective metric. These geodesics are not geodesics in the metrics of the space-time sheets.
- (d) This picture makes it possible to interpret classical physics as the physics based on effective gauge and gravitational fields and applying in the regions where there are many space-time sheets which M^4 intersections are non-empty. The loss of quantum coherence would be due to the effective superposition of very many modes having random phases.

The effective superposition of the CP_2 parts of the induced metrics gives rise to an effective metric which is not in general imbeddable to $M^4 \times CP_2$. Therefore many-sheeted space-time makes possible a rather wide repertoire of 4-metrics realized as effective metrics as one might have expected and the basic objection can be circumvented. In asymptotic regions where one can expect single sheetedness, only a rather narrow repertoire of "archetypal" field patterns of gauge fields and gravitational fields defined by topological field quanta is possible.

The skeptic can argue that this still need not make possible the imbedding of a rotating black hole metric as induced metric in any physically natural manner. This might be the case but need of course not be a catastrophe. We do not really know whether rotating blackhole metric is realized in Nature. I have indeed proposed that TGD predicts new physics in rotating systems. Unfortunately, gravity probe B could not check whether this new physics is there since it was located at equator where the new effects vanish.

6.3 Imbedding of the Reissner-Nordström metric

In the following the imbedding of electromagnetically neutral Reissner-Nordström metric to $M_+^4 \times CP_2$ will be studied. The imbedding generalizes to an imbedding of any spherically symmetric metric. The imbeddings as vacuum extremals reduce to imbeddings into 6-dimensional $M^4 \times Y^2$, Y^2 Lagrange manifold (vanishing induced Kähler form). Any vacuum extremal defines a solution of Einstein's equations if energy momentum tensor is defined by Einstein's equations. Non-vacuum imbeddings of Reissner-Nordström solutions would correspond to homologically non-trivial geodesic sphere of CP_2 , and it is implausible that non-vacuum imbeddings could be

extremals. Whether the imbeddings of the metrics believed to describe rotating objects in GRT Universe are possible at all, is not known but it might well be that the dimension of the imbedding space is too low to allow them. This would mean that the predictions of TGD concerning gravi-magnetism can differ from those of GRT.

6.3.1 Two basic types of imbeddings

One can construct a large number of imbeddings for Reissner-Nordström metric. These imbeddings need not be extremals of Kähler action except when they are represent vacua.

- (a) X^4 could be a sub-manifold of $M^4 \times S_i^2$, $i = I, II$, where S_i^2 is one of the geodesic spheres of CP_2 . For $i = II$ the imbeddings are vacuum extremals but this is not the case for $i = I$. The properties of these imbeddings are essentially those associated with the spherically symmetric stationary extremals of the Kähler action. Long range electromagnetic and Z^0 fields assignable to dark matter [K9, K8, K35] are present but the corresponding forces are by a factor 10^{-4} weaker than gravitational force, when the parameter ωR is of order one.
- (b) The vacuum extremals of the Kähler action are the physically most interesting candidates for the imbeddings of solutions of Einstein's equations. For these imbeddings electro-weak fields are in general non-vanishing. Em neutrality is possible to achieve only for $p = \sin^2(\theta_W) = 0$. Long ranged W^+ and W^- fields can be present and they induce a small mixing between charged dark lepton and corresponding neutrino spinors.

6.3.2 The condition guaranteing the vanishing of em, Z^0 , or Kähler fields

In order to obtain imbedding with vanishing em, Z^0 , or Kähler field, one must pose the condition guaranteing the vanishing of corresponding field (see the Appendix of the book). For extremals of Kähler action em Z^0 fields are always simultaneously present unless Weinberg angle vanishes. In practice only the condition guaranteing vanishing of Kähler field is thus interesting.

Using coordinates $(r, u = \cos(\Theta), \Psi, \Phi)$ for CP_2 the surfaces in question can be expressed as

$$\begin{aligned} r &= \sqrt{\frac{X}{1-X}} \ , \\ X &= D|k+u|^\epsilon \ , \\ u &\equiv \cos(\Theta) \ , \quad D = \frac{r_0^2}{1+r_0^2} \times \frac{1}{C} \ , \quad C = |k + \cos(\Theta_0)|^\epsilon \ . \end{aligned} \quad (6.3.1)$$

Here C and D are integration constants. The value of the parameter ϵ characterizes which field vanishes:

$$\begin{aligned} a) \quad \epsilon &= \frac{3+p}{3+2p} \ , \quad b) \quad \epsilon = \frac{1}{2} \ , \quad c) \quad \epsilon = 1 \ , \\ & \quad p = \sin^2(\Theta_W) \ . \end{aligned} \quad (6.3.2)$$

Here a/b/c corresponds to the vanishing of em/ Z^0 /Kähler field.

$0 \leq X \leq 1$ is required by the reality of r . $r = 0$ would correspond to $X = 0$ giving $u = -k$ achieved only for $|k| \leq 1$ and $r = \infty$ to $X = 1$ giving $|u+k| = [(1+r_0^2)/r_0^2]^\epsilon$ achieved only for

$$\text{sign}(u+k) \times \left[\frac{1+r_0^2}{r_0^2} \right]^\epsilon \leq k+1 \ ,$$

where $\text{sign}(x)$ denotes the sign of x .

These imbeddings obviously possess a 2-dimensional CP_2 projection. The generation of long range vacuum weak and color electric fields is a purely TGD based phenomenon related to the fact that gauge fields are not primary dynamical variables.

For future purposes it is convenient to list the explicit expressions of relevant gauge field when em or Kähler field vanishes.

- (a) Using coordinates $(u = \cos(\Theta), \Phi)$ the expressions for the Kähler form and Z^0 field for space-time surfaces with vanishing em field read as

$$\begin{aligned} J &= -\frac{p}{3+2p} X du \wedge d\Phi, \quad X = D|k+u|^{\frac{3+p}{3+2p}} \\ Z^0 &= -\frac{6}{p} J. \end{aligned} \tag{6.3.3}$$

- (b) For vacuum extremals ($\epsilon = 1$) classical em and Z^0 fields are proportional to each other:

$$\begin{aligned} Z^0 &= 2e^0 \wedge e^3 = \frac{r}{F^2} (k+u) \frac{\partial r}{\partial u} du \wedge d\Phi = (k+u) du \wedge d\Phi, \\ r &= \sqrt{\frac{X}{1-X}}, \quad X = D|k+u|, \\ \gamma &= -\frac{p}{2} Z^0. \end{aligned} \tag{6.3.4}$$

For a vanishing value of Weinberg angle ($p = 0$) em field vanishes and only Z^0 field remains as a long range gauge field. Vacuum extremals for which long range Z^0 field vanishes but em field is non-vanishing are not possible. The only reasonable physical interpretation seems to be in terms of a hierarchy of electro-weak physics with arbitrarily light weak boson mass scales.

The effective form of the CP_2 metric is given by

$$\begin{aligned} ds_{eff}^2 &= (s_{rr} \left(\frac{dr}{d\Theta}\right)^2 + s_{\Theta\Theta}) d\Theta^2 + (s_{\Phi\Phi} + 2ks_{\Phi\Psi}) d\Phi^2 = \frac{R^2}{4} [s_{\Theta\Theta}^{eff} d\Theta^2 + s_{\Phi\Phi}^{eff} d\Phi^2], \\ s_{\Theta\Theta}^{eff} &= X \times \left[\frac{\epsilon^2(1-u^2)}{(k+u)^2} \times \frac{1}{1-X} + 1 - X \right], \\ s_{\Phi\Phi}^{eff} &= X \times [(1-X)(k+u)^2 + 1 - u^2]. \end{aligned} \tag{6.3.5}$$

This expression is useful in the construction of electromagnetically neutral imbedding of, say Schwarzschild metric. For $k \neq 1$ $u = \pm 1$ corresponds in general to circle rather than single point as is clear from the fact that $s_{\Phi\Phi}^{eff}$ is non-vanishing at $u = \pm 1$ so that u and Φ parameterize a piece of cylinder.

6.3.3 Imbedding of Reissner-Nordström metric

The imbedding of R-N metric to be discussed generalizes with minor modifications to an imbedding of a spherically symmetric star model characterized by a mass density $\rho(r_M)$ and pressure $p(r_M)$ since the corresponding line element can be written in the form $ds^2 = A(r_M)dt^2 - B(r_M)dr_M^2 - r_M^2 d\Omega^2$ [E193]. For vacuum extremal a solution of field equations results.

Denote the coordinates of M_+^4 by (m^0, r_M, θ, ϕ) and those of X^4 by (t, r_M, θ, ϕ) . The expression for Reissner-Nordström metric reads as

$$\begin{aligned}
ds^2 &= Adt^2 - Bdr_M^2 - r_M^2 d\Omega^2 , \\
A &= 1 - \frac{a}{r_M} - \frac{b}{r_M^2} , \quad B = \frac{1}{A} , \\
a &= 2GM , \quad b = G\pi q^2 .
\end{aligned} \tag{6.3.6}$$

The imbedding is given by the expression

$$\begin{aligned}
\Phi &= \omega_1 t + f(r_M) , \\
\Psi &= k\Phi = \omega_2 t + kf(r_M) , \\
m^0 &= \lambda t + h(r_M) , \\
\lambda &= \sqrt{1 + \frac{R^2 \omega_1^2}{4} s_{\Phi\Phi}^{eff}(\infty)} , \quad k = \frac{\omega_2}{\omega_1} .
\end{aligned} \tag{6.3.7}$$

The components of s^{eff} are given by Eq. 8.2.13 and general form of imbedding by Eqs. 8.2.12 and 6.3.2.

The functions $f(r_M)$ and $h(r_M)$ are determined by the condition

$$\lambda \partial_{r_M} h = \frac{R^2}{4} s_{\Phi\Phi}^{eff} \omega_1 \partial_{r_M} f \tag{6.3.8}$$

resulting from the requirement $g_{tr_M} = 0$ and from the expression for $g_{r_M r_M} = -B$:

$$\begin{aligned}
h &= \int dr_M \sqrt{Y} , \quad Y = \frac{Y_1}{Y_2} , \\
Y_1 &= -B + 1 + \frac{R^2}{4} s_{\Theta\Theta}^{eff} \frac{(\partial_{r_M} u)^2}{(1-u^2)} , \\
Y_2 &= 1 - \frac{4\lambda^2}{R^2 \omega_1^2} \frac{s_{\Theta\Theta}^{eff}}{s_{\Phi\Phi}^{eff}} .
\end{aligned} \tag{6.3.9}$$

The condition $Y > 0$ at the limit $r \rightarrow \infty$ gives non-trivial conditions. Y_1 is positive at large values of r_M and this gives

$$Y_1 = -B + 1 + s_{\Theta\Theta}^{eff} \frac{(\partial_{r_M} u)^2}{(1-u^2)} \geq 0$$

for the allowed values of r_M . Y_1 can change sign at some critical radius above Schwarzschild radius $r_S = 2GM$ since B becomes infinite at r_S : this can be avoided only provided one has $u \rightarrow 1$ at $r_M \rightarrow r_S$. Y_2 must preserve its sign and this is possible if the value of $R\omega_1$ is sufficiently large. Below $r = r_S$ Y_1 has positive and also Y_2 can be positive down to some critical radius. At $r = r_S$ Y_1 has infinite discontinuity in case that Y_1 approaches finite value from above and CP_2 coordinates are continuous. It is easy to see that square root singularity of Θ as a function of $r_M - r_S$ is in question so that the function h is continuous so that the solution is well-defined.

The dependence of $u \equiv \cos(\Theta)$ on radial coordinate r_M is determined by the expression for $g_{tt} = A$ giving the condition

$$A = \lambda^2 - \frac{R^2 \omega_1^2}{4} s_{\Phi\Phi}^{eff} \omega_1^2 . \tag{6.3.10}$$

The asymptotic behavior of the coordinate $u = \cos(\Theta)$ is of form

$$u \simeq u_\infty + \frac{K}{r_M} , \quad (6.3.11)$$

u_∞ is fixed by the condition $A(\infty) = 1$:

$$\begin{aligned} \lambda^2 - \frac{R^2 \omega_1^2}{4} s_{\Phi\Phi}^{eff}(\infty) &= 1 , \\ s_{\Phi\Phi}^{eff} &= X \times [(1-X)(k+u)^2 + 1 - u^2] , \quad X = D|k+u|^\epsilon . \end{aligned} \quad (6.3.12)$$

The value of K is given by

$$K = \frac{8GM}{R^2 \omega_1^2} \left[\frac{\partial s_{\Phi\Phi}^{eff}}{\partial u}(\infty) \right]^{-1} . \quad (6.3.13)$$

The values of K and u_∞ depend on parameters $\lambda, R\omega_1, k, D$.

For definiteness one can assume that the value of u at infinity is non-negative:

$$u_\infty \geq 0 . \quad (6.3.14)$$

There are two different solution types depending on the sign of the parameter K .

- (a) For $K < 0$ u decreases and approaches to $u_{min} \geq 0$ as r_M decreases.
- (b) For $K > 0$ u increases and approaches to $u_{max} \leq 1$. The requirement that the solution can be continued below Schwartzild radius allows only this option. Below Schwartzild radius u must transform to a solution of type a).

Imbeddability breaks for a critical value of the radial coordinate

The imbeddability breaks for some critical value of the coordinate r_M . The extremal value of u and the radius r_c below which the imbedding fails corresponds to the maximum possible value of $s_{\Phi\Phi}^{eff}$. This value corresponds either to $u = 0, 1$ or to a vanishing derivative of $s_{\Phi\Phi}^{eff}$

$$\frac{\partial s_{\Phi\Phi}^{eff}}{\partial u} = 0 . \quad (6.3.15)$$

For $\epsilon = 1$ corresponding to vacuum extremals s_{eff} is a fourth order polynomial as a function of u depending on external parameters. One has

$$s_{\Phi\Phi}^{eff} = D|k+u| \times [(1-D|k+u|)(k+u)^2 + 1 - u^2] . \quad (6.3.16)$$

s_{eff} becomes negative for very large values of u . Hence a restriction of the standard form of the dual of the cusp catastrophe to the range $u \in (0, 1)$ results. Depending on the values of external

parameters there are either 2 maxima or single maximum. For $k = 1$ the positive extremum correspond to $u = 1/|D|$.

In the case of the Schwartshild metric this gives for the critical radius the expression

$$\begin{aligned} r_c &= \frac{r_S}{\delta} , \\ \delta &= 1 - \lambda^2 + \frac{R^2 \omega_1^2}{4} s_{\Phi\Phi}^{eff}(max) , \\ r_S &= 2GM . \end{aligned} \tag{6.3.17}$$

The existing evidence for black hole like objects suggests that it would be better to have $\delta \gg 1$ in order to get imbeddings of the Schwarzschild metric containing also horizon and part of the interior region. A sufficiently large value of $R\omega_1$ indeed allows to have arbitrarily small value of r_c . There the experimental evidence for the existence of black hole like objects leads to no problems.

The vacuum extremal imbeddings of Schwarzschild metric possess electro-weak charges

The vacuum imbeddings of Reissner-Nodrström and Swartshild metric necessarily possess some non-vanishing electro-weak charges. Consider first vacuum extremals. Z^0 electric field Z_{tr}^0 is proportional to ω_1

$$Z_{tr_M}^0 = \omega_1(k+u)\partial_{r_M}u . \tag{6.3.18}$$

The gauge flux through a sphere with radius r_M depends on r_M so that Z^0 vacuum charge density is necessarily present.

The condition $\theta \propto \sqrt{r - r_S}$ allowing to continue the imbedding below $r_M < r_S$ implies that gauge fluxes, which are proportional to $\sin(\Theta)\partial_{r_M}\Theta$, are finite at $r = r_S$ so that the renormalizations of gauge couplings remain finite at least down to Schwarzschild radius.

At large distances the gauge flux approaches to

$$\begin{aligned} Q_Z(\infty) &= \frac{1}{g_Z} \int_{r_M \rightarrow \infty} Z_{tr_M}^0 r_M^2 d\Omega , \\ &= \frac{4\pi}{g_Z} \omega_1(k+u_\infty)K = \frac{4\pi}{g_Z} (k+u_\infty) \frac{8GM}{R^2 \omega_1} \left[\frac{\partial s_{\Phi\Phi}^{eff}}{\partial u}(\infty) \right]^{-1} \end{aligned} \tag{6.3.19}$$

at the limit $r_M \rightarrow \infty$. Z^0 charge is proportional to the gravitational mass. The gauge flux grows at small distances in accordance with the general wisdom about the coupling constant evolution of $U(1)$ gauge field.

The requirement that Z^0 force is weaker than gravitational force expressed as the condition

$$\frac{Q_Z^2}{GM^2} \ll 1$$

implies

$$\frac{32\pi}{R\omega_1 g_Z} (k + u_\infty) \left[\frac{\partial s_{\Phi\Phi}^{eff}}{\partial u}(\infty) \right]^{-1} \ll \frac{R}{\sqrt{G}} . \quad (6.3.20)$$

It seems that a sufficiently large value of $R\omega_1$ allows arbitrarily small values for both the Z^0 charge and the critical radius r_c . In the earliest scenario, which was based on the assumption that CP_2 radius is of order Planck length the situation was different. It is clear that the larger radius of CP_2 makes it possible to avoid too strong classical electro-weak forces.

The non-extremal imbedding to S^2_I studied in detail here is Kähler charged and therefore also Z^0 charged since the condition $Z^0 = 6J/p$ holds true by electromagnetic neutrality. The value of the Kähler charge for non-vacuum imbedding depends on the distance from the origin

$$\begin{aligned} Q_K(r_M) &= \frac{1}{g_K} \int_{r_M=const} J_{tr_M} r_M^2 d\Omega , \\ J_{tr_M} &= -\frac{p}{2(3+p)} \omega_1 |k + u|^{\frac{3+p}{3+2p}} \partial_{r_M} u , \end{aligned} \quad (6.3.21)$$

The expression for the charge differs only in minor details from that for Z^0 charge for vacuum extremals. Essentially similar conclusions about the behavior of the gauge charges hold true also in the case of vacuum extremals and the expressions differ only by the value of the parameter ϵ characterizing whether em, Z^0 , of Kähler field vanishes.

Equivalence Principle and critical radius

When one considers Equivalence Principle, one must keep in mind that the Kähler charged imbeddings of Reissner Nodström and Schwartschild metrics are *not* extremals of Kähler action.

1. Equivalence Principle and imbeddings as vacuum extremals

In the case of vacuum extremals the interpretation is that net inertial energy density of the space-time outside the topologically condensed space-time sheet representing charged system is vanishing but the density of gravitational energy is non-vanishing and non-conserved in general. The gravitational mass of the topologically condensed space-time sheet however consists of both inertial and purely gravitational contribution. For RN solution it is natural to interpret the gravitational mass as the gravitational energy of the classical gauge fields. For genuine RN case the densities of inertial color gauge charges vanish but those for gravitational color gauge charges in $SO(3) \subset SU(3)$ are in general non-vanishing. Schwartschild metric possesses necessarily a vacuum densities of some electro-weak gauge charges but the contribution to the gravitational energy momentum tensor vanishes.

2. Equivalence Principle and imbeddings as non-vacuum extremals

One can consider Equivalence Principle in the case of Kähler charged imbeddings only if one believes that the imbedding is in a reasonable approximation an extremal. Equivalence Principle requires that the Kähler mass of the solution should be smaller than its gravitational mass. This does not pose any conditions on the critical radius since the density of Kähler charge can change sign inside the critical radius (meaning that antimatter dominates inside the critical radius). Thus no constraints results.

The strongest form of Equivalence Principle would require that the Kähler mass of the solution equals to its gravitational mass. It is difficult to see how this could be implied by any deep principle. This requirement poses a lower limit to the critical radius since the Kähler energy

outside the critical radius should be smaller than the gravitational mass of the system. In the lowest order approximation this energy is given by the expression

$$\begin{aligned}\frac{E_K}{M} &= \frac{1}{8\pi\alpha_K M} \int_{r_M \geq r_c} \lambda E_K^2 dV \\ &= \frac{\lambda Q_K^2 r_S}{GM^2 r_c} .\end{aligned}\tag{6.3.22}$$

The requirement that electro-weak interactions are much weak than gravitational interaction imply the condition $Q_K^2/GM^2 \ll 1$ so that the ratio can be equal to 1 as Equivalence Principle requires only if $r_S/r_c \gg 1$ holds true.

Gravitational energy is not conserved for vacuum imbedding of Reissner-Nordström metric

The inertial energy associated with Kähler action inside a ball of given radius is not conserved for Reissner-Nordström metric imbedded as a non-vacuum extremal since extremal of Kähler action is not in question. This follows from the dependence $m^0 = \lambda t + h(r_M)$ implying that energy current has a radial component and from the non-vanishing of $T^{r_M r_M}$. The non-conservation is not due to the outflow of energy but due to the fact that in the case of Kähler charged imbedding field equations are not satisfied. The basic reason is that the contraction of the energy momentum tensor with the second fundamental form is non-vanishing.

For vacuum extremals it is gravitational energy which fails to be conserved. For instance, for the imbedding of Reissner-Nordström this happens. Only at the limit of Schwarzschild metric gravitational energy is conserved. The vacuum extremals which are extremals of Einstein-Hilbert action for the induced metric conserve gravitational four momenta and color charges and are excellent candidates for models of the asymptotic state of star.

The simplest interpretation for the non-conservation of gravitational energy without losing Equivalence Principle is in terms of zero energy ontology. In zero energy ontology the extremals of curvature scalar have interpretation in terms of infinitely long time scale associated with the causal diamond.

The non-stationarity of the vacuum extremal imbedding ($m^0 = \lambda t + h(r_M)$) of R-N metric leads to the following expression for the rate of the change of gravitational energy per time inside a sphere of radius r

$$\begin{aligned}\frac{dE_{vap}/dt}{E(r_M)} &= \frac{dE(r_M)/dt}{E(r_M)} + X , \\ X &= \frac{\int T^{r_M r_M} \partial_{r_M} m^0 \sqrt{g} d\Omega}{E(r_M)} , \\ E(r_M) &= \int T^{tt} \partial_0 m^0 \sqrt{g} dV .\end{aligned}\tag{6.3.23}$$

The latter term depending on $T^{r_M r_M}$ takes into account the flow of gravitational energy through boundaries of the sphere and is in general non-vanishing for Reissner-Nordström metric.

Since the proposed solution ansatz works also in the more general case of a stationary spherically symmetric star model, characterized by the pressure $p(r_M)$ and the energy density $\rho(r_M)$, one can write a general order of magnitude estimate for the gravitational energy transfer associated with the boundary of the sphere approximating $h(r_M)$ with the corresponding function for the Schwarzschild metric for large values of r_M as

$$X \simeq -\partial_{r_M} h(r_M) \frac{4\pi p r_M^2}{M} . \quad (6.3.24)$$

The explicit expression for $\partial_{r_M} h(r_M)$ is given by

$$\begin{aligned} \partial_{r_M} h(r_M) &\simeq \frac{1}{\lambda} \sqrt{\frac{Y_1}{Y_2}} , \\ Y_1 &= -B + 1 + \frac{R^2}{4} s_{\Theta\Theta}^{eff} \frac{(\partial_{r_M} u)^2}{(1-u^2)} , \\ Y_2 &= 1 - \frac{4\lambda^2}{R^2 \omega_1^2} \frac{s_{\Theta\Theta}^{eff}}{s_{\Phi\Phi}^{eff}} . \end{aligned} \quad (6.3.25)$$

Here B is determined by the Einstein equations defining the star model and can be approximated with its value for Schwarzschild metric.

At the surface of the Sun ($r_M \simeq 6 \cdot 10^8 m$, particle density $n \simeq 10^{21}/m^3$, $T \simeq 0.5 eV$, $M \simeq 10^{57} m_p$ and pressure $p \simeq nT$) the order of magnitude of this term is about $X/E \simeq 2\pi K 10^{-13}/year$. For $K \sim 1$ (obtained if the radius of CP_2 is of order Planck length) the loss would be of the same order of magnitude as the inertial energy loss associated with the solar wind: $K \sim 1/k$, $10^4 < k \ll 10^8$, however implies that the loss is roughly four orders of magnitudes smaller.

It should be noticed that in the case of matter dominated cosmology shows that the rate for the reduction of the gravitational energy is of the order of $(dE/da)/E \simeq 1/a \simeq 10^{-11}/year$, which is of the same order as the fusion energy production of Sun. Thus it would seem that the rate for the change of gravitational energy in cosmological length scales is same as that for the inertial energy in the solar length scale.

6.4 A model for the final state of the star

As found, the energy production by fusion inside stars is of the same order of magnitude as the rate of change for the gravitational energy associated with the recent matter dominated cosmology. Since no energy is produced in the final state of the star, the stationary solutions provide a natural model for the final state of the star.

Besides stationarity, there is also a second new element, namely color and electro-weak long ranged forces coupling to the dark matter. For instance, for Kähler charged extremals one necessary has classical Z^0 force even when classical em force can vanish. For Schwarzschild solution this force becomes very strong at small values of the radial distance. Therefore the presence of the Z^0 force, and presumably also other classical electro-weak forces, are expected play crucial role in the dynamics of the compact objects. The most plausible physical interpretation is in terms of dark matter.

The topics to be discussed in the following are:

- (a) Spherically symmetric stationary model for the final state of the star. It is found that the model cannot be completely realistic since the stationarity assumption fails at the origin and at the surface of the star.
- (b) Generalization of the model to what could be called dynamo model in order to achieve stationarity.
- (c) The possible consequences of long range weak and color forces associated with dark matter, in particular the Z^0 force, concerning the dynamics of the compact objects.

The original discussion was based on a different view about energy and motivated the study of Kähler charged solutions with the stationarity property. These 4-surfaces are *not* extremals of the Kähler action. The replacement of the stationary solutions with vacuum extremals requires however only the replacement of the geodesic sphere S_I^2 with S_{II}^2 implying that both em and Z^0 fields are unavoidably present (or even W^\pm fields, depending on vacuum extremal). A serious limitation of the model is that it is single-sheeted. Indeed, the fact that the rotation axis and magnetic axis of super novae are different can be seen as a signal of many-sheeted-ness: the dominantly em and Z^0 fields would reside at different space-time sheets and would correspond to ordinary and dark matter. Of course, entire hierarchy of space-time sheets are expected to be present.

6.4.1 Spherically symmetric model

The simplest model for the final state of the star that one can imagine is obtained by assuming time translation invariance plus spherical symmetry and imbeddability to $M^4 \times S_i^2$, where S_i^2 , $i = I, II$ is the geodesic sphere of CP_2 . For the homologically non-trivial sphere S_I^2 the solution is *not* an extremal whereas S_{II}^2 gives an extremal with a vanishing density of inertial energy. In the original discussion cosmological constant was assumed to vanish. There are excellent reasons to assume that this constant is so small that it does not have any appreciable effects in the scale of the star and can thus be neglected. The nice feature of this kind of model is that symmetry assumptions plus stationarity requirement fix almost completely the model: no assumptions about the equation of state for the matter inside the star are needed.

The solution ansatz giving rise to vacuum extremal corresponds to a surface $X^4 \subset M_+^4 \times S_{II}^2$, where S_{II}^2 is the homologically trivial geodesic sphere of CP_2 . The solution ansatz has the same general form as the imbedding of spherically symmetric metric.

$$\begin{aligned} m^0 &= \lambda t + h(r) , \\ \Theta &= \Theta(r) , \\ \Phi &= \omega t + k(r) . \end{aligned} \tag{6.4.1}$$

The requirement that g_{tr} vanishes, implies a relationship between the functions $h(r)$ and $k(r)$. One might think that the simplest model is obtained, when the functions $h(r)$ and $k(r)$ vanish identically. One doesn't however obtain physically acceptable solutions in this manner: this is seen by expressing the g_{rr} component of the metric in terms of the mass function

$$-g_{rr} = 1 + \frac{R^2}{4} (\partial_r \Theta)^2 = \frac{1}{1 - \frac{2GM(r)}{r}} .$$

At the radii of order star radius (larger than Schwarzschild radius $r_S = 2GM$) the gradient of Θ must be of the order of $1/R$ and this is inconsistent with the finite range of possible values for Θ .

As already shown the field equations $G^{\alpha\beta} D_\beta \partial_\alpha h^k = 0$ are obtained by varying the integral of the curvature scalar over the space time surface. Field equations reduce to conservation conditions for suitably chosen conserved current: for instance the relevant components of the gravitational 4-momentum and gravitational color currents and express the conservation of gravitational four-momentum current and corresponding color currents.

The expression for the induced metric is given by

$$\begin{aligned} ds^2 &= B dt^2 - A dr^2 - r^2 d\Omega^2 , \\ B &= \lambda^2 - \frac{R^2 \omega^2}{4} \sin^2 \Theta , \\ A &= 1 + \frac{R^2}{4} (\partial_r \Theta)^2 + \frac{R^2}{4} \sin^2 \Theta (\partial_r k)^2 - (\partial_r h)^2 . \end{aligned} \tag{6.4.2}$$

The vanishing of the g_{tr} component of the metric implies the condition

$$\lambda \partial_r h - \frac{R^2}{4} \sin^2 \Theta \omega \partial_r k = 0 . \quad (6.4.3)$$

The expressions for the components of Einstein tensor for spherically symmetric stationary metric are given by

$$\begin{aligned} G^{rr} &= \frac{1}{A^2} \left(-\frac{\partial_r B}{Br} + \frac{(A-1)}{r^2} \right) , \\ G^{\theta\theta} &= \frac{1}{r^2} \left[-\frac{\partial_r^2 B}{2BA} + \frac{1}{2Ar} \left(\frac{\partial_r A}{A} - \frac{\partial_r B}{B} \right) \right. \\ &\quad \left. + \frac{\partial_r B}{4AB} \left(\frac{\partial_r A}{A} + \frac{\partial_r B}{B} \right) \right] , \\ G^{tt} &= \frac{1}{AB} \left(-\frac{\partial_r A}{Ar} + \frac{(1-A)}{r^2} \right) . \end{aligned} \quad (6.4.4)$$

A solution of the field equations with one-dimensional CP_2 projection and vanishing gauge fields is obtained by specifying the solution ansatz in the following manner

$$\begin{aligned} \Theta &= \frac{\pi}{2} , \\ h(r) &= hr , \\ k(r) &= kr . \end{aligned} \quad (6.4.5)$$

The requirement that g_{rt} vanishes gives the condition

$$h\lambda = R^2 \omega k / 4 .$$

The functions A and B are in this case just constants. Since A differs from unity, the resulting metric is however non-flat and the non-vanishing components of the Einstein tensor are given by the expressions

$$\begin{aligned} G^{tt} &= \frac{(1-A)}{ABr^2} , \\ G^{rr} &= -\frac{(1-A)}{A^2 r^2} . \end{aligned} \quad (6.4.6)$$

Field equations can be written as conservation conditions, say for the components of gravitational 4-momentum and the conserved "gravitational" color charges associated with the symmetry $\Phi \rightarrow \Phi + \varepsilon$. Quite generally, "gravitational" isometry currents have only time and radial components and radial component represent radial flow to or from the origin. Since the time component is time independent, the field equations state that radial flow is constant so that radial component of the current must behave as $1/r^2$. This is guaranteed provided the condition

$$\partial_r (G^{rr} \sqrt{g}) = 0 \quad (6.4.7)$$

holds true: this is indeed the case since G^{rr} is proportional to $1/r^2$.

The radial flow of gravitational energy is non-vanishing due to $m^0 = \lambda t t + h(r)$ behavior and given by the expression

$$J^r = \frac{G^{rr} h}{16\pi G} .$$

The conservation condition for J^r fails to be satisfied at origin, which acts as a source or a sink for the gravitational energy. Conservation law fails also at the surface of the star.

One can consider several interpretations.

- (a) Gravitational mass could be genuinely non-conserved at these locations. Dark particles *resp.* antiparticles with positive *resp.* negative energy would be created in the center of star such that the net density of inertial energy remains zero. Positive and negative energy particles would flow along their own space-time sheets to the outer surface and annihilate there so that there would be no net growth of the gravitational mass. The simplest possibility is that $\#$ contacts, which correspond to bound states of parton and negative energy antiparton [K35], split to give rise to particles of opposite inertial energy. At the outer surface $\#$ contacts fuse together again.
- (b) Second option assumes the conservation of gravitational four-momentum. At the surface the non-conservation could result from the flow of the gravitational 4-momentum to a larger space-time sheet via join along boundaries bonds. No net flow of inertial energy would be involved since positive and negative energy flows must cancel each other. For example, for a physically acceptable solution the gravitational energy might flow radially from or towards the z-axis, flow to say north pole at the surface of the object and return back along z-axis. Gravitational energy could also flow at origin to a second space-time sheet and return back at the surface of the star.

The (gravitational) mass function of the solution is given by the expression

$$M(r) = \frac{\lambda}{16\pi G} \frac{(A-1)}{AB} \sqrt{AB} r . \quad (6.4.8)$$

Mass is positive for Minkowskian metric with $B > 0$ and Euclidian metric but negative for the interior black hole metric ($A < 0, B < 0$). Mass is proportional to the radius of the star and in order to obtain an object with about Schwartzchild radius one must assume that the parameter k is of the order of $1/R$.

Concerning the physical interpretation of the $\Theta = \pi/2$ solution following remarks are in order:

- (a) Various gauge fields vanish since CP_2 projection is actually a geodesic circle. The interpretation is that various gauge charges vanish. Note that one-dimensional CP_2 projection conforms with the similar property of Robertson Walker cosmologies.
- (b) Both gravitational, color and weak forces vanish inside the star and the motion along radial geodesics takes place with constant velocity. This is consistent with the radial flow of gravitational energy.
- (c) Solution ansatz allows generalizations. For example, the following modification is stationary with respect to energy: $m^0 = \lambda t$, $\Phi = \omega_1 t + k_1 r$, $\Psi = \omega_2 t + k_2 r$, $u = \text{constant} < \infty$, $\Theta = \pi/2$. By choosing the values of the parameters suitably all the field equations are satisfied but stationarity is not achieved.
- (d) The solution should allow gluing to the Schwartzchild metric at $\Theta = \pi/2$. As found, for the imbedding of Schwartzchild metric the $\Theta = 0$ correspond to the Schwartzchild radius so that $\Theta = \pi/2$ would most naturally correspond to $r_M < r_S$. Since radial gauge fluxes are non-vanishing and finite at Schwartzchild radius, they must be non-vanishing $\Theta = \pi/2$ surface too, so that the star would carry surface charges and behave somewhat like a conducting sphere.

6.4.2 Dynamo model

The previous considerations have shown that the spherically symmetric solution is probably not physically realistic as such and it seems also clear that spherical symmetry must be given up and be replaced with a symmetry with respect to rotations around z-axis in order to obtain more realistic solutions. Since realistic stars rotate and have strong magnetic fields it is natural to ask whether rotation and magnetic fields might provide remedy for the pathological features of the solution. The rotation of the gauge charged matter (in "gravitational" sense) indeed creates classical gauge magnetic fields, which become very strong near the surface of the star, where the condition $\Theta \simeq \pi/2$ holds. If matter is approximately gauge neutral in the interior, the gauge fields should vanish to a very good approximation in the interior and the previous solution should be a good approximation to the actual situation. The rotating star could therefore be regarded as a rotating electro-weak conductor. Both Z^0 and em fields are present for a vanishing Kähler field and the ratio of field strengths is $\gamma/Z^0 = -\sin^2(\theta_W)/2 \simeq -1/8$ (see Appendix) so that Z^0 field dominates.

The generation of strong em and Z^0 electric and magnetic fields suggests a mechanism guaranteeing the stability of the solution: star behaves like a dynamo. For solutions with a 2-dimensional CP_2 projection em and Z^0 electric and magnetic fields are automatically orthogonal. For $\Theta \simeq \pi/2$ they are very strong and dominate over gravitation and centrifugal force. Therefore the stability of the surface region naturally results from the cancelation of the electric and magnetic em and Z^0 forces ($\vec{E} + \vec{v} \times \vec{B} = 0$), which takes place, when the velocity field of the matter is suitably chosen. This condition is completely analogous to the vanishing of Kähler Lorentz 4-force which seems to be a general property of the solutions of field equations [K11] and there are reasons to hope non-vacuum extremals describing rotating star can be found.

Conditions for the vanishing of the induced Kähler field

Although the situation becomes too complicated in order to allow the finding of exact solutions describing rotating star, one can identify some general properties of the solution ansatz describing the rotating configuration with Kähler electric and magnetic fields. In order to study the general properties of the solution ansatz in its most general form the explicit expressions for the line element and Kähler form of CP_2 given by the expression

$$\begin{aligned} ds^2 &= \frac{dr^2}{F^2} + \frac{r^2}{4F^2}(d\Psi + \cos(\Theta)d\Phi)^2 + \frac{r^2}{4F}(d\Theta^2 + \sin^2(\Theta)d\Phi^2) , \\ J &= \frac{r}{2F^2}dr \wedge (d\Psi + \cos(\Theta)d\Phi) + \frac{r^2}{2F}\sin\Theta d\Theta \wedge d\Phi , \\ F &= 1 + r^2 , \end{aligned} \tag{6.4.9}$$

0

are needed.

The vanishing of Kähler field is can be guaranteed by the conditions (not the most general ones, symplectic transformations generate new solutions)

$$\begin{aligned} \Phi &= q\Psi , \\ \frac{dr}{d\theta} &= -qrF \frac{\sin(\theta)}{1 + q\cos(\theta)} . \end{aligned} \tag{6.4.10}$$

Note that this ansatz excludes the case $q\cos(\Theta) = -1$ for which only W^\pm fields are non-vanishing. For this ansatz the expressions for em and Z^0 fields (see Appendix for general formulas) are

$$\begin{aligned}
\gamma &= -\sin^2(\Theta_W)R_{03} \quad , \quad Z^0 = 2R_{03} \quad , \\
R_{03} &= -qr^2F\sin(\theta)d\Theta \wedge d\Psi \quad .
\end{aligned}
\tag{6.4.11}$$

Here R_{03} denotes a component of spinor curvature.

Topological quantum numbers

The crucial point is that the expansions for the angle coordinates Φ and Ψ using spherical coordinates contain linear terms in t , r and ϕ

$$\begin{aligned}
\Phi &= n_1\phi + \omega_1t + k_1 \quad , \\
\Psi &= n_2\phi + \omega_2t + k_2 \quad .
\end{aligned}
\tag{6.4.12}$$

The functions k_1 and k_2 corresponds to Fourier expansion in terms of the plane waves $\exp(in\phi)$ with coefficients depending on the coordinates (t, r, θ) .

The terms depending linearly on ϕ imply a nontrivial topological structure for the gauge fields not present for the ordinary Maxwell fields. What happens is that space-time divides into regions, which correspond to different values of the topological quantum numbers (n_1, n_2) . In the boundaries of these regions the values of the coordinates u and Θ must be such that different values of Φ and Ψ correspond to same point of CP_2 . From the expression of the line element one finds that for Ψ the point $u = 0$ and the sphere $u = \infty$ corresponds to these kinds of points. For Φ the surfaces $u = 0$ and $u = \infty$, $\Theta = 0$ correspond to these kinds of surfaces. The form of Φ and Ψ implies that both electric and magnetic gauge fields are nontrivial and rather closely related as is clear from the expression for the Kähler form. Therefore the non-triviality of the winding numbers n_1 and n_2 is what seems to be the crucial, purely TGD based feature of rotating gauge field structures.

Stationary, axially symmetric ansatz with a non-vanishing Kähler field

To make the discussion more concrete, let us assume that the induced metric is invariant with respect to rotations around z-axis and time translations. This is achieved if CP_2 coordinates (apart from linear dependence on ϕ) depend on the coordinates r_M and θ only.

$$\begin{aligned}
r &= r(r_M, \theta) \\
\Theta &= \Theta(r_M, \theta) \quad , \\
k_i &= k_i(r_M, \theta) \quad , \quad i = 1, 2 \quad .
\end{aligned}
\tag{6.4.13}$$

This kind of ansatz is clearly consistent: field equations reduce to four equations since second fundamental form is orthogonal to the four-surface and there are four free functions of r and θ : one has effectively two dimensional field theory. Since the general solution ansatz for field equations relies on the vanishing of the Lorentz Kähler force central for the dynamo mechanism, it is of interest to study the general properties of the solution ansatz with a non-vanishing Kähler field. This ansatz can give as special cases space-time sheets carrying Z^0 and em fields with magnetic fields having different rotation axis.

In order to further simplify the discussion let us assume that X^4 corresponds to a sub-manifold of $M^4 \times S^2_J$. For instance, the ansatz

$$\begin{aligned}
r &= \infty , \\
\Theta &= \Theta(r_M, \theta) , \\
\Phi &= n\phi + \omega t + k(r_M, \theta) .
\end{aligned} \tag{6.4.14}$$

is consistent with this assumption. A simpler ansatz is obtained by assuming $k(r_M, \theta) = 0$. This ansatz has the following properties.

- (a) Induced Kähler (and Z^0 -) electric and magnetic fields are automatically orthogonal since CP_2 projection is two-dimensional. In fact, the orthogonality holds to an excellent approximation also for the values of u different but near to $u = \infty$ since the resulting additional components of the Kähler field are extremely small. Kähler electric and magnetic fields are given by

$$\begin{aligned}
E_{r_M} &= J_{r_M t} = -\partial_{r_M} \cos(\Theta) \omega / 2 , \\
E_\theta &= -\partial_\theta \cos(\Theta) \omega / 2 , \\
B_\theta &= -\partial_{r_M} \cos(\Theta) n / 2 , \\
B_{r_M} &= -\partial_\theta \cos(\Theta) n / 2 .
\end{aligned} \tag{6.4.15}$$

The field strengths are related by

$$\begin{aligned}
E &= vB , \\
v &= \frac{\omega}{n} \sqrt{-\frac{g_{\phi\phi}}{g_{tt}}} \simeq \frac{\omega}{n} \rho ,
\end{aligned} \tag{6.4.16}$$

where ρ denotes radial distance from the rotation axis. v can be interpreted as a velocity type parameter. The requirement that $v < 1$ gives a lower bound for the value of n : $n > \omega r_0$, where r_0 denotes the radius of the star: the condition implies that n must be larger than the mass of the star using Planck mass as unit. Somewhat counter intuitively, small rotation velocities seem to correspond to large values of n .

- (b) Kähler electric and magnetic fields indeed provide a possible mechanism guaranteing the stability of the star at the surface, where Z^0 forces dominate over gravitation and centrifugal force. Star behaves like a dynamo: matter rotates with a velocity guaranteing the vanishing of the Z^0 force. It should be noticed that no upper bound for the rotation velocity except that resulting from causality is obtained ($\Omega < 1/r_0$). Therefore this mechanism might explain the observed very large rotation velocities (for instance in Super Nova SN1987A), which are hard to understand in GRT based models [E182] .
- (c) The ansatz indeed describes a rotating object. First, the dynamo mechanism for the stability necessitates the presence of rotation and determines rotation velocity also. Secondly, the presence of Kähler magnetic field can be understood as being created by the rotation of gauge charges. Thirdly, the $g_{t\phi}$ component of the induced metric and therefore the angular momentum density $J_z^t \propto G^{t\phi} r^2 \sin^2 \theta$ is non-vanishing. A rough order of magnitude estimate for the angular momentum gives $J \simeq M \sqrt{G} n$. In order to obtain angular momentum of order $MR \simeq GM^2$ the order of magnitude for the parameter n must be $n \simeq M \sqrt{G}$ or the mass of the star using Planck mass as unit or: notice that also the Kähler charge of the star is of the same order of magnitude.
- (d) The gluing of the solution to Schwarzschild solution realized as a vacuum extremal is possible at a surface $\Theta = 0$, which corresponds to Schwarzschild radius, since at this surface different values of Φ correspond to same point of CP_2 . The gluing condition gives additional constraint $u = \infty$ at $r_M = r_S$.

- (e) The experience with the radially symmetric solution ansatz suggests that Θ is very nearly constant $\Theta \simeq \pi/2$ in the interior and varies considerably only at the surface of the star where Θ must go to zero in order to allow gluing to Schwarzschild metric at $r = r_S$. A possible picture is therefore the following. On z -axis there is a Z^0 charged vortex creating radial Z^0 electric field and Z^0 magnetic field in the direction of the vortex. In order to obtain cyclic energy flow matter velocity near the surface of the star must have besides the rotational component a component in θ direction (Z^0 force vanishes in this direction).
- (f) An interesting possibility is that the vortex actually corresponds to a Kähler charged cosmic string which has gradually lost its enormous inertial mass by a generating pairs of positive and negative energy particles, such that positive energy particles have left the string and participated in the formation of the star. The weakening of the magnetic field would have forced a gradual thickening of the cosmic string to an ordinary magnetic flux tube. This 'stars as pearls in necklace' picture would be consistent with the idea that cosmic strings serve as seeds of galaxy and star formation. Both negative and positive energy strings should be present in order to guarantee vanishing of net inertial energy and one can wonder whether the axis of Z^0 and em magnetic fields correspond to these two kinds of strings.

Does Sun have a solid surface?

The model for the asymptotic state of star predicts that mass at given space-time sheet is concentrated in a spherical shell so that star would have a multi-sheeted onion-like structure. This brings in mind the model for the formation of planetary systems in which spherical layers of quantum coherent dark matter serve as templates for the formation of visible matter which eventually condensed to planets [K72, K25]. It would not be surprising if also younger stars and also planets would possess similar structure. This picture is in conflict with the simplest model of Sun as a gas sphere.

Recently new satellites have begun to provide information about what lurks beneath the photosphere. The pictures produced by Lockheed Martin's Trace Satellite and YOHKOH, TRACE and SOHO satellite programs are publicly available in the web. SERTS program for the spectral analysis suggest a new picture challenging the simple gas sphere picture [E168]. The visual inspection of the pictures combined with spectral analysis has led Michael Moshina to suggest that Sun has a solid, conductive spherical surface layer consisting of calcium ferrite. The article of [E168] [E168] provides impressive pictures, which in my humble non-specialist opinion support this view. Of course, I have not worked personally with the analysis of these pictures so that I do not have the competence to decide how compelling the conclusions of Moshina are. In any case, I think that his web article [E168] deserves a summary.

Before SERTS people were familiar with hydrogen, helium, and calcium emissions from Sun. The careful analysis of SERTS spectrum however suggest the presence of a layer or layers containing ferrite and other heavy metals. Besides ferrite SERTS found silicon, magnesium, manganese, chromium, aluminum, and neon in solar emissions. Also elevated levels of sulphur and nickel were observed during more active cycles of Sun. In the gas sphere model these elements are expected to be present only in minor amounts. As many as 57 different types of emissions from 10 different kinds of elements had to be considered to construct a picture about the surface of the Sun.

Moshina has visually analyzed the pictures constructed from the surface of Sun using light at wave lengths corresponding to three lines of ferrite ions (171, 195, 284 Angstroms). On basis of his analysis he concludes that the spectrum originates from rigid and fixed surface structures, which can survive for days. A further analysis shows that these rigid structure rotate uniformly.

The existence of rigid structures idealizable as spherical shells in the first approximation would conform with the model for the final state of star extrapolated to a qualitative picture about the structure younger stars.

6.4.3 Z^0 force and dynamics of compact objects

The fact that long ranged color fields and weak fields, in particular Z^0 electric fields, could become strong under certain conditions and in fact dominate over gravitation might have interesting consequences in the physics of compact objects. Besides the dynamo mechanism guaranteeing the stability of the compact object the following ideas come immediately into mind.

- (a) In GRT based models Super Nova explosion is explained in terms of the pressure of the collapsed matter. Numerical simulations however fail to produce the explosion [E182] and it might even be that GRT based models in fact predict the collapse to black hole. Z^0 and em electric fields created by dark matter plus the existence of particles with Z^0 charge, which are suggested by TGD based model of nucleus and condensed matter to be present already in ordinary condensed matter, might provide a natural mechanism preventing the formation of the black hole (also excluded by the failure of complete imbeddability). When matter collapses to a sufficiently small volume the value of Θ approaches $\pi/2$ in the surface region and very strong repulsive radial Z^0 force is generated and could indeed lead to the explosion. Very light exotic variants of Higgs bosons identified as wormhole contacts having lefthanded weak charge provides a possible mechanism generating Z^0 charge.
- (b) The strong Z^0 fields at the surface of the star might provide energy source and acceleration mechanism for very high energy cosmic rays and a mechanism producing very high energy X-rays. These rays would be dark matter particles but could transform to ordinary matter by the mechanism discussed in [K27, K25]. For instance, one can imagine the ejection of a particle beam from the surface of a compact object: particles in dark matter phase gain very high energies in the Z^0 electric field and emit brehmstrahlung in the direction of their motion: most intense emission appears in the region very near the surface of the star, where the Z^0 electric field is strongest. This kind of mechanism might provide alternative explanation for the pulsars. In standard explanations the emission takes place in the direction of the magnetic axis, which does not coincide with the rotation axis. In present case the emission point could be anywhere on the surface of the star and magnetic and rotation axes might well coincide as they do in the simplest model. What one has to do is to invent a mechanism creating the surface instability pushing the matter from the surface of the star to the Kähler electric field.
- (c) The topological character of the magnetic structures might have applications also in the physics of the ordinary stars. It is known that solar magnetic fields correspond to definite isolated structures [E98]. Since electromagnetic fields must be accompanied by Kähler fields it is tempting to assume that these structures indeed correspond to the structures predicted by TGD. At the surface of the Sun the value of Θ near $\pi/2$ are possible and therefore Z^0 force can be very strong inside the magnetic structures.

6.4.4 Correlation between gamma ray bursts and supernovae and dynamo model for the final state of the star

The correlation between gamma ray bursts and supernovae is certainly the cosmological discovery of the year 2003 [E177, E116].

- (a) The first indications for supernova gamma ray burst connection came 1998 when a supernova was seen few days after the gamma ray burst in the same region of sky. In this case the intensity of the burst was however by four orders of magnitude weaker than for the typical gamma ray bursts so that the idea about the correlation was not taken seriously. On 29 March, observers recorded a burst christened as GRB030329. On 6 April, theorists at the Technion Institute of Technology in Israel and CERN in Geneva predicted that there would be signs of a supernova in the visible light and infrared spectra on 8 April [E177]. On cue, two days later, observers picked up the telltale spectrum of a type Ic supernova in the same region of sky, triggered as the collapsing star lost hydrogen from its surface. It has now become clear that a large class of gamma ray bursts correlate with supernovae of type Ib and Ic [E164], and that they could thus be powered by the mere core collapse

leading to supernova. Recall that supernovae of type II involve hydrogen lines unlike those of type I. Supernovae of type Ib shows Helium lines, and Ic shows neither hydrogen nor helium but intermediate mass elements instead. Supernovae of type Ib and Ic are thought to result as core collapse of massive stars.

- (b) One of the most enigmatic findings were the "mystery spots" accompanying supernova SN1987A at a distance of few light weeks at the symmetry axis at opposite sides of the supernova [E133]. Their luminosity was nearly 5 per cent of the maximal one. SN1987A was also accompanied by an expanding axi-symmetric remnant surrounded by three concentric rings.
- (c) The latest finding [E89] is that the radiation associated with the gamma ray bursts is maximally polarized. The polarization degree is the incredible 80 ± 20 per cent, which tells that it must be generated in an extremely strong magnetic field rather than in a simple explosion. The magnetic field must have a strong component parallel to the eye sight direction.

According to the updated model discussed in detail in [K24], cosmic strings transform in topological condensation to magnetic flux tubes about which they represent a limiting case. Primordial magnetic flux tubes forming ferro-magnet like structures become seeds for gravitational condensation leading to the formation of stars and galaxies. The TGD based model for the asymptotic state of a rotating star as dynamo leads to the identification of the predicted magnetic flux tube at the rotation axis of the star as Z^0 magnetic flux tube of primordial origin and assignable to dark matter. Besides Z^0 magnetic flux tube structure also magnetic flux tube structure exists at different space-time sheet but is in general not parallel to the Z^0 magnetic structure. This structure cannot have primordial origin (the magnetic field of star can even flip its polarity).

The flow of matter along Z^0 magnetic (rotation) axis generates synchrotron radiation, which escapes as a precisely targeted beam along magnetic axis and leaves the star. The identification is as the rotating light beam associated with ordinary neutron stars. During the core collapse leading to the supernova this beam becomes gamma ray burst. The mechanism is very much analogous to the squeezing of the tooth paste from the tube.

TGD based models of nuclei [K77] and condensed matter [K27] suggests that the nuclei of dense condensed matter develop anomalous color and weak charges coupling to dark weak bosons having Compton length L_w of order atomic size. Also lighter copies of weak bosons can be important in living matter. This weak charge is vacuum screened above L_w and by dark particles below it. Dark neutrinos, which according to TGD based explanation of tritium beta decay anomaly [K77] should have the same mass scale as ordinary neutrinos, are good candidates for screening dark particles. The Z^0 charge unbalance caused by the ejection of screening dark neutrinos hinders the gravitational collapse. The strong radial compression amplifies the tooth paste effect in this kind of situation so that there are hopes to understand the observed incredibly high polarization of 80 ± 20 per cent [E89].

6.4.5 Z^0 force and Super Nova explosion

The mechanism behind Super Nova explosion is not completely understood. The general picture is roughly the following.

- (a) The formation of iron means the end of the nuclear processes. The inner parts of the star contract and the degeneracy pressure of the non-relativistic electrons ($E_F \propto \rho^{2/3}$) increases and compensates the gravitational force. The equilibrium state is not stable. When the mass of the iron core approaches Chandrasekhar mass $1.4M_{Sun}$ electrons become relativistic. The milder dependence of the electron Fermi energy on density $E_F \propto \rho^{1/3}$ at the relativistic limit leads to the loss of stability. The high Fermi energy of the electrons allows also the reactions $p + e^- \rightarrow n + \nu_e$ implying decrease of the electronic pressure and neutronization of nuclear matter in the core. Gravitational collapse starts.
- (b) Collapse stops, when the density of the core reaches the density of the nuclear matter. The degeneracy pressure of the neutrons stops contraction, a shock wave is created and the

shock wave and neutrino radiation blow the outer regions of the star away so that Super Nova explosion results.

The problem of this scenario is that numerical simulations do not lead to a strong enough Super Nova explosion and the star tends to collapse into a black hole. A repulsive long ranged Z^0 force predicted by TGD based model of atomic nuclei [K77] generating an additional pressure provides a possible mechanism hindering the collapse and leading to the explosion.

- (a) The TGD based model for nuclei [K77] and condensed matter [K27] suggests that the nuclei of dense condensed matter develop anomalous color and weak charges coupling to dark weak bosons having Compton length L_w of order atomic size. Weak charge is due to the charged color bonds between nucleons: for instance, tetra-neutron can be understood as an alpha particle containing two negatively charged color bonds [K77]. This weak charge is vacuum screened above L_w and by dark particles below it. The charged bonds could exist and also generated between nucleons of different nuclei during collapse.

Dark neutrinos, which according to the TGD based explanation of tritium beta decay anomaly [K77] should have the same mass scale as ordinary neutrinos, are good candidates for screening dark weak force partially below length scale L_w . In equilibrium color force compensates the partially screened Z^0 force in the bonds. For the ordinary condensed matter densities vacuum screening effectively eliminates the force between neighboring nuclei, and the force makes it visible only via low compressibility. The gravitational collapse could be hindered by the strong additional pressure created by the repulsive L_w -ranged weak interaction between nucleons becoming manifest in the resulting dense phase.

- (b) In the initial state Z^0 charge is screened by dark neutrinos below L_w so that the repulsive Z^0 force is weaker than gravitational force and attractive color force associated with the bonds. Neutronization reactions $p + e^- \rightarrow n + \nu_e$ trigger the collapse. During collapse density increases so that dark neutrinos are not able to screen the anomalous Z^0 charge density. The dark neutrino radiation escaping from the star can also reduce the Z^0 screening. The resulting repulsive weak force implies a rapid increase of pressure with increasing density and thus a very low compressibility as it is proposed to imply also in the case of ordinary condensed matter [K27]. The repulsive weak force thus stops the collapse to black-hole.
- (c) The study of the spherically symmetric star models as 4-surfaces imbedded in $M_+^4 \times CP_2$ shows that the extreme nonlinearity of Kähler action implies that Z^0 force dominates over gravitation near the surface of the star.

6.4.6 Microscopic description of black-holes in TGD Universe

In TGD framework the imbedding of the metric for the interior of Schwarzschild black-hole fails below some critical radius. This strongly suggests that only the exterior metric of black-hole makes sense in TGD framework and that TGD must provide a microscopic description of black-holes. Somewhat unexpectedly, I ended up with this description from a model of hadrons.

Super-symplectic algebra is a generalization of Kac-Moody algebra obtained by replacing the finite-dimensional group G with the group of symplectic transformations of $\delta M_+^4 \times CP_2$. This algebra defines the group of isometries for the "world of classical worlds" and together with the Kac-Moody algebra assignable to the deformations of light-like 3-surfaces representing orbits of 2-D partonic surfaces it defines the mathematical backbone of quantum TGD as almost topological QFT.

From the point of view of experimentalist the basic question is how these super-symplectic degrees of freedom reflect themselves in existing physics and the pleasant surprise was that super-symplectic bosons explain what might be called the missing hadronic mass and spin. The point is that quarks explain only about 170 MeV of proton mass. Also the spin puzzle of proton is known for years. Also precise mass formulas for hadrons emerge.

Super-symplectic degrees of freedom represent dark matter in electro-weak sense and highly entangled hadronic strings in Hagedorn temperature are very much analogous to black-holes. This indeed generalizes to a microscopic model for black-holes created when hadronic strings fuse together in high density.

Super-symplectic bosons

TGD predicts also exotic bosons which are analogous to fermion in the sense that they correspond to single wormhole throat associated with CP_2 type vacuum extremal whereas ordinary gauge bosons corresponds to a pair of wormhole contacts assignable to wormhole contact connecting positive and negative energy space-time sheets. These bosons have super-conformal partners with quantum numbers of right handed neutrino and thus having no electro-weak couplings. The bosons are created by the purely bosonic part of super-symplectic algebra [K20, K19], whose generators belong to the representations of the color group and 3-D rotation group but have vanishing electro-weak quantum numbers. Their spin is analogous to orbital angular momentum whereas the spin of ordinary gauge bosons reduces to fermionic spin. Recall that super-symplectic algebra is crucial for the construction of configuration space Kähler geometry. If one assumes that super-symplectic gluons suffer topological mixing identical with that suffered by say U type quarks, the conformal weights would be (5,6,58) for the three lowest generations. The application of super-symplectic bosons in TGD based model of hadron masses is discussed in [K56] and here only a brief summary is given.

As explained in [K56], the assignment of these bosons to hadronic space-time sheet is an attractive idea.

- (a) Quarks explain only a small fraction of the baryon mass and that there is an additional contribution which in a good approximation does not depend on baryon. This contribution should correspond to the non-perturbative aspects of QCD. A possible identification of this contribution is in terms of super-symplectic gluons. Baryonic space-time sheet with $k = 107$ would contain a many-particle state of super-symplectic gluons with net conformal weight of 16 units. This leads to a model of baryons masses in which masses are predicted with an accuracy better than 1 per cent.
- (b) Hadronic string model provides a phenomenological description of non-perturbative aspects of QCD and a connection with the hadronic string model indeed emerges. Hadronic string tension is predicted correctly from the additivity of mass squared for $J = 2$ bound states of super-symplectic quanta. If the topological mixing for super-symplectic bosons is equal to that for U type quarks then a 3-particle state formed by 2 super-symplectic quanta from the first generation and 1 quantum from the second generation would define baryonic ground state with 16 units of conformal weight. A very precise prediction for hadron masses results by assuming that the spin of hadron correlates with its super-symplectic particle content.
- (c) Also the baryonic spin puzzle caused by the fact that quarks give only a small contribution to the spin of baryons, could find a natural solution since these bosons could give to the spin of baryon an angular momentum like contribution having nothing to do with the angular momentum of quarks.
- (d) Super-symplectic bosons suggest a solution to several other anomalies related to hadron physics. The events observed for a couple of years ago in RHIC [C15] suggest a creation of a black-hole like state in the collision of heavy nuclei and inspire the notion of color glass condensate of gluons, whose natural identification in TGD framework would be in terms of a fusion of hadronic space-time sheets containing super-symplectic matter materialized also from the collision energy. In the collision, valence quarks connected together by color bonds to form separate units would evaporate from their hadronic space-time sheets in the collision, and would define TGD counterpart of Pomeron, which experienced a reincarnation for few years ago [C22]. The strange features of the events related to the collisions of high energy cosmic rays with hadrons of atmosphere (the particles in question are hadron like but the penetration length is anomalously long and the rate for the production of hadrons increases as one approaches surface of Earth) could be also understood in terms of the same general mechanism.

Are ordinary black-holes replaced with super-symplectic black-holes in TGD Universe?

Some variants of super string model predict the production of small black-holes at LHC. I have never taken this idea seriously but in a well-defined sense TGD predicts black-hole like states associated with super-symplectic gravitons with strong gravitational constant defined by the hadronic string tension. The proposal is that super-symplectic black-holes have been already seen in Hera, RHIC, and the strange cosmic ray events.

Baryonic super-symplectic black-holes of the ordinary M_{107} hadron physics would have mass 934.2 MeV, very near to proton mass. The mass of their M_{89} counterparts would be 512 times higher, about 478 GeV. "Ionization energy" for Pomeron, the structure formed by valence quarks connected by color bonds separating from the space-time sheet of super-symplectic black-hole in the production process, corresponds to the total quark mass and is about 170 MeV for ordinary proton and 87 GeV for M_{89} proton. This kind of picture about black-hole formation expected to occur in LHC differs from the stringy picture since a fusion of the hadronic mini black-holes to a larger black-hole is in question.

An interesting question is whether the ultrahigh energy cosmic rays having energies larger than the GZK cut-off of 5×10^{10} GeV are baryons, which have lost their valence quarks in a collision with hadron and therefore have no interactions with the microwave background so that they are able to propagate through long distances.

In neutron stars the hadronic space-time sheets could form a gigantic super-symplectic black-hole and ordinary black-holes would be naturally replaced with super-symplectic black-holes in TGD framework (only a small part of black-hole interior metric is representable as an induced metric). This obviously means a profound difference between TGD and string models.

- (a) Hawking-Bekenstein black-hole entropy would be replaced with its p-adic counterpart given by

$$S_p = \left(\frac{M}{m(CP_2)}\right)^2 \times \log(p) , \quad (6.4.17)$$

where $m(CP_2)$ is CP_2 mass, which is roughly 10^{-4} times Planck mass. M is the contribution of p-adic thermodynamics to the mass. This contribution is extremely small for gauge bosons but for fermions and super-symplectic particles it gives the entire mass.

- (b) If p-adic length scale hypothesis $p \simeq 2^k$ holds true, one obtains

$$S_p = k \log(2) \times \left(\frac{M}{m(CP_2)}\right)^2, \quad (6.4.18)$$

$m(CP_2) = \hbar/R$, R the "radius" of CP_2 , corresponds to the standard value of \hbar_0 for all values of \hbar .

- (c) Hawking-Bekenstein area law gives in the case of Schwarzschild black-hole

$$S = \frac{A}{4G} \times \hbar = \pi GM^2 \times \hbar . \quad (6.4.19)$$

For the p-adic variant of the law Planck mass is replaced with CP_2 mass and $k \log(2) \simeq \log(p)$ appears as an additional factor. Area law is obtained in the case of elementary particles if k is prime and wormhole throats have M^4 radius given by p-adic length scale $L_k = \sqrt{k}R$ which is exponentially smaller than L_p . For macroscopic super-symplectic black-holes modified area law results if the radius of the large wormhole throat equals to Schwarzschild radius. Schwarzschild radius is indeed natural: a simple deformation of the Schwarzschild exterior metric to a metric representing rotating star transforms Schwarzschild horizon to a light-like 3-surface at which the signature of the induced metric is transformed from Minkowskian to Euclidian.

- (d) The formula for the gravitational Planck constant appearing in the Bohr quantization of planetary orbits and characterizing the gravitational field body mediating gravitational interaction between masses M and m [K72] reads as

$$\hbar_{gr} = \frac{GMm}{v_0} \hbar_0 .$$

$v_0 = 2^{-11}$ is the preferred value of v_0 . One could argue that the value of gravitational Planck constant is such that the Compton length \hbar_{gr}/M of the black-hole equals to its Schwarzschild radius. This would give

$$\hbar_{gr} = \frac{GM^2}{v_0} \hbar_0 , \quad v_0 = 1/2 . \quad (6.4.20)$$

The requirement that \hbar_{gr} is a ratio of ruler-and-compass integers expressible as a product of distinct Fermat primes (only four of them are known) and power of 2 would quantize the mass spectrum of black hole [K72]. Even without this constraint M^2 is integer valued using p-adic mass squared unit and if p-adic length scale hypothesis holds true this unit is in an excellent approximation power of two.

- (e) The gravitational collapse of a star would correspond to a process in which the initial value of v_0 , say $v_0 = 2^{-11}$, increases in a stepwise manner to some value $v_0 \leq 1/2$. For a supernova with solar mass with radius of 9 km the final value of v_0 would be $v_0 = 1/6$. The star could have an onion like structure with largest values of v_0 at the core as suggested by the model of planetary system. Powers of two would be favored values of v_0 . If the formula holds true also for Sun one obtains $1/v_0 = 3 \times 17 \times 2^{13}$ with 10 per cent error.
- (f) Black-hole evaporation could be seen as means for the super-symplectic black-hole to get rid of its electro-weak charges and fermion numbers (except right handed neutrino number) as the antiparticles of the emitted particles annihilate with the particles inside super-symplectic black-hole. This kind of minimally interacting state is a natural final state of star. Ideal super-symplectic black-hole would have only angular momentum and right handed neutrino number.
- (g) In TGD light-like partonic 3-surfaces are the fundamental objects and space-time interior defines only the classical correlates of quantum physics. The space-time sheet containing the highly entangled cosmic string might be separated from environment by a wormhole contact with size of black-hole horizon.

This looks the most plausible option but one can of course ask whether the large partonic 3-surface defining the horizon of the black-hole actually contains all super-symplectic particles so that super-symplectic black-hole would be single gigantic super-symplectic parton. The interior of super-symplectic black-hole would be a space-like region of space-time, perhaps resulting as a large deformation of CP_2 type vacuum extremal. Black-hole sized wormhole contact would define a gauge boson like variant of the black-hole connecting two space-time sheets and getting its mass through Higgs mechanism. A good guess is that these states are extremely light.

Anyonic view about blackholes

A new element to the model of black hole comes from the vision that black hole horizon as a light-like 3-surface corresponds to a light-like orbit of light-like partonic 2-surface. This allows two kinds of black holes. Fermion like black hole would correspond to a deformed CP_2 type extremal which Euclidian signature of metric and topologically condensed at a space-time sheet with a Minkowskian signature. Boson like black hole would correspond to a wormhole contact connecting two space-time sheets with Minkowskian signature. Wormhole contact would be a piece deformed CP_2 type extremal possessing two light-like throats defining two black hole horizons very near to each other. It does not seem absolutely necessary to assume that the interior metric of the black-hole is realized in another space-time sheet with Minkowskian signature.

Second new element relates to the value of Planck constant. For $\hbar_{gr} = 4GM^2$ the Planck length $L_P(\hbar) = \sqrt{\hbar/G}$ equals to Schwarzschild radius and Planck mass equals to $M_P(\hbar) = \sqrt{\hbar/G} = 2M$. If the mass of the system is below the ordinary Planck mass: $M \leq m_P(\hbar_0)/2 = \sqrt{\hbar_0/4G}$, gravitational Planck constant is smaller than the ordinary Planck constant.

Black hole surface contains ultra dense matter so that perturbation theory is not expected to converge for the standard value of Planck constant but do so for gravitational Planck constant. If the phase transition increasing Planck constant is a friendly gesture of Nature making perturbation theory convergent, one expects that only the black holes for which Planck constant is such that $GM^2/4\pi\hbar < 1$ holds true are formed. Black hole entropy -being proportional to $1/\hbar$ - is of order unity so that TGD black holes are not very entropic. $\hbar = GM^2/v_0$, $v_0 = 1/4$, would hold true for an ideal black hole with Planck length $(\hbar G)^{1/2}$ equal to Schwarzschild radius $2GM$. Since black hole entropy is inversely proportional to \hbar , this would predict black hole entropy to be of order single bit. This of course looks totally non-sensible if one believes in standard thermodynamics. For the star with mass equal to 10^{40} Planck masses the entropy associated with the initial state of the star would be roughly the number of atoms in star equal to about 10^{60} . Black hole entropy proportional to GM^2/\hbar would be of order 10^{80} provided the standard value of \hbar is used as unit. This stimulates some questions.

- (a) Does second law pose an upper bound on the value of \hbar of dark black hole from the requirement that black hole has at least the entropy of the initial state. The maximum value of \hbar would be given by the ratio of black hole entropy to the entropy of the initial state and about 10^{20} in the example consider to be compared with $GM^2/v_0 \sim 10^{80}$.
- (b) Or should one generalize thermodynamics in a manner suggested by zero energy ontology by making explicit distinction between subjective time (sequence of quantum jumps) and geometric time? The arrow of geometric time would correlate with that of subjective time. One can argue that the geometric time has opposite direction for the positive and negative energy parts of the zero energy state interpreted in standard ontology as initial and final states of quantum event. If second law would hold true with respect to subjective time, the formation of ideal dark black hole would destroy entropy only from the point of view of observer with standard arrow of geometric time. The behavior of phase conjugate laser light would be a more mundane example. Do self assembly processes serve as example of non-standard arrow of geometric time in biological systems? In fact, zero energy state is geometrically analogous to a big bang followed by big crunch. One can however criticize the basic assumption as ad hoc guess. One should really understand the the arrow of geometric time. This is discussed in detail in [L3] .

If the partonic 2-surface surrounds the tip of causal diamond CD , the matter at its surface is in anyonic state with fractional charges. Anyonic black hole can be seen as single gigantic elementary particle stabilized by fractional quantum numbers of the constituents preventing them from escaping from the system and transforming to ordinary visible matter. A huge number of different black holes are possible for given value of \hbar since there is infinite variety of pairs (n_a, n_b) of integers giving rise to same value of \hbar .

One can imagine that the partonic surface is not exact sphere except for ideal black holes but contains large number of magnetic flux tubes giving rise to handles. Also a pair of spheres with different radii can be considered with surfaces of spheres connected by braided flux tubes. The braiding of these handles can represent information and one can even consider the possibility that black hole can act as a topological quantum computer. There would be no sharp difference between the dark parts of black holes and those of ordinary stars. Only the volume containing the complex flux tube structures associated with the orbits of planets and various objects around star would become very small for black hole so that the black hole might code for the topological information of the matter collapsed into it.

6.5 TGD based model for cosmic strings

The model for cosmic strings has forced to question all cherished assumptions including positive energy ontology, Equivalence Principle, and positivity of gravitational energy.

6.5.1 Zero energy ontology and cosmic strings

There are two kinds of cosmic strings: free and topological condensed ones.

- (a) Free cosmic strings are not absolute minima of the Kähler action (the action has wrong sign). P^3 would favor cosmic strings and also their electric duals if they exist. Since the magnetic field of cosmic string corresponds to CP_2 degrees of freedom with Euclidian signature electric duals do not probably exist.
- (b) In long enough length and time scales Kähler action per volume must vanish so that the idealization of cosmology as a vacuum extremal becomes possible and there must be some mechanism compensating the positive action of the free cosmic strings. The mechanism need not be local.

The most convincing cancellation mechanism relies on zero energy ontology. If the sign of the Kähler action depends on time orientation it would be opposite for positive and negative energy space-time sheets and the actions associated with them would cancel if the field configurations are identical. Hence zero energy states would naturally have small Kähler action. Obviously this mechanism is non-local.

In this framework zero energy states correspond to cosmologies leading from big bang to big crunch separated by some time interval T of geometric time. Quantum jumps can gradually increase the value T and TGD inspired theory of consciousness suggests that the increase of T might relate to the shift for the contents of conscious experience towards geometric future. In particular, what is usually regarded as cosmology could have started from zero energy state with a small value of T .

The earlier picture was based on dynamical cancellation mechanism involving generation of strong Kähler electric fields in the condensation whose action compensated for Kähler magnetic action.

6.5.2 Topological condensation of cosmic strings

1. Exterior metrics of topologically condensed $g > 1$ strings

If the sign of the gravitational string tension is negative the simple imbedding of the metric existing for positive string tension ceases to exist. There exists however a different imbedding for which angle excess is in a good approximation same as for the flat solution. The solution is not flat anymore and this implies outwards radial gravitational acceleration. The imbedding of the exterior metric also fails beyond a critical radius. This is not the only possible exterior metric: also non-flat exterior metric are possible and look actually more plausible and also this metric implies radial outwards acceleration as one might indeed expect. What remains to be shown that these metrics do not only yield small angle defect but are also consistent with Newtonian intuitions as the constant velocity spectrum for distant stars around galaxies suggests.

The natural interpretation would be as a mechanism generating large void around a central cosmic string having $g > 1$ and negative string tension and containing at its boundary $g = 1$ positive energy cosmic strings with string tension equal to Kähler string tension. Since angle surplus instead of angle deficit is predicted for $g > 1$ strings, lense effect transforms in this case to angle divergence and one avoids the basic objection against big cosmic strings. The emergence of preferred axes defined by $g > 1$ strings in the scale of large void could relate to the anomalies observed in Cosmic Microwave Background.

Negative gravitational energy of $g > 1$ cosmic strings could be regarded as that part of gravitational energy which causes the accelerated cosmic expansion by driving galactic strings to the boundaries of large voids which then induces phase transition increasing the size of the voids. This kind of acceleration is encountered already at the level of Newton's equations when some of the gravitational masses are negative.

2. Exterior metrics of topologically condensed $g = 1$ strings

One cannot assume that the exterior metric of the galactic $g = 1$ strings is the one predicted by assuming $G = 0$ in the exterior region. This would mean that metric decomposes as $g = g_2(X^2) + g_2(Y^2)$. $g(X^2)$ would be flat as also $g_2(Y^2)$ expect at the position of string. The resulting angle defect due to the replacement of plane Y^2 with cone would be large and give rise to lense effect of same magnitude as in the case of GUT cosmic strings. This lensing has not been observed.

The constant velocity spectrum for distant stars of galaxies and the fact that galaxies are organized along strings suggests that these string generate in a good approximation Newtonian potential. This potential predicts constant velocity spectrum with a correct value velocity.

In the stationary situation one expects that the exterior metric of galactic string corresponds to a small deformation of vacuum extremal of Kähler action which is also extremal of the curvature scalar in the induced metric. This allows a solution ansatz which conforms with Newtonian intuitions and for which metric decomposes as $g = g_1 + g_3$, where g_1 corresponds to axis in the direction of string and g_3 remaining 1 + 2 directions.

6.5.3 Dark energy is replaced with dark matter in TGD framework

The first thing that comes in mind is that negative gravitational energy could be the TGD counterpart for the positive dark vacuum energy known to dominate over the mass density in cosmological length scales and believed to cause the accelerated cosmic expansion. This argument is wrong.

- (a) The gigantic value of gravitational Planck constant implies that dark matter makes TGD Universe a macroscopic quantum system even in cosmological length scales. Astrophysical systems become stationary quantum systems which participate in cosmic expansion only via quantum phase transitions increasing the value of gravitational Planck constant. Critical cosmologies, which are determined apart from a single parameter in TGD Universe, are natural during all quantum phase transitions, in particular the phase transition periods increasing the size of large voids and having interpretation in terms of an increase of gravitational Planck constant. Cosmic expansion is predicted to be accelerating during these periods. The mere criticality requires that besides ordinary matter there is a contribution $\Omega_\Lambda \simeq .74$ to the mass density besides visible matter and dark matter.
- (b) The essential characteristic of dark energy is its negative pressure. Negative gravitational energy could effectively create this negative pressure during phase transitions increasing the size of large voids. Since negative gravitational mass would be basically responsible for the accelerated expansion, one can assume that dark energy is actually dark matter.
- (c) Note that the pressure is negative during critical period. This is however interpreted as a correlate for the expansion caused by the phase transition increasing Planck constant rather than being due to positive cosmological constant or quintessence with negative pressure.

6.5.4 The values for the TGD counterpart of cosmological constant

One can introduce a parameter characterizing the contribution of dark mass to the mass density during critical periods and call it cosmological constant recalling however that the contribution does not correspond to negative pressure now. The value of this parameter is same as in the standard cosmology from mere criticality assumption.

What is new that p-adic fractality predicts that Λ scales as $1/L^2(k)$ as a function of the p-adic scale characterizing the space-time sheet implying a series of phase transitions reducing Λ . The order of magnitude for the recent value of the cosmological constant comes out correctly. The gravitational energy density assignable to the cosmological constant is identifiable as that associated with topologically condensed cosmic strings and magnetic flux tubes to which they are gradually transformed during cosmological evolution.

The naive expectation would be the density of cosmic strings would behave as $1/a^2$ as function of M_+^4 proper time. The vision about dark matter as a phase characterized by gigantic Planck

constant however implies that large voids do not expand in continuous manner during cosmic evolution but in discrete quantum jumps increasing the value of the gravitational Planck constant and thus increasing the size of the large void as a quantum state. Since the set of preferred values of Planck constant is closed under multiplication by powers of 2, p-adic length scales L_p , $p \simeq 2^k$ form a preferred set of sizes scales for the large voids.

Classically one can understand the occurrence of the phase transitions increasing the size of the void as resulting when the galactic strings end up to the boundary of the large void in the repulsive gravitational field of the big string.

6.5.5 Matter-antimatter asymmetry and cosmic strings

Despite huge amount of work done during last decades (during the GUT era the problem was regarded as being solved!) matter-antimatter asymmetry remains still an unresolved problem of cosmology. A possible resolution of the problem is matter-antimatter asymmetry in the sense that cosmic strings contain antimatter and their exteriors matter. The challenge would be to understand the mechanism generating this asymmetry. The vanishing of net gauge charges of cosmic string allows this symmetry since electro-weak charges of quarks and leptons can cancel each other.

The challenge is to identify the mechanism inducing the CP breaking necessary for the matter-antimatter asymmetry. Quite a small CP breaking inside cosmic strings would be enough. The key observation is that vacuum extremals as such are not physically acceptable: small deformations of vacuum extremals to non-vacua are required. The simplest deformation of this kind would induce a radial Kähler electric field and thus a small Kähler electric charge inside cosmic string. This in turn would induce CP breaking inside cosmic string inducing matter antimatter asymmetry by the minimization of the ground state energy. Conservation of Kähler charge in turn would induce asymmetry outside cosmic string and the annihilation of matter and antimatter would then lead to a situation in which there is only matter.

This model is not the only one that one can imagine. Antimatter could reside also at other p-adic space-time sheets and at the dark space-time sheets with different values of Planck constant. Most importantly, a first principle justification for the needed CP breaking is lacking. This justification comes from the fundamental formulation of quantum TGD in terms of the modified Dirac action associated with Kähler action and its generalization allowing include instanton term as imaginary part of Kähler action [K19].

- (a) The key idea in the formulation of quantum TGD in terms of modified Dirac equation associated with Kähler action is that the Dirac determinant defined by the generalized eigenvalues assignable to the Dirac operator D_K equals to the vacuum functional defined as the exponent of Kähler function in turn identifiable as Kähler action for a preferred extremal for which the second variation of Kähler action vanishes at least for the variations responsible for dynamical symmetries. The interpretation is in terms of quantum criticality with the hierarchy of symmetries defining a hierarchy of criticalities analogous to the hierarchy defined by the rank of the matrix defined by the second derivatives of potential function in Thom's catastrophe theory.
- (b) This representation generalizes. One can add an imaginary instanton term to the Kähler function and corresponding modified Dirac operator D_K so that the generalized eigenvalues assignable to D_K (analogous to Higgs vacuum expectation) become complex. The natural conjecture is that the resulting Dirac determinant equals to the exponent of Kähler action and imaginary instanton term for the preferred extremal. The instanton term does not contribute to the configuration space metric but provides a first principle description for CP breaking and anyonic effects. It also predicts the dependence of these effects on the page of the book like structure defined by the generalized imbedding space realizing the dark matter hierarchy with levels labeled by the value of Planck constant.

6.6 Allais effect and TGD

Allais effect represents one of the anomalies associated with gravitational interaction discarded by the average theoretician. In TGD framework this effect can be interpreted as an interference effect made possible by the gigantic value of gravitational Planck constant. As an interference effect it is extremely sensitive to the parameters of the problem and this explains why the sign and size of the effects varies so much.

6.6.1 The effect

Allais effect [E5, E68] is a fascinating gravitational anomaly associated with solar eclipses. It was discovered originally by M. Allais, a Nobelist in the field of economy, and has been reproduced in several experiments but not as a rule. The experimental arrangement uses so called paraconical pendulum, which differs from the Foucault pendulum in that the oscillation plane of the pendulum can rotate in certain limits so that the motion occurs effectively at the surface of sphere.

Experimental findings

Consider first a brief summary of the findings of Allais and others [E68] .

- (a) In the ideal situation (that is in the absence of any other forces than gravitation of Earth) paraconical pendulum should behave like a Foucault pendulum. The oscillation plane of the paraconical pendulum however begins to rotate.
- (b) Allais concludes from his experimental studies that the orbital plane approach always asymptotically to a limiting plane and the effect is only particularly spectacular during the eclipse. During solar eclipse the limiting plane contains the line connecting Earth, Moon, and Sun. Allais explains this in terms of what he calls the anisotropy of space.
- (c) Some experiments carried out during eclipse have reproduced the findings of Allais, some experiments not. In the experiment carried out by Jeverdan and collaborators in Romania it was found that the period of oscillation of the pendulum decreases by $\Delta f/f \simeq 5 \times 10^{-4}$ [E5, E141] which happens to correspond to the constant $v_0 = 2^{-11}$ appearing in the formula of the gravitational Planck constant. It must be however emphasized that the overall magnitude of $\Delta f/f$ varies by five orders of magnitude. Even the sign of $\Delta f/f$ varies from experiment to experiment.
- (d) There is also quite recent finding by Popescu and Olenici, which they interpret as a quantization of the plane of oscillation of paraconical oscillator during solar eclipse [E189] . There is also evidence that the effect is present also before and after the full eclipse. The time scale is 1 hour.

TGD based models for Allais effect

I have already earlier proposed an explanation of the effect in terms of classical Z^0 force [K10] . If the Z^0 charge to mass ratio of pendulum varies and if Earth and Moon are Z^0 conductors, the resulting model is quite flexible and one might hope it could explain the high variation of the experimental results.

The rapid variation of the effect during the eclipse is however a problem for this approach and suggests that gravitational screening or some more general interference effect might be present. Gravitational screening alone cannot however explain Allais effect. Also the combination of gravitational screening and Z^0 force assuming Z^0 conducting structures causing screening fails to explain the discontinuous behavior when massive objects are collinear.

A model based on the idea that gravitational interaction is mediated by topological light rays (MEs) and that gravitons correspond to a gigantic value of the gravitational Planck constant however explains the Allais effect as an interference effect made possible by macroscopic quantum

coherence in astrophysical length scales. Equivalence Principle fixes the model to a high degree and one ends up with an explicit formula for the anomalous gravitational acceleration and the general order of magnitude and the large variation of the frequency change as being due to the variation of the distance ratio $r_{S,P}/r_{M,P}$ ($S, M,$ and P refer to Sun, Moon, and pendulum respectively). One can say that the pendulum acts as an interferometer.

6.6.2 Could gravitational screening explain Allais effect

The basic idea of the screening model is that Moon absorbs some fraction of the gravitational momentum flow of Sun and in this manner partially screens the gravitational force of Sun in a disk like region having the size of Moon's cross subsection. The screening is expected to be strongest in the center of the disk. Screening model happens to explain the findings of Jevardan but fails in the general case. Despite this screening model serves as a useful exercise.

Constant external force as the cause of the effect

The conclusions of Allais motivate the assumption that quite generally there can be additional constant forces affecting the motion of the paraconical pendulum besides Earth's gravitation. This means the replacement $\bar{g} \rightarrow \bar{g} + \Delta\bar{g}$ of the acceleration g due to Earth's gravitation. $\Delta\bar{g}$ can depend on time.

The system obeys still the same simple equations of motion as in the initial situation, the only change being that the direction and magnitude of effective Earth's acceleration have changed so that the definition of vertical is modified. If $\Delta\bar{g}$ is not parallel to the oscillation plane in the original situation, a torque is induced and the oscillation plane begins to rotate. This picture requires that the friction in the rotational degree of freedom is considerably stronger than in oscillatory degree of freedom: unfortunately I do not know what the situation is.

The behavior of the system in absence of friction can be deduced from the conservation laws of energy and angular momentum in the direction of $\bar{g} + \Delta\bar{g}$. The explicit formulas are given by

$$\begin{aligned} E &= \frac{ml^2}{2} \left(\frac{d\Theta}{dt} \right)^2 + \sin^2(\Theta) \left(\frac{d\Phi}{dt} \right)^2 + mgl \cos(\Theta) , \\ L_z &= ml^2 \sin^2(\Theta) \frac{d\Phi}{dt} . \end{aligned} \quad (6.6.1)$$

and allow to integrate Θ and Φ from given initial values.

What causes the effect in normal situations?

The gravitational accelerations caused by Sun and Moon come first in mind as causes of the effect. Equivalence Principle implies that only relative accelerations causing analogs of tidal forces can be in question. In GRT picture these accelerations correspond to a geodesic deviation between the surface of Earth and its center. The general form of the tidal acceleration would thus the difference of gravitational accelerations at these points:

$$\Delta\bar{g} = -2GM \left[\frac{\Delta\bar{r}}{r^3} - 3 \frac{\bar{r} \cdot \Delta\bar{r}}{r^5} \right] . \quad (6.6.2)$$

Here \bar{r} denotes the relative position of the pendulum with respect to Sun or Moon. $\Delta\bar{r}$ denotes the position vector of the pendulum measured with respect to the center of Earth defining the geodesic deviation. The contribution in the direction of $\Delta\bar{r}$ does not affect the direction of the Earth's acceleration and therefore does not contribute to the torque. Second contribution

corresponds to an acceleration in the direction of \bar{r} connecting the pendulum to Moon or Sun. The direction of this vector changes slowly.

This would suggest that in the normal situation the tidal effect of Moon causes gradually changing force $m\Delta\bar{g}$ creating a torque, which induces a rotation of the oscillation plane. Together with dissipation this leads to a situation in which the orbital plane contains the vector $\Delta\bar{g}$ so that no torque is experienced. The limiting oscillation plane should rotate with same period as Moon around Earth. Of course, if effect is due to some other force than gravitational forces of Sun and Earth, paraconical oscillator would provide a manner to make this force visible and quantify its effects.

What would happen during the solar eclipse?

During the solar eclipse something exceptional must happen in order to account for the size of effect. The finding of Allais that the limiting oscillation plane contains the line connecting Earth, Moon, and Sun implies that the anomalous acceleration $\Delta|g$ should be parallel to this line during the solar eclipse.

The simplest hypothesis is based on TGD based view about gravitational force as a flow of gravitational momentum in the radial direction.

- (a) For stationary states the field equations of TGD for vacuum extremals state that the gravitational momentum flow of this momentum. Newton's equations suggest that planets and moon absorb a fraction of gravitational momentum flow meeting them. The view that gravitation is mediated by gravitons which correspond to enormous values of gravitational Planck constant in turn supports Feynman diagrammatic view in which description as momentum exchange makes sense and is consistent with the idea about absorption. If Moon absorbs part of this momentum, the region of Earth screened by Moon receives reduced amount of gravitational momentum and the gravitational force of Sun on pendulum is reduced in the shadow.
- (b) Unless the Moon as a coherent whole acts as the absorber of gravitational four momentum, one expects that the screening depends on the distance travelled by the gravitational flux inside Moon. Hence the effect should be strongest in the center of the shadow and weaken as one approaches its boundaries.
- (c) The opening angle for the shadow cone is given in a good approximation by $\Delta\Theta = R_M/R_E$. Since the distances of Moon and Earth from Sun differ so little, the size of the screened region has same size as Moon. This corresponds roughly to a disk with radius $.27 \times R_E$. The corresponding area is 7.3 per cent of total transverse area of Earth. If total absorption occurs in the entire area the total radial gravitational momentum received by Earth is in good approximation 92.7 per cent of normal during the eclipse and the natural question is whether this effective repulsive radial force increases the orbital radius of Earth during the eclipse.

More precisely, the deviation of the total amount of gravitational momentum absorbed during solar eclipse from its standard value is an integral of the flux of momentum over time:

$$\begin{aligned} \Delta P_{gr}^k &= \int \frac{\Delta P_{gr}^k}{dt}(S(t))dt \ , \\ \frac{\Delta P_{gr}^k}{dt}(S(t)) &= \int_{S(t)} J_{gr}^k(t)dS \ . \end{aligned} \quad (6.6.3)$$

This prediction could kill the model in classical form at least. If one takes seriously the quantum model for astrophysical systems predicting that planetary orbits correspond to Bohr orbits with gravitational Planck constant equal to GMm/v_0 , $v_0 = 2^{-11}$, there should be not effect on the orbital radius. The anomalous radial gravitational four-momentum could go to some other degrees of freedom at the surface of Earth.

- (d) The rotation of the oscillation plane is largest if the plane of oscillation in the initial situation is as orthogonal as possible to the line connecting Moon, Earth and Sun. The effect vanishes when this line is in the the initial plane of oscillation. This testable prediction might explain why some experiments have failed to reproduce the effect.
- (e) The change of $|\bar{g}|$ to $|\bar{g} + \Delta\bar{g}|$ induces a change of oscillation frequency given by

$$\frac{\Delta f}{f} = \frac{\bar{g} \cdot \Delta\bar{g}}{g^2} = \frac{\Delta g}{g} \cos(\theta) . \quad (6.6.4)$$

If the gravitational force of the Sun is screened, one has $|\bar{g} + \Delta\bar{g}| > g$ and the oscillation frequency should increase. The upper bound for the effect corresponds to vertical direction is obtained from the gravitational acceleration of Sun at the surface of Earth:

$$\frac{|\Delta f|}{f} \leq \frac{\Delta g}{g} = \frac{v_E^2}{r_E} \simeq 6.0 \times 10^{-4} . \quad (6.6.5)$$

What kind of tidal effects are predicted?

If the model applies also in the case of Earth itself, new kind of tidal effects are predicted due to the screening of the gravitational effects of Sun and Moon inside Earth. At the night-side the paraconical pendulum should experience the gravitation of Sun as screened. Same would apply to the "night-side" of Earth with respect to Moon.

Consider first the differences of accelerations in the direction of the line connecting Earth to Sun/Moon: these effects are not essential for tidal effects. The estimate for the ratio for the orders of magnitudes of the these accelerations is given by

$$\frac{|\Delta\bar{g}_\perp(Moon)|}{|\Delta\bar{g}_\perp(Sun)|} = \frac{M_S}{M_M} \left(\frac{r_M}{r_E}\right)^3 \simeq 2.17 . \quad (6.6.6)$$

The order or magnitude follows from $r(Moon) = .0026$ AU and $M_M/M_S = 3.7 \times 10^{-8}$. These effects are of same order of magnitude and can be compensated by a variation of the pressure gradients of atmosphere and sea water. The effects caused by Sun are two times stronger. These effects are of same order of magnitude and can be compensated by a variation of the pressure gradients of atmosphere and sea water.

The tangential accelerations are essential for tidal effects. They decompose as

$$\frac{1}{r^3} \left[\Delta\bar{r} - 3|\Delta\bar{r}| \cos(\Theta) \frac{\bar{r}}{r} \right] .$$

$\pi/4 \leq \Theta \leq \pi/2$ is the angle between $\Delta\bar{r}$ and \bar{r} . The above estimate for the ratio of the contributions of Sun and Moon holds true also now and the tidal effects caused by Sun are stronger by a factor of two.

Consider now the new tidal effects caused by the screening.

- (a) Tangential effects on day-side of Earth are not affected (night-time and night-side are of course different notions in the case of Moon and Sun). At the night-side screening is predicted to reduce tidal effects with a maximum reduction at the equator.
- (b) Second class of new effects relate to the change of the normal component of the forces and these effects would be compensated by pressure changes corresponding to the change of the effective gravitational acceleration. The night-day variation of the atmospheric and sea pressures would be considerably larger than in Newtonian model.

The intuitive expectation is that the screening is maximum when the gravitational momentum flux travels longest path in the Earth's interior. The maximal difference of radial accelerations associated with opposite sides of Earth along the line of sight to Moon/Sun provides a convenient manner to distinguish between Newtonian and TGD based models:

$$\begin{aligned} |\Delta\bar{g}_{\perp,N}| &= 4GM \times \frac{R_E}{r^3} , \\ |\Delta\bar{g}_{\perp,TGD}| &= 4GM \times \frac{1}{r^2} . \end{aligned} \quad (6.6.7)$$

The ratio of the effects predicted by TGD and Newtonian models would be

$$\begin{aligned} \frac{|\Delta\bar{g}_{\perp,TGD}|}{|\Delta\bar{g}_{\perp,N}|} &= \frac{r}{R_E} , \\ \frac{r_M}{R_E} &= 60.2 , \quad \frac{r_S}{R_E} = 2.34 \times 10^4 . \end{aligned} \quad (6.6.8)$$

The amplitude for the oscillatory variation of the pressure gradient caused by Sun would be

$$\Delta|\nabla p_S| = \frac{v_E^2}{r_E} \simeq 6.1 \times 10^{-4}g$$

and the pressure gradient would be reduced during night-time. The corresponding amplitude in the case of Moon is given by

$$\frac{\Delta|\nabla p_s|}{\Delta|\nabla p_M|} = \frac{M_S}{M_M} \times \left(\frac{r_M}{r_S}\right)^3 \simeq 2.17 .$$

$\Delta|\nabla p_M|$ is in a good approximation smaller by a factor of 1/2 and given by $\Delta|\nabla p_M| = 2.8 \times 10^{-4}g$. Thus the contributions are of same order of magnitude.

M_M/M_S	M_E/M_S	R_M/R_E	d_{E-S}/AU	d_{E-M}/AU
3.0×10^{-6}	3.69×10^{-8}	.273	1	.00257
R_E/d_{E-S}	R_E/d_{E-M}	g_S/g	g_M/g	
4.27×10^{-5}	01.7×10^{-7}	6.1×10^{-4}	2.8×10^{-4}	

Table 1. The table gives basic data relevant for tidal effects. The subscript E, S, M refers to Earth, Sun, Moon; R refers to radius; d_{X-Y} refers to the distance between X and Y g_S and g_M refer to accelerations induced by Sun and Moon at Earth surface. $g = 9.8 \text{ m/s}^2$ refers to the acceleration of gravity at surface of Earth. One has also $M_S = 1.99 \times 10^{30} \text{ kg}$ and $AU = 1.49 \times 10^{11} \text{ m}$, $R_E = 6.34 \times 10^6 \text{ m}$.

One can imagine two simple qualitative killer predictions assuming maximal gravitational screening.

- (a) Solar eclipse should induce anomalous tidal effects induced by the screening in the shadow of the Moon.
- (b) The comparison of solar and moon eclipses might kill the scenario. The screening would imply that inside the shadow the tidal effects are of same order of magnitude at both sides of Earth for Sun-Earth-Moon configuration but weaker at night-side for Sun-Moon-Earth situation.

An interesting co-incidence

The value of $\Delta f/f = 5 \times 10^{-4}$ in experiment of Jeverdan is exactly equal to $v_0 = 2^{-11}$, which appears in the formula $\hbar_{gr} = GMm/v_0$ for the favored values of the gravitational Planck constant. The predictions are $\Delta f/f \leq \Delta p/p \simeq 3 \times 10^{-4}$. Powers of $1/v_0$ appear also as favored scalings of Planck constant in the TGD inspired quantum model of bio-systems based on dark matter [K26]. This co-incidence would suggest the quantization formula

$$\frac{g_E}{g_S} = \frac{M_S}{M_E} \times \frac{R_E^2}{r_E^2} = v_0 \quad (6.6.9)$$

for the ratio of the gravitational accelerations caused by Earth and Sun on an object at the surface of Earth.

It must be however admitted that the larger variation in the magnitude and even sign of the effect does not favor this kind of interpretation.

Summary of the predicted new effects

Let us sum up the basic predictions of the model assuming maximal gravitational screening.

- (a) The first prediction is the gradual increase of the oscillation frequency of the conical pendulum by $\Delta f/f \leq 3 \times 10^{-4}$ to maximum and back during night-time in case that the pendulum has vanishing Z^0 charge. Also a periodic variation of the frequency and a periodic rotation of the oscillation plane with period co-inciding with Moon's rotation period is predicted. Already Allais observed both 24 hour cycle and cycle which is slightly longer and due to the fact that Moon rates around Earth.
- (b) A paraconical pendulum with initial position, which corresponds to the resting position in the normal situation should begin to oscillate during solar eclipse. This effect is testable by fixing the pendulum to the resting position and releasing it during the eclipse. The amplitude of the oscillation corresponds to the angle between \bar{g} and $\bar{g} + \Delta\bar{g}$ given in a good approximation by

$$\sin[\Theta(\bar{g}, \bar{g} + \Delta\bar{g})] = \frac{\Delta g}{g} \sin[\Theta(\bar{g}, \Delta\bar{g})] . \quad (6.6.10)$$

An upper bound for the amplitude would be $\Theta \leq 3 \times 10^{-4}$, which corresponds to .015 degrees. Z^0 charge of the pendulum would modify this simple picture.

- (c) Gravitational screening should cause a reduction of tidal effects at the "night-side" of Moon/Sun. The reduction should be maximum at "midnight". This reduction together with the fact that the tidal effects of Moon and Sun at the day side are of same order of magnitude could explain some anomalies know to be associated with the tidal effects [F30]. A further prediction is the day-night variation of the atmospheric and sea pressure gradients with amplitude which is for Sun $3 \times 10^{-4}g$ and for Moon $1.3 \times 10^{-3}g$.

To sum up, the predicted anomalous tidal effects and the explanation of the limiting oscillation plane in terms of stronger dissipation in rotational degree of freedom could kill the model assuming only gravitational screening.

Comparison with experimental results

The experimental results look mutually contradictory in the context provided by the model assuming only screening. Some experiments find no anomaly at all as one learns from [E5]. There are also measurements supporting the existence of an effect but with varying sign and quite different orders of magnitude. Either the experimental determinations cannot be trusted or the model is too simple.

- (a) The *increase* (!) of the frequency observed by Jeverdan and collaborators reported in Wikipedia article [E5] for Foucault pendulum is $\Delta f/f \simeq 5 \times 10^{-4}$ would support the model even quantitatively since this value is only by a factor $5/3$ higher than the maximal effect allowed by the screening model. Unfortunately, I do not have an access to the paper of Jeverdan *et al* to find out the value of $\cos(\Theta)$ in the experimental arrangement and whether there is indeed a decrease of the period as claimed in Wikipedia article. In [E113] two experiments supporting an effect $\Delta g/g = x \times 10^{-4}$, $x = 1.5$ or 2.6 but the sign of the effect is different in these experiments.
- (b) Allais reported an anomaly $\Delta g/g \sim 5 \times 10^{-6}$ during 1954 eclipse [E17]. According to measurements by authors of [E113] the period of oscillation increases and one has $\Delta g/g \sim 5 \times 10^{-6}$. Popescu and Olenici report a decrease of the oscillation period by $(\Delta g/g)\cos(\Theta) \simeq 1.4 \times 10^{-5}$.
- (c) In [E129] a *reduction* of vertical gravitational acceleration $\Delta g/g = (7.0 \pm 2.7) \times 10^{-9}$ is reported: this is by a factor 10^{-5} smaller than the result of Jeverdan.
- (d) Small pressure waves with $\Delta p/p = 2 \times 10^{-5}$ are registered by some micro-barometers [E17] and might relate to the effect since pressure gradient and gravitational acceleration should compensate each other. $\Delta g \cos(\Theta)/g$ would be about 7 per cent of its maximum value for Earth-Sun system in this case. The knowledge of the sign of pressure variation would tell whether effective gravitational force is screened or amplified by Moon.

6.6.3 Allais effect as evidence for large values of gravitational Planck constant?

One can represent rather general counter arguments against the models based on Z^0 conductivity and gravitational screening if one takes seriously the puzzling experimental findings concerning frequency change.

- (a) Allais effect identified as a rotation of oscillation plane seems to be established and seems to be present always and can be understood in terms of torque implying limiting oscillation plane.
- (b) During solar eclipses Allais effect however becomes much stronger. According to Olenici's experimental work the effect appears always when massive objects form collinear structures.
- (c) The behavior of the change of oscillation frequency seems puzzling. The sign of the frequency increment varies from experiment to experiment and its magnitude varies within five orders of magnitude.

What one can conclude about general pattern for $\Delta f/f$?

The above findings allow to make some important conclusions about the nature of Allais effect.

- (a) Some genuinely new dynamical effect should take place when the objects are collinear. If gravitational screening would cause the effect the frequency would always grow but this is not the case.
- (b) If stellar objects and also ring like dark matter structures possibly assignable to their orbits are Z^0 conductors, one obtains screening effect by polarization and for the ring like structure the resulting effectively 2-D dipole field behaves as $1/\rho^2$ so that there are hopes of obtaining large screening effects and if the Z^0 charge of pendulum is allow to have both signs, one might hope of being to able to explain the effect. It is however difficult to understand why this effect should become so strong in the collinear case.
- (c) The apparent randomness of the frequency change suggests that interference effect made possible by the gigantic value of gravitational Planck constant is in question. On the other hand, the dependence of $\Delta g/g$ on pendulum suggests a breaking of Equivalence Principle. It however turns out that the variation of the distances of the pendulum to Sun and Moon can explain the experimental findings since the pendulum turns out to act as a sensitive

gravitational interferometer. An apparent breaking of Equivalence Principle could result if the effect is partially caused by genuine gauge forces, say dark classical Z^0 force, which can have arbitrarily long range in TGD Universe.

- (d) If topological light rays (MEs) provide a microscopic description for gravitation and other gauge interactions one can envision these interactions in terms of MEs extending from Sun/Moon radially to pendulum system. What comes in mind that in a collinear configuration the signals along S-P MEs and M-P MEs superpose linearly so that amplitudes are summed and interference terms give rise to an anomalous effect with a very sensitive dependence on the difference of S-P and M-P distances and possible other parameters of the problem. One can imagine several detailed variants of the mechanism. It is possible that signal from Sun combines with a signal from Earth and propagates along Moon-Earth ME or that the interferences of these signals occurs at Earth and pendulum.
- (e) Interference suggests macroscopic quantum effect in astrophysical length scales and thus gravitational Planck constants given by $\hbar_{gr} = GMm/v_0$, where $v_0 = 2^{-11}$ is the favored value, should appear in the model. Since $\hbar_{gr} = GMm/v_0$ depends on both masses this could give also a sensitive dependence on mass of the pendulum. One expects that the anomalous force is proportional to \hbar_{gr} and is therefore gigantic as compared to the effect predicted for the ordinary value of Planck constant.

Model for interaction via gravitational MEs with large Planck constant

Restricting the consideration for simplicity only gravitational MEs, a concrete model for the situation would be as follows.

- (a) The picture based on topological light rays suggests that the gravitational force between two objects M and m has the following expression

$$F_{M,m} = \frac{GMm}{r^2} = \int |S(\lambda, r)|^2 p(\lambda) d\lambda$$

$$p(\lambda) = \frac{\hbar_{gr}(M, m) 2\pi}{\lambda}, \quad \hbar_{gr} = \frac{GMm}{v_0(M, m)}. \quad (6.6.11)$$

$p(\lambda)$ denotes the momentum of the gravitational wave propagating along ME. v_0 can depend on (M, m) pair. The interpretation is that $|S(\lambda, r)|^2$ gives the rate for the emission of gravitational waves propagating along ME connecting the masses, having wave length λ , and being absorbed by m at distance r .

- (b) Assume that $S(\lambda, r)$ has the decomposition

$$S(\lambda, r) = R(\lambda) \exp[i\Phi(\lambda)] \frac{\exp[ik(\lambda)r]}{r},$$

$$\exp[ik(\lambda)r] = \exp[ip(\lambda)r/\hbar_{gr}(M, m)],$$

$$R(\lambda) = |S(\lambda, r)|. \quad (6.6.12)$$

The phases $\exp(i\Phi(\lambda))$ might be interpreted in terms of scattering matrix. The simplest assumption is $\Phi(\lambda) = 0$ turns out to be consistent with the experimental findings. The substitution of this expression to the above formula gives the condition

$$\int |R(\lambda)|^2 \frac{d\lambda}{\lambda} = v_0. \quad (6.6.13)$$

Consider now a model for the Allais effect based on this picture.

- (a) In the non-collinear case one obtains just the standard Newtonian prediction for the net forces caused by Sun and Moon on the pendulum since $Z_{S,P}$ and $Z_{M,P}$ correspond to non-parallel MEs and there is no interference.

- (b) In the collinear case the interference takes place. If interference occurs for identical momenta, the interfering wavelengths are related by the condition

$$p(\lambda_{S,P}) = p(\lambda_{M,P}) . \quad (6.6.14)$$

This gives

$$\frac{\lambda_{M,P}}{\lambda_{S,P}} = \frac{\hbar_{M,P}}{\hbar_{S,P}} = \frac{M_M v_0(S,P)}{M_S v_0(M,P)} . \quad (6.6.15)$$

- (c) The net gravitational force is given by

$$\begin{aligned} F_{gr} &= \int |Z(\lambda, r_{S,P}) + Z(\lambda/x, r_{M,P})|^2 p(\lambda) d\lambda \\ &= F_{gr}(S, P) + F_{gr}(M, P) + \Delta F_{gr} , \\ \Delta F_{gr} &= 2 \int Re [S(\lambda, r_{S,P}) \bar{S}(\lambda/x, r_{M,P})] \frac{\hbar_{gr}(S, P) 2\pi}{\lambda} d\lambda , \\ x &= \frac{\hbar_{S,P}}{\hbar_{M,P}} = \frac{M_S v_0(M, P)}{M_M v_0(S, P)} . \end{aligned} \quad (6.6.16)$$

Here $r_{M,P}$ is the distance between Moon and pendulum. The anomalous term ΔF_{gr} would be responsible for the Allais effect and change of the frequency of the oscillator.

- (d) The anomalous gravitational acceleration can be written explicitly as

$$\begin{aligned} \Delta a_{gr} &= 2 \frac{GM_S}{r_S r_M v_0(S, P)} \times I , \\ I &= \int R(\lambda) R(\lambda/x) \cos \left[\Phi(\lambda) - \Phi(\lambda/x) + 2\pi \frac{(y_S r_S - x y_M r_M)}{\lambda} \right] \frac{d\lambda}{\lambda} , \\ y_M &= \frac{r_{M,P}}{r_M} , \quad y_S = \frac{r_{S,P}}{r_S} . \end{aligned} \quad (6.6.17)$$

Here the parameter y_M (y_S) is used to express the distance $r_{M,P}$ ($r_{S,P}$) between pendulum and Moon (Sun) in terms of the semi-major axis r_M (r_S) of Moon's (Earth's) orbit. The interference term is sensitive to the ratio $2\pi(y_S r_S - x y_M r_M)/\lambda$. For short wave lengths the integral is expected to not give a considerable contribution so that the main contribution should come from long wave lengths. The gigantic value of gravitational Planck constant and its dependence on the masses implies that the anomalous force has correct form and can also be large enough.

- (e) If one poses no boundary conditions on MEs the full continuum of wavelengths is allowed. For very long wave lengths the sign of the cosine terms oscillates so that the value of the integral is very sensitive to the values of various parameters appearing in it. This could explain random looking outcome of experiments measuring $\Delta f/f$. One can also consider the possibility that MEs satisfy periodic boundary conditions so that only wave lengths $\lambda_n = 2r_S/n$ are allowed: this implies $\sin(2\pi y_S r_S/\lambda) = 0$. Assuming this, one can write the magnitude of the anomalous gravitational acceleration as

$$\begin{aligned} \Delta a_{gr} &= 2 \frac{GM_S}{r_{S,P} r_{M,P}} \times \frac{1}{v_0(S, P)} \times I , \\ I &= \sum_{n=1}^{\infty} R\left(\frac{2r_{S,P}}{n}\right) R\left(\frac{2r_{S,P}}{nx}\right) (-1)^n \cos \left[\Phi(n) - \Phi(xn) + n\pi \frac{x y_M r_M}{y_S r_S} \right] . \end{aligned} \quad (6.6.18)$$

If $R(\lambda)$ decreases as λ^k , $k > 0$, at short wavelengths, the dominating contribution corresponds to the lowest harmonics. In all terms except cosine terms one can approximate $r_{S,P}$ resp. $r_{M,P}$ with r_S resp. r_M .

- (f) The presence of the alternating sum gives hopes for explaining the strong dependence of the anomaly term on the experimental arrangement. The reason is that the value of xyr_M/r_S appearing in the argument of cosine is rather large:

$$\frac{xy_M r_M}{y_S r_S} = \frac{y_M}{y_S} \frac{M_S}{M_M} \frac{r_M}{r_S} \frac{v_0(M, P)}{v_0(S, P)} \simeq 6.95671837 \times 10^4 \times \frac{y_M}{y_S} \times \frac{v_0(M, P)}{v_0(S, P)} .$$

The values of cosine terms are very sensitive to the exact value of the factor $M_S r_M / M_M r_S$ and the above expression is probably not quite accurate value. As a consequence, the values and signs of the cosine terms are very sensitive to the values of y_M/y_S and $\frac{v_0(M, P)}{v_0(S, P)}$.

The value of y_M/y_S varies from experiment to experiment and this alone could explain the high variability of $\Delta f/f$. The experimental arrangement would act like interferometer measuring the distance ratio $r_{M, P}/r_{S, P}$. Hence it seems that the condition

$$\frac{v_0(S, P)}{v_0(M, P)} \neq \text{const.} \quad (6.6.19)$$

implying breaking of Equivalence Principle is not necessary to explain the variation of the sign of $\Delta f/f$ and one can assume $v_0(S, P) = v_0(M, P) \equiv v_0$. One can also assume $\Phi(n) = 0$.

Scaling law

The assumption of the scaling law

$$R(\lambda) = R_0 \left(\frac{\lambda}{\lambda_0} \right)^k \quad (6.6.20)$$

is very natural in light of conformal invariance and masslessness of gravitons and allows to make the model more explicit. With the choice $\lambda_0 = r_S$ the anomaly term can be expressed in the form

$$\begin{aligned} \Delta a_{gr} &\simeq \frac{GM_S}{r_S r_M} \frac{2^{2k+1}}{v_0} \left(\frac{M_M}{M_S} \right)^k R_0(S, P) R_0(M, P) \times \sum_{n=1}^{\infty} \frac{(-1)^n}{n^{2k}} \cos [\Phi(n) - \Phi(xn) + n\pi K] , \\ K &= x \times \frac{r_M}{r_S} \times \frac{y_M}{y_S} . \end{aligned} \quad (6.6.21)$$

The normalization condition of Eq. 6.6.13 reads in this case as

$$R_0^2 = v_0 \times \frac{1}{2\pi \sum_n \left(\frac{1}{n}\right)^{2k+1}} = \frac{v_0}{\pi \zeta(2k+1)} . \quad (6.6.22)$$

Note the shorthand $v_0(S/M, P) = v_0$. The anomalous gravitational acceleration is given by

$$\begin{aligned} \Delta a_{gr} &= \sqrt{\frac{v_0(M, P)}{v_0(S, P)}} \frac{GM_S}{r_S^2} \times XY \times \sum_{n=1}^{\infty} \frac{(-1)^n}{n^{2k}} \cos [\Phi(n) - \Phi(xn) + n\pi K] , \\ X &= 2^{2k} \times \frac{r_S}{r_M} \times \left(\frac{M_M}{M_S} \right)^k , \\ Y &= \frac{1}{\pi \sum_n \left(\frac{1}{n}\right)^{2k+1}} = \frac{1}{\pi \zeta(2k+1)} . \end{aligned} \quad (6.6.23)$$

It is clear that a reasonable order of magnitude for the effect can be obtained if k is small enough and that this is essentially due to the gigantic value of gravitational Planck constant.

The simplest model consistent with experimental findings assumes $v_0(M, P) = v_0(S, P)$ and $\Phi(n) = 0$ and gives

$$\begin{aligned} \frac{\Delta a_{gr}}{g \cos(\Theta)} &= \frac{GM_S}{r_S^2 g} \times XY \times \sum_{n=1}^{\infty} \frac{(-1)^n}{n^{2k}} \cos(n\pi K) , \\ X &= 2^{2k} \times \frac{r_S}{r_M} \times \left(\frac{M_M}{M_S}\right)^k , \\ Y &= \frac{1}{\pi \sum_n \left(\frac{1}{n}\right)^{2k+1}} = \frac{1}{\pi \zeta(2k+1)} , \\ K &= x \times \frac{r_M}{r_S} \times \frac{y_M}{y_S} , \quad x = \frac{M_S}{M_M} . \end{aligned} \quad (6.6.24)$$

Numerical estimates

To get a numerical grasp to the situation one can use $M_S/M_M \simeq 2.71 \times 10^7$, $r_S/r_M \simeq 389.1$, and $(M_S r_M / M_M r_S) \simeq 1.74 \times 10^4$. The overall order of magnitude of the effect would be

$$\begin{aligned} \frac{\Delta g}{g} &\sim XY \times \frac{GM_S}{R_S^2 g} \cos(\Theta) , \\ \frac{GM_S}{R_S^2 g} &\simeq 6 \times 10^{-4} . \end{aligned} \quad (6.6.25)$$

The overall magnitude of the effect is determined by the factor XY .

- For $k = 0$ the normalization factor is proportional to $1/\zeta(1)$ and diverges and it seems that this option cannot work.
- The table below gives the predicted overall magnitudes of the effect for $k = 1, 2/2$ and $1/4$.

k	1	1/2	1/4
$\frac{\Delta g}{g \cos(\Theta)}$	1.1×10^{-9}	4.3×10^{-6}	1.97×10^{-4}

For $k = 1$ the effect is too small to explain even the findings of [E129] since there is also a kinematic reduction factor coming from $\cos(\Theta)$. Therefore $k < 1$ suggesting fractal behavior is required. For $k = 1/2$ the effect is of same order of magnitude as observed by Allais. The alternating sum equals in a good approximation to -0.693 for $y_S/y_M = 1$ so that it is not possible to explain the finding $\Delta f/f \simeq 5 \times 10^{-4}$ of Jeverdan.

- For $k = 1/4$ the expression for Δa_{gr} reads as

$$\begin{aligned} \frac{\Delta a_{gr}}{g \cos(\Theta)} &\simeq 1.97 \times 10^{-4} \sum_{n=1}^{\infty} \frac{(-1)^n}{n^{1/2}} \cos(n\pi K) , \\ K &= \frac{y_M}{y_S} u , \quad u = \frac{M_S}{M_M} \frac{r_M}{r_S} \simeq 6.95671837 \times 10^4 . \end{aligned} \quad (6.6.26)$$

The sensitivity of cosine terms to the precise value of y_M/y_S gives good hopes of explaining the strong variation of $\Delta f/f$ and also the findings of Jeverdan. Numerical experimentation indeed shows that the cosine sum alternates and increases as y_M/y_S increases in the range $[1, 2]$.

The eccentricities of the orbits of Moon *resp.* Earth are $e_M = .0549$ *resp.* $e_E = .017$. Denoting semimajor and semiminor axes by a and b one has $\Delta = (a-b)/a = 1 - \sqrt{1 - e^2}$. $\Delta_M = 15 \times 10^{-4}$ *resp.* $\Delta_E = 1.4 \times 10^{-4}$ characterizes the variation of y_M *resp.* y_E due to the non-circularity of the orbits of Moon *resp.* Earth. The ratio $R_E/r_M = .0166$ characterizes the range of the variation of $\Delta y_M = \Delta r_{M,P}/r_M \leq R_E/r_M$ due to the variation of the position of the laboratory. All these numbers are large enough to imply large variation of the argument of cosine term even for $n = 1$ and the variation due to the position at the surface of Earth is especially large.

The duration of full eclipse is of order 8 minutes which corresponds to angle $\phi = \pi/90$ and at equator roughly to a $\Delta y_N = (\sqrt{r_M^2 + R_E^2 \sin^2(\pi/90)} - r_M)/r_M \simeq (\pi/90)^2 R_E^2/2r_M^2 \simeq 1.7 \times 10^{-7}$. Thus the change of argument of $n = 1$ cosine term during full eclipse is of order $\Delta\Phi = .012\pi$ at equator. The duration of the eclipse itself is of order two 2 hours giving $\Delta y_M \simeq 3.4 \times 10^{-5}$ and the change $\Delta\Phi = 2.4\pi$ of the argument of $n = 1$ cosine term.

Other effects

There are also other strange effects involved.

- (a) One should explain also the recent finding by Popescu and Olenici, which they interpret as a quantization of the plane of oscillation of paraconical oscillator during solar eclipse [E189]. A possible TGD based explanation would be in terms of quantization of $\Delta\bar{g}$ and thus of the limiting oscillation plane. This quantization could reflect the quantization of the angular momentum of the dark gravitons decaying into bunches of ordinary gravitons and providing to the pendulum the angular momentum inducing the change of the oscillation plane. The knowledge of friction coefficients associated with the rotation of the oscillation plane would allow to deduce the value of the gravitational Planck constant if one assumes that each dark gravitons corresponds to its own approach to asymptotic oscillation plane. The flux would be reduced in a stepwise manner during the solar eclipse as the distance traversed by the flux through Moon increases and reduced in a similar manner after the maximum of the eclipse.
- (b) There is also evidence for the effect before and after the main eclipse [E189]. The time scale is 1 hour. A possible explanation is in terms of a dark matter ring analogous to rings of Jupiter surrounding Moon. From the average orbital velocity $v = 1.022$ km/s of the Moon one obtains that the distance traversed by moon during 1 hour is $R_1 = 3679$ km. The mean radius of moon is $R = 1737.10$ km so that one has $R_1 = 2R$ with 5 per cent accuracy ($2 \times R = 3474$ km). The Bohr quantization of the orbits of inner planets discussed in [K72] with the value $\hbar_{gr} = GMm/v_0$ of the gravitational Planck constant predicts $r_n \propto n^2 GM/v_0^2$ and gives the orbital radius of Mercury correctly for the principal quantum number $n = 3$ and $v_0/c = 4.6 \times 10^{-4} \simeq 2^{-11}$. From the proportionality $r_n \propto n^2 GM/v_0^2$ one can deduce by scaling that in the case of Moon with $M(\text{moon})/M(\text{Sun}) = 3.4 \times 10^{-8}$ the prediction for the radius of $n = 1$ Bohr orbit would be $r_1 = (M(\text{Moon})/M(\text{Sun})) \times R_M/9 \simeq .0238$ km for the same value of v_0 . This is too small by a factor 6.45×10^{-6} . $r_1 = 3679$ km would require $n \sim 382$ or $n = n(\text{Earth}) = 5$ and $v_0(\text{Moon})/v_0(\text{Sun}) \simeq 2^{-4}$.

6.6.4 Could Z^0 force be present?

One can understand the experimental results without a breaking of Equivalence Principle if the pendulum acts as a quantum gravitational interferometer. One cannot exclude the possibility that there is also a dependence on pendulum. In this case one would have a breaking of Equivalence Principle, which could be tested using several penduli in the same experimental arrangement. The presence of Z^0 force could induce an apparent breaking of Equivalence Principle. The most plausible option is Z^0 MEs with large Planck constant. One can consider also an alternative purely classical option, which does not involve large values of Planck constant.

Could purely classical Z^0 force allow to understand the variation of $\Delta f/f$?

In the earlier model of the Allais effect (see the Appendix of [K10]) I proposed that the classical Z^0 force could be responsible for the effect. TGD indeed predicts that any object with gravitational mass must have non-vanishing em and Z^0 charges but leaves their magnitude and sign open.

- (a) If both Sun, Earth, and pendulum have Z^0 charges, one might even hope of understanding why the sign of the outcome of the experiment varies since the ratio of Z^0 charge to gravitational mass and even the sign of Z^0 charge of the pendulum might vary. Constant charge-to-mass ratio is of course the simplest hypothesis so that only an effective scaling of gravitational constant would be in question. A possible test is to use several penduli in the same experiment and find whether they give rise to same effect or not.
- (b) If Moon and Earth are Z^0 conductors, a Z^0 surface charge canceling the tangential component of Z^0 force at the surface of Earth is generated and affects the vertical component of the force experienced by the pendulum. The vertical component of Z^0 force is $2F_Z \cos(\theta)$ and thus proportional to $\cos(\Theta)$ as also the effective screening force below the shadow of Moon during solar eclipse. When Sun is in a vertical direction, the induced dipole contribution doubles the radial Z^0 force near surface and the effect due to the gravitational screening would be maximal. For Sun in horizon there would be no Z^0 force and gravitational tidal effect of Sun would vanish in the first order so that over all anomalous effect would be smallest possible: for a full screening $\Delta f/f \simeq \Delta g^2/4g^2 \simeq 4.5 \times 10^{-8}$ would be predicted. One might hope that the opposite sign of gravitational and Z^0 contributions could be enough to explain the varying sign of the overall effect.
- (c) It seems necessary to have a screening effect associated with gravitational force in order to understand the rapid variation of the effect during the eclipse. The fact that the maximum effect corresponds to a maximum gravitational screening suggests that it is present and determines the general scale of variation for the effect. If the maximal Z^0 charge of the pendulum is such that Z^0 force is of the same order of magnitude as the maximal screening of the gravitational force and of opposite sign (that is attractive), one could perhaps understand the varying sign of the effect but the effect would develop continuously and begin before the main eclipse. If the sign of Z^0 charge of pendulum can vary, there is no difficulty in explaining the varying sign of the effect. An interesting possibility is that Moon, Sun and Earth have dark matter halos so that also gravitational screening could begin before the eclipse. The real test for the effect would come from tidal effects unless one can guarantee that the pendulum is Z^0 neutral or its Z^0 charge/mass ratio is always the same.
- (d) As noticed also by Allais, Newtonian theory does not give a satisfactory account of the tidal forces and there is possibility that tides give a quantitative grasp on situation. If Earth is Z^0 conductor tidal effects should be determined mainly by the gravitational force and modified by its screening whereas Z^0 force would contribute mainly to the pressure waves accompanying the shadows of Moon and Sun. The sign and magnitude of pressure waves below Sun and Moon could give a quantitative grasp of Z^0 forces of Sun and Moon. Z^0 surface charge would have opposite signs at the opposite sides of Earth along the line connecting Earth to Moon *resp.* Sun and depending on sign of Z^0 force the screening and Z^0 force would tend to amplify or cancel the net anomalous effect on pressure.
- (e) A strong counter argument against the model based on Z^0 force is that collinear configurations are reached in continuous manner from non-collinear ones in the case of Z^0 force and the fact that gravitational screening does not conform with the varying sign of the discontinuous effect occurring during the eclipse. It would seem that the effect in question is more general than screening and perhaps more like quantum mechanical interference effect in astrophysical length scale.

Could Z^0 MEs with large Planck constant be present?

The previous line of arguments for gravitational MEs generalizes in a straightforward manner to the case of Z^0 force. Generalizing the expression for the gravitational Planck constant one

has $\hbar_{Z^0} = g_Z^2 Q_Z(M)Q_Z(m)/v_0$. Assuming proportionality of Z^0 charge to gravitational mass one obtains formally similar expression for the Z^0 force as in previous case. If Q_Z/M ratio is constant, Equivalence Principle holds true for the effective gravitational interaction if the sign of Z^0 charge is fixed. The breaking of Equivalence Principle would come naturally from the non-constancy of the $v_0(S, P)/v_0(M, P)$ ratio also in the recent case. The variation of the sign of $\Delta f/f$ would be explained in a trivial manner by the variation of the sign of Z^0 charge of pendulum but this explanation is not favored by Occam's razor.

6.7 Gravimagnetism and TGD

Gravimagnetism is one of the predictions of GRT which is being tested experimentally. TGD predicts deviations from the predictions of GRT which unfortunately are not seen in the satellite experiment to be discussed below. The claimed discovery of gravimagnetic effect in superconductors having strength 20 orders of magnitude larger than predicted by GRT raises the question whether TGD might explain the effect.

6.7.1 Gravity Probe B and TGD

Gravity Probe B experiment tests the predictions of General Relativity related to gravimagnetism. Only the abstract [E134] of the talk C. W. Francis Everitt summarizing the results is available when I am writing this.

The NASA Gravity Probe B (GP-B) orbiting gyroscope test of General Relativity, launched from Vandenberg Air Force Base on 20 April, 2004, tests two consequences of Einstein's theory: 1) the predicted 6.6 arc-s/year geodetic effect due to the motion of the gyroscope through the curved space-time around the Earth; 2) the predicted 0.041 arc-s/year frame-dragging effect due to the rotating Earth. The mission has required the development of cryogenic gyroscopes with drift-rates 7 orders of magnitude better than the best inertial navigation gyroscopes. These and other essential technologies, for an instrument which once launched must work perfectly, have come into being as the result of an intensive collaboration between Stanford physicists and engineers, NASA and industry. GP-B entered its science phase on August 27, 2004 and completed data collection on September 29, 2005. Analysis of the data has been in continuing progress during and since the mission. This paper will describe the main features and challenges of the experiment and announce the first results.

The article [E194] gives an excellent summary of various test of GRT. The predictions tested by GP-B relate to gravimagnetic effects. The field equations of general relativity in post-Newtonian approximation with a choice of a preferred frame can in good approximation ($g_{ij} = -\delta_{ij}$) be written in a form highly reminiscent of Maxwell's equations with g_{tt} component of metric defining the counterpart of the scalar potential giving rise to gravito-electric field and g_{ti} the counterpart of vector potential giving rise to the gravimagnetic field.

Rotating body generates a gravimagnetic field so that bodies moving in the gravimagnetic field of a rotating body experience the analog of Lorentz force and gyroscope suffers a precession similar to that suffered by a magnetic dipole in magnetic field (Thirring-Lense effect or frame-drag). Besides this there is geodetic precession due to the motion of the gyroscope in the gravito-electric field present even in the case of non-rotating source which might be perhaps understood in terms of gravito-Faraday law. Both these effects are tested by GP-B.

In the following I represent some general comments about how TGD and GRT differs and also say something about the predictions of TGD concerning GP-B experiment.

TGD and GRT

Consider first basic differences between TGD and GRT.

- (a) In TGD local Lorentz invariance is replaced by exact Poincare invariance at the level of the imbedding space $H = M^4 \times CP_2$. Hence one can use unique global Minkowski coordinates

for the space-time sheets and gets rid of the problems related to the physical identification of the preferred coordinate system.

- (b) General coordinate invariance holds true in both TGD and GRT.
- (c) The basic difference between GRT and TGD is that in TGD framework gravitational field is induced from the metric of the imbedding space. One important cosmological implication is that the imbeddings of the Robertson-Walker metric for which the gravitational mass density is critical or overcritical fail after some value of cosmic time. Also classical gauge potentials are induced from the spinor connection of H so that the geometrization applies to all classical fields. Very strong constraints between fundamental interactions at the classical level are implied since CP_2 are the fundamental dynamical variables at the level of macroscopic space-time.
- (d) Equivalence Principle holds in TGD only in a weak form in the sense that gravitational energy momentum currents (rather than tensor) are not identical with inertial energy momentum currents. Inertial four-momentum currents are conserved but not gravitational ones. This explains the non-conservation of gravitational mass in cosmological time scales. At the more fundamental parton level (light-like 3-surfaces to which an almost-topological QFT is assigned) inertial four-momentum can be regarded as the time-average of the non-conserved gravitational four-momentum so that equivalence principle would hold in average sense. The non-conservation of gravitational four-momentum relates very closely to particle massivation.

TGD and GP-B

There are excellent reasons to expect that Maxwellian picture holds true in a good accuracy if one uses Minkowski coordinates for the space-time surface. In fact, TGD allows a static solutions with 2-D CP_2 projection for which the prerequisites of the Maxwellian interpretation are satisfied (the deviations of the spatial components g_{ij} of the induced metric from $-\delta_{ij}$ are negligible).

Schwartschild and Reissner-Norström metrics allow imbeddings as 4-D surfaces in H but Kerr metric [E21] assigned to rotating systems probably not. If this is indeed the case, the gravimagnetic field of a rotating object in TGD Universe cannot be identical with the exact prediction of GRT but could be so in the Post-Newtonian approximation. Scalar and vector potential correspond to four field quantities and the number of CP_2 coordinates is four. Imbedding as vacuum extremals with 2-D CP_2 projection guarantees automatically the consistency with the field equations but requires the orthogonality of gravito-electric and -magnetic fields. This holds true in post-Newtonian approximation in the situation considered.

Hence apart from restrictions caused by the failure of the global imbedding at short distances it *might* be possible to imbed Post-Newtonian approximations into H in the approximation $g_{ij} = -\delta_{ij}$. If so, the predictions for Thirring-Lense effect would not differ measurably from those of GRT. The predictions for the geodesic precession involving only scalar potential would be identical in any case.

The imbeddability in the post-Newtonian approximation is however questionable if one assumes vacuum extremal property and small deformations of Schwartschild metric indeed predict a gravimagnetic field differing from the dipole form.

1. Simplest candidate for the metric of a rotating star

The simplest situation for the metric of rotating start is obtained by assuming that vacuum extremal imbeddable to $M^4 \times S^2$, where S^2 is the geodesic sphere of CP_2 with vanishing homological charge and induce Kähler form. Use coordinates (Θ, Φ) for S^2 and spherical coordinates (t, r, θ, ϕ) in space-time identifiable as M^4 spherical coordinates apart from scaling and r -dependent shift in the time coordinate.

- (a) For Schwartschild metric one has

$$\Phi = \omega t, \quad \sin(\Theta) = f(r) . \quad (6.7.1)$$

f is fixed highly uniquely by the imbedding of Schwarzschild metric and asymptotically one must have

$$f = f_0 + \frac{C}{r}$$

in order to obtain $g_{tt} = 1 - 2GM/r$ ($\equiv 1 + \Phi_{gr}$) behavior for the induced metric.

- (b) The small deformation giving rise to the gravimagnetic field and metric of rotating star is given by

$$\Phi = \omega t + n\phi \quad (6.7.2)$$

There is obvious analogy with the phase of Schödinger amplitude for angular momentum eigenstate with $L_z = n$ which conforms with the quantum classical correspondence.

- (c) The non-vanishing component of A^g is proportional to gravitational potential Φ_{gr} .

$$A_\phi^g = g_{t\phi} = (n/\omega)\Phi_{gr} . \quad (6.7.3)$$

- (d) A little calculation gives for the magnitude of B_g^θ from the curl of A^g the expression

$$B_g^\theta = \frac{n}{\omega} \times \frac{1}{\sin(\theta)} \times \frac{2GM}{r^3} . \quad (6.7.4)$$

In the plane $\theta = \pi/2$ one has dipole field and the value of n is fixed by the value of angular momentum of star.

- (e) Quantization of angular momentum is obtained for a given value of ω . This becomes clear by comparing the field with dipole field in $\theta = \pi/2$ plane. Note that GJ , where J is angular momentum, takes the role of magnetic moment in B_g [E194] appears as a free parameter analogous to energy in the imbedding and means that the unit of angular momentum varies. In TGD framework this could be interpreted in terms of dynamical Planck constant having in the most general case any rational value but having a spectrum of number theoretically preferred values. Dark matter is interpreted as phases with large value of Planck constant which means possibility of macroscopic quantum coherence even in astrophysical length scales. Dark matter would induce quantum like effects on visible matter. For instance, the periodicity of small n states might be visible as patterns of visible matter with discrete rotational symmetry.

2. Comparison with the dipole field

The simplest candidate for the gravimagnetic field differs in many respects from a dipole field.

- (a) Gravitomagnetic field has $1/r^3$ dependence so that the distance dependence is same as in GRT.
- (b) Gravitomagnetic flux flows along z -axis in opposite directions at different sides of $z = 0$ plane and emanates from z -axis radially and flows along spherical surface. Hence the radial component of B_g would vanish whereas for the dipole field it would be proportional to $\cos(\theta)$.
- (c) The dependence on the angle θ of spherical coordinates is $1/\sin(\theta)$ (this conforms with the radial flux from z -axis whereas for the dipole field the magnitude of B_g^θ has the dependence $\sin(\theta)$). At $z = 0$ plane the magnitude and direction coincide with those of the dipole field so that satellites moving at the gravimagnetic equator would not distinguish between GRT and TGD since also the radial component of B_g vanishes here.

- (d) For other orbits effects would be non-trivial and in the vicinity of the flux tube formally arbitrarily large effects are predicted because of $1/\sin(\theta)$ behavior whereas GRT predicts $\sin(\theta)$ behavior. Therefore TGD could be tested using satellites near gravito-magnetic North pole.
- (e) The strong gravimagnetic field near poles causes gravi-magnetic Lorentz force and could be responsible for the formation of jets emanating from black hole like structures. This additional force might have also played some role in the formation of planetary systems and the plane in which planets move might correspond to the plane $\theta = \pi/2$ where gravimagnetic force has no component orthogonal to the plane. Same applies in the case of galaxies.

3. Consistency with the model for the asymptotic state of star

In TGD framework natural candidates for the asymptotic states of the star are solutions of field equations for which gravitational four-momentum is locally conserved. Vacuum extremals must therefore satisfy the field equations resulting from the variation of Einstein's action (possibly with cosmological constant) with respect to the induced metric. Quite remarkably, the solution representing asymptotic state of the star is necessarily rotating.

The proposed picture is consistent with the model of the asymptotic state of star. Also the magnetic parts of ordinary gauge fields have essentially similar behavior. This is actually obvious since CP_2 coordinates are fundamental dynamical variables and the field line topologies of induced gauge fields and induced metric are therefore very closely related.

As already discussed, the physicists M. Tajmar and C. J. Matos and their collaborators working in ESA (European Satellite Agency) have made an amazing claim of having detected strong gravimagnetism with gravimagnetic field having a magnitude which is about 20 orders of magnitude higher than predicted by General Relativity [E186, E125, E121]. Hence there are some reasons to think that gravimagnetic fields might have a surprise in store.

When I am writing this (day later than what is above I have learned that the error bars for the frame-dragging effect are still twice the size of the effect as predicted by GRT. Already this information would have killed TGD inspired model unless the satellite would have been at the equator.

6.7.2 Does horizon correspond to a degenerate four-metric for the rotating counterpart of Schwarzschild metric?

The metric determinant at Schwarzschild radius is non-vanishing. This does not quite conform with the interpretation as an analog of a light-like partonic 3-surface identifiable as a wormhole throat for which the determinant of the induced 4-metric vanishes and at which the signature of the induced metric changes from Minkowskian to Euclidian.

An interesting question is what happens if one makes the vacuum extremal representing imbedding of Schwarzschild metric a rotating solution by a very simple replacement $\Phi \rightarrow \Phi + n\phi$, where Φ is the angle coordinate of homologically trivial geodesic sphere S^2 for the simplest vacuum extremals, and ϕ the angle coordinate of M^4 spherical coordinates. It turns out that Schwarzschild horizon is transformed to a surface at which $\det(g_4)$ vanishes so that the interpretation as a wormhole throat makes sense.

The modification implies that the components $g_{t\phi}$ and $g_{r\phi}$ of the Schwarzschild metric become non-vanishing and $g_{\phi\phi}$ component receives a small modification. Using the notations of the subsection "Imbedding of Reissner-Nordström metric", one has

$$\begin{aligned}
 g_{t\phi} &= \omega_1 n \times \frac{R^2}{4} s_{\phi\phi}^{eff} , \\
 g_{r\phi} &= \partial_{r_M} f n \times \frac{R^2}{4} s_{\phi\phi}^{eff} , \\
 \Delta g_{\phi\phi} &= n^2 \times \frac{R^2}{4} s_{\phi\phi}^{eff} .
 \end{aligned} \tag{6.7.5}$$

It is easy to see that $g_{r\phi}/g_{t\phi}$ is of order $\sqrt{r_S/r}$, $r_S = 2GM$, so that in an excellent approximation $g_{r\phi} = 0$ holds true at large distances and previous considerations related to gravimagnetic fields remain true.

The vanishing of the 4-D metric determinant reduces to that for 3-D metric determinant $det(g_3)$ associated with (t, r, ϕ) . In the case of the Schwartzchild metric this determinant is given by

$$\begin{aligned} det(g_3) &= -g_{\phi\phi} - Ag_{r\phi}^2 + \frac{g_{t\phi}^2}{A} , \\ A &= 1 - \frac{2GM}{r} \equiv 1 - u . \end{aligned} \quad (6.7.6)$$

Since A changes sign at Schwartzchild radius $r_s = 2GM$, the determinant can indeed vanish near r_s . In a good approximation can neglect the contribution of $g_{r\phi}$ in the equation and put $r = r_S$ in the slowly varying functions. This gives

$$\frac{R^2}{4} \omega_1^2 s_{\phi\phi}^{eff} \simeq \lambda^2 \quad (6.7.7)$$

from the condition $u = r_S/r = 1$ applied to the induced metric. This gives

$$\begin{aligned} g_{\phi\phi} &\simeq -r_S^2 \sin^2(\theta) - \frac{n^2}{\omega^2} \lambda^2 , \\ g_{t\phi} &\simeq -\frac{n}{\omega} \lambda^2 . \end{aligned} \quad (6.7.8)$$

The singular surface for which $det(g_3)$ vanishes satisfies the approximate equation

$$u - 1 = \frac{g_{t\phi}^2}{g_{\phi\phi}}(r = r_S) = \frac{n^2 \lambda^4}{\omega^2 r_S^2 \sin^2(\theta) - n^2 \lambda^2} . \quad (6.7.9)$$

Since the left hand side can have both signs, the solution certainly exists but it can happen that part of it is inside and part outside Schwartzchild radius.

$\theta = 0$ allows solution only for $r > r_S$: hence some portion of the surface is always outside r_S . If the condition

$$\lambda^2 > \frac{\omega^2 r_S^2}{n^2} \quad (6.7.10)$$

is satisfied, the surface belongs as a whole to the region $r > r_S$. The singular surface has a cigar like shape approaching sphere $r = \lambda^2 r_S$, $\lambda > 1$ at large quantum number limit $n \rightarrow \infty$. For $n = 0$ no solution is obtained. If one assumes that black hole horizon is analogous to a wormhole contact, only rotating black hole like structures with quantized angular momentum are possible in TGD Universe.

6.7.3 Has strong gravimagnetism been observed?

Physicists M. Tajmar and C. J. Matos and their collaborators working in ESA (European Satellite Agency) have made an amazing claim of having detected strong gravimagnetism with gravimagnetic field having a magnitude which is about 20 orders of magnitude higher than predicted by General Relativity [E125]. If the findings are replicable they mean a revolution in the science of gravity and, as one might hope, force a long-awaited serious reconsideration of the basic assumptions of the dominating super-string approach.

The starting point of the theory of Tajmar and Matos [E186] is the so called Thomson magnetic moment generated in rotating charged super-conductors adding a constant contribution to the exponentially damped Meissner contribution to the magnetic field. This contribution can be understood as being due to the massivation of photons in super-conductors. The modified Maxwell equations are obtained by just adding scalar potential mass term to Gauss law and vector potential mass term to the equation related the curl of the magnetic field to the em current.

The expression for the Thomson magnetic field is given by

$$B = 2\omega_R n_s \times \lambda_\gamma^2, \quad (6.7.11)$$

where ω_R is the angular velocity of superconductor, n_s is charge density of super-conducting particles and $\lambda_\gamma = \hbar/m_\gamma$ is the wave length of a massive photon at rest. In the case of ordinary superconductor one has $\lambda_\gamma = \sqrt{m^*/q^*n_s}$, where $m^* \simeq 2m_e$ and $q^* = -2e$ are the mass and charge of Cooper pair. Hence one has

$$B = -2\frac{m^*}{2e}\omega_R. \quad (6.7.12)$$

Magnetic field extends also outside the super-conductor and by measuring it with a sufficient accuracy outside the super-conductor one can determine the value of the electron mass. Instead of the theoretical value $m^*/2m_e = .999992$ which is smaller than one due to the binding energy of the Cooper pair the value $m^*/2m_e = 1.000084$ was found by Tate [E121]. This inspired the theoretical work generalizing the notion of Thomson field to gravimagnetism and the attempt to explain the anomaly in terms of the effects caused by the gravimagnetic field.

Note that in the case of ordinary matter the equations would lead to an inconsistency at the limit $m_\gamma = 0$ since the value of Thomson magnetic field would become infinite. The resolution of the problem proposed in [E186] is based on the replacement of rotation frequency ω with electron's spin precession frequency $\omega_L = -eB/2m$ so that the consistency equation becomes $B = -B = 0$ for a unique choice $1/\lambda_\gamma^2 = -\frac{q}{m}n$. One could also consider the replacement of ω with electron's cyclotron frequency $\omega_c = 2\omega_L$. To my opinion there is no need to assume that the modified Maxwell's equations hold true in the case of ordinary matter.

Gravimagnetic field

The perturbative approach to the Einstein equations leads to equations which are essentially identical with Maxwell's equations. The g_{tt} component of the metric plays the role of scalar potential and the components g_{ti} define gravitational vector potential. Also the generalization to the super-conducting situation in which graviphotons develop a mass is straightforward. Just add the scalar potential mass term to the counterpart of Gauss law and vector potential mass term to the equation relating the curl of the gravimagnetic field to the gravitational mass current.

In the case of a rotating superconductor Thomson magnetic moment is replaced with its gravimagnetic counterpart

$$B_{gr} = -2\omega_R \rho_m \lambda_g^2 . \quad (6.7.13)$$

Obviously this formula would give rise to huge gravimagnetic fields in ordinary matter approaching infinite values at the limit of vanishing gravitational mass. Needless to say, these kind of fields have not been observed.

Equivalence Principle however suggests that the gravimagnetic field must be assigned with the rotating coordinate frame of the super-conductor. Equivalence principle would state that seeing the things in a rotating reference frame is equivalent of being in a gravimagnetic field $B_{gr} = -2\omega_R$ in the rest frame. This fixes the graviphoton mass to

$$\frac{1}{\lambda_{gr}^2} = \left(\frac{m_{gr}}{\hbar}\right)^2 = G\rho_m . \quad (6.7.14)$$

For a typical condensed matter density parameterized as $\rho_m = Nm_p/a^3$, $a = 10^{-10}$ m this gives the order of magnitude estimate $m_{gr} \sim N^{1/2}10^{-21}/a$ so that graviton mass would be extremely small.

If this is all what is involved, gravimagnetic field should have no special effects. In [E186] it is however proposed that in superconductors a small breaking of Equivalence Principle occurs. The basic assumptions are following.

- (a) Super-conducting phase and the entire system obey separately their gravitational analogs of Maxwell field equations.
- (b) The ad hoc assumption is that for super-conducting phase the sign of the gravimagnetic field is opposite to that for the ordinary matter. If purely kinematic effect were in question so that graviphotons were pure gauge degrees of freedom, the value of m_{gr}^2 should be proportional to ρ_m and $\rho_m - \rho_m^*$ respectively.
- (c) Graviphoton mass is same for both ordinary and super-conducting matter and corresponds to the net density ρ_m of matter. This is essential for obtaining the breaking of Equivalence Principle.

With these assumptions the gravimagnetic field giving rise to acceleration field detected in the rest system would be given by

$$B_{gr}^* = \frac{\rho_m^*}{\rho} \times 2\omega \quad (6.7.15)$$

This is claimed to give rise to a genuine acceleration field

$$g^* = -\frac{\rho_m^*}{\rho} a \quad (6.7.16)$$

where a is the radial acceleration due to the rotational motion.

Explanation for the too high value of measured electron mass in terms of gravimagnetic field

A possible explanation of the anomalous value of the measured electron mass [E121] is in terms of gravimagnetic field affecting the flux Bohr quantization condition for electrons by adding to the electromagnetic vector potential q^*A_{em} gravitational vector potential m^*A_{gr} . By requiring that the quantization condition

$$\oint (m^*v + q^*A_{em} + m^*A_{gr})dl = 0 \quad (6.7.17)$$

is satisfied for the superconducting ring, one obtains

$$B = -\frac{2m}{e}\omega - \frac{m}{e}B_{gr} . \quad (6.7.18)$$

This means that the magnetic field is slightly stronger than predicted and it has been known that this is indeed the case experimentally.

The higher value of the magnetic field could explain the slightly too high value of electron mass as determined from the magnetic field. This gives

$$B_{gr} = \frac{\Delta m_e}{m_e} \times 2\omega = \frac{\Delta m_e}{m_e} \times em_e \times B . \quad (6.7.19)$$

The measurement implies $\Delta m_e/m_e = 9.2 \times 10^{-5}$. The model discussed in [E186] predicts $\Delta m_e/m_e \sim \rho^*/\rho$. The prediction is about 23 times smaller than the experimental result.

6.7.4 Is the large gravimagnetic field possible in TGD framework?

TGD allows to consider several alternative solutions for the claimed effect.

- (a) TGD predicts the possibility of classical electro-weak fields at larger space-time sheets. If these couple to Cooper pairs generate exotic weak charge at super-conducting space-time sheets the Bohr quantization conditions modify the value of the magnetic field. Exotic weak charge would however mean also exotic electronic em charge so that this option is excluded. It would also require that the Z^0 charge of test bodies used to measure the acceleration field is proportional to their gravitational mass.
- (b) TGD suggests a hierarchy of strong gravities analogous to those generated by spin 2 mesons. These gravitons behave like massless particles below the appropriate Compton length. This Compton length can be arbitrarily long at higher levels of dark matter hierarchy. Electrons do not however couple to these gravitons so that this option does not seem to work.
- (c) The rotation of the super-conductor would correspond quite concretely to a rotation of the corresponding space-time sheet. Also the space-time sheet defining the magnetic and gravito-magnetic body of the system could participate to the rotation. Since the rotation affects the shape of the space-time surface the breaking of the Equivalence Principle is unavoidable. This predicts gravitational analogs of the effects found in rotating magnetic systems [H9], for instance the radial gravitational field $E^{gr} = vB^{gr}$ but does not seem to be enough to understand what is involved.

- (d) As already noticed, the failure of Equivalence Principle could be understood if the gravimagnetic fields of super-conducting and ordinary matter do not interfere. Many-sheeted space-time suggest the lack of interference is caused by the fact that super-conducting and ordinary matter reside at different space-time sheets. If the measurement of the gravimagnetic field (or rather its change causing Faraday effect and tangential acceleration) is carried out at either space-time sheet a breaking of Equivalence Principle is observed. In the similar manner magnetic field is affected via Bohr rules for angular momentum and gives rise to the desired effect. In this framework the model of [E186] looks rather plausible one.
- (e) Induced field concept implies extremely tight correlations between induced classical gauge fields and induced gravitational field and one expects that the magnetic field associated with the rotating super-conductor gives rise to a gravimagnetic field so that ordinary Meissner and Thompson effects would force their gravitational counterparts. This is not at all obvious in standard physics framework. It turns out however that the predicted gravimagnetic field is far too small in the simplest model.
- (f) The dependence of the mass of graviphoton on magnetic penetration length involves Planck constant. TGD predicts a hierarchy of Planck constants $\hbar(k) = \lambda^k \hbar_0$. This means that for given value of m_γ and m_{gr} there is a hierarchy of increasing photon and graviton rest Compton lengths defining the penetration depths for superconductors. It turns out that if graviphotons are dark, one can indeed understand the huge value of gravimagnetic field in TGD framework.

Key observations

Two observations are essential for what follows.

- (a) It would seem that the superposition of the of the gravimagnetic fields of the superconducting and ordinary ordinary matter gives the net gravimagnetic field which would not give any anomalous effects. The breaking of Equivalence Principle could be understood if these fields do not interfere in the experimental situation. In TGD framework the separation of ordinary matter and Cooper pairs at separate space-time sheets can explain the absence of the interference.
- (b) In order to obtain large enough an effect one must assume that ρ_m^* identifiable as that part of matter which goes to super-conducting space-sheets from those containing ordinary matter contains an additional contribution besides Cooper pairs. In TGD framework the presence of also other particles besides Cooper pairs at super-conducting space-time sheets could increase the value of ρ_m^* by a factor of order 23. For instance, the space-time sheet could contain $23m_e/m_p$ protons $23m_e/Am_p$ heavier atoms per electron.

Could gravimagnetism and breaking of Equivalence Principle be forced by the induced field concept?

The safest starting point seems to be that the separation of super-conducting phase to its own space-time sheet induces the reduction $\rho_m \rightarrow \rho_m - \rho_m^*$ at the space-time sheet of ordinary matter. If the graviphoton is not modified correspondingly, one has in inertial frame effective B_{gr} obtained by the replacement $\rho_m \rightarrow \rho_m - \rho_m^*$ in the defining formula as one goes to rest system. This gives also the sign of the gravimagnetic field correctly. The task is to find whether the notion of induced gauge field is consistent with or can even predict the generation of B_{gr} .

TGD predicts an extremely tight correlation between various kinds of classical fields so that the Thomson magnetic field associated with super-conductor is expected to be accompanied by a gravimagnetic field which need not have a value consistent with the Equivalence Principle.

The assumption that the space-time sheet in question has a CP_2 projection belonging to either Lagrange manifold Y^2 of CP_2 , say homologically trivial geodesic sphere, or to a non-trivial geodesic sphere allows to model the situation in a simple manner. For the homologically trivial

sphere field equations are identically satisfied by the vacuum extremal property. The treatments are essentially identical so that the consideration is restricted to the non-vacuum case for definiteness.

For the simplest cylindrically symmetric situations CP_2 coordinates can be expressed as $(\Theta = f(\rho), \Phi = \omega t - n\phi)$ cylindrical coordinates for M^4 . Kähler magnetic field would be $g_K B_{\rho\phi}^K = \sin(\Theta)\rho n$ and gravimagnetic vector potential would have the non-vanishing component $A_\phi^{gr} = g_{t\phi} = -R^2 \sin^2(\Theta)n\omega$. This would give $B_{\rho\phi}^{gr} = -2R^2\omega \sin(\Theta)g_K B_{\rho\phi}^K$. For the ratio $2m_e B_{gr}/g_K B^K$ one would obtain

$$\frac{2m_e B^{gr}}{g_K B^K} = -2R^2\omega m_e \sin(\Theta) . \quad (6.7.20)$$

Equivalence Principle would require $2m_e B_{gr}/eB_{em} = 1$ so that one would have

$$2R^2\omega m_e \sin(\Theta) = -x . \quad (6.7.21)$$

where one has $eB_{em} \equiv x g_K B_K$. The value of x is completely fixed for homologically non-trivial geodesic sphere. In the appendix of [K87] it is shown to be $x = 3 - 2\sin^2(\theta_W)$, where $\sin^2(\theta_W) \simeq .23$ denotes Weinberg angle.

The condition is impossible to satisfy in precise sense since $\sin(\Theta)$ cannot be constant so that at least a small breaking of Equivalence Principle is unavoidable but probably does not offer an explanation of the effect. The assumption that that B^K is constant implies $\sin(\Theta) = \alpha + \beta\rho^2$ and implies that also B_{gr} is constant in the lowest order approximation.

The condition above would require an extremely large value of the parameter ω of order $\omega \sim 1/m_e R^2 \sim 10^{19}/R$. This would imply that the induced metric has Euclidian signature by $g_{tt} < 1 - R^2\omega^2 \sin^2(\Theta) < 0$. It would also imply a huge Kähler electric field $g_K E^K = g_K B_{\rho\phi}^K \omega/n$. The situation is obviously same also in the case that the value gravimagnetic field has the value needed to explain the experimental findings of Tate.

Could the large gravimagnetic field correspond to dark graviphotons?

A possible way out of the difficulty is based on the assumption that the graviphotons are dark and have a large value of Planck constant increasing in turn the value of λ_{gr} and thus gravimagnetic field.

The TGD based model for the hierarchy of Planck constants associated with the dark matter hierarchy assumes that the various values $\hbar = \lambda^k \hbar_0$, $\lambda \simeq 2^{11}$ correspond at the level of imbedding space to a book like structure. Different algebraic extensions of rational numbers and p-adic numbers correspond to different values of Planck constant and copies of imbedding space. The metrics for these different copies differ by a scaling in M^4 degrees of freedom and are glued together by along a subset of rationals such that the distances of the glued points from the common origin of glued copies of M^4 are identical. The configuration space of 3-surfaces decomposes into sectors labeled by unions of future and past light cones and the dips of these light cones define the preferred origins.

The key observation is that the role of Planck constant in the d'Alembertian at the level of the imbedding space is to multiply M^4 part of the d'Alembertian but leave CP_2 part unaffected. This is in accordance with the fact that induced spinor connection corresponds to gauge couplings not involving \hbar and also with the fact that the scaling of CP_2 spinor connection does not make sense. At the level of induced spinor fields Planck constant in turn corresponds to the scaling factor of the M^4 part of the induced metric.

Hence it is natural to assume that contravariant M^4 metric scales as $\hbar^2(k) \propto \lambda^{2k}$. $\lambda \simeq 2^{11}$ as a function of \hbar whereas CP_2 metric is not affected. This would mean that M^4 contribution to the

induced covariant metric scales as λ^{-2k} : this implies that Kähler action can be seen as a function of the value of Planck constant and thus codes for the higher level corrections in powers of \hbar . This allows to have TGD to predict a series of higher order corrections in powers of \hbar although the perturbation theory defined by the configuration space functional integral could reduce to the lowest order approximation as the general number theoretic and integrability arguments inspired by symmetric space property of the zero mode constant sectors of the configuration space suggest.

Using scaled coordinates in which M^4 metric is represented by a unit tensor, this geometrization of the dynamics of Planck constant would mean an effective scaling $R^2 \rightarrow \lambda^{2k} R^2$ for the CP_2 radius R increasing the contribution of the CP_2 metric to the induced metric. This is just what is needed to preserve the Minkowskian signature of the induced metric in ultrastrong gravimagnetic fields.

For a dynamical Planck constant the expression for the parameter ω in the induced metric would become

$$\omega \sim \frac{m_e}{\lambda^{2k} R^2} \sim \frac{10^{19}}{\lambda^{2k} R} .$$

The requirement that the signature of the induced metric is Minkowskian gives

$$g_{tt} = 1 - R^2 \lambda^{2k} \omega^2 > 0 .$$

This boils down to the conditions

$$\begin{aligned} \lambda^k &> \frac{x}{R m_e} \sim 10^{19} x , \\ \omega &\leq \frac{m_e}{x^2} , \end{aligned} \tag{6.7.22}$$

where x is the numerical constant defined earlier. Using $\lambda \simeq 2^{11}$ this would give $k \geq 6$. The hierarchy of dark matter levels associated with living matter contains $k = 7$ levels relevant to human consciousness and $k = 7$ corresponds to a characteristic time scale of about 50 years [K26].

One can deduce an estimate for the dark graviphoton mass by assuming the value for λ_{gr} implied by B_{gr} necessary to explain the anomaly observed by Tate [E121]. This would give

$$m_{gr} \sim \sqrt{\frac{N}{10}} \times \frac{1}{10^2 a} , \tag{6.7.23}$$

where gravitational mass density has been parameterized as $\rho_m = N m_p / a^2$, $a = 10^{-10}$ m. Note that the rest energy is above the thermal threshold at room temperature. The mass corresponds to an ordinary Compton length of order 10 nm, size scale for Cooper pairs and cell membrane thickness which emerges as a fundamental length scale characterizing Cooper pairs in the TGD based model for high T_c super-conductor [K15, K16]. TGD inspired model of living matter predicts that also the magnetic structures corresponding to scaled up variants of cell membrane having sizes scaled up by λ^k are fundamental [K26].

A possible physical interpretation for the origin of the ordinary graviphoton mass would be that the confinement of longitudinal graviton inside a magnetic flux tube of thickness $L(151) = 10$ nm gives it a non-vanishing effective rest mass due to the confinement in transversal degrees of freedom which is same for all scaled up variants. The effect would be completely analogous to the generation effective photon mass in waveguide. For $k = 6$ level the Compton length of the dark graviphoton would be about 10^{11} m, the size scale of the solar system, so that a genuine long range interaction would be in question.

The gravitational mass of the photon associated with super-conductivity would be enormous for ordinary value of Planck constant. For the ordinary value of Planck constant the mass would be around $m_\gamma \simeq 10^{-3}m_e$ and for $k = 6$ one would have $m_\gamma \simeq 10^{16}m_e$. This weird implication suggests that super-conducting photons are ordinary. In this case the wavelength would be of order one nanometer and of the same order of magnitude as the wavelength of ordinary graviphoton, which supports the interpretation that transversal confinement to magnetic flux tubes gives rise to the mass in both cases.

The model ties together both electron mass scale, the order of magnitude for the size of Cooper pairs, cell membrane thickness crucial for high T_c super-conductivity, and the size scale of the solar system which in the case finite space-time sheets would give natural estimate for the much lower mass scale of the ordinary graviphoton. This raises the hope that the model might have at least something to do with reality. The model also suggest that dark gravimagnetism might be of importance in living systems.

Other explanations

One can consider also other explanations for the strong gravimagnetic effect.

1. Are p-adically scaled variants of graviton in question?

The recent view about coupling constant evolution assumes that Kähler coupling strength is invariant under p-adic coupling constant evolution whereas gravitational constant is proportional to L_p^2 [K5]. In this framework gravitons correspond to the Mersenne prime $M_{127} = 2^{127} - 1$ defining the p-adic length scale of electron. The motivation comes from the hypothesis that gauge bosons in general correspond to Mersenne primes and that M_{127} is the largest Mersenne prime, which does not correspond to completely super-astrophysical p-adic length scale.

One can however consider the possibility that in some situations -perhaps in the case of super-conductor - the space-time sheet mediating gravitational interaction - gravitonic field body - corresponds to some larger prime. The scaling of G by a factor 10^{20} would require scaling of electronic p-adic length scale by a factor of order 10^{10} to give 2.5 cm length scale.

2. Super-symplectic strong gravitation

TGD predicts also super-symplectic spin two quanta and these give rise to strong gravitation with G or order L_p^2 . Super-symplectic bosons are responsible for the non-perturbative aspects of hadron physics [K56, K52] and super-symplectic strong gravitation relates very closely to the stringy description of hadrons. There are good reasons to believe that strong gravitation prevails only at the hadronic space-time sheet. Also black-holes would in TGD framework correspond to gigantic hadron like structures resulting when the hadronic space-time sheets have fused together to form single highly entangled string like structure [K52]. Thus it would seem that super-symplectic strong gravitation cannot give rise to a gravimagnetic effect.

6.8 Some differences between GRT and TGD

In the following some effects possibly differentiating between GRT and TGD are discussed.

6.8.1 Do neutrinos travel with superluminal speed?

The newest particle physics rumour has been that the CERN OPERA team working in Gran Sasso, Italy has reported 6.1 sigma evidence that neutrinos move with a super-luminal speed. The total travel time is measured in milliseconds and the deviation from the speed of the light is nanoseconds meaning $\Delta c/c \simeq 10^{-6}$ which is roughly 10^3 times larger than the uncertainty 4.5×10^{-9} in the measured value of the speed of light. If the result is true it means a revolution in the fundamental physics. There is now an article by OPERA collaboration [H4] in arXiv so that superluminal neutrinos are not a rumour anymore. Even the finnish tabloid "Iltalehti"

reacted to the news and this is really something unheard! Maybe the finding could even stimulate colloquium in physics department of Helsinki University!

The superluminal speed of neutrino has stimulated intense email debates and blog discussions. The reactions to the potential discovery depend on whether the person can imagine some explanation for the finding or not. In the latter case the reaction is denial: most physics bloggers have chosen this option for understandable reasons. What else could they do? Personally I cannot take tachyonic neutrinos seriously but I would not however choose the easy option and argue that the result is due to a bad experimentation as Lubos and Jester do. The six sigma statistics does not leave much room for objections but there could of course be some very delicate systematical error involved. Lubos wrote quite an interesting piece about possible errors of this kind and classified the possible errors to timing errors either at CERN or Italy or to errors in distance measurement.

Basic data

The neutrinos used are highly relativistic having average energy 17 GeV much larger than the mass scale of neutrinos of order .1 eV. The distance between CERN and Gran Sasso is roughly 750 km, which corresponds to the time of travel equal to $T = 2.4$ milliseconds. The nasty neutrinos arrived to Gran Sasso $\Delta T = 60.7 \pm 6.9$ (statistical) ± 7.4 (systematic) ns before they should have done so. This time corresponds to a distance $\Delta L = 18$ m. From this is clear that the distance and timing measurements must be extremely accurate. The claimed distance precision is 20 cm [H4].

Experimentalists tell that they have searched for all possible systematic errors that they are able to imagine. The relative deviation of neutrino speed from the speed of light is

$$\frac{c - v}{v} = (5.1 \pm 2.9) \times 10^{-5} ,$$

which is much larger than the uncertainty related to the value of the speed of light. The effect does not depend on neutrino energy. 6.1 sigma result is in question so that it can be a statistical fluctuation with probability of 10^{-9} in the case that there is no systematic error.

The result is not the first of this kind and the often proposed interpretation is that neutrinos behave like tachyons. The following is the abstract [H5] of the article giving a summary about the earlier evidence that neutrinos can move faster than the speed of light.

From a mathematical point of view velocities can be larger than c . It has been shown that Lorentz transformations are easily extended in Minkowski space to address velocities beyond the speed of light. Energy and momentum conservation fixes the relation between masses and velocities larger than c , leading to the possible observation of negative mass squared particles from a standard reference frame. Current data on neutrino mass squared yield negative values, making neutrinos as possible candidates for having speed larger than c . In this paper, an original analysis of the SN1987A supernova data is proposed. It is shown that all the data measured in '87 by all the experiments are consistent with the quantistic description of neutrinos as combination of superluminal mass eigenstates. The well known enigma on the arrival times of the neutrino bursts detected at LSD, several hours earlier than at IMB, K2 and Baksan, is explained naturally. It is concluded that experimental evidence for superluminal neutrinos was recorded since the SN1987A explosion, and that data are quantitatively consistent with the introduction of tachyons in Einstein's equation.

TGD inspired model

This kind of effect is actually one of the basic predictions of TGD reflecting the differences between kinematics of relativities based on a view about space-time as abstract manifold and TGD in which one has sub-manifold gravitation. and emerged for more than 20 years ago. Also several Hubble constants are predicted and explanation for why the distance between Earth and

Moon seems to increasing as an apparent phenomenon emerges. There are many other strange phenomena which find an explanation [K85, K73, K72].

It is sub-manifold geometry which allows to fuse the good aspects of both special relativity (the existence of well-defined conserved quantities due to the isometries of imbedding space) and general relativity (geometrization of gravitation in terms of the induced metric). As an additional bonus one obtains a geometrization of the electro-weak and color interactions and of standard model quantum numbers. The choice of the imbedding space is unique. The new element is the generalization of the notion of space-time: space-time identified as a four-surface has shape as seen from the perspective of the imbedding space $M^4 \times CP_2$. The study of field equations leads among other things to the notion of many-sheeted space-time.

For many-sheeted space-time light velocity is assigned to light-like geodesic of space-time sheet rather than light-like geodesics of imbedding space $M^4 \times CP_2$. The effective velocity determined from time to travel from point A to B along different space time sheets is different and therefore also the signal velocity determined in this manner. The light-like geodesics of space-time sheet corresponds in the generic case time-like curves of the imbedding space so that the light-velocity is reduced from the maximal signal velocity. Space-time sheet is bumpy and wiggled so that the path is longer. Each space-time sheet corresponds to different light velocity as determined from the travel time. The maximal signal velocity is reached only in an ideal situation when the space-time geodesics are geodesics of Minkowski space.

1. Estimate fro the light velocity from Robertson-Walker cosmology

Robertson-Walker cosmology imbedded as 4-surface (this is crucial!) in $M^4 \times CP_2$ [K73] gives a good estimate for the light velocity in cosmological scales.

(a) One can use the relationship

$$\frac{da}{dt} = g_{aa}^{-1/2}$$

relating the curvature radius a of RW cosmology space (equal to M^4 light-cone proper time, the light-like boundary of the cone corresponds to the moment of Big Bang) and cosmic time t appearing in Robertson-Walker line element

$$ds^2 = dt^2 - a^2 d\sigma_3^2 .$$

(b) If one believes that Einstein's equations in long scales, one obtains

$$\frac{8\pi G}{3} \times \rho = \frac{(g_{aa}^{-1} - 1)}{a^2} .$$

One can solve from this equation g_{aa} and therefore get an estimate the cosmological speed of light -call it $c_{\#}$ as

$$c_{\#} = (g_{aa})^{1/2} .$$

(c) By plugging in the estimates

$$a \simeq t \simeq 13.8 \times Gy \quad (\text{the actual value is around } 10 \text{ Gy}) ,$$

$$\rho \simeq \frac{5m_p}{m^3} \quad (5 \text{ protons per cubic meter}) ,$$

$$G = 6.7 \times 10^{-11} m^3 kg^{-1} s^{-2} ,$$

one obtains the estimate

$$c_{\#} = (g_{aa})^{1/2} \simeq .73 ,$$

What can one conclude from the estimate?

- (a) The result leaves a lot of room to explain various anomalies (problems with determination of Hubble constant, apparent growth of the Moon-Earth distance indicated by the measurement of distance by laser signal,...). The effective velocity can depend on the scale of space-time sheet along which the relativistic particles arrive (and thus on distance distinguishing between OPERA experiment and SN1987A), it can depend on the character of ultra relativistic particle (photon, neutrino, electron,...), etc. The effect is testable by using other relativistic particles -say electrons.
- (b) The energy independence of the results fits perfectly with the predictions of the model since the neutrinos are relativistic. There can be dependence on length scale: in other words distance scale and this is needed to explain SN1987A -CERN difference in $\Delta c/c$. For SN1987A neutrinos were also relativistic and travelled a distance is $L=cT=168,000$ light years and the neutrinos arrived about $\Delta T = 2 - 3$ hours earlier than photons (see this). This gives $\Delta c/c = \Delta T/T \simeq .8 - 1.2 \times 10^{-6}$ which is considerably smaller than for the recent experiment. Hence the tachyonic model fails but scale and particle dependent maximal signal velocity can explain the findings easily.
- (c) The space-time sheet along which particles propagate would most naturally correspond to a small deformation of a "massless extremal" ("topological light ray" [K11]) assignable to the particle in question. Many-sheeted space-time could act like a spectroscop forcing each (free) particle type at its own kind of "massless extremal". The effect is predicted to be present for *any* relativistic particle. A more detailed model requires a model for the propagation of the particles having as basic building bricks wormhole throats at which the induced metric changes its signature from Minkowskian to Euclidian: the Euclidian regions have interpretation in terms of lines of generalized Feynman graphs. The presence of wormhole contact between two space-time sheets implies the presence of two wormhole throats carrying fermionic quantum numbers and the massless extremal is deformed in the regions surrounding the wormhole throat. At this stage I am not able to construct detailed model for deformed MEs carrying photons, neutrinos or some other relativistic particles.

2. Can one understand SN1987A-OPERA difference in TGD framework?

The challenge for sub-manifold gravity approach is to understand the SN1987A-OPERA difference qualitatively. Why neutrino (and any relativistic particle) travels faster in short length scales?

- (a) Suppose that this space-time sheet is massless extremal topologically condensed on a magnetic flux tube thickened from a string like object $X^2 \times Y^2$ subset $M^4 \times CP_2$ to a tube of finite thickness. Suppose that this means that the properties of the magnetic flux tube determine the maximal signal velocity. The longer and less straight the tube, the slower the maximal signal velocity since the light-like geodesic along it is longer in the induced metric (time-like curve in $M^4 \times CP_2$). There is also rotation around the flux lines increasing the path length: see below.
- (b) For a planar cosmic string (X^2 is just plane of M^4) the maximal signal velocity would be as large as it can be but is expected to be reduced as the flux tube develops 4-D M^4 projection. In thickening process flux is conserved so that B scales as $1/S$, S the transversal area of the flux tube. Magnetic energy per unit length scales as $1/S$ and energy conservation requires that the length of the flux tube scales up like S during cosmic expansion. Flux tubes become longer and thicker as time passes.
- (c) The particle -even neutrino!- can rotate along the flux lines of electroweak fields inside the flux tube and this makes the path longer. The thicker/longer the flux tube,- the longer the path- the lower the maximal signal velocity. I emphasize that classical Z^0 and W fields (and also gluon fields!) are the basic prediction of TGD distinguishing it from standard model: again the notion of induced gauge field pops up!
- (d) Classically the cyclotron radius is proportional to the cyclotron energy. For a straight flux tube there is free relativistic motion in longitudinal degrees of freedom and cyclotron

motion in transversal degrees of freedom and one obtains essentially harmonic oscillator like states with degeneracy due to the presence of rotation giving rise to angular momentum as an additional quantum number. If the transversal motion is non-relativistic, the radii of cyclotron orbits are proportional to a square root of integer. In Bohr orbitology one has quantization of the neutrino speeds: wave mechanically the same result is obtained in average sense. Fermi statistics implies that the states are filled up to Fermi energy so that several discrete effective light velocities are obtained. In the case of a relativistic electron the velocity spectrum would be of form

$$c_{eff} = \frac{L}{T} = \frac{c_{\#}}{\sqrt{1 + n\hbar \frac{eB}{m}}} .$$

Here L denotes the length of the flux tube and T the time taken by a motion along a helical orbit when the longitudinal motion is relativistic and transversal motion non-relativistic. In this case the spectrum for c_{eff} is quasi-continuous. Note that for large values of $\hbar = n\hbar_0$ (in TGD Universe) quasicontinuity is lost and in principle the spectrum might allow to the determination of the value of \hbar .

- (e) Neutrino is a mixture of right-handed and left handed components and right-handed neutrino feels only gravitation where left-handed neutrino feels long range classical Z^0 field. In any case, neutrino as a particle having weakest interactions should travel faster than photon and relativistic electron should move slower than photon. One must be however very cautious here. Also the energy of the relativistic particle matters.

This would be the qualitative mechanism explaining why the neutrinos (and relativistic particles in general) travel faster in short scales. The model can be also made quantitative since the cyclotron motion can be understood quantitatively once the field strength is known.

Here brane-theorists trying to reproduce TGD predictions are in difficulties since the notion of induced gauge field is required besides that of induced metric. Also the geometrization of classical electro-weak gauge fields in terms of the spinor structure of imbedding space is needed. It is almost impossible to avoid $M^4 \times CP_2$ and TGD.

3. What about electrons and photons?

If I were a boss at CERN, I would suggest that the experiment should be carried out for relativistic electrons whose detection would be much easier and for which one could use much shorter scale.

- (a) Could one use both photon and electron signal simultaneously to eliminate the need to measure precisely the distance between points A and B.
- (b) Can one imagine using mirrors for photons and relativistic electrons and comparing the times for $A \rightarrow B \rightarrow A$?

As a matter fact, there is an old result by electric engineer Obolensky [H2] that I have mentioned earlier [K35], and which states that in circuits signals seem to travel at superluminal speed. The study continues the tradition initiated by Tesla who started the study of what happens when relays are switched on or off in circuits.

- (a) The experimental arrangement of Obolensky suggest that that part of circuit - the base of the so called Obolensky triangle- behaves as a single coherent quantum unit in the sense that the interaction between the relays defining the ends of the base is instantaneous: the switching of the relay induces simultaneously a signal from both ends of the base.
- (b) There are electromagnetic signals propagating with velocities c_0 (with values $271 \pm 1.8 \times 10^6$ m/s and $278 \pm 2.2 \times 10^6$ m/s) and c_1 (200.110×10^6 m/s): these velocities are referred to as Maxwellian velocities and they are below light velocity in vacuum equal to $c = 3 \times 10^8$ m/s. c_0 and c_1 would naturally correspond to light velocities affected by the interaction of light with the charges of the circuit.

- (c) There is also a signal propagating with a velocity c_2 ($(620 \pm 2.7) \times 10^6$ m/s), which is slightly more than twice the light velocity in vacuum. Does the identification $c_2 = c_{max}$, where c_{max} is the maximal signal velocity in $M^4 \times CP_2$, make sense? Could the light velocity c in vacuum correspond to light velocity, which has been reduced from the light velocity $c_{\#} = .73c_{max}$ in cosmic length scales due to the presence of matter to $c_{\#} = .48c_{max}$. Note that this interpretation does not require that electrons propagate with a super-luminal speed.
- (d) If Obolensky's findings are true and interpreted correctly, simple electric circuits might allow the study of many-sheeted space-time in garage!

If these findings survive they will provide an additional powerful empirical support for the notion of many-sheeted space-time and could be for TGD what Mickelson-Morley was for Special Relativity. It is sad that TGD predictions must still be verified via accidental experimental findings. It would be much easier to do the verification of TGD systematically. In any case, Laws of Nature do not care about science policy, and I dare hope that the mighty powerholders of particle physics are sooner or later forced to accept TGD as the most respectable known candidate for a theory unifying standard model and General Relativity.

4. Additional support for TGD view from ICARUS experiment

Tommaso Dorigo [C3] managed to write the hype of his life about super-luminal neutrinos. This kind of accidents are unavoidable and any blogger sooner or later becomes a victim of such an accident. To my great surprise Tommaso described in a completely uncritical and hypeish manner a study by ICARUS group [C10] in Gran Sasso and concluded that it definitely refutes OPERA result. This is of course a wrong conclusion and based on the assumption that special and general relativity hold true as such and neutrinos are genuinely superluminal.

Also Sascha Vongehr [C2] wrote about ICARUS as a reaction to Tommaso's surprising posting but this was purposely written half-joking hype claiming that ICARUS proves that neutrinos travel the first 18 meters with a velocity at least 10 times higher than c . Sascha also wrote a strong criticism of the recent science establishment. The continual uncritical hyping is leading to the loss of the respectability of science and I cannot but share his views. Also I have written several times about the ethical and moral decline of the science community down to what resembles the feudal system of middle ages in which Big Boys have first night privilege to new ideas: something which I have myself had to experience many times.

What ICARUS did was to measure the energy distribution of muons detected in Gran Sasso. This result is used to claim that OPERA result is wrong. The measured energy distribution is compared with the distribution predicted assuming that Cohen-Glashow interpretation [C7] is correct. This is an extremely important ad hoc assumption without which the ICARUS demonstration fails completely.

- (a) Cohen and Glashow assume a genuine super-luminality and argue that this leads to the analog of Cherenkov radiation leading to a loss of neutrino energy: 28.2 GeV at CERN is reduced to average of 12.1 GeV at Gran Sasso. From this model one can predict the energy distribution of muons in Gran Sasso.
- (b) The figure 2 in Icarus preprint demonstrates that the distribution assuming now energy loss fits rather well the measured energy distribution of muons. The figure does not show the predicted distribution but the figure text tells that the super-luminal distribution would be much "leaner", which one can interpret as a poor fit.
- (c) From this ICARUS concludes that neutrinos cannot have exceeded light velocity. The experimental result of course tells only that neutrinos did not lose energy: about the neutrino velocity it says nothing without additional assumptions.

At the risk of boring the reader I repeat: the fatal assumption is that a genuine super-luminality is in question. The probably correct conclusion from this indeed is that neutrinos would lose their energy during their travel by Cherenkov radiation.

In TGD framework situation is different (see this, this, this, and also the article [L6]). Neutrinos move in excellent approximation velocity which is equal to the maximal signal velocity but slightly below it and without any energy loss. The maximal signal velocity is however higher for a neutrino carrying space-time sheets than those carrying photons- a basic implication sub-manifold gravity. I have explained this in detail in previous postings and in the article [L6].

The conclusion is that ICARUS experiment supports the TGD based explanation of OPERA result. Note however that at this stage TGD does not predict effective superluminality but only allows and even slightly suggests it and provides also a possible explanation for its energy independence and dependences on length scale and particle. TGD suggests also new tests using relativistic electrons instead of neutrinos.

It is also important to realize that the the apparent neutrino super-luminality -if true- provides only single isolated piece evidence for sub-manifold gravity. The view about space-time as 4-surface permeates the whole physics from Planck scale to cosmology predicting correctly particle spectrum and providing unification of fundamental interactions, it is also in a key role in TGD inspired quantum biology and also in quantum consciousness theory inspired by TGD.

5. OPERA confirms super-luminal velocity of neutrinos

OPERA collaboration has published an eprint Measurement of the neutrino velocity with the OPERA detector in the CNGS beam [C12] providing further support for the claim that neutrinos move faster than photons. Tommaso Dorigo describes the improved measurements in this blog. The abstract of the preprint is following.

The OPERA neutrino experiment at the underground Gran Sasso Laboratory has measured the velocity of neutrinos from the CERN CNGS beam over a baseline of about 730 km with much higher accuracy than previous studies conducted with accelerator neutrinos. The measurement is based on high-statistics data taken by OPERA in the years 2009, 2010 and 2011. Dedicated upgrades of the CNGS timing system and of the OPERA detector, as well as a high precision geodesy campaign for the measurement of the neutrino baseline, allowed reaching comparable systematic and statistical accuracies. An early arrival time of CNGS muon neutrinos with respect to the one computed assuming the speed of light in vacuum of $(57.8 \pm 7.8 \text{ (stat.)} + 8.3 - 5.9 \text{ (sys.)})$ ns was measured. This anomaly corresponds to a relative difference of the muon neutrino velocity with respect to the speed of light $(v - c)/c = (2.37 \pm 0.32 \text{ (stat.) (sys.)}) \times 10^{-5}$. The above result, obtained by comparing the time distributions of neutrino interactions and of protons hitting the CNGS target in 10.5 μ s long extractions, was confirmed by a test performed using a beam with a short-bunch time-structure allowing to measure the neutrino time of flight at the single interaction level.

In the new experiment the spacing between pulses was only 3 ns. This implies that pulse shape and duration cannot explain the earlier OPERA result as a measurement error. Effectively one studies individual neutrinos. Pulse shape and size has provided for the main stream theorist a cheap and fast way to explain the observation out from his mindscape. Certainly this finding also kills a large class of explanations for neutrino super-luminality. Of course, one must still keep mind open for some delicate measurement error. Lubos suggests that there is a systematic error in GPS system, other colleagues have not taken this option seriously.

Second new finding is that there is a "jitter" in travel times: the arrival times vary within 50 ms range which corresponds to a distance about 15 m. The shortening of travel times is not however not less than 40 ns from that when neutrinos move with light velocity as the figure that can be found from the posting of Phil Gibbs demonstrates [C6]. Is the determination of the arrival time inaccurate? Or does the neutrino velocity have values above minimum velocity larger than c ?

- (a) In TGD framework this could mean that the space-time sheet along which neutrino arrives would vary from neutrino to neutrino. The simplest possibility is that its length varies and velocity is constant: this does not look totally implausible.
- (b) Also the state of neutrino inside space-time sheet could vary from neutrino to neutrino. Classical long ranged Z^0 fields are one of the basic predictions of TGD and in the earlier

posting I proposed that neutrino feels classical Z^0 magnetic field and arrives along cyclotron orbit. This would give a discrete spectrum of arrival velocities as

$$v = \frac{c\#}{[1 + n \times \hbar \times \frac{Qz(\nu)gzBz}{m_\nu}]^{1/2}}$$

with $n = 0, 1, 2, \dots$. For some value of n the velocity would become sub-luminal. If \hbar is large enough, the discrete spectrum could be seen in the arrival times. This spectrum does not however look an attractive explanation for the jitter for which spectrum seems to be above minimum value rather than below maximum value.

6. Answers to questions by Eugen Stefanovich

Eugen Stefanovich made in my blog some questions allowing to bring additional details to the overall picture. The answers should reveal what the questions where.

- (a) There is no energy dependence. There is particle and scale dependence. There is an argument suggesting that the velocity is higher for neutrinos than for photon and for photon higher than for relativistic electron. The difference between neutrino families is expected to be small if the proposed mechanism based on electroweak interactions is correct: this because of the universality/ flavor independence of electroweak interactions.
- (b) The dependence on the length scale of the orbit should be via p-adic length scale and therefore piecewise constant. This kind of jump would come at half octaves of basic length scale and might be therefore observable. Increasing or decreasing the distance between CERN and receiver by a factor of $\sqrt{2}$ could reveal this effect.
- (c) The distance between CERN and Gran Sasso is 750 km. If I understood correctly, the distance travelled by neutrinos in MINOS experiment is 734 km) [C5]. 734 km is slightly above p-adic length scale $L(151 + 2 \times 46) = 2^{46} \times L(151) = 2^{46} \times 10^{-8}$ meters = $L(243) = 703$ km. If I take p-adic length scale hypothesis seriously then the result should be the same.
- (d) In cosmic scales one can estimate maximal signal velocity for photon: a very rough estimate using imbedding of Roberston-Walker cosmology as Lorentz invariant 4-surface is 73 per cent from absolute maximum (for light-like geodesic of M^4). For SN1987A neutrinos and photons the velocity difference would be much smaller than in shorter scales suggesting that the deviation from absolute maximum approaches to zero at very long distance scales.
 - i. One possibility is

$$\Delta[\frac{v}{c}(p)] \propto L_p^{-n} \propto p^{-n/2} \quad ,$$

where $L_p \propto p^{1/2}$ is the p-adic length scale. By p-adic length scale hypothesis the p-adic prime p satisfies $p \simeq 2^k$. n is an exponent which need not be an integer.

- ii. Second suggestive possibility is logarithmic dependence on L_p and therefore on p .

Superluminal neutrinos cannot be tachyons

New Scientist reported about the sad fate of the tachyonic explanation of neutrino superluminality. The argument is extremely simple.

- (a) One can start by assuming that a tachyon having negative mass squared: $m(\nu)^2 < 0$ and assume that super-luminal velocity is in question. The point is that one knows the value of the superluminal velocity $v(1 + \epsilon)c$, $\epsilon \simeq 10^{-5}$. One can calculate the energy of the neutrino as

$$E = |m(\nu)|[-1 + v^2/(v^2 - 1)]^{1/2} \quad ,$$

$|m(\nu)| = (-m(\nu)^2)^{1/2}$ is the absolute value of formally imaginary neutrino mass.

(b) In good approximation one can write

$$E = |m(\nu)|[-1 + (2\epsilon^{-1/2})^{1/2}] \simeq |m(\nu)|(2\epsilon)^{-1/2} .$$

The order of magnitude of $|m(\nu)|$ is not far from one eV - this irrespective of whether neutrino is tachyonic or not. Therefore the energy of neutrino is very small: not larger than keV. This is in a grave contradiction with what is known: the energy is measured using GeV as a natural unit so that there is discrepancy of 6 orders of magnitude at least. One can also apply energy conservation to the decay of pion to muon and neutrino and this implies that muon has gigantic energy: another contradiction.

What is amusing that this simple kinematic fact was not noticed from beginning. In any case, this finding kills all tachyonic models of neutrino super-luminality assuming energy conservation, and gives additional support for the TGD based explanation in terms of maximal signal velocity, which depends on pair of points of space-time sheet connected by signal and space-time sheet itself characterizing also particular kind of particle.

Even better, one can understand also the jitter [C12] in the spectrum of the arrival times which has width of about 50 ns in terms of an effect caused fluctuations in gravitational fields to the maximal signal velocity expressible in terms of the induced metric [K72]. The jitter could have interpretation in terms of gravitational waves inducing fluctuation of the maximal signal velocity $c_{\#}$, which in static approximation equals to $c_{\#} = c(1 + \Phi_{gr})^{1/2}$, where Φ_{gr} is gravitational potential.

Surprisingly, effectively super-luminal neutrinos would make possible gravitational wave detector [K72]! The gravitational waves would be however gravitational waves in TGD sense having fractal structure since they would correspond to bursts of gravitons resulting from the decays of large \hbar gravitons emitted primarily rather than to a continuous flow [K61]. The ordinary detection criteria very probably exclude this kind of bursts as noise. The measurements of Witte [E81] attempting to detect absolute motion indeed observed this kind of motion identifiable as a motion of Earth with respect to the rest frame of galaxy but superposed with fractal fluctuations proposed to have interpretation in terms of gravitational turbulence - gravitational waves.

Icarus refutes Opera result

Icarus collaboration [C11] has replicated the measurement of the neutrino velocity. The abstract summarizes the outcome.

The CERN-SPS accelerator has been briefly operated in a new, lower intensity neutrino mode with about 10^{12} p.o.t. /pulse and with a beam structure made of four LHC-like extractions, each with a narrow width of about 3 ns, separated by 524 ns. This very tightly bunched beam structure represents a substantial progress with respect to the ordinary operation of the CNGS beam, since it allows a very accurate time-of-flight measurement of neutrinos from CERN to LNGS on an event-to-event basis. The ICARUS T600 detector has collected 7 beam-associated events, consistent with the CNGS delivered neutrino flux of 2.2×10^{16} p.o.t. and in agreement with the well known characteristics of neutrino events in the LAr-TPC. The time of flight difference between the speed of light and the arriving neutrino LAr-TPC events has been analyzed. The result is compatible with the simultaneous arrival of all events with equal speed, the one of light. This is in a striking difference with the reported result of OPERA that claimed that high energy neutrinos from CERN should arrive at LNGS about 60 ns earlier than expected from luminal speed.

As explained, the TGD based explanation for the anomaly would not have been super-luminality but the dependence of the maximal signal velocity on space-time sheet: the geodesics in induced metric are not geodesics of the 8-D imbedding space. In principle the time taken to move from A (say CERN) to point B (say Gran Sasso) depends on space-time sheets involved. One of these space-time sheets would be that assignable to particle beam - a good guess is "massless extremal" [K11]: along this the velocity is in the simplest case (cylindrical "massless extremals") the maximal signal velocity in $M^4 \times CP_2$.

Other space-space-time sheets involved can be assigned to various systems such as Earth, Sun, Galaxy and they contribute to the effect. It is important to understand how the physics of test particle depends on the presence of parallel space-times sheets. Simultaneous topological condensation to all the sheets is extremely probable so that at classical level forces are summed. Same happens at quantum level. The superposition of various fields assignable to parallel space-time sheets is not possible in TGD framework and is replaced with the superposition of their effects. This allows to resolve one of the strongest objections against the notion induced gauge field.

The outcome of ICARUS experiment is not able to kill this prediction since at this moment I am not able to fix the magnitude of the effect. It is really a pity that such a fantastic possibility to wake up the sleeping colleagues is lost. I feel like a parent in a nightmare seeing his child to drown and being unable to do anything.

There are other well-established effects in which the dependence of maximal signal velocity on space-time sheet is visible: one such effect is the observed slow increase of the time spend by light ray to propagate moon and back. The explanation [K72] is that the effect is not real but due to the change of the unit for velocity defined by the light-velocity assignable to the distant stars. The maximal signal velocity is for Robertson-Walker cosmology gradually increasing and the anomaly emerges as an apparent anomaly when one assumes that the natural coordinate system assignable to the solar system (Minkowski coordinates) is the natural coordinate system in cosmological scales. The size of the effect is predicted correctly. Since the cosmic signal velocity defining the unit increases, the local maximal signal velocity which is constant seems to be reducing and the measured distance to the Moon seems to be increasing.

6.8.2 Anomalous time dilation effects due to warping as basic distinction between TGD and GRT

TGD predicts the possibility of large anomalous time dilation effects due to the warping of space-time surfaces, and the experimental findings of Russian physicist Chernobrov about anomalous changes in the rate of flow of time [J1, J7] provide indirect support for this prediction.

Anomalous time dilation effect due to the warping

Consider first the ordinary gravitational time dilation predicted by GRT. For simplicity consider a stationary spherically symmetric metric $ds^2 = g_{tt}dt^2 - g_{rr}dr^2 - r^2d\Omega^2$ in spherical coordinates. The time dilation is characterized by the difference $\Delta = \sqrt{g_{tt}} - 1$. In the weak field approximation one has $g_{tt} = 1 + 2\Phi_{gr}$, where Φ_{gr} is gravitational potential. The ordinary time dilation is given by $\Delta = \sqrt{g_{tt}} - 1 \simeq 2\Phi_{gr}$. At the Earth's surface the gravitational potential of the Earth is about $\Phi_{gr} = GM/R_E \simeq 10^{-9}$.

Consider next the situation for space-time surfaces. There exists an infinite number of warped imbeddings of M^4 to $M^4 \times CP_2$ given by $s^k = s^k(m^0)$, which are metrically equivalent with the canonical imbedding with CP_2 coordinates constant. New M^4 time coordinate is related by a diffeomorphism to the standard one. By restricting the imbedding to $M^4 \times S^1$, where S^1 a geodesic circle with radius $R/2$ (using the chosen convention for the definition CP_2 radius), the time component of the induced metric is $g_{m^0m^0} = 1 - R^2\omega^2/4$. The identification of M^4 coordinates as the preferred natural standard coordinate frame allows to overcome the difficulties related to the identification of the preferred time coordinate in general relativity in the case the metric does not approach asymptotically flat metric. For this choice an anomalous time dilation $\sqrt{1 - R^2\omega^2/4}$ due to the warping results even when gravitational fields are absent. Moreover, the dilation can be large.

The study of the imbeddings of Schwarzschild metric as vacuum extremals demonstrates that this vacuum warping is also seen as the degeneracy of the imbeddings of stationary spherically symmetric metrics. If m^0 is used as a time coordinate, anomalous time dilation is obtained also at $r_M \rightarrow \infty$ and is given by

$$\sqrt{g_{m^0 m^0}} = \frac{1}{\lambda} . \quad (6.8.1)$$

This time dilation is seen only if the clocks to be compared are at different space-time sheets. The anomalous time dilation can be quite large since the order of magnitude for the parameter ωR is naturally of order one for the imbeddings of R-N metrics.

Mechanisms producing anomalous time dilation

Anomalous time dilation could result in many manners.

- (a) An adiabatic variation of the parameters λ and ω_1 of the space-time sheet containing the clock could be induced by some physical mechanism. For instance, X_c^4 could move "over" a large space-time sheet X^4 and gradually form $\#$ and $\#_B$ contacts with it. Topological light rays (MEs) define a good candidate for X^4 . The parameter values λ and ω could change quasi-continuously if X_c^4 gradually generates CP_2 sized wormhole contacts or join along boundaries bonds connecting it to X^4 . This process would not affect the gravitational flux feeded to X_c^4 .

For instance, if X^4 is at rest with respect to Earth, this motion would result from the rotation of Earth and the effect should appear periodically from day to day. If it is at rest with respect to Sun, the effect should appear once a year.

The generation of vacuum extremals X_{vac}^4 (not gravitational vacua), which is in principle possible even by intentional action since conservation laws are not broken, could induce anomalous time dilation by this mechanism.

- (b) A phase transition increasing the value of \hbar increases the size of the space-time sheet in the same proportion. This transition could quite well affect also the parameter λ . If this phase transition occurs for the space-time sheet X_c^4 at which the clock feeds its gravitational flux, this mechanism could provide a feasible manner to induce an anomalous time dilation.
- (c) The system containing the clock could suffer a temporary topological condensation to a smaller space-time sheet and thus feed its gravitational flux to this space-time sheet. This would require coherently occurring splitting of $\#$ contacts and their regeneration. It is not possible to say anything definite about the probability of this kind of process except that it does not look very feasible.

The findings of Chernobrov

The findings claimed by Russian researcher V. Chernobrov support anomalous time dilation effect [J1, J7]. Chernobrov has studied anomalies in the rate of time flow defined operationally by comparing the readings of clocks enclosed inside a spherical volume with the readings of clocks outside this volume. The experimental apparatus involves a complex Russian doll like structure of electromagnets.

Chernobrov reports a slowing down of time by about 30 seconds per hour inside his experimental apparatus [J1] so that the average dilation factor during hour would be about $\Delta = 1/120$. If the dilation is present all the time, the anomalous contribution to the gravitational potential would be by a factor $\sim 10^7$ larger than that of Earth's gravitational potential and huge gravitational perturbations would be required to produce this kind of effect.

The slowing of the time flow is reported to occur gradually whereas the increase for the rate of time flow is reported to occur discontinuously. Time dilation effects were observed in connection with the cycles of moon, diurnal fluctuations, and even the presence of operator.

Consider now the explanation of the basic qualitative findings of Chernobrov.

- (a) The gradual slowing of the time flow suggests that the parameter values of λ and ω change adiabatically. This favors option 1) since the formation of $\#$ contacts occurs with some finite rate.

- (b) Also the sudden increase of the rate of time flow is consistent with option 1) since the splitting of # contacts occurs immediately when the sheets X_c^4 and X^4 are not "over" each other.
- (c) The occurrence of the effect in connection with the cycles of moon, diurnal fluctuations, and in the presence of operator support this interpretation. The last observation would support the view that intentional generation of almost vacuum space-time sheets is indeed possible.

Vacuum extremals as means of generating time dilation effects intentionally?

Field equations allow a gigantic family of vacuum extremals: any 4-surface having CP_2 projection, which belongs to a 2-dimensional Lagrange manifold with a vanishing induced Kähler form, is a vacuum extremal. Symplectic transformations and diffeomorphisms of CP_2 produce new vacuum extremals. Vacuum extremals carry non-vanishing classical electro-weak and color fields which are reduced to some $U(1)$ subgroup of the full gauge group and also classical gravitational field. Although the vacuum extremals are not absolute minima, their small deformations could define such. These vacuum extremals, call them X_{vac}^4 for brevity, could be generated by intentional action. In the first quantum jump the p-adic variant of the vacuum extremal representing an intention to create X_{vac}^4 would appear and in some subsequent quantum jump it would be transformed to a real space-time sheet.

The creation of these almost vacuum extremals could generate time dilation effects. The material system would gradually generate CP_2 sized wormhole contacts and/or join along boundaries connecting its space-time sheet to X_{vac}^4 and this could change the values of the vacuum parameters λ, ω .

Could warping have something to do with condensed matter physics?

Warping predicts the reduction of the effective light velocity. There is a report [D11] of an experimental study of a condensed-matter system (graphene, a single atomic layer of carbon, in which electron transport is essentially governed by massless Dirac's equation. According to the report, the charge carriers in graphene mimic relativistic particles with zero rest mass and have an effective 'speed of light' $c_1 = c/300 = 10^6$ m/s.

The study reveals a variety of unusual phenomena that are characteristic of two-dimensional Dirac fermions. Graphene's conductivity never falls below a minimum value corresponding to the quantum unit of conductance, even when the concentrations of charge carriers tend to zero. The integer quantum Hall effect in graphene is anomalous in that it occurs at half-integer filling factors. The cyclotron mass m_c of massless current carriers in graphene is defined in terms of the energy of current carrier as $E = m_c c_1^2$.

The authors believe that these phenomena can be understood in the framework of the ordinary QED and this might be the case. One can however wonder whether the massless Dirac equation for the 2-dimensional system could correspond to the modified Dirac equation for the induced spinor fields and whether the reduction of the maximal signal velocity to c_1 could have the warping of the space-time sheet as a space-time correlate. In the idealization that the CP_2 projection of the space-time surface is a geodesic circle of CP_2 , and using M^4 coordinates for space-time surface, so that one would have $\Phi = \omega t$ for S^2 coordinate Φ , one would have $g_{tt} = c_1^2 = 1 - R^2 \omega^2 / 4 = 10^{-4} / 9$.

6.8.3 Evidence for many-sheeted space-time from gamma ray flares

MAGIC collaboration has found evidence for a gamma ray anomaly. Gamma rays in different energy ranges seem to arrive with different velocities from Mkn 501 [E91]. The delay in arrival times is about 4 minutes. The proposed explanation is in terms of broken Lorentz invariance. TGD allows to explain the finding in terms of many-sheeted space-time and there is no need to invoke breaking of Lorentz invariance.

TGD based explanation at qualitative level

One of the oldest predictions of many-sheeted space-time is that the time for photons to propagate from point A to B along given space-time sheet depends on space-time sheet because photon travels along light-like geodesic of space-time sheet rather than light-like geodesic of the imbedding space and thus increases so that the travel time is in general longer than using maximal signal velocity.

Many-sheetedness predicts a spectrum of Hubble constants and gamma ray anomaly might be a demonstration for the many-sheetedness. The spectroscopy of arrival times would give information about how many sheets are involved.

Before one can accept this explanation, one must have a good argument for why the space-time sheet along which gamma rays travel depends on their energy and why higher energy gamma rays would move along space-time sheet along which the distance is longer.

- (a) Shorter wavelength means that that the wave oscillates faster. Space-time sheet should reflect in its geometry the the matter present at it. Could this mean that the space-time sheet is more "wiggly" for higher energy gamma rays and therefore the distance traveled longer? A natural TGD inspired guess is that the p-adic length scales assignable to gamma ray energy defines the p-adic length scale assignable to the space-time sheet of gamma ray connecting two systems so that effective velocities of propagation would correspond to p-adic length scales coming as half octaves. Note that there is no breaking of Lorentz invariance since gamma ray connects the two system and the rest system of receiver defines a unique coordinate system in which the energy of gamma ray has Lorentz invariant physical meaning.
- (b) One can invent also an objection. In TGD classical radiation field decomposes into topological light rays ("massless extremals", MEs) which could quite well be characterized by a large Planck constant in which case the decay to ordinary photons would take place at the receiving end via de-coherence. Gamma rays could propagate very much like a laser beam along the ME. For the simplest MEs the velocity of propagation corresponds to the maximal signal velocity and there would be no variation of propagation time.

One can imagine two manners to circumvent to the counter argument.

- i) Also topological light rays for which light-like geodesics are replaced with light-like curves of M^4 are highly suggestive as solutions of field equations. For these MEs the distance travelled would be in general longer than for the simplest MEs.
- ii) The gluing of ME to background space-time by wormhole contacts (actually representation for photons!) could force the classical signal to propagate along a zigzag curve formed by simple MEs with maximal signal velocity. The length of each piece would be of order p-adic length scale. The zigzag character of the path of arrival would increase the distance between source and receiver.

Quantitative argument

A quantitative estimate runs as follows.

- (a) The source in question is quasar Makarian 501 with redshift $z = .034$. Gamma flares of duration about 2 minutes were observed with energies in bands .25-.6 TeV and 1.2-10 TeV. The gamma rays in the higher energy band were near to its upper end and were delayed by about $\Delta\tau = 4$ min with respect to those in the lower band. Using Hubble law $v = Hct$ with $H = 71$ km/Mparsec/s, one obtains the estimate $\Delta\tau/\tau = 1.6 \times 10^{-14}$.
- (b) A simple model for the induced metric of the space-time sheet along which gamma rays propagate is as a flat metric associated with the flat imbedding $\Phi = \omega t$, where Φ is the angle coordinate of the geodesic circle of CP_2 . The time component of the metric is given by

$$g_{tt} = 1 - R^2\omega^2 \ .$$

ω appears as a parameter in the model. Also the imbeddings of Reissner-Norström and Schwarzschild metrics contain frequency as free parameter and space-time sheets are quite generally parameterized by frequencies and momentum or angular momentum like vacuum quantum numbers.

- (c) ω is assumed to be expressible in terms of the p-adic prime characterizing the space-time sheet. The parametrization to assumed in the following is

$$\omega^2 R^2 = K p^{-r} .$$

It turns out that $r = 1/2$ is the only option consistent with the p-adic length scale hypothesis. The naive expectation would have been $r = 1$. The result suggests the formula

$$\omega^2 = m_0 m_p \quad \text{with} \quad m_0 = \frac{K}{R} .$$

ω would be the geometric mean of a slowly varying large p-adic mass scale and p-adic mass scale m_p .

The explanation for the p-adic length scale hypothesis leading also to a generalization of Hawking-Bekenstein formula assumes that for the strong form of p-adic length scale hypothesis stating $p \simeq 2^k$, k prime, there are two p-adic length scales involved with given elementary particle. L_p characterizes particle's Compton length and L_k characterizes the size of the wormhole contact or throat representing the elementary particle. The guess is that ω is proportional to the geometric mean of these two p-adic length scales:

$$\omega^2 R^2 = \frac{x}{2^{k/2} \sqrt{k}} .$$

- (d) A relatively weak form of the p-adic length scale hypothesis would be $p \simeq 2^k$, k an odd integer. M_{127} corresponds to the mass scale $m_e 5^{-1/2}$ in a reasonable approximation. Using $m_e \simeq .5$ MeV one finds that the mass scales $m(k)$ for $k = 89 - 2n$, $n = 0, 1, 2, \dots, 6$ are $m(k)/TeV = x$, with $x = 0.12, 0.23, 0.47, 0.94, 1.88, 3.76, 7.50$. The lower energy range contains the scales $k = 87$ and 85 . The higher energy range contains the scales $k = 83, 81, 79, 77$. In this case the proposed formula does not make sense.
- (e) The strong form of p-adic length scale hypothesis allows only prime values for k . This would allow Mersenne prime M_{89} (intermediate gauge boson mass scale) for the lower energy range and $k = 83$ and $k = 79$ for the upper energy range. A rough estimate is obtained by assuming that the the two energy ranges correspond to $k_1 = 89$ and $k_2 = 79$.
- (f) The expression for τ reads as $\tau = (g_{tt})^{1/2} t$. $\Delta\tau/\tau$ is given by

$$\begin{aligned} \frac{\Delta\tau}{\tau} &\simeq (g_{tt})^{-1/2} \frac{\Delta g_{tt}}{2} \simeq R^2 \Delta\omega^2 = x[(k_2 p_2)^{-1/2} - (k_1 p_1)^{-1/2}] \simeq x(k_2 p_2)^{-1/2} \\ &= x 2^{-79/2} 79^{-1/2} . \end{aligned}$$

Using the experimental value for $\Delta\tau/\tau$ one obtains $x \simeq .45$. $x = 1/2$ is an attractive guess.

6.8.4 Do ultracold neutrons provide direct evidence for many-sheeted space-time?

There was a very interesting article about magnetic anomaly UCN trapping. UCN is a shorthand for ultra-cold neutrons. The article [C30] had a somewhat hypish title *Magnetic anomaly in UCN trapping: signal for neutrons oscillations to parallel world?*. Perhaps this explains why I did not bother to look at it at the first time I saw it.

As I saw again the popular story hyping the article, I realized that the anomaly - if real - could provide a direct evidence for the transitions of neutrons between parallel space-time sheets of many-sheeted space-time. TGD of course predicts that this phenomenon is completely general applying to all kinds of particles.

The interpretation of authors is that ultra-cold neutrons oscillate between parallel worlds- albeit in different sense as in TGD. The authors describe this oscillation using same mathematical model as describing neutrino oscillations. What would be observed would be that in statistical sense neutrons in the beam disappear and reappear periodically. The model predicts that the frequency for this is just the Larmor frequency $\omega = \mu \cdot B/2$ for the precession of spin of neutron in magnetic field. The authors claim that just this is observed and the interpretation is somewhat outlandish looking. Standard model gauge group is doubled: all particles have exact mirror copies with same quantum numbers. This of course is extremely inelegant interpretation. Something much more elegant is needed.

TGD based description of the situation

TGD allows to understand the finding in terms of many-sheeted space-time and one ends up with a phenomenological model similar to that of authors. Now however the phenomenon is predicted to be completely general applying to all kinds of particles and does not require the weird doubling of standard model symmetries.

Imagine the presence of two space-time sheets (or even more of them) carrying magnetic fields which decompose to flux tubes.

- (a) Suppose that neutron is topologically condensed in one of these flux tubes. What happens when the flux tubes are "above each other" in the sense that that their Minkowski space projections intersect and the flux tubes are extremely near to each other: the distance is of order CP_2 size of order 10^4 Planck lengths. It took long time to take seriously the obvious: neutrons topologically condense on both space-time sheets and experience the sum of the magnetic fields in these regions. This actually allows to overcome the basic objection against TGD due to the fact that all classical gauge fields are expressible in terms of CP_2 coordinates and their gradients so that enormously powerful constraints between classical gauge fields are satisfied and linear superposition of fields is lost. In many-sheeted space-time this superposition is replaced with the superposition of their effects in multiple topological condensation,
- (b) In the regions where the intersection of M^4 projections of flux tubes is empty, topological condensation takes place on either space-time sheet.
- (c) What happens when one has neutrons propagating along flux tube 1 characterized by magnetic field B_1 arrive to a region where flux tube 2 of magnetic field B_2 resides? In the intersection region the neutrons experience the field $B_1 + B_2$ in good approximation. The interaction energy $E = \mu B \cdot \sigma$, where B is the magnetic field and σ is the spin of neutron. In flux tube 1 has $B = B_1$, in flux tube 2 one has $B = B_2$ and in the intersection region $B = B_1 + B_2$. It can happen that neutron arriving along flux tube 1 continues its travel along flux tube 2.
- (d) Magnetic fields in question actually consists of large number of nearly parallel flux tubes and the travel of neutron is a series of segments: $B_{i_1} \rightarrow B_1 + B_2 \rightarrow B_{i_2} \rightarrow \dots$. As if neutron would make jumps between parallel worlds. Now these worlds are geometrically parallel rather than identifiable as copies in tensor product of standard model gauge groups.

A phenological description predicting the probabilities for the transitions between the parallel worlds assignable to the two magnetic fields could be based on simple Hamiltonian used to describe also neutrino mixing. Hamiltonian is sum of spin Hamiltonians $H_i = \mu B_i \cdot \sigma$ and of non-diagonal mixing term ϵ . $H = H_1 \oplus H_2 + \epsilon$. The diagonal term H_i are non-vanishing in the nonintersecting region i and non-diagonal describing what happens in the intersecting regions. Just this description was used by the authors of the article to parametrize the observed anomaly.

One can test this interpretation by introducing a third magnetic field. The interpretation of authors might force to introduce even third copy of standard model gauge group;-).

Amusing co-incidence

What is so amusing that the magnetic field used in the experiments was .2 Gauss. It is exactly the nominal value of the endogenous magnetic field needed to explain the strange quantal effects of radiation at cyclotron frequencies of biologically important ions on vertebrate brain. The frequencies are extremely low - in EEG range - and corresponding thermal energies are 10 orders below thermal energy so that standard quantum mechanics predicts no effects. The explanation assumes $B_{end} = .2$ GeV containing dark variants of these ions with so large Planck constants that the cyclotron energies are above thermal energy at physiological temperatures.

Why experimentalists happened to use just this .2 Gauss magnetic field which is 2/5 of the the nominal value of the Earth's magnetic field $B_E = .5$ Gauss? If I were a paranoid, I would swear that the experimentalists were well aware of TGD. Of course they were not! One cannot be aware of TGD in a company of respectable scientists and even less in respectable science journals!

6.8.5 Is gravitational constant really constant?

The most convincing TGD based model for the p-adic coupling constant evolution identified hitherto [K5] predicts that gravitational coupling constant is proportional to the square of p-adic length scale: $G \propto L_p^2$. Together with p-adic length scale hypothesis this would predict that gravitational coupling strength can have values differing from its standard value by a power of 2. $p = M_{127}$ would characterize the space-time sheet mediating ordinary gravitational interactions. In the following possible indications for the variation of G is discussed.

The case of Bullet cluster

The studies of the Bullet cluster [E109, E95] , provide the best evidence to date for the existence of dark matter. Bullet cluster [E6] consists of two colliding clusters of galaxies (strictly speaking, the term refers to the smaller one of the two clusters). The major components of the cluster pair, stars, gas and the putative dark matter, behave differently during collision, allowing them to be studied separately.

The stars of the galaxies, observable in visible light, were not greatly affected by the collision, and most passed right through, gravitationally slowed but not otherwise altered. The hot gas of the two colliding components, seen in X-rays, represents about 90 per cent of the mass of the ordinary matter in the cluster pair. The gases interact electromagnetically, so that the velocity change for the gases of clusters is larger than for the stars of clusters. The dominating dark matter component was detected indirectly by its gravitational lensing. The observation that the lensing is strongest in two separated regions near the visible galaxies, confirms with the assumption that most of the mass in the cluster pair is in the form of collisionless dark matter.

Particularly compelling results were inferred from the Chandra observations of the bullet cluster. Those authors report that the cluster is undergoing a high-velocity [around 4500 km/s] merger, evident from the spatial distribution of the hot, X-ray emitting gas, but this gas lags behind the sub-cluster galaxies. Furthermore, the dark matter clump, revealed by the weak-lensing map, is coincident with the collisionless galaxies, but lies ahead of the collisional gas.

Later came the work of Glennys Farrar, Rachel Rosen, and Volker Springler [E184] suggesting that the situation might not be as simple as this (for a popular article see [E163]). The velocity of the bullet of dark matter is higher than it should be in the cold dark matter scenario (CDM). The proposal is that dark matter has its own additional attractive interaction of finite range, "fifth force". Since the finite range of the force is not actually significant in the situation considered, the model is mathematically equivalent with a model assuming that dark gravitational coupling strength. A good fit is obtained by assuming that the net effective gravitational force is by a factor 2 stronger than gravitational force.

The hypothesis is claimed to solve also some other problems of the cold dark matter scenario (CDM). The number of dwarf galaxies around ordinary galaxies is considerably smaller than

predicted by CDM. The strong binding of dark matter in dwarfs would make them more compact and this in turn would mean that the binding of visible matter is weaker so that ordinary galaxies would have ripped this matter off and dwarfs would be more difficult to detect. CDM also predicts less galaxy clusters and stronger attraction for dark matter could resolve the problem.

TGD predicts that gravitational constant is proportional to the square of p-adic length scale: $G \propto L_p^2 \equiv L(k)^2$, $p \simeq 2^k$, k integer, in particular power of prime. Ordinary gravitational constant would correspond to $p = M_{127} = 2^{127} - 1$, which is the largest Mersenne prime which is not completely super-astrophysical and corresponds to electron's p-adic length scale. One can however ask whether it might be possible to have situations in which the p-adic length scale assigned to the space-time sheets mediating gravitational interaction differs from M_{127} . $L(k)$ $k = 2^7 = 128$, would correspond to $G \rightarrow 2G$. The growth of the gravitational coupling strength could be a transient phenomenon taking place only during the collision.

Shrinking kilogram

The definition of kilogram [E22] is not the topics number one in coffee table discussions and definitely not so because it could lead to heated debates. The fact however is that even the behavior of standard kilogram can open up fascinating questions about the structure of space-time.

The 118-year old International Prototype Kilogram is an alloy with 90 per cent Platinum and 10 per cent Iridium by weight (gravitational mass). It is held in an environmentally monitored vault in the basement of the BIPMs House of Breteuil in Sevres on the outskirts of Paris. It has forty copies located around the world which are compared with Sevres copy with a period of 40 years.

The problem is that the Sevres kilogram seems to behave in a manner totally in-appropriate taking into account its high age if the behavior of its equal age copies around the world is taken as the norm [C25], [E22]. The unavoidable conclusion from the comparisons is that the weight of Sevres kilogram has been reduced by about 50 μg during 118 years which makes about

$$\frac{d \log(m)}{dt} = -4.2 \times 10^{-10} / \text{year} .$$

for Sevres copy or relative increase of same amount for its copies.

Specialists have not been able to identify any convincing explanation for the strange phenomenon. For instance, there is condensation of matter from the air in the vault which increases the weight and there is periodic cleaning procedure which however should not cause the effect.

1. Could the non-conservation of gravitational energy explain the mystery?

The natural question is whether there could be some new physics mechanism involved. If the copies were much younger than the Sevres copy, one could consider the possibility that gravitational mass of all copies is gradually reduced. This is not the case. One can still however look what this could mean.

In TGD Equivalence Principle is not a basic law of nature and in the generic case gravitational energy is non-conserved whereas inertial energy is conserved (I will not go to the delicacies of zero energy ontology here). This occurs even in the case of stationary metrics such as Reissner-Nordström exterior metric and the metrics associated with stationary spherically symmetric star models imbedded as vacuum extremals as has been found.

The basic reason is that Schwarzschild time t relates by a scaling and shift to Minkowski time m^0 :

$$m^0 = \lambda t + h(r)$$

such that the shift depends on the distance r to the origin. The Minkowski shape of the 3-volume containing the gravitational energy changes with M^4 time but this does not explain the

effect. The key observation is that the vacuum extremal of Kähler action is not an extremal of the curvature scalar (these correspond to asymptotic situations). What looks first really paradoxical is that one obtains a constant value of energy inside a fixed constant volume but a non-vanishing flow of energy to the volume. The explanation is that the system simply destroys the gravitational energy flowing inside it! The increase of gravitational binding energy compensating for the feed of gravitational energy gives a more familiar looking articulation for the non-conservation.

Amusingly, the predicted rate for the destruction of the inflowing gravitational energy is of same order of magnitude as in the case of kilogram. Note also that the relative rate is of order $1/a$, a the value of cosmic time of about 10^{10} years. The spherically symmetric star model also predicts a rate of same order.

This approach of course does not allow to understand the behavior of the kilogram since it predicts no change of gravitational mass inside volume and does not even apply in the recent situation since all kilograms are in same age. The co-incidence however suggests that the non-conservation of gravitational energy might be part of the mystery. The point is that if the inflow satisfies Equivalence Principle then the inertial mass of the system would slowly increase whereas gravitational mass would remain constant: this would hold true only in steady state.

2. *Is the change of inertial mass in question?*

It would seem that the reduction in weight should correspond to a reduction of the inertial mass in Sevres or its increase of its copies. What would distinguish between Sevres kilogram and its cousins? The only thing one can imagine is that the cousins are brought to Sevres periodically. The transfer process could increase the kilogram or stop its decrease.

Could it be that the inertial mass of every kilogram increases gradually until a steady state is achieved? When the system is transferred to another place the saturation situation is changed to a situation in which genuine transfer of inertial and gravitational mass begins again and leads to a more massive steady state. The very process of transferring the comparison masses to Sevres would cause their increase.

In TGD Universe the increase of the inertial (and gravitational) mass is due to the flow of matter from larger space-time sheets to the system. The additional mass would not enter in via the surface of the kilogram but like a Trojan horse from the interior and it would be thus impossible to control using present day technology. The flow would continue until a flow equilibrium would be reached with as much mass leaving the kilogram as entering it.

3. *A connection with gravitation after all?*

Why the in-flow of the inertial energy should be of same order of magnitude as that for the gravitational energy predicted by simple star models? Why Equivalence Principle should hold for the in-flow although it would not hold for the body itself? A possible explanation is in terms of the increasing gravitational binding energy which in a steady situation leaves gravitational energy constant although inertial energy could still increase.

This would however require rather large value of gravitational binding energy since one has

$$\Delta E_{gr} = \frac{\Delta M_I}{M} .$$

The Newtonian estimate for E_{gr}/M is of order GM/R , where $R \simeq .1$ m the size of the system. This is of order 10^{-26} and too small by 16 orders of magnitude.

TGD predicts that gravitational constant is proportional to p-adic length scale squared

$$G \propto L_p^2 .$$

Ordinary gravitation can be assigned to the Mersenne prime M_{127} associated with electron and thus to p-adic length scale of $L(127) \simeq 2.5 \times 10^{-14}$ meters. The open question has been whether the gravities corresponding to other p-adic length scales are realized or not.

This question together with the discrepancy encourages to ask whether the value of the p-adic prime could be larger inside massive bodies (analogous to black holes in many respects in TGD framework) and make gravitation strong? In the recent case the p-adic length scale should correspond to a length scale of order $10^8 L(127)$. $L(181) \simeq 3.2 \times 10^{-4}$ m (size of a large neuron by the way) would be a good candidate for the p-adic scale in question and considerably smaller than the size scale of order .1 meter defining the size of the kilogram.

This discrepancy brings in mind the strange finding of Tajmar and collaborators [E186, E125, E121] . suggesting that rotating super-conductors generate a gravimagnetic field with a field strength by a factor of order 10^{20} larger than predicted by General Relativity. I have considered in this chapter a model of the finding based on dark matter. An alternative model could rely on the assumption that Newton's constant can in some situations correspond to p larger than M_{127} . In this case the p-adic length scale needed would be around $L(193) \simeq 2$ cm.

6.9 Entropic gravity in TGD framework

Entropic gravity (EG) introduced by Verline [B63] has stimulated a great interest. One of the most interesting reactions is the commentary of Sabine Hossenfelder [B41]. The article of Kobakhidze [B48] relies on experiments supporting the existence of Schrödinger amplitudes of neutron in the gravitational field of Earth develops an argument suggesting that EG hypothesis in the form in which it excludes gravitons is wrong. The following arguments represent TGD inspired view about what entropic gravity (EG) could be if one throws out the unnecessary assumptions such as the emerging dimensions and absence of gravitons. Before continuing I want to express my gratitude to Prof. Masud Chaichian for the stimulus which led to a re-evaluation and reformulation of EG hypothesis. I want also to represent my thanks to Archil Kobakhidze for his clarifications concerning his argument against Verlinde's entropic gravity.

- (a) If one does not believe in TGD, one could start from the idea that stochastic quantization or something analogous to it might imply something analogous to entropic gravity (EG). What is required is the replacement of the path integral with functional integral. More precisely, one has functional integral in which the real contribution to Kähler action of the preferred extremal from Euclidian regions of the space-time surface to the exponent represents Kähler function and the imaginary contribution from Minkowskian regions serves as a Morse function so that the counterpart of Morse theory in WCW is obtained on stationary phase approximation in accordance with the vision about TGD as almost topological QFT [K93]. The exponent of Kähler function is the new element making the functional integral well-defined and the presence of phase factor gives rise to the interference effects characteristic for quantum field theories although one does not integrate over all space-time surfaces. In zero energy ontology one has however pairs of 3-surfaces at the opposite light-like boundaries of CD so that something very much analogous to path integral is obtained.
- (b) Holography requires that everything reduces to the level of 3-metrics and more generally, to the level of 3-D field configurations. Something like this happens if one can approximate the functional integral with the integral over small deformations for the minima of the action. This happens in precise sense in completely integral quantum field theories.

The basic vision behind quantum TGD is that this approximation is much nearer to reality than the original theory. In other words, holography is realized in the sense that to a given 3-surface the metric of WCW assigns a unique space-time and this space-time serves as the analog of Bohr orbit and allows to realize 4-D general coordinate invariance in the space of 3-surfaces so that classical theory becomes an exact part of quantum theory. This point of view will be adopted in the following also in the framework of general relativity where one considers abstract 4-geometries instead of 4-surfaces: functional integral should be over 3-geometries with the definition of Kähler metric assigning to 3-geometry a unique 4-geometry.

- (c) A powerful constraint is that the functional integral is free of divergences. Both 4-D path integral and stochastic quantization for gravitation fail in this respect due to the local

divergences (in super-gravity situation might be different). The TGD inspired approach reducing quantum TGD to almost topological QFT with Chern-Simons term and a constraint term depending on metric associated with preferred 3-surfaces allows to circumvent this difficulty. This picture will be applied to the quantization of GRT and one could see the resulting theory as a guess for what GRT limit of TGD could be. The first guess that Kähler function corresponds to Einstein-Maxwell action for this kind of preferred extremal turns out to be correct. An essential and radically new element of TGD is the possibility of space-time regions with Euclidian signature of the induced metric replacing the interiors of blackholes: this element will be assumed also now. The conditions that CP_2 represents and extremal of EYM action requires cosmological constant in Euclidian regions determined by the constant curvature of CP_2 and one can ask whether the average value of cosmological constant over 3-space could correspond to the cosmological constant explaining accelerating cosmic expansion.

- (d) Before going to a more precise formulation it is better to discuss how the phenomenology of EG with gravitons and without the fuzzy assumption about the emergence of space-time could be understood in TGD framework. This article is kind of continuation to the earlier article published in <http://www.scribd.com/doc/45928480/PSTJ-V1-10-More-Possible-Games-in-Town-ContinuedPrespace-Time> Journal [B56], where the proposal that Quantum TGD as a hermitian square root of thermodynamics might imply something analogous to entropic gravity since S-matrix is replaced with the analog of thermal S-matrix. The article of Hossenfelder [B41] has been of great help. Entropic gravity is generalized in TGD framework so that all interactions are entropic: the reason is that in zero energy ontology (ZEO) the S -matrix is replaced with M -matrix defining a square root of thermodynamics in a well defined sense.

6.9.1 The phenomenology of EG in TGD framework

In TGD framework one can consider a modification of EG allowing gravitons. In this framework thermodynamics is assigned with the virtual gravitons (and also real) flowing along the flux tubes mediating gravitational interaction. The entropy proportional to the length of flux tube corresponds to the entropy assigned with the holographic screen and temperature is the temperature of gravitons decreasing with distance just like the temperature of the radiation from Sun decreases as $1/r^2$: this is due to the absence of gravitonic heat sources in empty space.

TGD based view about EG leads also to new views. The basic objection against EG is that it applies also to electromagnetic interactions and leads to negative temperatures. In zero energy ontology the resolution of the problem could be that matter and antimatter correspond to opposite arrow of geometric time and therefore different causal diamonds and space-time sheets: this could explain also the apparent absence of antimatter.

EG with gravitons and without emergence of space-time

The following arguments explain how the basic formulas of EG follow from TGD framework assuming that virtual gravitons reside at flux tubes connecting interacting systems.

- (a) The argument originally to Kobakhidze [?] suggests that EG in the strong sense predicting the absence of gravitons is inconsistent with experimental facts. The argument does not mention gravitons but relies on the experimental fact that neutron bound states in Earth's gravitational field exist. Chaichian et al [?] however claim the argument contains an error because the formula (8) of [?] or the density matrix of neutron plus screen reading as

$$\rho_S(z + \Delta z) = \rho_N(z + \Delta z) \times \rho_{S/N}(z)$$

gives constant density matrix for screen when one removes neutron and this is certainly not true. According to Kobakhidze (private communication) the theory of Verlinde implies that the removal of neutron effectively removes the screen from $z + \Delta z$ to z . I leave it for the reader to decide what is the truth. Second challengable assumption of Kobakhidze

used before equation (10) of [?]s the additivity of the entropies of the screen and neutron: the interaction with the screen implies interaction entropy and the question is whether it can be neglected.

- (b) According to Chaichian et al [?]hat there exist transitions between the excited states suggest that the emission of gravitons must be involved (one can of course consider also electromagnetic transitions). This assumption is not testable since the rate of graviton induced transitions is extremely low. This result together with the vision about quantum theory as a square root of thermodynamics suggests that one must consider a modification of EG such that it allows gravitons and try to assign entropy and temperature to some real systems.

- (c) Suppose that one takes EG formulas seriously but accepts the existence of gravitons. EG should be understandable in terms of the classical space-time correlates of gravitational interaction assignable to virtual gravitons with space-like momenta. Could virtual gravitons mediating the gravitational flux through a hologram surface be responsible for the gravitational entropy?

Could one assign entropy to the gravitons inside flux tube like structures from the source and traversing the holographic screen and carrying virtual gravitons with wave length much shorter than the distance to source so that quantum coherence for gravitons is lost? If the density of entropy per unit length of the flux tube is constant, gravitational entropy is proportional to the length of flux tube from the source to the constant potential surface so that $S \propto \Phi_{gr} A$ hypothesis would follow as a consequence.

- (d) Why the temperature of graviton carrying flux tubes should be reduced as $1/r^2$ with distance in the case of a spherically symmetric source? Could the masses serve as heat sources creating thermal ensemble of gravitons? The virtual gravitons emitted at the source would be at certain temperature just as ordinary photons created in Sun. The gravitons flowing along the flux tubes would cool- maybe by the expansion of the transversal cross section of the flux tube- and the condition that heat is not created or absorbed in the empty space would imply $1/r^2$ behavior. The flux tubes carrying virtual gravitons would serve as counterparts of long strings in holographic argument. In TGD the string like objects indeed appear quite concretely.

- (e) By using reduced mass, gravitational temperature and entropy become symmetric as functions of the masses of two objects. This assumption makes sense only in many-sheeted space-time for which each pair of systems is characterized by its own flux tubes (space-time sheets) mediating the gravitational interaction. Also the notion of gravitational Planck constant proportional to $G M m$ makes sense only if it characterizes the flux tubes.

- (f) Unless the special nature of gravitational force as inertial force distinguishes gravitation from other interactions representing genuine forces, EG argument applies also in electrodynamics. The temperature in this case is proportional to the projection of the electric field which is in the direction of the normal of constant potential surface and has wrong sign for the second sign of the charge. Could the negative temperature implying instability relating somehow to the matter antimatter asymmetry? Antimatter and antimatter could not appear in same space-time region because either of them would give rise to negative temperature for flux tubes carrying virtual photons. In TGD framework similar outcome results also from totally different arguments and states that matter and antimatter should reside at different space-time sheets. Antimatter could be also dark in TGD sense. This point will be discussed in detail below and will be related to the generation of thermodynamical arrow of time which would be different for particles and antiparticles. In this case the reduced mass must be replaced with reduced charge $Q_1 Q_2 / (Q_+ Q_-)$ to achieve symmetry.

- (g) Could one say that in the GRANIT experiment [C23] giving support for the description of the neutron in Earth's gravitational field using Schrödinger equation the entropy of neutron plus screen is just the entropy associated with the Coulomb potential of Earth and neutron obtainable as $S(r) \propto (\phi_{gr, Earth} + \Phi_{gr, neutron}) A$? The gravitational potential appearing in the Schrödinger equation would be expressible essentially as the entropy per surface area and -as already noticed- this could be a mere accident having nothing to do with the real nature of gravitational force.

The assignment of entropy with the lines of generalized Feynman graphs is consistent with the replacement of S -matrix with M -matrix identified as a product of S -matrix and a Hermitian square root of density matrix commuting with S -matrix. These Hermitian square roots commute with S -matrix and generate infinite-D symmetry algebra of S -matrix defining a generalization of Yangian in ZEO since they are multi-local with respect to the partonic 2-surfaces located at the two light-like boundaries of CD . This algebra generated by zero energy states generalizes the twistorial Yangian and allowing CD s with integer multiples of basic scale one obtains a generalization of Kac-Moody algebra in which the non-commutative phase S^n generalizes the commutative phase factor $\exp(in\phi)$ of Kac-Moody algebra. Also vacuum functional can be interpreted as a complex square root of density matrix for ground states with Minkowskian part of Kähler action defining the phase and the exponent of Euclidian part defining the modulus.

Could gravity reduce to entropic force in long length scales?

The pessimistic view is that the possibility to regard gravitation as an entropic force is purely accidental and follows from the fact that gravitational potential happens to represent the density of gravitonic entropy per surface area and gravitonic temperature happens to be proportional to the normal component of the gravitational acceleration. On the other hand, one can develop an argument in which the absorption of virtual gravitons with wavelength must shorter than the distance between the two systems is analogous to radiation pressure and describable in terms of entropic gravity.

The proposal that both virtual and real gravitons are characterized by temperature and entropy is questionable in standard quantum theory. It however makes sense in ZEO in which S -matrix is replaced with M -matrix identifiable as a Hermitian square root of density matrix so that thermodynamics emerges even at the level of virtual particles. That it does so conforms with the fact that the basic building blocks of virtual particles are on mass shell massless particles. Allowing negative energies one can have also space-like net values of virtual momenta and virtual particles differ from incoming ones only in that the bound state conditions for masses is given up. The resulting powerful constraints on virtual momenta allowing to avoid both UV and IR divergences and justify twistorial description for both on mass shell particles and virtual particles.

Flux tube picture for gravitational interaction

Consider now the emission of gravitational radiation and its absorption allowing also virtual gravitons. In the picture about flux tubes as space-time sheets carrying gravitons between two objects there are two cases as I have discussed earlier but without realizing that these cases could correspond to non-entropic and entropic gravitation respectively.

Remark: The flux tube picture emerged from the attempt to understand why the gravitational Planck constant introduced by Nottale and taken seriously by me as characteristics of dark gravitons is proportional to the masses of Sun and planet: the explanation is that \hbar_{gr} is associated with flux tubes connecting these objects. It follows also from fractal string picture with string like objects identified as flux tubes.

In the minimal formulation the hierarchy of Planck constants coming as integer multiples of ordinary Planck constant and assigned to dark matter can be understood as an effective hierarchy due to the possibility of many-sheeted classical solutions of field equations with identical canonical momentum densities at various sheets implied by the huge vacuum degeneracy of Kähler action.

- (a) When the wavelength of gravitons is longer than that of flux tube, the graviton serves as a string connecting the systems (say ends of long bar, of the receiving system and source-not in practice) together and induces at classical level coherent oscillations of the relative distance.

In the detection of gravitational waves this kind arrangement should appear and typically appears. For instance, for millisecond pulsar the graviton wavelength is about 10^5 meters.

This would represent quantum realm in which entropic gravity does not apply. Classical description however works in accordance with quantum classical correspondence.

Remark: If one is ready to take seriously the idea about large gravitational Planck constant, the wavelengths would be very long and one would be practically always in this realm.

- (b) When the wave length of gravitons is shorter than flux tube, the graviton beam losses its coherence and is characterized by temperature and entropy and generates on the receiver something analogous to gravitational radiation pressure induced by virtual particles (this pressure is however negative for gravitation!). This would generate entropic force with definite direction since the momentum of virtual gravitons is of the same sign.
 - i. This would suggest that gravitational waves with wavelengths shorter than the size of the detector should not be detectable via standard empirical arrangements.
 - ii. A stronger condition would be that gravitational waves with wave lengths shorter than the distance between source and receiver cannot be detected: this would effectively conform with EG and predict that gravitational waves ill not be detected. This should have no practical consequences since even in the case of neutrons of GRANIT experiment the wavelength seems to be of order 10^5 meters from the peV energy scale of the bound states in Earth's gravitational field.
- (c) Entropic gravity is not in conflict with the geometrization of gravitational interaction since also thermodynamics should have space-time correlates by quantum classical correspondence. In accordance with stringy vision about short range gravitation, gravitational interaction in non-entropic realm is mediated by flux tubes connecting the masses involved and acting like strings.

The identification of the temperature and entropy

One can look at the situation also at more quantitative level. The natural guess for the temperature parameter would be as Unruh temperature

$$T_{gr} = \frac{\hbar}{2\pi} a , \quad (6.9.1)$$

where a is the projection of the gravitational acceleration along the normal of the gravitational potential = constant surface. In the Newtonian limit it would be acceleration associated with the relative coordinates and correspond to the reduced mass and equal to $a = G(m_1 + m_2)/r^2$.

One could identify T_{gr} also as the magnitude of gravitational acceleration. In this case the definition would involved only be purely local. This is in accordance with the character of temperature as intensive property.

The general relativistic objection against the generalization is that gravitation is not a genuine force: only a genuine acceleration due to other interactions than gravity should contribute to the Unruh temperature so that gravitonic Unruh temperature should vanish. On the other hand, any genuine force should give rise to an acceleration. The sign of the temperature parameter would be different for attractive and repulsive forces so that negative temperatures would become possible. Also the lack of general coordinate invariance is a heavy objection against the formula.

1. Gravitonic temperature in TGD Universe

In TGD Universe the situation is different. In this case the definition of temperature as magnitude of local acceleration is more natural.

- (a) Space-time surface is sub-manifold of the imbedding space and one can talk about acceleration of a point like particle in imbedding space $M^4 \times CP_2$. This acceleration corresponds to the trace of the second fundamental form for the imbedding and is completely well-defined and general coordinate invariant quantity and vanishes for the geodesics of the imbedding space. Since acceleration is a purely geometric quantity this temperature would be same

for flux sheets irrespective of whether they mediate gravitational or some other interactions so that all kinds of virtual particles would be characterized by this same temperature.

- (b) One could even generalize T_{gr} to a purely local position dependent parameter by identifying it as the magnitude of second fundamental form at given point of space-time surface. This would mean that the temperature in question would have purely geometric correlate. This temperature would be always non-negative. This purely local definition would also save from possible inconsistencies in the definition of temperature resulting from the assumption that its sign depends on whether the interaction is repulsive or attractive.
- (c) The trace of the second fundamental form -call it H - and thus T_{gr} vanishes for minimal surfaces. Examples of minimal surfaces are cosmic strings [?, ?] massless extremals, and CP_2 type vacuum extremals with M^4 projection which is light-like geodesic [?] Vacuum extremals with at most 2-D Lagrangian CP_2 projection has a non-vanishing H and this is true also for their deformations defining the counterpart of GRT space-time. Also the deformations of cosmic strings with 2-D M^4 projection to magnetic flux tubes with 4-D M^4 projection are expected to be non-minimal surfaces. Same applies to the deformations of CP_2 vacuum extremals near the region where the signature of the induced metric changes. The predicted cosmic string dominated phase of primordial cosmology [?]ould correspond to the vanishing gravitonic temperature. Also generic CP_2 type vacuum extremals have non-vanishing H .
- (d) Massless extremals define an excellent macroscopic space-time correlate for gravitons. The massivation of gravitons is however strongly suggested by simple considerations encouraged by twistorial picture and wormhole throats connecting parallel MEs define the basic building bricks of gravitons and would bring in non-vanishing geometric temperature, (extremely small but non-vanishing) graviton mass, and gravitonic entropy.
 - i. The M^4 projection of CP_2 type vacuum extremal is random light-like curve rather than geodesic of M^4 (this gives rise to Virasoro conditions [K11]). The mass scale defined by the second fundamental form describing acceleration is non-vanishing. I have indeed assigned this scale as well as the mixing of M^4 and CP_2 gamma matrices inducing mixing of M^4 chiralities to massivation. The original proposal was that the trace of second fundamental form could be identifiable as classical counterpart of Higgs field. One can speak of light-like randomness above a given length scale defined by the inverse of the length of the acceleration vector.
 - ii. This suggests a connection with p-adic mass calculations: the p-adic mass scale m_p is proportional to the acceleration and thus could be given by the geometric temperature: $m_p = nR^{-1}p^{-1/2} \sim \hbar H = \hbar a$, where $R \sim 10^4 L_{Pl}$ is CP_2 radius, and n some numerical constant of order unity. This would determine the mass scale of the particle and relate it to the momentum exchange along corresponding CP_2 type vacuum extremal. Local graviton mass scale at the flux tubes mediating gravitational interaction would be essentially the geometric temperature.
 - iii. Interestingly, for photons at the flux tubes mediating Coulomb interactions in hydrogen atom this mass scale would be of order $\hbar a \sim e^2 \hbar / m_p n^4 a_0^2 \sim 10^{-5} / n^4$ eV, which is of same order of magnitude as Lamb shift, which corresponds to 10^{-6} eV energy scale for $n = 2$ level of hydrogen atom. Hence it might be possible to kill the hypothesis rather easily.
 - iv. Note that momentum exchange is space-like for Coulomb interaction and the trace H^k of second fundamental form would be space-like vector. It seems that one define mass scale as $H = \sqrt{-H^k H_k}$ to get a real quantity.
 - v. This picture is in line with the view that also the bosons usually regarded as massless possess a small mass serving as an IR cutoff. This vision is inspired by zero energy ontology and twistorial considerations [K89]. The prediction that Higgs is completely eaten by gauge bosons in massivation is a prediction perhaps testable at LHC already during year 2011.

Remark: In MOND theory of dark matter a critical value of acceleration is introduced. I do not believe personally to MOND and TGD explains galactic rotation curves without any modification of Newtonian dynamics in terms of dark matter assignable to cosmic strings containing

galaxies like around it like pearls in necklace. In TGD framework the critical acceleration would be the acceleration above which the gravitational acceleration caused by the dark matter associated with the cosmic strings traversing along galactic plane orthogonally and behaving as $1/\rho$ overcomes the acceleration caused by the galactic matter and behaving as $1/\rho^2$. Could this critical acceleration correspond to a critical temperature T_{gr} - presumably determined by an appropriate p-adic length scale and coming as a power $2^{-k/2}$ by p-adic length scale hypothesis? Could critical value of H perhaps characterize also a critical magnitude for the deformation from minimal surface extremal? The critical acceleration in Milgrom's model is about 1.2×10^{-10} m/s² and corresponds to a time scale of 10^{12} years, which is of the order of the age of the Universe.

The formula contains Planck constant and the obvious question of the inhabitant of TGD Universe is whether the Planck constant can be identified with the ordinary Planck constant or with the *effective* Planck constant coming as integer multiple of it [?]

- (a) For the ordinary value of \hbar the gravitational Unruh temperature is extremely small. To make things more concrete one can express the Unruh temperature in gravitational case in terms of Schwarzschild radius $r_S = 2GMm$ at Newtonian limit. This gives

$$T_{gr} = \frac{\hbar}{4\pi r_S} \frac{M+m}{M} \left(\frac{r_S}{r}\right)^2 . \quad (6.9.2)$$

Even at Schwarzschild radius the temperature corresponds to Compton length of order $4\pi r_S$ for $m \ll M$.

- (b) Suppose that Planck constant is gravitational Planck constant $\hbar_{gr} = GMm/v_0$, where $v_0 \simeq 2^{-11}$ holds true for inner planets in solar system [?] This would give

$$T_{gr} = \frac{m}{8\pi v_0} \frac{M+m}{M} \left(\frac{r_S}{r}\right)^2 .$$

The value is gigantic so that one must assume that the temperature parameter corresponds to the minimum value of Planck constant. This conforms with the identification of the p-adic mass scale in terms of the geometric temperature.

2. Gravitonic entropy in TGD Universe

A good guess for the value of gravitational entropy (gravitonic entropy associated with the flux tube mediating gravitational interaction) comes from the observation that it should be proportional to the flux tube length. The relationship $dE = TdS$ suggests $S \propto \phi_{gr}/T_{gr}$ as the first guess in Newtonian limit. A better guess would be

$$S_{gr} = -\frac{V_{gr}}{T_{gr}} = \frac{M+m}{M} \frac{r}{\hbar m} , \quad (6.9.3)$$

The replacement $M \rightarrow M+m$ appearing in the Newtonian equations of motion for the reduced mass has been performed to obtain symmetry with respect to the exchange of the masses.

The entropy would depend on the interaction mediated by the space-time sheet in question which suggests that the generalization is

$$S = -\frac{V(r)}{T_{gr}} . \quad (6.9.4)$$

Here $V(r)$ is the potential energy of the interaction. The sign of S depends on whether the interaction is attractive or repulsive and also on the sign of the temperature. For a repulsive

interaction the entropy would be negative so that the state would be thermodynamically unstable in ordinary thermodynamics.

The integration of $dE = TdS$ in the case of Coulomb potential gives $E = V(r) - V(0)$ for both options. If the charge density near origin is constant, one has $V(r) \propto r^2$ in this region implying $V(0) = 0$ so that one obtains Coulombic interaction energy $E = V(r)$. Hence thermodynamical interpretation makes sense formally.

The challenge is to generalize the formula of entropy in Lorentz invariant and general coordinate invariant manner. Basically the challenge is to express the interaction energy in this manner. Entropy characterizes the entire flux tube and is therefore a non-local quantity. This justifies the use of interaction energy in the formula. In principle the dynamics defined by the extremals of Kähler action predicts the dependence of the interaction energy on Minkowskian length of the flux tube, which is well-defined in TGD Universe. Entropy should be also a scalar. This is achieved since the rest frame is fixed uniquely by the time direction defined by the time-like line connecting the tips of CD: the interaction energy in rest frame of CD defines a scalar. Note that the sign of entropy correlates with the sign of interaction energy so that the repulsive situation would be thermodynamically unstable and this indeed suggests that antimatter should have opposite arrow of time.

The sign of entropy for a Coulomb type interaction potential is always positive for the identification of T_{gr} as the normal component of gravitational acceleration whereas T_{gr} can be negative. If T_{gr} corresponds to the magnitude of the acceleration, entropy is negative for repulsive Coulomb interaction.

Negative temperatures/entropies for virtual bosons and the spontaneous generation of the arrow of time in ZEO

Negative entropies/temperatures are especially interesting from the point of ZEO in which causal diamonds (CDs) containing positive and negative energy states at their future and past light-like boundaries. Note that the term CD is used somewhat loosely about Cartesian product of CD and CP_2 . Note also that CD is highly analogous to Penrose diagram and defines causal unit in quantum TGD.

There is also a fractal hierarchy CDs within CDs and the minimum number theoretically motivated assumption is that the scales of CDs come as integer multiples of CP_2 scale. Poincare transforms of CDs with respect to another tip are allowed and the position of the second tip with respect to the first one is quantized for number theoretic reasons and corresponds to a lattice like structure in the proper time constant hyperboloid of M_+^4 . This has some highly non-trivial cosmological implications such as quantization of cosmic redshifts for which there is empirical evidence.

Both definitions lead to very similar predictions.

- (a) The identification of temperature T_{gr} as a scalar defined by the length of second fundamental form is favored in TGD framework. Entropy is defined in terms of interaction energy by the formula $S = -V/T_{gr}$. This definition can be defended in TGD Universe by Poincare invariance and general coordinate invariance. In this case temperature is always non-negative and entropy is positive for attractive interactions but negative for repulsive interactions. Therefore systems consisting mostly from matter or antimatter and having repulsive electromagnetic Coulomb forces have negative entropy and should be thermodynamically unstable. This would suggest that the arrow of time for these systems could be non-standard one in ZEO. For charge neutral systems entropy can be positive. It does not matter whether the system consists of matter or antimatter.
- (b) Second definition differs from the first one only in that T_{gr} is the magnitude of acceleration with a sign factor telling whether repulsion or attraction is in question. In this temperature can have both signs but entropy is always non-negative. For systems consisting dominantly of matter or antimatter with long range Coulomb interactions the temperature would be negative but entropy positive. This would suggest that the arrow of geometric time is

non-standard one. Again it does not matter whether the system consists of matter or antimatter.

The obvious idea is that the thermal instability could imply matter antimatter asymmetry. The original argument that antimatter and matter would correspond to opposite arrows of geometric time turned out to be wrong. One can however modify the argument to state that thermal instability leads to a generation of regions consisting preferentially of matter and antimatter and having non-standard arrow of geometric time so that from the point of view of standard arrow of geometric time these regions are formed rather than decay as second law would dictate. For definiteness the definition of geometric temperature as trace of the second fundamental form is assumed but the argument can be easily modified to the second case.

- (a) Does the negative entropy mean that the time evolutions assignable to the systems consisting mostly of matter (or antimatter) obeys opposite arrow of geometric time? From the point of view of observer with standard arrow of time these systems would obey second law in reverse direction of the geometric time. Spontaneous self assembly of biomolecules represents a standard example about this and the interpretation would be in terms of formation of structures consisting preferentially of matter or antimatter. Could this lead to a separation of antimatter to separate domains in the final states identifiable as negative energy parts of zero energy states? If so then matter matter antimatter asymmetry would relate to the purely geometric thermodynamics.
- (b) The arrow of geometric time emerges spontaneously in TGD Universe by a not too well-understood mechanism involving arguments from TGD inspired theory of consciousness. Thermodynamics must be involved since the sequence of quantum jumps identified as moments of consciousness induces the arrow of experienced time. Could it be that the arrow of geometric time is opposite for charged particles and antiparticles from thermodynamic stability?
 - i. Quite generally, positive energy parts of at past boundary of CD energy states would have definite particle number and also other quantum numbers whereas the outcome of measurement at future boundary dictated by M -matrix would be a superposition of final states at the opposite end of CD . This defines the arrow of geometric time as the direction of geometric time induced by that of thermodynamical time and experienced time defined in terms of a sequence of quantum jumps.
 - ii. What mechanism selects the light-like boundary of CD which corresponds to the initial prepared states with second one identified in terms of the outcome of the scattering process expressible as a superpositions of states with well defined particle numbers and also other quantum numbers? The mechanism should relate to the square root of density matrix appearing in M -matrix and therefore to entropy of virtual bosons consisting of basic building blocks which are on mass shell massless particles with both signs of energy assignable to what I call wormhole throats to be discussed below.
 - iii. The wrong sign of the entropy for systems consisting predominantly of matter or antimatter means they must have negative energies and second law realized as properties of zero energy states would correspond to opposite direction of geometric time allowed in TGD based generalization of thermodynamics. The arrow would emerge at scales longer than wavelength and would be therefore a macroscopic phenomenon if wavelength is taken as the borderline between microscopic and macroscopic.

How to circumvent the difficulties in generalizing EG to relativistic situation

One argument against EG is that it applies as such to Newtonian gravity only. The general coordinate invariant and Lorentz invariant definitions of T and S have been already considered and are favored in TGD framework and give always non-negative temperature depending only on purely local data. In the following the original definitions of T and S involving equi-potential surfaces in the case of T are considered.

To make the generalization in a coordinate invariant manner two physically preferred coordinates defined modulo diffeomorphism are required: time coordinate t allowing to identify gravitational

scalar potential Φ_{gr} as the deviation of g_{tt} from unity and radial coordinate orthogonal to the equipotential surfaces of Φ_{gr} so that Φ_{gr} itself could be regarded as the second preferred coordinate. This requires a slicing of space-time by 2-dimensional surfaces parametrized by (t, r) with remaining space-time coordinates regarded as constant for a given slice. The other two coordinates could define a dual slicing.

Entropy density $s_{gr} = dS_{gr}/dA$ per unit area of flux tube would be proportional to Φ_{gr} and a unique physical identification of the radial coordinate would be as proportional to the entropy $S_{gr}(r) = \int s_{gr} dA \propto \int \Phi_{gr} dA$ proportional to radial coordinate in the Newtonian limit. One should somehow specify what one precisely means with flux tube and here the area could be identified as the area inside which Kähler magnetic flux has definite sign if monopole flux is involved. If not then Kähler flux could take this role.

A possible identification of the preferred coordinates (t, r) is in terms of stringy slicing of the space-time surface by 2-D surfaces required by general consistency conditions. Strings would connect the points of partonic 2-surfaces carrying fermion number and the braids defining the orbits of these points would define string world sheets so that a rather concrete concretization of TGD as almost topological QFT would be obtained.

The physical interpretation of stringy slicing is in terms of integrable distribution of planes of non-physical polarization directions assignable to massless fields and orthogonal dual slicing would correspond to the directions of physical polarizations. The existence of the stringy slicing is motivated also by number theoretical considerations. The general ansatz for the preferred extremals leads to an identification of time preferred coordinate as a coordinate associated with the flow lines of conserved currents defining Beltrami flow. Second stringy coordinate could correspond to the direction for the gradient of gravitational field $\Phi_{gr} = g_{tt} - 1$ in accordance with the idea that gravitons flow along string like flux tubes and the polarizations of gravitons are orthogonal to the direction of their motion.

The translation of Witten's ideas about knots to TGD framework lead to the string worlds sheets could correspond to inverse images of geodesic spheres of CP_2 for the imbedding map of space-time surface to CP_2 . This would conform with the idea that wormhole throats are magnetic monopoles at the ends of stringy flux tubes.

6.9.2 The conceptual framework of TGD

There are several reasons to expect that something analogous to thermodynamics results from quantum TGD. The following summarizes the basic picture, which will be applied to a proposal about how to quantize (or rather de-quantize!) Einstein-Maxwell system with quantum states identified as the modes of classical WCW spinor field with spinors identifiable in terms of Clifford algebra of WCW generated by second quantized induced spinor fields of H .

- (a) In TGD framework quantum theory can be regarded as a "complex square root" of thermodynamics in the sense that zero energy states can be described in terms of what I call M -matrices which are products of hermitian square roots of density matrices and unitary S -matrix so that the moduli squared gives rise to a density matrix. The mutually orthogonal Hermitian square roots of density matrices span a Lie algebra of a subgroup of the unitary group and the M -matrices define a Kac-Moody type algebra with generators proportional to powers of S assuming that they commute with S . Therefore this algebra acts as symmetries of the theory.

What is nice that this algebra consists of generators multi-local with respect to partonic 2-surfaces and represents therefore a generalization of Yangian algebra. The algebra of M -matrices makes sense if causal diamonds (double light-cones) have sizes coming as integer multiples of CP_2 size. U -matrix has as its rows the M -matrices. One can look how much of this structure could make sense in GRT framework.

- (b) In TGD framework one is forced to geometrize WCW [K40] consisting of 3-surfaces to which one can assign a unique space-time surfaces as analogs of Bohr orbits and identified as preferred extremals of Kähler action (Maxwell action essentially). The 3-surfaces could be identified as the intersections space-time surface with the future and past light-like

boundaries causal diamond (CDs analogous to Penrose diagrams). The preferred extremals associated with the preferred 3-surfaces allow to realize General Coordinate Invariance (GCI) and its natural to assign quantum states with these.

GCI in strong sense implies even stronger form of holography. Space-time regions with Euclidian signature of metric are unavoidable in TGD framework and have interpretation as particle like structure and are identified as lines of generalized Feynman diagrams. The light-like 3-surfaces at which the signature of the induced metric changes define equally good candidates for 3-surfaces with which to assign quantum numbers. If one accepts both identifications then the intersections of the ends of space-time surfaces with these light-like surfaces should code for physics. In other words, partonic 2-surfaces plus their 4-D tangent space-data would be enough and holography would be more or less what the holography of ordinary visual perception is!

In the sequel the 3-surfaces at the ends of space-time and and light-like 3-surfaces with degenerate 4-metric will be referred to as *preferred 3-surfaces*.

- (c) WCW spinor fields are proportional to a real exponent of Kähler function of WCW defined as Kähler action for a preferred extremal so that one has indeed square root of thermodynamics also in this sense with Kähler essential one half of Hamiltonian and Kähler coupling strength playing the role of dimensionless temperature in "vibrational" degrees of freedom. One should be able to identify the counterpart of Kähler function also in General Relativity and if one has Einstein-Maxwell system one could hope that the Kähler function is just the Euclidian part of Maxwell action for a preferred extremal and therefore formally identical with the Kähler function in TGD framework. The phase factor from the Minkowskian contribution emerges naturally as one takes complex square root of the Boltzmann factor. The delicacies of this picture are discussed in [K93].

Fermionic degrees of freedom correspond to spinor degrees of freedom and are representable in terms of oscillator operators for second quantized induced spinor fields [K31]. This means geometrization of fermionic statistics. There is no quantization at WCW level and everything is classical so that one has "quantum without quantum" as far as quantum states are considered.

- (d) The dynamics of the theory must be consistent with holography. This means that the Kähler action for preferred extremal must reduce to an integral over 3-surface. Kähler action density decomposes to a sum of two terms. The first term is $j^\alpha A_\alpha$ and second term a boundary term reducing to integral over light-like 3-surfaces and ends of the space-time surface. The first term must vanish and this is achieved if the Kähler current j^α is proportional to Abelian instanton current

$$j^\alpha \propto *j^\alpha = \epsilon^{\alpha\beta\gamma\delta} A_\beta J_{\gamma\delta} \quad (6.9.5)$$

since the contraction involves A_α twice. This is at least part of the definition of preferred extremal property but not quite enough. Note that in Einstein-Maxwell system without matter j^α vanishes identically so that the action reduces automatically to a surface term.

- (e) The action would reduce reduce to terms which should make sense at light-like 3-surfaces. This means that only Abelian Chern-Simons term is allowed. This is guaranteed if the weak form of electric-magnetic duality [K31] stating

$$*F^{n,\beta} = kF^{n,\beta} \quad (6.9.6)$$

at preferred at light-like throats with degenerate four-metric and at the ends of space-time surface. These conditions reduce the action to Chern-Simons action with a constraint term realizing what I call weak form of electric-magnetic duality. One obtains almost topological QFT since the constraint term depends on metric. This is of course what one wants.

Here the constant k is integer multiple of basic value which is proportional to g_K^2 from the quantization of Kähler electric charge which corresponds to U(1) part of electromagnetic charge. Fractional charges for quarks require $k = ng_K^2/3$. Physical particles correspond to

several Kähler magnetically charged wormhole throats with vanishing net magnetic charge but with non-vanishing Kähler electric proportional to the sum $\sum_i \epsilon_i k_i Q_{m,i}$, with $\epsilon_i = \pm 1$ determined by the direction of the normal component of the magnetic flux for i :th throat. The first guess is that the length of magnetic flux tube associated with the particle is of order Compton length or perhaps corresponds to weak length scale as was the original proposal. The screening of weak isospin can be understood as magnetic confinement such that neutrino pair at the second end of magnetic flux tube screens the weak charged leaving only electromagnetic charge. Also color confinement could be understood in terms of flux tubes of length of order hadronic size scales. Compton length hypothesis is enough to understand color confinement and weak screening.

Note that $1/g_K^2$ factor in Kähler action is compensated by the proportionality of Chern-Simons action to g_K^2 . This need not mean the absence of non-perturbative effects coming as powers of $1/g_K^2$ since the constraint expressing electric magnetic duality depends on g_K^2 and might introduce non-analytic dependence on g_K^2 .

- (f) In TGD the space-like regions replace black holes and a concrete model for them is as deformations of CP_2 type vacuum extremals which are just warped imbeddings of CP_2 to $M^4 \times CP_2$ with random light-like random curve as M^4 projection: the light-like randomness gives Virasoro conditions. This reflects as a special case the conformal symmetries of light-like 3-surfaces and those assignable to the light-like ends of the CDs .

One could hope that this picture more or less applies for the GRT limit of quantum TGD.

6.9.3 What one obtains from quantum TGD by replacing space-times as surfaces with abstract 4-geometries?

It is interesting to see what one obtains when one applies TGD picture by replacing space-times as 4-surfaces with abstract geometries as in Einstein's theory and assumes holography in the sense that space-times satisfy besides Einstein-Maxwell equations also conditions guaranteeing Bohr orbit like property. The resulting picture could be also regarded as GRT type limit of quantum TGD obtained by dropping the condition that space-times are surfaces.

GRT is a more general theory than TGD in the sense that much more general space-times are allowed than in TGD - this leads also to difficulties - and one could also argue that the mathematical existence of WCW Kähler geometry actually forces the restriction of these geometries to those imbeddable in $M^4 \times CP_2$ so that the quantization of GRT type theory would lead to TGD.

What one wants?

What one wants is at least following.

- (a) Euclidian regions of the space-time should reduce to metrically deformed pieces of CP_2 . Since CP_2 spinor structure does not exist without the coupling of the spinors to Kähler gauge potential of CP_2 one must have Maxwell field. CP_2 is gravitational instanton and constant curvature space so that cosmological constant is non-vanishing unless one adds a constant term to the Maxwell action, which is non-vanishing only in Euclidian regions. It is matter of taste, whether one regards V_0 as term in Maxwell action or as cosmological constant term in gravitational part of the action. CP_2 radius is determined by the value of this term so that it would define a fundamental constant.

This raises an interesting question. Could one say that one has a small value of cosmological constant defined as the average value of cosmological constant assignable to the Euclidian regions of space-time? The average value would be proportional to the fraction of 3-space populated by Euclidian regions (particles and possibly also macroscopic Euclidian regions). The value of cosmological constant would be positive as is the observed value. In TGD framework the proposed explanation for the apparent cosmological constant is different but one must remain open minded. In fact, I have proposed the description in terms of

cosmological constant also as a proper description in the approximation to TGD provided by GRT like theory. The answer to the question is far from obvious since the cosmological constant is associated with Euclidian rather than Minkowskian regions: all depends on the boundary conditions at the wormhole throats where the signature of the metric changes.

- (b) One can also consider the addition of Higgs term to the action in the hope that this could allow to get rid of constant term which is non-vanishing only in Euclidian regions. It turns out that only free action for Higgs field is possible from the condition that the sum of Higgs action and curvature scalar reduces to a surface term and that one must also now add to the action the constant term in Euclidian regions. Conformal invariance requires that Higgs is massless.

The conceptual problem is that the surface term from Higgs does not correspond to topological action since it is expressible as flux of $\Phi\nabla\Phi$. Hence the simplest possibility is that Kähler action contains a constant term in Euclidian regions just as in TGD, where curvature scalar is however absent. Einstein-Maxwell field equations however apply that it vanishes and is effectively absent also in GRT quantized like TGD.

- (c) Reissner-Nordström solutions are obtained as regions exterior to CP_2 type regions. In black hole horizons (when they exist) the 3- metric becomes light-like but 4-metric remains non-degenerate. Hence R-N solution cannot be directly glued to a deformed CP_2 type region at horizon but a transition region in which the determinant of 4-metric becomes zero must be present. The simplest possibility is that R-N metric is deformed slightly so that one has $g_{tt} = 0$ and $g_{rr} < \infty$ at the horizon. This surface would correspond to a wormhole throat in TGD framework. Most of the blackhole interior would be replaced with CP_2 type region. In TGD black hole solutions indeed fail to be imbeddable at certain radius so that deformed CP_2 type vacuum extremal is much more natural object than black hole. In the recent framework the finite size of CP_2 means that macroscopic size for the Euclidian regions requires large deformation of CP_2 type solution. For masses $M < Q/\sqrt{G}$ R-N metric has no horizons so that in the case of elementary particles the situation is more complex than this.

Remark: In TGD framework large value of \hbar and space-time as 4-surface property changes the situation. The generalization of Nottale's formula for gravitational Planck constant in the case of self gravitating system gives $\hbar_{gr} = GM^2/v_0$, where $v_0/c < 1$ has interpretation as velocity type parameter perhaps identifiable as a rotation velocity of matter in black hole horizon [K72, K61]. This gives for the Compton length associated with mass M the value $L_C = \hbar_{gr}/M = GM/v_0$. For $v_0 = c/2$ one obtains Schwarzschild radius as Compton length. The interpretation would be that one has CP_2 type vacuum extremal in the interior up to some macroscopic value of Minkowski distance. One can whether even the large voids containing galaxies at their boundaries could correspond to Euclidian blackhole like regions of space-time surface at the level of dark matter.

- (d) The geometry of CP_2 allows to understand standard model symmetries when one considers space-times as surfaces [K48]. This is not necessarily the case for GRT limit.
- i. In the recent case one has different situation color quantum numbers make sense only inside the Euclidian regions and momentum quantum numbers in Minkowskian regions. This is in conflict with the assumption that quarks can carry both momentum and color. On the other, color confinement could be used to argue that this is not a problem.
 - ii. One could assume that spinors are actually 8-component $M^4 \times CP_2$ spinors but this would be somewhat ad hoc assumption in general relativistic context. Also the existence of this kind of spinor structure is not obvious for general solutions of Einstein-Maxwell equations unless one just assumes it.
 - iii. It is far from clear whether the symplectic transformations of CP_2 could be interpreted as isometries of WCW in general relativity like theory [K40, K20, K31]. These symmetries certainly act in non-trivial manner on Euclidian regions but it is highly questionable whether this could give rise to a genuine symmetry. Same applies to Kac-Moody symmetries assigned to isometries of $M^4 \times CP_2$ in TGD framework. These symmetries are absolutely essential for the existence of WCW Kähler geometry in infinite-D context as already the uniqueness of the loop space Kähler geometries demonstrates [A49] (maximal group of isometries is required by the existence of Riemann connection).

Note that a generalization of Equivalence Principle follows in TGD framework from the assumption that coset representations of super-conformal symplectic algebra and super Kac-Moody algebra define conformally invariant physical states. The equality of gravitational and inertial masses follows from the condition that the actions of the super-generators of two algebras are identical. This also justifies the use p-adic thermodynamics [K54] for the scaling generator of either super-conformal algebra without a loss of conformal invariance.

- (e) One could argue that GRT limit does not make sense since in Minkowskian regions the theory knows nothing about the color and electroweak quantum numbers: there is only metric and Maxwell field. On the other hand, in TGD one has color confinement and weak screening by magnetic confinement. If the functional integral over Euclidian regions representing generalized Feynman diagrams is enough to construct scattering amplitudes, pure Einstein-Maxwell system in Minkowskian regions might be enough. All experimental data is expressible in terms of classical em and gravitational fields. If Weinberg angle vanishes in Minkowskian regions, electromagnetic field reduces to Kähler form and the interpretation of the Maxwell field as em field should make sense. The very tight empirical constraints on the value of Kähler coupling strength α_K indeed allow its identification as fine structure constant at electron length scale.
- (f) One can worry about the almost total disappearance of the metric from the theory. This is not a problem in TGD framework since all elementary particles correspond to many-fermion states. For instance, gauge bosons are identified as pairs of fermion and antifermion associated with opposite throats of a wormhole connecting two space-time sheets with Minkowskian signature of the induced metric. Similar picture should make sense also now.
- (g) TGD possesses also approximate super-symmetries and one can argue that also these symmetries should be possessed by the GRT limit. All modes of induced spinor field generate a badly broken SUSY with rather large value of \mathcal{N} (number of spinor modes) and right-handed neutrino and its antiparticle give rise to $\mathcal{N} = \infty$ SUSY with R-parity breaking induced by the mixing of left- and right handed neutrinos induced by the modified Dirac equation. This picture is consistent with the existing data from LHC and there are characteristic signatures -such as the decay of super partner to partner and neutrino- allowing to test it. These super-symmetries might make sense if one replaces ordinary space-time spinors with 8-D spinors.

Note that the possible inconsistency of Minkowskian and Euclidian 4-D spinor structures might force the use of 8-D Minkowskian spinor structure.

Basic properties of Reissner-Nordström metric

Denote the coordinates of M_+^4 by (m^0, r_M, θ, ϕ) and those of X^4 by (t, r_M, θ, ϕ) . The expression for Reissner-Nordström metric reads as

$$\begin{aligned}
 ds^2 &= A dt^2 - B dr_M^2 - r_M^2 d\Omega^2 , \\
 A &= 1 - \frac{r_s}{r_M} + \frac{r_Q^2}{r_M^2} , \quad B = \frac{1}{A} , \\
 r_s &= 2GM , \quad r_Q^2 = Q^2 G .
 \end{aligned} \tag{6.9.7}$$

Here the charge $Q^2 = g^2 q^2 = 4\pi\alpha\hbar q^2$ contains gauge coupling g for the Maxwell field. For Kähler field one would have $g = g_K$.

The metric has two horizons for large enough mass values corresponding to the vanishing of function A implying that the sphere at which the vanishing takes place becomes metrically effectively 2-dimensional light-like 3-surface analogous to the boundary of light-cone. Note however that the determinant of the 4-metric is non-vanishing but just the finiteness of the radial component of the metric (something rather natural) would make it vanishing if g_{tt} remains zero. The horizon radii are given by

$$r_{\pm} = \frac{r_s}{2} \left[1 \pm \sqrt{1 - \left(\frac{r_Q}{r_s}\right)^2} \right] . \quad (6.9.8)$$

r_{\pm} is real for

$$M \geq M_Q = \frac{Q}{\sqrt{G}} . \quad (6.9.9)$$

For smaller masses one has no horizons and naked singularity at origin. The imbeddability condition however implies that the imbedding fails below some critical radius.

Some general comments about the relation to TGD are in order [K85].

- (a) Reissner-Nordström metric has imbedding as a vacuum extremal but not as non-vacuum extremal for which induced Kähler field would appear as Maxwell field. Vacuum extremals which are very important in TGD framework have no counterpart in Maxwell-Einstein system, which forces to question the assumption that Einstein-Maxwell system could serve as a GRT type limit of TGD except at macroscopic scales defined by the mass condition.
- (b) The solution is not expected to describe the exterior metric of objects with $M < M_Q$ at short distances. For elementary particles one expects different space-time correlates of gravitational interaction. One might optimistically guess that this is the realm where TGD replaces General Relativity.
- (c) The determinant of the four metric is non-vanishing at the horizons so that they cannot correspond to wormhole throats. There must be a transition region within which the determinant of the metric goes to zero at both Euclidian and Minkowskian region. The transition region could be around either horizon of the Reissner-Nordström metric when these exist. For elementary particles the situation is different since R-N metric has no horizon in this case. The critical mass corresponds to a condensed matter blob with size scale of living cell and one can ask whether it might be possible to test experimentally whether something happens in the transition region.
- (d) Non-vacuum extremals of Kähler action are relevant near wormhole throats and an interesting and the behavior of radially symmetric extremal of Kähler action with induced Kähler form defining the Maxwell field is still an open question. This kind of extremal would serve as the first guess for a model of the exterior space-time of elementary particle but could be quite too simple. In fact, the light-likeness of wormhole throats suggests a more complex zitterbewegung like behavior so that stationarity and spherical symmetry would be quite too strong conditions on the metric.

It is interesting to apply the formula for the gravitational Planck constant [K72] to the lower bound for M . The formula reads as

$$\hbar_{gr} = \frac{GMm}{v_0}, \quad \frac{v_0}{c} < 1 . \quad (6.9.10)$$

The parameter v_0 has dimensions of velocity and for the space-time sheets mediating gravitational interaction between Sun and the three inner planets one has $v_0 \simeq 2^{-11}$. By writing the expression for M_Q as $M_Q = q\sqrt{\alpha_K}\hbar_{gr}\sqrt{G}$, where α_K can be assumed to be equal to fine structure constant, one finds that horizons exist only if the condition

$$q \leq \frac{v_0}{\sqrt{Gm\sqrt{\alpha_K}}} . \quad (6.9.11)$$

Therefore solar system would represent a genuine elementary particle like realm in which Reissner-Nordstöm like metric does not apply unless the electromagnetic charge is so small that it vanishes by its quantization, which is of course a non-realistic condition. This idealized argument suggests the smallness of the electric charge as a condition for the applicability of GRT type description and this indeed guarantees that space-time sheets are near vacuum extremals so that small deformation of Scwarschild metric should apply.

Reduction of the quantization of Kähler electric charge to that of electromagnetic charge

The best manner to learn more is to challenge the form of the weak electric-magnetic duality based on the induced Kähler form.

- (a) Physically it would seem more sensible to pose the duality on electromagnetic charge rather than Kähler charge. This would replace induced Kähler form with electromagnetic field, which is a linear combination of induced Kähler field and classical Z^0 field

$$\begin{aligned}\gamma &= 3J - \sin^2\theta_W R_{03} \ , \\ Z^0 &= 2R_{03} \ .\end{aligned}\tag{6.9.12}$$

Here $Z_0 = 2R_{03}$ is the appropriate component of CP_2 curvature form [L1]. For a vanishing Weinberg angle the condition reduces to that for Kähler form.

- (b) For the Euclidian space-time regions having interpretation as lines of generalized Feynman diagrams Weinberg angle should be non-vanishing. In Minkowskian regions Weinberg angle could however vanish. If so, the condition guaranteeing that electromagnetic charge of the partonic 2-surfaces equals to the above condition stating that the em charge assignable to the fermion content of the partonic 2-surfaces reduces to the classical Kähler electric flux at the Minkowskian side of the wormhole throat. One can argue that Weinberg angle must increase smoothly from a vanishing value at both sides of wormhole throat to its value in the deep interior of the Euclidian region.
- (c) The vanishing of the Weinberg angle in Minkowskian regions conforms with the physical intuition. Above elementary particle length scales one sees only the classical electric field reducing to the induced Kähler form and classical Z^0 fields and color gauge fields are effectively absent. Only in phases with a large value of Planck constant classical Z^0 field and other classical weak fields and color gauge field could make themselves visible. Cell membrane could be one such system [K26, K66]. This conforms with the general picture about color confinement and weak massivation.

The GRT limit of TGD suggests a further reason for why Weinberg angle should vanish in Minkowskian regions.

- (a) The value of the Kähler coupling strength must be very near to the value of the fine structure constant in electron length scale and these constants can be assumed to be equal.
- (b) Einstein-Maxwell limit would make sense only for a vanishing Weinberg angle in Minkowskian regions. A non-vanishing Weinberg angle would make sense in the deep interior of the Euclidian regions where the approximation as a small deformation of CP_2 makes sense.

Preferred extremal property for Einstein-Maxwell system

Consider now the preferred extremal property defined to be such that the action reduces to Chern-Simons action at space-like 3-surfaces at the ends of space-time surface and at light-like wormhole throats.

- (a) In Maxwell-Einstein system the field equations imply

$$j^\alpha = 0 \quad . \quad (6.9.13)$$

so that the Maxwell action for extremals reduces automatically to a surface term assignable to the preferred 3-surfaces. Note that Higgs field could in principle serve as a source of Kähler field but its presence does not look like a good idea since it is not present in the field equations of TGD and because the resulting boundary term is not topological.

- (b) The condition

$$J = k \times *J \quad (6.9.14)$$

at preferred 3-surfaces guarantees that the surface term from Kähler action reduces to Abelian Chern-Simons term and one has hopes about almost topological QFT.

Since CP_2 type regions carry magnetic monopole charge and since the weak form of electric-magnetic duality implies that electric charge is proportional to the magnetic charge, one has electric charge without electric charge as Wheeler would express it. The identification of elementary building blocks as magnetic monopoles leads in TGD context to the picture about particle as Kähler magnetic flux tubes having opposite magnetic charges at their ends. It is not quite clear what the length of the tubes is. One possibility is Compton length and second possibility is weak length scale and the color confinement length scale. Note that in TGD the physical charges reside at the wormhole throats and correspond to massless fermions.

- (c) CP_2 is constant curvature space and satisfies Einstein equations with cosmological constant. The simplest manner to realize this is to add to the action constant volume term which is non-vanishing only in Euclidian regions. This term could be also interpreted as part of Maxwell action so that it is somewhat a matter of taste whether one speaks about cosmological constant or not. In any case, this would mean that the action contains a constant potential term

$$V = V_0 \times \frac{(1 + \text{sign}(g))}{2} \quad , \quad (6.9.15)$$

where $\text{sign}(g) = -1$ holds true in Minkowskian regions and $\text{sign}(g) = 1$ holds true in Euclidian regions.

Note that for a piece of CP_2 V_0 term can be expressed is proportional to Maxwell action and by self-duality this is proportional to instanton action reducible to a Chern-Simons term so that V_0 is indeed harmless from the point of view of holography.

- (d) For Einstein-Maxwell system with similar constant potential in Euclidian regions curvature scalar vanishes automatically as a trace of energy momentum tensor so that no interior or surface term results and the only surface term corresponds to a pure Chern-Simons term for Maxwell field. This is exactly the situation also in quantum TGD. The constraint term guaranteeing the weak form of electric-magnetic duality implies that the metric couples to the dynamics and the theory does not reduce to a purely topological QFT.
- (e) In TGD framework a non-trivial theory is obtained only if one assumes that Kähler function corresponds apart from sign to either the Kähler action in the Euclidian regions or its negative in Minkowskian regions. This is required also by number theoretic vision. This implies a beautiful duality between field descriptions and particle descriptions.

This also guarantees that the Kähler function reducing to Chern-Simons term is negative definite: this is essential for the existence of the functional integral and unitarity of the theory. This is due to the fact that Kähler action density as a sum of magnetic and electric energy densities is positive definite in Euclidian regions. This duality would be very much analogous to that implied by the possibility to perform Wick rotation in QFTs. Therefore it seems natural to postulate similar duality also in the proposed variant of quantized General Relativity.

- (f) The Kähler function of the WCW would be given by Chern-Simons term with a constraint expressing the weak form of electric-magnetic duality both in TGD and General Relativity. One should be able regard also in GRT framework WCW as a union of symmetric spaces with Kähler structure possessing therefore a maximal group of isometries. This is an absolutely essential prerequisite for the existence of WCW Kähler geometry. The symmetric spaces in the union are labelled by zero modes which do not contribute to the line element and would represent classical degrees of freedom essential for quantum measurement theory. In TGD the induced CP_2 Kähler form would represent such degrees of freedom and the quantum fluctuating degrees of freedom would correspond to symplectic group of $\delta M_{\pm}^4 \times CP_2$.

The difference between TGD and GRT would be that light-like 3-surfaces for all possible space-times containing Euclidian and Minkowskian regions would be considered for GRT type theory. In TGD these space-times are representable as surfaces of $M^4 \times CP_2$. In TGD framework the imbeddability assumption is crucial for the mathematical existence of the theory since it eliminates space-times with non-physical characteristics. The problem posed by arbitrarily large values of cosmological constants is one of the basic problems solved by this assumption. Also mass density is sub-critical for cosmologies with infinite duration and critical cosmologies are unique apart from their duration and quantum critical cosmologies replace inflationary cosmologies.

- (g) Note that one could consider assigning the gravitational analog of Chern-Simons term with the preferred 3-surfaces: this kind of term is discussed by Witten in this classic work about Jones polynomial. This term is a non-abelian version of Chern-Simons term and one must replace curvature tensor with its contraction with sigma matrices so that 4-D spinor structure is necessarily involved. The objection is that this term contains second derivatives. In TGD spinor structure is induced from that of $M^4 \times CP_2$ and this kind of term need not make sense as such since gamma matrices are expressed in terms of imbedding space gamma matrices: among other things this resolves the problems caused by the non-existence of spinor structure for generic 4-geometries. The coupling to the metric however results from the constraint term expressing weak form of electric-magnetic duality.

The difference between TGD and GRT would be basically due to the factor of scattering amplitudes coming from the duality expressing electric-magnetic duality and due to the fact that induced metric in terms of H -coordinates and Maxwell potential is expressible in terms of CP_2 coordinates. The latter implies topological field quantization and many-sheeted space-time crucial for the interpretation of quantum TGD.

Could the action contain also Higgs part?

One could criticize Maxwell-Einstein action with cosmological constant non-vanishing only in Euclidian regions and ask whether a coupling to Higgs field could change the situation. This is not the case.

- (a) If the action contains also Higgs part, Einstein-Higgs part of the action must reduce to a surface term. The trace $G^{\alpha\beta}$ equals to the trace of the Higgs energy momentum tensor and one obtains

$$-kG = kR = -T \quad ,$$

and

$$T = -(\nabla\Phi)^2 + 4V(\Phi) = -L_H + 2V(\Phi) \quad .$$

This gives

$$L_H + kR = 2L_H - 2V(\Phi) \quad .$$

(b) The kinetic term of Higgs field can be written as

$$(\nabla\Phi)^2 = \nabla \cdot (\Phi\nabla\Phi) - \Phi\nabla^2\Phi .$$

The first term reduces to a surface term and second term can be expressed as

$$\Phi\nabla^2\Phi = -\Phi \frac{\partial V}{\partial\phi} .$$

Similar formula applies also if the number of Higgs components is higher than one.

The condition that only the surface term remains gives

$$-2V + \Phi \frac{\partial V}{\partial\Phi} = 0$$

giving

$$V(\Phi) = \frac{m^2}{2}\Phi^2 . \quad (6.9.16)$$

(c) The presence of constant term in V does not matter in field equations for Φ so that one can have

$$V(\Phi) = V_0 + \frac{m^2}{2}\Phi^2 . \quad (6.9.17)$$

In order to have both CP_2 like Euclidian regions and Reissner-Nordström type exterior solutions one must allow the Higgs potential to depend on the signature of the metric so that for massless Higgs favored by conformal invariance one would have

$$V(\Phi) = V_0 \times \frac{(1 + \text{sign}(g))}{2} , \quad (6.9.18)$$

where one has $\text{sign}(g) = -1$ for Minkowskian regions and $\text{sign}(g) = 1$ for Euclidian regions. V_0 would be a constant of nature coding for CP_2 radius about 10^4 Planck lengths.

Since the introduction of Higgs field does not allow to circumvent the introduction of a term having interpretation in terms of cosmological constant and since one loses topological QFT property, it seems that the idea about Higgs is not good.

Could ZEO and the notion of CD make sense in GRT framework?

The notion of CD is crucial in ZEO and one can ask whether the notion generalizes to GRT context. In the previous arguments related to EG the notion of ZEO plays a fundamental role since it allows to replace S -matrix with M -matrix defining "complex square root" of density matrix.

(a) In TGD framework CD s are Cartesian products of Minkowskian causal diamonds of M^4 with CP_2 . The existence of double light-cones in curved space-time would be required and it is not clear whether this makes sense generally. TGD suggest that the scales of these diamonds defined in terms of the proper time distance between the tips are integer multiples of CP_2 scale defined in terms of the fundamental constant V_0 (the more restrictive assumption allowing only 2^n multiples would explain p-adic length scale hypothesis but would not allow the generalization of Kac-Moody algebra spanned by M -matrices). The difference between boundaries of GRT CD s and wormhole throats would be that four-metric would not be degenerate at CD s.

- (b) The conformal symmetries of light-cone boundary and light-like wormhole throats generalize also now since they are due to the metric 2-dimensionality of light-like 3-surfaces. It is however far from clear whether one can have anything something analogous to conformal variants of symplectic algebra of $\delta M_{\pm}^4 \times CP_2$ and isometry algebra of $M^4 \times CP_2$.

Could one perhaps identify four-momenta as parameters associated with the representations of the conformal algebras involved? This hope might be unrealistic in TGD framework: the basic idea behind TGD indeed is that Poincare invariance lost in GRT is retained if space-times are surfaces in $H = M^4 \times CP_2$. The reason is that that super-Kac-Moody symmetries correspond to localized isometries of H whereas the super-conformal algebra associated with the symplectic group is assignable to the light-like boundaries $\delta M_{\pm}^4 \times CP_2$ of CD of H rather than space-time surface.

- (c) One could of course argue that some physical conditions on GRT -most naturally just the highly non-trivial mathematical existence of WCW Kähler geometry and spinor structure- could force the representability of physically acceptable 4-geometries as surfaces $M^4 \times CP_2$. If so, then also CD s would be the same CD s as in TGD and quantization of GRT would lead to TGD and all the huge symmetries would emerge from quantum GRT alone.

The first objection is that the induced spinor structure in TGD is not consistent with that natural in GRT. Second objection is that in TGD framework Einstein-Maxwell equations are not true in general and Einstein's equations can be assumed only in long length scales for the vacuum extremals of Kähler action. The Einstein tensor would characterize the energy momentum tensor assignable to the topologically condensed matter around these vacuum extremals and neither geometrically nor topologically visible in the resolution defined by very long length scale. If Maxwell field corresponds to em field in Minkowskian regions, the vacuum extremal property would make sense in scales where matter is electromagnetic neutral and em radiation is absent.

6.9.4 What can one conclude?

The previous considerations suggest that a surprisingly large piece of TGD can be applied also in GRT framework and raise the possibility about quantization of Einstein-Maxwell system in terms of Kähler geometry of WCW consisting of 3-geometries instead of 3-surfaces. One can even consider a new manner to understand TGD as resulting from the quantization of GRT in terms of WCW Kähler geometry in the space of 3-metrics realizing holography and making classical theory an exact part of quantum theory. Since the space-times allowed by TGD define a subset of those allowed by GRT one can ask whether the quantization of GRT leads to TGD or at least sub-theory of TGD. The arguments represented above however suggest that this is not the case. The generalization of S -matrix to a complex of U -matrix, S -matrix and algebra of M -matrices forced by ZEO gives a natural justification for the modification of EG allowing gravitons and giving up the rather nebulous idea about emergent space-time. Whether ZEO crucial for EG makes sense in GRT picture is not clear. A promising signal is that the generalization of EG to all interactions in TGD framework leads to a concrete interpretation of gravitational entropy and temperature, to a more precise view about how the arrow of geometric time emerges, to a more concrete realization of the old idea that matter antimatter asymmetry could relate to different arrows of geometric time (not however for matter and antimatter but for space-time sheets mediating attractive and repulsive long range interactions), and to the idea that the small value of cosmological constant could correspond to the small fraction of non-Euclidian regions of space-time with cosmological constant characterized by CP_2 size scale.

6.10 Could the measurements trying to detect absolute motion of Earth allow to test sub-manifold gravity?

The history of the modern measurements of absolute motion has a long - more than century beginning from Michelson-Morley 1887. The reader can find in web a list of important publications [E10] giving an overall view about what has happened. The earliest measurements assumed

aether hypothesis. Cahill identifies the velocity as a velocity with respect to some preferred rest frame and uses relativistic kinematics although he misleadingly uses the terms absolute velocity and aether. The preferred frame could galaxy, or the system defining rest system in cosmology. It would be easy to dismiss this kind of experiments as attempts to return to the days before Einstein but this is not the case. It might be possible to gain unexpected information by this kind of measurements. Already the analysis of CMB spectrum demonstrated that Earth is not at rest in the Robertson-Walker coordinate system used to analysis CMB data and similar motion with respect to galaxy is quite possible and might serve as a rich source of information also in GRT based theory.

In TGD framework the situation is especially interesting.

- (a) Sub-manifold gravity predicts that the effective light-velocity measured in terms of M^4 time taken for a light signal to propagate from point A to B depends on space-time sheet, on points A and B, in particular the distance between A and B. The maximal signal velocity determined in terms of light-like geodesics has this dependence because light-like geodesics for the space-time surface are in general not light-like geodesics for M^4 but light-like like curves. The maximal signal velocity is in general smaller than its absolute maximum obtained light-like geodesics of M^4 , depends on particle, and could be larger than for photon space-time sheets. This might explain neutrino super-luminality [C12] [K52].
- (b) Space-time sheets move with respect to larger space-time sheets and it makes sense to speak about the motion of solar system space-time sheet with respect to galactic space-time sheet and this velocity is in principle measurable. Maximal signal velocity can be defined operationally in terms of time needed to travel from point A to B using Minkowski coordinates of the imbedding space as preferred coordinates. It depends on pair of points involved: basically on the direction on and spatial distance along effectively light-like geodesic defined by the sum of the perturbations of the induced metric for the space-time sheets involved. The question is whether one could say something interesting about various experiments carried out to measure the absolute motion interpreted in terms of velocity of space-time sheet with respect to say galactic space-time-sheet.

Also in Special Relativity the motion relative to the rest system of a larger system is a natural notion. In General Relativistic framework situation should be the same but the mathematical description of the situation is somewhat problematic since Minkowski coordinates are not global due to the loss of Poincare invariance as a global symmetry. In practice one must however introduce linear Minkowski coordinates and this makes sense only if one interprets the general relativistic space-time as a perturbation of Minkowski space. This background dependence is in conflict with general coordinate invariance. For sub-manifold gravity the situation is different.

Could the measurements performed already by Michelson-Morley and followers could provide support for the sub-manifold gravity? This might indeed be the case as the purpose of the following arguments demonstrate. The basic results of this analysis are following.

- (a) The basic formulas for interferometer experiments using relativistic kinematics instead of Galilean one are same as the predictions of Cahill [E79] using different basic assumptions, and allow to conclude that already the data of Mickelson and Morley show the motion of Earth -not with respect to aether- but with galactic rest system.
- (b) The only difference is the appearance of the maximal signal velocity $c_{\#}$ for space-time sheet to which various gravitational fields contribute. In the static approximation sum of gravitational potentials contributes to $c_{\#}$.
- (c) This allows to utilize the results of Cahill [E79], who has carried out a re-analysis of experiments trying to detect what he calls absolute motion using these formulas. Cahill has also replicated [E80] the crucial experiments of Witte [E81].
- (d) The value of the velocity as well as its direction can be determined and the results from various experiments are consistent with each other. The travel time data demonstrate a periodicity due to the rotation of Earth and motion with respect a preferred frame identifiable as a galactic rest frame. The tell-tale signature is the periodicity of sidereal day instead of exact 24 hour periodicity. The travel time for photons shows fluctuations which

might be interpreted in terms of gravitational waves having fractal patterns. TGD view about gravitons would suggest that the emission takes place -not as a continuous stream- but in burst-wise manner producing fractal fluctuation spectrum. These fluctuations could show themselves as a jitter also in the neutrino travel times discovered by Opera collaboration [C12].

6.10.1 The predictions of TGD for the local light-velocity

An interesting question is what various experiments carried out during more than century could allow to conclude about TGD predictions and what they are.

Theoretical issues

One must answer several questions before one can make predictions.

- (a) The reduction of light velocity in the case that there are many space-time sheets whose M^4 projections intersect, is described using common M^4 coordinates for the space-time sheets. The induced metric for given space-time sheet is the sum of flat M^4 metric and CP_2 contribution identified as classical gravitational field. The hypothesis is that in good approximation a linear superposition for the effects of the gravitational fields holds true in the sense that a test particle having wormhole throat contacts to these space-time sheets experiences the sum of the gravitational fields of various sheets. Similar description holds for induced gauge fields.

From this one can identify the reduced light velocity in the static situation as $c_{\#} = \sqrt{g_{tt}}$. In a more realistic necessary non-local treatment one calculates the effective light-velocity by assuming that the orbit of massless state in geometric optics approximation is light-like geodesic for the sum of the metric perturbations: this line is not a light-like geodesic of any of the space-time sheets.

In the general the effective metric defined in this manner is not imbeddable as induced metric. This description of linear super-position allows to circumvent the basic objection against TGD, which is that induced metric and gauge fields are extremely strongly correlated since they are expressible in terms of CP_2 coordinates and their gradients and that the variety of metrics representable as induced metrics is extremely restricted. Same of course applies to gauge fields.

- (b) How the reduced light-velocity $c_{\#}$ relates to the reduced light-velocity in medium which is usually described by introducing the notions of free and polarization charges and magnetization and magnetization currents. In the simple situation when polarization tensor is scalar, refractive index n characterizes the reduction of the light velocity: $V = c_{\#}/n$. Since the reduction of maximal signal velocity due to sub-manifold is purely gravitational and its reduction in medium has an electromagnetic origin, one can argue that the two notions have nothing to do with each other. Hence $c_{\#}$ should be treated as a local concept possibly depending on direction of motion by taking the limit when light-like geodesic with respect to effective metric becomes infinitesimally short. This dependence can be deduced by comparing light-like geodesics emanating from a point and calculating the maximal signal velocity as a function of direction angles of the light-like geodesic and the spatial distance along it.
- (c) What happens to the boundary conditions between different media deduced from the structural equations of classical electrodynamics and Maxwell equations? For instance, does the refraction of light take place also when $c_{\#}$ changes? It might of course be that $c_{\#}$ changes only in astrophysical scales - maybe at the surfaces of astrophysical objects - and stays constant at the boundaries between two media in laboratory scale but nevertheless this issue should be understood. The safest guess is that at the level of kinematic local Lorentz invariance still holds true so that the tangential wave vectors identifiable in terms of massless momentum components are conserved at boundaries and one obtains law of refraction also now.

- (d) In TGD Universe space-time sheets can move with respect to each other and the larger space-time sheet defines the analog of absolute reference frame in this kind of situation. Also in cosmology one can assign to CMB radiation a specific frame and Earth indeed moves with respect to it rather than being at rest in the global Robertson-Walker coordinate system. For Earth solar system is one such frame. Galactic rest system is second such preferred reference frame. To both one can assign linear Minkowski coordinates, which play a special physical. The obvious question is whether this kind of motion could be detected and whether the measurements carried out to detect absolute motion could allow to deduce this kind of velocity with respect to galactic rest system.
- (e) The question is how photons in medium behave when this kind of motion is present. Assume that the medium is characterized by refractive index n so that one has $V = c_{\#}/n$ and that space-time sheet moves with respect to larger one by velocity v characterized by direction angles and magnitude. Here $c_{\#} < c_0$ is the maximal signal velocity at the space-time sheet. For definiteness assume that the larger space-time sheet corresponds to galaxy.
- i. In the measurements of light velocity the light propagates in medium with velocity $V < c_{\#} < c_0$, and the question is how to describe this mathematically. In his experiments Michelson assumed summation of velocities based on Galilean invariance. This is of course wrong and Special Relativity suggests summation of velocities according to the relativistic formula:

$$V \rightarrow V_1(v, u) \equiv \frac{V + vu}{1 + \frac{Vv}{c_{\#}^2}u} = \frac{V + vu}{V + \frac{v}{nc_{\#}}u} ,$$

$$V = \frac{c_{\#}}{n} , \quad u = \cos(\theta) . \quad (6.10.1)$$

Here θ is the direction of the light signal with respect to the velocity v . This formula might be justified in TGD framework: also photon has very small but non-vanishing mass and summation formula for velocities can be applied. This demands the assumption of local Lorentz invariance made routinely in General Relativity. Also it requires that the complex process of repeated absorption and emission of photons is described by a propagation of photon with the reduced velocity.

- ii. This predicts two effects which might be seen in the experiments trying to measure absolute velocity and its direction. Both solar and galactic gravitational field and also its perturbations - even gravitational waves- can affect the signal velocity via fluctuations in $c_{\#}$ deduced from the superposition of the perturbative contributions of CP_2 to the effective induced metric. Second effect is due to the change of the propagation time. This change depends on the propagation direction. Note however that also $c_{\#}$ in general has the directional dependence and only in the situation when the components g_{ti} vanish, this dependence is trivial. In the Newtonian approximation the assumption $g_{ti} \simeq 0$ is made and corresponds to the description of the situation in terms of gravitational potential.

Basic predictions

From the above summarized assumptions one can deduce the basic predictions for what should happen in various experiments measuring $c_{\#} < c_0$ and v .

- (a) One can have gravitational reduction or even increase of the light velocity from its standard value which need not corresponds to its absolute maximum. The model for neutrino superluminality assumes that $c_{\#}$ characterizes particle space-time sheets - perhaps massless extremals carrying the small deformations of CP_2 type vacuum extremals - topologically condensed aren magnetic flux tubes characterizing particles. For neutrinos one has $(c_{\#} - c_0)/c_0 \sim 10^{-5}$ where $c_0 < c$ is what we have used to call light-velocity in vacuum.
- (b) The variation of the propagation time visible in interferometer experiments as a variation of the position interference fringes with the direction of light signal demonstrates the possible dependence of the the light velocity on direction. This dependence is predicted for $n > 1$

only. The motion of Earth around Earth induces the variation of the angle θ even in the situation that the interferometer is not rotated.

It is straightforward to derive a formula for the difference of propagation times along orthogonal arms of the interferometer.

- (a) What determines the position of interference fringes is the quantity

$$r = \frac{\Delta T(v, \theta)}{T_0} , , T_0 = \frac{2L}{V} = \frac{2Ln}{c_{\#}} . \quad (6.10.2)$$

Here $T(0, 0)$ is back and form propagation time for interferometer arm of length L $v = 0$.

- (b) The time difference ΔT is the difference of times for the propagation back and forth along orthogonal interferometer arms of length L :

$$\begin{aligned} \Delta T &= T(v, \theta) - T(v, \theta + \pi/2) , \\ T(v, \theta) &= \frac{L}{V_1(v, u = \cos(\theta))} + \frac{L}{V_1(v, -u = \cos(\theta + \pi))} , \\ V_1(v, u) &= \frac{V + vu}{1 + \frac{Vv}{c_{\#}^2}u} , \quad u = \cos(\theta) , \quad V = \frac{c_{\#}}{n} . \end{aligned} \quad (6.10.3)$$

Assuming that $\beta = v/c_{\#}$ is small one obtains

$$\frac{\Delta T}{T_0} \simeq (n^2 - 1)\beta^2 \cos(2\theta) = (n^2 - 1)\left(\frac{v}{c_{\#}}\right)^2 \cos(2\theta) . \quad (6.10.4)$$

The formula contains also dependence on $c_{\#}$ and in principle the interferometer could allow to detect gravitational waves via their effect on $c_{\#}$. The formula is consistent with the formula proposed by Cahill [E79]. Unfortunately, I am unable to understand the argument of Cahill, who speaks about Lorentz contractions whereas the above arguments assumes just the relativistic addition formula for velocities.

- (c) For interferometer experiments using gas phase the deviation of n from unity is small: $n = 1 + \epsilon$, $\epsilon \ll 1$ and one can write in good approximation

$$\frac{\Delta T}{T_0} \simeq 2\epsilon\beta^2 \cos(2\theta) = 2\epsilon\left(\frac{v}{c_{\#}}\right)^2 \cos(2\theta) . \quad (6.10.5)$$

- (d) IThe Newtonian picture applied by Michelson-Morley and many followers the basic formula would be

$$\frac{\Delta T}{T_0} \simeq 2\beta^2 n^2 \cos(2\theta) . \quad (6.10.6)$$

Therefore the value of the velocity deduced by using TGD would be much larger than by using Newtonian kinematics and this means that the small anisotropy of $\beta \simeq 10^{-5}$ reported already by Michelson and Morley is amplified by a factor of order $\sqrt{1/\epsilon} \simeq 10^2/\sqrt{3}$. (one has $\epsilon \simeq 2.9 \times 10^{-4}$ for air and becomes of order $\beta \simeq 10^{-3}$ consistent with the value reported by of Torr and Kolen, De Witte, and Cahill in experiments using propagation of RF light in axial cable. Hence the claim of Cahill that already Michelson and Morley measured the anisotropy of velocity of light would make sense also in TGD framework when appropriately re-interpreted.

Second interesting situation corresponds to one-way and two-way propagation times measured for RF waves propagating along straight co-axial cables.

(a) In this case the relevant quantity is

$$\begin{aligned} r &= \frac{\Delta T}{T_0} = \frac{T(v, \theta) - T_0}{T_0} \\ &= \frac{1 + \frac{\beta u}{n}}{1 + \beta u n} - 1 \simeq \beta \left(\frac{1 - n^2}{n} \right) u - \beta^2 u^2, \\ n &= \frac{c_{\#}}{V}, \quad u = \cos(\theta). \end{aligned} \quad (6.10.7)$$

For $n = 1 + \epsilon$, $\epsilon \ll 1$ has in good approximation

$$\begin{aligned} r &\simeq -2\epsilon\beta u - \beta^2 u^2, \\ n &= \frac{c_{\#}}{V}, \quad u = \cos(\theta). \end{aligned} \quad (6.10.8)$$

If one writes $c_{\#} = (1 + \epsilon_{\#})c_0$ and $n_0 = 1 + \epsilon_0$ (no gravitational perturbations) one obtains in good approximation $\epsilon \simeq \epsilon_{\#} + \epsilon_0$. Again it is essential that r is proportional to the deviation $n - 1$.

(b) For two-way propagation time the relevant quantity is in the same approximation

$$\begin{aligned} r &= \frac{\Delta T}{2T_0} = \frac{T(v, \theta) + T(v, \theta + \pi) - 2T_0}{2T_0} \simeq -\beta^2 u^2 (n^2 - 1) \simeq -2\epsilon\beta^2 u^2, \\ u &= \cos(\theta). \end{aligned} \quad (6.10.9)$$

The linear term in β is absent in this expression defining the building block of the expression for r interferometer experiments.

All these formulas are consistent with those proposed by Cahill although the argument leading to them is different. The new element is of course the appearance of $c_{\#}$ bringing in the dependence of the maximal signal velocity on induced space-time metric and therefore gravitational effects.

What can one say about super-luminal neutrinos in this framework?

The proposed framework applies as such to super-luminal neutrinos reported by OPERA collaboration [C12].

- (a) $n = 1$ is natural for neutrinos so that no directional dependence from the velocity v with respect to the galactic frame is expected. The dependence of $c_{\#}$ on particle type and on the gravitational fields at other parallel space-time sheets could however explain both super-luminality and the observed jitter in the arrival time [C12].
- (b) The value of $c_{\#}$ depends on the primary space-time sheet along which the neutrinos propagate and could be larger than for the space-time sheets of photons. Massless extremal topologically condensed at the magnetic flux tubes with neutrinos represented by worm-hole contacts is a good candidate for neutrino space-time sheet pair. It is also possible that classical Z^0 fields affect the situation by giving rise to a cyclotron orbit [K52].
- (c) The presence of also other space-time sheets - in particular those assigned to Earth, Sun, and Galaxy - is possible and plausible and they contribute to $c_{\#}$. This contribution is precisely defined if one accepts that in common M^4 coordinates for space-time sheets the sum of CP_2 contributions to the effective metric determines the effective metric and therefore also $c_{\#}$. Also the fluctuations of the gravitational fields suggested by Cahill to have interpretation as gravitational waves affect $c_{\#}$ and therefore maximal signal velocity for neutrinos. The question which does not first come into mind is therefore whether the jitter in the neutrino propagation time is due to gravitational waves!

6.10.2 The analysis of Cahill of the measurements trying to measure absolute motion

The primary inspiration for looking various experiments related to the determination of absolute motion came from P. O. Ulianov's proposal described in article *The Witte Effect: The Neutrino Speed and The Anisotropy of the Light Speed, as Defined in the General Theory of Relativity* [E188].

Ulianov proposed that one could perhaps understand neutrino super-luminality in terms of Witte effect [E81]. This idea does not work as such. $n = 1$ is natural for neutrinos and would predict vanishing directional effect. If the directional effect is present it would be oscillatory behavior around a value, which is below c and would not allow super-luminality even momentarily. Fluctuations due to the variations of $c_{\#}$, which itself could be larger than for photon space-time sheets are however possible and could explain the observer jitter in the arrival time [C12].

The reading of this article led to the realization that delicate effects related to the many-sheeted space-time concept might have been observed already by Michelson and Morley, who indeed report a small anisotropy for the magnitude of the light velocity- something that TGD based view about maximal signal velocity indeed suggests. I also found that R. T. Cahill had come into similar thoughts so that I decided to study the articles of Cahill.

- (a) Cahill describes the history of the experiments trying to detect the absolute motion in his article *Absolute Motion and Gravitational Effects* [E79]. Cahill has his terminology and own views about the correct interpretation but the open-minded reader should not allow this to disturb too much.
- (b) A less technical article describing the contribution of De Witte is titled *The Roland De Witte 1991 Experiment (to the Memory of Roland De Witte)* [E81].
- (c) The article *A New Light-Speed Anisotropy Experiment: Absolute Motion and Gravitational Waves Detected* [E80] describes the measurement of Cahill himself using RF waves propagating along co-axial cable. The reader should not take the term "Absolute Motion" too emotionally since it can be replaced with relative motion of a small system with respect to much larger system. The formulas of Witte are also consistent with local Special Relativity although one can disagree about their derivation.

Re-analysis of old experiments by Cahill

There are two basic methods to measure the value of c and detect its possible dependence on the direction of travel. The interferometer experiments were used by Michelson and Morley [E27] and their followers. The measurements of propagation time for RF signal propagating in co-axial cable were carried out by Torr and Kolen, De Witte and by Cahill. Cahill reports [E81] that 7 interferometer experiments has been carried out during more than century.

Cahill has re-analyzed [E79] the earlier interferometer experiments using his theory and concluded that already these experiments reveal the motion with respect to some system - most naturally galactic rest frame - and allow to deduce the magnitude and direction of the velocity of motion. It must be emphasized that all this is consistent with special relativity: the formulas used are just the above formulas obtained by putting $c_{\#} = c$. Cahill's analysis applies therefore also to TGD predictions. The variability of $c_{\#}$ gives however additional liberty in interpretation.

- (a) Cahill analyzes the unpublished experiments of De Witte (1991) [E81]. RF travel time along co-axial cable was in question. Data was taken over 178 days. The experimental apparatus was already earlier used by Torr and Kolen and is described in detail. The length of the cable was $L = 1.5$ km. The frequency of radio waves was 5 MHz. The refractive index of the cable was $n = 1.5$. The signals were sent between clusters of atomic clocks along RF cable in synchronization purpose.

The value of the velocity $\beta = v/c$ derived by De Witte and later by Cahill himself, is about 400 km/s corresponding to $\beta \simeq 1.3 \times 10^{-3}$ and surprisingly large. The direction of β coincides with the direction of β given by right ascension ($\alpha = 5.2$ hr, $\delta = 67^{\circ}$) deduced

by Miller in this interferometer experiments 1932-1933. Cahill interprets β as the velocity of Earth with respect to galactic rest frame. De Witte did not yet realize the possibility of this interpretation. There are also fluctuations in the value of the velocity v deduce in this manner to be discussed later.

In TGD framework $\Delta T/T$ is proportional $\beta^2 = (v \cos(\theta)/c_{\#})^2$ and Earth's rotation causes the oscillatory variation of $\cos(\theta)$, which is indeed seen: see Fig. 1 of the article. Fluctuations in propagation time can be understood as being due to the fluctuations of $c_{\#}$.

- (b) Cahill re-analyzes [E79] the earlier interferometer experiments using what is equivalent with relativistic addition formula for the velocities applied to photons with $V < c$. All interferometer experiments have been regarded to be consistent with Special Relativity. Michelson and Morley (1887) and also Miller (1932-1933) however observed small fringe shifts but interpreted them as measurement errors.

- i. Miller found $v = 10$ km/s and also deduced the right ascension for the velocity as $(\alpha, \delta) = (5.2 \text{ hr}, 67^\circ)$. Cahill obtains $v = 420 \pm 30$ km/s from the re-analysis of Miller experiments and interprets it as a velocity with respect to galactic rest frame. CMB anisotropy corresponds to a motion with respect to "cosmic" rest frame and is 369 km/s in direction characterize by right ascension $(\alpha, \delta) = (11.20 \text{ hr}, -7.22^\circ)$, which differs Miller's direction.

Cahill improves his fit by introducing to velocity field corrections which he calls in-flows and defined from the formula $v^2 = \Phi_{gr}$ for Earth and Sun assuming that v is in radial direction. The corrections are measured using 10 km/s as a natural unit. The first guess is that these corrections might be understood in TGD framework in terms of the effect of the dependence of $c_{\#} = \sqrt{g_{tt}}$ in static approximation on the gravitational potentials of Earth and Sun.

- ii. The value of v from Michelson-Morley experiments using Galilean kinematics would be about $v = 9$ km/s gives $\beta = v/c \simeq 10^{-5}$. Cahill deduces the value of v using what reduces to relativistic kinematics and obtains $v = 328 \pm 50$ km/s. Cahill also performs a fit using Miller's velocity and direction and obtains what he regards as a good fit.
- iii. Cahill has also repeated the experiments of Witte with improved technology (2006) and reports the results in the article *A New Light-Speed Anisotropy Experiment: Absolute Motion and Gravitational Waves Detected* [E80] and obtains results consistent with those of Witte. Unfortunately the terminology of the title and the use of the taboo terms "absolute motion" and "aether" serving as deeply emotional signals for the members of the academic mainstream creates easily mis-interpretations. The motion is relative and most naturally relative to the galactic rest system.

Additional observations

Already Witte and later Cahill makes the following additional observations.

- (a) Already Witte observed that the effective velocity deduced from $\Delta T/T$ for one-way propagation time has an oscillatory behavior with a period consistent with the sidereal day suggesting that the fluctuation is caused by galactic gravitational field rather than being of solar origin. Hence v would have the most natural interpretation as a velocity for the motion with respect to galactic rest frame.
- (b) All these experimenters find fluctuations - "turbulence"- in the magnitude of the velocity v deduced using the basic formulas. The fluctuations are illustrated by Fig. 2 of the article [E81]. Cahill reports that the fluctuations have a fractal spectrum (in the sense that no scale is present).

The model of Cahill forces to assign these fluctuations to the velocity field v . The assumption that the velocity of a solar sized system could fluctuate so rapidly looks non-realistic. Cahill indeed introduces a modification of general relativity in which 3-space is the fundamental object and gravitational field is replaced by a velocity field so that the fluctuations of velocity field would correspond to those of gravitational field. Cahill also suggests the interpretation of the fluctuations as gravitational waves: this looks much more reasonable

than the fluctuations in velocity of Earth. Velocity field is assigned to what Cahill calls quantum foam. To me this idea does not look attractive.

Cahill seems to identify the density of the non-relativistic kinetic energy as gravitational potential: $v^2/2 = \Phi_{gr}$. In Newtonian theory this would correspond to the vanishing of the total energy density. In TGD framework the analog would be the identification of the phase in which Einstein's equations holds true as vacuum extremals for which the induced Kähler field vanishes. Any 4-surface with a CP_2 projection which is Lagrangian and thus at most 2-D sub-manifold of CP_2 satisfies this condition. $c_{\#} = c$ restriction leaves no other possibility.

In TGD framework the fluctuations can be assigned to $c_{\#}$ and therefore to gravitational potential in static approximation so that gravitational waves or their analogs could indeed be in question. Certainly gravitational waves should make themselves visible in $\Delta T/T$. $\Delta c_{\#}/c_{\#}$ for the fluctuations would be below 10^{-3} . The amplitude of the fluctuations seem quite large but the idea about the bursts of ordinary gravitons created in the decays of large \hbar gravitons very large energy might produce fractal spectrum.

- (c) Cahill correctly notices that the interpretation of the interferometer experiments proposed by Michelson and Morley and followers is wrong because a non-relativistic addition formula for the addition of velocities is used. Cahill re-interprets the experiments using formulas which are equivalent with those obtained by replacing Galilean addition of velocities with Lorentzian one, and finds that with his assumptions the findings of the earlier experiments conform with the findings from co-axial cable experiments.

I must admit that I do not understand the argument of Cahill. Cahill however concludes that ΔT must be proportional to $n(n^2 - 1)$ rather than n^3 and this implies that the value of β deduced from interferometer experiments is for $n \sim 1$ by a factor $n/\sqrt{n^2 - 1}$ larger than in Newtonian framework. Cahill also correctly notices that $n > 1$ is essential for a non-trivial effect so that only gas interferometers are capable of observing the motion with respect to galactic rest system. This is obvious from the relativistic additional formula for velocities.

- (d) Cahill as an honest experimentalist notices also that there is an issue, which is not understood at all in his interpretation. Optical fibers would provide an excellent manner to test the theory. Fiber can be in a form of loop and even 4 meter long fiber could be enough as Cahill notices.
- i. The amazing finding is that there is no directional effect in this case. Cahill calls this optical fiber effect [E80]. Anti-crackpot would of course immediately conclude that the case is closed. As an inhabitant of TGD Universe I have however learned to be very cautious in this kind of situations. There are two manners to reduce the local light velocity.
 - A. The standard manner is based on electromagnetic interactions and boils down to refractive index n .
 - B. The new manner relies on gravitational interactions and boils down to deviation of $c_{\#}$ from c_0 . This allows $c_{\#}$ to depend on condensed matter phase- parameters characterizing the material, to have a slow dependence on position in astrophysical scales, as well as the dependence on the direction of and spatial distance along light-like geodesic in the effective metric (involving sum over CP_2 contributions associated with various space-time sheets involved), and even the dependence on gravitational waves inducing time dependent modification of the effective metric.
 - ii. The conservative attitude is that $n = 1.5$ for the optical fiber at the static limit is due to electromagnetic interactions but that for the specific frequencies used in IR transmissions $n(f) \simeq 1$ holds true in excellent approximation. The use of index of refraction at the zero frequency limit would be simply wrong. If I have understood correctly the propagation without absorptions and reflections is the defining property of an ideal optical fibre. This would mean that the light at the frequencies considered propagates without any interactions except the reflections at the boundaries of the optical fiber.

- iii. Could the reduction of light velocity from c_0 for optical fiber be mostly due to the reduction of $c_{\#}$ so that in good approximation one would have $n = 1$? This hypothesis is rather radical and would mean that gravitational physics becomes an essential part of condensed matter physics. What one expects is refraction of gravitational waves and this is expected to take place in astrophysical rather than the scales of the everyday world. This proposal should be also consistent with the meaning of refractive index. In particular, the reduction of light velocity gravitational should give rise to the refraction of light waves also now. For these reasons this proposal does not look realistic.

6.10.3 Cahill's work in relation to TGD

Cahill has also introduced a theoretical framework to explain the findings of De Witte and re-interpreted interferometer experiments.

- (a) Cahill claims that the $v \sim 400$ km/s of Earth with respect to a galactic rest system explains roughly the findings of various experiments. To improve the fit Cahill introduces additional velocities which he interprets as velocities of quantum foam towards Sun and Earth respectively. Cahill seems to interpret gravitational potential as a density of non-relativistic kinetic energy per unit mass: $v^2/2 = \Phi_{gr}$. In TGD framework It might be possible to interpret these additional contributions to the velocity field as counterparts for the contributions of the gravitational potentials of Sun and Earth to the overall gravitational potential and affective $c_{\#}$ and providing it with a directional dependence.
- (b) If I have understood correctly Cahill assumes that Lorentz-Fitzgerald contraction occurs but in the Earth's rest system rather than in the rest system with respect to which Earth is moving. The motivation for the assumption is that in the rest system of galaxy time dilation would compensate Lorentz contraction completely. Cahill notices that the deviation of V from c is essential and gives rise to a non-trivial effect for interferometer which is not idealizable as empty space ($n = c/V > 1$). I must admit that I do not understand here Cahill's argument although he ends up with the same formula for $\Delta T/T$ as I do using relativistic addition formula for velocities.
- (c) Cahill has proposed what he calls quantum flow information theory of gravity [B25]. Cahill introduces velocity field v , which replaces gravitational potential: $v^2 \propto \Phi_{gr}$, where Φ_{gr} is Newtonian gravitational potential is the basic identification. The motivation is presumably the necessity to introduce radial inward velocities to Sun and Earth in order to improve the interpretation of the various experiments trying to detect absolute motion. Space-time is replaced with 3-space but special relativity is assumed to hold true. This of course makes the theory vulnerable to criticism and D. Martin has criticized Cahill's quantum flow information theory of gravity in *Comments on Cahills quantum foam inflow theory of gravity* [B53].
- (d) The quantum foam in-flow has a physical analogy in TGD framework. Gravitational acceleration involves real four-momentum transfer in TGD Universe. By quantum classical correspondence this transfer should have a space-time counterpart and could be realized in terms of topological field quanta, presumably magnetic flux tubes along which gravitons propagate. The attractiveness of gravitation means inward momentum flux. This picture has been applied to explain Allais effect [K85] in terms of the large Planck constant assignable to space-time sheets mediating gravitational interactions. I have also suggested that the gigantic value of gravitational Planck constant implies that large \hbar gravitons decay to bursts of ordinary gravitons and instead of a continuous flow of gravitons there would be bursts which would be probably interpreted as noise [K61]. This might even lead to a failure to detect gravitons. The evidence for the fluctuations in the spectrum of $\Delta T/T$ for the travel time in the experiments trying to detect absolute motion might conform with this interpretation.

So: What attitude should one take on Cahill?

- (a) Anti-crackpot would resolve the irritating cognitive dissonance by claiming that Torr and Kolen, Witte, and Cahill make the same systematic error in their measurements. Experimental apparatus is indeed essentially the same. Also the absence of the directional dependence for optical fibers provides a weapon for easy debunking.
- (b) The appearance of the sidereal day as a period produces problems for the anti-crackpot. Any systematic effect - say to temperature variations - would have exactly 24 hours period. Anti-crackpot can of course argue that the period is actually this and that sidereal day as period is due to a systematic error or wishful thinking. This is however not very convincing argument. What is also irritating is the fact that the simple formula of Cahill deducible directly from the relativistic formula for the addition of velocities allows to understand satisfactorily all experiments in terms of single velocity β in direction determined by Miller. Could it be that the experiments are right and there is indeed a motion of Earth relative to galaxy causing non-trivial effects?
- (c) Anti-crackpot might also argue that the model used by Cahill to analyze the experiments is wrong so that the whole issue should be forgotten. Basic formulas are however consistent with special relativity. To my opinion the other notions introduced by Cahill might be seen as an attempt to right direction and could have interpretation in terms of $c_{\#}$ interpreted in terms of a sum of gravitational potentials at the static limit. The genuine new element is that local light velocity can be affected also by gravitation besides electromagnetic effects.

I have nothing personal against theorists but my own conclusion based on experience of decades is that I trust more on experimentalists than theorists. Cahill and his predecessors are excellent experimentalists and might have been able to make discoveries much before the time is ripe for them. These experiments not only give direct support for TGD but could even provide new approach to detect time dependent gravitational perturbations and perhaps even gravitational waves. Although I cannot agree with the theoretical proposals of Cahill, I must admit that they have analogs in TGD framework.

6.11 Miscellaneous topics

I have collected in this section miscellaneous topics for which I have not found any natural place in preceding sections.

6.11.1 Michelson Morley revisited

The famous Michelson-Morley experiment [E27] carried out for about century ago demonstrated that the velocity of light does not depend on the velocity of the source with respect to the receiver and killed the ether hypothesis. This could have led to the discovery of Special Relativity. Reality is not so logical however: actually Einstein ended up with his Special Relativity from the symmetries of Maxwell's equations. Amusingly, for hundred years later Sampo Pentikäinen told me about a Youtube video reporting a modern version of Michelson-Morley experiment by Martin Grusenick [E145] in which highly non-trivial results challenging the general relativistic view about the nearby gravitational fields of astrophysical objects are reported.

To my best knowledge there is no written document about the experiment of Martin Grusenick in web but the Youtube video [E145] is excellent. The reader willing to learn in more detail how Michelson-Morley interferometer works might find Youtube videos [E3] interesting. The result could be an artifact of the experimental arrangement, and it indeed turned out that the attempt of Frank Pierce to reproduce the effect one year later failed. Pierce also demonstrates in his video [E119] a possible reason for the artefact. I decided however to keep this section as it was since the attempt to explain this probably non-existing effect led to a considerable increase in the understanding of zero energy ontology.

Experimental arrangement and results

Grusenick's interferometer [E145] uses green light (532 nm wavelength) with 5 mW power from a laser powered by a battery. The light from the laser arrives at a beam splitter at angle of 45 degrees with respect to the beam direction and decomposes to two beams in directions orthogonal to each other. These beams are reflected back at mirrors having same distance from the splitter and combine again at beam splitter and travel to what to my best understanding should be a concave mirror magnifying and reflecting the interference pattern to a plywood screen. Also the longer video demonstrates that the mirror must be concave. Grusenick however talks about planar mirror but this cannot be the case if the mirror is orthogonal to the incoming beam as it seems to be (in the German version of the video he uses "einfach" instead of "planar" so that a linguistic lapsus or wrong pattern recognition on my side is probably in question). Video camera records the time development of the interference pattern as the arrangement mounted to a rotating tripod is rotated in plane. The plane is parallel to the Earth's surface in the first experiment and orthogonal to it in the second one.

When the rotation takes place in the plane parallel to the surface of Earth the interference pattern remains stationary during rotation. This is the result that Michelson obtained for 100 years ago. When the plane of rotation is orthogonal to the surface of Earth situation changes dramatically, and there is a clear shift of the interference pattern depending on the angle of rotation. The effect cannot be explained as being due to a motion of Earth with respect to ether since the direction of motion would be orthogonal to the Earth's surface at the measurement point and can be so only at certain measurement times since Earth rotates.

When the rotation plane is orthogonal to the surface of Earth one finds following.

- (a) The maximum shift of the interference pattern corresponds to 11-11.5 peaks which translates to a distance difference of 22-23 wavelengths from the beam splitter to the two orthogonal reflecting mirrors. The corresponding distance is $x = 11.70 - 12.23 \mu\text{m}$. I do not know the precise distance between the beam splitter and mirror. If it equals to $l = .1$ meters, the difference in distance generated during the travel from the splitter to a mirror and back can be expressed as $x/l = x \times 10^{-5} \sim 10^{-4}$. From the point of view of the failing ether hypothesis this would mean $v/c \sim 10^{-4}$.
- (b) The shift for the interference pattern becomes stationary and changes sign when the splitter is parallel to the Earth's surface. The vertical distances from the splitter to the mirrors are the same at this point. The maximum shift occurs when the beam splitter forms angle of 45 degrees with the Earth's surface. In this situation the vertical distance difference is maximum since the first mirror is in vertical direction and second mirror in horizontal direction.
- (c) There is also a slight dependence on time of day.

The result might have a trivial explanation. The changes of the distance are rather small: of order 10 microns. Suppose that contraction is in question. In TGD framework there are two distances involved: M^4 distance and the distance defined by the induced metric. The M^4 distance between mirror and splitter in vertical position might shorten by a contraction due to the weight of the system. Alternatively the contraction (if contraction is in question) could correspond to a shortening of the length in the induced metric leaving Minkowski distance invariant. One must estimate the shortening due to the weight of the system to clarify this issue.

Estimate for the change of distance implied by elasticity

The elasticity of the steel plate at which the system is mounted induces by its own weight a change of the vertical distance between beam splitter and mirror above it. Since only order of magnitude estimate is in question, the effects of the instruments mounted on the steel plate are not taken into account in the model so that system (steel plate) is effectively one-dimensional.

- (a) Using standard elasticity theory in one-dimensional situation [D1], one can express the counterpart for Newton's equations for an effectively one-dimensional elastic medium in a static equilibrium under its own gravitational force as

$$E\partial_z^2 u + \rho g = 0 \quad (6.11.1)$$

Here u denotes displacement, and E is Young's modulus. ρ is the mass density of the medium and g is the acceleration of gravity at the surface of Earth. The equation states that gravitational force is compensated by the atomic forces modeled using a linear force density $f = E\partial_z^2 u$.

- (b) From this equation one can solve the displacement $u(z)$ as

$$u(z) = -\frac{\rho g z^2}{2E} + bz + c \quad (6.11.2)$$

At the bottom of the plate one has $u(0) = 0$. If one has also $(du/dz)(0) = b = 0$ implied by the condition that momentum current in the vertical direction vanishes at the upper end, one obtains

$$u(z) = -\frac{\rho g z^2}{2E} \quad (6.11.3)$$

This gives for the change of the distance between beam splitter and mirror in vertical position the estimate

$$\Delta h = -\frac{\rho g (h_2^2 - h_1^2)}{2E} \quad (6.11.4)$$

- (c) A rough estimate for the relevant parameters of the system are following. The height of the steel plate is $h \simeq .5$ m. The height of the beam splitter is $h \simeq .25$ m and the height of the mirror at maximum height is $h \simeq .35$. The density of steel is $\rho \simeq 8 \times 10^3$ kg/m³. Young's modulus for steel is $E = 2 \times 10^{11}$ N/m². This gives the estimate $\Delta h = 1.2 \times 10^{-8}$ m, which is by three orders of magnitude smaller than the estimated distance difference.

Schwarschild metric does not explain the result

In the framework of general relativity the only manner to understand these effects is in terms of distance difference along vertical and horizontal directions. This difference would be due to the deviation of the space-time metric from Minkowski metric in such a manner that the distance in radial direction is changed due to the presence of gravitational field of Earth.

- (a) One can start from the Schwarschild metric as an idealized model for the situation outside the surface of Earth (I use units with $c = 1$).

$$\begin{aligned} ds^2 &= K dt^2 - \frac{1}{K} dr^2 - r^2(d\theta^2 + \sin^2(\theta)d\phi^2) \ , \\ K &= 1 - \frac{r_s}{r} \ , \ r_s = 2GM \ . \end{aligned} \quad (6.11.5)$$

Here M denotes the mass of Earth and r the distance from the center of mass of Earth. r_s is Schwarschild radius. At the Earth's surface ($r = R$) one has $r_s c^2 / R^2 \simeq g = 10$ m/s², the gravitational acceleration at the surface of Earth. For $M = 0$ one obtains Minkowski metric and no effect.

- (b) The maximum distance difference x would correspond to

$$\begin{aligned} \frac{x}{l} &= 2 \frac{\int_R^{R+l} (\sqrt{\frac{1}{K}} - 1) dr}{l} \ , \\ K &= 1 - \frac{r_s}{r} \ , \ r_s = 2GM \ . \end{aligned} \quad (6.11.6)$$

Here r_s denotes the Schwarzschild radius and $R \simeq 6371\text{km}$ the Earth's radius. $l \sim .1\text{ m}$ is the Minkowskian distance between beam splitter and mirror. Since the value of K is extremely small, the integral can be evaluated easily and gives (not surprisingly)

$$\frac{x}{l} \simeq \frac{r_s}{R} = \frac{2gR}{c^2} \simeq 1.4 \times 10^{-9} . \quad (6.11.7)$$

The predicted value is by a factor of order 10^{-5} too small if one assumes $l = .1\text{ m}$.

The modification of Schwarzschild metric explaining the result

If the finding of Grusenick is real it means that the value of g_{rr} at the Earth's surface is much larger than for Schwarzschild metric. One cannot exclude a large deviation of g_{rr} from the prediction of Schwarzschild metric also in the case of stars by what is known about planetary orbits. The point is that for exactly circular orbits g_{rr} does not appear at all in the equations determining the orbits since $dr = 0$ holds true for these orbits. For elliptic orbits the effects are in principle visible and Mercury's perihelion shift poses bounds on the deviation.

- (a) To see what the needed deviation means quantitatively it is convenient to parameterize the deviation as

$$g_{rr} \rightarrow (1 + \Delta(r))g_{rr} = -(1 + \Delta(r))\frac{1}{K} . \quad (6.11.8)$$

Restricting the consideration to the free fall near the Earth's surface one can perform the approximation $\Delta(r) \simeq \Delta(R)$. The value of Δ is fixed by the results of the experiment of Grusenick to be of order

$$\Delta(R) \simeq 5 \times 10^{-4} \quad (6.11.9)$$

if the distance between the mirror and beam splitter is taken to be .1 m (the estimate for the distance is by bare eyes from the video).

- (b) Einstein's equations for a free fall in radial direction give

$$\begin{aligned} \frac{d^2t}{ds^2} + 2\left\{ \begin{matrix} t \\ r r \end{matrix} \right\} \frac{dt}{ds} \frac{dr}{ds} &= 0 , \\ g_{tt}\left(\frac{dt}{ds}\right)^2 + g_{rr}\left(\frac{dr}{ds}\right)^2 &= 1 . \end{aligned} \quad (6.11.10)$$

- (c) The first equation can be integrated to give

$$\frac{dt}{ds} = \frac{C}{g_{tt}} = \frac{C}{1 - K} . \quad (6.11.11)$$

The result is same as for Schwarzschild metric. The constant C is determined by the initial height in free fall.

- (d) The second equation expresses the conservation of energy. One can solve dr/ds from it in terms of E and g_{rr} . For Schwarzschild metric one obtains

$$\left(\frac{dr}{ds}\right)^2 - \frac{K}{r} = C^2 - 1 \equiv 2E . \quad (6.11.12)$$

The interpretation in terms of energy conservation is obvious. For the modified metric one obtains

$$\left(\frac{dr}{ds}\right)^2 - (1 + \Delta)\frac{K}{r} = (1 + \Delta)2E . \quad (6.11.13)$$

The results is same as obtained for Schwarzschild metric if the value of the Newton's constant G and and energy E are replaced with effective values given by

$$G_{eff} = (1 + \Delta)G , \quad E_{eff} = (1 + \Delta)E . \quad (6.11.14)$$

- (e) The dependence on time of day might reflect a similar contribution of the gravitational field of Sun to the gravitational field if the radial component of Sun's gravitational field has similar behavior. From the $1/r$ dependence of Δ the order of magnitude for the additional contribution assuming $\Delta_S(R_S) = \Delta(R)$ (R_S denotes solar radius and r_E the distance of Earth from Sun in the following formula) would be given by

$$\frac{\Delta_S(r_E)}{\Delta(R)} \sim \frac{R_S}{r_E} \sim 4.6 \times 10^{-2} . \quad (6.11.15)$$

Therefore the effect of Sun could be visible in the interference pattern and would be maximal when the Sun the measurement point and Sun are at same line and minimal when the the normal of Earth is orthogonal to the line connecting Earth with Sun.

For a free fall in a direction orthogonal to the surface of Earth the effect is maximum since g_{rr} is visible in the geodesic equations of motion and means that the effective value of GM estimated in this manner would differ from its actual value. There are several manners, such as Cavendish experiment [E8] to measure G and from the measured value of g to deduce also the value of M . The values of G however vary in surprisingly wide range [E51] with variations up to one per cent. If similar behave holds true also for the gravitational fields of masses used in the experiments determining the value of G , it might be possible to understand these deviations.

What can one conclude about $\Delta(r)$ if the mass density remains zero outside the Earth's surface?

An interesting question is what one can conclude about $\Delta(r)$ by assuming that G^{tt} component for Einstein's tensor remains zero.

- (a) For a spherically symmetric metric parameterized as

$$ds^2 = Bdt^2 - A dr^2 - r^2 d\Omega^2 \quad (6.11.16)$$

the expressions for the components of Einstein tensor for spherically symmetric stationary metric are deduced in this this chapter and given by

$$\begin{aligned} G^{rr} &= \frac{1}{A^2} \left(-\frac{\partial_r B}{Br} + \frac{(A-1)}{r^2} \right) , \\ G^{\theta\theta} &= \frac{1}{r^2} \left[-\frac{\partial_r^2 B}{2BA} + \frac{1}{2Ar} \left(\frac{\partial_r A}{A} - \frac{\partial_r B}{B} \right) \right. \\ &\quad \left. + \frac{\partial_r B}{4AB} \left(\frac{\partial_r A}{A} + \frac{\partial_r B}{B} \right) \right] , \\ G^{tt} &= \frac{1}{AB} \left(-\frac{\partial_r A}{Ar} + \frac{(1-A)}{r^2} \right) . \end{aligned} \quad (6.11.17)$$

- (b) In the recent case one obtains

$$\begin{aligned}
G^{tt} &= -\frac{1}{(1+\Delta)r^2} \times \left(\frac{r\partial_r\Delta}{1+\Delta} + \frac{\Delta}{1-\frac{r_s}{r}} \right) , \\
G^{rr} &= \frac{\Delta}{(1+\Delta)r^2} \left(1 - \frac{r_s}{r} \right) , \\
G^{\theta\theta} &= \frac{\partial_r\Delta}{2(1+\Delta)r^3} \times \left(2 - 3\frac{r_s}{r} \right) , \\
r_s &= 2GM .
\end{aligned} \tag{6.11.18}$$

$r_s = 2GM$ denotes Schwarzschild radius.

- (c) If one requires that the mass density outside the Earth's radius vanishes one obtains $G^{tt} = 0$ giving the differential equation

$$\frac{\partial_r\Delta}{\Delta(1+\Delta)} = -\frac{1}{r\left(1-\frac{r_s}{r}\right)} . \tag{6.11.19}$$

The solution is

$$\Delta(r) = \frac{X}{1-X} , \quad X = \frac{R}{r} \times \frac{1-\frac{r_s}{R}}{1-\frac{r_s}{r}} \times \frac{\Delta(R)}{1+\Delta(R)} . \tag{6.11.20}$$

The deviation approaches zero like $1/r$. The effects on planetary orbits would be negligible in the case that this expression holds true in case of Sun with same order of magnitude for Δ . Only when the orbits is very near to the surface of the star the situation changes. This situation might prevail for some exoplanets.

- (d) If the deviation is due the interaction of the massive body with the external world, it is dictated in the first approximation by the average density of matter in cosmos and by the geometry of the body meaning that the function $\Delta(r)$ for $r \gg R$ is universal and therefore same for all systems.

Is the proposal consistent with causality?

The general expressions for the Einstein tensor listed above allow to deduce how the "pressure" components G^{rr} and $G^{\theta\theta}$ of the Einstein tensor are affected. $G^{tt} = 0$ combined with non-vanishing of "pressure" components of $G^{\alpha\beta}$ seems to break causality. It is also at odds with the general wisdom about the structure of a typical energy momentum tensor of matter. The attempt to understand what is involved induces a series of arguments and counter arguments leading to what seems to provide a deeper understanding of Einstein's equations in zero energy ontology and also of the notion of virtual particle as well as the realization of twistor program in TGD framework.

- (a) In TGD framework one has sub-manifold gravity for which Einstein equations hold true at long length scale limit with the constraint space-time surfaces are extremals of Kähler action. The Schwarzschild coordinates (t, r, θ_M, ϕ_M) for the imbedding of Schwarzschild solution in $M^4 \times CP_2$ are related to Minkowski coordinates (m^0, r_M, θ, ϕ) by the conditions $(m^0 = \Delta t + h(r_M), r_M = r, \theta_M = \theta, \phi_M = \phi)$. As a consequence, the time component of the energy momentum tensor is non-vanishing in Minkowski coordinates and one might hope that the apparent breaking of causality could be a mere coordinate artefact.
- (b) A possible general coordinate invariant characterization of the causality would be as the condition $G \geq 0$. In the recent case this condition reads as

$$G = \Delta \left[1 - \frac{1}{(1+\Delta)^2} - \frac{x}{2(1-x)} \right] \geq 0 , \quad x = \frac{r_s}{r} . \tag{6.11.21}$$

For small values of Δ the sign of this quantity is determined by the sign of Δ since the first two terms in the brackets cancel each other in good approximation and is positive if Δ is negative. Hence $\Delta \leq 0$ guarantees causality in this sense.

- (c) In TGD framework one can consider also a stronger form of causality. The vector field $G^{\alpha k} = G^{\alpha r} \partial_r m^k$, where m^k denotes linear coordinates for M^4 , is proportional to four-momentum current. It is space-like since $|\partial_r h(r)| < 1$ holds true to guarantee that $t = \text{constant}$ 3-surface is space-like so that $G^{\alpha k}$ seems to describe a tachyonic energy momentum current. In quantum context this need not be a catastrophe. Quantum classical correspondence suggests the identification of $G^{\alpha k}$ in the matter free regions as the four-momentum current associated with virtual particles mediating the interactions of the system with the external world. Note that also gravitons must contribute to the energy momentum tensor $T^{\alpha\beta}$ if this is the correct interpretation.
- (d) It is however very difficult to understand how the energy momentum tensor of matter could behave like $G^{\alpha k}$ does. The resolution of the problem is very simple in zero energy ontology. In zero energy ontology bosons (and their super counterparts) correspond to wormhole contacts carrying fermion and antifermion numbers at the light-like wormhole throats and having opposite signs of energy. This allows the possibility that the fermions at the throats are on mass shell and the sum of their momenta gives rise to off mass shell momentum which can be also space-like. In zero energy ontology $G^{\alpha\beta}$ would naturally correspond to the sum of on mass shell energy energy momentum tensors $T_{\pm}^{\alpha\beta}$ associated with positive and negative energy fermions and their super-counterparts. Note that for the energy momentum tensor $T^{\alpha\beta} = (\rho + p)u^\alpha u^\beta - pg^{\alpha\beta}$ of fluid with $u^\alpha u_\alpha = 1$ constraint stating on mass shell condition the allowance of virtual particles would mean giving up the condition $u^\alpha u_\alpha = 1$ for the velocity field.
- (e) This identification suggests also a nice formulation of the twistor program [K89, K32]. The basic idea is that massive on mass shell states can be regarded as massless states in 8-dimensional sense so that twistor program generalizes to the case of massive on mass shell states associated with the representations of super-conformal algebras. One has however also now off mass shell states and the question is how to describe them in terms of generalized twistors. In the case of wormhole contacts the answer is obvious. Since bosons and their super partners correspond to pairs of positive and negative energy on mass shell states, both on mass shell and of mass shell states can be described using a pair of twistors associated with composite momenta massless in 8-D sense.
- (f) How can one then interpret virtual fermions and their super-counterparts? Fermions and their super-partners have been assumed to consist of single wormhole throat associated with a deformation of CP_2 vacuum extremal so that the proposed definition would allow only on mass shell states. A possible resolution of the problem is the identification of also virtual fermions and their super-counterparts as wormhole contacts in the sense that the second wormhole throats is fermionic Fock vacuum carrying purely bosonic quantum numbers and corresponds to a state generated by purely bosonic generators of the super-symplectic algebra whose elements are in 1-1 correspondence with Hamiltonians of $\delta M_{\pm}^4 \times CP_2$. Thus the distinction between on mass shell and of mass shell states would be purely topological for fermions and their super partners.

The concrete physical interpretation would be that particle scattering event involves at least two parallel space-time sheets. Incoming (outgoing) fermion is topologically condensed at positive energy (negative energy) sheet and in the interaction region touches with a high probably the other sheet since the distance between sheets is about 10^4 Planck lengths. The touching (topological sum) generates a second wormhole throat with a spherical topology and carrying no fermion number. Virtual fermions would be fermions in interaction region [K89].

The conclusion would be following. A large deviation of the radial component of the metric from empty space metric near Earth's surface could explain the finding claimed by Grusenick without contradictions with what is known about the metric for planetary orbits assuming that similar deviation occurs quite generally. Michelson-Morley interferometer would provide a very precise method to measure g_{rr} at various heights (say in satellites) so that a very precise testing of the

proposed model becomes possible. Also the value of g_{rr} of solar gravitational field at Earth's surface might be deduced from the diurnal variation of the interference pattern.

6.11.2 Various interpretations of Machian Principle in TGD framework

TGD allows several interpretations of Machian Principle and leads also to a generalization of the Principle.

- (a) Machian Principle is true in the sense that the notion of completely free particle is non-sensible. Free CP_2 type extremal (having random light-like curve as M^4 projection) is a pure vacuum extremal and only its topological condensation creates a wormhole throat (two of them) in the case of fermion (boson). Topological condensation to space-time sheet(s) generates all quantum numbers, not only mass. Both thermal massivation and massivation via the generation of coherent state of Higgs type wormhole contacts are due to topological condensation.
- (b) Machian Principle has also interpretation in terms of p-adic physics [K80]. Most points of p-adic space-time sheets have infinite distance from the tip light-cone in the real sense. The discrete algebraic intersection of the p-adic space-time sheet with the real space-time sheet gives rise to effective p-adicity of the topology of the real space-time sheet if the number of these points is large enough. Hence p-adic thermodynamics with given p also assigned to the partonic 3-surface by the modified Dirac operator makes sense. The continuity and smoothness of the dynamics corresponds to the p-adic fractality and long range correlations for the real dynamics and allows to apply p-adic thermodynamics in the real context. p-Adic variant of Machian Principle says that p-adic dynamics of cognition and intentionality in literally infinite scale in the real sense dictates the values of masses among other things.
- (c) A further interpretation of Machian Principle is in terms of number theoretic Brahman=Atman identity or equivalently, Algebraic Holography [K79]. This principle states that the number theoretic structure of the space-time point is so rich due to the presence of infinite hierarchy of real units obtained as ratios of infinite integers that single space-time point can represent the entire world of classical worlds. This could be generalized also to a criterion for a good mathematics: only those mathematical structures which are representable in the set of real units associated with the coordinates of single space-time point are really fundamental.

6.11.3 Einstein's equations and second variation of volume element

Lubos Motl had an interesting blog posting about how Jacobsen [B43] has derived Einstein's equations from thermodynamical considerations. The argument involves approximate Poincare invariance, Equivalence principle, and proportionality of entropy to area ($dS = kdA$) so that the result is perhaps not a complete surprise.

One starts from an expression for the variation of the area element dA for certain kind of variations in direction of light-like Killing vector field and ends up with Einstein's equations. Ricci tensor creeps in via the variation of dA expressible in terms of the analog of geodesic deviation involving curvature tensor in its expression. Since geodesic equation involves first variation of metric, the equation of geodesic deviation involves its second variation expressible in terms of curvature tensor.

The result raises the question whether it makes sense to quantize Einstein Hilbert action and in light of quantum TGD the worry is justified. In TGD (and also in string models) Einstein's equations result in long length scale approximation whereas in short length scales stringy description provides the space-time correlate for Equivalence Principle. In fact in TGD framework Equivalence Principle at fundamental level reduces to a coset construction for two super-conformal algebras: super-symplectic and super Kac-Moody. The four-momenta associated with these algebras correspond to inertial and gravitational four-momenta.

In the following I will consider different -more than 10 year old - argument implying that empty space vacuum equations state the vanishing of first and second variation of the volume element

in freely falling coordinate system and will show how the argument implies empty space vacuum equations in the "world of classical worlds". I also show that empty space Einstein equations at space-time level allow interpretation in terms of criticality of volume element - perhaps serving as a correlate for vacuum criticality of TGD Universe. I also demonstrate how one can derive non-empty space Einstein equations in TGD Universe and consider the interpretation.

Vacuum Einstein's equations from the vanishing of the second variation of volume element in freely falling frame

The argument of Jacobsen leads to interesting considerations related to the second variation of the metric given in terms of Ricci tensor. In TGD framework the challenge is to deduce a good argument for why Einstein's equations hold true in long length scales and reading the posting of Lubos led to an idea how one might understand the content of these equations geometrically.

- (a) The first variation of the metric determinant gives rise to

$$\delta\sqrt{g} = \partial_\mu\sqrt{g}dx^\mu \propto \sqrt{g} \begin{pmatrix} \rho \\ \rho \mu \end{pmatrix} dx^\mu.$$

The possibility to find coordinates for which this variation vanishes at given point of space-time realizes Equivalence Principle locally.

- (b) Second variation of the metric determinant gives rise to the quantity

$$\delta^2\sqrt{g} = \partial_\mu\partial_\nu\sqrt{g}dx^\mu dx^\nu = \sqrt{g}R_{\mu\nu}dx^\mu dx^\nu.$$

The vanishing of the second variation gives Einstein's equations in empty space. Einstein's empty space equations state that the second variation of the metric determinant vanishes in freely moving frame. The 4-volume element is critical in this frame.

The world of classical worlds satisfies vacuum Einstein equations

In quantum TGD this observation about second variation of metric led for two decades ago to Einstein's vacuum equations for the Kähler metric for the space of light-like 3-surfaces ("world of classical worlds"), which is deduced to be a union of constant curvature spaces labeled by zero modes of the metric. The argument is very simple. The functional integration over configuration space degrees of freedom (union of constant curvature spaces a priori: $R_{ij} = kg_{ij}$) involves second variation of the metric determinant. The functional integral over small deformations of 3-surface involves also second variation of the volume element \sqrt{g} . The propagator for small deformations around 3-surface is contravariant metric for Kähler metric and is contracted with $R_{ij} = \lambda g_{ij}$ to give the infinite-dimensional trace $g^{ij}R_{ij} = \lambda D = \lambda \times \infty$. The result is infinite unless $R_{ij} = 0$ holds. Vacuum Einstein's equations must therefore hold true in the world of classical worlds.

Non-vacuum Einstein's equations: light-like projection of four-momentum projection is proportional to second variation of four-volume in that direction

An interesting question is whether Einstein's equations in non-empty space-time could be obtained by generalizing this argument. The question is what interpretation one should give to the quantity

$$\sqrt{g_4}T_{\mu\nu}dx^\mu dx^\nu$$

at a given point of space-time.

- (a) If one restricts the consideration to variations for which dx^μ is of form $k^\mu\epsilon$, where k is light-like vector, one obtains a situation similar to used by Jacobsen in his argument. In this case one can consider the component dP_k of four-momentum in direction of k associated with 3-dimensional coordinate volume element $dV_3 = d^3x$. It is given by

$$dP_k = \sqrt{g_4} T_{\mu\nu} k^\mu k^\nu dV_3.$$

- (b) Assume that dP_k is proportional to the second variation of the volume element in the deformation $dx^\mu = \epsilon k^\mu$, which means pushing of the volume element in the direction of k in second order approximation:

$$\frac{d^2 \sqrt{g_4}}{d\epsilon^2} \sqrt{g_4} dV_3 = \frac{d^2 \sqrt{g_4}}{\partial x^\mu \partial x^\nu} k^\mu k^\nu \sqrt{g_4} dV_3 = \sqrt{g_4} R_{\mu\nu} k^\mu k^\nu dV_3.$$

By light-likeness of k^μ one can replace $R_{\mu\nu}$ by $G_{\mu\nu}$ and add also $g_{\mu\nu}$ for light-like vector k^μ to obtain covariant conservation of four-momentum. Einstein's equations with cosmological term are obtained.

That light-like vectors play a key role in these arguments is interesting from TGD point of view since light-like 3-surfaces are fundamental objects of TGD Universe.

The interpretation of non-vacuum Einstein's equations as breaking of maximal quantum criticality in TGD framework

What could be the interpretation of the result in TGD framework.

- (a) In TGD one assigns to the small deformations of vacuum extremals average four-momentum densities (over ensemble of small deformations), which satisfy Einstein's equations. It looks rather natural to assume that statistical quantities are expressible in terms of the purely geometric gravitational energy momentum tensor of vacuum extremal (which as such is not physical). The question why the projections of four-momentum to light-like directions should be proportional to the second variation of 4-D metric determinant.
- (b) A possible explanation is the quantum criticality of quantum TGD. For induced spinor fields the modified Dirac equation gives rise to conserved Noether currents only if the second variation of Kähler action vanishes. The reason is that the modified gamma matrices are contractions of the first variation of Kähler action with ordinary gamma matrices.
- (c) A weaker condition is that the vanishing occurs only for a subset of deformations representing dynamical symmetries. This would give rise to an infinite hierarchy of increasingly critical systems and generalization of Thom's catastrophe theory would result. The simplest system would live at the V shaped graph of cusp catastrophe: just at the verge of phase transition between the two phases.
- (d) Vacuum extremals are maximally quantum critical since both the first and second variation of Kähler action vanishes identically. For the small deformations second variation could be non-vanishing and probably is. Could it be that vacuum Einstein equations would give gravitational correlate of the quantum criticality as the criticality of the four-volume element in the local freely falling frame. Non-vacuum Einstein equations would characterize the reduction of the criticality due to the presence of matter implying also the breaking of dynamical symmetries (symplectic transformations of CP_2 and diffeomorphisms of M^4 for vacuum extremals).

Chapter 7

Cosmic Strings

7.1 Introduction

Cosmic strings belong to the basic extremals of the Kähler action. These cosmic strings have nothing to do with the cosmic strings of GUTS [E153] but their string tension $T \simeq .52 \times 10^{-6}/G$ happens to be in the same range as that for the GUT strings and this makes them very interesting cosmologically. Indeed, string like objects play a fundamental role in TGD inspired cosmology and also provide TGD based models for the galaxy formation, galactic dark matter, and for the generation of the large voids. Therefore the study of the properties of cosmic strings deserves a separate chapter.

The progress in the understanding of the physics of cosmic strings has been slow due to the difficult interpretational problems.

- (a) The physical interpretation of cosmic strings depends strongly on the principle assumed to select the preferred extremals as generalized Bohr orbits. There are some objections against absolute minimization.

Number theoretical compactification [K36, K81] leads to very precise predictions about the structure of preferred extremals of Kähler action and implied breakthrough in the understanding of quantum TGD. In particular, their M^4 projections allow a distribution of $M^2(x) \subset M^4$ in their tangent space. A stronger condition is that this distribution is integrable [K19, K36]. The construction of extremals of Kähler action had led years earlier to the notion of Hamilton-Jacobi coordinates, whose existence realizes this conjecture [K11] so that the notion seems to be on firm basis. As a consequence, preferred extremals have dual slicings to string world sheets Y^2 and partonic 2-surfaces X^2 .

This observation stimulated a development leading to the realization that modified Dirac operator $D_K = D_K(X^2) + D_K(Y^2)$ associated with Kähler action can code via the generalized eigen value spectrum of $D_K(X^2)$ the value of Kähler action as Dirac determinant. Noether charges for the modified Dirac action are conserved only if the first variation of D_K vanishes, which means that second variation of Kähler action vanishes at least for the deformations responsible for dynamical symmetries. This criterion selects the preferred extremals and the choice is nothing but a space-time correlate for quantum criticality, which has been the basic guiding principle of quantum TGD. Ironically, absolute minimization is something diametrically opposite to criticality.

- (b) Physical interpretation depends also strongly on what one means with Equivalence Principle. Also here the number theoretical compactification meant breakthrough. The application of Equivalence Principle in General Relativistic formulation to cosmic strings produced a lot paradoxes and bad theory. The realization that it is stringy variant of Equivalence Principle, which works in short length scales and that general relativistic form of Equivalence Principle makes sense only in long length scales, solved these interpretational problems.

7.1.1 Various strings

TGD predicts two basic types of strings.

- (a) The analogs of hadronic strings correspond to deformations of vacuum extremals carrying non-vanishing induced Kähler fields. p-Adic thermodynamics for super-symplectic quanta condensed on them with additivity of mass squared yields without further assumptions stringy mass formula. These strings are associated with various fractally scaled up variants of hadron physics.
- (b) Cosmic strings correspond to homologically non-trivial geodesic sphere of CP_2 (more generally to complex sub-manifolds of CP_2) and have a huge string tension. These strings are expected to have deformations with smaller string tension which look like magnetic flux tubes with finite thickness in M^4 degrees of freedom. The signature of these strings would be the homological non-triviality of the CP_2 projection of the transverse section of the string.

7.1.2 Equivalence Principle and cosmic strings

The motivation for TGD as a Poincare invariant theory of gravitation was that the notion of four-momentum is poorly defined in curved space-time since corresponding Noether currents do not exist. There however seems to be a fundamental obstacle against the existence of a Poincare invariant theory of gravitation related to the notions of inertial and gravitational energy.

- (a) The conservation laws of inertial energy and momentum assigned to the fundamental action would be exact in this kind of a theory. Gravitational four-momentum can be assigned to the curvature scalar as Noether currents and is thus completely well-defined unlike in GRT. Equivalence Principle requires that inertial and gravitational four-momenta are identical. This is satisfied if curvature scalar defines the fundamental action principle crucial for the definition of quantum TGD. Curvature scalar as a fundamental action is however non-physical and had to be replaced with so called Kähler action.
- (b) One can question Equivalence Principle because the conservation of gravitational four-momentum seems to fail in cosmological scales.
- (c) For the extremals of Kähler action the Noether currents associated with curvature scalar are well-defined but non-conserved. Also for vacuum extremals satisfying Einstein's equations gravitational four-momentum fails to be conserved and non-conservation becomes large for small values of cosmic time. This looks fine but the problem is whether the possible failure of Equivalence Principle is so serious that it leads to conflict with experimental facts. Especially bad failure occurs for cosmic strings like objects $fX^2 \times Y^2 \subset M^4 \times CP_2$ for which gravitational mass becomes negative if the CP_2 projection has genus $g > 1$.

The cause of interpretational problems looks now obvious. I tried to deduce the formulation of Equivalence Principle in the framework provided by General Relativity framework applying only in the long length scale limit rather than in string model context. There were several steps in the process of becoming aware of this.

- (a) First came the conviction that coset representation for super-symplectic and super Kac-Moody algebras provides extremely general formulation of Equivalence Principle in which inertial and gravitational four-momenta are replaced with Super Virasoro generators of two algebras whose differences annihilate physical states. This idea came for years before becoming aware of its importance and I simply forgot it.
- (b) Next came the realization of the fundamental role of number theoretical compactification providing a number theoretical interpretation of $M^4 \times CP_2$ and thus also of standard model quantum numbers. This led to the identification of the preferred extremals of Kähler action and to the formulation of quantum TGD in terms of second quantized induced spinors fields. One of conclusion was that dimensional reduction for preferred extremals of Kähler action- if they have the properties required by theoretic compactification- leads to string

model with string tension which is however not proportional to the inverse of Newton's constant but to L_p^2 , p-adic length scale squared and thus gigantic. The connection between gravitational constant and L_p^2 comes from an old argument that I discovered about two decades ago and which allowed to predict the value of Kähler coupling strength by using as input electron mass and p-adic mass calculations. In this framework the role of Planck length as a fundamental length scale is taken by CP_2 size so that Planck length scale loses its magic role as a length scale in which usual views about space-time geometry cease to hold true.

- (c) The next step was the realization that zero energy ontology allows to avoid the paradox implied in positive energy ontology by the fact that gravitational energy is not conserved but inertial energy identified as Noether charge is. Energy conservation is always in some length scale in zero energy ontology.
- (d) As a matter fact, there was still one step. I had to become fully aware that the identification of gravitational four-momentum in terms of Einstein tensor makes sense only in long length scales. This is of course trivial but for some reason I did not realize that this fact resolves the paradoxes associated with objects like cosmic strings.

To summarize, the understanding of Equivalence Principle in TGD context required quite many discoveries of mostly mathematical character: the understanding of the super-conformal symmetries of quantum TGD, the discovery of zero energy ontology, the identification of preferred extremals of Kähler action by requiring number theoretical compactification, and the discovery that dimensional reduction allows to formulate quantum in terms of slicing of space-time surface by stringy world sheets. As far as cosmic strings are considered, the new vision throws to paper basket the idea about negative gravitational mass of the cosmic string inducing antigravity like effects.

7.1.3 TGD based quantum model for astrophysical systems

A brief summary of TGD based quantum model of astrophysical systems is in order.

- (a) TGD based quantum model for astrophysical systems relies on the evidence that planetary orbits (also those of known exoplanets) correspond to Bohr orbits with a gigantic value of gravitational Planck constant $\hbar_{gr} = GMm/v_0$ characterizing the gravitational interaction between masses M and m . Nottale [E175] introduced originally this quantization rule and assigned it to hydrodynamics.
- (b) TGD inspired hypothesis is that quantization represents genuine quantum physics and is due to the fact that dark matter corresponds to a hierarchy whose levels are labeled by the values of Planck constant. Visible matter bound to dark matter would make this quantization visible. Putting it more precisely, the space-time sheets mediating various interactions (electro-weak, color, gravitational) between the two physical systems are characterized by their own Planck constant which can have arbitrarily large values. For gravitational interactions the value of this Planck constant is gigantic and depends on the systems involved. These space-time sheets could correspond to magnetic flux tubes which were originally cosmic strings and concrete representations for gravitonic strings of astrophysical size having wormhole contacts at their ends.
- (c) The implication is that astrophysical systems are analogous to atoms and molecules and thus correspond to quantum mechanical stationary states have constant size in the local M^4 coordinates (t, r_M, Ω) related to Robertson Walker coordinates via the formulas (a, r, Ω) by $(a^2 = t^2 - r_M^2, r = r_M/a)$. This means that their M^4 radius R_M remains constant whereas the coordinate radius R decreases as $1/a$ rather than being constant as for co-moving matter.
- (d) Astrophysical quantum systems can however participate in the cosmic expansion by discrete quantum jumps in which Planck constant increases. This means that the parameter v_0 appearing in the gravitational Planck constant $\hbar = GMm/v_0$ is reduced in a discrete manner so that the quantum scale of the system increases.

- (e) This applies also to gravitational self interactions for which one has $\hbar = GM^2/v_0$. During the final states of star the phase transitions reduce the value of Planck constant and the prediction is that collapse to neutron or super-nova should occur via phase transitions increasing v_0 . Ideal black-hole state could be identified as a state for which the scaled up Planck length $l_P(\hbar) = \sqrt{\hbar G}$ equals to Schwarzschild radius $2GM$. This gives $v_0 = 1/4$.
- (f) Planetary Bohr orbit model explains the finding by Masreliez [E160] that planetary radii seem to decrease when express in terms of the cosmic radial coordinate $r = r_M/a$ [K61]. The prediction is that planetary systems should experience now and then a phase transition in which the size of the system increases by an integer n . The number theoretically favored values are ruler-and-compass integers expressible as products of distinct Fermat primes (four of them are known) and power of 2. The most favored changes of v_0 are as powers of 2. That inner and outer planets correspond to the values of v_0 differing by a factor of $1/5$ is consistent with ruler and compass hypothesis.

7.1.4 Correlation between super-novae and cosmic strings

During year 2003 two important findings related to cosmic strings were made.

- (a) A correlation between supernovae and gamma ray bursts was observed.
- (b) Evidence that some unknown particles of mass $m \simeq 2m_e$ and decaying to gamma rays and/or electron positron pairs annihilating immediately serve as signatures of dark matter. These findings challenge the identification of cosmic strings and/or their decay products as dark matter, and also the idea that gamma ray bursts correspond to cosmic fire crackers formed by the decaying ends of cosmic strings. This forces the updating of the more than decade old rough vision about topologically condensed cosmic strings and about gamma ray bursts described in this chapter (old version is left essentially untouched in order to demonstrate how important the experimental input is for the evolution of ideas).

According to the updated model, cosmic strings transform in topological condensation to magnetic flux tubes about which they represent a limiting case. Primordial magnetic flux tubes forming ferro-magnet like structures become seeds for gravitational condensation leading to the formation of stars and galaxies. The TGD based model for the asymptotic state of a rotating star as dynamo [K85] leads to the identification of the predicted magnetic flux tube at the rotation axis of the star as Z^0 magnetic flux tube of primordial origin (flux tube carries also em field but could carry only Z^0 charge). Besides Z^0 magnetic flux tube structure also magnetic flux tube structure exists at different space-time sheet but is in general not parallel to the Z^0 magnetic structure. This structure cannot have primordial origin (the magnetic field of star can even flip its polarity).

The flow of matter along Z^0 magnetic (rotation) axis generates synchrotron radiation, which escapes as a precisely targeted beam along magnetic axis and leaves the star. The identification is as the rotating light beam associated with ordinary neutron stars. During the core collapse leading to the supernova this beam becomes gamma ray burst. The mechanism is very much analogous to the squeezing of the tooth paste from the tube.

TGD based models of nuclei [K77] and condensed matter [K27] suggests that the nuclei of dense condensed matter develop anomalous color and weak charges coupling to dark weak bosons having Compton length L_w of order atomic size. Also lighter copies of weak bosons can be important in living matter. This weak charge is vacuum screened above L_w and by dark particles below it. Dark neutrinos are good candidates for screening dark particles. The Z^0 charge unbalance caused by the ejection of screening dark neutrinos hinders the gravitational collapse. The strong radial compression amplifies the tooth paste effect in this kind of situation so that there are hopes to understand the observed incredibly high polarization of 80 ± 20 per cent [E89].

TGD suggests the identification of particles of mass $m \simeq 2m_e$ accompanying dark matter as lepto-pions [K84] formed by color excited leptons, and topologically condensed at magnetic flux tubes having thickness of about lepto-pion Compton length. Lepto-pions would serve as

signatures of dark matter whereas dark matter itself would correspond to the magnetic energy of topologically condensed cosmic strings transformed to magnetic flux tubes.

7.2 General vision about topological condensation of cosmic strings

In this section the basic properties of free cosmic strings are discussed and a general vision about topological condensation of cosmic strings is proposed. In the later sections the vision is developed at a more quantitative level.

7.2.1 Free cosmic strings

The free cosmic strings correspond to four-surfaces of type $X^2 \times S^2$, where S^2 is the homologically nontrivial geodesic sphere of CP_2 [L1], [L1] and X^2 is minimal surface in M_+^4 . As a matter fact, any complex manifold $Y^2 \subset CP_2$ is possible. In this section, a co-moving cosmic string solution inside the light cone $M_+^4(m)$ associated with a given m point of M_+^4 will be constructed.

Recall that the line element of the light cone in co-moving coordinates inside the light cone is given by

$$ds^2 = da^2 - a^2 \left(\frac{dr^2}{1+r^2} + r^2 d\Omega^2 \right) . \quad (7.2.1)$$

Outside the light cone the line element is given

$$ds^2 = -da^2 - a^2 \left(-\frac{dr^2}{1-r^2} + r^2 d\Omega^2 \right) , \quad (7.2.2)$$

and is obtained from the line element inside the light cone by replacements $a \rightarrow ia$ and $r \rightarrow -ir$.

Simplest solutions

Using the coordinates $(a = \sqrt{(m^0)^2 - r_M^2}, ar = r_M)$ for X^2 the orbit of the cosmic string is given by

$$\begin{aligned} \theta &= \frac{\pi}{2} , \\ \phi &= f(r) . \end{aligned} \quad (7.2.3)$$

Inside the light cone the line element of the induced metric of X^2 is given by

$$ds^2 = da^2 - a^2 \left(\frac{1}{1+r^2} + r^2 f_{,r}^2 \right) dr^2 . \quad (7.2.4)$$

The equations stating the minimal surface property of X^2 can be expressed as a differential conservation law for energy or equivalently for the component of the angular momentum in the direction orthogonal to the plane of the string. The conservation of the energy current T^α gives

$$\begin{aligned}
T_{,\alpha}^{\alpha} &= 0 , \\
T^{\alpha} &= Tg^{\alpha\beta}m_{,\beta}^0\sqrt{g} , \\
T &= \frac{1}{8\alpha_K R^2} \simeq .52 \times 10^{-6} \frac{1}{G} .
\end{aligned} \tag{7.2.5}$$

The numerical estimate $TG \simeq .52 \times 10^{-6}$ for the string tension is upper bound and corresponds to a situation in which the entire area of S^2 contributes to the tension. It has been obtained using $\alpha_K/104$ and $R^2/G = 2.5 \times 10^7 G$ given by the most recent version of p-adic mass calculations (the earlier estimate was roughly by a factor 1/2 too small due to error in the calculation [K36, K5]). The string tension belongs to the range $TG \in [10^{-6} - 10^{-7}]$ predicted for GUT strings [E153]. WMAP data give the upper bound $TG \in [10^{-6} - 10^{-7}]$, which does not however hold true in the recent case since criticality predicts adiabatic spectrum of perturbations as in the inflationary scenarios.

The non-vanishing components of energy current are given by

$$\begin{aligned}
T^a &= TUa , \\
T^r &= -T \frac{r}{U} , \\
U &= \sqrt{1 + r^2(1 + r^2)f_{,r}^2} .
\end{aligned} \tag{7.2.6}$$

The equations of motion give

$$U = \frac{r}{\sqrt{r^2 - r_0^2}} , \tag{7.2.7}$$

or equivalently

$$\phi_{,r} = \frac{r_0}{r\sqrt{(r^2 - r_0^2)(1 + r^2)}} , \tag{7.2.8}$$

where r_0 is an integration constant to be determined later. Outside the light cone the solution has the form

$$\phi_{,r} = \frac{r_0}{\sqrt{r^2 + r_0^2}r\sqrt{1 - r^2}} . \tag{7.2.9}$$

In the region inside the light cone, where the conditions

$$r_0 \ll r \ll 1 \tag{7.2.10}$$

hold, the solution has the form

$$\begin{aligned}
\phi(r) &\simeq \phi_0 + \frac{v}{r} , \\
v &= \frac{r_0}{\sqrt{1 + r_0^2}} ,
\end{aligned} \tag{7.2.11}$$

corresponding to the linearized equations of motion

$$f_{,rr} + \frac{2f_{,r}}{r} = 0 , \quad (7.2.12)$$

obtained most nicely from the angular momentum conservation condition.

Cosmic string is stationary in comoving coordinates

In co-moving coordinates (in general the co-moving coordinates of sub-light-cone M_+^4 !) the string is stationary. In Minkowski coordinates string rotates with an angular velocity inversely proportional to the distance from the origin

$$\omega \simeq \frac{v}{r_M} \quad (7.2.13)$$

so that the orbital velocity of the string becomes essentially constant in this region. For very large values of r the orbital velocity of the string vanishes as $1/r$. Outside the light cone the variable r is in the role of time and for a given value of the time variable r strings are straight and one can regard the string as a rigidly rotating straight string in this region.

Inside the light cone, the solution becomes ill defined for the values of r smaller than the critical value r_0 . Although the derivative $\phi_{,r}$ becomes infinite at this limit, the limiting value of ϕ is finite so that strings winds through a finite angle. The normal component T^r of the energy momentum current vanishes at $r = r_0$ identically, which means that no energy flows out at the end of the string. The coordinate variable r becomes however bad at $r = r_0$ (string resembles a circle at r_0) and this conclusion must be checked using ϕ as coordinate instead of r . The result is that the normal component of the energy current indeed vanishes.

Field equations are not however satisfied at the end of the string since the normal component of the angular momentum current (in z - direction) is non-vanishing at the boundary and given by

$$J^r = Tr^2 a . \quad (7.2.14)$$

This means that the string loses angular momentum through its ends although the angular momentum density of the string is vanishing. The angular momentum lost at moment a is given by

$$J = \frac{Tr^2 a^2}{2} = \frac{Tr_M^2}{2} . \quad (7.2.15)$$

This angular momentum is of the same order of magnitude as the angular momentum of a typical galaxy [E179] .

In M^4 coordinates singularity corresponds to a disk in the plane of string growing with a constant velocity, when the coordinate m^0 is positive

$$\begin{aligned} r_M &= vm^0 , \\ v &= \frac{r_0}{\sqrt{1+r_0^2}} . \end{aligned} \quad (7.2.16)$$

From the expression of the energy density of the string

$$\begin{aligned} T^a &= T \frac{ar}{\sqrt{r^2 - r_0^2}} , \\ T &= \frac{1}{8\alpha_K R^2} , \end{aligned} \quad (7.2.17)$$

it is clear that energy density diverges at the singularity.

Energy of the cosmic string

As already noticed, the string tension is by a factor of order 10^{-6} smaller than the critical string tension $T_{cr} = 1/4G$ implying angle deficit of 2π in GRT so that there seems to be no conflict with General Relativity (unlike in the original scenario, in which the CP_2 radius was of order Planck length).

The energy of the string portion ranging from r_0 to r_1 is given by

$$E = T\sqrt{(r_1^2 - r_0^2)}a = T\sqrt{\delta r_M^2} . \quad (7.2.18)$$

It should be noticed that M^4 time development of the string can be regarded as a scaling: each point of the string moves to radial direction with a constant velocity v .

One can calculate the total change of the angle ϕ from the integral

$$\Delta\phi = \sqrt{\frac{r_0^2}{1+r_0^2}} \int_{r_0}^{\infty} dr \frac{1}{r\sqrt{(r^2 - r_0^2)(1+r^2)}} . \quad (7.2.19)$$

The upper bound of this quantity is obtained at the limit $r_0 \rightarrow 0$ and equals to $\Delta\phi = \pi/2$.

7.2.2 TGD based model for cosmic strings

The model for cosmic strings has forced to question all cherished assumptions including positive energy ontology, Equivalence Principle, and positivity of gravitational mass. The final outcome turned out to be rather conservative. Zero energy ontology is unavoidable, Equivalence Principle holds true universally but its general relativistic formulation makes sense only in long length scales, and gravitational mass has definite sign for positive/negative energy states. As a matter fact, all problems were created by the failure to realize that the expression of gravitational energy in terms of Einstein's tensor does not hold true in short length scales and must be replaced with the stringy expression resulting naturally by dimensional reduction of quantum TGD to string model like theory [K19, K36, K5] .

Zero energy ontology and cosmic strings

There are two kinds of cosmic strings: free and topological condensed ones and both are important in TGD inspired cosmology.

- (a) Free cosmic strings are not absolute minima of the Kähler action (the action has wrong sign). In the original identification of preferred extremals as absolute minima of Kähler action this was a problem. In the new formulation preferred extremals correspond to quantum criticality identified as the vanishing of the second variation of Kähler action at least for the deformations defining symmetries of Kähler action [K19, K36]. Criticality guarantees the conservation of the Noether charges assignable to the modified Dirac action. Ideal cosmic strings are excluded because they fail to satisfy the conditions characterizing the preferred extremal as a space-time surface containing regions with both Euclidian and Minkowskian signature of the induced metric with light-like 3-surface separating them identified as orbits of partonic 2-surfaces carrying elementary particle quantum numbers. The topological condensation of CP_2 type vacuum extremals representing fermions generates negative contribution to the action and reduces the string tension and leaves cosmic strings still free.
- (b) If the topologically condensate of fermions has net Kähler charges as the model for matter antimatter asymmetry suggests, the repulsive interaction of the particles tends to thicken the cosmic string by increasing the thickness of its infinitely thin M^4 projection so that Kähler magnetic flux tubes result. These flux tubes are ideal candidates for the carriers of dark matter with a large value of Planck constant. The criterion for the phase transition increasing \hbar is indeed the presence of a sufficiently dense plasma implying that perturbation theory in terms of $Z^2\alpha_{em}$ (Z is the effective number of charges with interacting with each other without screening effects) fails for the standard value of Planck constant. The phase transition $\hbar_0 \rightarrow \hbar$ reduces the value of $\alpha_{em} = e^2/4\pi\hbar$ so that perturbation theory works. This phase transition scales up also the transversal size of the cosmic string. Similar criterion works also for other charges. The resulting phase is anyonic if the resulting 2-surfaces containing almost spherical portions connected by flux tubes to each other encloses the tip of the causal diamond (CD). The proposal is that dark matter resides on complex anyonic 2-surfaces surrounding the tips of CD s.
- (c) The topological condensation of cosmic strings generates wormhole contacts represented as pieces of CP_2 type vacuum extremals identified as bosons composed of fermion-antifermion pairs. Also this generates negative action and can make cosmic string a preferred extremal of Kähler action. The earliest picture was based on dynamical cancelation mechanism involving generation of strong Kähler electric fields in the condensation whose action compensated for Kähler magnetic action. Also this mechanism might be at work. Cosmic strings could also form bound states by the formation graviton like flux tubes connecting them and having wormhole contacts at their ends so that again action is reduced.
- (d) One can argue that in long enough length and time scales Kähler action per volume must vanish so that the idealization of cosmology as a vacuum extremal becomes possible and there must be some mechanism compensating the positive action of the free cosmic strings. The general mechanism could be topological condensation of fermions and creation of bosons by topological condensation of cosmic strings to space-time sheets.

In this framework zero energy states correspond to cosmologies leading from big bang to big crunch separated by some time interval T of geometric time. Quantum jumps can gradually increase the value T and TGD inspired theory of consciousness suggests that the increase of T might relate to the shift for the contents of conscious experience towards geometric future. In particular, what is usually regarded as cosmology could have started from zero energy state with a small value of T .

Topological condensation of cosmic strings

In the original vision about topological condensation of cosmic strings I assumed that large voids represented by space-time sheets contain "big" cosmic string in their interior and galactic strings near their boundaries. The recent much simpler view is that there are just galactic strings which carry net fermion numbers (matter antimatter asymmetry). If they have also net em charge they have a repulsive interaction and tend to end up to the boundaries of the large void. Since this slows down the expansive motion of strings, the repulsive interaction energy

increases and a phase transition increasing Planck constant and scaling up the size of the void occurs after which cosmic strings are again driven towards the boundary of the resulting larger void.

One cannot assume that the exterior metric of the galactic strings is the one predicted by assuming General Relativity in the exterior region. This would mean that metric decomposes as $g = g_2(X^2) + g_2(Y^2)$. $g(X^2)$ would be flat as also $g_2(Y^2)$ expect at the position of string. The resulting angle defect due to the replacement of plane Y^2 with cone would be large and give rise to lense effect of same magnitude as in the case of GUT cosmic strings. Lense effect has not been observed.

This suggests that General Relativity fails in the length scale of large void as far as the description of topologically condensed cosmic strings is considered. The constant velocity spectrum for distant stars of galaxies and the fact that galaxies are organized along strings suggests that these string generate in a good approximation Newtonian potential. This potential predicts constant velocity spectrum with a correct value velocity.

In the stationary situation one expects that the exterior metric of galactic string corresponds to a small deformation of vacuum extremal of Kähler action which is also extremal of the curvature scalar in the induced metric. This allows a solution ansatz which conforms with Newtonian intuitions and for which metric decomposes as $g = g_1 + g_3$, where g_1 corresponds to axis in the direction of string and g_3 remaining 1 + 2 directions.

Dark energy is replaced with dark matter in TGD framework

The observed accelerating expansion of the Universe has forced to introduce the notion of cosmological constant in the GRT based cosmology. In TGD framework the situation is different.

- (a) The gigantic value of gravitational Planck constant implies that dark matter makes TGD Universe a macroscopic quantum system even in cosmological length scales. Astrophysical systems become stationary quantum systems which participate in cosmic expansion only via quantum phase transitions increasing the value of gravitational Planck constant.
- (b) Critical cosmologies, which are determined apart from a single parameter in TGD Universe, are natural during all quantum phase transitions, in particular the phase transition periods increasing the size of large voids and having interpretation in terms of an increase of gravitational Planck constant. Cosmic expansion is predicted to be accelerating during these periods. The mere criticality requires that besides ordinary matter there is a contribution $\Omega_\Lambda \simeq .74$ to the mass density besides visible matter and dark matter. In fact, also for the over-critical cosmologies expansion is accelerating.
- (c) In GRT framework the essential characteristic of dark energy is its negative pressure. In TGD framework critical and over-critical cosmologies have automatically effective negative pressure. This is essentially due to the constraint that Lorentz invariant vacuum extremal of Kähler action is in question. The mysterious negative pressure would be thus a signal about the representability of space-time as 4-surface in H and there is no need for any microscopic description in terms of exotic thermodynamics.

The interpretation of accelerated expansion and the values for the TGD counterpart of the cosmological constant

Dark energy characterized by cosmological constant provides a satisfactory description of the accelerated expansion in GRT framework and should have TGD counterpart.

- (a) If the accelerated expansion is due to the phase transitions changing the value of Planck constant, one can introduce a parameter characterizing the contribution of the dark mass to the mass density during critical periods and call it cosmological constant recalling however that the contribution does not correspond to dark energy in the standard sense. The negative pressure of the almost unique critical cosmology would be a space-time correlate for the phase transition increasing the Planck constant.

- (b) There is also an alternative interpretation. According to the earlier proposal, string like objects resulting as descendants of primordial cosmic string are carriers of the dark energy. If the string like objects correspond to space-time sheets mediating gravitational interaction and have a gigantic gravitational Planck constant $h_{gr} = GMm/v_0$, with $v_0/c \leq 1$ holds true as proposed in [K72] ($v_0 = 2^{-11}$ for inner planets), one can indeed understand why dark energy density is a constant in such an excellent approximation (Compton lengths of particles would be gigantic: Planck mass would correspond to Compton length of order Schwarzschild radius for $\hbar_{gr} \sim GM^2/c$). The negative pressure assigned to dark energy would reflect the negative string tension of string like objects.
- (c) These two views conform if the negative pressure of the critical cosmology is due to the presence of string like objects. Cosmological constant would be the natural parameter in GRT based description and replaced in TGD framework by the parameter characterizing the duration of the critical cosmology. In the purely classical description based on cosmological constant the accelerated expansion taking place as short jerks would be replaced by a continual accelerated expansion.

What is new that p-adic fractality predicts that Λ scales as $1/L^2(k)$ as a function of the p-adic scale characterizing the space-time sheet implying a series of phase transitions reducing Λ . The order of magnitude for the recent value of the cosmological constant comes out correctly. The gravitational energy density assignable to the cosmological constant is identifiable as that associated with topologically condensed cosmic strings and magnetic flux tubes to which they are gradually transformed during the cosmological evolution.

The naive expectation would be the density of cosmic strings behaves as $1/a^2$ as function of M_+^4 proper time. The vision about dark matter as a phase characterized by gigantic Planck constant however implies that large voids do not expand in continuous manner during cosmic evolution but in discrete quantum jumps increasing the value of the gravitational Planck constant and thus increasing the size of the large void as a quantum state. Since the set of preferred values of Planck constant is closed under multiplication by powers of 2, p-adic length scales L_p , $p \simeq 2^k$ form a preferred set of sizes scales for the large voids.

Zero energy ontology provides a further view about the situation.

- (a) In zero energy ontology causal diamonds (*CDs*) defined as intersections of the future and past directed light-cones are the fundamental building blocks of the world of classical worlds (*WCW*) identified as a union of sub-*WCWs* assignable to *CDs* [K73]. Note that *CDs* contains *CDs* within *CDs* so that fractality results.
- (b) A particular *CD* is characterized by its position in M^4 , by the value a of the Lorentz invariant distance a between its upper and lower tips, and by the Lorentz boost applied to get the *CD* from a standard representative. The moduli space for the *CD* is therefore the union of spaces $M^4 \times L(a)$ where $L(a)$ is Lobatchevski space, and a corresponds to an allowed value of a .
- (c) The hypothesis that $L(a)$ corresponds to the 3-space of Robertson-Walker cosmology in quantum cosmology with a having interpretation as cosmic time, is highly attractive. p-Adic length scale hypothesis follows if the values of a come as octaves of the CP_2 time scale. In this framework, the classical cosmology associated with *CD* representing accelerated expansion would serve as a smoothed out space-time correlate for the discrete quantum jump scaling the size of *CD* by 2.

A further work is required to find whether these different views about accelerated expansion are mutually consistent.

TGD cosmic strings are consistent with the fluctuations of CMB

GUT cosmic strings were excluded by the fluctuation spectrum of the CMB background [E12]. In GRT framework these fluctuations can be classified to adiabatic density perturbations and isocurvature density perturbations. Adiabatic density perturbations correspond to overall scaling of various densities and do not affect the vanishing curvature scalar. For isocurvature density

fluctuations the net energy density remains invariant. GUT cosmic strings predict isocurvature density perturbations while inflationary scenario predicts adiabatic density fluctuations.

In TGD framework inflation is replaced with quantum criticality of the phase transition period leading from the cosmic string dominated phase to matter dominated phase. Since curvature scalar vanishes during this period, the density perturbations are indeed adiabatic.

7.3 More detailed view about topological condensation of cosmic strings

The purpose of this section is to represent in more detail the calculations behind the vision discussed in the previous section. As already noticed, free cosmic strings as such cannot correspond to the absolute minima of the action since their action is large and positive.

7.3.1 Topological condensation of a positive energy cosmic string

It is however useful to build a model of exterior space-time of topologically condensed cosmic string as a solution of Einstein's equations. For a straight string this solution is flat except at the position of the string. What happens is that the 2-dimensional plane orthogonal to the string becomes a conical surface. The angular defect is given by

$$\Delta\phi = \frac{T}{T_{max}} \times 2\pi, \quad T_{max} = \frac{1}{4G}. \quad (7.3.1)$$

Here the string tension T refers to the gravitational mass density of the string and this is not necessarily identical with the inertial mass density. Obviously $T_{max} = 1/4G$ represents an upper bound for the gravitational mass density of the string.

The metric can be written as

$$\begin{aligned} ds^2 &= dt^2 - dz^2 - \frac{d\rho^2}{k_1^2} - \rho^2 d\phi^2, \\ k_1^2 &= 1 - 4GT. \end{aligned} \quad (7.3.2)$$

The imbeddings of this metric as an induced metric are easy to find. The simplest imbedding is obtained by considering a map $M^4 \rightarrow S^1$, where S^1 is a geodesic circle of CP_2 . Denoting by Φ the angle coordinate of S^1 , one has

$$\begin{aligned} \Phi &= k\rho, \\ 1 + R^2 k^2 &= \frac{1}{k_1^2}. \end{aligned} \quad (7.3.3)$$

The geodesic lines associated with this metric are easy to find in Cartesian coordinates. In M^4 coordinates the geodesics are slightly curved, which is nothing but the lense effect [E190]. To see what happens consider geodesic lines in the plane; cut from the plane a sector corresponding to the deficit angle and bend it to form a cone; after this operation project the geodesic lines on the cone to the plane again to see how the geodesics look like in M^4 coordinates. The observation of this bending is possible if the coordinates used by the observers are actually M^4 coordinates rather than space-time coordinates.

The predicted lense effect would serve as a signature for the presence of strings with this kind of exterior metric and the experimental absence of this effect suggests that this metric is not a proper choice for the exterior metric but should be replaced with a metric inspired by Newtonian intuition.

7.3.2 Exterior metrics of cosmic string as extremal of curvature scalar

Einstein action with induced metric in general gives also solutions for exterior metric which are not gravitational vacua. One might hope these solutions in the first approximation correspond to Newtonian expectations and give rise only to a small lense effect. One must of course keep in mind that Einstein's equations and their TGD variant hold true only in long length scales and their application in the scale of cosmic string might not be justified. Second point is that it is the inertial energy density of cosmic strings rather than the energy density associated with curvature scalar, which serves as the source term in TGD variant of the Einstein's equations.

The ansatz

A rather general ansatz implying radial induced gauge fields in the background space is given by the following expression in cylindrical coordinates for M_+^4

$$\begin{aligned} m^0 &= \Lambda t \ , \\ \cos(\Theta) &= u(\rho) \ , \\ \Phi &= \omega t + k(\rho) + n\phi \ . \end{aligned} \tag{7.3.4}$$

The reason why this ansatz works is that the components of metric and thus also of curvature tensor depend only on ρ so that field equations reduce to two differential equations. One can get rid of the $g_{t\rho}$ component of the induced metric by assuming $m^0 = \Lambda t + h(\rho)$ as in case of Schwarzschild metric.

The interesting components of the induced metric in the cylindrical coordinates are given by the expression

$$\begin{aligned} g_{tt} &= \Lambda^2 - \omega^2 A \ , \\ g_{\rho\rho} &= -1 - A \left[(\partial_\rho k)^2 + (\partial_\rho u)^2 \frac{1}{(1-u^2)^2} \right] \ , \\ g_{\rho t} &= -\omega \partial_\rho k A \ , \\ g_{t\phi} &= -\omega n A \ , \\ g_{\rho\phi} &= -\partial_\rho k A \ , \\ A &= R^2 \omega^2 (1-u^2) \ , \\ \Lambda^2 - \omega^2 A(\infty) &= 1 \ . \end{aligned} \tag{7.3.5}$$

Note that the induced gauge fields are Abelian. Em and Z^0 fields are proportional to each other and classical color field is proportional to induced Kähler form and vanishes for vacuum extremals. This can be seen as a signature of color confinement.

Field equations as conservation laws

The conservation law for color charge corresponding to $\Phi \rightarrow \Phi + \epsilon$ gives the first differential equation:

$$\partial_\rho \left[(G^{\rho\rho} \partial_\rho k + \frac{G^{\rho\phi} n}{\rho} + G^{\rho t} \omega) \sin^2(\Theta) \sqrt{g} \right] = 0 \ . \tag{7.3.6}$$

For $m^0 + \Lambda t + h(\rho)$ energy conservation one gets rid of the $G^{\rho t}$ term. This equation can be integrated to give

$$(G^{\rho\rho}\partial_\rho k + \frac{G^{\rho\phi}n}{\rho})\sin^2(\Theta)\sqrt{g} = C \quad . \quad (7.3.7)$$

and states that the conserved radial flow of $U(1)$ color charge is non-vanishing. This current must flow along the string. Note that for $k = \text{constant}$ gives $C = 0$.

The second equation can be chosen to correspond to the momentum conservation in say x -direction and would give

$$\partial_\rho \left[(G^{\rho\rho} + \frac{G^{\phi\rho}}{\rho})\sqrt{g} \right] - G^{\phi\phi}\rho\sqrt{g} = 0 \quad . \quad (7.3.8)$$

The resulting field equations are extremely non-linear ordinary differential equations for $\Theta(\rho)$ and $\Phi(\rho) = k(\rho)$ having a character of a hydrodynamical conservation law. For $n = 0$ one obtains effectively Einstein equations with purely geometric source terms.

$$\begin{aligned} G^{\rho\rho} &= \frac{C}{\sin^2(\Theta)\partial_\rho k\sqrt{g}} \quad , \\ G^{\phi\phi} &= \partial_\rho \left[\frac{C}{\sin^2(\Theta)\partial_\rho k} \right] \frac{1}{\rho\sqrt{g}} \quad . \end{aligned} \quad (7.3.9)$$

Linearization

The linearized expression of the Einstein tensor with respect to the deviation $h_{\alpha\beta}$ of the induced metric from flat metric should give a good approximation to the field equations and allow to decide whether the Newtonian picture holds true. The linearized Ricci tensor is given by

$$\begin{aligned} 2R_{\alpha\beta} &= D_\gamma D_\beta h^\gamma_\alpha + D_\gamma D_\alpha h^\gamma_\beta - D_\alpha D_\beta h - D_\gamma D^\gamma h_{\alpha\beta} \quad , \\ R &= D_\alpha D_\beta h^{\alpha\beta} - D_\alpha D^\alpha h \quad . \end{aligned} \quad (7.3.10)$$

The covariant derivatives are with respect to the flat M^4 metric.

Are field equations consistent with the Newtonian limit?

One can hope that the field equations are consistent with the Newtonian limit which implies $R_{tt} = g_{tt}R/2$ outside z -axis in the linear approximation. If this is true, the gravitational energy density of the exterior metric would remain vanishing in the linear approximation for the metric so that a minimal modification of the vacuum Einstein equations would be in question. That Newtonian limit makes sense could be due to the fact that Einstein tensor represents the action of a non-linear wave operator on metric. Hence metric should be expressible in terms of its sources and topologically condensed cosmic string defines such a source very naturally.

Newtonian limit corresponds to the approximation

$$g_{tt} - 1 = 2\Phi_{gr} \quad , \quad \nabla^2\Phi_{gr} = -4\pi\rho_{gr} \quad . \quad (7.3.11)$$

For string tension $T = dM/dl$, which corresponds to the density of inertial mass, one has $\Phi_{gr} = 2TG \log(\rho/\rho_0)$ as the 2-dimensional variant of Gauss law shows. This corresponds to the simplified ansatz

$$\begin{aligned} u &= u(\rho) \ , \ \Phi = \omega t + k(\rho) \ , \\ A - A(\infty) &= 2\Phi_{gr} = 4GT \times \log\left(\frac{\rho}{\rho_0}\right) \ . \end{aligned} \quad (7.3.12)$$

This gives

$$\begin{aligned} u^2 &= u^2(\infty) - K \times \log\left(\frac{\rho}{\rho_0}\right) \ , \\ K &= \frac{16GT}{R^2\omega^2} \ . \end{aligned} \quad (7.3.13)$$

The imbedding ceases to exist at certain critical radii corresponding to

$$\begin{aligned} \frac{\rho_{max}}{\rho_0} &= \exp\left(\frac{u^2(\infty)}{K}\right) \ , \\ \frac{\rho_{min}}{\rho_0} &= \exp\left(\frac{u^2(\infty) - 1}{K}\right) \ , \\ \frac{\rho_{max}}{\rho_{min}} &= \exp\left(\frac{1}{K}\right) \ , \ K = \frac{4GT}{R^2\omega^2} \ . \end{aligned} \quad (7.3.14)$$

This ansatz with suitably chosen $k_0(\rho)$ could be taken as the lowest order approximation to the solution and one can expand the solution as $X \equiv u^2 = X_0 + \epsilon X_1 + \dots$, $k = k_0(\rho) + \epsilon_1 k_1 + \dots$ and solve u_n and k_n by linearizing the field equations around $X = X_0 + \dots + \epsilon^n X_n$ and $k = k_0 + \dots + \epsilon^n k_n$ solving (X_{n+1}, k_{n+1}) from the linearized differential equations. One could also proceed by substituting to the right hand side n :th order approximation and linearized Einstein tensor to the left hand side using $n + 1$:th order approximation. Note that the ansatz makes sense also for negative gravitational energy.

The angle defect (or surplus) is given by

$$\Delta\Phi(\rho) = \frac{\sqrt{\rho^2 + R^2 u^2 n^2}}{\int_0^\rho \sqrt{g_{\rho\rho}} d\rho} \times 2\pi \ . \quad (7.3.15)$$

For small values of n the effect is expected to be small.

7.3.3 Geodesic motion in the exterior metric of cosmic string

Writing the geodesic equations explicitly one finds that the conservation of energy and angular momentum give the conditions

$$\begin{aligned} \frac{dt}{ds} &= E \ , \\ \rho^2 k^2 \frac{d\phi}{ds} &= L \ . \end{aligned} \quad (7.3.16)$$

In the radial direction one obtains the equation of motion

$$\frac{d^2u}{ds^2} = \frac{u}{1-u^2} \times \left(\frac{du}{ds}\right)^2 + \frac{L^2}{\rho_0^2} \frac{1-u^2}{u^3} . \quad (7.3.17)$$

The cosmic string induces besides ordinary centrifugal acceleration a radial repulsive acceleration

$$g = \frac{u}{1-u^2} \times \left(\frac{du}{ds}\right)^2 . \quad (7.3.18)$$

The geodesic lines lead to the boundary of the cylindrical region. A possible interpretation is that this acceleration drives galactic cosmic strings with reduced string tension to the boundary of the large void.

The exterior solution does not represent co-moving matter which conforms with the idea that gravitational space-time sheets correspond to gigantic values of Planck constants implying that even astrophysical objects correspond to stationary quantum states following cosmic expansion only in average sense by quantum jumps leading to a reduction of Planck constant and rapid expansion of the space-time sheet. Classical picture would suggest that these jumps occur when the matter has ended up sufficiently near to the boundary of the large void.

Note that if one completes the space-time sheet by gluing "above" it second cosmic string with positive time orientation and positive gravitational mass the geodesic lines could turn around at the boundary so that the accelerated expansion of the matter would transform to compression.

It is easy to see that simple imbeddings of almost everywhere flat metric do not exist so that the density of gravitational energy in the exterior region is unavoidable. The condition $g_{\rho\rho} = 1$ could be satisfied by assuming $m^0 = t + h(\rho)$ and choosing h properly. This generates however also $g_{t\rho}$ component to the induced metric and to compensate it one should have $\Phi = n\phi + \omega t + k(\rho)$ with k chosen properly. This however generates $g_{t\phi} \neq 0$ which cannot be canceled and would mean that the solution is rotating.

One obtains also vacuum extremals representing solutions for which gauge charges and angular momentum are non-vanishing by a very simple deformation $\Phi \rightarrow \Phi + \omega t$ of the proposed ansatz. Interestingly, non-vanishing gauge charges are necessarily accompanied by angular momentum and vice versa.

7.3.4 Matter distribution around cosmic string

The distribution of stars in the vicinity of cosmic string can be modeled using kinetic model for the evolution of the distribution of stars. Assuming that stars have some average mass M and that the situation is non-relativistic the kinetic equation for the distribution of stars reads

$$\frac{dn}{dt} = \nabla \cdot (D\nabla n + \bar{w}n) . \quad (7.3.19)$$

The second term is the divergence of the current consisting of diffusion term and drift term caused by the Kähler force.

The drift velocity \bar{w} is related to the Kähler force F_K

$$\bar{w} = b\bar{F}_K , \quad (7.3.20)$$

where b is the mobility of the star. Assuming that one can associate a well defined temperature parameter to the star distribution the mobility is related to the diffusion constant D by the Einstein relation $D = bT$. Kähler force is expressible in terms of Kähler gauge potential

$$\bar{F}_K = \nabla Q \Phi . \quad (7.3.21)$$

Here $\Phi = kT_s G \omega \ln(\rho/\rho_0)$ is the gauge potential of the Kähler electric field. T_s denotes the string tension:

$$T_s \simeq .52 \times 10^{-6} \times \frac{\epsilon}{G} .$$

The lower bound for ϵ is about 10^{-7} from the previous considerations. Q is the average Kähler charge of the star: $Q \simeq \epsilon M \sqrt{G}$,

An order of magnitude estimate for diffusion constant is given by $D \simeq \langle v \rangle / n \sigma$, where $\langle v \rangle = \sqrt{T/M}$ is the average thermal velocity of star and σ is the collision cross section for collisions with other stars.

The equilibrium distribution corresponds to the cancelation of diffusion and drift currents

$$\frac{dn}{dr} \simeq -\frac{M\sqrt{G}\omega}{T} \partial_r \Phi n . \quad (7.3.22)$$

In isothermal case one obtains for the distribution of stars the following expression

$$\begin{aligned} n(\rho) &= n_0 \exp\left(-\frac{M\sqrt{G}\Phi_K \omega}{T}\right) = n_0 \left(\frac{r}{r_0}\right)^\alpha , \\ \alpha &= \frac{M\sqrt{G}T_s G \omega}{T} , \end{aligned} \quad (7.3.23)$$

so that a power law behavior results. Unfortunately, concerning the value of the temperature parameter there is nothing interesting to say.

The second alternative is based on the adiabaticity assumption

$$\frac{T}{T_0} = \left(\frac{n}{n_0}\right)^{1-\gamma} , \quad (7.3.24)$$

where γ denotes adiabatic constant. In this case one obtains

$$\begin{aligned} n(r) &= n_0 \left(A \ln\left(\frac{r}{r_0}\right) \right)^{\frac{1}{1-\gamma}} , \\ A &= (1-\gamma) M \sqrt{G} T_s \frac{G}{T_0} . \end{aligned} \quad (7.3.25)$$

for the distribution of stars.

7.3.5 Quantization of the cosmic recession velocity

The statistical analysis of the observational data about red shift of quasars [E136] shows that the distribution of emission line red shifts of quasars have a periodicity, which can be explained most nicely by assuming that the recession velocity v calculated from red shift is quantized so that one has, using the standard relation between the recession velocity and distance of the emitting object,

$$v = H_0(r_0 + nR) . \tag{7.3.26}$$

Here H_0 denotes the present value of Hubble constant. The order of magnitude for the parameter R is $R \simeq 10^8$ ly.

There is also a problem of the association between galaxies and quasars. There are indications that galaxies and quasars form correlated pairs but that the red shift of the quasar is much larger than the red shift of the galaxy [E87]. In case that the two systems are actually different physical systems, this implies that the red shift of the quasar member is of non-cosmological origin.

Various explanations for these effects have been proposed. For example, the idea that Universe is multiply connected has been put forward [E136]. According to this explanation the emission lines with different red shifts correspond to images of single object: the light emitted from the object can travel several times "around the world" before being detected and the distance to the observe is thus quantized: $r = r_0 + nL$, where L is the size of the non-simply connected Universe. Observations require that L is of the order of $L \simeq 10^8 - 10^9$ ly.

The TGD based explanation for the phenomenon is similar in spirit to this explanation (see Fig. 7.3.5). The original model for the phenomenon turned out to be inconsistent with the revised view about cosmic strings. The model however allows an obvious modification.

Original model for the quantization of red shifts

The original model was based on the idea is that null geodesic lines around the topologically condensed "big" strings ("big" meant that the parameter $K = \omega^2 R^2$ is not too far from unity) do not leave the 3-space surrounding "big" string in the center of large void of radius of order 10^8 ly and carrying strong Kähler electric field canceling its magnetic action: for the simplest geodesic the projection to the plane orthogonal to the string is just circle. Galaxies tend to be situated near the boundaries of the 3-space surrounding big string and the light emitted from quasar can travel several times around the string before being detected.

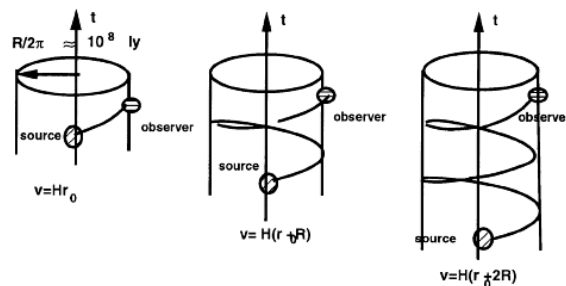

Figure 7.1: Quantization of the cosmic recession velocity.

A simplified situation is obtained, when the distance R of the emitting quasar and observer from the string is same ($R \simeq 10^8 ly$) and when the distance along string direction is L . In this case the projection of the light like geodesic on plane is circle and the motion in z -direction is along straight line. The distance traveled by light before its detection is given by the expression

$$r = \sqrt{L^2 + (r_0 + n2\pi R)^2} . \quad (7.3.27)$$

If observer and source are in same plane one obtains the previous formula for the quantized recession velocity. The size of the parameter R , which is fixed by the hypothesis that big void regions correspond to cosmic strings is indeed in accordance with the observational constraints.

It is not at all obvious that the orbit of photon can indeed be confined inside the outer critical radius ρ_+ associated with the string having $\omega R \sim 1$: the Kähler charge cannot obviously be all that matters since photons do not couple to it. For "big" strings however $\omega R \sim 1$ holds true. This is indeed the case: the physical reason is the extremely strong gravitational field caused by the big string. To see this consider the equations of motion for an orbit with circular projection in the plane orthogonal to the string. Orbit is characterized by energy conservation condition, momentum conservation condition in the direction of string, masslessness condition and the equation of motion in radial direction (essentially Kepler law)

$$\begin{aligned} \frac{dt}{ds} &= E , \\ \frac{dz}{ds} &= p , \\ E^2 g_{tt} - p^2 - \rho^2 \omega_0^2 &= 0 , \\ \rho \omega_0^2 &= \frac{\partial_\rho g_{tt} E^2}{2} , \end{aligned} \quad (7.3.28)$$

The last equation forces the photon to a circular orbit if some additional consistency conditions are satisfied and obviously requires Kähler charged string. The expression for the time component of the metric is given by

$$\begin{aligned} g_{tt} &= 1 - R^2 \omega^2 (1 - u^2) , \\ u &= \cos(\Theta) = k \ln\left(\frac{\rho}{\rho_0}\right) , \\ k &= \frac{1}{\ln\left(\frac{\rho_+}{\rho_0}\right)} . \end{aligned} \quad (7.3.29)$$

Here $u = \cos\Theta$ denotes the coordinate variable of the geodesic sphere S^2 as a function of the radial coordinate approaching value $u = -1$ at the boundary of the cylindrical region surrounding big string. These conditions boil down to the following condition fixing the value for the radius ρ of the circular orbit

$$\cos(\Theta) = \frac{1}{\sqrt{K}} \sqrt{\frac{1 - \frac{p^2}{E^2} - K}{1 - \frac{Kk^2}{\omega_0^2 \rho^2}}} . \quad (7.3.30)$$

This equation has real solutions provided the argument of the square root term is positive. In addition the condition $|\cos\Theta| \leq 1$ must hold true.

If the longitudinal momentum of the photon vanishes, one has

$$\cos(\Theta) = \frac{1}{\sqrt{K}} \sqrt{\frac{1-K}{1-\frac{Kk^2}{E^2}}} . \quad (7.3.31)$$

In the approximation $\frac{Kk^2}{E^2} \simeq 0$ this gives the bounds $1/2 < K < 1$. This condition is not consistent with the assumption that $K = R^2\omega^2$ is a small parameter given by

$$K = \frac{\epsilon}{2\alpha_K k} .$$

The small value of K is consistent with $p/E \simeq 1$ so that most of photons momentum is in the direction of string. The result means that the original model based on "big" strings in the center of the large void and explaining the observations must be given up.

Modified model for the quantization of red shifts

The modification of the previous model is obvious and much analogous to the topological model for the quantization. If closed galactic strings and torus like space-time sheets containing them and winding around the boundary of the large void are closed and are able to confine photons inside them and thus acting as cosmic wave guides, the photons from a distant star can rotate several times along these space-time sheets and same quantization of the red shift would result also now.

If the proposed explanation for the quantized red shift is correct, one can in principle observe the time development of single object from quasar to galaxy by a series of images, the time difference between two successive images being of the order of 10^8 *ly*. These images are observed on the same line of sight, when the light comes from a distant object.

7.4 Cosmic evolution and cosmic strings

In this section a general vision about cosmic evolution based on zero energy ontology is discussed.

7.4.1 Cosmic strings and generation of structures

p-Adic fractality and simple quantitative observations lead to the hypothesis that cosmic strings are responsible for the evolution of astrophysical structures in a very wide length scale range. Large voids with size of order 10^8 light years can be seen as structures containing near their boundaries long cosmic strings at around which galaxies are organized linear structures like pearls in string. The original model contained big string in the center of void but it might well be possible to do without it. Galaxies would correspond to similar string like structure with smaller size and linked around the supra-galactic strings. This indeed conforms with the finding that galaxies tend to be grouped along linear structures. Simple quantitative estimates show that even stars and planets could be seen as structures formed around cosmic strings of appropriate size. Thus Universe could be seen as fractal cosmic necklace consisting of cosmic strings linked like pearls around longer cosmic strings linked like...

The observed quantization of the cosmic recession velocity [E136] supports the proposed view. The space-time sheet of large void containing galactic cosmic strings is closed structure. The photons from a distance astrophysical experience radial outwards acceleration and are drifted to the boundaries of the void but they cannot escape this space-time sheet. Hence these photons can be detected after having traversed several times around the closed loop and the red shift is proportional to the number of traversals. In case of larger void the order of magnitude for the quantization is predicted correctly.

7.4.2 Generation of ordinary matter via TGD counterpart of Hawking radiation?

Cosmic strings can reduce their inertial masses by the analog of Hawking radiation involving the generation of fermion particle-antiparticle pairs, whose negative energy member remains inside string and annihilates there and positive energy member is radiated away. This mechanism can generate ordinary matter during initial stages of cosmic evolution and its temporal mirror image could give rise to a process analogous to the flow of ordinary matter to a black-hole during the final stages of the cosmic evolution. Highly tangled strings indeed within volume whose radius corresponds to black-hole radius indeed define a very general TGD based microscopic model of a black-hole. This "Hawking radiation" could generate at least part of the visible matter. The splitting of cosmic strings followed by a "burning" of the string ends provides a second manner to generate visible matter.

7.4.3 How single cosmic string could reduce its Kähler string tension?

The string tension of cosmic strings is due to Kähler action and has microscopic interpretation in terms of the mass of wormhole contacts having boson interpretation and fermions and super-symplectic bosons which correspond to topologically condensed CP_2 type vacuum extremals. The model of hadrons suggests that super-symplectic bosons could dominate the mass of cosmic string. If one accepts the general formula for the string tension in terms of Kähler coupling strength and quantum classical correspondence, one must conclude that the total contribution of matter to string tension equals to that of Kähler action.

One can imagine several mechanisms for how cosmic string could reduce its string tension. The topological condensation of CP_2 type vacuum extremals generates negative Kähler action so that string tension is reduced. The fact that Kähler action for the infinitely thin cosmic strings depends only on Kähler coupling strength suggests that the cosmic string transforms somehow in the process so that Kähler magnetic field flux remains constant but magnetic energy is reduced. This happens if the cosmic string develops finite transversal size in M^4 degrees of freedom since energy for magnetic flux tubes behaves as $1/S$, S the transversal thickness.

TGD predicts what I have used to call super-symplectic bosons and also their super-partners carrying having fermionic quantum numbers of right handed neutrino [K36]. These bosons have no electro-weak interactions and define a particular candidate for dark matter. Super-symplectic boson corresponds to single wormhole throat just like fermions and string like hadronic space-time sheets containing super-symplectic bosons and their super-partners connected by join along boundaries bonds to partonic space-time sheets have a key role in the recent model of hadrons. Also the model of black-hole as a gigantic hadron like entity relies on them. Two kinds of black-holes, "fermionic" and "bosonic" corresponding to strings and pairs of strings suggest themselves.

7.4.4 Zero energy ontology and cosmic strings

The combination of zero energy ontology with the cosmic evolution inspires concrete ideas about what the localization of contents of consciousness experience around narrow time interval identified as moment of subjective time could mean.

Zero energy ontology and cosmic evolution

Zero energy ontology means that all matter is creatable from vacuum as zero energy states which can be decomposed to positive and negative energy states whose space-time correlates correspond to partonic 2-surfaces in geometric past and future. This suggests strongly a picture about cosmic evolution beginning with TGD counterpart of Big Bang and ending with that of Big Crunch. It is however more appropriate to speak about "a silent whisper amplified to a big bang" since the amount of gravitational energy of cosmic strings in co-moving volume approaches zero at the limit of initial singularity.

This picture means genuine temporal non-locality and correlations over time interval T characterizing the distance between Bang and Crunch. It is however quite possible that T increases quantum jump by quantum jump and has been very small in past. The gradual shifting of the future end of zero energy state to the geometric future might relate directly to the arrow of subjective time. The usual identification of subjective time with geometric time can be understood if the arrow of subjective time corresponds to the gradual shift of the space-time volume from which the contents of conscious experience are to geometric future. TGD of course predicts a fractal hierarchy of cosmologies within cosmologies. Even elementary particle reactions have interpretation in terms of zero energy states identifiable as kind of mini-cosmologies.

If the main contribution to the contents of consciousness comes from the upper end of the zero energy state, and if T increases quantum jumps by quantum jump, this correlation could be understood and biological life cycle might have interpretation in terms of cosmology in human time scale at some level of dark matter hierarchy. Interestingly, the apparent increase of order suggests that the crunch phase might be experienced as a kind of Ω point. We could live all the subjective time at the Ω point which shifts to the geometric future quantum jump by quantum jump.

In the case of cosmic strings zero energy ontology would mean that cosmic strings are created in pairs of positive and negative energy cosmic strings. The mechanism could be non-local in the sense that the strings need not form tightly correlated pairs. An analogy with TGD based description of particle reaction would allow positive energy fermions from the geometric past and negative energy fermions from geometric future to meet somewhere in between. Bosons would correspond to tightly correlated pairs of positive and negative space-time sheets connected by wormhole contacts.

If the mechanism of generation of strings is local, "bosonic" strings formed by pairs of positive and negative inertial energy cosmic strings connected by wormhole contacts would appear near the bang and crunch so that the density of inertial energy would vanish at this limit. With respect to geometric time single sub-cosmology would correspond to kind of vacuum polarization event for inertial energy. Locality assumption is however not necessary but would be consistent with the fact that Robertson Walker cosmology for which inertial mass density vanishes works so well.

The new view about second law

Quantum classical correspondence suggests negative and positive energy strings (in the sense of zero energy ontology) tend to dissipate backwards in opposite directions of the geometric time in their geometric degrees of freedom. Time reversed dissipation of negative energy states looks from the point of view of systems consisting of positive energy matter self-organization and even self assembly. The matter at the space-time sheet containing strings in turn consists of positive energy matter and negative energy antimatter and also here same competition would prevail.

This tension suggests a general manner to understand the paradoxical aspects of the cosmic and biological evolution.

- (a) The first paradox is that the initial state of cosmic evolution seems to correspond to a maximally entropic state. Entropy growth would be naturally due to the emergence of matter inside cosmic strings giving them large p-adic entropy proportional to mass squared [K36, K5]. As strings decay to ordinary matter and transform to magnetic flux tubes the entropy related to translation degrees of freedom increases.
- (b) The dissipative evolution of matter at space-time sheets with positive time orientation would obey second law and evolution of space-time sheets with negative time orientation its geometric time reversal. Second law would hold true in the standard sense as long as one can neglect the interaction with negative energy antimatter and strings.
- (c) The presence of the cosmic strings with negative energy and time orientation could explain why gravitational interaction leads to a self-assembly of systems in cosmic time scales. The formation of supernovae, black holes and the possible eventual concentration of positive energy matter at the negative energy cosmic strings could reflect the self assembly aspect

due to the presence of negative energy strings. An analog of biological self assembly identified as the geometric time reversal for ordinary entropy generating evolution would be in question.

- (d) In the standard physics framework the emergence of life requires extreme fine tuning of the parameters playing the role of constants of Nature and the initial state of the Universe should be fixed with extreme accuracy in order to predict correctly the emergence of life. In the proposed framework situation is different. The competition between dissipations occurring in reverse time directions means that the analog of homeostasis fundamental for the functioning of living matter is realized at the level of cosmic evolution. The signalling in both directions of geometric time makes the system essentially four-dimensional with feedback loops realized as geometric time loops so that the evolution of the system would be comparable to the carving of a four-dimensional statue rather than approach to chaos.

7.4.5 A new cosmological finding challenging General Relativity

Rachel Bean has published a cosmological finding which- if correct- challenges General Relativity or at least the cosmology based on cold dark matter. The title of the article [E72] is *A weak lensing detection of a deviation from General Relativity on cosmic scales*. Both Sean Carroll [E60] and Lubos Motl [E62] commented the finding. The article *Cosmological Perturbation Theory in the Synchronous and Conformal Newtonian Gauges* [E159] by C.P. Ma and E. Bertschinger allows to understand the mathematics related to the cosmological perturbation theory necessary for a deeper understanding of the article of Bean.

The message of the article is that under reasonable assumptions General Relativity leads to a wrong prediction for cosmic density perturbations in the scenario involving cold dark matter and cosmological constant to explain accelerated expansion. The following represents my first impressions after reading the article of Rachel Bean and the paper about cosmological perturbation theory.

Assumptions

”Reasonable” means at least following assumptions about the perturbation of the metric and of energy momentum tensor.

- (a) The perturbations to the Robertson-Walker metric contain only two local scalings parameterized as $d\tau^2 \rightarrow (1 + 2\Psi)d\tau^2$ and $dx^i dx_i \rightarrow (1 - 2\Phi)dx^i dx_i$. Vector perturbations and tensor perturbations (gravitational radiation classically) are neglected.
- (b) The traceless part (in 3-D sense) of the perturbation of energy momentum tensor vanishes. Geometrically this means that the perturbation does not contain a term for which the contribution to 3-curvature would vanish. In hydrodynamical picture the vanishing of this term would mean that the mass current for the perturbation contains only a term representing incompressible flow. During the period when matter and radiation were coupled this assumption makes sense. The non-vanishing of this term would mean the presence of a flow component - say radiation of some kind- which couples only very weakly to the background matter. Neutrinos would represent one particular example of this kind of contribution.
- (c) The model of cosmology used is so called Λ CDM (cosmological constant and cold dark matter).

These assumptions boil down to a simple equation

$$\eta = \Phi/\Psi = 1. \tag{7.4.1}$$

The results

The prediction can be tested and Rachel Bean indeed did it.

- (a) Ψ makes itself visible in the motion of massive objects such as galaxies since they couple to Newton's potential. This motion in turn makes itself visible as detected modifications of the microwave background from ideal. The so called Integrated Sachs-Wolfe effect [E41] is due to the redshift of microwave photons between last surface of scattering and Earth and caused by the gravitational fields of massive objects. Ordinary matter does not contribute to this effect but dark energy does.
- (b) η makes itself visible in the motion of light. The so called weak lensing effect [E56] distorts the images of the distant objects: apparent size is larger than the real one and there is also distortion of the shape of the object.

From these two data sources Rachel Bean is able to deduce that η differs significantly from the GRT value and concentrates around $\eta = 1/3$ meaning that the scaling of the time component of the metric perturbation is roughly 3 times larger than for spatial scaling.

What could be the interpretation of the discrepancy?

What $\eta = 1/3$ could mean physically and mathematically?

- (a) From [E159] one learns that for neutrinos causing shear stress one has $\Phi = (1 + 2R_\nu/5)\Psi$, where R_ν is the mass fraction of neutrinos: hence η should increase rather than decrease! If this formula generalizes, a negative mass fraction $R = -5/3$ would be present! Something goes badly wrong if one tries to interpret the result in terms of the perturbations of the density of matter - irrespective of whether it is visible or dark!
- (b) What about the perturbations of the density of dark energy? Geometrically $\eta = 1/3$ would mean that the trace of the metric tensor defined in terms of the background metric is not affected. This means conservation of the metric determinant for the deformations so that small four-volumes are not affected. As a consequence, the interaction term $T^{\alpha\beta}\delta g_{\alpha\beta}$ receives a contribution from $G^{\alpha\beta}$ but not from the cosmological term $\Lambda g^{\alpha\beta}$. This would suggest that the perturbation is not that of matter but of the vacuum energy density for which one would have

$$\Lambda g^{\alpha\beta}\delta g_{\alpha\beta} = 0 . \quad (7.4.2)$$

The result would not challenge General Relativity (if one accepts the notion of dark energy) but only the assumption about the character of the density perturbation. Instead of matter it would be the density of dark energy which is perturbed.

TGD point of view

What TGD could say about this.

- (a) In TGD framework one has many-sheeted space-time, dark matter hierarchy represented by the book like structure of the generalized imbedding space, and dark energy is replaced with dark matter at pages of the book with gigantic Planck constant so that the Compton lengths of ordinary particles are gigantic and the density of matter is constant in long scales so that one can speak about cosmological constant in General Relativity framework. The periods with vanishing 3-curvature are replaced by phase transitions changing the value of Planck constant at some space-time sheets and inducing lengthening of quantum scales: the cosmology during this kind of periods is fixed apart from the parameter telling the maximal duration of the period. Also early inflationary period would correspond to his kind of phase transition. Obviously, many new elements are involved so that it is difficult to say anything quantitative.

- (b) Quantum criticality means the existence of deformations of space-time surface for which the second variation of Kähler action vanishes. The first guess would be that cosmic perturbations correspond to this kind of deformations. In principle this would allow a quantitative modeling in TGD framework. Robertson-Walker metrics correspond to vacuum extremals of Kähler action with infinite spectrum of this kind of deformations (this is expected to hold true quite generally although deformations disappear as one deforms more and more the vacuum extremal).
- (c) Why the four-volumes defined by the Robertson-Walker metric should remain invariant under these perturbations as $\eta = 1/3$ would suggest? Are the critical perturbations of the energy momentum tensor indeed those for the dominating part of dark matter with gigantic values of Planck constant and having an effective representation in terms of cosmological constant in GRT so that the above mentioned equations implying conservation of four-volume result as a consequence?
- (d) The most natural interpretation for the space-time sheets mediating gravitation is as magnetic flux tubes connecting gravitationally interacting objects and thus string like objects of astrophysical size. For this kind of objects the effectively 2-dimensional energy momentum tensor is proportional to the induced metric. Could this mean -as I proposed many years ago when I still took seriously the notion of the cosmological constant as something fundamental in TGD framework- that in the GRT description based on the replacement string like objects with energy momentum tensor the resulting energy momentum tensor is proportional to the induced metric? String tension would explain the negative pressure preventing the identification of dark energy in terms of ordinary particles.
- (e) It is not clear whether the GRT based explanation of the accelerated expansion in terms of cosmological constant describing the presence of cosmic strings with large Planck constant conforms with the explanation in terms of phase transitions increasing Planck constant to which TGD assigns critical cosmology with negative string tension. Can one say that the presence of cosmic strings with gigantic Planck constant induces these phase transitions?
- (f) Note that the gigantic value of \hbar_{gr} implies that for the energies usually assigned with gravitons the wave-length would be enormous so that these gravitons could correspond to string like objects connecting source and detector! Dark graviton with a frequency typically assignable to an astrophysical system would have enormous energy. Dark gravitons would decay to bunches of ordinary gravitons before arriving the detector [K85] so that the flux of ordinary gravitons would not be constant.

7.5 Cosmic string model for galaxies and other astrophysical objects

The new view about the relationship between gravitational and inertial energy forces to modify the original model based of galaxy based on split cosmic strings. Splitting, although possible, might not be needed since Hawking radiation might replace it as a basic mechanism generating visible matter. By p-adic fractality the mechanism generalizes and provides a universal mechanism for the generation of astrophysical structures and universe can be seen as fractal necklace containing coiled pairs of cosmic strings linked around larger structures of similar kind linked...

7.5.1 Cosmic strings and the organization of galaxies into linear structures

Astronomical observations suggest that galaxies form linear structures [E197]. This inspired the original TGD based model of galaxies as decay products of split cosmic strings forming kind of cosmic fire crackers. The required order of magnitude for the string tension was of order $10^{-6}/G$ the same as the string tension of the cosmic strings predicted by TGD (so that CP_2 radius would reflect itself directly in the galactic dynamics!). The model suggested also a solution of galactic

dark matter problem since the net mass of a ball containing string is expected to depend linearly on the radius of the ball as indeed found.

One problem of this model was that galactic strings ought be in the plane of the galaxy. The galactic jets which one might expect to be parallel to the strings are however orthogonal to the galactic plane which suggests that visible matter condensed on certain points of a long string roughly orthogonal to the galactic plane.

The new view about the relationship between inertial and gravitational energy and the necessity of cosmological constant forces to modify this scenario.

- (a) The observation that galaxies are organized in linear structures can be understood if the basic structures cosmic strings with string tension determined by Kähler action and winding in a spaghetti like manner along the boundaries of large voids. Part of ordinary matter would results as a Hawking radiation from these strings but the very fact these strings are mostly invisible suggests that the matter emitted by them remains in the vicinity of strings. Visible jets orthogonal to the galactic plane usually interpreted in terms of black hole emissions could correspond to the emission of Hawking radiation from these structures. Galaxies are concentrations of visible matter around these strings and they are roughly orthogonal to the plane of galaxy.
- (b) The generation of positive and negative energy matter with zero net energy from vacuum does not contribute to the inertial energy in time scales longer than the scale of causal diamond (CD) involved. This has occurred already during string dominated critical period during which the density of gravitational mass behaves as $\rho \propto 1/a^2$ as a function of the light cone proper time and the mass per co-moving volume is proportional to a . The fractality of TGD inspired cosmology suggests that the creation pairs of positive and negative energy cosmic strings giving rise to cosmologies inside cosmologies has occurred also later in smaller length scales. In particular, galaxies and even smaller structures could be seen as cosmologies within cosmologies. Pairs of cosmic strings and magnetic flux tubes are not visible and are thus excellent candidates for the dark matter. The non-conservation of inertial and gravitational energy identified locally as energy associated with positive energy part of the local zero energy state supports this view.

If the initial inertial and gravitational mass per unit length of these objects is same as that for a free string, the order of magnitude for the gravitational energy density of dark matter per volume is predicted correctly if the length L of string inside sphere R is proportional to its radius: $L \propto R$. Galaxies could be strongly knotted relatively short cosmic strings linked around the long cosmic strings like pearls in a necklace. Their shortness would mean that they do not contribute significantly to the mass of the void.

- (c) p-Adic fractality suggests that even smaller astrophysical structures might involve strings linked with larger strings linked with...., the cosmic necklace would be a fractal necklace. In the case of Sun a string of length $L \sim 10^{11}$ m, which is not far from the distance $AU = 1.5 \times 10^{11}$ m between Earth and Sun, would be needed whereas the radius of Sun is $\sim 7 \times 10^8$ meters. Thus the magnetic flux tubes resulting form these strings could wind around solar system and bind the entire system into single coherent magnetic structure. For Earth one would have $L \sim 3 \times 10^5$ m, which is smaller than the radius $R = 6.4 \times 10^6$ m of Earth. What makes this interesting is that quite recently it has been announced that Earth contains a previously unidentified core region with size of 3×10^5 m [F34] . This picture suggest a universal mechanism for the evolution of the solar system replacing the existing Newtonian model based on the amplification of gravitational perturbations.

7.5.2 Cosmic strings and dark matter problem

Consider now the idea that the presence of cosmic strings might solve the dark matter puzzle [E90] . The presence of the dark matter is indicated by the velocity spectrum of the distant stars (at distance of few tens of kilo-parsecs from the center of the galaxy), which according to the recent observations [E110, E142] approaches to a constant depending on the galaxy in question and having the general order of magnitude $V \simeq 10^{-3}$.

One can estimate the velocity V of a distant star in galactic plane from Kepler law (the spherically symmetric model for galaxy suggests that this argument indeed applies)

$$\frac{V^2}{R} = \frac{GM(R)}{R^2} , \quad (7.5.1)$$

where $M(R)$ denotes the mass inside a sphere of radius R . Since the mass of the cosmic string dominates the mass inside a sphere of radius R one gets the following very rough estimate for the effective gravitational mass inside the sphere of radius R

$$M(R) \simeq n2TR , \quad (7.5.2)$$

where $n > 1$ accounts for the fact that straight string is not in question. From the known velocity V one obtains for the string tension the estimate

$$T \sim \frac{V^2}{4nG} \sim \frac{10^{-6}}{4nG} \sim v_D T_{free} . \quad (7.5.3)$$

This estimate is of the same order of magnitude as the lower bound of string tension obtained from the Jeans criterion. The result is also consistent with the assumption that, due to their gravitational binding to strings, stars rotate with the same velocity as strings.

Recall that an upper bound for the string tension of the TGD cosmic string is given by

$$T = \frac{1}{8\alpha_K R^2} \simeq .52 \times 10^{-6} \frac{1}{\hbar_0 G} .$$

This is roughly twice the required tension for $n = 1$ so that TGD is consistent with the experimental input. The effective string tension of the co-moving string also increases for $r \rightarrow r_0$ (see the general description of cosmic string solution) and diverges at $r = 0$. Furthermore, since the cosmic string is not straight there appears additional factor n making $M(R)$ larger than the simple estimate above.

On basis of these observations one has a strong temptation to think that the still existing cosmic strings, possibly thickened to magnetic flux tubes, correspond to galactic and extragalactic dark matter. At this stage one must leave open whether the naive argument leads to a correct form for the velocity spectrum of stars. Whether or not true this prediction would have nice features in that it would relate the velocity spectrum directly to the size and age of the galaxy since the velocity v determines the recent size of the visible galaxy (if it corresponds to the recent distance of the string end from the center of galaxy): the older the galaxy with given size the smaller the rotational velocity v . Elliptic galaxies are older than spiral galaxies: rotational velocities for the elliptic galaxies are indeed smaller than for spiral galaxies [E142]. Furthermore, the rotational velocities increase with the size of the galaxy, when the age of the galaxy is kept constant: also this feature is in qualitative accordance with observed facts [E110, E142].

An interesting question is whether one could explain the angular momentum of galaxies in terms of the tidal forces acting between the galaxies [E77] at the opposite ends of a string (having length of order 10^5 light years. The idea is following. For free cosmic string there is a flux of angular momentum of order Tar^2 (using Robertson-Walker coordinates (a, r)) through the end of the string, which produces a correct order of magnitude for the galactic angular momentum at time a given by $J \sim Ta^2r^2 = Tr_M^2$, $r_M \sim 10^5 ly$.

7.5.3 Estimate for the velocity parameters

The first task is to fix the value of the velocity parameter, to be denoted by V , appearing in the general solution describing one arm of the split cosmic string. In the region, where linearized equations of motion hold the orbital velocity V of the cosmic string is constant.

The radius of the singular region associated with cosmic string increases with some velocity v_D identifiable as the velocity with which the size of a typical galaxy (defined for example as the distance of spiral arm L from the center of galaxy) is about $L \simeq 10^4 - 10^5$ light years [E165, E135]. The condition $v_D T < L$, where $T \simeq 10^9 - 10^{10}$ years is the typical age of the galaxy, gives the estimate

$$v_D < 10^{-5} , \quad (7.5.4)$$

for the velocity v_D using the velocity of light as unit.

One can relate the velocity v_D to the string tension if one accepts the assumption that the relative motion of the string ends results from the shortening of strings, which in turn results from the decay of the string ends to elementary particles (some of them possibly exotics). A rough estimate for the velocity of the shortening of the string [E190] is based on the observation that the velocity

$$v \simeq TG \sim 10^{-6} \quad (7.5.5)$$

seems to set the time scale for the various dynamical processes leading to the decay of strings [E190]: for example, the shortening of loop with radius L via gravitational radiation as well as the shortening of the string connecting the monopole pair takes place with this velocity [E190]. This velocity is considerably smaller than the typical velocity $V \simeq 10^{-3}$ [E110, E142] of the distant stars moving in the galactic plane, which in turn can be understood using Kepler law.

The idea that the spiral arms of the spiral galaxy correspond to cosmic strings seems to be in accordance with the observational facts. In case of Milky Way [E165] the distance of spiral arms is about $L = 10^4 - 10^5$ light years from the center of the galaxy so that the order of magnitude for the velocity v_D is $v_D \sim 10^{-6} - 10^{-5}$. Furthermore, spiral arms are known to recede from the center of the Milky Way [E165].

The model suggests also an explanation for the observed bar like structure connecting the ends of the spiral arms of the spiral galaxies. The gravitational field is most intense near the string end so that the density of the ordinary matter is expected to be largest near the end of the string. On the other hand, the orbit of the string end is straight line so that "bar" like structure might be formed [E135], when the ends of the spiral arms recede from each other.

It should be stressed that the visible form of galaxies is not so closely related with the form of strings contrary to the original expectations (we used the term "spiral string"). This is clear from the observation that the total change of angle ϕ is smaller than $\pi/2$, which means that simplest cosmic strings are really not "spiral" like. Of course, this result holds for free strings and it might be that condensation in fact creates spiral structure somehow. A more conventional explanation is the generation of density waves with spiral structure [E179] and the presence of strings might have something to do with this phenomenon.

7.5.4 Galaxies as split cosmic strings?

It is not clear whether the Hawking radiation from a coiled pair of cosmic strings is able to explain galactic visible matter. The reason is that the cosmic strings responsible for linear structures formed by galaxies are not visible along their entire length. One might argue that same applies also the knotted and linked galactic cosmic string pairs. If this is the case, the dark

- (a) The size L of the density fluctuation leading to the formation of a structure satisfies the inequality

$$l_J < L < l_H , \quad (7.5.6)$$

where the Jeans length l_J is given by [E190]

$$l_J \simeq 10v_s t , \quad (7.5.7)$$

where v_s denotes the velocity of sound. Notice that the formation of structures is not possible at the radiation dominated era since Jeans length is larger than horizon: $l_H \simeq t < l_J \simeq 10t$ since the velocity of sound is of order 1.

- (b) When radiation and matter decouple from each other (corresponding to the value of about $a_{dec} = 10^8$ light years [E193]), the formation of galaxies becomes possible due to the lowering of the pressure, which leads also to the lowering of the sound velocity v_s from $v_s \simeq 1$ to $v_s \simeq 10^{-5}$ (thermal velocity of hydrogen). Jeans length shortens by a factor 10^{-5} and the formation of structures becomes possible.

In accordance with the idea that the split strings act as seeds for the galaxy formation, one can identify Jeans length as the minimal distance between the ends of the split string, which leads to a formation of galaxy

$$v_D a_{dec} > l_J . \quad (7.5.8)$$

Using the values for a_{dec} and l_J one obtains lower bounds for the velocity v_D between the ends of the galactic string and for the string tension of the galactic strings (accepting the proposed relationship between v_D and string tension)

$$\begin{aligned} v_D &> 10^{-6} , \\ T &> \frac{10^{-6}}{G} . \end{aligned} \quad (7.5.9)$$

One obtains also a lower bound for the recent size L_{now} of the galactic nuclei assuming that the decay of galactic strings continues with velocity v_D

$$L_{now} > 10^4 ly . \quad (7.5.10)$$

These numbers are in accordance with the estimate obtained for the string tension of a typical galactic strings and with what is known about recent sizes of the galaxies [E135] .

Spherically symmetric model

The imbeddability requirement plays central role in TGD inspired cosmology and the galaxy model based on spherically symmetric mass ($M(r) = kr$) distribution is of some interest. This model could be regarded as a large length scale idealization of galaxy mass distribution. In case that galactic dark matter consists of the exotic decay products of the cosmic string the model might be even reasonably realistic. The line element for an energy momentum tensor characterized by energy density $\rho(r)$ and pressure $p(r)$ is given by the expression $ds^2 = A(r)dt^2 - B(r)dr^2 - r^2d\Omega^2$ and to find an imbedding for this metric one can use the general imbedding ansatz introduced, when discussing the imbedding of Reissner- Nordström metric.

Under rather general assumptions about the mass density the time component of the metric for a spherically symmetric mass distribution $M(r)$ (the mass inside the sphere of radius r) is given by the expression $g_{tt} = 1 - 2GM(r)/r$. In present case one would obtain $g_{tt} = \text{constant}$ so that some of the underlying assumptions must fail. The following form leads to a correct gravitational force

$$g_{tt} = 1 + 2Gk \ln\left(\frac{r}{r_0}\right) . \quad (7.5.11)$$

The gravitational force in the Newtonian limit is $2Gk/r = 2GM(r)/r^2$ and implies that Kepler law to be used later to derive velocity distribution of distant stars is indeed applicable.

The general expression for the metric component g_{tt} in terms of the imbedding ($m^0 = \lambda t, \Theta = \Theta(r), \Phi = \omega t + f(r)$)

$$g_{tt} = \lambda^2 - R^2 \omega^2 \sin^2(\Theta) , \quad (7.5.12)$$

which gives

$$\sin^2(\Theta) = \lambda^2 - 1 - \frac{2Gk}{R^2 \omega^2} \ln\left(\frac{r}{r_0}\right) . \quad (7.5.13)$$

Imbedding fails for two critical radii r_{in} ($\sin^2(\Theta) = 1$) and r_{out} ($\sin^2(\Theta) = 0$)

$$\begin{aligned} \ln\left(\frac{r_{in}}{r_0}\right) &= \frac{(\lambda^2 - 1 - R^2 \omega^2)}{2Gk} , \\ \ln\left(\frac{r_{out}}{r_0}\right) &= \frac{(\lambda^2 - 1)}{2Gk} . \end{aligned} \quad (7.5.14)$$

An interesting question is whether one could relate the inner critical radii to the existence of the galactic nucleus having diameter of the order of 2 parsecs (.65 light years).

7.5.5 Cylindrically symmetric model for the galactic dark matter

TGD allows also a model of the dark matter based on cylindrical symmetry. In this case the dark matter would correspond to the mass of a cosmic string orthogonal to the galactic plane and traversing through the galactic nucleus. The string tension would be the one predicted by TGD. In the directions orthogonal to the plane of galaxy the motion would be free motion so that the orbits would be helical, and this should make it possible to test the model. In this kind of situation general theory of relativity would predict only an angle deficit giving rise to a lens effect. TGD predicts a Newtonian $1/\rho$ potential in a good approximation.

Spiral galaxies are accompanied by jets orthogonal to the galactic plane and a good guess is that they are associated with the cosmic strings. The two models need not exclude each other. The vision about astrophysical structures as pearls of a fractal necklace would suggest that the visible matter has resulted in the decay of cosmic strings originally linked around the cosmic string going through the galactic plane and creating $M(R) \propto R$ for the density of the visible matter in the galactic bulge. The finding that galaxies are organized along linear structures [E197] fits nicely with this picture.

7.5.6 New information about the distribution of galactic dark matter

The newest discovery relating to the galactic dark matter is described in the popular article 'Milky Way Has a "Squashed Beachball"-Shaped Dark Matter Halo' [E69] . In more formal terms the title states that the orbit of the dwarf galaxy Sagittarius around Milky Way can be understood if the cold dark matter halo is not spherical but ellipsoid with different half axes in each three orthogonal directions. The dark matter distribution allowing the best fit is nearly orthogonal to the galactic plane and looks like a flattened sphere with height equal to one half of the diameter (see the illustration of the article [E69]).

The result is surprising since the most natural expectation is a complete spherical symmetry or ellipsoid with a rotational symmetry around the axes orthogonal to the galactic plane. The complete breaking of the rotational symmetry raises the question whether something might be wrong with the usual dark matter models. The following text is strongly updated version of the original one, which contained several errors and was badly organized.

Observations

Consider first in some detail what has been observed. Since the life span of the astronomers is not astronomical, they are not able to measure the orbit of the dwarf galaxy directly. The orbit of the dwarf galaxy can be however deduced from the stream of stars which Milky Way has ripped out from the dwarf galaxy.

Sagittarius is one of the 14 dwarf galaxies forming a gravitational bound state with Milky Way. It is an elliptic dwarf with a diameter of 10^4 light years (about size as the core of Milky Way). It has rotated about 1 My around Milky Way and already made about 10 full rotations. Now (in astronomical sense) Sagittarius is about to traverse the plane of Milky Way. During its motion Sagittarius experiences enormous tidal forces ripping out stars from it. The resulting stream of ripped out stars marks the orbit of Sagittarius. Obviously Sagittarius loses its mass to Milky Way and has already lost a considerable fraction. The ability of Sagittarius to maintain its coherence has been explained in terms of unusually high dark matter content.

The article states that the study of the paths for the parts of Sagittarius gives different parameters for the dark matter distribution. Maybe the "parts" refer to the four globular clusters of stars belonging to Sagittarius. In any case, a highly refined study of the structure of the star stream left behind by Sagittarius is carried out and one goal has been to find a gravitational potential allowing to fit the paths of the parts deduced from the star debris left behind by Sagittarius. The fact that Sagittarius has made several rotations around Milky Way explains why the "leading star debris" is present in the illustration of [E69] . The movie about the orbit of Sagittarius [E42] gives an artistic simulation about the situation. It seems that an illustration of the actual track from different angles in the galactic plane must be in question.

The basic observation is that the track is in a good approximation in plane. What one can conclude from this depends on what happens in the ripping out process. The star becomes part of Milky Way in some sense. The ripped out star experiences a free fall in the gravitational field of the Milky way. The question concerns what happens to the velocity of the star as it is ripped out.

- (a) The most natural guess is that the initial velocity is in a good approximation parallel to the velocity at the moment of ripping out.
- (b) A much stronger assumption is that the star eventually rotates with the same velocity as the distant stars of Milky Way around its center after the ripping out. If the dark matter is also rotating as it should be and forms a halo the gravitational interactions with it could force the hydrodynamic behavior. If one believe that dark matter in astrophysical length scales can have gigantic value of Planck constant, then hydrodynamics behavior looks natural.

Two models of dark matter

TGD allows to consider two alternative models for the dark matter. Contrary to the first guess both models are consistent if the ripping out process is interpreted in the first manner and need

not therefore be hydrodynamic. Both models are consistent with the assumption that dark matter corresponds to particles at magnetic flux tubes, which are dark in the sense that they reside at different pages of the book like structure defined by the generalized imbedding space with pages labeled by differed values of Planck constant. Magnetic flux tubes can be regarded as outcomes of cosmic expansion thickening the extremely thin cosmic strings and weakening the extremely strong magnetic fields inside them.

Classically dark matter corresponds to the magnetic energy of cosmic string. This interpretation is not locally consistent with the General Relativistic form of the Equivalence Principle if one considers a model for the string like object itself. Einstein's equations however make sense when one considers only the long range gravitational fields created by cosmic strings.

The two models are following.

- (a) The first model is very similar to the standard models of dark matter. If the galactic dark matter consists of decay products of a closed non-circular cosmic string approximately vertical to the galactic plane, a non-spherically symmetric distribution of dark matter is expected and there is qualitative consistency with the observed squeezed sphere character. If the ripping out leads rapidly to a hydrodynamic behavior the stream of the particles should rotate around Milky Way destroy the planarity of the debris stream. This would be like rocket in straight path through a rotating liquid: the used fuel would start to rotate with fluid.
- (b) In the second model galactic dark matter as matter resides at long cosmic string perpendicular to galactic plane. The matter in galactic plane could be also partially dark and visible matter could have resulted as decay products of the cosmic string transformed to magnetic flux tube. Galactic strings would have been linked around the long strings like pearls in necklace and this would explain the observed long strings of galaxies.

Consider next in detail the latter model. The very heavy cosmic string like object along the axis perpendicular to the galactic plane creates (in the Newtonian approximation) 2-D logarithmic potential forcing everything to rotate with a constant velocity around it. Besides this there is a weaker nearly vertical acceleration orthogonal to the plane created by the matter in the galactic plane. If the density of the matter in the galactic plane is approximated with a constant density, the motion of the individual star is a superposition of a free fall in the perpendicular direction and scattering in a logarithmic potential of form $K \log(\rho/\rho_0)$ in the approximation that the individual stars of the dwarf galaxy move completely independently. Second extreme would be a hydrodynamic flow.

Sagittarius rotates around the axis orthogonal to the plane of galaxy with the same velocity as the galactic matter identified as the velocity of the distant stars in the galactic plane (the constancy of this velocity led to the discovery of dark matter). Stating it differently, the motion of the stars of dwarf galaxy takes place in a potential, which is sum of a potential $V_1(\rho)$ depending on the radial coordinate of the plane and a potential $V_2(z)$ depending on the vertical coordinate and created by the galactic matter.

The models differ from each other in several respects.

- (a) In the first model the simplest gravitational potential would be some function $V(r)$ of the 3-D radial coordinate and in the first approximation logarithmic. The rotation around the axes of Milky way takes place with a smaller velocity as in case of Milky Way and dark matter. The ripping out process is not consistent with the hydrodynamic behavior. The necessity to modify the spherically symmetric distribution of matter might reflect the fact the behavior is actually hydrodynamic.
- (b) In the second model galactic matter and Sagittarius itself would rotate with approximately the same velocity around the cosmic string and the ripping out process could be rather smooth since the velocity component in the galactic plane would not be affected in the ideal case. This model is consistent with the hydrodynamic behavior. In the optimal situation only the vertical gravitational forces due to the matter in the galactic plane would tend to rip out stars. This might relate to the fact that Sagittarius has been able to maintain its coherence so long. The article "Missing matter mystery of small galaxies"

in New Scientist tells about mysterious missing dark matter [E92] . Roughly half of the dark matter predicted by theories is missing. The dark matter at the long cosmic strings would be the natural candidate for this missing dark matter if visible and dark matter in the plane of galaxy identifiable as decay products of galactic cosmic strings is responsible for the visible matter and already identified dark matter.

Some details related to the central string model

It is interesting to look in more detail the toy model based on cosmic string vertical to the galactic plane (also in this case matter in galactic plane could be decay remnants of a cosmic string). The energies for vertical and transverse motions are conserved separately as is also angular momentum component in vertical direction and one can solve the Newton's equations exactly. By Equivalence Principle one can speak about energy and angular momentum per unit mass: therefore notations e_z, e_T, l for the energies and angular momentum are natural.

- (a) Energy conservation in the vertical direction gives

$$v_z^2 + 2g_G \times z = 2e_z \quad , \quad (7.5.15)$$

where g_G is the analog of gravitational acceleration at the Earth's surface and created by a constant density of the galactic matter in the galactic plane.

- (b) Angular momentum conservation gives

$$\rho^2 \omega = l \quad . \quad (7.5.16)$$

- (c) The conservation of energy in plane orthogonal to z -axis gives the third conservation law

$$\left(\frac{d\rho}{dt}\right)^2 + \frac{l^2}{\rho^2} + 2K \log\left(\frac{\rho}{\rho_0}\right) = 2e_T \quad . \quad (7.5.17)$$

These conditions allow to solve the equations of motions for e_z, e_T , and l for each star involved and the mass of the star does not matter at all. In hydrodynamical model correlations between velocities of stars are forced by idealization as continuous matter. In this case the flow lines correspond to classical orbits with gradient of pressure added as an additional force to gravitational force. Energy and angular momentum are conserved along flow lines also now. Situation becomes more complex (and realistic) when one takes into account the gravitational forces between stars.

7.5.7 Cold dark matter in difficulties

Cold dark matter scenario [E9] assumes that dark matter consists of exotic particles having extremely weak interactions with ordinary matter and which clump together gravitationally. These concentrations of dark matter would grow and attract ordinary matter forming eventually the galaxies.

Cold dark matter scenario (CDM) has several problems.

- (a) Computer simulations support the view that dark matter should be densely packed in galactic nuclei. This prediction is problematic since the constant velocity spectrum of distant stars rotting around galactic nucleus requires that the mass of dark matter within sphere of radius R is proportional to R so that the density of dark matter would decrease as $1/r^2$. This if one assumes that the distribution of dark matter is spherically symmetric.
- (b) Observations show that in the inner parts of galactic disk velocity spectrum depend linearly on the radial distance [E75]. Dark matter density should be constant in good approximation (assuming spherical symmetry) whereas the cold dark matter model represent is strong peaking of the mass density in the galactic center. This is known as core/cusp problem.

- (c) CDM predicts also large number of dwarf galaxies with mass which would be about one thousandth of that for the Milky Way. They are not observed. This is known as missing satellites problem.
- (d) CDM predicts significant amounts of low angular momentum material which is not observed.

Already these problems suggest that CDM is somehow wrong. Quite recently a further problem related to dwarf galaxies has been identified as one learns from Science Daily article Dark Matter Mystery Deepens [E14]. Dwarf galaxies are believed to contain 99 per cent of dark matter and are therefore ideal for the attempts to understand dark matter. They differ from ordinary ones in that stars inside them move like bees in beehive instead of moving along nice circular orbits. The observational data about the structure of dark matter in dwarf galaxies is in conflict with the predictions of cold dark matter scenario. New measurements about two dwarf galaxies tell that dark matter distribution is uniform over a region with diameter of several hundred light years which corresponds to the size scale of the galactic nucleus. For comparison purposes note that Milky Way has at its center a bar like structure with size between 3,300-16,000 ly. Notice also that also in ordinary galaxies empirical data support strongly constant density core (core/cusp problem) so that in the real world dwarf galaxies and ordinary galaxies need not be so different after all.

In TGD framework the simplest model for the galactic dark matter assumes that galaxies are like pearls in a necklace. Necklace would be long magnetic flux tube carrying dark energy identified as magnetic energy and galaxies would be bubbles inside the flux tube which would have thickened locally. Similar model would apply to stars. The basic prediction is that the motion of stars along flux tube is free apart from the gravitational attraction caused by the visible matter. Constant velocity spectrum for distant stars follows from the logarithmic gravitational potential of the magnetic flux tube and cylindrical symmetry would be absolutely essential and distinguish the model from the cold dark matter scenario.

What can one say about the dwarf galaxies in TGD framework? The thickness of the flux tube is a good guess for the size scale in which dark matter distribution is approximately constant: this is true for any galaxy (recall that dark and ordinary matter would have formed as dark energy transforms to matter). The scale of hundred light years is roughly by a factor of 1/10 smaller than the size of the center of the Milky Way nucleus. If dark matter density equals to the density of dark energy (magnetic energy) which has given rise to the dark matter, dark matter distribution is naturally spherically symmetric and constant in this scale. This could be true also for ordinary galaxies. If so, the cusp/core problem would disappear and ordinary galaxies and dwarf galaxies would not differ in an essential manner as far as dark matter is considered. The problem would be essentially that of cold dark matter scenario.

7.5.8 Three blows against standard view about dark matter

The standard view about dark matter is in grave difficulties.

- (a) The assumption is that galactic dark matter forms a spherical halo around the galaxy: with a suitable distribution this would explain constant velocity distribution of distant stars. Sometime ago NASA [E64] reported that Fermi telescope does not find support for dark matter in this sense in small faint galaxies that orbit our own.
- (b) Another blow [E65] against standard view came now. A team using the MPG/ESO 2.2-metre telescope at the European Southern Observatory's La Silla Observatory, along with other telescopes, has mapped the motions of more than 400 stars up to 13,000 light-years from the Sun. Also in this case the signature would have been the gravitational effects of dark matter. No evidence for dark matter has been found in this volume. The results will be published in an article entitled "Kinematical and chemical vertical structure of the Galactic thick disk II. A lack of dark matter in the solar neighborhood," by Moni-Bidin et al. to appear in The Astrophysical Journal.

These findings support the TGD based model for galactic dark matter (to be carefully distinguished from dark matter as large \hbar phases appearing in much smaller amounts and essential for life in TGD inspired quantum biology). TGD based model for the galactic dark matter postulates that the dominating contribution is along long magnetic flux tubes resulting from these during cosmic expansion and containing galaxies around them like pearls in a necklace.

The distribution of dark matter would be concentrated around this string rather than forming a spherical halo around galaxy. This would give rise to a gravitational acceleration behaving like $1/\rho$, where ρ is transversal distance from the string, explaining constant velocity spectrum for distant stars. The killer prediction is that galaxies could move along the string direction freely. Large scale motions difficult to understand in standard cosmology has been indeed observed. It has been also known for a long time that galaxies tend to concentrate on linear structures.

The third blow [E63] against the theory comes from the observation that Milky Way has a distribution of satellite galaxies and star clusters, which rotate around the Milky Way in plane orthogonal to Milky Way's plane. One can visualize the situation in terms of two orthogonal planes such that the second plane contains Milky Way and second one the satellite galaxies and globular clusters. The Milky Way itself has size scale of .1 million light years whereas the newly discovered structure extends from about 33,000 light years to 1 million light years. The study is carried out by astronomers in Bonn University and will be published in journal Monthly Notices of the Royal Astronomical Society. The lead author is Ph. D. student Marcel Pawlowski.

According to the authors, it is not possible to understand the structure in terms of the standard model for dark matter. This model assumes that galactic dark matter forms a spherical halo around galaxy. The problem is the planarity of the newly discovered matter distribution. Not only satellite galaxies and star clusters but also the long streams of material left - stars and also gas - behind them as they orbit around Milky Way move in this plane. Planarity seems to be a basic aspect of the internal dynamics of the system. As a matter fact, quantum view about formation of also galaxies predicts planarity and this allows also to understand approximate planarity of solar system [K61]: common quantization axis of angular momentum defined by the direction of string like object in the recent case with a gigantic value of gravitational Planck constant defining the unit of angular momentum would provide a natural explanation for planarity.

The proposal of the researchers is that the situation is an outcome of a collision of two galaxies.

- (a) An amusing co-incidence is that the original TGD inspired model for the formation of spiral galaxies [K24] assumed that they result when two primordial cosmic strings intersect each other. This would be nothing but the counterpart of closed string vertex giving also rise to reconnection of magnetic flux tubes. Later I gave up this assumption and introduced the model in which galaxies are like pearls in necklace defined by primordial cosmic strings which since then have thickened to magnetic flux tubes. These pearls could themselves correspond to closed string like objects or their decay products. Magnetic energy would transform to matter and would be the analog for the decay of inflaton field energy to particles in inflationary scenarios.
- (b) As already noticed, in TGD Universe galactic dark matter would correspond to the matter assignable to the magnetic flux tube defining the necklace creating $1/\rho$ gravitational accelerating explaining constant velocity spectrum of distant stars in galactic plane.

Could one interpret the findings by assuming two big cosmic strings which have collided and decayed after that to matter? Or should one assume that the galaxies existed before the collision?

- (a) The collision would have induced the decay of portions of these cosmic strings to ordinary and dark matter with large value of Planck constant. The magnetic energy of the cosmic strings identifiable as dark energy would have produced the matter. It is however not clear why the decay products would have remained in the planes orthogonal to the colliding orthogonal flux tubes. According to the researchers the planar structures must have existed before the collision.
- (b) This suggests that the two flux tubes pass near each other and the galaxies have moved along the flux tubes and collided and remained stuck to each other by gravitational attraction.

The probability of this kind of galactic collisions depends on what one assumes about the distribution of string like objects. Due to their mutual gravitational attraction the flux tubes could be attracted towards each other to form web like structures forming a network of cosmic highways. Milky Way would represent on particular node at which two highways form a cross-road. In this kind of situation the collisions resulting s cross-road crashes could be more frequent than those resulting from encounters of randomly moving strings. The galaxies arriving to this kind of nodes would tend to form a bound state and remain in the node. It could also happen that the second galaxy continues its journey but leaves matter behind in the form of satellite galaxies and globular clusters.

It is encouraging that the TGD based explanation for galactic dark matter survives all these three discoveries meaning grave difficulties for the halo model.

7.6 Cosmic strings and energy production in quasars

One of the basic mysteries of astrophysics are so called 'central engines' in the centers of the galaxies [E157] . These engines are very massive, have very small size of at most few light hours, their luminosity fluctuates in hour time scale, their electromagnetic spectrum is non-thermal and they are often accompanied by two jets in opposite directions. One should also understand why some galaxies are active (have a pair of jets) and others are not. A mysterious property of jets is their microstructure: main jets with length of order 10^6 light years are accompanied by short jets with length of order one light year and with directions parallel to the long jets.

In the standard model the central engine is a galactic black hole but the mechanism of the jet production is not well understood. In the following it is shown that decaying cosmic string ends provide a good candidate for the central engine. Note that in the standard picture jets are orthogonal to galactic plane whereas in the proposed model jets are parallel to the galactic plane. One could consider also the possibility that galaxies are formed in the splitting of cosmic strings orthogonal to galactic plane but this option will not be discussed here.

7.6.1 Basic properties of the decaying cosmic strings

The rate for the shortening of a split galactic cosmic string can be deduced by an order of magnitude argument

$$\begin{aligned} v &\sim kTG \ , \\ T &\simeq \frac{2 \times 10^{-7}}{G} \ . \end{aligned} \tag{7.6.1}$$

T is the string tension of the cosmic string. k is some numerical constant not too far from unity. The numerical study of the *ordinary* cosmic strings [E190] gives support for this order of magnitude estimate.

Taking the age of the Universe to be $a \sim 10^{11}$ years and assuming that the cosmic string is split in early phase of cosmology, the length of the portion of the decayed string is of the order

$$L \sim kTGa \simeq 2 \times 10^4 k \text{ light years} \ , \tag{7.6.2}$$

which is of the same order of magnitude as the typical size of the visible part of the galaxy.

An estimate for the rate of the energy production by single cosmic string is given by

$$P \sim Tv = kT^2G \sim \frac{4 \times 10^{-14}k}{G} \sim 10^{47}k \times m(\text{proton})/\text{sec} \ . \tag{7.6.3}$$

The energy production in quasars is roughly 10^{14} times larger than the energy production in Sun, which is about $10^{25} W$: this gives $P \sim 10^{49} m_p/sec$. In order to have same order of magnitude one should have

$$k \sim 25 . \quad (7.6.4)$$

The required value of k looks suspiciously large and suggests that the energy flux from the decaying cosmic string could well be a jet directed to a narrow cone, which would increase the observed effective energy flux.

7.6.2 Decaying cosmic string ends as a central engine

It seems that the decaying cosmic string could explain elegantly the basic properties of the central engines. There are two alternative scenarios to be considered.

- I) Galaxies are formed around the ends created in the splitting of a very long cosmic string.
- II) Galaxies are formed by a decay of a piece of cosmic string. The decay of a finite piece of cosmic might explain the existence of some stellar objects accompanied by jet like structures.

In both cases the rate of the string decay gives a correct upper bound for the recent size of the visible part of the galaxies. Consider now the explanation of basic characteristics of active galaxies.

- (a) Visible jets are created by the energy beams

The rate of the energy production in the decay of a cosmic string is few per cent about the estimated energy production in quasars assuming spherical symmetry. A correct rate for the observed energy flux from quasars is obtained if the energy from the decay of the string is liberated in a jet. Since two string ends are involved, the visible two-jet structure is an automatic consequence. The jets emerging from the active galactic nuclei are created by the interaction of the primary jets with the ordinary matter.

- (b) Quasars.

Quasars differ from the ordinary galaxies only in that the energy jet from the cosmic string decay meets Earth. This explains the non-thermal nature of the spectrum and the absence of the atomic lines for the most intensive quasars (they are masked by the primary radiation). The rapid variations (a time scale of an hour) in the luminosity can be understood as resulting from the motion of the cosmic string inducing changes in the direction of the jet. Also the similarity between active and inactive galaxies is an automatic consequence.

- (c) Active-inactive distinction.

For the option I possible explanation is that the galactic black hole has absorbed all matter around the galaxy and the jets coming from the decay of the cosmic strings have nothing with which to interact. It could however happen that the two jets interact with matter in very distant regions creating two tightly correlated jets but apparently originating from very distant sources. It could also occur that string ends are inside a galactic black hole for inactive galaxies so that the decay products remain inside the black hole and no visible jets are created. For the option II inactive galaxies without any jets, one can also consider the possibility that the piece of cosmic string has already decayed completely.

- (d) Dark matter halo.

There are two alternative explanations for the velocity spectrum of the distant stars around the galaxy. The first, purely TGD based, explanation is that distant stars are gravitationally bound to the rotating cosmic string. Cosmic string indeed rotates with a correct velocity and, being Kähler charged, creates a genuine gravitational field unlike neutral cosmic string. The standard explanation is based on the assumption that galaxy is surrounded by a dark matter halo.

An interesting possibility is that a halo of dark matter could result from the decay of the cosmic strings, perhaps in the form of ordinary and exotic neutrino like matter predicted by TGD. The decay could produce also part of the visible matter around the galactic nucleus. The jet model suggests that most of the decay products of the cosmic string escape the visible region of the galaxy but massive and Kähler charged particles with a proper sign of charge could remain bound to the cosmic string. Dark variants of ordinary elementary particles, in particular dark neutrinos, suffer classical Z^0 force below appropriate p-adic length scale. Clearly, Kähler force favors the generation of matter antimatter asymmetry. The average density in the halo would however be perhaps too small to explain the velocity spectrum.

- (e) Production mechanism for ultrahigh energy cosmic rays.

The decay of the cosmic string should also give rise to ultrahigh energy cosmic rays. This production mechanism would provide an alternative for the production mechanisms based on the acceleration of the charged particles [it is difficult to conceive how any acceleration mechanism could lead to the generation of ultra high energy cosmic rays].

7.6.3 How to understand the micro-jet structure?

The long jets with length of roughly 10^6 light years have microstructure consisting of micro-jets with length of order one light year. This feature could be regarded as a shortcoming of the model. A possible TGD based explanation is based on lense effect on the gravitational field of the split cosmic string (scenario I).

In option I, a lense effect, caused by the strong gravitational field of the cosmic string itself, and creating multiple images could be involved. Since charged cosmic string is in question, the situation is more complicated than for the ordinary cosmic string. For instance, photon could rotate several times around the cosmic string before leaving the galactic region. The disappearance of the effect in distant regions (of length of order light year) could be understood if the energy jet were on the wrong side of the string at large distances or the distance between the jet and cosmic string would become so large that photons would not anymore circulate around the string.

7.6.4 Gamma-ray bursts and cosmic strings

Gamma ray bursters [E167] are now quite generally believed to have a cosmological origin. The energy flux from the gamma ray bursters (assuming spherical symmetry and cosmological origin and distance of order 10^8 ly) is about 10^{16} times the energy flux from Sun and by a factor of 10^2 larger than the total energy flux from the decaying cosmic string. The order of magnitude is same as for the energy flux of quasars. Typically the energy is produced in pulses lasting for a few seconds but also long lasting bursts consisting of a train of smaller pulses with a duration of order second are detected. It seems that the system emitting pulses is in some sense near criticality. The distribution of the gamma ray bursters is isotropic.

An interesting possibility is that decaying cosmic strings might explain also this phenomenon. The string would produce a continuous stream of energy, which fails slightly to meet Earth. Small perturbations causing the string end to oscillate (random oscillation of the direction of a flicker is a good analogy) imply that the beam of energy can meet the Earth at each period of oscillation and cause a sequence of pulses. A unique maximum intensity is predicted.

The shape of the pulse is predicted to reflect only the time development of the direction of the cosmic string rather than the actual intensity distribution of the pulse and this should make it possible to distinguish between TGD based and other explanations for the bursts. For instance, the typical bi-modality of the pulse could reflect directly to a perturbation taking string direction from the equilibrium position and bringing it back. The asymmetry of this perturbation caused by dissipative effects should explain the asymmetry of the two intensity peaks. The observed hardness-brightness correlation could be understood as following from the cosmic red shift and cosmic time dilatation increasing the observed duration of the pulse.

From the estimate that there are

$$\frac{dN}{dt} \sim 10^{-6} \text{ year}^{-1} \text{ galaxy}^{-1}$$

bursts per galaxy per year and taking the average duration t_P of the pulse to be

$$t_P \sim 1 \text{ sec} ,$$

one obtains a *very* rough estimate for the probability that a given galaxy acts as a gamma ray burster at a given moment as

$$P \sim t_P \times \frac{dN}{dt} \sim 10^{-13} .$$

One can estimate the solid angle Ω of the cone to which the energy of the decaying cosmic string is emitted: the probability P for galaxy being a burster, is simply the product of the probability $p(A)$ that galaxy is active multiplied with the probability $\Omega/(4\pi)$ that Earth happens to be in the solid angle Omega

$$P = \frac{p(A)\Omega}{4\pi} \sim 10^{-13} ,$$

which gives

$$\Omega \sim \frac{4\pi P}{p(A)} \sim \frac{10^{-12}}{p(A)} .$$

To proceed further an estimate for the probability of being active galaxy is needed. The value of Ω had better to be rather small since the oscillations in the direction of the cosmic string leading to fluctuations in the intensity of beam must be of the order of Ω and too large fluctuations are not expected (cosmic string is quite a heavy object!).

7.7 The light particles associated with dark matter and the correlation between gamma ray bursts and supernovae

Both the model for dark matter identified as cosmic strings or their decay products and the model for gamma ray bursts identified as beams resulting in the fire cracker like decay of cosmic strings were constructed more than decade ago. During year 2003 came several astonishing observations, which at first seemed to be in a dramatic conflict with both the model of the dark matter and the model of gamma ray bursts.

It however turned out that these findings allow to relate, modify, and generalize as many as five models sketched at that time as the first applications of TGD. The subjects modeled were following:

- i) The final state of a rotating star predicting flux tube like magnetic field along the symmetry axis [K85] ,
- ii) Dark matter identified as cosmic strings or their decay products,
- iii) Sunspots identified as the throats of magnetic flux tubes feeding magnetic flux to larger space-time sheet and behaving effectively as magnetic monopoles [K72]),
- iv) Gamma ray bursts explained as cosmic firecrackers resulting from the decay of split cosmic strings to elementary particles,
- v) The anomalous e^+e^- pairs produced in the collisions of heavy nuclei at energy near the Coulomb wall as decay products of lepto-pions consisting of color excited leptons [K84] .

7.7.1 Correlations between gamma ray bursts and supernovae

The established correlation between gamma ray bursts and supernovae is certainly the cosmological discovery of the year 2003 [E177, E116] .

- (a) The first indications for supernova gamma ray burst connection came 1998 when a supernova was seen few days after the gamma ray burst in the same region of sky. In this case the intensity of the burst was however by four orders of magnitude weaker than for the typical gamma ray bursts so that the idea about the correlation was not taken seriously. On 29 March, observers recorded a burst christened as GRB030329. On 6 April, theorists at the Technion Institute of Technology in Israel and CERN in Geneva predicted that there would be signs of a supernova in the visible light and infrared spectra on 8 April [E177] . On cue, two days later, observers picked up the telltale spectrum of a type Ic supernova in the same region of sky, triggered as the collapsing star lost hydrogen from its surface. It has now become clear that a large class of gamma ray bursts correlate with supernovae of type Ib and Ic [E164] , and that they could thus be powered by the mere core collapse leading to supernova. Recall that supernovae of type II involve hydrogen lines unlike those of type I. Supernovae of type Ib shows Helium lines, and Ic shows neither hydrogen nor helium but intermediate mass elements instead. Supernovae of type Ib and Ic are thought to result as core collapse of massive stars.
- (b) One of the most enigmatic findings were the "mystery spots" accompanying supernova SN1987A at a distance of few light weeks at the symmetry axis at opposite sides of the supernova [E133] Their luminosity was nearly 5 per cent of the maximal one. SN1987A was also accompanied by an expanding axi-symmetric remnant surrounded by three concentric rings.
- (c) The latest finding [E89] is that the radiation associated with the gamma ray bursts is maximally polarized. The polarization degree is the incredible 80 ± 20 per cent, which tells that it must be generated in an extremely strong magnetic field rather than in a simple explosion. The magnetic field must have a strong component parallel to the eye sight direction.

Do topologically condensed cosmic strings become co-moving magnetic flux tubes serving as seeds for the formation of stars and galaxies

According to the model for the formation of stars and galaxies proposed already fifteen years ago, topologically condensed pieces of cosmic strings perhaps resulting in the collision of long possibly knotted cosmic strings would serve as seeds making possible formation of lumps of matter forming later stars. The assumption that the pieces of cosmic strings result in the collision of cosmic strings leading to the splitting of them to pieces with some fractal length distribution perhaps concentrated around p-adic length scales would explain why the mass $M(R)$ of galactic dark matter inside a sphere of radius R is proportional to the radius: $M(R) \propto R$.

1. Topologically condensed cosmic strings as co-stretching magnetic flux tubes

I considered already 15 years ago a model for topological condensation of cosmic strings assuming that strong radial Kähler electric fields are generated to compensate the large positive magnetic action. Cosmic strings are actually a special case of magnetic flux tube solutions of field equations. This leads to a revised vision for what happens for topologically condensed cosmic strings. This model does not exclude the presence of the radial electric fields due to the charging of the cosmic strings.

Cosmic strings, which are in the ideal situation string like objects of type $X^2 \times Y^2$, X^2 string like object in M_+^4 and Y^2 geodesic sphere of CP_2 or a piece of it, generate an M_+^4 projection which increases in thickness so that the solution becomes increasingly thicker magnetic flux tube. In the topological condensation the open ends of the string disappear and thus no decay to elementary particles can occur. Thus the topological condensation would stabilize the cosmic strings against decay.

- (a) The simplest assumption is that the topologically condensed piece of a magnetic flux tube of finite length co-stretches with the expanding universe so that its length increases as $L \propto a$, a light cone proper time.
- (b) The requirement that magnetic flux is conserved and quantized implies $B \propto 1/S$, S the transverse area of the flux tube. The condition that magnetic energy is conserved, implies $S \propto L \propto a$ and $B \propto 1/a$. This of course applies both to the magnetic and Z^0 magnetic flux tubes.

The assumption that topologically condensed pieces of cosmic strings remain co-stretching forever is questionable, and it might be that when the thickness of the flux tube reaches a critical value corresponding to a Compton length of say pion or lepto-pion, expansion stops, and the flux tube freezes to a very long hadronic or lepto-hadronic (color) magnetic flux tube (a Kähler field giving rise to em or Z^0 field gives also rise to a classical color field).

”Wormhole magnetic fields” consist of pairs of magnetic flux tubes represented by space-time sheets with opposite time orientations and thus having opposite energies. These structures have zero energy and I have proposed that they play a key role in the physics of living matter. In particular, they could be generated by intentional action by first generating a p-adic variant of the wormhole magnetic field representing the intention to generate wormhole magnetic field, and then transforming it to its real counterpart in quantum jump. One cannot exclude the possibility that cosmic strings could also be generated as zero energy pairs of cosmic strings with opposite time orientation. This would make possible to intentionally create universe from nothing. This is actually the only possibility if one poses the boundary condition that no quantum numbers flow out of the future light cone at its boundary.

2. Stars and galaxies as gravitational condensates around fragments of cosmic strings

The gravitational condensation of matter around short parallel flux tubes topologically condensed at larger space-time sheets is a natural mechanism for generating structures like galaxies and stars. The pieces of magnetic flux tubes would form expanding ferro-magnet like structure in the self-consistent magnetic field defined by the by the return flux flowing at the space-time sheet at which strings have suffered topological condensation. The contribution of the magnetic flux tubes to the total mass of the star can be small and the ordinary matter can be seen as decay products of cosmic strings as in the earlier model. Similar mechanism with different initial length of topologically condensed cosmic strings and resulting in fragmentation in the collision of say two long cosmic strings could give rise to the birth of galactic nuclei.

According to the TGD based model of primordial critical cosmology, the transition from string dominated to radiation dominated cosmology should have occurred at $a_0 \sim 10^{-10}$ s, and one could argue that the topological condensation of the magnetic flux tubes should have started at this time. With this assumption the recent thickness of the magnetic flux tubes would be $d = (a/a_0)^{1/2} \times 10^4 \sqrt{G} \sim 10^{-16}$ m for $a \sim 10^{11}$ years. This corresponds to a hadronic length scale. Quite generally, this would suggest that at light cone proper time a the fragments of long cosmic strings, which have survived the decay to elementary particles, have typical length $L \sim a$.

From the recent length of about light month associated with super nova SN1987A (identifying the mysterious light spots as ends of the flux tube), one can deduce that the length L_0 of the cosmic strings at a_0 would have been $L_0 \simeq 10^{-14}$ m, roughly the Compton length of pion. The corresponding magnetic field would be about 10^{16} Tesla and extremely strong. Fields of similar magnitude have been proposed to result in the core collapse of supernovae [E67]. It however seems that the flux tubes of the primordial magnetic fields cannot explain the highly polarized synchrotron radiation but that the temporary extremely strong Z^0 magnetic field induced by the core collapse are responsible for the polarization.

Magnetic and Z^0 magnetic flux tubes as templates for the formation of material structures is an idea borrowed from TGD inspired theory of consciousness and of bio-systems as macroscopic quantum systems [K82]. The TGD based quantum model for bio-matter assumes that the magnetic flux tubes of Earth serve as templates for the formation of bio-matter, and also define what I have called magnetic bodies controlling pre-biotic and biotic evolution [K33]. Also the idea that magnetic flux tubes act as wave guides and make precisely targeted communications

possible originates from TGD inspired theory of consciousness [K86] . Thus magnetic flux tube structures could serve as templates for and even guide the evolution of matter in all length and time scales: this is certainly in spirit with the fractality of TGD Universe.

A mechanism producing gamma ray burst and polarized synchrotron radiation

The dynamo model for the final state of a rotating star leads to a model for gamma ray bursts consistent with ultrahigh polarization of the synchrotron radiation. The model is consistent with the standard model for the radiation beams from neutron stars.

1. Generalizing the dynamo model for the final state of rotating star

TGD based dynamo model for the final state of rotating star predicts that the rotation axis star contains extremely strong magnetic or Z^0 magnetic field. The field along the axis can also be helical and B_ϕ would naturally result from the rotation of the matter. While attempting to interpret the dynamo model I proposed that the axial field might somehow relate to a cosmic string. This might be indeed the case.

What I did not realize 15 years ago that many-sheeted space-time allows both magnetic and Z^0 magnetic dynamo fields and their symmetry axes of the fields need not coincide.

- (a) The atomic nuclei of even ordinary condensed matter can carry anomalous weak charges due to the presence of color bonds between nucleons having at their ends exotic quarks with mass of order electron mass and carrying also weak charges [K77, K27] . If some color bonds become charged they have also net weak charges. The Z^0 repulsion due to the weak bosons with Compton length of order atomic radius can explain the low compressibility of condensed matter and give rise to the repulsive term in van der Waals equation. Weak repulsion due to exotic weak bosons is expected to become important in the extremely dense phase of matter inside star.
- (b) There are good justifications for the assumption that Z^0 magnetic axis is parallel to the rotation axes- Z^0 magnetic field having neutron number as its source receives a large varying contribution dictated by the flow dynamics of the star. Hence Z^0 magnetic field is expected to be very strong, at least in the situations in which currents of different dark matter particle species do not cancel each other. In particular, the ejection of dark neutrinos during the formation of supernova is expected to generate a strong Z^0 charge due to the anomalous Z^0 charges of nuclei. This induces both Z^0 electric field and Z^0 magnetic fields. Since rotation and Z^0 magnetic fields are so strongly coupled, the Z^0 magnetic and rotation axes should coincide.
- (c) The fact that the rotation axis of the star is rather stable is consistent with the primordial origin of the Z^0 magnetic field and suggests that Z^0 magnetic field as the primordial cause of the rotation.
- (d) Magnetic axis need not coincide with the rotation axis. The direction of the magnetic field of the star can be reversed (this is happening just now in case of Sun). This suggests that magnetic field does not have primordial origin and reflects the dynamics of the star.
- (e) TGD based variant for charged particle currents frozen to the magnetic field lines (assumed to have infinity conductivity in magnetohydrodynamics) are non-dissipative supra currents flowing along magnetic flux tubes of the magnetic and Z^0 magnetic fields. These currents in turn generate magnetic and/or Z^0 magnetic fields with field lines circulating around the rotation axes and thus make the magnetic field along symmetry axis helical.
- (f) Both in the case of magnetic or Z^0 magnetic field, the charged particles topologically condensed at the super-conducting flux tubes could be also spin polarized and amplify the field further.

In many-sheeted space-time topologically condensed magnetic flux tubes must feed their fluxes to larger space-time sheets so that a many-sheeted variant of the dipole field would result. The return fluxes would flow at larger space-time sheet and correspond to thicker flux tubes with

weaker intensity of the magnetic flux. The regions, where the flux would be transferred between space-time sheets could correspond to join along boundaries bonds or wormhole contacts. In the latter case they would look like magnetic charges. As the in case of the sunspots, a fractal structure containing flux tubes inside flux tubes is expected [K72] .

The mysterious light spots associated with SN1987A [E133] could correspond to join along boundaries bonds or the throats of the magnetic flux tubes of or primordial Z^0 magnetic flux tubes.

3. *Synchrotron radiation in strong Z^0 magnetic field as a mechanism generating strong polarization*

Usually the degree of polarization for the radiation from supernovae is around few per cent [E191] . The polarization associated with gamma ray burst GRB021206 is however incredibly high 80 ± 20 per cent and maximal polarization of the radiation [E89] . This requires extremely strong Z^0 magnetic field. The helical Z^0 magnetic field along the rotation axis can have flux quanta of astrophysical size and is ideal for accelerating dark charges flowing along the rotation axis and for producing dark photon synchrotron radiation leaking out in the direction of the rotating magnetic axis and transforming to ordinary photons by a mechanism analogous to decoherence of laser beams [K27, K25] . Gamma ray bursts could be seen as a particular case of this radiation resulting when an especially strong dark current (say dark electron current) flows along the rotational axis in an exceptionally strong dynamically generated Z^0 magnetic field, and induces a beam of synchrotron radiation along the rotating magnetic axis.

The radiation is linearly polarized with the polarization direction and intensity defined by the vector

$$\bar{n} \times (\bar{n} \times \bar{B}^Z) = \bar{B}^Z - B_z^Z \cos(\theta) \bar{n} ,$$

where \bar{n} is the direction of the observer in the direction of the axial magnetic flux tubes and characterized by the angle θ . The direction of polarization is constant during the observation period if the symmetry axis associated with B^Z coincides with the rotation axis. It is essential that magnetic and Z^0 magnetic fields are not parallel and reside at different space-time sheets. The intensity is proportional to the square of the polarization factor given by

$$(B^Z)^2 \times (1 - \cos^2(\alpha) \cos^2(\theta)) , \quad \cos(\alpha) \equiv \frac{B_z^Z}{B^Z} .$$

If the Z^0 magnetic field has only z-component, the intensity is proportional to $(B^Z)^2 \sin^2(\theta)$ and at minimum.

4. *Radial compression as a mechanism producing strong Z^0 magnetic field*

A sudden compression in radial directions orthogonal to the rotation axis at the core collapse could be seen as a process analogous to the squeezing of the tooth paste tube. A strong non-dissipative supra current along the axis of magnetic field is induced because this is the route of the lowest resistance. This current in turn generates a strong magnetic field component B_ϕ^Z , and the charges accelerated in the axial direction in this field emit synchrotron radiation with a direction of polarization tangential to the magnetic field component B_ϕ^Z . If all nuclei possess anomalous Z^0 charges, the matter flow along rotation axis can generate very strong Z^0 magnetic field so that there are good hopes of explaining the anomalously high value of polarization of the synchrotron radiation.

The three expanding ring like structures associated with SN1987A [E38] could be identified as being due to dark Z^0 currents rotating around the strong axial Z^0 magnetic field. Even the identification as torus like flux quanta of Z^0 magnetic field induced by the very strong Z^0 current along the z-axis is possible. This kind of Z^0 magnetic dark currents rotating around axial Z^0 magnetic field could be even responsible for the rings associated with planets like Saturnus and even with the ring current associated with Earth. This picture conforms with the model for the formation of solar system in which macroscopically quantum coherent dark matter serves as a

template around which ordinary matter is condensed [K72, K25] as also with the explanation of tritium beta decay anomaly assuming that Earth's orbit is surrounded by dark neutrino belt [K77].

It is known that spherical and even axial symmetry is broken in case of SN1987A and this is consistent with the fact that magnetic and Z^0 magnetic axis are not parallel. Let L be the line of sight orthogonal to the plane S of sky, and R the projection of the ring to S . Let z-axis correspond to L and x- and y-axis to the directions of the minor and major axis of R . Denote by E_z and E_y the projections of ejecta to S and xz-plane. From the figure 2 of [E123] one can deduce that the plane of the ring forms an angle of 44 degrees with respect L . The symmetry axes of E_y resp. E_z forms an angle of 45 degrees resp. 15 degrees with respect to x-axis. From this one can conclude the polar and azimuthal angles of the symmetry axis of ejecta are $\theta = 45.4$ degrees and $\phi = 9$ degrees. A good guess is that this axis corresponds to the rotation axis and axis of Z^0 magnetic field tilted by 45.4 degrees with respect to the line of sight parallel to the magnetic axis. Mystery spots are known to be located at this axis too [E123] so that they could indeed correspond to sunspot like throats at which Z^0 magnetic flux is transferred between space-time sheets.

Magnetic flux tubes as wave guides

Magnetic flux tubes are ideal wave guides forcing the confined radiation to propagate in a precisely targeted manner along them. Topological light rays (MEs) accompany magnetic flux tubes involved and have interpretation as space-time correlates for a radiation propagating in the waveguide defined by the magnetic flux tube. They are accompanied by coherent light generated by light like vacuum currents associated with them. Topological light rays would couple to Alfven waves representing transversal oscillations of the magnetic flux tubes propagating also with light velocity.

The wave guide function of magnetic flux tubes suggests a generalization and modification of the model of gamma ray bursts. Gamma ray bursts would be generated by the synchrotron radiation generated in the acceleration of charges when they move along rotation axis with dynamically generated component B_ϕ^Z . Part of the resulting radiation would end up to a rotating magnetic flux tube bundle in the direction of the rotating magnetic axis. The initial channelling at the magnetic flux tubes would force synchrotron radiation to propagate to distant parts of the universe in a precisely targeted manner. This mechanism would explain the observed universal properties for the gamma ray [E167] [E138] difficult to understand in the models involving mergers, say collisions of white dwarf binaries [E164]. As already noticed, the model is consistent with the existing model for the ordinary radiation arriving from supernovae and thought of as involving a beam rotating with the supernova.

Gamma ray bursts as dark photons

In [K72] a model for dark graviton with a large value of Planck constant is developed. This yields also a model for the de-coherence of dark graviton and for what happens in the detection of dark gravitational radiation. The model applies also to dark gauge bosons.

- (a) The basic new element is that dark bosons are associated with topological light rays which are N -sheeted multiple coverings of M^4 . The energy absorbed in the detection of a dark boson would be N -fold whereas the frequency for detections is expected to be $1/N$ times lower so that in average sense dark bosons would behave like normal ones. The events in which dark gravitons with large N are detected would be interpreted as noise. Same could apply to other dark bosons. Dark matter would be only apparently dark.
- (b) The propagation of of dark boson can be regarded as a sequential de-coherence in which pieces with smaller value of Planck constant and thus smaller energy are split off from the original dark boson. Frequency is not altered in this process.

Gamma ray bursts could correspond to dark photons with very large value of N so that strongly targeted and very intense beam of ordinary photons results in the de-coherence process.

Gamma ray bursts as collective transitions of cosmic strings identified as scale up hadrons

According to the TGD based model [K56], hadrons consists of two kinds of matter. Valence quark space-time sheets have fused to single structure by color bonds, the "Pomeron" of the physics before QCD. This structure is in turn connected by bonds (possibly carrying the color of sea quarks) to string like hadronic space-time sheet characterized by Mersenne prime M_{107} and containing super-symplectic bosons giving the dominating contribution to the mass of light baryons.

The black-hole like characteristics of the hadronic space-time sheet, which conform with the experimental findings at RHIC, plus the general vision about the formation of neutron stars and quark stars via the fusion of hadronic space-time sheets encourage a generalization to a model for the microscopic structure of black-holes as highly tangled strings inside black-hole horizon. Black-hole would be kind of scaled up hadron.

The Mersenne primes characterizing the hadronic space-time sheet in the hierarchy extending from cosmic strings to hadrons would belong to the set $\{M_n | \text{vertn} = 2, 3, 5, 7, 13, 17, 19, 31, 61, 89, 107\}$. The quarks contained by cosmic string would be labeled by rather small p-adic primes. Cosmic strings would give rise to primordial black-holes decaying to ordinary matter and magnetic flux tubes with a lower string tension. Gamma ray bursts could result in collective quantum transitions of cosmic strings involving several steps with end products of final state at each step characterized by a smaller Mersenne prime. For gamma ray bursts produced by super-novae the value of Mersenne prime would be probably $k = 107$.

Note that ordinary hadrons need not define the lowest level of the hierarchy since also M_{127} copy of hadron physics appears in the TGD based model of nucleus. If Gaussian Mersennes are allowed then much more levels are possible: in particular, in length scale range especially relevant for living systems.

Gamma ray bursts and quantum phase transitions in the scale of string like object

The model of hadrons behind hadronic mass calculations leads to the vision that super-symplectic bosons are responsible for the most of hadronic mass [K56, K52]. This in turn leads to a microscopic model for neutron stars, quark stars, and black-holes as highly entangled hadronic strings resulting in the fusion of hadronic strings. Also cosmic strings would contain super-symplectic matter and separate from environment by black hole horizon.

All these objects would be macroscopic quantum systems and their quantum transitions could generate dark gamma rays, dark gravitons, and other dark particles decaying to ordinary particles in de-coherence phase transition.

A model for dark graviton emission assignable to the gravitational quantum transition of astrophysical objects characterized by gigantic gravitational Planck constant is discussed in [K85]. Dark gravitons would correspond to pulses of ordinary gravitons resulting in de-coherence rather than continuous flow of gravitons. These pulses might be dismissed as noise in measurement philosophy based on standard quantum mechanics.

7.7.2 Lepto-pions as a signature dark matter?

The identification of cosmic strings as the ultimate source of both visible and dark matter does not exclude the possibility that a considerable portion of topologically condensed cosmic strings have decayed to some light particles. In particular, this could be the situation in the galactic nuclei. On the other hand, if some fraction of cosmic strings evolve to magnetic flux tubes, these flux tubes identifiable as dominant part of the dark matter can carry phases of some exotic particles serving as signatures of the dark matter. Quite recent experimental findings [E78] suggest that these exotic particles could be lepto-hadrons predicted by TGD [K84].

Two anomalies

The idea that lepto-hadrons might have something to do with the dark matter has popped up now and then during the last decade but for some reason I have not taken it seriously. Situation changed towards the end of the year 2003. There exist now detailed maps of the dark matter in the center of galaxy and it has been found that the density of dark matter correlates strongly with the intensity of monochromatic photons with energy equal to the rest mass of electron [E78].

The only explanation for the radiation is that some yet unidentified particle of mass very nearly equal to $2m_e$ decays to an electron positron pair or directly to gamma pair. Electron and positron are almost at rest and this implies a high rate for the annihilation to a pair of gamma rays. A natural identification for the particle in question would be as a lepto-pion. By their low mass lepto-pions, just like ordinary pions, would be produced in high abundance, in lepto-hadronic strong reactions and therefore the intensity of the monochromatic photons resulting in their decays would serve as a measure for the density of the lepto-hadronic matter. Also the presence of lepto-pionic condensates can be considered. Lepto-pions decay directly to both gamma pairs and electron-positron pairs. Indeed, galaxy is for long time known to be a source of positrons and there is no generally accepted mechanism producing them [E78].

The second anomaly was the microwave interstellar medium emission observed by WMAP used to map the anisotropy of cosmic microwave spectrum [E137]. Unfortunately, the anomaly reached my attention for more than 4 years later. Anomalous lines at frequencies $f = 23; 33, 41, 61, 94$ GHz have been observed. In good approximation they correspond to harmonics of single frequency of $f = 10$ GHz. For the cyclotron transitions of electron the required magnetic field would be about 0.36 Tesla. The identification would be in terms of cyclotron transitions of dark electrons or of their Cooper pairs residing at magnetic flux tubes of galactic magnetic fields and characterized by so large value of Planck constant that cyclotron energy is above thermal energy. The emitted cyclotron radiation would decay into bunches of ordinary photons with same frequency but much smaller energy.

Lepto-hadron as explanation of gamma ray anomaly?

In the chapter [K84] I have discussed the TGD based explanation for the anomalous production of electron positron pairs in the collisions of heavy nuclei at energies corresponding to the height of Coulomb wall. The effect was observed for more than fifteen years ago [C21] but after string model revolution has been forgotten by theorists like many other anomalies of particle physics. The hypothesis is that so called lepto-pions are produced in the strong, non-orthogonal, and rapidly varying electric and magnetic fields of the colliding nuclei. Lepto-hadrons are color bound states of colored excitations of leptons predicted by TGD defining an asymptotically non-free QCD. Actually an entire hierarchy of non-asymptotically free QCD:s are allowed in TGD Universe.

These findings force to take seriously either the identification

- a) of the dark matter as lepto-hadrons or
- b) of lepto-pions as a signature of dark matter, which itself would be basically magnetic energy associated with cosmic strings transformed to magnetic flux tubes in topological condensation. Of course, leptopions could correspond to only a small fraction of dark matter and one can quite well imagine that they are created in strong interactions of leptobaryons.

In fact, lepto-pions are not the only possibility. The TGD based model for tetra-neutrons [C20] [K77] is based on the hypothesis that mesons made of scaled down versions of quarks corresponding to Mersenne prime M_{127} (ordinary quarks correspond to $k = 107$) and having masses around one MeV could correspond to the color electric flux tubes binding the neutrons to form a tetra-neutron. The same force would be also relevant for the understanding of alpha particles.

Why lepto-hadrons cannot directly correspond to dark matter?

The identification of lepto-hadrons as dark matter raises several questions leading to the conclusion that lepto-pions are most probably only a signature of dark matter.

- (a) Why the ratio of the lepto-hadronic mass density to the mass density of the ordinary hadrons would be so high, of order 7? Could an entire hierarchy of asymptotically non-free QCDs be responsible for the dark matter so that lepto-hadrons would explain only a small portion of the dark matter? Is even the hierarchy of QCD:s enough?
- (b) Under what conditions one can regard lepto-hadronic matter as a dark matter? Could short life-times of lepto-hadrons make them effectively dark matter in the sense that there would be no stable enough atom like structures consisting of say charged lepto-baryons bound electromagnetically to the ordinary nuclei or electrons? But what would be the mechanism producing lepto-hadrons in this case (nuclear collisions produce lepto-pions only under very special conditions)?
- (c) What would be the role of the many-sheeted space-time: could lepto-hadrons and atomic nuclei reside at different space-time sheets so that lepto-baryons could be long-lived? Could dark matter quite generally correspond to the matter at different space-time sheets and thus serve as a direct signature of the many-sheeted space-time topology? Magnetic flux tubes are excellent candidates for the space-time sheets accommodate the dark matter but there are good reasons to believe that magnetic energy is considerably higher than the energy of particles condensed on magnetic flux tubes so that magnetic energy is the best candidate for dark matter.

These objections suggest that lepto-pions serve only as a signature of dark matter. The recent vision about dark matter suggests that all particles can appear as dark variants and reside at magnetic flux tubes and leptopions could be only particular kind of dark matter. Of course, dark matter itself could correspond also to the magnetic energy of the magnetic flux tubes and cosmic strings.

Lepto-pions topologically condensed on magnetic flux tubes as a signature of dark matter?

Lepto-pions and other lepto-hadrons producing copiously lepto-pions could reside at magnetic of Z^0 magnetic flux tubes of thickness of order Compton length of lepto-pion. These strings could be seen as kind of very long lepto-hadronic strings. Also long hadronic flux tubes carrying coherent states of ordinary pions are possible and Z^0 flux tubes beaming the gamma ray bursts could correspond to them.

One could identify the lepto-hadronic magnetic flux tubes as structures generated later in the cosmic evolution, when the magnetic flux of hadronic flux tubes flow to larger space-time sheets. The transversal length scales of the flux tubes would be in ratio m_e/m_p and the magnetic field would be by a factor of about 10^{-6} weaker, about 10^{10} Tesla whereas the magnetic field of supernovae are around 10^9 Tesla. If the thickness of the magnetic flux tube at the moment of the annihilation of lepto-pion is of the order of Compton length of electron, one obtains an estimate for its thickness at the moment when the transition to the radiation dominated phase occurred.

If the strength of the magnetic field is of order $eB \sim m_e^2 \sim 10^9$ Tesla, the cyclotron frequency would be of same order as electron mass $eB/m_e \sim m_e$ and in gamma ray region. For $eB \sim m_p^2$ the field strength would be 10^{15} Tesla and cyclotron energy would be of order proton mass. Harmonics of this line might serve as a signature for the strength of the magnetic field. The monochromatic gamma lines at electron mass could also result in cyclotron transitions of electrons if the magnetic field at magnetic flux tubes that $eB = m_e^2$ holds true in high precision.

One can imagine two mechanisms of lepto-pion production.

- (a) The magnetic and Z^0 magnetic fields associated with the magnetic flux tubes give rise to classical color fields, which suggest that one could regard the flux tubes as macroscopic

color magnetic and possibly also color electric flux tubes carrying lepto-hadrons, which produce copiously lepto-pions in their reactions.

- (b) In heavy ion collisions lepto-pion production is caused by the presence of the rapidly varying non-orthogonal electric and magnetic fields of colliding nuclei, whose "instanton density" $E \cdot B$ is non-vanishing (this means that the magnetic flux tube has higher than 2-dimensional CP_2 projection). The amplitude for lepto-pion production as a decay of the coherent state is proportional to the Fourier component of the "instanton density". The mechanism could be at work also now if magnetic flux tubes carry strong charges and generate radial electric fields. Lepto-pions would serve as signature for rapid changes of the magnetic and electric fields induced by rapid deformations of the magnetic flux tubes.

Solar X-ray halo and scaled up QCDs at magnetic flux tubes

Quite recently New Scientist told about an explanation proposed by Kostantin Zioukas and his colleagues [E122] for the X-ray halo of Sun in terms of axions, one of the many candidates for the dark matter [E49]. The X-ray halo of Sun was detected at 1940. The halo extends from the surface of Sun (free path for photons increases at the surface). The X-ray intensity decays exponentially and extends several solar radii from the surface. The energy range of X-rays is 3 – 15 keV. The origin of the X-ray halo has remained a mystery.

The axions in the required mass range are predicted by certain higher-dimensional theories [E122]. The axions would be produced in the solar core and because of their extremely long lifetime they would propagate to the surface of Sun and some fraction of non-relativistic axions would remain bound in the solar gravitational field where they would decay. The estimated mean distance of the proposed axion population from the solar surface is about 6.2 solar radii. Zioukas and his colleagues are able to deduce the value of the coupling constant $g_{A\gamma\gamma}$ characterizing the rate of axion decay and the interaction cross section of axion with matter from the fact that the X-ray luminosity must be proportional to $g_{A\gamma\gamma}^4$. The resulting lifetime of the axion is about 10^{21} s to be compared with the lifetime of ordinary pion about 10^{-16} s.

TGD suggests an alternative explanation based on a non-asymptotically free exotic QCD at a magnetic flux tube corresponding to a p-adic length scale $L(k)$ for which the scaled down value of pion mass corresponds to mass of about 3 keV. Assuming that pion corresponds to $k = 107$ ($k = 109$ is the second candidate) this gives $2^{(k-107)/2} \sim m_{\pi(107)}/m_{\pi(k)}$. The lower limit for the energy spectrum would favor the p-adic length scale $L(139)$ giving $m_{\pi(139)} \simeq 2.2$ keV. The lifetime of lepto-pion would be scaled up by a factor 2^{16} so that one would have $\tau \sim 10^{-11}$ s. One cannot exclude the presence of several scaled up QCDs with $k = 139, 137$ and $k = 131$ being the most favored ones in the energy range of about 3 octaves spanned by the X-ray spectrum.

In the recent case the intensity of the X-ray halo from a given spherical volume V of the halo defining the pixel is determined by the density $dn(\pi)/dl$ of the exotic pions per unit length of the magnetic flux tube and the length $l(V)$ of the magnetic flux tube inside the volume, which is expected behave as $l(V) \sim V^{1/3}$. A rough estimate is

$$I(V) \sim \frac{dn(\pi)}{dl} \times l(V) \times \Gamma \times \langle E(\pi) \rangle \Delta\Omega ,$$

where $\Delta\Omega = A/4\pi R^2$ is the solid angle defined spanned by the active detection area A of the measuring instrument at a given point of the magnetic flux tube and R is the distance of Earth from Sun. In principle this allows to estimate the density of exotic pions per unit length of the magnetic flux tube.

The exponential decay of the intensity with distance from the surface of the Sun would suggest that magnetic flux tubes might be regarded as threads extending from the solar surface and returning back to it, and that the probability of a path of given length decreases exponentially with its length. If the probability for the appearance of a thread of given length is proportional to the Boltzman weight $\exp(-E_B/T)$, where E_B is magnetic energy of the thread and T is temperature parameter, this indeed holds true.

The intensity of the magnetic field at the flux tubes can be estimated from the nominal value $B_E = .5 \times 10^{-4}$ Tesla of the Earth's magnetic field at the space-time sheet $k = 169$. By scaling one would obtain $B = 2^{169-139} B_E = 5 \times 10^4$ Tesla. The field is extremely strong and could be perhaps assigned to remnants of primordial cosmic strings. Note that also Z^0 magnetic field could be in question in which case dark matter coupling to scaled down copies of electro-weak bosons would be in question [K35, K27] .

Do the length scale ratios for astrophysical objects reflect Compton length ratios of elementary particles?

The ratio for the size $L_l \sim 10^5$ light years of a galactic nucleus to the distance $L_h \sim 1$ light month between the light spots of super nova gives an estimate for the ratio of the lengths of the lepto-hadronic and hadronic magnetic flux tubes. This would predict $L_l/L_h \sim 10^6$ and that the ratio of transverse thicknesses $d_l/d_h = 10^3$, which is the ratio of lepto-pion Compton length scale to proton Compton length. This would suggest that the length scale hierarchy for astrophysical objects could represent a scaled up version of the p-adic length scale hierarchy associated with elementary particles.

Frequency cutoff for zero point frequencies as a test for many-sheeted space-time?

For a quantum system mode lable in terms of harmonic oscillators (say photon field) the frequency spectrum in the thermal equilibrium obeys Planck distribution. Besides this the system exhibits zero point fluctuations whose energy density is given by $\rho_0(f) = 8\pi^2 f^3$ ($\hbar = c = 1$) in the 3-dimensional case. Zero point fluctuations appear in many models of physical phenomena such as X-ray scattering in solids, Lamb shift, Casimir effect, and the interpretation of the Aharonov Bohm effect (for references see [E73]).

The zero point fluctuations are predicted to appear also in electronic systems, and the experimentally measured spectral density of the current noise measured by Koch [E172] in Josephson junctions provides a direct support for this prediction. The fluctuations have been observed up to the frequency of $f = .6$ THz which corresponds to a microwave wavelength of .5 mm.

It has been proposed by Beck and Mackey [E73] that if these fluctuations are associated with the vacuum energy, the total vacuum energy density associated with these fluctuations cannot exceed the recently measured dark energy density of the Universe: this leads to a cutoff frequency of $f_c = (1.69 \pm .05)$ THz for the measured frequency spectrum.

In TGD framework dark matter is ordinary matter at larger space-time sheets. First of all, the finite size of the space-time sheet poses an IR cutoff. p-Adic length scale hierarchy suggests that that there is also UV cutoff that corresponds to the next p-adic length scale in the hierarchy. Hence the frequencies above the UV cutoff would correspond to oscillations at smaller space-time sheets. The interpretation would be in terms of de-coherence.

Thus a given space-time sheet would contain half octave of frequencies between the frequency cutoffs $f_{low}(k) = c/L(k) \propto 2^{-k/2}$ and $f_{up}(k) = c/L(k+1)$. Cutoff frequencies would come as half octaves for k integer as predicted by the most general form of the p-adic length scale hypothesis. The stronger form of the hypothesis favors prime values of k . Note that for $k = 179$ (prime) the predicted cutoff frequency would be $f_c(179) \simeq 1.74$ THz, which happens consistent with the prediction of [E73] deduced from the estimate for the dark matter density. This need not be an accident. According to the TGD based model explaining the finding that neutrino mass depends on the environment, neutrinos can condense on several space-time sheets and neutrinos in dense matter travel along $k = 179$ space-time sheet [K48] .

The problem is that the spectral density would be same at every space-time sheet. One might however hope that the shift of the spectrum from a space-time sheet to another one manifests itself as some kind of structure at half-integer octaves of a basic frequency. By using a suitable arrangement one might be even able to eliminate some space-time sheet so that a gap would result. An interesting question is how the measurement instrument could be constructed to detect only the frequencies associated with a space-time sheet corresponding to a fixed value of k .

Chapter 8

TGD and Cosmology

8.1 Introduction

TGD inspired cosmology in its recent form relies on an ontology differing dramatically from that of GRT based cosmologies. Zero energy ontology states that all physical states have vanishing net quantum numbers so that all matter is creatable from vacuum. The hierarchy of dark matter identified as macroscopic quantum phases labeled by arbitrarily large values of Planck constant is second aspect of the new ontology. The values of the gravitational Planck constant assignable to space-time sheets mediating gravitational interaction are gigantic. This implies that TGD inspired late cosmology might decompose into stationary phases corresponding to stationary quantum states in cosmological scales and critical cosmologies corresponding to quantum transitions changing the value of the gravitational Planck constant and inducing an accelerated cosmic expansion.

8.1.1 Zero energy cosmology

Robertson-Walker cosmologies correspond to vacua with respect to inertial energy and in fact with respect to all quantum numbers. They are not vacua with respect to gravitational charges defined as Noether charges associated with the curvature scalar. Also more general imbeddings of Einstein's equations are typically vacuum extremals with respect to Noether charges assignable to Kähler action since otherwise one ends up with conflict between imbeddability and dynamics. This suggests that physical states have vanishing net quantum numbers quite generally. The construction of quantum theory [K36, K23] indeed leads naturally to zero energy ontology stating that everything is creatable from vacuum.

At the level of elementary particle physics positive and negative energy parts of zero energy state are interpreted as initial and final states of a particle reaction so that quantum states become physical events. Equivalence Principle would hold true in the sense that the classical gravitational four-momentum of the vacuum extremal whose small deformations appear as the argument of configuration space spinor field is equal to the positive energy of the positive energy part of the zero energy quantum state.

The vacuum extremals are absolutely essential for the TGD based view about long length scale limit about gravitation. Already the Kähler action defined by CP_2 Kähler form J allows enormous vacuum degeneracy: any four-surface having Lagrangian submanifold of CP_2 as its CP_2 projection is a vacuum extremal. The dimension of these sub-manifolds is at most two. Robertson-Walker cosmologies correspond to vacua with respect to inertial energy and in fact with respect to all quantum numbers. They are not vacua with respect to gravitational charges defined as Noether charges associated with the curvature scalar. Also more general imbeddings of Einstein's equations are typically vacuum extremals with respect to Noether charges assignable to Kähler action since otherwise one ends up with conflict between imbeddability and dynamics. This suggests that physical states have vanishing net quantum numbers quite

generally. The construction of quantum theory [K36, K23] indeed leads naturally to zero energy ontology stating that everything is creatable from vacuum.

The reduction of quantum TGD to almost topological quantum theory [K11] however forces the replacement $J \rightarrow J + J_1$, where J_1 is the Kähler form assignable to the two sphere of CD and defining a monopole field with magnetic monopole at the time-like line connecting the tips of CD . This implies small breaking of Lorentz invariance at the level of particular CD but at the level of the "world of classical worlds" (WCW) there is no breaking of Lorentz or Poincare invariance. The known non-vacuum extremals are not affected but the vacuum extremals changes profoundly.

- (a) The canonically imbedded M^4 would become a monopole configuration with an infinite magnetic energy and Kähler action due to the monopole singularity at the line connecting tips of the CD . Action and energy can be made small by drilling a small hole around origin. This is however not consistent with the weak form of electro-weak duality. Amusingly, the modified Dirac equation reduces to ordinary massless Dirac equation in M^4 .
- (b) This extremal can be transformed to a vacuum extremal by assuming that the solution is also a CP_2 magnetic monopole with opposite contribution to the magnetic charge so that $J + J_1 = 0$ holds true. This is achieved if one can regard space-time surface as a map $M^4 \rightarrow CP_2$ reducing to a map $(\Theta, \Phi) = (\theta, \pm\phi)$ with the sign chosen properly projecting the homologically non-trivial $r_M = \text{constant}$ spheres of CD to the homologically non-trivial geodesic sphere of CP_2 . Symplectic transformations of $S^2 \times CP_2$ produce new vacuum extremals of this kind.
- (c) Using Darboux coordinates in which one has $J = \sum_{k=1,2} P_k dQ^k$ and assuming that (P_1, Q_1) corresponds to the CP_2 image of S^2 , one can take either P_2 or Q^2 to be an arbitrary function of (t, r_M) to obtain even more general vacuum extremals with 3-D CP_2 projection. Also P_1 or Q_1 can be assumed to be an arbitrary function of (t, r_M) . Therefore the spectrum of vacuum extremals, which is very relevant for the TGD based description of gravitation in long length scales because it allows to satisfy Einstein's equations as an additional condition, is much richer than for the original option. Robertson-Walker cosmologies must be slightly deformed meaning a slight breaking of the cosmological principle. For the simplest option the dependence of CP_2 coordinates on lightcone proper time a is $P_2 = f(a)$ or $Q^2 = f(a)$, f an arbitrary function. The induced metric of X^4 deviates extremely little from Robertson-Walker form for the simplest solutions. From the point of classical gravitation this option is obviously more promising than the original one. In this chapter the implications of the extended vacuum sector are not discussed.

Zero energy states decompose into positive and negative energy parts having identification as initial and final states of particle reaction in time scales of perception longer than the geometro-temporal separation T of positive and negative energy parts of the state. If the time scale of perception is smaller than T , the usual positive energy ontology applies.

In zero energy ontology inertial four-momentum is a quantity depending on the temporal time scale T used and in time scales longer than T the contribution of zero energy states with parameter $T_1 < T$ to four-momentum vanishes. This scale dependence alone implies that it does not make sense to speak about conservation of inertial four-momentum in cosmological scales. Hence it would be in principle possible to identify inertial and gravitational four-momenta and achieve strong form of Equivalence Principle. It however seems that this is not the correct approach to follow.

Negative energy virtual gravitons represented by topological quanta having negative time orientation and hence also negative energy. The absorption of negative energy gravitons by photons could explain the gradual red-shifting of the microwave background radiation. Negative energy virtual gravitons give also rise to a negative gravitational potential energy. Quite generally, negative energy virtual bosons build up the negative interaction potential energy. An important constraint to TGD inspired cosmology is the requirement that Hagedorn temperature $T_H \sim 1/R$, where R is CP_2 size, is the limiting temperature of radiation dominated phase.

8.1.2 Dark matter hierarchy and hierarchy of Planck constants

The idea about hierarchy of Planck constants relying on generalization of the imbedding space was inspired both by empirical input (Bohr quantization of planetary orbits) and by the mathematics of hyper-finite factors of type II₁ combined with the quantum classical correspondence.

Quantum classical correspondence suggests that Jones inclusions [A2] have space-time correlates [K90, K30]. There is a canonical hierarchy of Jones inclusions labeled by finite subgroups of $SU(2)$ [A55]. This leads to a generalization of the imbedding space obtained by gluing an infinite number of copies of H regarded as singular bundles over $H/G_a \times G_b$, where $G_a \times G_b$ is a subgroup of $SU(2) \times SU(2) \subset SL(2, C) \times SU(3)$. Gluing occurs along a factor for which the group is same. The generalized imbedding space has clearly a book like structure with pages of books intersecting along 4-D sub-manifold $M^2 \times S^2$, S^2 a geodesic sphere of CP_2 characterizing the choice of quantization axes. Entire configuration space is union over "books" corresponding to various choices of this sub-manifold.

The groups in question define in a natural manner the direction of quantization axes for various isometry charges and this hierarchy seems to be an essential element of quantum measurement theory. Ordinary Planck constant, as opposed to Planck constants $\hbar_a = n_a \hbar_0$ and $\hbar_b = n_b \hbar_0$ appearing in the commutation relations of symmetry algebras assignable to M^4 and CP_2 , is naturally quantized as $\hbar = (n_a/n_b) \hbar_0$, where n_i is the order of maximal cyclic subgroup of G_i . The hierarchy of Planck constants is interpreted in terms of dark matter hierarchy [K30]. What is also important is that $(n_a/n_b)^2$ appear as a scaling factor of M^4 metric so that Kähler action via its dependence on induced metric codes for radiative corrections coming in powers of ordinary Planck constant: therefore quantum criticality and vanishing of radiative corrections to functional integral over WCW does not mean vanishing of radiative corrections.

G_a would correspond directly to the observed symmetries of visible matter induced by the underlying dark matter [K30]. For instance, in living matter molecules with 5- and 6-cycles could directly reflect the fact that free electron pairs associated with these cycles correspond to $n_a = 5$ and $n_a = 6$ dark matter possibly responsible for anomalous conductivity of DNA [K30, K15] and recently reported strange properties of graphene [D11]. Also the tetrahedral and icosahedral symmetries of water molecule clusters could have similar interpretation [K27], [D10].

A further fascinating possibility is that the observed indications for Bohr orbit quantization of planetary orbits [E175] could have interpretation in terms of gigantic Planck constant for underlying dark matter [K72] so that macroscopic and -temporal quantum coherence would be possible in astrophysical length scales manifesting itself in many manners: say as preferred directions of quantization axis (perhaps related to the CMB anomaly) or as anomalously low dissipation rates.

Since the gravitational Planck constant is proportional to the product of the gravitational masses of interacting systems, it must be assigned to the field body of the two systems and characterizes the interaction between systems rather than systems themselves. This observation applies quite generally and each field body of the system (em, weak, color, gravitational) is characterized by its own Planck constant.

In the gravitational case the order of G_a is gigantic and at least $GM_1 m/v_0$, $v_0 = 2^{-11}$ the favored value. The natural interpretation is as a discrete rotational symmetry of the gravitational field body of the system having both gravimagnetic and gravi-electric parts. The subgroups of G_a for which order is a divisor of the order of G_a define broken symmetries at the lower levels of dark matter hierarchy, in particular symmetries of visible matter.

The number theoretically simple ruler-and-compass integers having as factors only first powers of Fermat primes and power of 2 would define a physically preferred sub-hierarchy of quantum criticality for which subsequent levels would correspond to powers of 2: a connection with p-adic length scale hypothesis suggests itself. Ruler and compass hypothesis implies that besides p-adic length scales also their 3- and 5- multiples should be important.

A crucially important implication of dark matter hierarchy is macroscopic quantum coherence in astrophysical scales. This means that astrophysical systems tend to retain their M^4 size during cosmic expansion and change their size only during quantum jumps increasing the value of Planck

constant. Cosmological quantum states can be modeled in terms of stationary Robertson-Walker cosmologies, which are extremals of curvature scalar. These cosmologies are determined apart from single parameter and string dominated having infinite horizon size.

Quantum phase transitions between stationary cosmologies are modelable in terms of quantum critical cosmologies which are also determined apart from single parameter. They correspond to accelerated cosmic expansion having interpretation in terms of increase of quantum scale due to the increases of gravitational Planck constant.

8.1.3 Quantum criticality and quantum phase transitions

TGD Universe is quantum counterpart of a statistical system at a critical temperature. As a consequence, topological condensate is expected to possess hierarchical, fractal like structure containing topologically condensed 3-surfaces with all possible sizes. Both Kähler magnetized and Kähler electric 3-surfaces ought to be important and string like objects indeed provide a good example of Kähler magnetic structures important in TGD inspired cosmology. In particular space-time is expected to be many-sheeted even at cosmological scales and ordinary cosmology must be replaced with many-sheeted cosmology. The possible presence of vapor phase consisting of free cosmic strings and possibly also elementary particles is second crucial aspects of TGD inspired cosmology.

Quantum criticality of TGD Universe supports the view that many-sheeted cosmology is in some sense critical, at least during quantum phase transitions. Criticality in turn suggests fractality. Phase transitions, in particular the topological phase transitions giving rise to new space-time sheets, are (quantum) critical phenomena involving no scales. If the curvature of the 3-space does not vanish, it defines scale: hence the flatness of the cosmic time=constant section of the cosmology implied by the criticality is consistent with the scale invariance of the critical phenomena. This motivates the assumption that the new space-time sheets created in topological phase transitions are in good approximation modelable as critical Robertson-Walker cosmologies for some period of time at least. It turns out that the critical cosmologies are naturally assignable to phase transitions and quantum criticality.

8.1.4 Critical and over-critical cosmologies are highly unique

Any one-dimensional sub-manifold of CP_2 allows global imbeddings of subcritical cosmologies whereas for a given 2-dimensional Lagrange manifold of CP_2 critical and overcritical cosmologies allow only one-parameter family of partial imbeddings.

The infinite size of the horizon for the imbeddable critical cosmologies is in accordance with the presence of arbitrarily long range fluctuations at criticality and guarantees the average isotropy of the cosmology. Imbedding is possible for some critical duration of time. The parameter labeling these cosmologies is a scale factor characterizing the duration of the critical period. These cosmologies have the same optical properties as inflationary cosmologies but exponential expansion is replaced with logarithmic one.

Cosmic expansion is accelerated for critical cosmologies. This gives good hopes of avoiding the introduction of cosmological constant and exotic forms of matter such as quintessence. Critical cosmologies might be completely universal and assignable to any quantum phase transitions in proper length scale. Dark matter hierarchy realized in terms of gigantic values of gravitational Planck constant predicts that even astrophysical systems are macroscopic quantum systems at the level of dark matter. This means that their M^4 size remains constant during cosmic expansion and can change only in quantum jump increasing the value of Planck constant. Critical cosmologies would be assigned to this kind of phase transitions occurring for large voids [K24].

Critical cosmology can be regarded as a 'Silent Whisper amplified to Bang' rather than 'Big Bang' and transformed to hyperbolic cosmology before its imbedding fails. Split strings decay to elementary particles in this transition and give rise to seeds of galaxies. In some later stage the hyperbolic cosmology can decompose to disjoint 3-surfaces. Thus each sub-cosmology is analogous to biological growth process leading eventually to biological death.

Critical and stationary cosmologies for which gravitational charges are conserved can be used as a building blocks of a fractal cosmology containing cosmologies containing ... cosmologies. p-Adic length scale hypothesis allows a quantitative formulation of the fractality [K72] . Fractal cosmology predicts cosmos to have essentially same optical properties as inflationary scenario but avoids the prediction of unknown vacuum energy density. Fractal cosmology explains the paradoxical result that the observed density of the matter is much lower than the critical density associated with the largest space-time sheet of the fractal cosmology. Also the observation that some astrophysical objects seem to be older than the Universe, finds a nice explanation.

The key difference between inflationary and quantum critical cosmologies relates to the interpretation of the fluctuations of the microwave background. In the inflationary option fluctuations are amplified to long length scale fluctuations during inflationary expansion. In quantum critical cosmology the fluctuations be assigned to the quantum critical period accompanying macroscopic quantum fluctuations of the dark matter appearing in very long length scales during the phase transition so that no inflationary expansion is needed. Sub-critical cosmology is predicted after the inflationary period.

8.1.5 Equivalence Principle in TGD framework

The motivation for TGD as a Poincare invariant theory of gravitation was that the notion of four-momentum is poorly defined in curved space-time since corresponding Noether currents do not exist. A lot of cognitive noise was caused by my attempt to deduce the formulation of Equivalence Principle in the framework provided by General Relativity framework applying only in the long length scale limit rather than in string model context. There were several steps in the process of becoming aware of this.

- (a) First came the conviction that coset representation for super-symplectic and super Kac-Moody algebras provides extremely general formulation of Equivalence Principle in which inertial and gravitational four-momenta are replaced with Super Virasoro generators of two algebras whose differences annihilate physical states. This idea came for years before becoming aware of its importance and I simply forgot it.
- (b) Next came the realization of the fundamental role of number theoretical compactification providing a number theoretical interpretation of $M^4 \times CP_2$ and thus also of standard model quantum numbers. This led to the identification of the preferred extremals of Kähler action and to the formulation of quantum TGD in terms of second quantized induced spinors fields. One of conclusion was that dimensional reduction for preferred extremals of Kähler action- if they have the properties required by theoretic compactification- leads to string model with string tension which is however not proportional to the inverse of Newton's constant but to L_p^2 , p-adic length scale squared and thus gigantic. The connection between gravitational constant and L_p^2 comes from an old argument that I discovered about two decades ago and which allowed to predict the value of Kähler coupling strength by using as input electron mass and p-adic mass calculations. In this framework the role of Planck length as a fundamental length scale is taken by CP_2 size so that Planck length scale loses its magic role as a length scale in which usual views about space-time geometry cease to hold true.
- (c) The next step was the realization that zero energy ontology allows to avoid the paradox implied in positive energy ontology by the fact that gravitational energy is not conserved but inertial energy identified as Noether charge is. Energy conservation is always in some length scale in zero energy ontology.
- (d) As a matter fact, there was still one step. I had to become fully aware that the identification of gravitational four-momentum in terms of Einstein tensor makes sense only in long length scales. This is of course trivial but for some reason I did not realize that this fact resolves the paradoxes associated with objects like cosmic strings.

To summarize, the understanding of Equivalence Principle in TGD context required quite many discoveries of mostly mathematical character: the understanding of the super-conformal symmetries of quantum TGD, the discovery of zero energy ontology, the identification of preferred

extremals of Kähler action by requiring number theoretical compactification, and the discovery that dimensional reduction allows to formulate quantum in terms of slicing of space-time surface by stringy world sheets. As far as cosmic strings are considered, the new vision throws to paper basket the idea about negative gravitational mass of the cosmic string inducing antigravity like effects.

8.1.6 Cosmic strings as basic building blocks of TGD inspired cosmology

Cosmic strings are the basic building blocks of TGD inspired cosmology and all structures including large voids, galaxies, stars, and even planets can be seen as pearls in a cosmic fractal necklaces consisting of cosmic strings containing smaller cosmic strings linked around them containing... During cosmological evolution the cosmic strings are transformed to magnetic flux tubes with smaller Kähler string tension and these structures are also key players in TGD inspired quantum biology.

Cosmic strings are of form $X^2 \times Y^2 \subset M^4 \times CP_2$, where X^2 corresponds to string orbit and Y^2 is a complex sub-manifold of CP_2 . The gravitational mass of cosmic string is $M_{gr} = (1-g)/4G$, where g is the genus of Y^2 . For $g = 1$ the mass vanishes. When Y^2 corresponds to homologically trivial geodesic sphere of CP_2 the presence of Kähler magnetic field is however expected to generate inertial mass which also gives rise to gravitational mass visible as asymptotic behavior of the metric of space-time sheet at which the cosmic string has suffered topological condensation. The corresponding string tension is in the same range that for GUT strings and explains the constant velocity spectrum of distant stars around galaxies.

For $g > 1$ the gravitational mass is negative. This inspires a model for large voids as space-time regions containing $g > 1$ cosmic string with negative gravitational energy and repelling the galactic $g = 0$ cosmic strings to the boundaries of the large void.

These voids would participate cosmic expansion only in average sense. During stationary periods the quantum states would be modelable using stationary cosmologies and during phase transitions increasing gravitational Planck constant and thus size of the large void they critical cosmologies would be the appropriate description. The acceleration of cosmic expansion predicted by critical cosmologies can be naturally assigned with these periods. Classically the quantum phase transition would be induced when galactic strings are driven to the boundary of the large void by the antigravity of big cosmic strings with negative gravitational energy. The large values of Planck constant are crucial for understanding of living matter so that gravitation would play fundamental role also in the evolution of life and intelligence.

8.1.7 Topics of the chapter

In the following this scenario is described in detail.

- (a) Basic ingredients of TGD inspired cosmology are introduced. The consequences of the imbeddability requirement are analyzed. The basic properties of cosmic strings are summarized and simple model for vapor phase as consisting of critical density of cosmic strings are introduced. Additional topics are thermodynamical aspects of cosmology, in particular the new view about second law and the consequences of Hagedorn temperature. Non-conservation of gravitational momentum is considered.
- (b) The evolution of the fractal cosmology is described in more detail.
- (c) TGD inspired cosmology is compared to inflationary scenario: in particular, the TGD based explanation for the recently observed flatness of 3-space and a possible solution to the Hubble constant controversy are discussed.
- e) Certain problems of the cosmology such as the questions why some stars seem to be older than the Universe, the claimed time dependence of the fine structure constant, the generation of matter antimatter asymmetry, and the problem of the fermion families, are discussed.

- (d) Simulating Big Bang in laboratory is the title of the last section. The motivation comes from the observation that critical cosmology could serve as a universal model for phase transitions.

8.2 Basic ingredients of TGD inspired cosmology

In this section the general principles and ingredients of the TGD inspired cosmology are discussed briefly.

8.2.1 Many-sheeted space-time defines a hierarchy of smoothed out space-times

The notion of quantum average space-time obtained by smoothing out details below the scale of resolution was inspired by renormalization philosophy and for long time I regarded it as a fictive concept. The rough idea was that quantum average effective space-times correspond to the absolute minima of the Kähler action associated with the maxima of the Kähler function. Therefore the dynamics of the quantum average effective space-time is fixed and the stationarity requirement for the effective action should only select some physically preferred maxima of the Kähler function. The topologically trivial space time of classical GRT cannot directly correspond to the topologically highly nontrivial TGD space-time but should be obtained only as an idealized, length scale dependent and essentially macroscopic concept. This allows the possibility that also the dynamics of the effective smoothed out space-times is determined by the effective action.

The space-time in length scale L is obtained by smoothing out all topological details (particles) and by describing their presence using various densities such as energy momentum tensor $T_{\#}^{\alpha\beta}$ and Yang Mills current densities $J_{a\#}^{\alpha}$ serving as sources of classical electro-weak and color gauge fields (see Fig. 8.2.1). It is important to notice that the smoothing out procedure eliminates elementary particle type boundary components in all length scales: this suggests that the size of a typical elementary particle boundary component sets lower limit for the scale, where the smoothing out procedure applies.

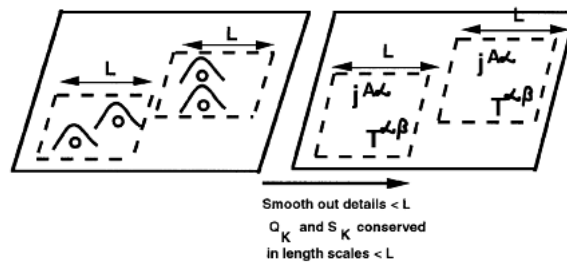

Figure 8.1: Intuitive definition of length scale dependent space-time

During development of the many-sheeted space-time concept it has become obvious that the notions of classical space-time and of smoothing out of details are not only activities of a theoretician, but that the many-sheeted space-time itself can be said to perform renormalization theory.

- (a) In TGD framework classical space-time is much more than a fiction produced by the stationary phase approximation. The localization in the so called zero modes, which corresponds to state function reduction in TGD, which occurs in each quantum jump (the delicacies due

to macro-temporal quantum coherence will not be discussed here) means that the superposition of space-time surfaces in the final state of quantum jump, consists of space-time surfaces equivalent from the point of view of observer.

- (b) The notion of many-sheeted space-time predicts a hierarchy of space-time sheets labeled by p-adic primes $p \simeq 2^k$, k integer with primes and prime powers being in preferred role. The space-time sheets at a given level of hierarchy play a role of particles topologically condensed at larger space-time sheets. Hence the physics at larger space-time sheets is quite concretely a smoothed out version of the physics at smaller space-time sheets. Many-sheeted space-time itself performs renormalization group theory, and p-adic primes characterizing the sizes of the space-time sheets correspond to the fixed points of the renormalization group evolution.
- (c) There are good reasons to expect that the absolute minimum value for the Kähler action vanishes for large enough space-time sheets, and that space-time sheets result as small deformations of the vacuum extremals at the long length scale limit. The equations derived from Einstein-Hilbert action for the induced metric can be posed as an additional constraint on stationary vacuum extremals for which the gravitational four momentum current is conserved. It must be however emphasized that the structure of Einstein tensor as a source of the wave equation for the metric is enough to guarantee that gravitational masses make themselves visible in the asymptotic behavior of the metric.
An important difference to the standard view is that energy momentum tensor is defined by the Einstein tensor (plus possible contribution of metri
- (d) rather than vice versa. Since the dynamics of the induced EYM fields is dictated by the absolute minimization of Kähler action, EYM equations cannot in general be satisfied without the introduction of particle currents. This conforms with the view that Einstein's equations relate to a statistical description of matter in terms of both particle densities and classical fields. The imbeddability to $H = M_+^4 \times CP_2$ means a rich spectrum of predictions not made by GRT. TGD inspired cosmology and TGD based model for the final state of the star are good examples of these predictions, and are consistent with experimental facts.
- (e) Quantum measurement theory with a finite measurement resolution formulated in terms of Jones inclusions replacing effectively complex numbers as coefficient field of Hilbert space with non-commutative von Neumann algebra is the most recent formulation for the finite measurement resolution and leads to the rather fascinating vision about quantum TGD [K90, K30]. This formulation should have also a counterpart at space-time level and combined with number theoretical vision it leads to the emergence of discretization at space-time level realized in terms of number theoretical braids.
- (f) Dark matter hierarchy whose levels are labeled by the values of Planck constant brings in an additional complication [K36, K30]. Planck constant actually labels the "field bodies" mediating various interactions and gravitational field bodies have a gigantic value of Planck constant.

The realization of this hierarchy at the level of imbedding space means the replacement of the imbedding space with a book like structure whose pages are copies of imbedding space endowed with a finite and singular bundle projection corresponding to the group $Z_{n_a} \times Z_{n_b} \subset SO(3) \times SU(3)$. These groups act as discrete symmetries of field bodies.

The choice of these discrete subgroups realizes the choice of angular momentum and color quantization axes at the level of imbedding space and thus realizes quantum classical correspondence. Any two pages of this book with 8-D pages intersect along common at most 4-D sub-manifold and the partonic 2-surfaces in the intersection can regarded as quantum critical systems in the sense that they correspond to a critical point of a quantum phase transition in general changing the value of Planck constant. Field bodies are four-surfaces mediating interactions between four-surfaces at different pages of this book.

The value of Planck constant makes itself visible in the scaling of M^4 part of the metric of H appearing in Kähler action. The scaling factor of M^4 metric m_{kl} equals to $(\hbar/\hbar_0)^2 = (n_a/n_b)^2$ as is clear from the fact that the Laplacian part of Schrödinger equation is at same time proportional to the contravariant metric and to $1/\hbar^2$. This means that radiative corrections are coded by the nonlinear dependence of the Kähler action on the induced

metric. This means that all radiative corrections assignable to functional integral defined by exponent of Kähler function can vanish for preferred values of Kähler coupling strength. Number theoretic arguments require this.

8.2.2 Robertson-Walker cosmologies

Robertson-Walker cosmologies are the basic building block of standard cosmologies and sub-critical R-W cosmologies have a very natural place in TGD framework as Lorentz invariant cosmologies. Inflationary cosmologies are replaced with critical cosmologies being parameterized by a single parameter telling the duration of the critical cosmology. Over-critical cosmologies are also possible and have the same form as critical cosmologies and finite duration.

Why Robertson-Walker cosmologies?

Robertson Walker cosmology, which is a vacuum extremal of the Kähler action, is a reasonable idealization only in the length scales, where the density of the Kähler charge vanishes. Since (visible) matter and antimatter carry Kähler charges of opposite sign this means that Kähler charge density vanishes in length scales, where matter-antimatter asymmetry disappears on the average. This length scale is certainly very large in present day cosmology: in the proposed model for cosmology its present value is of the order of 10^8 light years: the size of the observed regions containing visible matter predominantly on their boundaries [E197]. That only matter is observed could be understood if it resides dominantly outside cosmic strings and antimatter inside cosmic strings.

Robertson Walker cosmology is expected to apply in the description of the condensate locally at each condensate level and it is assumed that the GRT based criteria for the formation of "structures" apply. In particular, the Jeans criterion stating that density fluctuations with size between Jeans length and horizon size can lead to the development of the "structures" will be applied.

Imbeddability requirement for RW cosmologies

Standard Robertson-Walker cosmology is characterized by the line element [E193]

$$ds^2 = f(a)da^2 - a^2\left(\frac{dr^2}{1 - kr^2} + r^2d\Omega^2\right), \quad (8.2.1)$$

where the values $k = 0, \pm 1$ of k are possible.

The line element of the light cone is given by the expression

$$ds^2 = da^2 - a^2\left(\frac{dr^2}{1 + r^2} + r^2d\Omega^2\right). \quad (8.2.2)$$

Here the variables a and r are defined in terms of standard Minkowski coordinates as

$$\begin{aligned} a &= \sqrt{(m^0)^2 - r_M^2}, \\ r_M &= ar. \end{aligned} \quad (8.2.3)$$

Light cone clearly corresponds to mass density zero cosmology with $k = -1$ and this makes the case $k = -1$ rather special as far imbeddings are considered since any Lorentz invariant map $M_+^4 \rightarrow CP_2$ defines imbedding

$$s^k = f^k(a) . \quad (8.2.4)$$

Here f^k are arbitrary functions of a .

$k = -1$ requirement guarantees imbeddability if the matter density is positive as is easy to see. The matter density is given by the expression

$$\rho = \frac{3}{8\pi G a^2} \left(\frac{1}{g_{aa}} + k \right) . \quad (8.2.5)$$

A typical imbedding of $k = -1$ cosmology is given by

$$\begin{aligned} \phi &= f(a) , \\ g_{aa} &= 1 - \frac{R^2}{4} (\partial_a f)^2 . \end{aligned} \quad (8.2.6)$$

where ϕ can be chosen to be the angular coordinate associated with a geodesic sphere of CP_2 (any one-dimensional sub-manifold of CP_2 works equally well). The square root term is always positive by the positivity of the mass density and the imbedding is indeed well defined. Since g_{aa} is smaller than one, the matter density is necessarily positive.

Critical and over-critical cosmologies

TGD allows the imbeddings of a one-parameter family of critical over-critical cosmologies. Critical cosmologies are however not inflationary in the sense that they would involve the presence of scalar fields. Exponential expansion is replaced with a logarithmic one so that the cosmologies are in this sense exact opposites of each other. Critical cosmology has been used hitherto as a possible model for the very early cosmology. What is remarkable that this cosmology becomes vacuum at the moment of 'Big Bang' since mass density behaves as $1/a^2$ as function of the light cone proper time. Instead of 'Big Bang' one could talk about 'Small Whisper amplified to bang' gradually. This is consistent with the idea that space-time sheet begins as a vacuum space-time sheet for some moment of cosmic time.

As an imbedded 4-surface this cosmology would correspond to a deformed future light cone having its tip inside the future light cone. The interpretation of the tip as a seed of a phase transition is possible. The imbedding makes sense up to some moment of cosmic time after which the cosmology becomes necessarily hyperbolic. At later time hyperbolic cosmology stops expanding and decomposes to disjoint 3-surfaces behaving as particle like objects co-moving at larger cosmological space-time sheet. These 3-surfaces topologically condense on larger space-time sheets representing new critical cosmologies.

Consider now in more detail the imbeddings of the critical and overcritical cosmologies. For $k = 0, 1$ the imbeddability requirement fixes the cosmology almost uniquely. To see this, consider as an example of $k = 0/1$ imbedding the map from the light cone to S^2 , where S^2 is a geodesic sphere of CP_2 with a vanishing Kähler form (any Lagrange manifold of CP_2 would do instead of S^2). In the standard coordinates (Θ, Φ) for S^2 and Robertson-Walker coordinates (a, r, θ, ϕ) for future light cone (, which can be regarded as empty hyperbolic cosmology), the imbedding is given as

$$\begin{aligned} \sin(\Theta) &= \frac{a}{a_1} , \\ (\partial_r \Phi)^2 &= \frac{1}{K_0} \left[\frac{1}{1 - kr^2} - \frac{1}{1 + r^2} \right] , \\ K_0 &= \frac{R^2}{4a_1^2} , \quad k = 0, 1 , \end{aligned} \quad (8.2.7)$$

when Robertson-Walker coordinates are used for both the future light cone and space-time surface.

The differential equation for Φ can be written as

$$\partial_r \Phi = \pm \sqrt{\frac{1}{K_0} \left[\frac{1}{1 - kr^2} - \frac{1}{1 + r^2} \right]} . \quad (8.2.8)$$

For $k = 0$ case the solution exists for all values of r . For $k = 1$ the solution extends only to $r = 1$, which corresponds to a 4-surface $r_M = m^0/\sqrt{2}$ identifiable as a ball expanding with the velocity $v = c/\sqrt{2}$. For $r \rightarrow 1$ Φ approaches constant Φ_0 as $\Phi - \Phi_0 \propto \sqrt{1 - r}$. The space-time sheets corresponding to the two signs in the previous equation can be glued together at $r = 1$ to obtain sphere S^3 .

The expression of the induced metric follows from the line element of future light cone

$$ds^2 = da^2 - a^2 \left(\frac{dr^2}{1 - kr^2} + r^2 d\Omega^2 \right) . \quad (8.2.9)$$

The imbeddability requirement fixes almost uniquely the dependence of the S^2 coordinates a and r and the g_{aa} component of the metric is given by the same expression for both $k = 0$ and $k = 1$.

$$\begin{aligned} g_{aa} &= 1 - K , \\ K &\equiv K_0 \frac{1}{(1 - u^2)} , \\ u &\equiv \frac{a}{a_1} . \end{aligned} \quad (8.2.10)$$

The imbedding fails for $a \geq a_1$. For $a_1 \gg R$ the cosmology is essentially flat up to immediate vicinity of $a = a_1$. Energy density and "pressure" follow from the general equation of Einstein tensor and are given by the expressions

$$\begin{aligned} \rho &= \frac{3}{8\pi G a^2} \left(\frac{1}{g_{aa}} + k \right) , \quad k = 0, \pm 1 , \\ \frac{1}{g_{aa}} &= \frac{1}{1 - K} , \\ p &= -\left(\rho + \frac{a \partial_a \rho}{3} \right) = -\frac{\rho}{3} + \frac{2}{3} K_0 u^2 \frac{1}{(1 - K)(1 - u^2)^2} \rho_{cr} , \\ u &\equiv \frac{a}{a_1} . \end{aligned} \quad (8.2.11)$$

Here the subscript 'cr' refers to $k = 0$ case. Since the time component g_{aa} of the metric approaches constant for very small values of the cosmic time, there are no horizons associated with this metric. This is clear from the formula

$$r(a) = \int_0^a \sqrt{g_{aa}} \frac{da}{a}$$

for the horizon radius.

g_{aa} vanishes at the limit $a \rightarrow a_f = a_1\sqrt{1-K_0}$. One has $a_f \simeq a_1$ in excellent approximation for cosmic values of a_1 as is clear from the definition of K_0 . For $a = a_f$ the signature of the metric transforms to Euclidian. The relationship between cosmic proper time $t = \int \sqrt{g_{aa}} da$ and a is given in excellent approximation $a = t$ so that the situation is very much like for empty Minkowski space. 3-space is flat but there is no expansion with exponential rate as in the case of inflationary cosmologies. The expansion is accelerating since the counterpart of pressure is negative.

The mass density associated with these cosmologies behaves as $\rho \propto 1/a^2$ for very small values of the M_+^4 proper time. The mass in a co-moving volume is proportional to $a/(1-K)$ and goes to zero at the limit $a \rightarrow 0$. Thus, instead of Big Bang one has 'Silent Whisper' gradually amplifying to Big Bang. The imbedding fails at the limit $a \rightarrow a_1$. At this limit energy density becomes infinite. This cosmology can be regarded as a cosmology for which co-moving strings ($\rho \propto 1/a^2$) dominate the mass density as is clear also from the fact that the "pressure" becomes negative at big bang ($p \rightarrow -\rho/3$) reflecting the presence of the string tension. The natural interpretation is that cosmic strings condense on the space-time sheet which is originally empty.

The facts that the imbedding fails and gravitational energy density diverges for $a = a_1$ necessitates a transition to a hyperbolic cosmology. For instance, a transition to radiation or matter dominated hyperbolic cosmology can occur at the limit $\theta \rightarrow \pi/2$. At this limit $\phi(r)$ must transform to a function $\phi(a)$. The fact, that vacuum extremals of Kähler action are in question, allows large flexibility for the modeling of what happens in this transition. Quantum criticality and p-adic fractality suggest the presence of an entire fractal hierarchy of space-time sheets representing critical cosmologies created at certain values of cosmic time and having as their light cone projection sub-light cone with its tip at some $a=\text{constant}$ hyperboloid.

More general imbeddings of critical and over-critical cosmologies as vacuum extremals

In order to obtain imbeddings as more general vacuum extremals, one must pose the condition guaranteing the vanishing of corresponding the induced Kähler form (see the Appendix of this book). Using coordinates $(r, u = \cos(\Theta), \Psi, \Phi)$ for CP_2 the surfaces in question can be expressed as

$$\begin{aligned} r &= \sqrt{\frac{X}{1-X}} , \\ X &= D|k+u| , \\ u &\equiv \cos(\Theta) , \quad D = \frac{r_0^2}{1+r_0^2} \times \frac{1}{C} , \quad C = |k + \cos(\Theta_0)| . \end{aligned} \quad (8.2.12)$$

Here C and D are integration constants.

These imbeddings generalize to imbeddings to $M^4 \times Y^2$, where Y^2 belongs to a family of Lagrange manifolds described in the Appendix of this book with induced metric

$$\begin{aligned} ds_{eff}^2 &= \frac{R^2}{4} [s_{\Theta\Theta}^{eff} d\Theta^2 + s_{\Phi\Phi}^{eff} d\Phi^2] , \\ s_{\Theta\Theta}^{eff} &= X \times \left[\frac{(1-u^2)}{(k+u)^2} \times \frac{1}{1-X} + 1 - X \right] , \\ s_{\Phi\Phi}^{eff} &= X \times [(1-X)(k+u)^2 + 1 - u^2] . \end{aligned} \quad (8.2.13)$$

For $k \neq 1$ $u = \pm 1$ corresponds in general to circle rather than single point as is clear from the fact that $s_{\Phi\Phi}^{eff}$ is non-vanishing at $u = \pm 1$ so that u and Φ parameterize a piece of cylinder. The generalization of the previous imbedding is as

$$\sin(\Theta) = ka \rightarrow \sqrt{s_{\Phi\Phi}^{eff}} = ka . \quad (8.2.14)$$

For Φ the expression is as in the previous case and determined by the requirement that g_{rr} corresponds to $k = 0, 1$.

The time component of the metric can be expressed as

$$g_{aa} = 1 - \frac{R^2 k^2}{4} \frac{s_{\Theta\Theta}^{eff}}{\frac{d\sqrt{s_{\Phi\Phi}^{eff}}}{d\Theta}} \quad (8.2.15)$$

In this case the $1/(1-k^2a^2)$ singularity of the density of gravitational mass at $\Theta = \pi/2$ is shifted to the maximum of $s_{\Phi\Phi}^{eff}$ as function of Θ defining the maximal value a_{max} of a for which the imbedding exists at all. Already for $a_0 < a_{max}$ the vanishing of g_{aa} implies the non-physicality of the imbedding since gravitational mass density becomes infinite.

The geometric properties of critical cosmology change radically in the transition to the radiation dominated cosmology: before the transition the CP_2 projection of the critical cosmology is two-dimensional. After the transition it is one-dimensional. Also the isometry group of the cosmology changes from $SO(3) \times E^3$ to $SO(3, 1)$ in the transition. One could say that critical cosmology represents Galilean Universe whereas hyperbolic cosmology represents Lorentzian Universe.

String dominated cosmology

A particularly interesting cosmology is string dominated cosmology with very nearly critical mass density. Assuming that strings are co-moving the mass density of this cosmology is proportional to $1/a^2$ instead of the $1/a^3$ behavior characteristic to the standard matter dominated cosmology. The line element of this metric is very simple: the time component of the metric is simply constant smaller than 1:

$$g_{aa} = K < 1 . \quad (8.2.16)$$

The Hubble constant for this cosmology is given by

$$H = \frac{1}{\sqrt{Ka}} , \quad (8.2.17)$$

and the so called acceleration parameter [E193] k_0 proportional to the second derivative \ddot{a} therefore vanishes. Mass density and pressure are given by the expression

$$\rho = \frac{3}{8\pi G K a^2} (1 - K) = -3p . \quad (8.2.18)$$

What makes this cosmology so interesting is the absence of the horizons. The comparison with the critical cosmology shows that these two cosmologies resemble each other very closely and both could be used as a model for the very early cosmology.

Stationary cosmology

An interesting candidate for the asymptotic cosmology is stationary cosmology for which gravitational four-momentum currents (and also gravitational color currents) are conserved. This cosmology extremizes the Einstein-Hilbert action with cosmological term given by $\int(kR + \lambda)\sqrt{g}d^4x + \lambda$ and is obtained as a sub-manifold $X^4 \subset M_+^4 \times S^1$, where S^1 is the geodesic circle of CP_2 (note that imbedding is now unique apart from isometries by variational principle).

For a vanishing cosmological constant, field equations reduce to the conservation law for the isometry associated with S^1 and read

$$\partial_a(G^{aa}\partial_a\phi\sqrt{g}) = 0 , \quad (8.2.19)$$

where ϕ denotes the angle coordinate associated with S^1 . From this one finds for the relevant component of the metric the expression

$$\begin{aligned} g_{aa} &= \frac{(1-2x)}{(1-x)} , \\ x &= \left(\frac{C}{a}\right)^{2/3} . \end{aligned} \quad (8.2.20)$$

The mass density and "pressure" of this cosmology are given by the expressions

$$\begin{aligned} \rho &= \frac{3}{8\pi G a^2} \frac{x}{(1-2x)} , \\ p &= -\left(\rho + \frac{a\partial_a\rho}{3}\right) = -\frac{\rho}{9} \left[3 - \frac{2}{(1-2x)}\right] . \end{aligned} \quad (8.2.21)$$

The asymptotic behavior of the energy density is $\rho \propto a^{-8/3}$. "Pressure" becomes negative indicating that this cosmology is dominated by the string like objects, whose string tension gives negative contribution to the "pressure". Also this cosmology is horizon free as are all string dominated cosmologies: this is of crucial importance in TGD inspired cosmology.

It should be noticed that energy density for this cosmology becomes infinite for $x = (C/a)^{2/3} = 1/2$ implying that this cosmology doesn't make sense at very early times so that the non-conservation of gravitational energy is necessary during the early stages of the cosmology.

Stationary cosmologies could define space-time correlates for macroscopic quantum states in cosmological length scales predicted by the hypothesis for the values of gravitational Planck constant [K36]. Together with critical cosmologies serving as space-time correlates for cosmic quantum jumps increasing gravitational Planck constant they could define basic building blocks for late cosmologies in TGD Universe.

Non-conservation of gravitational energy in RW cosmologies

In *RW* cosmology the gravitational energy in a given co-moving sphere of radius r in local light cone coordinates (a, r, θ, ϕ) is given by

$$E = \int \rho g^{aa} \partial_a m^0 \sqrt{g} dV . \quad (8.2.22)$$

The rate characterizing the non-conservation of gravitational energy is determined by the parameter X defined as

$$X \equiv \frac{(dE/da)_{vap}}{E} = \frac{(dE/da + \int |g^{rr}| p \partial_r m^0 \sqrt{g} d\Omega)}{E} , \quad (8.2.23)$$

where p denotes the pressure and $d\Omega$ denotes angular integration over a sphere with radius r . The latter term subtracts the energy flow through the boundary of the sphere.

The generation of the pairs of positive and negative (inertial) energy space-time sheets leads to a non-conservation of gravitational energy. The generation of pairs of positive and negative energy cosmic strings would be involved with the generation of a critical sub-cosmology. "Fermionic" pairs would have time-like separation and "bosonic" pairs would consist of parallel stringy space-time sheets connected by wormhole contacts.

For RW cosmology with subcritical mass density the calculation gives

$$X = \frac{\partial_a(\rho a^3/\sqrt{g_{aa}})}{(\rho a^3/\sqrt{g_{aa}})} + \frac{3pg_{aa}}{\rho a} . \quad (8.2.24)$$

This formula applies to any infinitesimal volume. The rate doesn't depend on the details of the imbedding (recall that practically any one-dimensional sub-manifold of CP_2 defines a huge family of subcritical cosmologies). Apart from the numerical factors, the rate behaves as $1/a$ in the most physically interesting RW cosmologies. In the radiation dominated and matter dominated cosmologies one has $X = -1/a$ and $X = -1/2a$ respectively so that gravitational energy decreases in radiation and matter dominated cosmologies. For the string dominated cosmology with $k = -1$ having $g_{aa} = K$ one has $X = 2/a$ so that gravitational energy increases: this might be due to the generation of dark matter due to pairs of cosmic strings with vanishing net inertial energy.

For the cosmology with exactly critical mass density Lorentz invariance is broken and the contribution of the rate from 3-volume depends on the position of the co-moving volume. Taking the limit of infinitesimal volume one obtains for the parameter X the expression

$$\begin{aligned} X &= X_1 + X_2 , \\ X_1 &= \frac{\partial_a(\rho a^3/\sqrt{g_{aa}})}{(\rho a^3/\sqrt{g_{aa}})} , \\ X_2 &= \frac{pg_{aa}}{\rho a} \times \frac{3 + 2r^2}{(1 + r^2)^{3/2}} . \end{aligned} \quad (8.2.25)$$

Here r refers to the position of the infinitesimal volume. Simple calculation gives

$$\begin{aligned} X &= X_1 + X_2 , \\ X_1 &= \frac{1}{a} \left[1 + 3K_0 u^2 \frac{1}{1-K} \right] , \\ X_2 &= -\frac{1}{3a} \left[1 - K - \frac{2K_0 u^2}{(1-u^2)^2} \right] \times \frac{3+2r^2}{(1+r^2)^{3/2}} , \\ K &= \frac{K_0}{1-u^2} , \quad u = \frac{a}{a_0} , \quad K_0 = \frac{R^2}{4a_0^2} . \end{aligned} \quad (8.2.26)$$

The positive density term X_1 corresponds to increase of gravitational energy which is gradually amplified whereas pressure term ($p < 0$) corresponds to a decrease of gravitational energy changing however its sign at the limit $a \rightarrow a_0$.

The interpretation might be in terms of creation of pairs of positive and negative energy particles contributing nothing to the inertial energy but increasing gravitational energy. Also pairs of positive energy gravitons and negative anti-gravitons are involved. The contributions of all particle species are determined by thermal arguments so that gravitons should not play any special role as thought originally.

Pressure term is negligible at the limit $r \rightarrow \infty$ so that topological condensation occurs all the time at this limit. For $a \rightarrow 0, r \rightarrow 0$ one has $X > 0 \rightarrow 0$ so that condensation starts from zero at $r = 0$. For $a \rightarrow 0, r \rightarrow \infty$ one has $X = 1/a$ which means that topological condensation is present already at the limit $a \rightarrow 0$.

Both the existence of the finite limiting temperature and of the critical mass density imply separately finite energy per co-moving volume for the condensate at the very early stages of the cosmic evolution. In fact, the mere requirement that the energy per co-moving volume in the vapor phase remains finite and non-vanishing at the limit $a \rightarrow 0$ implies string dominance as the following argument shows.

Assuming that the mass density of the condensate behaves as $\rho \propto 1/a^{2(1+\alpha)}$ one finds from the expression

$$\rho \propto \frac{\left(\frac{1}{g_{aa}} - 1\right)}{a^2},$$

that the time component of the metric behaves as $g_{aa} \propto a^\alpha$. Unless the condition $\alpha < 1/3$ is satisfied or equivalently the condition

$$\rho < \frac{k}{a^{2+2/3}} \tag{8.2.27}$$

is satisfied, gravitational energy density is reduced. In fact, the limiting behavior corresponds to the stationary cosmology, which is not imbeddable for the small values of the cosmic time. For stationary cosmology gravitational energy density is conserved which suggests that the reduction of the density of cosmic strings is solely due to the cosmic expansion.

8.2.3 Cosmic strings and cosmology

The model for cosmic strings has forced to question all cherished assumptions including positive energy ontology, Equivalence Principle, and positivity of gravitational mass. The final outcome turned out to be rather conservative. Zero energy ontology is unavoidable, Equivalence Principle holds true universally but its general relativistic formulation makes sense only in long length scales, and gravitational mass has definite sign for positive/negative energy states. As a matter fact, all problems were created by the failure to realize that the expression of gravitational energy in terms of Einstein's tensor does not hold true in short length scales and must be replaced with the stringy expression resulting naturally by dimensional reduction of quantum TGD to string model like theory [K19, K36, K5].

Zero energy ontology and cosmic strings

There are two kinds of cosmic strings: free and topological condensed ones and both are important in TGD inspired cosmology.

- (a) Free cosmic strings are not absolute minima of the Kähler action (the action has wrong sign). In the original identification of preferred extremals as absolute minima of Kähler action this was a problem. In the new formulation preferred extremals correspond to quantum criticality identified as the vanishing of the second variation of Kähler action at least for the deformations defining symmetries of Kähler action [K19, K36]. Criticality guarantees the conservation of the Noether charges assignable to the modified Dirac action.

Ideal cosmic strings are excluded because they fail to satisfy the conditions characterizing the preferred extremal as a space-time surface containing regions with both Euclidian and Minkowskian signature of the induced metric with light-like 3-surface separating them identified as orbits of partonic 2-surfaces carrying elementary particle quantum numbers. The topological condensation of CP_2 type vacuum extremals representing fermions generates negative contribution to the action and reduces the string tension and leaves cosmic strings still free.

- (b) If the topologically condensate of fermions has net Kähler charges as the model for matter antimatter asymmetry suggests, the repulsive interaction of the particles tends to thicken the cosmic string by increasing the thickness of its infinitely thin M^4 projection so that Kähler magnetic flux tubes result. These flux tubes are ideal candidates for the carriers of dark matter with a large value of Planck constant. The criterion for the phase transition increasing \hbar is indeed the presence of a sufficiently dense plasma implying that perturbation theory in terms of $Z^2\alpha_{em}$ (Z is the effective number of charges with interacting with each other without screening effects) fails for the standard value of Planck constant. The phase transition $\hbar_0 \rightarrow \hbar$ reduces the value of $\alpha_{em} = e^2/4\pi\hbar$ so that perturbation theory works. This phase transition scales up also the transversal size of the cosmic string. Similar criterion works also for other charges. The resulting phase is anyonic if the resulting 2-surfaces containing almost spherical portions connected by flux tubes to each other encloses the tip of the causal diamond (CD). The proposal is that dark matter resides on complex anyonic 2-surfaces surrounding the tips of CD s.
- (c) The topological condensation of cosmic strings generates wormhole contacts represented as pieces of CP_2 type vacuum extremals identified as bosons composed of fermion-antifermion pairs. Also this generates negative action and can make cosmic string a preferred extremal of Kähler action. The earliest picture was based on dynamical cancelation mechanism involving generation of strong Kähler electric fields in the condensation whose action compensated for Kähler magnetic action. Also this mechanism might be at work. Cosmic strings could also form bound states by the formation graviton like flux tubes connecting them and having wormhole contacts at their ends so that again action is reduced.
- (d) One can argue that in long enough length and time scales Kähler action per volume must vanish so that the idealization of cosmology as a vacuum extremal becomes possible and there must be some mechanism compensating the positive action of the free cosmic strings. The general mechanism could be topological condensation of fermions and creation of bosons by topological condensation of cosmic strings to space-time sheets.

In this framework zero energy states correspond to cosmologies leading from big bang to big crunch separated by some time interval T of geometric time. Quantum jumps can gradually increase the value T and TGD inspired theory of consciousness suggests that the increase of T might relate to the shift for the contents of conscious experience towards geometric future. In particular, what is usually regarded as cosmology could have started from zero energy state with a small value of T .

Topological condensation of cosmic strings

In the original vision about topological condensation of cosmic strings I assumed that large voids represented by space-time sheets contain "big" cosmic string in their interior and galactic strings near their boundaries. The recent much simpler view is that there are just galactic strings which carry net fermion numbers (matter antimatter asymmetry). If they have also net em charge they have a repulsive interaction and tend to end up to the boundaries of the large void. Since this slows down the expansive motion of strings, the repulsive interaction energy increases and a phase transition increasing Planck constant and scaling up the size of the void occurs after which cosmic strings are again driven towards the boundary of the resulting larger void.

One cannot assume that the exterior metric of the galactic strings is the one predicted by assuming General Relativity in the exterior region. This would mean that metric decomposes as

$g = g_2(X^2) + g_2(Y^2)$. $g(X^2)$ would be flat as also $g_2(Y^2)$ expect at the position of string. The resulting angle defect due to the replacement of plane Y^2 with cone would be large and give rise to lense effect of same magnitude as in the case of GUT cosmic strings. Lense effect has not been observed.

This suggests that General Relativity fails in the length scale of large void as far as the description of topologically condensed cosmic strings is considered. The constant velocity spectrum for distant stars of galaxies and the fact that galaxies are organized along strings suggests that these string generate in a good approximation Newtonian potential. This potential predicts constant velocity spectrum with a correct value velocity.

In the stationary situation one expects that the exterior metric of galactic string corresponds to a small deformation of vacuum extremal of Kähler action which is also extremal of the curvature scalar in the induced metric. This allows a solution ansatz which conforms with Newtonian intuitions and for which metric decomposes as $g = g_1 + g_3$, where g_1 corresponds to axis in the direction of string and g_3 remaining 1 + 2 directions.

Dark energy is replaced with dark matter in TGD framework

The observed accelerating expansion of the Universe has forced to introduce the notion of cosmological constant in the GRT based cosmology. In TGD framework the situation is different.

- (a) The gigantic value of gravitational Planck constant implies that dark matter makes TGD Universe a macroscopic quantum system even in cosmological length scales. Astrophysical systems become stationary quantum systems which participate in cosmic expansion only via quantum phase transitions increasing the value of gravitational Planck constant.
- (b) Critical cosmologies, which are determined apart from a single parameter in TGD Universe, are natural during all quantum phase transitions, in particular the phase transition periods increasing the size of large voids and having interpretation in terms of an increase of gravitational Planck constant. Cosmic expansion is predicted to be accelerating during these periods. The mere criticality requires that besides ordinary matter there is a contribution $\Omega_\Lambda \simeq .74$ to the mass density besides visible matter and dark matter. In fact, also for the over-critical cosmologies expansion is accelerating.
- (c) In GRT framework the essential characteristic of dark energy is its negative pressure. In TGD framework critical and over-critical cosmologies have automatically effective negative pressure. This is essentially due to the constraint that Lorentz invariant vacuum extremal of Kähler action is in question. The mysterious negative pressure would be thus a signal about the representability of space-time as 4-surface in H and there is no need for any microscopic description in terms of exotic thermodynamics.

The values for the TGD counterpart of cosmological constant

One can introduce a parameter characterizing the contribution of dark mass to the mass density during critical periods and call it cosmological constant recalling however that the contribution does not correspond to dark energy. The value of this parameter is same as in the standard cosmology from mere criticality assumption.

What is new that p-adic fractality predicts that Λ scales as $1/L^2(k)$ as a function of the p-adic scale characterizing the space-time sheet implying a series of phase transitions reducing Λ . The order of magnitude for the recent value of the cosmological constant comes out correctly. The gravitational energy density assignable to the cosmological constant is identifiable as that associated with topologically condensed cosmic strings and magnetic flux tubes to which they are gradually transformed during cosmological evolution.

The naive expectation would be the density of cosmic strings would behave as $1/a^2$ as function of M_+^4 proper time. The vision about dark matter as a phase characterized by gigantic Planck constant however implies that large voids do not expand in continuous manner during cosmic evolution but in discrete quantum jumps increasing the value of the gravitational Planck constant

and thus increasing the size of the large void as a quantum state. Since the set of preferred values of Planck constant is closed under multiplication by powers of 2, p-adic length scales L_p , $p \simeq 2^k$ form a preferred set of sizes scales for the large voids.

TGD cosmic strings are consistent with the fluctuations of CMB

GUT cosmic strings were excluded by the fluctuation spectrum of the CMB background [E12]. In GRT framework these fluctuations can be classified to adiabatic density perturbations and isocurvature density perturbations. Adiabatic density perturbations correspond to overall scaling of various densities and do not affect the vanishing curvature scalar. For isocurvature density fluctuations the net energy density remains invariant. GUT cosmic strings predict isocurvature density perturbations while inflationary scenario predicts adiabatic density fluctuations.

In TGD framework inflation is replaced with quantum criticality of the phase transition period leading from the cosmic string dominated phase to matter dominated phase. Since curvature scalar vanishes during this period, the density perturbations are indeed adiabatic.

Matter-antimatter asymmetry and cosmic strings

Despite huge amount of work done during last decades (during the GUT era the problem was regarded as being solved!) matter-antimatter asymmetry remains still an unresolved problem of cosmology. A possible resolution of the problem is matter-antimatter asymmetry in the sense that cosmic strings contain antimatter and their exteriors matter. The challenge would be to understand the mechanism generating this asymmetry. The vanishing of the net gauge charges of cosmic string allows this symmetry since electro-weak charges of quarks and leptons can cancel each other.

The challenge is to identify the mechanism inducing the CP breaking necessary for the matter-antimatter asymmetry. Quite a small CP breaking inside cosmic strings would be enough.

- (a) The key observation is that vacuum extremals as such are not physically acceptable: small deformations of vacuum extremals to non-vacua are required. This applies also to cosmic strings since as such they do not present preferred extremals. The reason is that the preferred extremals involve necessary regions with Euclidian signature providing four-dimensional representations of generalized Feynman diagrams with particle quantum numbers at the light-like 3-surfaces at which the induced metric is degenerate.
- (b) The simplest deformation of vacuum extremals and cosmic strings would be induced by the topological condensation of CP_2 type vacuum extremals representing fermions. The topological condensation at larger space-time surface in turn creates bosons as wormhole contacts.
- (c) This process induces a Kähler electric fields and could induce a small Kähler electric charge inside cosmic string. This in turn would induce CP breaking inside cosmic string inducing matter antimatter asymmetry by the minimization of the ground state energy. Conservation of Kähler charge in turn would induce asymmetry outside cosmic string and the annihilation of matter and antimatter would then lead to a situation in which there is only matter.
- (d) Either galactic cosmic strings or big cosmic strings (in the sense of having large string tension) at the centers of galactic voids or both could generate the asymmetry and in the recent scenario big strings are not necessary. One might argue that the photon to baryon ratio $r \sim 10^{-9}$ characterizing matter asymmetry quantitatively must be expressible in terms of some fundamental constant possibly characterizing cosmic strings. The ratio $\epsilon = G/\hbar R^2 \simeq 4 \times 10^{-8}$ is certainly a fundamental constant in TGD Universe. By replacing R with $2\pi R$ would give $\epsilon = G/(2\pi R)^2 \simeq 1.0 \times 10^{-9}$. It would not be surprising if this parameter would determine the value of r .

The model can be criticized.

- (a) The model suggest only a mechanism and one can argue that the Kähler electric fields created by topological condensates could be random and would not generate any Kähler electric charge. Also the sign of the asymmetry could depend on cosmic string. A CP breaking at the fundamental level might be necessary to fix the sign of the breaking locally.
- (b) The model is not the only one that one can imagine. It is only required that antimatter is somewhere else. Antimatter could reside also at other p-adic space-time sheets and at the dark space-time sheets with different values of Planck constant.

The needed CP breaking is indeed predicted by the fundamental formulation of quantum TGD in terms of the modified Dirac action associated with Kähler action and its generalization allowing include instanton term as imaginary part of Kähler action inducing CP breaking [K19, K63] .

- (a) The key idea in the formulation of quantum TGD in terms of modified Dirac equation associated with Kähler action is that the Dirac determinant defined by the generalized eigenvalues assignable to the Dirac operator D_K equals to the vacuum functional defined as the exponent of Kähler function in turn identifiable as Kähler action for a preferred extremal for which the second variation of Kähler action vanishes at least for the variations responsible for dynamical symmetries. The interpretation is in terms of quantum criticality with the hierarchy of symmetries defining a hierarchy of criticalities analogous to the hierarchy defined by the rank of the matrix defined by the second derivatives of potential function in Thom's catastrophe theory.
- (b) This representation generalizes. One can add an imaginary instanton term to the Kähler function and corresponding modified Dirac operator D_K so that the generalized eigenvalues assignable to D_K (analogous to Higgs vacuum expectation) become complex. The natural conjecture is that the resulting Dirac determinant equals to the exponent of Kähler action and imaginary instanton term for the preferred extremal. The instanton term does not contribute to the configuration space metric but provides a first principle description for CP breaking and anyonic effects. It also predicts the dependence of these effects on the page of the book like structure defined by the generalized imbedding space realizing the dark matter hierarchy with levels labeled by the value of Planck constant.
- (c) In the case of cosmic strings CP breaking could be especially significant and force the generation of Kähler electric charge. Instanton term is proportional to $1/\hbar$ so that CP breaking would be small for the gigantic values of \hbar characterizing dark matter. For small values of \hbar the breaking is large provided that the topological condensation is able to make the CP_2 projection of cosmic string four-dimensional so that the instanton contribution to the complexified Kähler action is non-vanishing and large enough. Since instanton contribution as a local divergence reduces to the contributions assignable to the light-like 3-surfaces X_l^3 representing topologically condensed particles, CP breaking is large if the density of topologically condensed fermions and wormhole contacts generated by the condensation of cosmic strings is high enough.

CP breaking at the level of CKM matrix

The CKM matrix for quarks contains CP breaking phase factors and this could lead to different evaporation rates for baryons and anti-baryons are different (quark cannot appear as vapor phase particle since vapor phase particle must have vanishing color gauge charges and in the recent vision about quantum TGD CP_2 type vacuum extremal which has not suffered topological condensation represents vacuum). The CP breaking at the level of CKM matrix would be implied by the instanton term present in the complexified Kähler action and modified Dirac operator. The mechanism might rely on hadronic Kähler electric fields which are accompanied by color electric gauge fields proportional to induced Kähler form.

The topological condensation of quarks on hadronic strings containing weak color electric fields proportional to Kähler electric fields should be responsible for its string tension and this should in turn generate CP breaking. At the parton level the presence of CP breaking phase factor $\exp(ikS_{CS})$, where $S_{CS} = \int_{X^4} J \wedge J + \text{boundary term}$ is purely topological Chern Simons

term and naturally associated with the boundaries of space-time sheets with at most $D = 3$ -dimensional CP_2 projection, could have something to do with the matter antimatter asymmetry. Note however that TGD predicts no strong CP breaking as QCD does [K5] .

Development of strings in the string dominated cosmology

The development of the string perturbations in the Robertson Walker cosmology has been studied [E190] and the general conclusion seems to be that that all the details smaller than horizon are rapidly smoothed out. One must of course take very cautiously the application of these result in TGD framework.

In present case, the horizon has an infinite size so that details in all scales should die away. To see what actually happens consider small perturbations of a static string along z -axis. Restrict the consideration to a perturbation in the y -direction. Using instead of the proper time coordinate t the "conformal time coordinate" τ defined by $d\tau = dt/a$ the equations of motion read [E190]

$$\begin{aligned} (\partial_\tau + \frac{2\dot{a}}{a})(\dot{y}U) &= \partial_z(y'U) , \\ U &= \frac{1}{\sqrt{1 + (y')^2 - \dot{y}^2}} . \end{aligned} \quad (8.2.28)$$

Restrict the consideration to small perturbations for which the condition $U \simeq 1$ holds. For the string dominated cosmology the quantity $\dot{a}/a = 1/\sqrt{K}$ is constant and the equations of motion reduce to a very simple approximate form

$$\ddot{y} + \frac{2}{\sqrt{K}}\dot{y} - y'' = 0 . \quad (8.2.29)$$

The separable solutions of this equation are of type

$$\begin{aligned} y &= g(a)(C \sin(kz) + D \cos(kz)) , \\ g(a) &= \left(\frac{a}{a_0}\right)^r . \end{aligned} \quad (8.2.30)$$

where r is a solution of the characteristic equation $r^2 + 2r/\sqrt{K} + k^2 = 0$:

$$r = -\frac{1}{\sqrt{K}}(1 \pm \sqrt{1 - k^2 K}) . \quad (8.2.31)$$

For perturbations of small wavelength $k > 1/\sqrt{K}$, an extremely rapid attenuation occurs; $1/\sqrt{K} \simeq 10^{27}$! For the long wavelength perturbations with $k \ll 1/\sqrt{K}$ (physical wavelength is larger than t) the attenuation is milder for the second root of above equation: attenuation takes place as $(a/a_0)^{\sqrt{K}k^2/2}$. The conclusion is that irregularities in all scales are smoothed away but that attenuation is much slower for the long wave length perturbations.

The absence of horizons in the string dominated phase has a rather interesting consequence. According to the well known Jeans criterion the size L of density fluctuations leading to the formation of structures [E190] must satisfy the following conditions

$$l_J < L < l_H , \quad (8.2.32)$$

where l_H denotes the size of horizon and l_J denotes the Jeans length related to the sound velocity v_s and cosmic proper time as [E190]

$$l_J \simeq 10v_s t . \quad (8.2.33)$$

For a string dominated cosmology the size of the horizon is infinite so that no upper bound for the size of the possible structures results. These structures of course, correspond to string like objects of various sizes in the microscopic description. This suggests that primordial fluctuations create structures of arbitrary large size, which become visible at much later time, when cosmology becomes string dominated again.

8.2.4 Thermodynamical considerations

The new view about energy challenging the universal applicability of the second law of thermodynamics, the existence of 'vapor phase' consisting mainly of cosmic strings and critical temperature equal to Hagedorn temperature are basic characteristics of TGD inspired cosmology. The recent view about preferred extremals [K19, K36] requires that cosmic strings are accompanied by a topological condensate of fermions (and possibly also super-symplectic bosons) represented by CP_2 type vacuum extremals. The corresponding light-like 3-surfaces define generalized Feynman diagram associated with the state.

New view about second law: first trial

Quantum classical correspondence suggests negative and positive energy strings (in the sense of zero energy ontology) tend to dissipate backwards in opposite directions of the geometric time in their geometric degrees of freedom. Time reversed dissipation of negative energy states looks from the point of view of systems consisting of positive energy matter self-organization and even self assembly. The matter at the space-time sheet containing strings in turn consists of positive energy matter and negative energy antimatter and also here same competition would prevail.

This tension suggests a general manner to understand the paradoxical aspects of the cosmic and biological evolution.

- (a) The first paradox is that the initial state of cosmic evolution seems to correspond to a maximally entropic state. Entropy growth would be naturally due to the emergence of matter inside cosmic strings giving them large p-adic entropy proportional to mass squared [K36, K5] . As strings decay to ordinary matter and transform to magnetic flux tubes the entropy related to translation degrees of freedom increases.
- (b) The dissipative evolution of matter at space-time sheets with positive time orientation would obey second law and evolution of space-time sheets with negative time orientation its geometric time reversal. Second law would hold true in the standard sense as long as one can neglect the interaction with negative energy antimatter and strings.
- (c) The presence of the cosmic strings with negative energy and time orientation could explain why gravitational interaction leads to a self-assembly of systems in cosmic time scales. The formation of supernovae, black holes and the possible eventual concentration of positive energy matter at the negative energy cosmic strings could reflect the self assembly aspect due to the presence of negative energy strings. An analog of biological self assembly identified as the geometric time reversal for ordinary entropy generating evolution would be in question.
- (d) In the standard physics framework the emergence of life requires extreme fine tuning of the parameters playing the role of constants of Nature and the initial state of the Universe should be fixed with extreme accuracy in order to predict correctly the emergence of life. In the proposed framework situation is different. The competition between dissipations occurring in reverse time directions means that the analog of homeostasis fundamental for

the functioning of living matter is realized at the level of cosmic evolution. The signalling in both directions of geometric time makes the system essentially four-dimensional with feedback loops realized as geometric time loops so that the evolution of the system would be comparable to the carving of a four-dimensional statue rather than approach to chaos.

- (e) The apparent creation of order by the gravitational interactions is a mystery in the standard cosmology. A naive application of the second law of thermodynamics suggests that in GRT based cosmology the most probable end state corresponds to a black hole dominated Universe since the entropy of the black hole is much larger than the entropy of a typical star with the same mass. TGD allows to consider several alternative solutions of this puzzle.
- i. One might think that the the hierarchy of Planck constants and the proportional of the black hole entropy to \hbar could make black holes entropic so that they would not be favored final states of evolution. This argument turned out to be wrong. If black holes are dark black holes with a gigantic gravitational Planck constant the sheets of the blackhole surface for C-C option - which can be understood as a consequence of basic TGD- are not entropic since the entropy for single sheet of the covering is scaled down by $1/n_a n_b$. For the entire covering one however obtains just the standard black-hole entropy since the number of sheets equals to \hbar/\hbar_0 . This would suggest that entropy serves as a control variable in the sense that when it exceeds the threshold value, the partonic 2-surfaces at the ends of CD split to a surfaces in the covering. In the Bohr orbit model for solar system the value of Planck constant for the space-time sheets mediating gravitational interaction has the gigantic value $\hbar_{gr} = GM_1 M_2/v_0$, where $v_0 = 2^{-11}$ holds true for inner planets. If $\hbar_{gr} = GM^2/v_0$ holds true for black holes, black hole entropy for single sheet of covering would be of order $1/v_0$. For $v_0 = 1/4$ this entropy would be of order single bit and Schwarzschild radius would be equal to the scaled up Planck length $l_P = \sqrt{\hbar_{gr} M}$.
 - ii. The new view about second law inspires the view that gravitational self-organization corresponds to the temporal mirror image of dissipative time evolution for space-time sheets with negative time orientation competing with thermalization. In this situation negative energy dark black holes with small entropy are possible. The formation of black hole would look like breaking of second law from the point of view of observed with standard arrow of geometric time. The self organizing tendency of negative energy cosmic strings would compete with the opposite tendency of positive energy strings and ordinary matter could give rise to kind of gravitational homeostasis. Although black-hole like structures would result as outcome of gravitational self-organization they would not be sinks of information but have complex internal information carrying structure.
 - iii. It is also possible that elementary particles take the role of black holes in TGD framework. CP_2 type extremals are the counterparts of the black holes in TGD. Hawking-Bekenstein area law generalizes and states that elementary particles are carriers of p-adic entropy. Thus this p-adic entropy associated with the thermodynamics of Virasoro generator L_0 could be the counterpart of black hole entropy and the decay of the free cosmic strings to elementary particles would thus generate "invisible" entropy. The upper bound for the p-adic entropy depends on p-adic condensation level as $\log(p)$ so that the generation of the new space-time sheets with increasing size (and thus p) generates new entropy since the particles, which are topologically condensed on these sheets, can have entropy of order $\log(p)$.

New view about second law: second trial

The proposed new view about second law can be criticized of involving un-necessary assumptions about the details of dynamics. The real understanding of what second law inspired by TGD inspired theory of consciousness [K50] and zero energy ontology indeed allows to resolve the paradox without making this kind of assumptions.

The TGD inspired proposal is based on zero energy ontology and new view about the relationship between subjective and geometric time. In zero energy ontology causal diamonds (CD s) defined

as intersections of future and past light-cones of Minkowski space define basic building blocks of world of classical worlds. CD s are thought to have position in M^4 characterized by tips of the light-cones: this guarantees Poincare invariance broken for individual CD . The world of classical worlds is union of sub-worlds of classical worlds defined by space-time surfaces inside given CD . CD s also define a fractal structure: CD s within CD s are possible and the assumption that the temporal distance between tips comes in powers of 2 implies p-adic length scale hypothesis. The hypothesis assigns to elementary particles time scale. For electron this time scale is .1 seconds, which corresponds to 10 Hz biorhythm associated with living systems. p-Adic length scale $L(193) = 2.1$ cm corresponds to $T(193) = 2.4 \times 10^{11}$ years, which gives order of magnitude for the age of the Universe. $L(193) = 2.1$. $L(199) = 16.7$ cm (length scale defined by human brain) corresponds to $T(199) = 1.5 \times 10^{13}$ years which could be regarded as an upper bound for the age of the Universe. Maybe brain hemispheres correspond to cosmological CD .

In TGD inspired theory of consciousness CD s serve as correlates for selves and CD can be identified as perceptive field of self defining the contents of consciousness of self. One can understand the arrow of psychological time emerging as apparent arrow of geometric time [K6]. Also the localization of sensory mental experiences to a narrow time interval instead of entire CD can be understood using same argument. Memories are however distributed to entire CD and this leads to a new view about what memories are.

Consider now the argument.

- (a) It is *subjective* time with respect to which second law holds true. It corresponds to the geometric time of observer *only locally*.
- (b) One can apply second law only for to what happens inside 4-D causal diamond (CD) corresponding to the time scale of observations: in positive energy ontology second law is applied at fixed value of geometric time and this leads to problems. In cosmology the relevant CD extends from the moment of big bang and to the recent time or even farther to geometric future. The idea that entropy grows as a function of cosmic time is simply wrong if you accept zero energy ontology.

More concrete picture would look like follows.

- (a) In each quantum jump re-creating entire 4-D Universe the entire geometric *future* and *past* changes.
- (b) Initial state of big bang in geometric sense- the zero energy states associated with small CD s near the light-cone boundary corresponding to Big Bang- are replaced by a new one at every moment of subjective time. Hence the "subjectively recent" initial state of Big Bang can be assumed to have maximum entropy as also states after that when the time scale of observations (size of CD) is the age of the universe. Gradually the entire geometric past ends up to a maximum entropy state in time scales below the time scale characterizing the time scale of observations. Thermal equilibrium in 4-D sense rather than 3-D sense results and the paradox disappears.

Note that the breaking of strict classical determinism of Kähler action allowing CD s within CD s picture is essential mathematical prerequisite: otherwise this picture does not make sense. It makes possible also space-time correlates for quantum jump sequence rather than only for quantum states.

Vapor phase

The structure of $M^4_{\pm} \times CP_2$ suggests kinematic constraints on the cosmology: for the very small values of the M^4_{\pm} proper time a the allowed 3-surfaces are necessarily CP_2 type surfaces or string like objects rather than pieces of M^4 . As a consequence, topological evaporation should take place so that the space-time resembles enormous stringy diagram containing inside itself generalized Feynman diagram rather than continuous "classical" space-time. It indeed turns out that although the condensate could be present also in the primordial stage, the dominant contribution to the energy density is in the vapor phase during the primordial cosmology (and

as it turns out, also in recent cosmology unless one takes into account the fact that at each level of condensate cosmic expansion is only local!).

The properties of the critical cosmology suggest that space-time sheets representing critical sub-cosmologies are generated only after some value $a_0 \sim R$ of light cone proper time, where $R \sim 10^{3.5}$ Planck times corresponds is CP_2 time. Before this moment there would be no macroscopic space-time but only vapor phase consisting of cosmic strings containing topologically condensed fermions and having purely geometric contact interactions. Thus the idea about primordial cosmology as a stage preceding the formation of space-time in the sense of General Relativity seems to be correct in TGD framework.

The key object of the TGD inspired cosmology is cosmic string with string tension $T \simeq .2 \times 10^{-6}/G$ of same order as the string tension of the GUT strings but with totally different physical and geometric interpretation. Cosmic strings play a key role in the very early string dominated cosmology, they could generate the matter antimatter asymmetry, they would lead to the formation of the large voids and galaxies, they would give rise to the galactic dark matter and also dominate the mass density in the asymptotic cosmology. Vapor phase cosmic strings containing dark matter might be present also in the cosmology of later times and correspond closely to the vacuum energy density of inflationary cosmologies: now however dark matter rather than dark energy would be in question.

For critical cosmology the gravitational energy of the co-moving volume is proportional to a at the limit $a \rightarrow 0$ and vanishes so that 'Silent Whisper' amplifying to 'Big Bang' is in question. The assumption that also vapor phase gravitational energy density (that is density in imbedding space) behaves in similar manner implies the absence of initial singularities also at vapor phase level. Thus the condition

$$\rho \propto \frac{1}{a^2} , \quad (8.2.34)$$

and hence the string dominated primordial cosmology both in vapor phase and space-time sheets is an attractive hypothesis mathematically. The simplest hypothesis suggested by dimensional considerations is that the mass density of the vapor phase near $a = 0$ behaves as

$$\rho = n \frac{3}{8\pi G a^2} . \quad (8.2.35)$$

Here n is numerical factor of order one. This hypothesis fixes the total energy density of the universe and sets strong constraints on energetics of the cosmology. At later stages topological condensation of the strings reduces the mass density in vapor phase and replaces n by a decreasing function of a . A very attractive hypothesis is that the value of n is

$$n = 1 . \quad (8.2.36)$$

This gravitational energy density is same as that of critical cosmology at the limit of flatness and can be interpreted as TGD counterpart for the basic hypothesis of inflationary cosmologies. In inflationary cosmologies 70 per cent of the critical mass density is in form of vacuum energy deriving from cosmological constant. In TGD the counterpart of vacuum energy could be the mass density of cosmic strings in vapor phase in these sense that it topologically condensed on string like objects. By quantum classical correspondence it however corresponds to dark matter rather than genuine dark energy.

One can criticize the assumption as un-necessarily strong. There is no absolute necessity for the density of gravitational four-momentum of strings in M_+^4 to be conserved and one can consider

the possibility that zero inertial energy string pairs are created from vacuum everywhere inside future light cone.

Long range interactions in the vapor phase are generated only by the exchange of particle like 3-surfaces and the long range interactions mediated by the exchange of the boundary components are impossible. The exchange of CP_2 type vacuum extremals has geometric cross section and the same is expected to be true for the other exchanges of the particle like surfaces. This would mean that the interaction cross sections are determined by the size of the particle of the order of CP_2 radius: $\sigma \simeq l^2 \sim 10^8 G$. In this sense the asymptotic freedom of gauge theories would be realized in the vapor phase. It should be emphasized that this assumption might be wrong and that the gauge interactions between two particles belonging to vapor phase and condensate respectively are certainly present and topological condensation can be indeed seen as this interaction. It should be noticed that the expansion of the Universe in vapor phase is slower than in condensed phase: the ratio of the expansion rates of the universe in vapor and condensed phases is given by the velocity of light in the condensed phase ($c_{\#} = \sqrt{g_{aa}}$).

Also the cross sections for the purely geometric contact interactions of free cosmic strings are extremely low. This suggests that vapor phase is in essentially in temperature zero string dominated state and that the energy density of strings behaves as $1/a^2$.

Limiting temperature

Since particles are extended objects in TGD, one expects the existence of the limiting temperature T_H (Hagedorn temperature as it is called in string models) so that the primordial cosmology is in Hagedorn temperature. A special consequence is that the contribution of the light particles to the energy density becomes negligible: this is in accordance with the string dominance of the critical mass cosmology. The value of T_H is of order $T_H \sim \hbar/R$, where R is CP_2 radius of order $R \sim 10^{3.5} \sqrt{G}$ and thus considerably smaller than Planck temperature. Note that T_H increases with Planck constant and one can wonder whether this increase continues only up to $T_H = \hbar_{cr}/R = \sqrt{\hbar_{cr}/G}$, which corresponds to the critical value $\hbar_{cr} = R^2/G$. The value $R^2/G = 3 \times 20^{23} \hbar_0$ is consistent with p-adic mass calculations and is favored by by number theoretical arguments [K36, K5].

The existence of limiting temperature gives strong constraint to the value of the light cone proper time a_F when radiation dominance must have established itself in the critical cosmology which gave rise to our sub-cosmology. Before the moment of transition to hyperbolic cosmology critical cosmology is string dominated and the generation of negative energy virtual gravitons builds up gradually the huge energy density density, which can lead to gravitational collapse, splitting of the strings and establishment of thermal equilibrium with gradually rising temperature. This temperature cannot however become higher than Hagedorn temperature T_H , which serves thus as the highest possible temperature of the effectively radiation dominated cosmology following the critical period. The decay of the split strings generates elementary particles providing the seeds of galaxies.

If most strings decay to light particles then energy density is certainly of the form $1/a^4$ of radiation dominated cosmology. This is not the only manner to obtain effective radiation dominance. Part of the thermal energy goes to the kinetic energy of the vibrational motion of strings and energy density $\rho \propto 1/a^2$ cannot hold anymore. The strings of the condensate is expected to obey the scaling law $\rho \propto 1/a^4$, $p = \rho/3$ [E190]. The simulations with string networks suggest that the energy density of the string network behaves as $\rho \propto 1/a^{2(1+v^2)}$, where v^2 is the mean square velocity of the point of the string [E76]. Therefore, if the value of the mean square velocity approaches light velocity, effective radiation dominance results even when strings dominate [E154]. In radiation dominated cosmology the velocity of sound is $v = 1/\sqrt{3}$. When v lowers to sound velocity one obtains stationary cosmology which is string dominated.

An estimate for a_F is obtained from the requirement that the temperature of the radiation dominated cosmology, when extrapolated from its value $T_R \simeq .3\text{eV}$ at the time about $a_R \sim 3 \times 10^7$ years for the decoupling of radiation and matter to $a = a_F$ using the scaling law $T \propto 1/a$, corresponds to Hagedorn temperature. This gives

$$\begin{aligned}
 a_F &= a_R \frac{T_R}{T_H} \ , \\
 T_H &= \frac{n}{R} \ , \quad a_R \sim 3 \times 10^7 \text{ y} \ , \quad T_R = .27 \text{ eV} \ .
 \end{aligned}
 \tag{8.2.37}$$

This gives a rough estimate $a_F \sim 3 \times 10^{-10}$ seconds, which corresponds to length scale of order 7.7×10^{-2} meters. The value of a_F is quite large.

The result does not mean that radiation dominated sub-cosmologies might have not developed before $a = a_F$. In fact, entire series of critical sub-cosmologies could have developed to radiation dominated phase before the final one leading to our sub-cosmology is actually possible. The contribution of sub-cosmology i to the total energy density of recent cosmology is in the first approximation equal to the fraction $(a_F(i)/a_F)^4$. This ratio is multiplied by a ratio of numerical factors telling the number of effectively massless particle species present in the condensate if elementary particles dominate the mass density. If strings dominate the mass density (as expected) the numerical factor is absent.

For some reason the later critical cosmologies have not evolved to the radiation dominated phase. This might be due to the reduced density of cosmic strings in the vapor phase caused by the formation of the earlier cosmologies which does not allow sufficiently strong gravitational collapse to develop and implies that critical cosmology transforms directly to stationary cosmology without the intervening effectively radiation dominated phase. Indeed, condensed cosmic strings develop Kähler electric field compensating the huge positive Kähler action of free string and can survive the decay to light particles if they are not split. The density of split strings yielding light particles is presumably the proper parameter in this respect.

p-Adic length scale hypothesis allows rather predictive quantitative model for the series of sub-cosmologies [K72] predicting the number of them and allowing to estimate the moments of their birth, the durations of the critical periods and also the durations of radiation dominated phases. p-Adic length scale hypothesis allows also to estimate the maximum temperature achieved during the critical period: this temperature depends on the duration of the critical period a_1 as $T \sim n/a_1$, where n turns out to be of order 10^{30} . This means that if the duration of the critical period is long enough, transition to string dominated asymptotic cosmology occurs with the intervening decay of cosmic strings leading to the radiation dominated phase.

The existence of the limiting temperature has radical consequences concerning the properties of the very early cosmology. The contribution of a given massless particle to the energy density becomes constant. So, unless the number of the effectively massless particle families $N(a)$ increases too fast the contribution of the effectively massless particles to the energy density becomes negligible. The massive excitations of large size (string like objects) are indeed expected to become dominant in the mass density.

What about thermodynamical implications of dark matter hierarchy?

The previous discussion has not mentioned dark matter hierarchy labeled by increasing values of Planck constants and predicted macroscopic quantum coherence in arbitrarily long scales. In TGD Universe dark matter hierarchy means also a hierarchy of conscious entities with increasingly long span of memory and higher intelligence [K82, K26] .

This forces to ask whether the second law is really a fundamental law and whether it could reflect a wrong view about existence resulting when all these dark matter levels and information associated with conscious experiences at these levels is neglected. For instance, biological evolution difficult to understand in a universe obeying second law relies crucially on evolution as gradual progress in which sudden leaps occur as new dark matter levels emerge.

TGD inspired consciousness suggests that Second Law holds true only for the mental images of a given self (a system able to avoid bound state entanglement with environment [K82]) rather than being a universal physical law. Besides these mental images there is irreducible basic awareness of self and second law does not apply to it. Also the hierarchy of higher level

conscious entities is there. In this framework second law would basically reflect the exclusion of conscious observers from the physical model of the Universe.

8.2.5 Structure of WCW in zero energy ontology and Robertson-Walker cosmology

Zero energy ontology has meant a real quantum leap in the understanding of the exact structure of the world of classical worlds (WCW). There are however still open questions and interpretational problems. The following comments are about a quantal interpretation of Robertson-Walker cosmology provided by zero energy ontology.

- (a) The light-like 3-surfaces -or equivalently corresponding space-time sheets- inside a particular causal diamond (CD) is the basic structural unit of world of classical worlds (WCW). CD (or strictly speaking $CD \times CP_2$) is characterized by the positions of the tips for the intersection of the future and past directed light-cones defining it. The Lorentz invariant temporal distance a between the tips allows to characterize the CD s related by Lorentz boosts and $SO(3)$ acts as the isotropy group of a given CD . CD s with a given value of a are parameterized by Lobatchevski space -call it $L(a)$ - identifiable as $a^2 = constant$ hyperboloid of the future light-cone and having interpretation as a constant time slice in TGD inspired cosmology.
- (b) The moduli space for CD s characterized by a given value of a is $M^4 \times L(a)$. If one poses no restrictions on the values of a , the union of all CD s corresponds to $M^4 \times M_+^4$, where M_+^4 corresponds to the interior of future light-cone. F-theorist might get excited about dimension 12 for $M^4 \times M_+^4 \times CP_2$: this is of course just a numerical co-incidence.
- (c) p-Adic length scale hypothesis follows if it is assumed that a comes as octaves of CP_2 time scale: $a_n = 2^n T_{CP_2}$. For this option the moduli space would be discrete union $\cup_n M^4 \times L(a_n)$. A weaker condition would be that a comes as prime multiples of T_{CP_2} . In this case the preferred p-adic primes $p \simeq 2^n$ correspond to $a = a_n$ and would be natural winners in fight for survival. If continuum is allowed, p-adic length scale hypothesis must be a result of dynamics alone. Algebraic physics favors quantization at the level of moduli spaces.
- (d) Also unions of CD s are possible. The proposal has been that CD s form a fractal hierarchy in the sense that there are CD s within CD s but that CD s do not intersect. A more general option would allow also intersecting CD s.

Consider now the possible cosmological implications of this picture. In TGD framework Robertson-Walker cosmologies correspond to Lorentz invariant space-time surfaces in M_+^4 and the parameter a corresponds to cosmic time.

- (a) First some questions. Could Robertson Walker coordinates label CD s rather than points of space-time surface at deeper level? Does the parameter a labeling CD s really correspond to cosmic time? Do astrophysical objects correspond to sub- CD s?
- (b) An affirmative answer to these questions is consistent with classical causality since the observer identified as -say- upper boundary of CD receives classical positive/negative energy signals from sub- CD s arriving with a velocity not exceeding light-velocity. $M^4 \times L(a)$ decomposition provides also a more precise articulation of the answer to the question how the non-conservation of energy in cosmological scales can be consistent with Poincare invariance. Note also that the empirically favored sub-critical Robertson-Walker cosmologies are unavoidable in this framework whereas the understanding of sub-criticality is one of the fundamental open problems in General Relativity inspired cosmology.
- (c) What objections against this interpretation can one imagine?
 - i. Robertson-Walker cosmology reduces to future light-cone only at the limit of vanishing density of gravitational mass. One could however argue that the scaling factor of the metric of $L(a)$ need not be a^2 corresponding to M_+^4 but can be more general function of a . This would allow all Robertson-Walker cosmologies with sub-critical mass density. This argument makes sense also for $a = a_n$ option.

- ii. Lorentz invariant space-time surfaces in CD provide an elegant and highly predictive model for cosmology. Should one give up this model in favor of the proposed model? This need not to be the case. Quantum classical correspondence requires that also the quantum cosmology has a representation at space-time level.
- (d) What is then the physical interpretation for the density of gravitational mass in Robertson-Walker cosmology in the new framework? A given CD characterized by a point of $M^4 \times L(a)$, has certainly a finite gravitational mass identified as the mass assignable to positive/negative energy state at either upper or lower light-like boundary or CD . In zero energy ontology this mass is actually an average over a superposition of pairs of positive and negative energy states with varying energies. Since quantum TGD can be seen as square root of thermodynamics the resulting mass has only statistical meaning. One can assign a probability amplitude to CD as a wave function in $M^4 \times L(a)$ as a function of various quantum numbers. The cosmological density of gravitational mass would correspond to the quantum average of the mass density determined by this amplitude. Hence the quantum view about cosmology would be statistical as is also the view provided by standard cosmology.
- (e) Could cosmological time be really quantized as $a = a_n = 2^n T(CP_2)$? Note that other values of a are possible at the pages of the book like structure representing the generalized imbedding space since a scales as $r = \hbar/\hbar_0$ at these pages. All rational multiples of a_n are possible for the most general option. The quantization of a does not lead to any obvious contradiction since M^4 time would correspond to the time measured in laboratory and there is no clock keeping count about the flow of a and telling whether it is really discrete or continuous. It might be however possible to deduce experimental tests for this prediction since it holds true in all scales. Even for elementary particles the time scale a is macroscopic. For electron it is .1 seconds, which defines the fundamental bio-rhythm.
- (f) The quantization for a encourages also to consider the quantization for the space of Lorentz boosts characterized by $L(a)$ obtained by restricting the boosts to a subgroup of Lorentz group. A more concrete picture is obtained from the representation of $SL(2, C)$ as Möbius transformations of plane [A18] .
- i. The restriction to a discrete subgroup of Lorentz group $SL(2, C)$ is possible. This would allow an extremely rich structure. The most general discrete subgroup would be subgroup of $SL(2, Q_C)$, where Q_C could be any algebraic extension of complex rational numbers. In particular, discrete subgroups of rotation group and powers L^n of a basic Lorentz boost $L = \exp(\eta_0)$ to a motion with a fixed velocity $v_0 = \tanh(\eta_0)$ define lattice like structures in $L(a)$. This would effectively mean a cosmology in 4-D lattice. Note that everything is fully consistent with the basic symmetries.
 - ii. The alternative possibility is that all points of $L(a)$ are possible but that the probability amplitude is invariant under some discrete subgroup of $SL(2, Q_C)$. The first option could be seen as a special case of this.
 - iii. One can consider also the restriction to a discrete subgroup of $SL(2, R)$ known as Fuschian groups [A8] . This would mean a spontaneous breaking of Lorentz symmetry since only boosts in one particular direction would be allowed. The modular group $SL(2, Z)$ and its subgroups known as congruence subgroups [A19] define an especially interesting hierarchy of groups if this kind: the tessellations of hyperbolic plane provide a concrete representation for the resulting hyperbolic geometries.
 - iv. Is there any experimental support for these ideas. There are indeed claims for the quantization of cosmic recession velocities of quasars [E136] discussed in [K24] in terms of TGD inspired classical cosmology. For non-relativistic velocities this means that in a given direction there are objects for which corresponding Lorentz boosts are powers of a basic boost $\exp(\eta_0)$. The effect could be due to a restriction of allowed Lorentz boosts to a discrete subgroup or to the invariance of the cosmic wave function under this kind of subgroup. These effects should take place in all scales: in particle physics they could manifest themselves as a periodicity of production rates as a function of η closely related to the so called rapidity variable y .

- (g) The possibility of CD s would mean violent collisions of sub-cosmologies. One could consider a generalized form of Pauli exclusion principle denying the intersections.

This quantum view about cosmology will not be discussed further in this chapter most of which is written much before the emergence of zero energy ontology.

8.3 TGD inspired cosmology

Quantum criticality suggests strongly quantum critical fractal cosmology containing cosmologies inside cosmologies such that each sub-cosmology is critical before transition to hyperbolic phase. The general conceptual framework represented in the previous section give rather strong constraints on fractal cosmology. There are reasons to believe that the scenario to be represented, although by no means the final formulation, contains several essential features of what might be called TGD inspired cosmology.

Some remarks about interpretation are in order.

- (a) Equivalence Principle is assumed to hold true quite generally and the expression of gravitational four-momentum in terms of Einstein tensor is assumed to make sense in long length scales.
- (b) Robertson-Walker cosmology is taken as a statistical description replacing the many-sheeted space-time with single space-time sheet. The vanishing of density of inertial energy would be due to the smoothing out of the topological condensate of CP_2 type vacuum extremals and cosmic strings (carrying also these condensates) and giving to the inertial four-momentum a contribution expressible in terms of Einstein tensor in statistical description.
- (c) TGD inspired cosmology has the structure of Russian doll. Dark matters at various pages of the Big Book defined by the hierarchy of Planck constants defines one hierarchy of cosmologies. There is also a hierarchy of causal diamonds (CD s) defined as the intersection of future and past directed light-cones. Zero energy state associated with CD s could be interpreted as not so big bang followed by not so big crunch as the time scale of CD becomes long enough. In short time scales the interpretation would be in terms of particle reaction. Sub-cosmologies can be generated from vacuum spontaneously so that one has a p-adic hierarchy of cosmologies within cosmologies. If the size of CD is assumed to come as power of 2 as the geometry of CD suggests, p-adic length scale hypothesis follows.
- (d) The understanding of the non-conservation of gravitational energy associated with a co-moving volume has been a long standing issue in TGD. The conservation of four-momentum is an un-necessarily strong assumption in statistical description since in zero energy ontology four-momentum is conserved only inside causal diamond (CD). The rate for change of the gravitational energy in a given co-moving volume could be interpreted to reflect this statistical non-conservation. The original interpretation for the non-conservation of gravitational energy was in terms of topological evaporation and condensation of space-time sheets and cosmic strings carrying topological condensate of particles, and more generally, in terms of the transfer of energy between different space-time sheets. One cannot exclude the presence of also these mechanisms.

In the following discussion only a sub-cosmology associated with a given CD is discussed and the considerations assume that the time scale of observations is short as compared with the time scale of CD so that positive energy ontology is a good approximation.

8.3.1 Primordial cosmology

TGD inspired cosmology has primordial phase in which only vapor phase containing only cosmic strings containing topological condensate of fermions is present and lasting to $a \sim R$. During this period it is not possible to speak about space-time in the sense of General Relativity. The energy density and 'pressure' of cosmic strings in vapor phase (densities in $M_+^4 \times CP_2$ are assumed to be

$$\begin{aligned}\rho_V &= \frac{3}{8\pi G a^2} , \\ p &= -\frac{\rho}{3} .\end{aligned}\tag{8.3.1}$$

This assumption would mean that gravitational energy and various gravitational counterparts of the classical charges associated with the isometries of H are conserved during vapor phase period. This assumption guarantees consistency with the critical cosmology and by the requirement that the mass per co-moving volume vanishes at the limit $a \rightarrow 0$ so that the Universe is apparently created from nothing. The interactions between cosmic strings are pure contact interactions and extremely weak and it seems natural to assume that the temperature of the vapor phase is zero.

8.3.2 Critical phases

The mere finiteness of Kähler action does not allow vapor phase to endure indefinitely since the Kähler magnetic action of the free cosmic string is positive and infinite at the limit of infinite duration. The topological condensate of fermions necessarily present reduces this action. Second manner to reduce it is creation of space-time sheets at which cosmic strings condense on them and generate Kähler electric fields compensating the positive Kähler magnetic action. Individual cosmic string can however stay as free cosmic string for arbitrarily long time since the finite magnetic Kähler action can be compensated by the correspondingly larger electric Kähler action. In principle cosmic strings can be created as pairs of positive and negative inertial energy cosmic strings from vacuum in vapor phase.

In accordance with this primordial phase is followed by the generation of critical cosmologies as 'Silent Whispers' amplifying to 'Big Bangs' basically by emission of ordinary matter by Hawking radiation, and possibly by gravitational heating made possible by the emission of negative energy virtual gravitons as "acceleration radiation" as matter gains strong inertial energies in gravitational fields. p-Adic length scale hypothesis allows to deduce estimates for the typical time for the creation of a critical cosmology, the duration of the critical phase, the temperature achieved during the critical phase and the duration of the hyperbolic expanding phase possibly following it and transforming to a phase in which cosmic expansion ceases and space-time surface behaves like a particle.

What is of extreme importance is that the deceleration parameter q associated with critical and over-critical cosmologies is negative. It is given by

$$q = -K_0 \frac{K_0 u^2}{1 - u^2 - K_0} < 0 , \quad u = a/a_1 ,\tag{8.3.2}$$

where K_0 and a_1 are the parameters appearing in $g_{aa} = 1 - K$, $K = K_0/(1 - u^2)$.

The rate of change for Hubble constant is

$$\frac{dH/ds}{H^2} = -(1 + q) ,\tag{8.3.3}$$

so that one must have $q < -1$ in order to have acceleration. This holds true for $a > \sqrt{(1 - K_0)/(1 + K_0)} a_1$. This allows to understand the recently discovered acceleration of late cosmology as assignable to a quantum critical phase transition increasing cosmological constant and thus leading to an increase of the size of the large void.

This model is discussed in detail in [K24] and shown to explain the observed jerk about 13 billion years changing deceleration to acceleration. The recently observed cold spot in cosmic

microwave background [E1] can be understood as a presence of large void with size of about 10^8 ly already about 10^{10} years ago. This conforms with the hypothesis that large voids increase their size in phase transition like manner rather than participating in cosmic expansion in continuous manner.

8.3.3 Radiation dominated phases

p-Adic length scale hypothesis suggests that the typical moments of birth $a_0(k)$ and durations $a_1(k)$ for the critical cosmologies satisfy $a_0(k) \sim L(k)$ and $a_1(k) \sim L(k)$, where k prime or power of prime, $L(k) = l \times 2^{k/2}$, $l = R \simeq 10^{3.5}$ Planck lengths, and n is a numerical factor. p-Adic length scale hypothesis suggest that the temperature just after the transition to the effectively radiation dominated phase is

$$\begin{aligned} T(k) &= \frac{n}{L(k)} \quad , \quad \text{for } k > k_{cr} \quad , \\ T(k) &= T_H \sim \frac{1}{R} \quad , \quad \text{for } k \leq k_{cr} \quad . \end{aligned} \tag{8.3.4}$$

Here n is rather large numerical factor. Since $a_F \sim 2.7 \times 10^{-10}$ seconds which corresponds to length scale $L \simeq .08$ meters roughly to p-adic length scale $L(197) \simeq .08$ meters (which by the way corresponds to the largest p-adic length scale associated with brain, a cosmic joke?!), should correspond to the establishment of Hagedorn temperature, one has the conditions

$$\begin{aligned} k_{cr} &= 197 \quad , \\ n &\simeq 2^{197/2} \sim 10^{30} \sim \frac{m_{CP_2}^2}{m_p^2} \quad . \end{aligned}$$

Thus n is in of same order of magnitude as the ratio of the CP_2 mass squared ($m_{CP_2} \simeq 10^{-3.5}$ Planck masses) to proton mass squared.

Dimensional considerations suggest also that the energy density in the beginning of the radiation dominated phase (in case that it is achieved) is

$$\rho = nT^4(k) \quad , \tag{8.3.5}$$

where n a numerical factor of order one. n does not count for the number of light particle species since the thermal energy of strings could give rise to the effective radiation dominance. Furthermore, if ordinary matter is created by Hawking radiation and by radiation generated by the ends of split strings, the large mass and Hagedorn temperature as a limiting temperature could make impossible the generation of particle genera higher the three lowest ones (see [K21] for the argument why $g > 2$ particle families (g denotes the genus of partonic 2-surface) have ultra heavy masses). Thus it seems that the infinite number of fermion families cannot lead to an infinite density of thermal energy and why their presence leaves no trace in present day cosmology.

When the time parameter a_1 of the critical cosmology grows too large, it cannot anymore generate radiation dominated phase since the temperature remains too low. Previous considerations suggest that the maximum value of a_1 is roughly $a_1(max) = a_F \sim 3 \times 10^{-10}$. After this critical sub-cosmologies would transform directly to the stationary cosmologies.

Radiation dominated phase transforms to matter dominated phase and possibly decomposes to disjoint 3-surfaces with size of order horizon size at the same time. p-Adic length scale hypothesis suggests that the duration of the radiation dominated phase with respect to the proper time of the space-time sheet is or order

$$s_2 \equiv \int_{a_1}^{a_1+a_2} \sqrt{g_{aa}} da \sim L(k) . \quad (8.3.6)$$

In case of 'our' radiation dominated cosmology this gives correct estimate for the moment of time when transition to matter dominated phase occurs since one has $L(k) \sim a_F$ in this case.

That the decomposition to disjoint 3-surfaces occurs after the transition to matter dominated phase is suggested by simple arguments. First of all, the decomposition into regions has obviously interpretation as a formation of visible structures around hidden structures formed by pairs of cosmic strings thickened to magnetic flux tubes. Secondly, of decomposition occurs, the photons coming from distant objects 'drop' to the space-time sheets representing later critical cosmologies. This explains why the optical properties of the Universe seem to be those of a critical cosmology.

8.3.4 Matter dominated phases

The transition to the matter dominated phase followed by the decoupling of the radiation and matter makes possible the formation of structures. This is expected to involve compression of matter to dense regions and to lead to at least a temporary decomposition of the matter dominated cosmology to disjoint 3-surfaces condensed on larger space-time surfaces. The reason is that Jeans length becomes smaller than the size of the horizon. A galaxy model based on the assumption that the region around the two curved ends of a split cosmic string serve as a seed for galaxy formation has been considered in [K24] . In particular, it was found that Jeans criterion leads to a lower bound for the string tension of the galactic strings of same order of magnitude as the string tension of the cosmic strings.

If one assumes that matter dominated regions continue cosmological expansion so that the radius of region equals to the horizon size $R = a^{1/2}$, the fraction of the volume occupied by matter dominated regions grows as $\epsilon(a) = (a/a_R)\epsilon(a_R)$. In recent cosmology the regions have joined together for $\epsilon(a_R) > 10^{-3}$ which would suggest that ultimately asymptotic string dominated cosmology results. One could however argue that matter dominated cosmology does not expand. Taking into account the horizon size of about 5×10^5 light years at the time of the transition to matter dominance, this would mean that galaxies do not participate in cosmic expansion but move as particles on background cosmology.

TGD allows an entire sequence of matter dominated cosmologies associated with the radiation dominated cosmologies labeled by p-adic primes allowed by p-adic length scale hypothesis. Forgetting the delicacies related to nucleo-synthesis, the matter densities associated with these matter dominated cosmologies are scaled down like $(a_1(k)/a_F)^3$ where $a_1(k) \sin L(k)$ is the moment at which the corresponding critical cosmology was created. Thus the latest matter dominated cosmology gives the dominating contribution to the matter density.

Sooner or later matter dominated cosmology becomes string dominated. A good guess is that the transition to string dominance occurs if cosmic expansion of the space-time sheet indeed continues. To see what is involved consider the bounds on the total length of string per large void with size of order $a_* \sim 10^8$ light years. This length can be parameterized as $L = nL(\text{void})$. The requirement that the mass density of the strings is below the critical density gives, when applied to the large void with size of $a_* \simeq 10^8$ light years at recent time a , gives

$$\frac{3}{4\pi} \frac{nT}{a_*^2} < \rho_s = \frac{3}{8\pi G a^2} . \quad (8.3.7)$$

Here one has $T \simeq .22 \times 10^{-6} \frac{1}{G}$. This gives roughly

$$n < 2 \times 10^6 \times \left(\frac{a_*}{a}\right)^2 . \quad (8.3.8)$$

The second constraint is obtained from the requirement that the ratio of the string mass per void to the mass of the ordinary matter per void is not too large at present time. Using the expression

$$\rho_m \simeq \frac{3}{32\pi G} \frac{a_*}{a^3} ,$$

with $a_* \sim 10^8$ years (time of recombination) and the expression for the string mass per void one has

$$\frac{\rho_s(a)}{\rho_m a(a)} = n \times 1.8 \times 10^{-6} \left(\frac{a}{a_*}\right)^3 . \quad (8.3.9)$$

for the ratio of the densities. For $a = 10^{10+1/2}$ ly the two conditions give

$$\begin{aligned} n &< 20 , \\ \frac{\rho_s(a)}{\rho_m} &\simeq n \times 18 \times \sqrt{10} . \end{aligned} \quad (8.3.10)$$

These equations suggest that n cannot be much larger than one and suggest the simple picture in which the Kähler charges associated with the “big” string in the interior of the large void and with the galactic strings on the boundaries of the void cancel each other. The minimal value of n is clearly $n = 4$ corresponding to a straight string in the interior of the void. It must be however emphasized that these estimates are rough.

The rate $d\log(E_{gr})/d\log(a)$ for the change of gravitational energy in co-moving volume at present moment in the matter dominated cosmology is determined by

$$\frac{(d\rho_c/da)}{\rho_c} = -\frac{1}{2a} \sim 10^{-11} \frac{1}{year} . \quad (8.3.11)$$

The rate is of the same order of magnitude as the rate of energy production in Sun [E193] so that the rates dE_{I+}/da and dE_{I-}/da for the change of positive and negative contributions to the inertial energy would be of same order of magnitude and sum up to dE_{gr}/da .

8.3.5 Stationary cosmology

The original term was asymptotic cosmology but stationary cosmology is a better choice if one accepts the notion of quantal cosmology. In this kind of situation expects that stationary cosmologies correspond to stationary quantum states during which topologically condensed space-time sheets do not participate the cosmic expansion but co-move as point like particles.

During stationary cosmology one has $dE_{gr}/da = 0$. In zero energy ontology the interpretation is that the apparent non-conservation of gravitational (=inertial) energy due to the change of time scale characterizing typical causal diamond (CD) is not present anymore. The following argument suggests that asymptotic cosmology is equivalent with the assumption that the cosmic expansion of the space-time sheets almost halts. The expression for the horizon radius for the cosmology decomposing into critical, radiation and matter dominated and asymptotic phases. The expression for the radius reads as

$$R = \int_0^a \sqrt{g_{aa}} \frac{da}{a} = R_0 + R_{as} ,$$

where R_0 corresponds from the cosmology before the transition to the asymptotic cosmology and R_{as} gives the contribution after that. Formally this expression is infinite since the contribution to R_{as} from the critical period is infinite. Since one has $g_{aa} \rightarrow 1$ asymptotically R_{as} is in good approximation equal to $R_{as} = \log(a/a_{as})$, where a_{as} denotes the time for the transition to asymptotic cosmology. This means that the growth of the horizon radius becomes logarithmically slow: $dR(a)/da = 1/a$. A possible interpretation is that the sizes of various structures during asymptotic cosmology are almost frozen. One can however consider the possibility that the disjoint structures formed during the period of matter dominated phase expand and fuse together so that there is basically single structure of infinite size formed by the join along boundaries condensate of various matter carrying regions.

From the known estimates [E197] for the total length of galactic string per void one obtains estimate for the needed string tension of the galactic strings. The resulting string tension is indeed of the order of GUT string tension $T \sim 10^{-6}/G$. It will be found later that Jeans criterion gives same lower bound for the string tension of the galactic strings. The resulting contribution to the mass density is smaller than the critical mass density so that no inconsistencies result.

The simplest mechanism generating galactic strings is the splitting of long strings to pieces resulting from the collisions of the strings during very early string dominated cosmology. This mechanism implies that galaxies should form linear structures: this seems indeed to be the case [E197].

The recent mass density of the strings is considerably larger than that associated with the visible matter. This implies string dominance sooner or later. There are two possible alternatives for the string dominated cosmology.

- (a) Cosmology with co-moving strings.
- (b) Stationary cosmology, which seems a natural candidate for the asymptotic cosmology.

Consider first the co-moving string dominated cosmology. The mass density for the string dominated Robertson-Walker cosmology (necessarily smaller than critical density now) is given by the expression

$$\begin{aligned} \rho &= \frac{3}{8\pi G a^2} \left(\frac{1}{K} - 1 \right) , \\ H^2 &= \frac{1}{K a^2} , \end{aligned} \tag{8.3.12}$$

and is a considerable fraction of the critical mass density unless the parameter K happens to be very close to 1. Sub-criticality gives the condition

$$c_{\#} = \sqrt{K} > \frac{1}{\sqrt{2}} .$$

The requirement that the gravitational force dominates over the Kähler force implies that the value of $g_{aa} = K$ differs considerably from unity. The recent value of the quantity $K a^2$ can be evaluated from the known value of the Hubble constant. By the previous argument, the ratio of the string mass density to the matter mass density for the recent time $a \sim 10^{10+1/2}$ years is about $\rho_s/\rho_m \sim 50$. This gives the estimates for the light velocity in the condensate and the ratio of the density to the critical density

$$\begin{aligned} c_{\#} &= \sqrt{K} \simeq .93 , \\ \Omega \equiv \frac{\rho}{\rho_{cr}} &\simeq .16 . \end{aligned} \tag{8.3.13}$$

One also obtains an estimate for the time a_1 , when the transition to string dominated phase has occurred

$$\begin{aligned}
\rho_{m0} &= \rho_m \left(\frac{a}{a_1}\right)^3 = \rho_s = \rho_{s0} \left(\frac{a}{a_1}\right)^2 , \\
a_1 &= \frac{\rho_m}{\rho_s} a \sim 6 \times 10^8 \text{ ly} .
\end{aligned} \tag{8.3.14}$$

The fraction of the total mass density about the critical mass density is about 4 per cent and perhaps two small.

Consider next the stationary cosmology. The relevant component of the metric and mass density are given by the expressions

$$\begin{aligned}
g_{aa} &= \frac{(1-2x)}{(1-x)} , \\
\rho &= \frac{3}{8\pi G a^2} \frac{x}{(1-2x)} , \\
x &= \left(\frac{a_1}{a}\right)^{2/3} .
\end{aligned} \tag{8.3.15}$$

Asymptotically the mass density for this cosmology behaves as $\rho \simeq 1/a^{2(1+v^2)}$, $v^2 = 1/3$ and "pressure" ($p \simeq -1/9\rho$) is negative indicating that strings indeed dominate the mass density. The results from the numerical simulation of the GUT cosmic strings suggest the interpretation of v^2 as mean square velocity for a long string [E76] : the relative velocities of the big strings seem rather large.

The transition to the stationary cosmology must take place at some finite time since the energy density

$$\rho = \frac{3}{8\pi G a^2} \frac{\left(\frac{a_1}{a}\right)^{2/3}}{\left(1 - 2\left(\frac{a_1}{a}\right)^{2/3}\right)} , \tag{8.3.16}$$

is negative, when the condition $a < a_1(1/2)^{-3/2}$ holds true. An estimate for the parameter a_1 is obtained by requiring that the ratio of the mass density to the recent density of the ordinary matter is of order $r \sim 200$ at time $a \sim 10^{10.5}$ ly (this requires $n = 4$, which corresponds to the lower bound for the length of cosmic string per void): $\frac{\rho}{\rho_m}(a) = r$. This gives for the parameter x , the time parameter a_1 , the velocity of light in the condensate and for the fraction of the mass density about the critical mass density the following estimates:

$$\begin{aligned}
x &= \frac{\frac{r}{4} \frac{a_*}{a}}{1 + \frac{r}{2} \frac{a_*}{a}} \simeq .16 , \\
a_1 &\simeq 2 \times 10^9 \text{ ly} , \\
c_{\#} &\simeq .93 , \\
\Omega &\simeq .16 .
\end{aligned} \tag{8.3.17}$$

Apart from the value of the transition time, the results are essentially the same as for the string dominated cosmology. By increasing the amount of a string per void one could reduce the value of the light velocity in the condensate. The experimental lower bound on Ω is $\Omega > .016$ and the favored value is $\Omega \sim .3$. The latter value would require $n \simeq 6.8$ instead of the lower bound $n = 4$ and give $c_{\#} \simeq .87$

If the proposed physical interpretation for dE_{gr}/da in terms of the energy production inside the stars is correct, then stationary cosmology should be a good idealization for the cosmology

provided that the rate of the energy production of stars is negligibly small as compared with the total energy density. This is expected to case, when the energy density of the string like objects begins to dominate over the ordinary matter.

String dominated and stationary cosmologies have certain common characteristic features:

- (a) Horizons are absent. This implies that the formation of the structures of arbitrarily large size should be possible at this stage and in certain sense the formation of these structures can be regarded as a manifestation of the structures already formed during the very early string dominated cosmology.
- (b) The so called acceleration parameter q_0 vanishes asymptotically for the stationary cosmology and identically for string dominated cosmology: The deceleration parameter

$$q = \frac{1}{3} \frac{x}{(1-2x)(1-x)} . \quad (8.3.18)$$

The value of q is positive and conforms with the identification of stationary cosmology as counterpart of stationary state in which topologically condensed space-time sheets co-move but do not expand.

For the matter dominated cosmology the value of this parameter is $q_0 = 1/2$ and positive ($a \simeq t^{2/3}$). The earlier attempts made to evaluate the value of this parameter from the observations are consistent with the value $q_0 = 0$ as well as with the value $q_0 = 1/2$ [E193]. Quite recent determinations of the parameter [E130] are consistent with $q_0 \leq 0$ but exclude large negative values of q_0 typical for the inflationary scenarios with a large value of the cosmological constant.

8.4 Inflationary cosmology or quantum critical cosmology?

The measurements [E181] allow to deduce information about the curvature properties of the space-time in cosmological scales. These experimental findings force the conclusion that cosmological time= constant sections are essentially flat after the decoupling of the em radiation from matter which occurred roughly one half million years after the Big Bang. The findings allowed to build a much more detailed model for the many-sheeted cosmology leading also to a considerable increase in the understanding of the general principles of TGD inspired cosmology. In the following the observational facts are discussed first and then TGD based explanation relying on the many-sheeted cosmology is briefly discussed. One ends up to a cosmological realization of quantum criticality in terms of a fractal cosmology having Russian doll like structure. The cosmologies within cosmologies are critical cosmologies before transition to hyperbolicity followed by an eventual decay to disjoint non-expanding 3-surfaces.

Critical cosmologies can be regarded as 'Silent Whispers' amplifying to Big Bangs and are generated from vacuum by the gradual condensation of cosmic strings to initially empty and flat space-time sheets. The transition to hyperbolicity involves topological condensation of the remnants of the earlier sub-cosmologies. Hyperbolic period is followed by a decay to disjoint non-expanding 3-surfaces, remnants of the sub-cosmology. There is thus a strong analogy with biological evolution involving growth, metabolism and death. Sub-cosmologies are characterized by three parameters: moment of birth and durations of the critical period and hyperbolic periods. p-Adic length scale hypothesis makes model quantitative by providing estimates for the moments of cosmic time when the phase transitions generating new critical sub-cosmologies occur and fixes the number of the phase transitions already occurred. What is especially remarkable, that the time for the generation of CMB is predicted correctly from p-adic fractality and from the absence of the second acoustic peak in the spectrum of CMB fluctuations.

The recent measurements [E181] allow to deduce information about the curvature properties of the space-time in cosmological scales. The conclusion is that cosmological time= constant sections are essentially flat after the decoupling of the em radiation from matter which occurred roughly one half million years after the Big Bang. This forces to consider a more detailed model

for the many-sheeted cosmology provided by TGD. In the following the observational facts are discussed first and then TGD based explanation relying on the many-sheeted cosmology is discussed. One ends up to a cosmological realization of quantum criticality in terms of a fractal cosmology having Russian doll like structure. The cosmologies within cosmologies are critical cosmologies before transition to hyperbolicity followed by an eventual decay to disjoint non-expanding 3-surfaces.

Critical cosmologies can be regarded as 'Silent Whispers' amplifying to Big Bangs and are generated from vacuum by the gradual condensation of cosmic strings to initially empty and flat space-time sheets. The transition to hyperbolicity involves topological condensation of the remnants of the earlier sub-cosmologies. Hyperbolic period is followed by a decay to disjoint non-expanding 3-surfaces, remnants of the sub-cosmology. There is thus a strong analogy with biological evolution involving growth, metabolism and death. Sub-cosmologies are characterized by three parameters: moment of birth and durations of the critical period and hyperbolic periods. p-Adic length scale hypothesis makes model quantitative and gives estimate for the moments of cosmic time when the phase transitions generating new critical sub-cosmologies occur and fixes the number of the phase transitions already occurred. The time for the generation of CMB is predicted correctly from p-adic fractality and from the absence of the second acoustic peak in the spectrum of CMB fluctuations.

It must be emphasized that in TGD framework critical cosmology reflects quantum criticality and the presence of two kinds of two-dimensional conformal symmetries acting at the level of imbedding space and space-time [K19]. Thus the correlation function for the fluctuations of the mass density at the surface of a sphere of fixed radius is dictated by conformal invariance and by quantal effects the naive scaling dimension predicted by the scaling invariance can be modified to an anomalous dimension. The implications of replacing scaling invariance with conformal invariance for the correlation function of density fluctuations is discussed at the general level in [E151].

8.4.1 Comparison with inflationary cosmology

TGD differs from GRT in several respects. Many-sheeted space-time concept forces fractal cosmology containing cosmologies within cosmologies. A p-adic hierarchy of long ranged electro-weak and color physics assignable to dark matter at various space-time sheets is predicted if one interprets the unavoidable long ranged classical gauge fields as space-time correlates of corresponding quantum fields. Confinement (weak) length scales associated with these physics correspond to p-adic length scales characterizing the sizes of the space-time sheets of corresponding hadrons (weak bosons). Topological condensation involves a formation of # contacts identifiable as parton- antiparton pairs defining a particular instance of dark matter. Infinite variety of dark matters, or more precisely partially dark matters with respect to each other, is predicted.

Z^0 force competes with gravitational force and it will be found that the role of this force seems to be crucial in understanding the formation of the observed large void regions (with recent size of order 10^8 light years) containing ordinary matter predominantly on their boundaries. Einstein's equations provide only special solutions of the field equations for the length scale dependent space-time of TGD. For instance, in case of strongly Kähler charged cosmic strings it seems better to regard the strings as sources of the Kähler electric field rather than gravitational field. Vapor phase containing at least cosmic strings is the crucial element of TGD inspired cosmology.

The proposed scenario for cosmology deserves a comparison with the inflationary scenarios [E148, E66].

- (a) In inflationary cosmologies exponentially expanding phase corresponds to a symmetry non-broken phase and de-Sitter cosmology follows from the vacuum energy density for the Higgs field. The vacuum energy of the Higgs field creates "negative pressure" giving rise to the exponential expansion. The string tension of the topologically condensed cosmic strings creates the "negative pressure" in TGD context.

In TGD framework situation is diametric opposite of this since exponential expansion is replaced by a logarithmic expansion. This can be seen by solving proper time t in terms of M_+^4 proper time a from the equation

$$\frac{dt}{da} = \sqrt{g_{aa}} = \sqrt{1 - \frac{R^2 k^2}{4} \frac{1}{1 - k^2 a^2}}. \quad (8.4.1)$$

One obtains

$$kt = \int^{\sinh(ka)} du \sqrt{\cosh^2(u) - \frac{R^2 k^2}{4}} \simeq \sinh(ka) \quad (8.4.2)$$

since $R^2 k^2 \ll 1$ holds true. This gives $kt \sim \sinh(ka) \sim \exp(ka)$ rather than $a \sim \exp(Ht)$ as in inflationary scenarios so that expansion takes place with a logarithmic slowness.

- (b) In the inflationary scenarios the exponential expansion destroys inhomogenities and implies the isotropy of 3 K radiation and the decay of the Higgs field to radiation creates entropy. In TGD string dominance implies the absence of horizons. There are no horizons associated with the vapor phase neither since it obeys light cone cosmology. Also critical, string dominated and asymptotic cosmologies are horizon free.
- (c) In inflationary scenarios the transition to the radiation dominated phase corresponds to the transition from the symmetric phase to a symmetry broken phase. In TGD something analogous happens. Cosmic strings are free at primordial stage but unstable against decay to elementary particles because their action has wrong sign. Some of these strings achieve stability by topologically condensing and generating large Kähler electric charge to cancel their Kähler magnetic action. Light particles of matter in turn suffer a gradual condensation around Kähler electric strings. The Kähler charge of the string induces automatically a slight matter-antimatter asymmetry in the exterior space-time. Or vice versa: the surrounding vacuum extremal must suffer a slight deformation to non-vacuum extremal and this requires Kähler electric field and simplest field of this kind is radial one forcing cosmic string to generate small Kähler charge. At the limit $a \rightarrow 0$ the contribution of the condensate to the energy of a given co-moving volume vanishes and in this sense condensate can be regarded as a seed of the symmetry broken phase.
- (d) In inflationary scenarios the critical mass density is reached from above and final state corresponds to a cosmology with a critical mass density. In TGD scenario in its simplest form, the mass density is exactly critical before the transition to the "radiation dominated phase" and overcritical mass density resides in the vapor phase. In a well defined sense vapor phase makes possible sub-critical cosmology. The mysterious vacuum energy density of the inflationary cosmologies could correspond in TGD framework to the dark matter density at cosmic strings part of which could be in vapor phase.

8.4.2 Balloon measurements of the cosmic microwave background favor flat cosmos

Inflationary scenario has been one of the dominating candidates for cosmology. The basic prediction of the inflationary cosmology is criticality of the mass density which means that cosmic time=constant sections are flat. Observations about the density of known forms of matter are not consistent with this and the only possible manner to get critical mass density is to assume that there exist some hitherto unknown form of vacuum energy density contributing roughly 70 percent to the energy density of the universe. This vacuum energy density is believed to cause the observed acceleration of the cosmic expansion.

The basic geometrical prediction of the inflationary scenario is that cosmic time=constant sections are flat Euclidian 3-spaces. This prediction has been now tested experimentally and it seems that the predictions are consistent with the observations. The test is based on the study of non-uniformities of the cosmic microwave background (CMB). CMB was created about half

million years after the moment of Big Bang when opaque plasma of electrons and ions coalesced into transparent gas of neutral hydrogen and helium. Thermal photons decoupled from matter to form cosmic microwave background and have been propagating practically freely after that. The fluctuations of the temperature of the cosmic microwave background reflect the density fluctuations of the universe at the time when this transition occurred. The prediction is that the relative fluctuations of temperature are proportional to the relative fluctuations of mass density and are few parts to 10^5 .

Happily, it is possible to estimate the size spectrum for the regions of unusually high and low density theoretically and compare the predictions with the experimentally determined distribution of hot and cold spots in CMB. Since the light from hot and cold spots propagates through the intervening curved space, its intrinsic geometry reflects itself in the properties of the observed spectrum of CMB fluctuations. Hence it becomes possible to experimentally determine whether the 3-space (cosmic time=constant section) is negatively curved (expansion forever), positively curved and closed (big crunch) or flat.

The acoustic properties of the plasma help in the task of determining the spectrum of CMB fluctuations. The competition between gravity and radiation pressure during radiation dominated period produced regions of slow, attenuated oscillatory contraction and expansion. The maximum size of over-dense region that could have shrunk coherently during the half million years before the plasma became transparent was limited by the velocity of sound which is $c/\sqrt{3}$ in radiation dominated plasma. This gives $R = 5/\sqrt{3} \times 10^5$ light years which is about 300 thousand light years for the maximal size of the hot spot. The observed position and size of the first acoustic peak corresponding to the largest hot spots and its observed position depends on the presence or absence of the distorting cosmic curvature. If the intervening 3-space is positively (negatively) curved the parallel rays coming from hot spot diverge and hot spots look larger (smaller) than they actually are: also distances between hot spots look larger (smaller).

To abstract cosmological details from the observations one calculates the power spectrum of the thermal fluctuations by fitting the CMB temperature map to a spherical harmonic series. The absolute square of the fitted amplitude for l :th order spherical-harmonic component is essentially the mean-square point-to-point temperature fluctuation of the CMB on angular scale about π/l radians. The observed fluctuation power spectrum as function of l has maximum at $l = 200$. This is consistent with flat intervening 3-space and inflationary scenario. The next maximum of power spectrum as function of l corresponds to the second acoustic peak (recall that acoustic oscillations are in question) with smaller size of hot spot and should be observed at $l = 500$ according to inflationary scenario. In fact this peak has not been observed. This might be due to the small statistics or due to the fact that the scale free prediction of the inflationary scenario for the spectrum of fluctuations is quite not correct but that fluctuations have cutoff at some length scale larger than the size of the size of the hot spot associated with the second acoustic peak.

In standard cosmology the result means that 3-space has remained flat for most of the time after the moment when CMB was generated. Of course, the cosmology can have changed hyperbolic after that since the small mass density of the recent day universe implies that the effects of the curvature on the optical properties of the universe are small. Inflationary scenario predicts this if one repeats the biggest blunder of Einstein's life by adding to Einstein's equations cosmological constant, which means that vacuum energy density of an unknown origin contributes about 70 per cent to the mass density of the universe. Besides this one must assume that primordial baryon density is about 50 per cent higher than standard expectation. Thus inflationary model survives the test but not gracefully.

8.4.3 Quantum critical fractal cosmology as TGD counterpart of the inflationary cosmology

In TGD framework Einstein's equations are structural equations relating the energy momentum tensor of topologically condensed matter to the geometry of the space-time surface rather than fundamental equations derivable from a variational principle. Furthermore, the solutions of Einstein's equations are only a special case of the equations characterizing the macroscopic limit

of the theory. The simplest assumption is however that Einstein's equations hold true for each sheet of the many-sheeted space-time and is made in TGD inspired cosmology.

Does quantum criticality of TGD imply criticality and fractality of TGD based cosmology?

Quantum criticality of the TGD Universe supports the view that many-sheeted cosmology is in some sense critical. Criticality in turn suggests p-adic fractality. Phase transitions, in particular the topological phase transitions giving rise to new space-time sheets, are (quantum) critical phenomena involving no scales. If the curvature of the 3-space does not vanish, it defines scale: hence the flatness of the cosmic time=constant section of the cosmology implied by the criticality is consistent with the scale invariance of the critical phenomena. This motivates the assumption that the new space-time sheets created in topological phase transitions are in good approximation modelable as critical Robertson-Walker cosmologies for some period of time at least.

Neither inflationary cosmologies nor overcritical cosmologies allow global imbeddings. TGD however allows the imbedding of a one-parameter family of critical and overcritical cosmologies. Imbedding is possible for some critical duration of time. The parameter labeling these cosmologies is a scale factor characterizing the duration of the critical period. The infinite size of the horizon for the imbeddable critical cosmologies is in accordance with the presence of arbitrarily long range fluctuations at criticality and guarantees the average isotropy of the cosmology. These cosmologies have the same optical properties as inflationary cosmologies.

The critical cosmologies can be used as a building blocks of a fractal cosmology containing cosmologies containing ... cosmologies. p-Adic length scale hypothesis allows a quantitative formulation of the fractality. Fractal cosmology provides explanation for the balloon experiments and also for the paradoxical result that the observed density of the matter is much lower than the critical density associated with the largest space-time sheet of the fractal cosmology. Also the observation that some astrophysical objects seem to be older than the Universe, finds a nice explanation.

Cosmic strings and vapor phase

An essential element of TGD inspired cosmology is the presence of vapor phase consisting dominantly of cosmic strings. For the values of light cone proper time a smaller than CP_2 time R , space-time does not exist in sense as it is defined in General Relativity. Instead, very early Universe consists of a primordial soup of cosmic strings. General arguments lead to the hypothesis that the density of the cosmic strings in vapor phase in this period is

$$\rho_V = \frac{3}{8\pi G a^2} . \quad (8.4.3)$$

The expression of the density is formally same as the critical density of flat critical cosmology (note that future light cone is hyperbolic vacuum cosmology). The topological condensation of free cosmic strings forced by the absolute minimization of Kähler action (free cosmic strings have infinite positive Kähler magnetic action) to critical space-time sheets leads to fractal hierarchy of critical cosmologies and reduces the density of vapor phase. Obviously the energy density in vapor phase is very much analogous to the vacuum energy density needed in inflationary cosmologies.

What happens when criticality becomes impossible?

Given critical sub-cosmology is created at the moment $a = a_0$ of the light cone proper time. The imbeddability of the critical cosmology fails for $a = a_1$. The question is what happens for the space-time sheet before this occurs. A natural assumption is that when the value of the

cosmic time for which imbeddability fails is approached, cosmology is transformed to hyperbolic cosmology. One can imagine several scenarios but the following one involving two transitions is the most plausible one. The first step is the transition of the critical cosmology to a hyperbolic cosmology which is either matter or radiation dominated or to a stationary cosmology for which gravitational energy density is conserved. The next step is possible decomposition of $a = \text{constant}$ 3-surface of hyperbolic cosmology to disjoint non-expanding 3-surfaces topologically condensing on critical cosmology created later. This process in turn could induce the transition of the critical cosmology to hyperbolicity: when critical sub-cosmology eats the remnants of earlier sub-cosmology it could become hyperbolic itself. Of course, this is not the only mechanism. This scenario resembles to high degree the lifecycle of a biological organism involving gradual growth, metabolism and death.

1. Transition to matter or radiation dominated phase

The critical cosmology is transformed to a hyperbolic cosmology with sub-critical mass density. This option is very general and means that criticality is gradually shifted to increasingly longer length scales when it breaks down in short length scales. The continuity condition in the transformation to hyperbolic cosmology with $\theta = \pi/2$ and $\phi = \phi(a)$ for g_{aa} reads as

$$\begin{aligned} \frac{1}{g_{aa}^H} - 1 &= \frac{1}{1-K} \equiv \epsilon, \\ K &\equiv \frac{R^2}{4a_1^2} \frac{1}{(1 - (\frac{a}{a_1})^2)}. \end{aligned} \quad (8.4.4)$$

The light cone projection of the sub-cosmology is sub-lightcone of M_+^4 . a denotes light cone proper time for this sub-light cone: its value is obviously smaller than the value of M_+^4 proper time. Upper index 'H' refers to the metric of the hyperbolic cosmology. The value of the parameter ϵ must deviate considerably from unity and since R/a_1 is extremely small number, the transformation to hyperbolic cosmology must happen very near to $a = a_1$: for all practical purposes this fixes the moment of transition to be $a = a_1$. Critical cosmology is also flat in excellent approximation up to $a = a_1$. The mass density of the hyperbolic cosmology behaves during the matter (radiation) dominated phase as

$$\rho = \frac{3}{8\pi G} \epsilon \frac{a_1^{1+n}}{a^{3+n}}. \quad (8.4.5)$$

Here $n = 0$ corresponds to matter dominance and $n = 1$ to radiation dominance.

2. Decomposition of $a = \text{constant}$ surface to disjoint non-expanding components

p-Adic length scale hypothesis suggests that hyperbolic sub-cosmology ceases to participate in the cosmic expansion sooner or later and that $a = \text{constant}$ 3-surface decomposes to disjoint particle like non-expanding objects topologically condensing at and comoving on the sub-cosmologies generated later. A possible mechanism causing the decomposition of a hyperbolic sub-cosmology into disjoint space-time sheets is the intersection of the sub-light cones defined by the sub-cosmologies initiated at same $a = \text{constant}$ hyperboloid. The transition to non-expanding phase has certainly occurred for stellar objects.

The disjoint 3-surfaces generated in this process are topologically condensed at (or are 'metabolized' by) younger critical cosmologies and the simplest assumption is that this condensation process changes the newer cosmology to matter dominated hyperbolic cosmology. This assumption is consistent with the fact that the mass density of the critical cosmologies is very small before the transformation to the matter dominated phase so that they cannot contain topologically condensed matter. Before the condensation process the condensation of free cosmic strings gives rise to the gradual increase of the mass density of the critical cosmology.

This picture implies that cosmic expansion occurs only above some length scale and that the long length scale optical properties of the universe are determined by the competition of sub-cosmologies in hyperbolic and critical stages since photons travel along space-time sheets of both type.

p-Adic fractality

p-Adic fractality suggests that all cosmological phase transitions giving rise to the generation of new space-time sheets should be describable using the same universal Robertson-Walker cosmology during their critical period so that cosmology would contain cosmologies containing cosmologies... like Russian doll contains Russian dolls inside it. The light cone projection of each sub-cosmology is sub-light cone. Lorentz invariance requires that the probability distribution for the position the tip of the sub-light cone is constant along $a = \text{constant}$ hyperboloid.

Sub-cosmology is characterized by three parameters a_0 , a_1 and a_2 . a_0 characterizes the moment of birth for sub-cosmology, a_1 characterizes in excellent approximation the value of the sub-light cone proper time for which the transition from critical to hyperbolic sub-cosmology occurs. $a_1 + a_2$ in turn characterizes the sub-light cone proper time for the decay of the hyperbolic sub-cosmology to comoving non-expanding surfaces. p-Adic length scale hypothesis allows to make educated guesses for the values of a_0 , a_1 and a_2 so that TGD inspired cosmology becomes highly predictive.

Since a_0 characterizes the moment of birth for sub-cosmology, it is not expected to reflect in any manner the dynamics of earlier sub-cosmologies. In contrast to this, a_1 and a_2 characterize the internal dynamics of sub-cosmology involving gravitational time dilation effects in an essential manner and this suggests that the fundamental parameters are the values of the proper times s_1 and s_2 for sub-cosmologies to which a_1 and a_2 are related in simple manner.

More quantitatively, the proper time s of the space-time surface representing cosmology is defined as

$$s = \int_0^a \sqrt{g_{aa}} da .$$

The relationship between light cone proper time and proper time of the critical cosmology implies the relationship

$$\begin{aligned} s_1 &= \int_0^{a_1} \sqrt{1-K} da , \\ K &\equiv \frac{R^2}{4a_1^2} \frac{1}{\left(1 - \left(\frac{a}{a_1}\right)^2\right)} . \end{aligned} \quad (8.4.6)$$

between a_1 and s_1 . Up to to $a \simeq a_1$ the value of the parameter K is nearly vanishing so that $s \simeq a$ holds in a good approximation during the critical period. This means that the values of s_1 and a_1 are in excellent approximation identical:

$$s_1 \simeq a_1 .$$

The relationship between s_2 and a_1 and a_2 is

$$s_2 = \int_{a_1}^{a_1+a_2} \sqrt{g_{aa}} da . \quad (8.4.7)$$

The gravitational dilation effects for hyperbolic cosmology are large and s_2 and a_2 can differ by orders of magnitude.

p-Adic length scale hypothesis states two things.

- (a) Each p-adic prime p corresponds to p-adic length scale $L_p = \sqrt{p} \times l$, where $l \simeq 10^{3.5}$ Planck lengths is CP_2 'radius'.

(b) The primes $p \simeq 2^k$, k prime or power of prime are physically preferred so that one has

$$L_p \equiv L(k) \simeq 2^{k/2} \times l .$$

p-Adic fractality allows to make educated guesses for the most plausible values of the parameters a_0 , a_1 and a_2 characterizing the evolution of the sub-cosmologies.

1. Moments of birth of sub-cosmologies

It seems that the generation of new sub-cosmologies is a process having nothing to do with the internal dynamics of sub-cosmologies themselves. Therefore p-adic fractality suggests that the dips of the sub-light cones associated with the critical cosmologies are concentrated in good approximation at the hyperboloids

$$a_0(k) = x_0 L(k)$$

of the light cone M_+^4 where x_0 is some numerical constant: note that a_0 refers to the proper time of the light cone M_+^4 rather than sub-light cone. The number of primes k in the interval $[2, \dots, 401]$ (see Table 2) is rather small which implies that the number of sub-cosmologies created after Big Bang is smaller than 100.

2. Moments for the transition to hyperbolicity

The natural guess is that the imbedding for the cosmology characterized by $p \simeq 2^k$ fails for $a \simeq a_1$ (in excellent approximation) when sub-cosmology also starts to metabolize the remnants of earlier sub-cosmologies. p-Adic length scale hypothesis gives the estimate

$$s_1(k) \simeq a_1(k) = x_1 L(k) ,$$

where x_1 is numerical constant of order unity. The most natural interpretation is that transition to radiation or matter dominated cosmology occurs. It is natural to assume that topological condensation of 3-surfaces resulting from earlier cosmology accompanies this transition. One can also say that cosmological metabolism causes transition to hyperbolicity.

3. Moments of death for sub-cosmologies

The death of the sub-cosmology means decay to disjoint 3-surfaces. The simplest assumption is that this occurs when the age of sub-cosmology measured with respect to sub-cosmological proper time s exceeds p-adic time scale defined by the next p-adic prime in the hierarchy. Thus one has

$$s_1 + s_2 \simeq a_1 + s_2 = x_2 L(k(next))$$

giving

$$s_2 = x_2 L(k(next)) - x_1 L(k) . \quad (8.4.8)$$

From this one can relate the parameter a_2 with the p-adic length scales $L(k(next))$ and $L(k)$. $L(k)$ gives the size scale of the 3-surfaces resulting when the connected space-time sheet $a_2 = \text{constant}$ decomposes to pieces. Due to gravitational time dilation s_2 can be smaller than a_2 by several orders of magnitude so that the duration of the hyperbolic period when measured using sub-light cone proper time is lengthened by gravitational time dilation and topological condensation of the remnants of sub-cosmology can take place to a critical cosmology having $k > k(next)$.

4. Temperature and energy density of the critical cosmology at the moment of transition to hyperbolicity.

p-Adic length scale hypothesis suggest that the temperature just after the transition to the effectively radiation dominated phase is

$$\begin{aligned}
 T(k) &= \frac{n}{L(k)} \ , \quad \text{for } k > k_{cr} \ , \\
 T(k) &= T_H \sim \frac{1}{R} \ , \quad \text{for } k \leq k_{cr} \ .
 \end{aligned}
 \tag{8.4.9}$$

Here n is rather large numerical factor. Since $a_F \sim 2.7 \times 10^{-10}$ seconds which corresponds to length scale $L \simeq .08$ meters roughly to p-adic length scale $L(197) \simeq .08$ meters (which by the way corresponds to the largest p-adic length scale associated with brain, cosmic joke?), should correspond to the establishment of Hagedorn temperature, one has the conditions

$$\begin{aligned}
 k_{cr} &= 197 \ , \\
 n &\simeq 2^{197/2} \sim 10^{30} \sim \frac{m_{CP_2}^2}{m_p^2} \ .
 \end{aligned}$$

Thus n is in of same order of magnitude as the ratio of the CP_2 mass squared ($m_{CP_2} \simeq 10^{-3.5}$ Planck masses) to proton mass squared.

Dimensional considerations suggest also that the energy density in the beginning of the radiation dominated phase (in case that it is achieved) is

$$\rho = nT(k)^4 \ , \tag{8.4.10}$$

where n a numerical factor of order one. n does not count for the number of light particle species since the thermal energy of strings gives rise to the effective radiation dominance. This explains why infinite number of fermion families does not lead to infinite density of thermal energy and why their presence leaves no trace in present day cosmology.

When the time parameter a_1 of the critical cosmology becomes too high, it cannot anymore generate radiation dominated phase since the temperature remains too low. Previous considerations suggest that the maximum value of a_1 is roughly $a_1(max) = a_F \sim 3 \times 10^{-10}$. After this critical sub-cosmologies transform directly to the stationary cosmologies.

These estimates fix the structure of the fractal cosmology to rather high degree. Note that the expanding space-time surfaces associated with the new critical cosmologies created in the phase transition can fuse since corresponding light cones can intersect. The number of the phase transitions occurred after the light cone proper time corresponding to electron Compton length is roughly forty. The tables below give the p-adic length scales in the range extending from electron Compton radius to 10^{10} light years.

k	127	131	137	139	149
$L_p/10^{-10}m$.025	.1	.8	1.6	50
k	151	157	163	167	169
$L_p/10^{-8}m$	1	8	64	256	512
k	173	179	181	191	193
$L_p/10^{-4}m$.2	1.6	3.2	100	200
k	197	199	211	223	227
L_p/m	.08	.16	10	640	2560

Table 1. p-Adic length scales $L_p = 2^{k-151}L_{151}$, $p \simeq 2^k$, k prime, possibly relevant to astro- and biophysics. The last 3 scales are included in order to show that twin pairs are very frequent in

the biologically interesting range of length scales. The length scale $L(151)$ is take to be thickness of cell scale, which is 10^{-8} meters in good approximation.

k	227	229	233	239	241
L_p/m	$2.3E+3$	$4.6E+3$	$1.9E+4$	$1.5E+5$	$3.0E+5$
k	251	257	263	269	271
L_p/m	$.96E+7$	$7.7E+7$	$6.0E+8$	$4.8E+9$	$.9E+10$
k	277	289	293	307	311
L_p/m	$7.7E+10$	$5.0E+12$	$2.0E+13$	$2.5E+15$	$1.0E+16$
k	313	317	329	331	337
L_p/ly	2.2	$5.4E+2$	$1.0E+3$	$2.2E+3$	$8.4E+3$
k	347	349	353	359	367
L_p/ly	$2.8E+5$	$5.6E+5$	$2.2E+6$	$1.8E+7$	$2.9E+8$
k	373	379	381	391	397
L_p/ly	$2.2E+9$	$1.9E+10$	$3.8E+10$	$1.2E+12$	$.96E+13$

Table 2. p-Adic length scales $L_p = 2^{(k-127)/2} L_{127}$, $p \simeq 2^k$, k prime, possibly relevant to large scale astrophysics. The definition of the length scale involves an unknown factor r of order one and the requirement $L(151) \simeq 10^{-8}$ meters, the thickness of the cell membrane, implies that this factor is $r \simeq 1.1$.

8.4.4 The problem of cosmological missing mass

In inflationary cosmology the basic problem is related to the missing mass. The experimentally determined recent density of the ordinary matter is about 4 per cent of the critical mass density and it seems that ordinary sources (other than vacuum energy density) can contribute about 30 percent of the critical mass density in inflationary scenarios. In TGD framework the situation is different as following arguments show.

1. *Criticality does not force missing mass in TGD framework.*

There is no absolute need for vacuum energy density since the mass densities of critical cosmologies present in condensate are extremely low before the transition to the hyperbolicity. In TGD framework the observed mass density corresponds to the mass density at 'our' cosmological space-time sheet condensed to some larger space-time sheet... condensed on the largest space-time sheet present in the topological condensate now. If the vapor phase density equals to the critical density of flat critical cosmology, the net energy density of the entire topological condensate is bound to be smaller than the critical density. This is in accordance with experimental facts. In fact, vapor phase energy density corresponds closely to the vacuum energy density of inflationary scenarios. By the conservation of energy the total energy density at various space-time sheets is indeed equal to 'critical' vapor phase density apart from effects caused by different expansion rates. The possibility of negative energy virtual gravitons however makes possible for a given space-time sheet to have energy density much larger than the energy density of the vapor phase.

2. *The observed optical properties of the Universe require that photons travel in critical cosmologies for a sufficiently long fraction of time.*

The photons coming from a distant source must propagate along a space-time sheet of a critical cosmology for a sufficiently long fraction of time during their travel to detector. If the period of the matter dominance is too long, photons spend too long time fraction in matter dominated phase and the spectrum of anisotropies is seriously affected. This is avoided if the period between the initiation of the matter dominance and decomposition into disjoint 3-surfaces is sufficiently short. Generation of lumps of matter could in fact involve gravitational collapse leading to the decomposition of the 3-surface to pieces. Second possibility is that the topological condensation

of photons is more probable on critical and essentially flat cosmologies (present always) than on matter dominated cosmologies. The large rate of topological evaporation from radiation and matter dominated cosmologies is consistent with this. An alternative explanation in terms of zero energy ontology is that topological evaporation is only effective.

3. *The mass density of later matter dominated cosmologies should be larger than that of previous matter dominated cosmologies.*

Assume that previous cosmology have made transition to non-expanding phase and behaves as comoving matter with density $\rho(p_1)$ on the next expanding matter dominated cosmology with density $\rho(p_2)$. Under this assumption the condition

$$\rho(p_1) \equiv p\rho(1) < \rho(p_2)$$

implies

$$a_1(p_1)\epsilon(p_1)\frac{1}{a^3(p_1)} = p \times a_1(p_2)\epsilon(p_2)\frac{1}{a^3(p_2)} .$$

The larger the space-time sheet, the later it is created, and therefore one has $a(p_1) > a(p_2)$ as well as $a_1(p_1) < a_1(p_2)$. For large values of $a(p_1)$ and $a(p_2)$ one has $a(p_1) \sim a(p_2)$ in good approximation and one has

$$a_1(p_1)\epsilon(p_1) = p \times a_1(p_2)\epsilon(p_2) . \quad (8.4.11)$$

The parameters ϵ are of order unity in recent day cosmology.

If one assumes the relationship $s_1 \simeq a_1 = xL(k)$, one obtains

$$\frac{\epsilon(k_1)}{\epsilon(k_2)} = p \times 2^{(k_2-k_1)/2} . \quad (8.4.12)$$

It is possible to satisfy this constraint for $p < 1$.

The assumption about cosmologies inside cosmologies implies distribution of ages of the Universe and provides a natural explanation for why the observed mass density is subcritical. Cosmic strings topologically condensed at the larger space-time sheet could correspond to the missing mass. The age of the space-time sheet of an astrophysical object can be much longer than the age of the largest space-time sheet: this could explain the paradoxical observation that some stars seem to be older than the Universe.

8.4.5 TGD based explanation of the results of the balloon experiments

TGD based model explaining the results of balloon experiments relies on the notion of the fractal cosmology.

Under what conditions Universe is effectively critical?

TGD based model explaining the results of balloon experiments relies on the notion of the fractal cosmology. If $a = \text{constant}$ sections of hyperbolic cosmologies decompose to disjoint 3-surfaces after sufficiently short matter dominated period, the photons propagating along these space-time sheets must 'drop' on the critical space-time sheets so that situation stays effectively critical and model yields same predictions as inflationary cosmology. The decoupling of radiation from matter involved a topological phase transition leading to a generation of new expanding space-time sheets along which the CMB radiation could propagate.

The following argument shows under what conditions the total duration of the matter dominated periods is negligible as compared with the total duration of the critical periods. The ratio of the observed angular separation $\Delta\phi_{obs}$ between hot spots to real angular separation $\Delta\phi_r$ between them can be deduced from

$$\begin{aligned}\Delta\phi_{obs} \simeq \tan(\Delta\phi_{obs}) &= \frac{\sqrt{g_{\phi\phi}}\Delta\phi_r}{R(r)} , \\ R(r) &= \int \sqrt{g_{aa}}da = \int \sqrt{g_{rr}}\frac{dr}{da}da\end{aligned}\quad (8.4.13)$$

$R(r)$ is the Euclidian distance calculated along the light like geodesic associated with photon and depends on the curvature properties of the intervening space. Flat cosmology serves as a natural reference and the ratio

$$\begin{aligned}\frac{\Delta\phi_{obs}}{\Delta\phi_{obs}(flat)} &= \frac{R(r, flat)}{R(r)} \\ &= \frac{a - a_1}{\int_{a_1}^a \sqrt{g_{aa}}da}\end{aligned}\quad (8.4.14)$$

measures the effect of the intervening space to the observed angular distance between hot spots of CMB. Note that the integral must be expressed in terms of the initial values of the coordinate r .

When photons travel along critical cosmology, $g_{aa} \simeq 1$ holds true and this corresponds to flat situation. For a fixed value of r one has the following approximate expressions in various cosmologies

$$\begin{aligned}a - a_1 &= r - r_1 , && \text{(critical cosmology with } g_{aa} = 1 \text{)} , \\ a - a_1 &\sim \log\left(\frac{r}{r_1}\right) , && \text{(hyperbolic cosmology with } g_{aa} = 1 \text{)} , \\ \frac{2}{3}ka\left(\left(\frac{a}{a_R}\right)^{1/2} - \left(\frac{a_1}{a_R}\right)^{1/2}\right) &&& \\ = \log\left(\frac{r}{r_1}\right) , &&& \text{(matter dominance with } g_{aa} = k\left(\frac{a}{a_R}\right)^{1/2} \text{)} .\end{aligned}\quad (8.4.15)$$

From these expressions one finds that same increment of r gives rise to much smaller increment of a in hyperbolic cosmology than in critical cosmology. Thus the fractions of r spent in critical cosmology gives the dominating contribution to the integral unless this fraction happens to be especially small. From these expressions one finds that for a given distance r the red shift in approximately flat (no horizon) hyperbolic cosmology is exponentially larger than in critical cosmology. The arrival of photons along hyperbolic cosmology could thus explain why their ages when derived from the red shift seem to be larger than the age of the Universe derived assuming that photons travel along critical cosmology.

During periods of matter dominance g_{aa} behaves as $g_{aa} = k\frac{a}{a_2}$ and gives smaller contribution than critical period. Integral can be expressed as sum of critical and matter dominated contributions as

$$\int_{a_2}^a \sqrt{g_{aa}}da = \sum_i [\Delta a_0(i) + s_2(i)] . \quad (8.4.16)$$

Here the durations of periods are of order $L(k_i)$ and last period gives the dominant contribution. If the last propagation has occurred along critical cosmology for a sufficiently long time, the contribution of the earlier matter dominated periods to the integral are small and the last critical period can dominate in the integral. If the last critical period corresponds to $k = 379$ preceded by $k = 373$, then the ratio for angle separations does not differ more than about 10 per cent from the value guaranteeing ideal criticality.

What the absence of the second acoustic peak implies?

The absence of the second acoustic peak (which might be also a statistical artefact) fixes the TGD based model to a very high degree.

- (a) By quantum criticality scale free spectrum for the size L of the density fluctuations is a natural assumption when L is above the p-adic length scale $L(k(\text{prev}))$ characterizing the size of the remnants of the previous cosmology condensing to the critical space-time sheets in the transition to hyperbolic cosmology. Below this size ($L < L(k(\text{prev}))$) the spectrum for fluctuations has however natural cutoff. This cutoff could also correspond to the length of the cosmic strings giving rise to large voids containing cosmic strings inside them in TGD based model of galaxy formation and to the recent size of large voids containing galaxies at their boundaries. The space-time sheets of large voids should have been born in the phase transition generating CMB if this picture is correct.
- (b) The first acoustic maximum corresponds to $l = 200$ and $L(k_R)$. The second acoustic maximum corresponds to $l = 500$ and has thus size which is $2/5$ of the size of the first hot spot. $L(k_R(\text{prev}))$ defines the lower bound for the size of the density and temperature fluctuations as the minimum size of topologically condensed space-time sheets. Therefore, if second acoustic maximum is present, the size of the corresponding hot spot must be larger than $L(k_R(\text{prev}))$. Thus the condition for the absence of the second acoustic maximum is

$$\frac{L(k_R(\text{prev}))}{L(k_R)} < \frac{2}{5} .$$

Thus the experimental absence of the second maximum requires that k_R and $k_R(\text{prev})$ form twin pair ($k_R(\text{prev}) = k_R - 2$) so that one has $L(k_R(\text{prev})) = L(k_R)/2$.

There are two candidates for the twin pairs in question: the twin pairs are (347, 349) and (359, 381) (see table 2 for the values of corresponding p-adic length scales). Only the first pair is consistent with the previous considerations related to p-adic fractality.

- (a) The pair ($k_R(\text{prev}) = 347, k_R = 349$) corresponds to the p-adic length scales $L(347) = 2.8E + 5$ ly and $L(349) = 5.6E + 5$ ly. $L(347)$ clearly corresponds to the minimum size of the first acoustic peak. Rather remarkably, the length scale $L(347)$, which corresponds also to the size of the typical spatial structures frozen in the transition to matter dominated cosmology, corresponds rather closely to the estimated time $s_R \sim 5E + 5$ years for the transition to matter dominance and also to the typical size of galaxies. In consistency with the general picture, the estimate

$$s_R = s_1 + s_2 = x_2 L(349)$$

gives $s_R = 5.8E + 5$ years for $x_2 = 1$.

- (b) If one takes seriously the order of magnitude estimate $s = s_R = 5 \times 10^5$ light years for the age of the cosmology when CMB was created, and assumes that hyperbolic cosmology was radiation dominated before s_R , one can estimate the value of light cone proper time a at this time using the formula

$$s_R = \int_{a_1}^{a_R} \sqrt{g_{aa}} da ,$$

$$g_{aa} \simeq 10^{-3} \frac{a^2}{a_R^2} . \quad (8.4.17)$$

This gives $a_R \sim 3.3 \times 10^7$ light years: this corresponds to the p-adic length scale $L(359)$. Thus gravitational time dilatation implies that topological condensation does not occur to $L(353)$ next to $L(349)$ but to $L(259)$. 5 new cosmologies corresponding to $k = 353, 359, 367, 373$ and 379 should have emerged after the transition to matter dominated cosmology and could correspond to cosmological structures. Large voids are certainly this kind of structures and correspond to the p-adic length scale $L(367) \sim 2.9E + 8$ ly. The predicted age of the Universe is about $L(381) \sim 1.9E + 10$ years in this scenario.

Fluctuations of the microwave background as a support the notion of many-sheeted space-time

The fluctuations of the microwave background temperature are due to the un-isotropies of the mass density: enhanced mass density induces larger red shift visible as a local lowering of the temperature. Hence the fluctuations of the microwave temperatures spectrum provide statistical information about the deviations of the geometry of the 3-space from global homogeneity. The symmetries of the fluctuation spectrum can also provide information about the global topology of 3-space and for over-critical topologies the presence of symmetries is easily testable [E173].

The first year Wilkinson microwave anisotropy probe observations [E106] allow to deduce the angular correlation function. For angular separations smaller the 60 degrees the correlation function agrees well with that predicted by the inflationary scenarios and deriving essentially from the assumption of a flat 3-space (due to quantum criticality in TGD framework). For larger angular separations the correlations however vanish, which means the existence of a preferred length scale. The correlation function can be expressed as a sum of spherical harmonics. The $J = 1$ harmonic is not detectable due to the strong local perturbation masking it completely. The strength of $J = 2$ partial wave is only 1/7 of the predicted one whereas $J = 3$ strength is about 72 per cent of the predicted. The coefficients of higher harmonics agree well with the predictions based on infinite flat 3-space.

Later some interpretational difficulties have emerged: there is evidence that the shape of spectrum might reflect local conditions. There are differences between northern and southern galactic hemispheres and largest fluctuations are in the plane of the solar system. In TGD framework these anomalies could be interpreted as evidence for the presence of galactic and solar system space-time sheets.

1. Dodecahedral cosmology?

The WMAP result means a discrepancy with the inflationary scenario and explanations based on finite closed cosmologies necessarily having $\Omega > 1$ but very near to $\Omega = 1$ have been proposed. In [E120] Poincare dodecahedral space, which is globally homogenous space obtained by identifying the points of S^3 related by the action of dodecahedral group, or more concretely, by taking a dodecahedron in S^3 (12 faces, 20 vertices, and 30 edges) and identifying opposite faces after 36 degree rotation, was discussed. It was found to fit quadrupole and octupole strengths for $1.012 < \Omega < 1.014$ without an introduction of any other parameters than Ω .

However, according to [E126] the quadrupole and octupole moments have a common preferred spatial axis along which the spectral power is suppressed so that dodecahedron model seems to be excluded. The analysis of [E169] led to the same result. According to the article of Luminet [E158], the situation is however not yet completely settled, and there is even some experimental evidence for the predicted icosahedral symmetry of the thermal fluctuations.

The possibility to imbed also a very restricted family of over-critical cosmologies raises the question whether it might be possible to develop a TGD based version of the dodecahedral cosmology. The dodecahedral property could have two interpretations in TGD framework.

- (a) Space-time sheet with boundaries could correspond to a fundamental dodecahedron of S^3 . If temperature fluctuations are assumed to be invariant under the so called icosahedral group, which is subgroup of $SO(3)$ leaving the vertices of dodecahedron invariant as a point set, the predictions of the dodecahedral model result.

- (b) An alternative interpretation is that the temperature fluctuations for S^3 decomposing to 120 copies of fundamental dodecahedron are invariant under the icosahedral group.

For neither option topological lensing phenomenon is present since icosahedral symmetry is not due to the identification of points of 3-space in widely different directions but due to symmetry which is not be strict. An objection against both options is that there is no obvious justification for the G invariance of the thermal fluctuations. The only justification that one can imagine is in terms of quantum coherent dark matter.

The finding of WMAP that the ratio Ω of the mass density of the Universe to critical mass density is $\Omega = 1 + g_{aa} = 1 + \epsilon$, $\epsilon = 0.02 \pm 0.02$. This is consistent with critical cosmology. If only slightly overcritical cosmology is realized, there must be a very good reason for this.

The WMAP constraint implies that the value of a which corresponds to the value of cosmic time a_s which characterizes the thermal fluctuations must be such that $g_{aa} = \epsilon$ holds true. The inspection of the explicit form of g_{aa} deduced in the subsection "Critical and over-critical cosmologies" requires that a_s is extremely near to the value a_0 of cosmic time for which $g_{aa} = 0$ holds true: the deviation of a from a_0 should be of order $(R/a_0)R$ and most of the thermal radiation should have been generated at this moment.

Since gravitational mass density approaches infinity at $a \rightarrow a_0$ one can imagine that the spectrum of thermal fluctuations reflects the situation at the transition to sub-criticality occurring for $\Omega = 1 + \epsilon$. Thermal fluctuations would be identifiable as long ranged quantum critical fluctuations accompanying this transition and realized as a hierarchy of space-time sheets inducing the formation of structures. The scaling invariance of the fluctuation spectrum generalizes in TGD framework to conformal invariance. This means that the correlation function for fluctuations can have anomalous scaling dimension [E151]. The hadron physics analogy would be the transition from hadronic phase to quark gluon plasma via a critical phase discussed in section "Simulating Big Bang in laboratory".

The transition $k = 1 \rightarrow 0 \rightarrow -1$ would involve the change in the shape of the $S^2 \subset CP_2$ angle coordinate Φ as a function $f(r)$ of radial coordinate of RW cosmology. The shape is fixed by the value of $k = 1, 0, -1$. In particular, Φ would become constant in the transition to subcriticality. $k = 1 \rightarrow 0$ phase transition would be accompanied by the increase of the maximal size of space-time sheets to infinite in accordance with the emergence of infinite quantum coherence length at criticality. Whether this could be regarded as the TGD counterpart for the exponential expansion during inflationary period is an interesting question. In the transition to subcriticality also the shape of Θ as function of a necessarily changes since $\sin(\Theta(a > a_0)) > 1$ would be required otherwise.

2. Hyperbolic cosmology with finite volume?

Also hyperbolic cosmologies allow infinite number of non-simply connected variants with 3-space having finite volume. For these cosmologies the points of $a = \text{constant}$ hyperboloid are identified under some discrete subgroup G of $SO(3, 1)$. Also now fundamental domain determines the resulting space and it has a finite volume.

It has been found that a hyperbolic cosmology with finite-sized 3-space based on so called Picard hyperbolic space [E171, E71], which in the representation of hyperbolic space H^3 as upper half space $z > 0$ with line element $ds^2 = (dx^2 + dy^2 + dz^2)/z^2$ can be modeled as the space obtained by the identifications $(x, y, z) = (x + ma, y + nb, z)$. This space can be regarded as an infinitely long trumpet in z -direction having however a finite volume. The cross section is obviously 2-torus. This metric corresponds to a foliation of H^3 represented as hyperboloid of M^4 by surfaces $m^3 = f(\rho)$, $\rho^2 = (m^1)^2 + (m^2)^2$ with f determined from the requirement that the induced metric is flat so that x, y correspond to Minkowski coordinates (m^1, m^2) and z a parameter labeling the flat 2-planes corresponds to m^3 varying from ∞ to ∞ .

This model allows to explain the small intensities of the lowest partial waves as being due to constraints posed by G invariance but requires $\Omega = .95$. This is not quite consistent with $\Omega = 1.02 \pm .02$.

Also now two interpretations are possible in TGD framework. Thermal photons could originate from a space-time sheet identifiable as the fundamental domain invariant under G . Alternatively,

$a = \text{constant}$ hyperboloid could have a lattice-like structure having fundamental domain as a lattice cell with thermal fluctuations invariant under G . The shape of the fundamental domain interpreted as a surface of M^4 is rather weird and one could argue that already this excludes this model.

Quantum criticality and the presence of quantum coherent dark matter in arbitrarily long length scales could explain the invariance of fluctuations. If Ω reflects the situation after the transition to subcriticality, one has $\Omega = g_{aa} - 1 = .95$. This gives $g_{aa} = 1.95$ which is in conflict with $g_{aa} < 1$ holding true for the imbeddings of all hyperbolic cosmologies. Thus Ω must correspond to the critical period and one should explain the deviation from $\Omega = 1$. A detailed model for the temperature fluctuations possibly fixed by conformal invariance alone would be needed in order to conclude whether many-sheeted space-time might allow this option.

3. Is the loss of correlations due to the finite size of the space-time sheet?

One can imagine a much more concrete explanation for the vanishing of the correlations at angles larger than 60 degrees in terms of the many-sheeted space-time. Large angular separations mean large spatial distances. Too large spatial distance, together with the fact that the size of the space-time sheet containing the two astrophysical objects was smaller than now, means that they cannot belong to the same space-time sheet if the red shift is large enough, and cannot thus correlate. The size of the space-time sheet defines the preferred scale. The preferred direction would be most naturally defined by cosmic string(s) in the length scale of the space-time sheet. For instance, closed cosmic string would define an expanding 3-space with torus topology and thus having symmetries. This option would explain also the WMAP anomalies suggesting local effects as effects due to galactic and solar space-time sheets.

Empirical support for the hyperbolic period

TGD inspired cosmology predicts that critical cosmology is followed by a hyperbolic cosmology. A natural question is whether the travel of microwave photons through the negative curvature cosmology might induce some signatures in microwave background. This is indeed the case.

The geodesics in negative curvature 3-space diverge exponentially. The divergence of the nearly parallel light-like geodesic lines is due to the negative curvature making 2-dimensional sections of 3-space analogous to saddle surfaces. The scatterings during the travel of light induce geodesic mixing so that light from regions with differing temperature mix. Hence negative curvature tends to smooth out the anisotropies of the temperature distribution.

Negative curvature has also a more dramatic signature. Gurzadyan [E147, E146] has developed a very refined argument involving algorithmic information theory and complexity theory to show that in the hyperbolic cosmology the hot and cold spots of the temperature distribution of the cosmic microwave radiation look elongated. The direction of elongation is random but the shape of the ellipse is characterized by the curvature of 3-space and does not depend on temperature or size of the spot. For a flat or positively curved space this kind of elongation does not occur.

The emergence of a preferred direction in a Lorentz invariant cosmology looks highly counter-intuitive. My humble understanding is that a scattering of photons from a large geometric structure must be involved somehow. The elongation should relate to what happens at the last scattering surface whose position together with the positions of observer and previous scattering surface define a plane whose normal defines the preferred direction, which would presumably correspond to the shorter axis of the ellipse. In TGD framework the transfer of photons from a larger space-time sheet to that of observer might correspond to this scattering process. Scattering surface would correspond to the boundary of the space-time sheet of the observer whereas scattering would correspond to refraction at the boundary.

The analysis of BOOMERanG, COBE and WMAP CMB maps indeed shows that the spots have elliptic shape with ellipticity parameter ~ 2 whereas the prediction for hyperbolic RW cosmology is 1.4. [E132]. This would suggest that some additional effect is involved and TGD inspired bet have been already described.

8.5 Some problems of cosmology

In this chapter some problems, most of them common to both standard and TGD inspired cosmology, are discussed.

8.5.1 Why some stars seem to be older than the Universe?

There exists experimental evidence that some stars are older than the Universe [E139] , [E119, E139] . A related problem is the problem of the two Hubble constants. These paradoxical results can be understood in TGD inspired cosmology. In TGD light can propagate via several routes. In the topological condensate light ray can propagate along one of the many curved space-time sheet as a small condensed particle and in the vapor phase as a small 3-surface in imbedding space $H = M_+^4 \times CP_2$, where M_+^4 is future light cone of M^4 . The time needed to travel from point A to point B is shorter in the vapor phase than in any space-time surface since the geodesic length along the space-time surface in the induced metric is obviously longer than in free Minkowski space. This time depends also on the space-time sheet so that entire spectrum of effective light velocities and Hubble constants results. The failure to distinguish between vapor phase photons and photons propagating along various space-time sheets leads to the paradox as following arguments shows and possibly also to the problem of two (or in fact more than two) different Hubble constants. The possibility of the vapor phase photons or photons propagating along almost flat space-time sheets emitted by the objects outside the space-time horizon of 'our' space-time sheet explains also objects with anomalously large red shifts.

Basic facts

To understand these results one must study TGD based cosmology in more quantitative level.

- (a) The most general cosmological imbedding of M_+^4 to $M_+^4 \times CP_2$, is of form

$$\begin{aligned} s^k &= s^k(a) , \\ g_{aa} &= 1 - s_{kl} \frac{ds^k}{da} \frac{ds^l}{da} , \\ ds^2 &= g_{aa} da^2 - a^2 \left(\frac{dr^2}{1+r^2} + r^2 d\Omega^2 \right) . \end{aligned} \quad (8.5.1)$$

Here s_{kl} is CP_2 metric tensor and describes always expanding cosmology with subcritical or at most critical mass density.

- (b) The age of the Universe defined as M_+^4 proper time a of the co-moving observer (the co-moving observer on the space-time surfaces is also co-moving in M_+^4) is larger than the age defined as the proper time $s(a)$ of the co-moving observer on space-time surface. For the matter dominated Universe one has $g_{aa} = Ka$, which gives

$$\frac{\text{age}(cond)}{\text{age}(vapor)} = \frac{s(a)}{a} = \frac{2}{3} \sqrt{g_{aa}} , \quad (8.5.2)$$

for the ratio of the ages.

- (c) The recent value of g_{aa} can estimated from the expression for the mass density in the expanding cosmology

$$\begin{aligned} \rho &= \frac{3}{8\pi G} \left(\frac{1}{g_{aa}} + k \right) , \\ k &= -1 . \end{aligned} \quad (8.5.3)$$

$k = 0$ mass density corresponds to the critical mass density ρ_c . The mass density is believed to be a fraction of order $\epsilon = 0.1 - 0.5$ of the critical mass density and this gives estimate for $\sqrt{g_{aa}}$:

$$\begin{aligned}\sqrt{g_{aa}} &= \sqrt{1 - \epsilon} , \\ \epsilon &= \frac{\rho}{\rho_c} .\end{aligned}\tag{8.5.4}$$

$\sqrt{g_{aa}} = 2/3$ suggested by the proposed solution to the Hubble constant discrepancy gives $\epsilon = \frac{9}{4}$. $\epsilon = .1$ gives $\sqrt{g_{aa}} \simeq .95$.

- (d) The ratio of the condensate travel time to the vapor phase travel time for short distances is given by

$$\frac{\tau(\text{cond})}{\tau(\text{vapor})} = \frac{1}{\sqrt{g_{aa}}} .\tag{8.5.5}$$

This effect is in principle observable. The effect provides also a means of measuring the mass density of the Universe.

- (e) The light travelling in the vapor phase can reach the observer from a region, which is the intersection of the past light cone of the observer with the boundary of M^4_+ and therefore finite region of M^4 . The M^4 radius of this region in the rest frame of the observer is equal $r_M = a/2$ by elementary geometry.
- (f) For a null geodesic of the space-time surface representing cosmology, starting at (a_0, r) and ending at $(a, 0)$, one has

$$\begin{aligned}r &= \sinh(X) , & (\text{hyperbolic cosmology}) , \\ r &= X , & (\text{critical cosmology}) , \\ X &= \int_{a_0}^a \frac{\sqrt{g_{aa}}}{a} da .\end{aligned}\tag{8.5.6}$$

If g_{aa} approaches zero for $a_0 \rightarrow 0$, as it does for the radiation dominated cosmology, the integral defining X is finite. This means that the value of $r_M(a_0)$ (M^4 distance of the object from the observer) approaches zero at this limit. All radiation from the moment of the big bang comes from the tip of the light cone. The very early cosmology with a critical mass density corresponds to $g_{aa} = 1 - K$, K a very small number, and also in this case the radiation comes from the origin.

Maximum Minkowski distance from which light can propagate

It is interesting to find the maximum value of M^4_+ distance r_M from which it is possible to receive information in various cosmologies. The radius $r_M(a_0)$ has maximum for some finite value of a_0 and this radius defines the M^4 radius of the Universe observed using the condensate photons. For a_0 corresponding to maximum the condition

$$\begin{aligned}\sqrt{g_{aa}} &= \tanh(X) , & (\text{hyperbolic cosmology}) , \\ \sqrt{g_{aa}} &= X , & (\text{critical cosmology}) .\end{aligned}\tag{8.5.7}$$

The maximum corresponds to a rather large value of a_0 . Consider now various cases.

- i) In case of matter dominated cosmology one has $g_{aa} = Ka$ and one has the condition

$$u_0 = \tanh(2(u - u_0)) \simeq 2(u - u_0) , \quad u = \sqrt{Ka} , \quad u_0 = \sqrt{Ka_0} . \quad (8.5.8)$$

This gives in good approximation

$$u_0 = r = \frac{2}{3}u , \quad a_0 = \frac{4}{9}a , \quad r_M^0 = \frac{8}{27}ua = \frac{16}{81}\sqrt{Ka} \times a . \quad (8.5.9)$$

ii) In case of vapor phase and also for asymptotic cosmology in the limit of flatness one obviously has

$$r_M^0 = a . \quad (8.5.10)$$

iii) In case of critical cosmology with $g_{aa} = 1$ one has

$$a_0 = \frac{a}{e} , \quad r_0 = 1 , \quad r_M^0 = \frac{a}{e} . \quad (8.5.11)$$

The value of r_M^0 is clearly smallest in matter dominated cosmology.

Many-sheeted space-time allows several snapshots from the evolution of astrophysical objects

Vapor phase photons and condensate photons propagating along various space-time sheets provide in principle a possibility to obtain simultaneous information about the astrophysical object in various different phases of its development. For an object situated at distance r and observed at $(a, r = 0)$, the emission moments a_0 and $a_1 > a_0$ (in Minkowski proper time) for the condensate photon and vapor phase photon are related by the formula

$$\frac{a}{a_1} = \exp(2\sqrt{K_1}(a^{1/2} - a_0^{1/2})) . \quad (8.5.12)$$

in the matter dominated cosmology $g_{aa} = K_1a$ ($K_1a \sim 1$). Hence a sufficiently nearby Super Nova would provide a test for this effect. The first burst of light corresponds to vapor phase photons and subsequent bursts to the condensate photons. The time lag between the bursts provides a manner to measure the value of $\sqrt{g_{aa}}$. Unfortunately, the time lag in case of SN1987A is quite too large since the distance of order $1.5 \cdot 10^5$ ly. The observation of the same spectral line with two different cosmological red-shifts is second effect of this kind and might be erratically interpreted as the existence of two different objects on same line of sight.

Why some stars seem to be older than the Universe?

Red-shifts are determined by the apparent velocity of astrophysical object which is in good approximation given $v = Hr$, where H is Hubble constant which in TGD depends on space-time sheet along which photons propagate. One has $r = \sinh(X)$ for hyperbolic cosmology and $r = X$ for critical cosmology, where the function X is defined by Eq. 8.5.6. For matter dominated cosmology with $g_{aa} = Ka$ and for almost flat hyperbolic cosmology with $g_{aa} = 1 - \epsilon$ one has

$$\begin{aligned}
 X &= 2 [(Ka)^{1/2} - (Ka_0)^{1/2}] < 1, \quad (\text{matter dominance}), \\
 X &= \sqrt{(1-\epsilon)} \log\left(\frac{a}{a_0}\right), \quad (\text{almost flat hyperbolic}).
 \end{aligned}
 \tag{8.5.13}$$

From this it is clear that the approximation $\sinh(X) \simeq X$ makes sense in case of matter dominated cosmology and the red-shifts do not differ much from those predicted by critical cosmology.

For almost flat hyperbolic cosmology and for vapor phase situation is dramatically different since red-shifts can be exponentially larger. Therefore, if most of radiation comes along matter dominated or critical space-time sheets, then the radiation coming in vapor phase or along almost flat hyperbolic space-time sheets can give rise to huge red-shifts and stars which seem to be older than the Universe. The presence of several space-time sheets means that using common value of Hubble constant one obtains entire spectrum of ages of the Universe. Same astrophysical can also give rise to several images corresponding to the photons propagating along various space-time sheets. It might be that this mechanism might be involved with the observed multiple images of stars.

The puzzle of several Hubble constants

Each cosmic space-time has its own Hubble constant defined as

$$H = \frac{1}{a\sqrt{g_{aa}}}, \tag{8.5.14}$$

where the value of the light cone proper time corresponds to the light cone proper time of observer in the sub-light cone defined by the sub-cosmology. The value of Hubble constant is smallest at almost flat space-time sheets. Photons propagating along almost flat space-time sheet or in vapor phase provide a possible solution to the puzzle of two different Hubble constants if the mass density is sufficiently large. The distances derived from type Ia super-novae give $H_0^a = 54 \pm 8 \text{ kms}^{-1} \text{ Mpc}^{-1}$ to be compared with the Hubble result $H_0^b = 80 \pm 17 \text{ kms}^{-1} \text{ Mpc}^{-1}$ [E139], [E139].

The discrepancy is resolved if the measurement of the distance is correct and made using photons propagating in vapor phase or along almost flat hyperbolic space-time sheets so that H_0^a corresponds in good approximation to the Hubble constant of M_+^4 , which is by a factor

$$\frac{H_0^a}{H_0^b} = \frac{H_0(M_+^4)}{H_0(X^4)} = \sqrt{g_{aa}} = \sqrt{1-\epsilon} \sim 2/3 \tag{8.5.15}$$

smaller than the Hubble constant of the space-time surface. The needed mass density $\epsilon = 5/9$ and the ratio of the propagation velocities of light differs considerably from unity. For $\epsilon = .1$ the ratio of two Hubble constants is predicted to be .95 and some other explanation for discrepancy is needed. The model for the stationary cosmology indeed suggests that the density of matter is much below the value needed to explain the Hubble discrepancy in this manner.

For instance, for the space-time outside the Kähler charged cosmic string, discussed in [K24], one has

$$g_{tt} = 1 - \frac{R^2\omega^2}{4}(1-u^2), \quad -1 < u(\rho) < 1.$$

The model for the galaxy formation requires $\exp(4\omega R) \sim 10^3$ and this gives $\frac{\omega^2 R^2}{4} \simeq .86$ implying $\sqrt{g_{tt}} \geq .37$ so that the reduction of the local light velocity can be rather large and explain the Hubble controversy.

In fact, there are quite recent results [E57], which can be interpreted as a support for the many-sheeted space-time picture with separate Hubble constant associated with each sheet. The preliminary result is that the Hubble constant determined from the nearby supernovas is larger than that determined from the faraway supernovas. The proposed interpretation is that the rate of the expansion of the Universe is increasing in the course of time. The increase could be due to the non-vanishing cosmological constant corresponding to a vacuum energy density about 40 per cent of the critical density: the origin of this vacuum energy density remains a mystery.

TGD suggests that Hubble constant depends on the (p-adic) length scale associated with the space-time sheet and decreases as the length scale increases. [This could also solve the problem of the two different Hubble constants since entire spectrum of Hubble constants is predicted]. Photons from nearby supernovas have suffered a topological condensation on a smaller space-time sheet as those from faraway supernovas. Hence the Hubble constant for nearby supernovas is larger and the rate of the expansion of the Universe is found to apparently increase in the course of time.

The decrease of the Hubble constant as a function of the (p-adic) length scale characterizing a given space-time sheet would follow from the fractality of the TGD Universe implying that the mass density as a function of the p-adic length scale decreases in the long length scales. Fractality could in turn would follow from the basic hypothesis necessary to get a sensible cosmology in TGD, namely that a space-time sheet corresponding to a given p-adic length scale expands until it reaches critical size not too much larger than the p-adic length scale in question. This does not exclude the possibility that the matter topologically condensed on the space-time sheet in question continues expanding and is therefore gradually drifted to the boundaries of the space-time sheet. The presence of the large voids with galaxies on their boundaries, is consistent with this assumption. From the view point of a given space-time sheet, smaller space-time sheets behave like particles of fixed size, whose density is gradually reduced in the cosmic expansion.

8.5.2 Mechanism of accelerated expansion in TGD Universe

In TGD framework the most plausible identification for the accelerated periods of cosmic expansion is in terms of phase transitions increasing gravitational Planck constant. These phase transitions would in average sense provide quantum counterpart for smooth cosmic expansion. These phase transitions might be initiated by the repulsive Coulomb interaction between cosmic strings driven to the boundaries of the large voids. It is interesting to see how this view relates with the assumption of positive cosmological constant.

How accelerated expansion results in standard cosmology?

The accelerated of cosmic expansion means that the deceleration parameter

$$q = -(a d^2 a / ds^2) / (da / ds)^2$$

is negative. For Robertson-Walker cosmologies one has

$$\begin{aligned} H^2 &\equiv \left(\frac{da/ds}{a}\right)^2 = \frac{8\pi G\rho + \Lambda}{3} - K/a^2, \quad K = 0, \pm 1, \\ 3\frac{d^2 a / ds^2}{a} &= \Lambda - 4\pi G(\rho + 3p) \equiv -4\pi G(1 + 3w)\rho. \end{aligned} \quad (8.5.16)$$

It is clear that the accelerated expansion requires positive value of Λ .

The deceleration parameter can be expressed as $q = \frac{1}{2}(1+3w)(1+K/(aH)^2)$. $K = 0, 1, -1$ tells whether the cosmology is flat, hyper-spherical, or hyperbolic. The rate for the change of Hubble constant can be expressed as $(dH/ds)/H^2 = (1+q)$ and the acceleration of cosmic expansion means $q < -1$. All particle models predict $q \geq -1$.

On basis of modified Einstein's equations written for the recent metric convention (+,-,-,-) (note that opposite signature changes the sign of the left hand side)

$$-G^{\alpha\beta} - \Lambda g^{\alpha\beta} = 8\pi G T^{\alpha\beta} \quad (8.5.17)$$

it is clear that the introduction of a positive cosmological constant could be interpreted by saying that for gravitational vacuum carries energy density equal to $\Lambda/8\pi$ and negative pressure. The negative gravitational pressure would induce the acceleration.

Cosmological term at the level of field equations could be also interpreted by saying that Einstein's equations hold true in the original sense but that energy momentum tensor contains besides the density of inertial mass also a positive density of purely gravitational mass: $T \rightarrow T + \Lambda g$ so that Equivalence Principle fails. Since cosmological constant means effectively negative pressure $p = -\Lambda/8\pi$ the introduction of the cosmological constant means the effective replacement $\rho + 3p \rightarrow \rho + 3p - 2\Lambda/8\pi$. In the so called $\Lambda - CDM$ model [E24] the densities of dark energy, ordinary matter, and dark matter are assumed to sum up to critical mass density $\rho_{cr} = 3/(8\pi g_{aa} G a^2)$. The fraction of dark matter density is deduced to be $\Omega_\Lambda = .74$ from mere criticality.

Critical cosmology predicts accelerated expansion

In order to get clue about the mechanism of accelerated cosmic expansion in TGD framework it is useful to study the deceleration parameter for various cosmologies in TGD framework.

In standard Friedmann cosmology with non-vanishing cosmological constant one has

$$3 \frac{d^2 a / ds^2}{a} = \Lambda - 4\pi G (\rho + 3p) . \quad (8.5.18)$$

From this form it is obvious why $\Lambda > 0$ is required in order to obtain accelerating expansion.

Deceleration parameter is a purely geometric property of cosmology and defined as

$$q \equiv -a \frac{d^2 a / ds^2}{(da/ds)^2} . \quad (8.5.19)$$

During radiation and matter dominated phases the value of q is positive. In TGD framework there are several metrics which are independent of details of dynamics.

1. String dominated cosmology

String dominated cosmology is hyperbolic cosmology and might serve as a model for very early cosmology corresponds to the metric

$$g_{aa} \equiv (ds/da)^2 = 1 - K_0 . \quad (8.5.20)$$

In this case one has $q = 0$.

2. Critical cosmology

Critical cosmology with flat 3-space corresponds to

$$\begin{aligned} g_{aa} &= 1 - K \ , \\ K &\equiv \frac{K_0}{1 - u^2} \ , \\ u &\equiv \frac{a}{a_1} \ . \end{aligned} \tag{8.5.21}$$

g_{aa} has the same form also for over-critical cosmologies. Both cosmologies have finite duration. In this case q is given by

$$q = -K_0 \frac{K_0 u^2}{1 - u^2 - K_0} < 0 \ , \tag{8.5.22}$$

and is negative. The rate of change for Hubble constant is

$$\frac{dH/ds}{H^2} = -(1 + q) \ , \tag{8.5.23}$$

so that one must have $q < -1$ in order to have acceleration. This holds true for $a > \sqrt{(1 - K_0)/(1 + K_0)} a_1$.

Quantum critical cosmology could be seen as a universal characteristic of quantum critical phases associated with phase transition like phenomena. No assumptions about the mechanism behind the transition are made. There is great temptation to assign this cosmology to the phase transitions increasing the size of large voids occurring during late cosmology. The observed jerk assumed to lead from de-accelerated to accelerated expansion for about 13 billion years ago might have interpretation as a transition of this kind.

3. Stationary cosmology

TGD predicts a one-parameter family of stationary cosmologies from the requirement that the density of gravitational 4-momentum is conserved. This is guaranteed if curvature scalar is extremized. These cosmologies are expected to define asymptotic cosmologies or at least characterize the stationary phases between quantum phase transitions. The metric is given by

$$\begin{aligned} g_{aa} &= \frac{1 - 2x}{1 - x} \ , \\ x &= \left(\frac{a_0}{a}\right)^{2/3} \ . \end{aligned} \tag{8.5.24}$$

The deceleration parameter

$$q = \frac{1}{3} \frac{x}{(1 - 2x)(1 - x)} \ . \tag{8.5.25}$$

is positive so that it seems that TGD does not lead to a continual acceleration which might be regarded as tearing galaxies into pieces.

If quantum critical phases correspond to the expansion of large voids induced by the accelerated radial motion of galactic strings as they reach the boundaries of the voids, one can consider a series of phase transitions between stationary cosmologies in which the value of gravitational Planck constant and the parameter a_0 characterizing the stationary cosmology increase by some even power of two as the ruler-and-compass integer hypothesis [K36, K30] and p-adic length scale hypothesis suggests.

4. Summary

One can safely conclude that TGD predict accelerated cosmic expansion during critical periods and that dark energy is replaced with dark matter in TGD framework. There is also a rather clear view about detailed mechanism leading to the accelerated expansion at "microscopic" level. Some summarizing remarks are in order.

- (a) Accelerated expansion is predicted only during periods of over-critical and critical cosmologies parameterized essentially by their duration. The microscopic description would be in terms of phase transitions increasing the size scale of large void. This phase transition is basically a quantum jump increasing gravitational Planck constant and thus the size of the large void. p-Adic length scales are favored sizes of the large voids. A large piece of 4-D cosmological history would be replaced by a new one in this transition so that quite a dramatic event would be in question.
- (b) p-Adic fractality forces to ask whether there is a fractal hierarchy of time scales in which Equivalence Principle in the formulation provided by General Relativity sense fails locally (no failure in stringy sense). This would predict a fractal hierarchy of large voids and phase transitions during which accelerated expansion occurs.
- (c) Cosmological constant can be said to be vanishing in TGD framework and the description of accelerated expansion in terms of a positive cosmological constant is not equivalent with TGD description since only effective pressure is negative. TGD description has some resemblance to the description in terms of quintessence [E36], a hypothetical form of matter for which equation of state is of form $p = -w\rho$, $w < -1/3$, so that one has $\rho + 3p = 1 - w < 0$ and deceleration parameter can be negative. The energy density of quintessence is however positive. TGD does not predict endlessly accelerated acceleration tearing galaxies into pieces if the total purely gravitational energy of large voids is assumed to vanish so that Equivalence Principle holds above this length scale.

TGD counterpart of Λ as a density of dark matter rather than dark energy

The value of Λ is expressed usually as a fraction of vacuum energy density from the critical mass density. Combining the data about acceleration of cosmic expansion with the data about cosmic microwave background gives $\Omega_\Lambda \simeq .74$.

- (a) Critical mass density requires also in TGD framework the presence of dark contribution since visible matter contribute only a few percent of the total mass density and $\Omega_\Lambda \simeq .74$ characterizes this contribution. Since the acceleration mechanism has nothing to do with dark energy, dark energy can be replaced with dark matter in TGD framework.
- (b) The dark matter hierarchy labeled by the values of Planck constant suggests itself. The $1/a^2$ behavior of dark matter density suggests an interpretation as dark matter topologically condensed on cosmic strings. Besides ordinary particles also super-symplectic bosons and their super partners playing a key role in the model of hadrons and black holes suggest themselves.
- (c) Stationary cosmology predicts that the density of stringy matter and thus dark matter decreases like $1/a^2$ as a function of M_+^4 proper time. This behavior is very natural in cosmic string dominated cosmology and one expects that the TGD counterpart of cosmological constant should behave as $\Lambda \propto 1/a^2$ in average sense. At primordial period cosmological constant would be gigantic but its recent value would be extremely small and naturally of correct order of magnitude if the fraction of positive gravitational energy is few per cent

about negative gravitational energy. Hence the basic problem of the standard cosmology would find an elegant solution.

Piecewise constancy of TGD counterpart of Λ and p-adic length scale hypothesis

There are good reasons to believe that TGD counterpart of Λ is piecewise constant. Classical picture suggests that the sizes of large voids increase in discrete jumps. The transitions increasing the size of the void would occur when the galactic strings end up to the boundary of the large void and large repulsive Coulomb energy forces the phase transition increasing Planck constant.

Also the quantum astrophysics based on the notion of gravitational Planck constant strongly suggests that astrophysical systems are analogous to stationary states of atoms so that the sizes of astrophysical systems remain constant during the cosmological expansion, and can change only in quantum jumps increasing the value of Planck constant and therefore increasing the radius of the large void regarded as dark matter bound state.

Since the set of preferred values of Planck constant is closed under multiplication by powers of 2, p-adic length scales L_p , $p \simeq 2^k$ form a preferred set of sizes scales for the large voids with phase transitions increasing k by even integer. What values of k are realized depends on the time scale of the dynamics driving the galactic strings to the boundaries of expanded large void. Even if all values of k are realized the transitions becomes very rare for large values of a .

p-Adic fractality predicts that the effective cosmological constant Λ scales as $1/L^2(k)$ as a function of the p-adic scale characterizing the space-time sheet implying a series of phase transitions reducing the value of effective cosmological constant Λ . As noticed, the allowed values of k would be of form $k = k_0 + 2n$, where however all integer value need not be realized. By p-adic length scale hypothesis primes are candidates for k . The recent value of the effective cosmological constant can be understood. The gravitational energy density usually assigned to the cosmological constant is identifiable as that associated with topologically condensed cosmic strings and magnetic flux tubes to which they are gradually transformed during cosmological evolution.

p-Adic prediction is consistent with the recent study [E192] according to which cosmological constant has not changed during the last 8 billion years: the conclusion comes from the reshifts of supernovae of type Ia. If p-adic length scales $L(k) = p \simeq 2^k$, k any positive integer, are allowed, the finding gives the lower bound $T_N > \sqrt{(2)/(\sqrt{2} - 1)} \times 8 = 27.3$ billion years for the recent age of the universe.

Brad Shaefer from Louisiana University has studied the red shifts of gamma ray bursters up to a red shift $z = 6.3$, which corresponds to a distance of 13 billion light years [E180], and claims that the fit to the data is not consistent with the time independence of the cosmological constant. In TGD framework this would mean that a phase transition changing the value of the cosmological constant must have occurred during last 13 billion years. In principle the phase transitions increasing the size of large voids could be observed as sudden changes of sign for the deceleration parameter.

The reported cosmic jerk as an accelerated period of cosmic expansion

There is an objection against the hypothesis that cosmological constant has been gradually decreasing during the cosmic evolution. Type Ia supernovae at red shift $z \sim .45$ are fainter than expected, and the interpretation is in terms of an accelerated cosmic expansion [E174]. If a period of an accelerated expansion has been preceded by a decelerated one, one would naively expect that for older supernovae from the period of decelerating expansion, say at redshifts about $z > 1$, the effect should be opposite. The team led by Adam Riess [E100] has identified 16 type Ia supernovae at redshifts $z > 1.25$ and concluded that these supernovae are indeed brighter. The conclusion is that about about 5 billion years ago corresponding to $z \simeq .48$, the expansion of the Universe has suffered a cosmic jerk and transformed from a decelerated to an accelerated expansion.

The apparent dimming/brightening of supernovae at the period of accelerated/decelerated expansion the follows from the luminosity distance relation

$$\mathcal{F} = \frac{\mathcal{L}}{4\pi d_L^2}, \quad (8.5.26)$$

where \mathcal{L} is actual luminosity and \mathcal{F} measured luminosity, and from the expression for the distance d_L in flat cosmology in terms of red shift z in a flat Universe

$$\begin{aligned} d_L &= (1+z) \int_0^z \frac{du}{H(u)} \\ &= (1+z)H_0^{-1} \int_0^z \exp\left[-\int_0^u du [1+q(u)] d(\ln(1+u))\right] du, \end{aligned} \quad (8.5.27)$$

where one has

$$\begin{aligned} H(z) &= \frac{d\ln(a)}{ds}, \\ q &\equiv -\frac{d^2 a/ds^2}{aH^2} = \frac{dH^{-1}}{ds} - 1. \end{aligned} \quad (8.5.28)$$

In TGD framework a corresponds to the light-cone proper time and s to the proper time of Robertson-Walker cosmology. Depending on the sign of the deceleration parameter q , the distance d_L is larger or smaller and accordingly the object looks dimmer or brighter.

The natural interpretation for the jerk would be as a period of accelerated cosmic expansion due to a phase transition increasing the value of gravitational Planck constant.

8.5.3 New anomaly in Cosmic Microwave Background

A new anomaly in CMB has been found. The article by L. Rudnick, S. Brown, L. R. Williams is *Extragalactic Radio Sources and the WMAP Cold Spot* tells that a cold spot in the microwave background has been discovered. The amplitude of the temperature variation is $-73 \mu\text{K}$ at maximum. The authors argue that the variation can be understood if there is a void at redshift $z \leq 1$, which corresponds to $d \leq 1.4 \times 10^{10}$ ly. The void would have radius of 140 Mpc making 5.2×10^8 ly.

Neil Turok's recent talk at PASCOS was entitled *Is the Cold Spot in the CMB a Texture?*. Turok has proposed that the cold spot results from a topological defect associated with a cosmic string of GUT type theories.

Comparison with sizes and distances of large voids

It is interesting to compare the size and distance of the argued CMB void to those for large voids [E55].

The largest known void has size of 163 Mpc making 5.3×10^8 ly which does not differ significantly from the size $8 \times 6.5 \times 10^8$ ly of CMB void. The distance is 201 Mpc making about 6.5×10^8 ly and roughly by a factor 1/22 smaller than CMB void.

Is it only an accident that the size of CMB void is same as that for largest large void? If large voids follow the cosmic expansion in a continuous manner, the size of the CMB void should be roughly 1/22 time smaller. Could it be that large voids might follow cosmic expansion by rather seldomly occurring discrete jumps? TGD inspired quantum astrophysics indeed predicts that expansion occurs in discrete jumps [K61].

The explanation of CMB void

Concerning the explanation of CMB void one can consider two options.

1. *p-Adic evolution of cosmological constant as explanation for the constancy of the void size*

If the large CMB void is similar to the standard large voids it should have emerged much earlier than these or the durations of constant value of v_0 could be rather long so that also the nearby large voids should have existed for a very long time with same size. Even in the case that all values of k corresponds to possible p-adic length scales characterizing effective Λ it is possible that no transitions reducing effective Λ have occurred during the time interval considered.

The constancy of the size of the large void during the time interval considered is predicted by other experimental findings. As already found, there is empirical evidence that cosmological constant has remained constant during last 8 billion years at least and the observed jerk suggests that this kind of phase transition has occurred for 13 billion years ago. This would predict that large voids have had the same size between 13 and 8 billion years.

2. *Are fractally scaled up variants of large voids possible?*

One can also consider the possibility that CMB void is a fractally scaled up variant of large void. The p-adic length scale of the CMB void would be $L_p \equiv L(k)$, $p \simeq 2^k$, $k = 263$ (prime). If it has participated cosmic expansion in the average sense its recent p-adic size scale would be about $16 < 22$ times larger and p-adic scale would be $L(k)$, $k = 271$ (prime). This explanation has no obvious connection with the empirical findings about the behavior of cosmological constant and does not therefore look promising.

8.5.4 Could many-sheeted cosmology explain the claimed time dependence of the fine structure constant?

There is recent evidence for the time dependence of the fine structure constant in cosmological time scales [E117]. The spectroscopic observations of a number of absorption systems in the spectra of distant quasars indicate a smaller value of α in the past. The comparison of the ratios of the frequencies for relativistic atomic transitions depending non-linearly on α^2 gives the average value $\Delta\alpha/\alpha = -0.72 \pm .18 \times 10^{-5}$ in the red shift range $z = .5 - 3.5$.

On the other hand, the data about the isotopic abundances in Oklo natural reactor which operated at 1.8×10^9 years ago gives the upper bound $\Delta\alpha/\alpha \leq 10^{-7}$ [E84]: this corresponds to the red shift $z = .13$. This suggests an abrupt change of the fine structure constant in the range $.13 < z_0 \leq .5$.

A further important piece of data is about type Ia super-novae in distant galaxies. These data have extended the Hubble diagram to red shifts $z \geq 1$ [E131]. The data imply an accelerated expansion of the universe in the framework of standard cosmology requiring the introduction of cosmological constant and vacuum energy density of unknown origin. More recent measurements have measured no variation [E111]. Despite this it is an interesting exercise to see whether the variation might have some explanation in TGD framework.

The notion of the many-sheeted cosmology might explain the apparent acceleration of the cosmological expansion. The notion of the many-sheeted space-time could also explain the apparent time variation of the fine structure constant as the following arguments tend to demonstrate.

Classical model based on many-sheeted space-time

Assume that new space-time sheets with size determined by the p-adic length scale $L(k)$ emerge at values $t \sim L(k)$ of the time coordinate during the cosmological evolution. It is also assumed that the proper description of atoms involves in an essential manner the concept of classical em field. This is indeed the case in TGD framework but not for the Bether-Salpeter equation relying on correlation functions and the abstraction of the basic features of perturbative QED.

- (a) The basic idea is that atomic nuclei need not feed their entire electric gauge fluxes to the atomic space-time sheet, which presumably corresponds to $p \simeq 2^k$, $k = 131$ or $k = 137$, but can feed a small fraction of the electric flux also to the larger space-time sheets. The simplest assumption is that each new cosmological space-time sheet receives a constant fraction of the existing nuclear gauge charge. Stability requirement suggests that also each electron feeds a negative fraction of its electric flux to the larger space-time sheet so that an overall charge neutrality is preserved. The fraction must be negative to guarantee that the nuclear and electronic charges effectively increase in magnitude when new larger space-time sheets emerge during the cosmological evolution. Negative fraction is favored also by the fact that the effective nuclear charge would otherwise approach zero in the sufficiently distant geometric future. The effect corresponds to an apparent renormalization of the fine structure constant having nothing to do with the ordinary QED renormalization or the renormalization of the fine structure constant suggested by the p-adic coupling constant evolution.
- (b) The experimental findings suggest that the distribution of the electric gauge fluxes between different space-time sheets could have changed in some abrupt manner during the period $.16 < z_0 < .5$. The lower bound follows from the fact that Oklo natural reactor data are consistent with the laboratory value of the effective fine structure constant. Assume that this abrupt change corresponds to the emergence of a new space-time sheet at $z = z_0$ taking a negative fraction of order $\epsilon \sim -10^{-5}$ of the nuclear and electronic gauge fluxes so that the effective nuclear and electronic charges increase correspondingly in magnitude. More generally, assume that this occurs for all values of cosmic time $t(k) \sim L(k)$ corresponding to p-adic length scales.
- (c) If the p-adic length scale L_p appears at $t = a \simeq L_p$ then p-adic length scales appear at $a(k_n) = 2^{(k_n - k_0)/2} a_{k_0}$. The effective fine structure constant is predicted to be constant inside intervals $[a(k_n), a(k_{n-1})]$. The minimum value for the increment of k_n is $\Delta k = k_n - k_{n-1} = 2$ and corresponds to a variation of a by single octave and to a pair of twin primes $k_n = k_{n-1} + 2$. This predicts the constancy of the effective fine structure constant after $z = z_0$ in accordance with the experimental facts. If $z_0 = a_{now}/a_0 - 1$ corresponds to the first abrupt change in the range $.13 < z_0 < .5$ then for $\Delta k = 2$ another abrupt change would occur at $z_1 = 2z_0 + 1$, $1.26 < z_1 < 3$. If each space-time sheet receives the same amount of electric flux, one has $\Delta[\log(\alpha)](z_1) \simeq 2\Delta[\log(\alpha)](z_0)$, which is excluded in the range considered. For $\Delta k = 4$ the next abrupt change would correspond to $z_2 = 4z_0 + 3$: $3.52 < z_2 < 5$. Unfortunately, this value of z is slightly above the range studied in [E118]. For $\Delta k = 6$ one would have $z_3 = 8z_0 + 7$, $8 < z_3 < 11$.
- (d) The negative em flux which is fraction of order $\epsilon \sim -10^{-5}$ of nuclear electromagnetic charge flowing to single space-time sheet does not lead to any inconsistencies since the number of the primary p-adic length scales between atomic length scale and cosmological length scales is only 45. Therefore the total variation between $a = a_{now} \sim 10^{10}$ years and $a = 10^7$ years (this is the range probed by the cosmic microwave background) would correspond to something like five p-adic length scales for $t = a$ and the predicted net variation in the red shift interval $.13 < z < 10^3$ would not be larger than $\Delta[\log(\alpha)] \sim 10^{-4}$ if each p-adic space-time sheet receives the same amount of the electric flux.

Note that this model might be seen as a topological and microscopic version of the Bekenstein's field theory model [E74] based on the assumption that fine structure constant is a slowly varying scalar field Φ having naturally the needed linear coupling to the Maxwell action. In [E84] it was suggested that Φ could correspond to the so called quintessence field believed to give rise to cosmological vacuum energy and that Bekenstein's model could explain the observed variation of the fine structure constant. Note that in many-sheeted cosmology charge conservation is not lost although the effective fine structure constant depends on cosmological time.

Could hierarchy of Planck constants be involved?

The introduction of hierarchy of Planck constants [K30, K63] suggests also mechanisms based on charge fractionization and change of Planck constant from its standard value.

Fine structure constant is proportional to $1/\hbar$. In the lowest order perturbative QED the predictions are more or less same as the predictions of classical theory and do not depend at all on \hbar . Radiation corrections appear in higher orders in powers of α , and would allow to deduce the value of \hbar associated with the dark matter system. The possibility that the value of \hbar/\hbar_0 , which is rational number, has changed a little bit in past for what we regard as visible matter does not however look very plausible.

One can imagine also another effect related to the hierarchy of Planck constants.

- (a) The pages of the book like structures associated with causal diamond CD and CP_2 are labeled by integers n_a and n_b characterizing the cyclic group associated with the singular covering or factor space defining the page. Both n_a and n_b could make themselves visible physical if the Kähler gauge potential has a pure gauge part ΔA in both CD and CP_2 degrees of freedom (with g_K included as scaling factor so that ΔA has dimension of \hbar) [K63]. This would give a fractional shift to both spin and color hyper charge and color isospin.
- (b) Since the holonomy group of CP_2 identifiable as electro-weak gauge group corresponds in natural manner to the $U(2)$ subgroup of color group, the interpretation of the anomalous color hyper charge and color isospin in terms of anomalous weak isospin and hyper charge can be considered.
- (c) This contribution to the charge in units of \hbar_0 would be of form $(a\Delta A_\psi + b\Delta A_\Phi)/\hbar_0$, where Ψ and Φ denote the phases assignable to the complex coordinates of CP_2 transforming linearly under $U(2)$. For a page of CP_2 book, which corresponds to a singular covering characterized by integer n_b , the physically most plausible scenario would give $\Delta A_\Psi = \Delta A_\Phi = \hbar_0/n_b$ for coverings so that for coverings em charge would be shifted by $1/n_b$ units. For singular factor spaces formal guess would be $\Delta A_\Psi = \Delta A_\Phi = \hbar_0 n_b$. One can argue that ΔA can be eliminated by a global gauge transformation: this transformation however induces a phase into induced spinor field giving rise to anomalous charge. This fractionization means a shift of the charge so that even neutrino would receive a small fractional em charge. Nothing prevents from asking whether this kind of fractionization could actually take place and seeing the trouble of demonstrating that it cannot be involved with the claimed anomaly.

is based on charge fractionization predicted for dark matter.

8.5.5 The problem of fermion families

The generation-genus correspondence implies that the number of the particle families is apparently infinite. The arguments developed in the second part of the book however suggest that $g > 2$ particle families have masses of order $m_0 \sim 10^{-3.5} m_{Pl}$ except possibly at the very early stages of the cosmology in the vapor phase. One should somehow understand how the effective number of particle families manages to be finite and whether very early TGD inspired cosmology allows infinite number of light particle families. In the following I shall consider the possibility that the existence of the vapor phase might provide solutions to this problem.

Without additional constraints TGD predicts infinite number of particles families (both bosonic and fermionic) since each boundary topology characterized by the handle number corresponds to a separate elementary particle. On the other hand, GRT based cosmology poses stringent bounds on the number of the fermion families. The number of the light fermion families is generally believed to be not larger than 3 or 4. In TGD the problem is even more acute if all elementary particles are massless in the vapor phase.

The original proposal for the solution of the problem was based on the following arguments.

- (a) The masses $M(g)$ of the topologically condensed elementary fermions increase as a function of the genus of the boundary component. In particular, higher genus neutrinos are (very) massive. The properties of the elementary particle vacuum functionals suggest that condensed $g > 2$ particle families have masses of order CP_2 mass.
- (b) Massive condensed fermions with mass $M(g)$ begin to decay at temperature $T \simeq M(g)$. If $M(g)$ increases sufficiently rapidly the number $N(a)$ of the effectively massless fermions in

the topological condensate is always finite due to the decay of the massive fermions. The temperature equals to the critical temperature $T_H \sim 1/R$ before $a = a_F \sim 10^{-11}$ sec. If the masses of the higher fermion families are larger than T_H , their contribution to the mass density is exponentially suppressed and they are effectively absent from cosmology. Thus the number of fermion families is effectively finite and equal to three if the argument based on elementary particle vacuum functionals holds true.

- (c) Massless fermions could be present in vapor phase but their fraction of energy density is presumably negligible since vapor phase is expected to be in zero temperature.

It has turned out [K21] that under very general conditions the number of fermion families is three. The idea is that the property of being fermion has some space-time correlate. There are reasons to believe that this correlate is Z_2 conformal symmetry for the corresponding partonic 2-surfaces. This symmetry implies that fermionic elementary particle vacuum functionals vanish identically for $g > 2$. This holds true also for gauge bosons which can be regarded as fermion anti-fermion pairs associated with the light-like throats of wormhole contact. The argument is represented in detail in [K21].

8.5.6 The redshift anomaly of quasars

There are strange findings about the time dilation of quasar dynamics challenging the standard cosmology [E199]. One expects that the farther the object is the slower its dynamics looks as seen from Earth. Lorentz invariance implies red shift for frequencies and in time domain this means the stretching of time intervals so that the evolution of distant objects should look the slower the longer their distance from the observer is. In the case of supernovae this seems to be the case. What was studied now were quasars at distances of 6 and 10 billion years and the time span of the study was 28 years [E149]. Their light was red shifted by different amounts as one might expect but their evolution went on exactly the same rhythm. This looks really strange.

One must notice that the frequency assigned to electromagnetic signature is not ordinary light frequency. For instance, is it analogous to a frequency assignable to massive particle or massless particle? Consider ordinary Doppler effect as an analog. If the redshift is effectively that of a massive particle then the redshift is given by $f \rightarrow (1 - v^2)^{1/2} f = (1 + z)f$ and for small relative velocities the redshift is about $z = \Delta f/f = v^2$ smaller than for massless case $f \rightarrow ((1 - v)/(1 + v))^{1/2} \times f = z f$ giving $z = \Delta f/f = v$ in the same approximation. In the recent case however redshifts are large. From $z + 1 = Hr$, with redshift $z = 7$ associated with $r = .75$ billion years one deduces $z = 56$ for 6 billion ly and $z = 93.3$ for 10 billion ly. Therefore the redshifts for massive and massless case are related by a factor of 2 as one easily finds.

Consider now the situation in TGD framework.

- (a) Causal diamond defined as the intersection of future and past directed light-cones is the fundamental geometric object in zero energy ontology. In cosmological scales a possible interpretation of CD is as sub-cosmology. In particular, our cosmology would correspond to this kind of CD having sub- CD s having CD s possess moduli space. CD has M^4 position identified as say that of the lower tip. One can perform Lorentz boosts for CD leaving the lower tip invariant. The proper time distance between tips of CD is Lorentz invariant and defines an internal time standard of CD . For instance, for electron, d, and u quarks this time is .1 seconds, 1/1.28 milliseconds, and 6.5 milliseconds corresponding to masses .5 MeV, 5 MeV, and 2 MeV [C19]. These time scales define fundamental biorhythms [K65].
- (b) p-Adic length scale hypothesis follows if the light-cone proper time distance between the tips of the CD is quantized in powers of two. This means that future light-cone is replaced with a union of light-cone proper time constant hyperboloids with size scales coming as powers of two. Cosmic time in quantum cosmology identified as the distance between the tips would be quantized and cosmic time would increase in jumps. As a matter fact, the relative coordinate between the tips should be quantized quite generally so that the light-cone proper time constant hyperboloids would be replaced with discrete lattice like structures. This would predict quantization of cosmic redshifts and explain the claimed

strange phenomena like God's fingers containing galaxies along the line of sight with a quantized redshift.

- (c) Could the quantization of the cosmic time relate to the strange observation? What does the dynamics of objects with a frozen value of cosmic time look like when viewed from Earth? What is clear that the distant object does not recede away during the studied evolution period. The overall redshift for the studied events during its evolution is same. No dilation of the time interval between periodic events would takes place. But isn't this the case in good approximation also in the measurements? And obviously this argument does not say anything about the time dilations associated with the samples at different distances.
- (d) Let us make a second trial. The above idea that the observed system behaves like a particle would make sense at the level of sub- CD assignable to it. One can perform Lorentz boosts to the CD and from the point of view of observer this induces a dilation of the time scales of internal dynamics expressible as fractions of the proper time distance between its tips. Should one speak about two kinds of redshifts: the cosmic redshift associated with all radiation coming from the CD and the internal redshift associated the dynamics of CD . The observations about supernovae would suggests that cosmic expansion implies CD s of distant objects have systematically suffered a radial Lorentz boost in radial direction in the manner dictated by Hubble's law.

This means that the time-like direction defined by the vector connecting tips of CD in M_{sup}^4 is same as the time direction in co-moving system thus a time-like vector pointing from the tip of the very big CD defining what we call our Big Bang cosmology at this moment to the M_{sup}^4 point at which the CD containing astrophysical object is located. This position characterizes all points of given CD so that the time dilation is same the for internal dynamics inside the CD .

- (e) Why the Lorentz boosts of quasar CD s in the two samples should be identical? Could the explanation relate to the fact that quasars are extremely distant objects meaning that the corresponding CD s are very large? Could the quasars in the two samples belong to the same CD ?! If so then the internal dynamics would obey same rhythm but there would be a purely cosmological redshift! This effect would be basic prediction of zero energy ontology in cosmological scales and would become visible in very long length scales.

Ultra-high energy collisions of heavy nuclei at Relativistic Heavy Ion Collider (RHIC) can create so high temperatures that there are hopes of simulating Big Bang in laboratory. The experiment with PHOBOS detector [C16] probed the nature of the strong nuclear force by smashing two Gold atoms together at ultrahigh energies. The analysis of the experimental data has been carried out by Prof. Manly and his collaborators at RHIC in Brookhaven, NY [C15]. The surprise was that the hydrodynamical flow for non-head-on collisions did not possess the expected longitudinal boost invariance.

This finding stimulates in TGD framework the idea that something much deeper might be involved.

- (a) The quantum criticality of the TGD inspired very early cosmology predicts the flatness of 3-space as do also inflationary cosmologies. The TGD inspired cosmology is 'silent whisper amplified to big bang' since the matter gradually topologically condenses from decaying cosmic string to the space-time sheet representing the cosmology. This suggests that one could model also the evolution of the quark-gluon plasma in an analogous manner. Now the matter condensing to the quark-gluon plasma space-time sheet would flow from other space-time sheets. The evolution of the quark-gluon plasma would very literally look like the very early critical cosmology.
- (b) What is so remarkable is that critical cosmology is not a small perturbation of the empty cosmology represented by the future light cone. By perturbing this cosmology so that the spherical symmetry is broken, it might possible to understand qualitatively the findings of [C15]. Maybe even the breaking of the spherical symmetry in the collision might be understood as a strong gravitational effect on distances transforming the spherical shape of the plasma ball to a non-spherical shape without affecting the spherical shape of its M_+^4 projection.

- (c) The model seems to work at qualitative level and predicts strong gravitational effects in elementary particle length scales so that TGD based gravitational physics would differ dramatically from that predicted by the competing theories. Standard cosmology cannot produce these effects without a large breaking of the cherished Lorentz and rotational symmetries forming the basis of elementary particle physics. Thus the the PHOBOS experiment gives direct support for the view that Poincare symmetry is symmetry of the imbedding space rather than that of the space-time.
- (d) This picture was completed a couple of years later by the progress made in hadronic mass calculations [K56] . It has already earlier been clear that quarks are responsible only for a small part of the mass of baryons (170 GeV in case of nucleons). The assumption that hadronic $k = 107$ space-time sheet carries a many-particle state of super-symplectic particles with vanishing electro-weak quantum numbers (meaning darkness in the strongest sense of the word.)
- (e) TGD allows a model of hadrons predicting their masses with accuracy better than one per cent. In this framework color glass condensate can be identified as a state formed when the hadronic space-time sheets of colliding hadrons fuse to single long stringy object and collision energy is transformed to super-symplectic hadrons.

What I have written above reflects the situation around 2005 when RHIC was in blogs. After 5 years later (2010) LHC gave its first results suggesting similar phenomena in proton-proton collisions. These results provide support for the idea that the formation of long entangled hadronic strings by a fusion of hadronic strings forming a structure analogous to black hole or initial string dominated phase of the cosmology are responsible for the RHIC findings. In the LHC case the mechanism leading to this kind of strings must be different since initial state contains only two protons. I would not anymore distinguish between hadrons and super-symplectic hadrons since in the recent picture super-symplectic excitations are responsible for most of the mass of the hadron. The view about dark matter as macroscopic quantum phase with large Planck constant has also evolved a lot from what it was at that time and I have polished reference to some short lived ideas for the benefit of the reader and me. I did not speak about zero energy ontology at that time and the understanding of the general mathematical structure of TGD has improved dramatically during these years.

8.5.7 Experimental arrangement and findings

Heuristic description of the findings

In the experiments using PHOBOS detector ultrahigh energy Au+Au collisions at center of mass energy for which nucleon-nucleon center of mass energy is $\sqrt{s_{NN}} = 130$ GeV, were studied [C16].

- (a) In the analyzed collisions the Au nuclei did not collide quite head-on. In classical picture the collision region, where quark gluon plasma is created, can be modelled as the intersection of two colliding balls, and its intersection with plane orthogonal to the colliding beams going through the center of mass of the system is defined by two pieces of circles, whose intersection points are sharp tips. Thus rotational symmetry is broken for the initial state in this picture.
- (b) The particles in quark-gluon plasma can be compared to a persons in a crowded room trying to get out. The particles collide many times with the particles of the quark gluon plasma before reaching the surface of the plasma. The distance $d(z, \phi)$ from the point $(z, 0)$ at the beam axis to the point $(0, \phi)$ at the plasma surface depends on ϕ . Obviously, the distance is longest to the tips $\phi = \pm\pi/2$ and shortest to the points $\phi = 0, \phi = \phi$ of the surface at the sides of the collision region. The time $\tau(z, \phi)$ spent by a particle to the travel to the plasma surface should be a monotonically increasing function $f(d)$ of d :

$$\tau(z, \phi) = f(d(z, \phi)) .$$

For instance, for diffusion one would have $\tau \propto d^2$ and $\tau \propto d$ for a pure drift.

- (c) What was observed that for $z = 0$ the difference

$$\Delta\tau = \tau(z = 0, \pi/2) - \tau(z = 0, 0)$$

was indeed non-vanishing but that for larger values of z the difference tended to zero. Since the variation of z correspond that for the rapidity variable y for a given particle energy, this means that particle distributions depend on rapidity which means a breaking of the longitudinal boost invariance assumed in hydrodynamical models of the plasma. It was also found that the difference vanishes for large values of y : this finding is also important for what follows.

A more detailed description

Consider now the situation in a more quantitative manner.

- (a) Let z -axis be in the direction of the beam and ϕ the angle coordinate in the plane E^2 orthogonal to the beam. The kinematical variables are the rapidity of the detected particle defined as $y = \log[(E + p_z)/(E - p_z)]/2$ (E and p_z denote energy and longitudinal momentum), Feynman scaling variable $x_F \simeq 2E/\sqrt{s}$, and transversal momentum p_T .
- (b) By quantum-classical correspondence, one can translate the components of momentum to space-time coordinates since classically one has $x^\mu = p^\mu a/m$. Here a is proper time for a future light cone, whose tip defines the point where the quark gluon plasma begins to be generated, and $v^\mu = p^\mu/m$ is the four-velocity of the particle. Momentum space is thus mapped to an $a = \text{constant}$ hyperboloid of the future light cone for each value of a .

In this correspondence the rapidity variable y is mapped to $y = \log[(t + z)/(t - z)]$, $|z| \leq t$ and non-vanishing values for y correspond to particles which emerge, not from the collision point defining the origin of the plane E^2 , but from a point above or below E^2 . $|z| \leq t$ tells the coordinate along the beam direction for the vertex, where the particle was created. The limit $y \rightarrow 0$ corresponds to the limit $a \rightarrow \infty$ and the limit $y \rightarrow \pm\infty$ to $a \rightarrow 0$ (light cone boundary).

- (c) Quark-parton models predict at low energies an exponential cutoff in transverse momentum p_T ; Feynman scaling $dN/dx_F = f(x_F)$ independent of s ; and longitudinal boost invariance, that is rapidity plateau meaning that the distributions of particles do not depend on y . In the space-time picture this means that the space-time is effectively two-dimensional and that particle distributions are Lorentz invariant: string like space-time sheets provide a possible geometric description of this situation.
- (d) In the case of an ideal quark-gluon plasma, the system completely forgets that it was created in a collision and particle distributions do not contain any information about the beam direction. In a head-on collision there is a full rotational symmetry and even Lorentz invariance so that transverse momentum cutoff disappears. Rapidity plateau is predicted in all directions.
- (e) The collisions studied were not quite head-on collisions and were characterized by an impact parameter vector with length b and direction angle ψ_2 in the plane E^2 . The particle distribution at the boundary of the plane E^2 was studied as a function of the angle coordinate $\phi - \psi_2$ and rapidity y which corresponds for given energy distance to a definite point of beam axis.

The hydrodynamical view about the situation looks like follows.

- (a) The particle distributions $N(p^\mu)$ as function of momentum components are mapped to space-time distributions $N(x^\mu, a)$ of particles. This leads to the idea that one could model the situation using Robertson-Walker type cosmology. Co-moving Lorentz invariant particle currents depending on the cosmic time only would correspond in this picture to Lorentz invariant momentum distributions.

- (b) Hydrodynamical models assign to the particle distribution $d^2N/dy d\phi$ a hydrodynamical flow characterized by four-velocity $v^\mu(y, \phi)$ for each value of the rapidity variable y . Longitudinal boost invariance predicting rapidity plateau states that the hydrodynamical flow does not depend on y at all. Because of the breaking of the rotational symmetry in the plane orthogonal to the beam, the hydrodynamical flow v depends on the angle coordinate $\phi - \psi_2$. It is possible to Fourier analyze this dependence and the second Fourier coefficient v_2 of $\cos(2(\phi - \psi_2))$ in the expansion

$$\frac{dN}{d\phi} \simeq 1 + \sum_n v_n \cos(n(\phi - \psi_2)) \quad (8.5.29)$$

was analyzed in [C15].

- (c) It was found that the Fourier component v_2 depends on rapidity y , which means a breaking of the longitudinal boost invariance. v_2 also vanishes for large values of y . If this is true for all Fourier coefficients v_n , the situation becomes effectively Lorentz invariant for large values of y since one has $v(y, \phi) \rightarrow 1$.

Large values of y correspond to small values of a and to the initial moment of big bang in cosmological analogy. Hence the finding could be interpreted as a cosmological Lorentz invariance inside the light cone cosmology emerging from the collision point. Small values of y in turn correspond to large values of a so that the breaking of the spherical symmetry of the cosmology should be manifest only at $a \rightarrow \infty$ limit. These observations suggest a radical re-consideration of what happens in the collision: the breaking of the spherical symmetry would not be a property of the initial state but of the final state.

8.5.8 TGD based model for the quark-gluon plasma

Consider now the general assumptions the TGD based model for the quark gluon plasma region in the approximation that spherical symmetry is not broken.

- (a) Quantum-classical correspondence supports the mapping of the momentum space of a particle to a hyperboloid of future light cone. Thus the symmetries of the particle distributions with respect to momentum variables correspond directly to space-time symmetries.
- (b) The M_+^4 projection of a Robertson-Walker cosmology imbedded to $H = M_+^4 \times CP_2$ is future light cone. Hence it is natural to model the hydrodynamical flow as a mini-cosmology. Even more, one can assume that the collision quite literally creates a space-time sheet which locally obeys Robertson-Walker type cosmology. This assumption is sensible in many-sheeted space-time and conforms with the fractality of TGD inspired cosmology (cosmologies inside cosmologies).
- (c) If the space-time sheet containing the quark-gluon plasma is gradually filled with matter, one can quite well consider the possibility that the breaking of the spherical symmetry develops gradually, as suggested by the finding $v_2 \rightarrow 1$ for large values of $|y|$ (small values of a). To achieve Lorentz invariance at the limit $a \rightarrow 0$, one must assume that the expanding region corresponds to $r = \text{constant}$ "coordinate ball" in Robertson-Walker cosmology, and that the breaking of the spherical symmetry for the induced metric leads for large values of a to a situation described as a "not head-on collision".
- (d) Critical cosmology is by definition unstable, and one can model the Au+Au collision as a perturbation of the critical cosmology breaking the spherical symmetry. The shape of $r = \text{constant}$ sphere defined by the induced metric is changed by strong gravitational interactions such that it corresponds to the shape for the intersection of the colliding nuclei. One can view the collision as a spontaneous symmetry breaking process in which a critical quark-gluon plasma cosmology develops a quantum fluctuation leading to a situation described in terms of impact parameter. This kind of modelling is not natural for a hyperbolic cosmology, which is a small perturbation of the empty M_+^4 cosmology.

The imbedding of the critical cosmology

Any Robertson-Walker cosmology can be imbedded as a space-time sheet, whose M_+^4 projection is future light cone. The line element is

$$ds^2 = f(a)da^2 - a^2(K(r)dr^2 + r^2d\Omega^2) . \quad (8.5.30)$$

Here a is the scaling factor of the cosmology and for the imbedding as surface corresponds to the future light cone proper time.

This light cone has its tip at the point, where the formation of quark gluon plasma starts. (θ, ϕ) are the spherical coordinates and appear in $d\Omega^2$ defining the line element of the unit sphere. a and r are related to the spherical Minkowski coordinates (m^0, r_M, θ, ϕ) by $(a = \sqrt{(m^0)^2 - r_M^2}, r = r_M/a)$. If hyperbolic cosmology is in question, the function $K(r)$ is given by $K(r) = 1/(1+r^2)$. For the critical cosmology 3-space is flat and one has $K(r) = 1$.

- (a) The critical cosmologies imbeddable to $H = M_+^4 \times CP_2$ are unique apart from a single parameter defining the duration of this cosmology. Eventually the critical cosmology must transform to a hyperbolic cosmology. Critical cosmology breaks Lorentz symmetry at space-time level since Lorentz group is replaced by the group of rotations and translations acting as symmetries of the flat Euclidian space.
- (b) Critical cosmology replaces Big Bang with a silent whisper amplified to a big but not infinitely big bang. The silent whisper aspect makes the cosmology ideal for the space-time sheet associated with the quark gluon plasma: the interpretation is that the quark gluon plasma is gradually transferred to the plasma space-time sheet from the other space-time sheets. In the real cosmology the condensing matter corresponds to the decay products of cosmic string in 'vapor phase'. The density of the quark gluon plasma cannot increase without limit and after some critical period the transition to a hyperbolic cosmology occurs. This transition could, but need not, correspond to the hadronization.
- (c) The imbedding of the critical cosmology to $M_+^4 \times S^2$ is given by

$$\begin{aligned} \sin(\Theta) &= \frac{a}{a_m} , \\ \Phi &= g(r) . \end{aligned} \quad (8.5.31)$$

Here Θ and Φ denote the spherical coordinates of the geodesic sphere S^2 of CP_2 . One has

$$\begin{aligned} f(a) &= 1 - \frac{R^2 k^2}{(1 - (a/a_m)^2)} , \\ (\partial_r \Phi)^2 &= \frac{a_m^2}{R^2} \times \frac{r^2}{1+r^2} . \end{aligned} \quad (8.5.32)$$

Here R denotes the radius of S^2 . From the expression for the gradient of Φ it is clear that gravitational effects are very strong. The imbedding becomes singular for $a = a_m$. The transition to a hyperbolic cosmology must occur before this.

This model for the quark-gluon plasma would predict Lorentz symmetry and $v = 1$ (and $v_n = 0$) corresponding to head-on collision so that it is not yet a realistic model.

TGD based model for the quark-gluon plasma without breaking of spherical symmetry

There is a highly unique deformation of the critical cosmology transforming metric spheres to highly non-spherical structures purely gravitationally. The deformation can be characterized by the following formula

$$\sin^2(\Theta) = \left(\frac{a}{a_m}\right)^2 \times (1 + \Delta(a, \theta, \phi)^2) . \quad (8.5.33)$$

- (a) This induces deformation of the g_{rr} component of the induced metric given by

$$g_{rr} = -a^2 \left[1 + \Delta^2(a, \theta, \phi) \frac{r^2}{1+r^2} \right] . \quad (8.5.34)$$

Remarkably, g_{rr} does not depend at all on CP_2 size and the parameter a_m determining the duration of the critical cosmology. The disappearance of the dimensional parameters can be understood to reflect the criticality. Thus a strong gravitational effect independent of the gravitational constant (proportional to R^2) results. This implies that the expanding plasma space-time sheet having sphere as M_+^4 projection differs radically from sphere in the induced metric for large values of a . Thus one can understand why the parameter v_2 is non-vanishing for small values of the rapidity y .

- (b) The line element contains also the components g_{ij} , $i, j \in \{a, \theta, \phi\}$. These components are proportional to the factor

$$\frac{1}{1 - (a/a_m)^2(1 + \Delta^2)} , \quad (8.5.35)$$

which diverges for

$$a_m(\theta, \phi) = \frac{a_m}{\sqrt{1 + \Delta^2}} . \quad (8.5.36)$$

Presumably quark-gluon plasma phase begins to hadronize first at the points of the plasma surface for which $\Delta(\theta, \phi)$ is maximum, that is at the tips of the intersection region of the colliding nuclei. A phase transition producing string like objects is one possible space-time description of the process.

8.5.9 Further experimental findings and theoretical ideas

The interaction between experiment and theory is pure magic. Although experimenter and theorist are often working without any direct interaction (as in case of TGD), I have the strong feeling that this disjointness is only apparent and there is higher organizing intellect behind this coherence. Again and again it has turned out that just few experimental findings allow to organize separate and loosely related physical ideas to a consistent scheme. The physics done in RHIC has played completely unique role in this respect.

Super-symplectic matter as the TGD counterpart of CGC?

The model discussed above explained the strange breaking of longitudinal Lorentz invariance in terms of a hadronic mini bang cosmology. The next twist in the story was the shocking finding, compared to Columbus's discovery of America, was that, rather than behaving as a dilute gas, the plasma behaved like a liquid with strong correlations between partons, and having density 30-50 times higher than predicted by QCD calculations [C29]. When I learned about these findings towards the end of 2004, I proposed how TGD might explain them in terms of what I called conformal confinement [K48]. This idea - although not wrong for any obvious reason - did not however have any obvious implications. After the progress made in p-adic mass calculations of hadrons leading to highly successful model for both hadron and meson masses [K56], the idea was replaced with the hypothesis that the condensate in question is Bose-Einstein condensate like state of super-symplectic particles formed when the hadronic space-time sheets of colliding nucleons fuse together to form a long string like object.

A further refinement of the idea comes from the hypothesis that quark gluon plasma is formed by the topological condensation of quarks to hadronic strings identified as color flux tubes. This would explain the high density of the plasma. The highly entangled hadronic string would be analogous to the initial state of TGD inspired cosmology with the only difference that string tension is extremely small in the hadronic context. This structure would possess also characteristics of blackhole.

Fireballs behaving like black hole like objects

The latest discovery in RHIC is that fireball, which lasts a mere 10^{-23} seconds, can be detected because it absorbs jets of particles produced by the collision [C28]. The association with the notion black hole is unavoidable and there indeed exists a rather esoteric M-theory inspired model "The RHIC fireball as a dual black hole" by Hortiu Nastase [C27] for the strange findings.

The Physics Today article [C24] "What Have We Learned From the Relativistic Heavy Ion Collider?" gives a nice account about experimental findings. Extremely high collision energies are in question: Gold nuclei contain energy of about 100 GeV per nucleon: 100 times proton mass. The expectation was that a large volume of thermalized Quark-Gluon Plasma (QGP) is formed in which partons lose rapidly their transverse momentum. The great surprise was the suppression of high transverse momentum collisions suggesting that in this phase strong collective interactions are present. This has inspired the proposal that quark gluon plasma is preceded by liquid like phase which has been christened as Color Glass Condensate (CGC) thought to contain Bose-Einstein condensate of gluons.

The theoretical ideas relating CGC to gravitational interactions

Color glass condensate relates naturally to several gravitation related theoretical ideas discovered during the last year.

1. Classical gravitation and color confinement

Just some time ago it became clear that strong classical gravitation might play a key role in the understanding of color confinement [K81]. Whether the situation looks confinement or asymptotic freedom would be in the eyes of beholder: this is one example of dualities filling TGD Universe. If one looks the situation at the hadronic space-time sheet or one has asymptotic freedom, particles move essentially like free massless particles. But - and this is absolutely essential- in the induced metric of hadronic space-time sheet. This metric represents classical gravitational field becoming extremely strong near hadronic boundary. From the point of view of outsider, the motion of quarks slows down to rest when they approach hadronic boundary: confinement. The distance to hadron surface is infinite or at least very large since the induced metric becomes singular at the light-like boundary! Also hadronic time ceases to run near the boundary and finite hadronic time corresponds to infinite time of observer. When you look from outside you find that this light-like 3-surface is just static surface like a black hole horizon which is also a light-like 3-surface. This gives confinement.

2. Dark matter in TGD

The evidence for hadronic black hole like structures is especially fascinating. In TGD Universe dark matter can be (not always) ordinary matter at larger space-time sheets in particular magnetic flux tubes. The mere fact that the particles are at larger space-time sheets might make them more or less invisible.

Matter can be however dark in much stronger sense, should I use the word "black"! The findings suggesting that planetary orbits obey Bohr rules with a gigantic Planck constant [K72], [E175] would suggest quantum coherence of dark matter even in astrophysical length scales and this raises the fascinating possibility that Planck constant is dynamical so that fine structure constant. Dark matter would correspond to phases with non-standard value of Planck constant.

This quantization saves from black hole collapse just as the quantization of hydrogen atom saves from the infrared catastrophe.

The basic criterion for the transition to this phase would be that it occurs when some coupling strength - say fine structure constant multiplied by appropriate charges or gravitational constant multiplied by masses- becomes so large that the perturbation series for scattering amplitudes fails to converge. The phase transition increases Planck constant so that convergence is achieved. The attempts to build a detailed view about what might happen led to a generalization of the imbedding space concept by replacing M^4 (or rather the causal diamond) and CP_2 with their singular coverings. During 2010 it turned out that this generalization could be regarded as a conventional manner to describe a situation in which space-time surface becomes analogous to a multi-sheeted Riemann surface. If so, then Planck constant would be replaced by its integer multiple only in effective sense.

The obvious questions are following. Could black hole like objects/magnetic flux tubes/cosmic strings consist of quantum coherent dark matter? Does this dark matter consist dominantly from hadronic space-time sheets which have fused together and contain super-symplectic bosons and their super-partners (with quantum numbers of right handed neutrino) having therefore no electro-weak interactions. Electro-weak charges would be at different space-time sheets.

- (a) Gravitational interaction cannot force the transition to dark phase in a purely hadronic system at RHIC energies since the product GM_1M_2 characterizing the interaction strength of two masses must be larger than unity ($\hbar = c = 1$) for the phase transition increasing Planck constant to occur. Hence the collision energy should be above Planck mass for the phase transition to occur if gravitational interactions are responsible for the transition.
- (b) The criterion for the transition to dark phase is however much more general and states that the system does its best to stay perturbative by increasing its Planck constant in discrete steps and applies thus also in the case of color interactions and governs the phase transition to the TGD counterpart of non-perturbative QCD. Criterion would be roughly $\alpha_s Q_s^2 > 1$ for two color charges of opposite sign. Hadronic string picture would suggest that the criterion is equivalent to the generalization of the gravitational criterion to its strong gravity analog $nL_p^2M^2 > 1$, where L_p is the p-adic length scale characterizing color magnetic energy density (hadronic string tension) and M is the mass of the color magnetic flux tube and n is a numerical constant. Presumably $L_p, p = M_{107} = 2^{107} - 1$, is the p-adic length scale since Mersenne prime M_{107} labels the space-time sheet at which partons feed their color gauge fluxes. The temperature during this phase could correspond to Hagedorn temperature (for the history and various interpretations of Hagedorn temperature see the CERN Courier article [B28]) for strings and is determined by string tension and would naturally correspond also to the temperature during the critical phase determined by its duration as well as corresponding black-hole temperature. This temperature is expected to be somewhat higher than hadronization temperature found to be about $\simeq 176$ MeV. The density of inertial mass would be maximal during this phase as also the density of gravitational mass during the critical phase.

Lepto-hadron physics [K84] , one of the predictions of TGD, is one instance of a similar situation. In this case electromagnetic interaction strength defined in an analogous manner becomes larger than unity in heavy ion collisions just above the Coulomb wall and leads to the appearance of mysterious states having a natural interpretation in terms of lepto-pion condensate. Lepto-pions are pairs of color octet excitations of electron and positron.

3. Description of collisions using analogy with black holes

The following view about RHIC events represents my immediate reaction to the latest RHIC news in terms of black-hole physics instead of notions related to big bang. Since black hole collapse is roughly the time reversal of big bang, the description is complementary to the earliest one.

In TGD context one can ask whether the fireballs possibly detected at RHIC are produced when a portion of quark-gluon plasma in the collision region formed by to Gold nuclei separates from

hadronic space-time sheets which in turn fuse to form a larger space-time sheet separated from the remaining collision region by a light-like 3-D surface (I have used to speak about light-like causal determinants) mathematically completely analogous to a black hole horizon. This larger space-time sheet would contain color glass condensate of super-symplectic gluons formed from the collision energy. A formation of an analog of black hole would indeed be in question.

The valence quarks forming structures connected by color bonds would in the first step of the collision separate from their hadronic space-time sheets which fuse together to form color glass condensate. Similar process has been observed experimentally in the collisions demonstrating the experimental reality of Pomeron, a color singlet state having no Regge trajectory [C22] and identifiable as a structure formed by valence quarks connected by color bonds. In the collision it temporarily separates from the hadronic space-time sheet. Later the Pomeron and the new mesonic and baryonic Pomerons created in the collision suffer a topological condensation to the color glass condensate: this process would be analogous to a process in which black hole sucks matter from environment.

Of course, the relationship between mass and radius would be completely different with gravitational constant presumably replacement by the the square of appropriate p-adic length scale presumably of order pion Compton length: this is very natural if TGD counterparts of black-holes are formed by color magnetic flux tubes. This gravitational constant expressible in terms of hadronic string tension of $.9 \text{ GeV}^2$ predicted correctly by super-symplectic picture would characterize the strong gravitational interaction assignable to super-symplectic $J = 2$ gravitons. I have long time ago in the context of p-adic mass calculations formulated quantitatively the notion of elementary particle black hole analogy making the notion of elementary particle horizon and generalization of Hawking-Bekenstein law [K58] .

The size L of the "hadronic black hole" would be relatively large using protonic Compton radius as a unit of length. For instance, for $\hbar = 26\hbar_0$ the size would be $26 \times L(107) = 46 \text{ fm}$ and correspond to a size of a heavy nucleus. This large size would fit nicely with the idea about nuclear sized color glass condensate. The density of partons (possibly gluons) would be very high and large fraction of them would have been materialized from the brehmstrahlung produced by the de-accelerating nuclei. Partons would be gravitationally confined inside this region. The interactions of partons would lead to a generation of a liquid like dense phase and a rapid thermalization would occur. The collisions of partons producing high transverse momentum partons occurring inside this region would yield no detectable high p_T jets since the matter coming out from this region would be somewhat like a thermal radiation from an evaporating black hole identified as a highly entangled hadronic string in Hagedorn temperature. This space-time sheet would expand and cool down to QQP and crystallize into hadrons.

4. Quantitative comparison with experimental data

Consider now a quantitative comparison of the model with experimental data. The estimated freeze-out temperature of quark gluon plasma is $T_f \simeq 175.76 \text{ MeV}$ [C24, C27], not far from the total contribution of quarks to the mass of nucleon, which is 170 MeV [K56] . Hagedorn temperature identified as black-hole temperature should be higher than this temperature. The experimental estimate for the hadronic Hagedorn temperature from the transversal momentum distribution of baryons is $\simeq 160 \text{ MeV}$. On the other hand, according to the estimates of hep-ph/0006020 the values of Hagedorn temperatures for mesons and baryons are $T_H(M) = 195 \text{ MeV}$ and $T_H(B) = 141 \text{ MeV}$ respectively.

D-dimensional bosonic string model for hadrons gives for the mesonic Hagedorn temperature the expression [B28]

$$T_H = \frac{\sqrt{6}}{2\pi(D-2)\alpha'} , \quad (8.5.37)$$

For a string in $D = 4$ -dimensional space-time and for the value $\alpha' \sim 1 \text{ GeV}^{-2}$ of Regge slope, this would give $T_H = 195 \text{ MeV}$, which is slightly larger than the freezing out temperature as

it indeed should be, and in an excellent agreement with the experimental value of [B24] . It deserves to be noticed that in the model for fireball as a dual 10-D black-hole the rough estimate for the temperature of color glass condensate becomes too low by a factor 1/8 [C27]. In light of this I would not yet rush to conclude that the fireball is actually a 10-dimensional black hole.

Note that the baryonic Hagedorn temperature is smaller than mesonic one by a factor of about $\sqrt{2}$. According to [B24] this could be qualitatively understood from the fact that the number of degrees of freedom is larger so that the effective value of D in the mesonic formula is larger. $D_{eff} = 6$ would give $T_H = 138$ MeV to be compared with $T_H(B) = 141$ MeV. On the other hand, TGD based model for hadronic masses [K56] assumes that quarks feed their color fluxes to $k = 107$ space-time sheets. For mesons there are two color flux tubes and for baryons three. Using the same logic as in [B24] , one would have $D_{eff}(B)/D_{eff}(M) = 3/2$. This predicts $T_H(B) = 159$ MeV to be compared with 160 MeV deduced from the distribution of transversal momenta in p-p collisions.

8.5.10 Are ordinary black-holes replaced with super-symplectic black-holes in TGD Universe?

Some variants of super string model predict the production of small black-holes at LHC. I have never taken this idea seriously but in a well-defined sense TGD predicts black-holes associated with super-symplectic gravitons with strong gravitational constant defined by the hadronic string tension. The proposal is that super-symplectic black-holes have been already seen in Hera, RHIC, and the strange cosmic ray events.

Baryonic super-symplectic black-holes of the ordinary M_{107} hadron physics would have mass 934.2 MeV, very near to proton mass. The mass of their M_{89} counterparts would be 512 times higher, about 478 GeV if quark masses scale also by this factor. This need not be the case: if one has $k = 113 \rightarrow 103$ instead of 105 one has 434 GeV mass. "Ionization energy" for Pomeron, the structure formed by valence quarks connected by color bonds separating from the space-time sheet of super-symplectic black-hole in the production process, corresponds to the total quark mass and is about 170 MeV for ordinary proton and 87 GeV for M_{89} proton. This kind of picture about black-hole formation expected to occur in LHC differs from the stringy picture since a fusion of the hadronic mini black-holes to a larger black-hole is in question.

An interesting question is whether the ultrahigh energy cosmic rays having energies larger than the GZK cut-off of 5×10^{10} GeV are baryons, which have lost their valence quarks in a collision with hadron and therefore have no interactions with the microwave background so that they are able to propagate through long distances.

In neutron stars the hadronic space-time sheets could form a gigantic super-symplectic black-hole and ordinary black-holes would be naturally replaced with super-symplectic black-holes in TGD framework (only a small part of black-hole interior metric is representable as an induced metric). This obviously means a profound difference between TGD and string models.

- (a) Hawking-Bekenstein black-hole entropy would be replaced with its p-adic counterpart given by

$$S_p = \left(\frac{M}{m(CP_2)}\right)^2 \times \log(p) , \quad (8.5.38)$$

where $m(CP_2)$ is CP_2 mass, which is roughly 10^{-4} times Planck mass. M is the contribution of p-adic thermodynamics to the mass. This contribution is extremely small for gauge bosons but for fermions and super-symplectic particles it gives the entire mass.

- (b) If p-adic length scale hypothesis $p \simeq 2^k$ holds true, one obtains

$$S_p = k \log(2) \times \left(\frac{M}{m(CP_2)}\right)^2, \quad (8.5.39)$$

$m(CP_2) = \hbar/R$, R the "radius" of CP_2 , corresponds to the standard value of \hbar_0 for all values of \hbar .

- (c) Hawking-Bekenstein area law gives in the case of Schwarzschild black-hole

$$S = \frac{A}{4G} \times \hbar = \pi GM^2 \times \hbar . \quad (8.5.40)$$

For the p-adic variant of the law Planck mass is replaced with CP_2 mass and $k \log(2) \simeq \log(p)$ appears as an additional factor. Area law is obtained in the case of elementary particles if k is prime and wormhole throats have M^4 radius given by p-adic length scale $L_k = \sqrt{k}R$ which is exponentially smaller than L_p . For macroscopic super-symplectic black-holes modified area law results if the radius of the large wormhole throat equals to Schwarzschild radius. Schwarzschild radius is indeed natural: in [K85] I have shown that a simple deformation of the Schwarzschild exterior metric to a metric representing rotating star transforms Schwarzschild horizon to a light-like 3-surface at which the signature of the induced metric is transformed from Minkowskian to Euclidian.

- (d) The formula for the gravitational Planck constant appearing in the Bohr quantization of planetary orbits and characterizing the gravitational field body mediating gravitational interaction between masses M and m [K72] reads as

$$\hbar_{gr} = \frac{GMm}{v_0} \hbar_0 .$$

$v_0 = 2^{-11}$ is the preferred value of v_0 . One could argue that the value of gravitational Planck constant is such that the Compton length \hbar_{gr}/M of the black-hole equals to its Schwarzschild radius. This would give

$$\hbar_{gr} = \frac{GM^2}{v_0} \hbar_0 , \quad v_0 = 1/2 . \quad (8.5.41)$$

The requirement that \hbar_{gr} is a ratio of ruler-and-compass integers expressible as a product of distinct Fermat primes (only four of them are known) and power of 2 would quantize the mass spectrum of black hole [K72]. Even without this constraint M^2 is integer valued using p-adic mass squared unit and if p-adic length scale hypothesis holds true this unit is in an excellent approximation power of two.

- (e) The gravitational collapse of a star would correspond to a process in which the initial value of v_0 , say $v_0 = 2^{-11}$, increases in a stepwise manner to some value $v_0 \leq 1/2$. For a supernova with solar mass with radius of 9 km the final value of v_0 would be $v_0 = 1/6$. The star could have an onion like structure with largest values of v_0 at the core as suggested by the model of planetary system. Powers of two would be favored values of v_0 . If the formula holds true also for Sun one obtains $1/v_0 = 3 \times 17 \times 2^{13}$ with 10 per cent error.
- (f) Black-hole evaporation could be seen as means for the super-symplectic black-hole to get rid of its electro-weak charges and fermion numbers (except right handed neutrino number) as the antiparticles of the emitted particles annihilate with the particles inside super-symplectic black-hole. This kind of minimally interacting state is a natural final state of star. Ideal super-symplectic black-hole would have only angular momentum and right handed neutrino number.
- (g) In TGD light-like partonic 3-surfaces are the fundamental objects and space-time interior defines only the classical correlates of quantum physics. The space-time sheet containing the highly entangled cosmic string might be separated from environment by a wormhole contact with size of black-hole horizon.

This looks the most plausible option but one can of course ask whether the large partonic 3-surface defining the horizon of the black-hole actually contains all super-symplectic particles so that super-symplectic black-hole would be single gigantic super-symplectic parton. The interior of super-symplectic black-hole would be a space-like region of space-time, perhaps resulting as

a large deformation of CP_2 type vacuum extremal. Black-hole sized wormhole contact would define a gauge boson like variant of the black-hole connecting two space-time sheets and getting its mass through Higgs mechanism. A good guess is that these states are extremely light.

8.5.11 Very cautious conclusions

The model for quark-gluon plasma in terms of valence quark space-time sheets separated from hadronic space-time sheets forming a color glass condensate relies on quantum criticality and implies gravitation like effects due to the presence of super-symplectic strong gravitons. At space-time level the change of the distances due to strong gravitation affects the metric so that the breaking of spherical symmetry is caused by gravitational interaction. TGD encourages to think that this mechanism is quite generally at work in the collisions of nuclei. One must take seriously the possibility that strong gravitation is present also in longer length scales (say biological), in particular in processes in which new space-time sheets are generated. Critical cosmology might provide a universal model for the emergence of a new space-time sheet.

The model supports TGD based early cosmology and quantum criticality. In standard physics framework the cosmology in question is not sensible since it would predict a large breaking of the Lorentz invariance, and would mean the breakdown of the entire conceptual framework underlying elementary particle physics. In TGD framework Lorentz invariance is not lost at the level of imbedding space, and the experiments provide support for the view about space-time as a surface and for the notion of many-sheeted space-time.

The attempts to understand later strange events reported by RHIC have led to a dramatic increase of understanding of TGD and allow to fuse together separate threads of TGD.

- (a) The description of RHIC events in terms of the formation of hadronic black hole and its evaporation seems to be also possible and essentially identical with description as a mini bang.
- (b) It took some time to realize that scaled down TGD inspired cosmology as a model for quark gluon plasma predicts a new phase identifiable as color glass condensate and still a couple of years to realize the proper interpretation of it in terms of super-symplectic bosons having no counterpart in QCD framework.
- (c) There is also a connection with the dramatic findings suggesting that Planck constant for dark matter has a gigantic value.
- (d) Black holes and their scaled counterparts would not be merciless information destroyers in TGD Universe. The entanglement of particles having particle like integrity would make black hole like states ideal candidates for quantum computer like systems. One could even imagine that the galactic black hole is a highly tangled cosmic string in Hagedorn temperature performing quantum computations the complexity of which is totally out of reach of human intellect! Indeed, TGD inspired consciousness predicts that evolution leads to the increase of information and intelligence, and the evolution of stars should not form exception to this. Also the interpretation of black hole as consisting of dark matter follows from this picture.

Summarizing, it seems that thanks to some crucial experimental inputs the new physics predicted by TGD is becoming testable in laboratory.

8.5.12 Five years later

The emergence of the first interesting findings from LHC by CMS collaboration [C9, C1] provide new insights to the TGD picture about the phase transition from QCD plasma to hadronic phase and inspired also the updating of the model of RHIC events (mainly elimination of some remnants from the time when the ideas about hierarchy of Planck constants had just born).

Anomalous behavior of quark gluon plasma is observed also in proton proton collisions

In some proton-proton collisions more than hundred particles are produced suggesting a single object from which they are produced. Since the density of matter approaches to that observed in heavy ion collisions for five years ago at RHIC, a formation of quark gluon plasma and its subsequent decay is what one would expect. The observations are not however quite what QCD plasma picture would allow to expect. Of course, already the RHIC results disagreed with what QCD expectations. What is so striking is the evolution of long range correlations between particles in events containing more than 90 particles as the transverse momentum of the particles increases in the range 1-3 GeV (see the excellent description of the correlations by Lubos Motl in his blog [C4]).

One studies correlation function for two particles as a function of two variables. The first variable is the difference $\Delta\phi$ for the emission angles and second is essentially the difference for the velocities described relativistically by the difference $\Delta\eta$ for hyperbolic angles. As the transverse momentum p_T increases the correlation function develops structure. Around origin of $\Delta\eta$ axis a widening plateau develops near $\Delta\phi = 0$. Also a wide ridge with almost constant value as function of $\Delta\eta$ develops near $\Delta\phi = \pi$. The interpretation is that particles tend to move collinearly and or in opposite directions. In the latter case their velocity differences are large since they move in opposite directions so that a long ridge develops in $\Delta\eta$ direction in the graph.

Ideal QCD plasma would predict no correlations between particles and therefore no structures like this. The radiation of particles would be like blackbody radiation with no correlations between photons. The description in terms of string like object proposed also by Lubos on basis of analysis of the graph showing the distributions as an explanation of correlations looks attractive. The decay of a string like structure producing particles at its both ends moving nearly parallel to the string to opposite directions could be in question.

Since the densities of particles approach those at RHIC, I would bet that the explanation (whatever it is!) of the hydrodynamical behavior observed at RHIC for some years ago should apply also now. The introduction of string like objects in this model was natural since in TGD framework even ordinary nuclei are string like objects with nucleons connected by color flux tubes [L2] , [L2] : this predicts a lot of new nuclear physics for which there is evidence. The basic idea was that in the high density hadronic color flux tubes associated with the colliding nucleon connect to form long highly entangled hadronic strings containing quark gluon plasma. The decay of these structures would explain the strange correlations. It must be however emphasized that in the recent case the initial state consists of two protons rather than heavy nuclei so that the long hadronic string could form from the QCD like quark gluon plasma at criticality when long range fluctuations emerge.

The main assumptions of the model for the RHIC events and those observed now deserve to be summarized. Consider first the "macroscopic description".

- (a) A critical system associated with confinement-deconfinement transition of the quark-gluon plasma formed in the collision and inhibiting long range correlations would be in question.
- (b) The proposed hydrodynamic space-time description was in terms of a scaled variant of what I call critical cosmology defining a universal space-time correlate for criticality: the specific property of this cosmology is that the mass contained by comoving volume approaches to zero at the the initial moment so that Big Bang begins as a silent whisper and is not so scaring;-). Criticality means flat 3-space instead of Lobatchevski space and means breaking of Lorentz invariance to $SO(4)$. Breaking of Lorentz invariance was indeed observed for particle distributions but now I am not so sure whether it has much to do with this.
- (c) The system behaves like almost perfect fluid in the sense that the viscosity entropy ratio is near to its lower bound whose values is predicted by string theory considerations to be $\eta/s = \hbar/4\pi$.

The microscopic level the description would be like follows.

- (a) A highly entangled long hadronic string like object (color-magnetic flux tube) would be formed at high density of nucleons via the fusion of ordinary hadronic color-magnetic flux tubes to much longer one and containing quark gluon plasma. In QCD world plasma would not be at flux tube.
- (b) This geometrically (and perhaps also quantally!) entangled string like object would straighten and split to hadrons in the subsequent "cosmological evolution" and yield large numbers of almost collinear particles. The initial situation should be apart from scaling similar as in cosmology where a highly entangled soup of cosmic strings (magnetic flux tubes) precedes the space-time as we understand it. Maybe ordinary cosmology could provide analogy as galaxies arranged to form linear structures?
- (c) This structure would have also black hole like aspects but in totally different sense as the 10-D hadronic black-hole proposed by Nastase to describe the findings. Note that M-theorists identify black holes as highly entangled strings: in TGD 1-D strings are replaced by 3-D string like objects.

This picture leaves does not yet make the perfect fluid behavior obvious. The following argument relates it to the properties of the preferred extremals of Kähler action.

Preferred extremals as perfect fluids

Almost perfect fluids seems to be abundant in Nature. For instance, QCD plasma was originally thought to behave like gas and therefore have a rather high viscosity to entropy density ratio $x = \eta/s$. Already RHIC found that it however behaves like almost perfect fluid with x near to the minimum predicted by AdS/CFT. The findings from LHC gave additional conform the discovery [C8]. Also Fermi gas is predicted on basis of experimental observations to have at low temperatures a low viscosity roughly 5-6 times the minimal value [D7]. In the following the argument that the preferred extremals of Kähler action are perfect fluids apart from the symmetry breaking to space-time sheets is developed. The argument requires some basic formulas summarized first.

The detailed definition of the viscous part of the stress energy tensor linear in velocity (oddness in velocity relates directly to second law) can be found in [D2].

- (a) The symmetric part of the gradient of velocity gives the viscous part of the stress-energy tensor as a tensor linear in velocity. Velocity gradient decomposes to a term traceless tensor term and a term reducing to scalar.

$$\partial_i v_j + \partial_j v_i = \frac{2}{3} \partial_k v^k g_{ij} + (\partial_i v_j + \partial_j v_i - \frac{2}{3} \partial_k v^k g_{ij}) . \quad (8.5.42)$$

The viscous contribution to stress tensor is given in terms of this decomposition as

$$\sigma_{visc;ij} = \zeta \partial_k v^k g_{ij} + \eta (\partial_i v_j + \partial_j v_i - \frac{2}{3} \partial_k v^k g_{ij}) . \quad (8.5.43)$$

From $dF^i = T^{ij} S_j$ it is clear that bulk viscosity ζ gives to energy momentum tensor a pressure like contribution having interpretation in terms of friction opposing. Shear viscosity η corresponds to the traceless part of the velocity gradient often called just viscosity. This contribution to the stress tensor is non-diagonal and corresponds to momentum transfer in directions not parallel to momentum and makes the flow rotational. This term is essential for the thermal conduction and thermal conductivity vanishes for ideal fluids.

- (b) The 3-D total stress tensor can be written as

$$\sigma_{ij} = \rho v_i v_j - p g_{ij} + \sigma_{visc;ij} . \quad (8.5.44)$$

The generalization to a 4-D relativistic situation is simple. One just adds terms corresponding to energy density and energy flow to obtain

$$T^{\alpha\beta} = (\rho - p)u^\alpha u^\beta + pg^{\alpha\beta} - \sigma_{visc}^{\alpha\beta} . \quad (8.5.45)$$

Here u^α denotes the local four-velocity satisfying $u^\alpha u_\alpha = 1$. The sign factors relate to the conventions in the definition of Minkowski metric $((1, -1, -1, -1))$.

- (c) If the flow is such that the flow parameters associated with the flow lines integrate to a global flow parameter one can identify new time coordinate t as this flow parameter. This means a transition to a coordinate system in which fluid is at rest everywhere (comoving coordinates in cosmology) so that energy momentum tensor reduces to a diagonal term plus viscous term.

$$T^{\alpha\beta} = (\rho - p)g^{tt}\delta_t^\alpha \delta_t^\beta + pg^{\alpha\beta} - \sigma_{visc}^{\alpha\beta} . \quad (8.5.46)$$

In this case the vanishing of the viscous term means that one has perfect fluid in strong sense.

The existence of a global flow parameter means that one has

$$v_i = \Psi \partial_i \Phi . \quad (8.5.47)$$

Ψ and Φ depend on space-time point. The proportionality to a gradient of scalar Φ implies that Φ can be taken as a global time coordinate. If this condition is not satisfied, the perfect fluid property makes sense only locally.

AdS/CFT correspondence allows to deduce a lower limit for the coefficient of shear viscosity as

$$x = \frac{\eta}{s} \geq \frac{\hbar}{4\pi} . \quad (8.5.48)$$

This formula holds true in units in which one has $k_B = 1$ so that temperature has unit of energy. What makes this interesting from TGD view is that in TGD framework perfect fluid property in appropriately generalized sense indeed characterizes locally the preferred extremals of Kähler action defining space-time surface.

- (a) Kähler action is Maxwell action with $U(1)$ gauge field replaced with the projection of CP_2 Kähler form so that the four CP_2 coordinates become the dynamical variables at QFT limit. This means enormous reduction in the number of degrees of freedom as compared to the ordinary unifications. The field equations for Kähler action define the dynamics of space-time surfaces and this dynamics reduces to conservation laws for the currents assignable to isometries. This means that the system has a hydrodynamic interpretation. This is a considerable difference to ordinary Maxwell equations. Notice however that the "topological" half of Maxwell's equations (Faraday's induction law and the statement that no non-topological magnetic are possible) is satisfied.
- (b) Even more, the resulting hydrodynamical system allows an interpretation in terms of a perfect fluid. The general ansatz for the preferred extremals of field equations assumes that various conserved currents are proportional to a vector field characterized by so called Beltrami property. The coefficient of proportionality depends on space-time point and the conserved current in question. Beltrami fields by definition is a vector field such that the time parameters assignable to its flow lines integrate to single global coordinate. This is highly non-trivial and one of the implications is almost topological QFT property due to the fact that Kähler action reduces to a boundary term assignable to wormhole throats which are light-like 3-surfaces at the boundaries of regions of space-time with Euclidian and Minkowskian signatures. The Euclidian regions (or wormhole throats, depends on one's tastes) define what I identify as generalized Feynman diagrams.

Beltrami property means that if the time coordinate for a space-time sheet is chosen to be this global flow parameter, all conserved currents have only time component. In TGD framework energy momentum tensor is replaced with a collection of conserved currents assignable to various isometries and the analog of energy momentum tensor complex constructed in this manner has no counterparts of non-diagonal components. Hence the preferred extremals allow an interpretation in terms of perfect fluid without any viscosity.

This argument justifies the expectation that TGD Universe is characterized by the presence of low-viscosity fluids. Real fluids of course have a non-vanishing albeit small value of x . What causes the failure of the exact perfect fluid property?

- (a) Many-sheetedness of the space-time is the underlying reason. Space-time surface decomposes into finite-sized space-time sheets containing topologically condensed smaller space-time sheets containing.... Only within given sheet perfect fluid property holds true and fails at wormhole contacts and because the sheet has a finite size. As a consequence, the global flow parameter exists only in given length and time scale. At imbedding space level and in zero energy ontology the phrasing of the same would be in terms of hierarchy of causal diamonds (CDs).
- (b) The so called eddy viscosity is caused by eddies (vortices) of the flow. The space-time sheets glued to a larger one are indeed analogous to eddies so that the reduction of viscosity to eddy viscosity could make sense quite generally. Also the phase slippage phenomenon of super-conductivity meaning that the total phase increment of the super-conducting order parameter is reduced by a multiple of 2π in phase slippage so that the average velocity proportional to the increment of the phase along the channel divided by the length of the channel is reduced by a quantized amount.

The standard arrangement for measuring viscosity involves a lipid layer flowing along plane. The velocity of flow with respect to the surface increases from $v = 0$ at the lower boundary to v_{upper} at the upper boundary of the layer: this situation can be regarded as outcome of the dissipation process and prevails as long as energy is feeded into the system. The reduction of the velocity in direction orthogonal to the layer means that the flow becomes rotational during dissipation leading to this stationary situation.

This suggests that the elementary building block of dissipation process corresponds to a generation of vortex identifiable as cylindrical space-time sheets parallel to the plane of the flow and orthogonal to the velocity of flow and carrying quantized angular momentum. One expects that vortices have a spectrum labelled by quantum numbers like energy and angular momentum so that dissipation takes in discrete steps by the generation of vortices which transfer the energy and angular momentum to environment and in this manner generate the velocity gradient.

- (c) The quantization of the parameter x is suggestive in this framework. If entropy density and viscosity are both proportional to the density n of the eddies, the value of x would equal to the ratio of the quanta of entropy and kinematic viscosity η/n for single eddy if all eddies are identical. The quantum would be $\hbar/4\pi$ in the units used and the suggestive interpretation is in terms of the quantization of angular momentum. One of course expects a spectrum of eddies so that this simple prediction should hold true only at temperatures for which the excitation energies of vortices are above the thermal energy. The increase of the temperature would suggest that gradually more and more vortices come into play and that the ratio increases in a stepwise manner bringing in mind quantum Hall effect. In TGD Universe the value of \hbar can be large in some situations so that the quantal character of dissipation could become visible even macroscopically. Whether this a situation with large \hbar is encountered even in the case of QCD plasma is an interesting question.

The following poor man's argument tries to make the idea about quantization a little bit more concrete.

- (a) The vortices transfer momentum parallel to the plane from the flow. Therefore they must have momentum parallel to the flow given by the total cm momentum of the vortex. Before continuing some notations are needed. Let the densities of vortices and absorbed vortices

be n and n_{abs} respectively. Denote by v_{\parallel} *resp.* v_{\perp} the components of cm momenta parallel to the main flow *resp.* perpendicular to the plane boundary plane. Let m be the mass of the vortex. Denote by S are parallel to the boundary plane.

- (b) The flow of momentum component parallel to the main flow due to the absorbed at S is

$$n_{abs}mv_{\parallel}v_{\perp}S .$$

This momentum flow must be equal to the viscous force

$$F_{visc} = \eta \frac{v_{\parallel}}{d} \times S .$$

From this one obtains

$$\eta = n_{abs}mv_{\perp}d .$$

If the entropy density is due to the vortices, it equals apart from possible numerical factors to

$$s = n$$

so that one has

$$\frac{\eta}{s} = mv_{\perp}d .$$

This quantity should have lower bound $x = \hbar/4\pi$ and perhaps even quantized in multiples of x . Angular momentum quantization suggests strongly itself as origin of the quantization.

- (c) Local momentum conservation requires that the comoving vortices are created in pairs with opposite momenta and thus propagating with opposite velocities v_{\perp} . Only one half of vortices is absorbed so that one has $n_{abs} = n/2$. Vortex has quantized angular momentum associated with its internal rotation. Angular momentum is generated to the flow since the vortices flowing downwards are absorbed at the boundary surface.

Suppose that the distance of their center of mass lines parallel to plane is $D = \epsilon d$, ϵ a numerical constant not too far from unity. The vortices of the pair moving in opposite direction have same angular momentum $mv D/2$ relative to their center of mass line between them. Angular momentum conservation requires that the sum these relative angular momenta cancels the sum of the angular momenta associated with the vortices themselves. Quantization for the total angular momentum for the pair of vortices gives

$$\frac{\eta}{s} = \frac{n\hbar}{\epsilon}$$

Quantization condition would give

$$\epsilon = 4\pi .$$

One should understand why $D = 4\pi d$ - four times the circumference for the largest circle contained by the boundary layer- should define the minimal distance between the vortices of the pair. This distance is larger than the distance d for maximally sized vortices of radius $d/2$ just touching. This distance obviously increases as the thickness of the boundary layer increases suggesting that also the radius of the vortices scales like d .

- (d) One cannot of course take this detailed model too literally. What is however remarkable that quantization of angular momentum and dissipation mechanism based on vortices identified as space-time sheets indeed could explain why the lower bound for the ratio η/s is so small.

8.6 Could hyperbolic 3-manifolds and hyperbolic lattices be relevant in zero energy ontology?

In zero energy ontology (ZEO) lattices in the 3-D hyperbolic manifold defined by H^3 ($t^2 - x^2 - y^2 - z^2 = a^2$) (and known as hyperbolic space to distinguish it from other hyperbolic manifolds [A12]) emerge naturally. The interpretation of H^3 as a cosmic time=constant slice of space-time of sub-critical Robertson-Walker cosmology (giving future light-cone of M^4 at the limit of vanishing mass density) is relevant now.

8.6.1 Hyperbolic lattices in H^3 from zero energy ontology

In TGD framework zero energy ontology (ZEO) indeed predicts the hyperbolic lattices if one accepts the following argument.

- (a) Causal diamond CD is basic element of ZEO. It is defined as the intersection of a pair of future and past directed light-cones and looks like double pyramid Cartesian product with CP_2 makes it 8-D region off $M^4 \times CP_2$ but the presence of CP_2 as Cartesian factor is not relevant. Its opposite light-like boundaries contain positive and negative energy parts of zero energy states with opposite total quantum numbers. In the usual positive energy ontology zero energy states corresponds to physical events consisting of initial and final states. ZEO is consistent with the crossing symmetry of QFTs. ZEO leads to a generalization of S-matrix concept. The time-like entanglement coefficients between positive and negative energy parts of zero energy state define M-matrix identifiable as a "complex square root" of density matrix and expressible as a product of Hermitian square root of density matrix and unitary S-matrix. One can say that quantum theory corresponds to a square root of thermodynamics in ZEO.
- (b) The "lower" tip of CD can have any position in M^4 : one can argue that these degrees of freedom give rise to 4-momentum. The "upper" tip is at M^4 proper time distance a assumed to be integer multiple of CP_2 size. The assumption motivated by number theoretical considerations (the goal is to fuse real and p-adic physics and real continuum must be effectively replaced by rationals or at most their algebraic extension). One can of course consider also the discretization for the position of the lower tip in M^4 and interpret it in terms of finite measurement resolution for four-momentum.
- (c) One can perform for CD Lorentz boosts preserving the fixed position of "lower" tip but one cannot allow all possible transformations since one would have two separate 3-D continuous degrees of freedom in this case (here is the crux of argument). Therefore I assume that "upper" tip which lies on the hyperbolic space H^3 - hyperboloid - defined by $t^2 - x^2 - y^2 - z^2 = a^2$, $a = n$ in proper units defined by the size scale of CP_2 , can have only discrete positions corresponding to a discrete subgroup G of $SL(2, C)$ (double covering of Lorentz group). Recall that H^3 has negative constant sectional curvature.
- (d) The discrete subgroup G defining G -coset as points of H^3/G is in the most general case discrete subgroup of $SL(2, C)$. It could be also modular subgroup $SL(2, Z)$ or its. Quite generally, one obtains a tessellation of H^3 with a lattice characterizing positions of unit cells H^3/G , which are closed hyperbolic manifolds in absence of singular points known as cusp points and giving rise to punctures and effectively holes. Physically unit cell or fundamental domain corresponds to an open set and effective identification of boundary points comes through "G-periodic" boundary conditions for physical fields analogous to periodic boundary conditions in the case of condensed matter physics. H^3/G has constant negative curvature metric.

Some examples of hyperbolic manifolds

In order to make things more concrete it is good to have some examples about hyperbolic manifolds.

- (a) Examples about hyperbolic manifolds are provided by compactifications of tetrahedron and dodecahedron. It is possible to remove the vertices of tetrahedron and identify the faces of tetrahedron in a pairwise manner to get a compact manifold with boundary having the topology of Klein bottle (non-orientable torus). This manifold is known as Gieseking manifold [A9]. This space has finite volume, is non-orientable, and the boundary corresponds to the cusp. Gieseking manifold is a double cover of the knot complement of figure eight knot which explains why the boundary has genus $g = 1$.
- (b) The so called Seifert-Weber space [A29] is a closed hyperbolic manifold obtained by gluing each face of a dodecahedron with its opposite. So called Weeks manifold [A36] has smallest volume among closed hyperbolic 3-manifolds. If the volume of the hyperbolic manifolds surfaces as the analog of energy in topological thermodynamics, Weeks manifold might be one of the favored 3-manifold topologies.
- (c) Thurston's geometrization conjecture [A35] (actually a theorem thanks to the work of Grigori Perelman) implies that all knot complements except those of satellite knots (they include composites of prime knots and torus knots!) and torus knots (trefoil is the simplest example) are hyperbolic manifolds.
- (d) Kleinian groups [A14] identified as a discrete subgroups G of $PSL(2C)$ acting as isometries of H^3 and conformal symmetries of Riemannian sphere (Möbius transformations) define hyperbolic manifolds as quotients H^3/G . The fundamental group of any hyperbolic manifold is Kleinian group acting also as group of symmetries of a tessellation of H^3 .

Questions

Could hyperbolic lattices and crystals and hyperbolic manifolds have some physical role in TGD?

- (a) The points of hyperbolic lattices could label astrophysical (possibly dark matter) objects. The indications for the existence of astrophysical objects at lines of sight and coming with quantized redshift [E136, E187] supports this picture [K73]. In cosmology redshift for small distances r is from Hubble law given by $v = Hr$ so that the recession velocity - or equivalently cosmic redshift - serves as a natural measure for the distance.
If dark matter objects corresponds to CDs with upper vertices at the points of H^3/G , both the directions and magnitudes of the recession velocities would be quantized. The quantization for the velocities would follow from the quantization of the hyperbolic angle η defining Lorentz boosts as integer multiples of basic value: $\eta = n\eta_0$ giving $v/\sqrt{1-v^2} = \sinh(\eta) = \sinh(n\eta_0)$ ($c = 1$) reducing for non-relativistic velocities to $v \simeq n\eta_0$.
- (b) 3-surface is a fundamental dynamical object in TGD. Hyperbolic 3-manifolds are central in the theory of 3-manifolds, and very many 3-manifolds are hyperbolic. Note that also 2-D manifolds with $g > 1$ are hyperbolic. For instance, knot complements of prime knots are hyperbolic apart from some exceptions, and also surface bundles over circle [A32] are hyperbolic. Thurston's theorem [A34] states that the volume of the hyperbolic manifold defines a topological invariant so that continuous deformations of 3-surfaces would correspond to the same hyperbolic volume, which could thus appear as a counterpart of energy in topological thermodynamics telling which hyperbolic 3-manifold topologies contribute significantly to the physical states (in ZEO this thermodynamics is replaced with its "square root").
- (c) In TGD framework elementary particles correspond to closed flux tube like structures carrying monopole flux. The solutions of the modified Dirac equation [K94] assign to them closed stringy curves, which can get knotted [K41] and in general case when several flux tubes are associated with the elementary particle (say in case of boson) even braiding becomes possible. The homological non-triviality of the knot brings in additional quantum numbers.

It is natural to assign to the flux tube the geometry $X^2 \times S^1$ corresponding to trivial surface bundle over sphere. The two wormhole contacts associated with the ends of the flux tube allow gluing of X^2 from upper space-time sheet with that associated with the lower space-time sheet and this would transform $X^2 \times S^1$ to a non-trivial bundle. Hence the topology of the flux tube could be characterized by hyperbolic volume. The induced metric of course need not be hyperbolic metric.

- (d) What is interesting that the isometry group of H^3 has $SL(2, C)$ as a double covering and H^2 realized as upper half-plane has $SL(2, C)$ as conformal isometries. Could this mean some kind of duality analogous to AdS-CFT duality? The hyperbolic manifolds H^3/G have 2-D boundary: could there be a duality between 2-D conformal field theory at the boundary and string theory in the interior. This is suggested by the strong form of holography (equivalently strong form of general coordinate invariance) stating that partonic 2-surfaces and their 4-D tangent space data code for quantum physics in TGD Universe.

This raises several questions.

- (a) What happens to 3-D Euclidian crystallography when E^3 is replaced with H^3 ? How the negative constant sectional curvature affects the character of lattices obtained?
- (b) Can one build a rough overview about hyperbolic manifolds? Under what conditions the fundamental domain regarded as an open manifold analogous to lattice cell can be compactified by G -periodic boundary conditions to a closed 3-manifold? To me this is not obvious since the compactified manifold could have singularities known as cusps points and represent punctures.
- (c) Does one obtain also hyperbolic quasicrystals? One can imagine also 2-D hyperbolic quasicrystals analogous to Penrose tilings [A22] defined by the imbedding of 2-D hyperbolic manifold H^2 to H^3 (or higher dimensional hyperbolic space) and by projecting the points of H^3 to H^2 along geodesic lines orthogonal to H^3 . One can also imagine 3-D hyperbolic quasicrystals as analogs of Penrose tilings obtained by imbedding H^3 to H^4 or H^5 and performing similar projection.

It turns out that a visit to Wikipedia allows to answer the first two questions.

8.6.2 Comparing crystallographies in E^3 and H^3

Consider first crystallography in E^3 . There exists a large number of lattice like structures depending on detailed definition used and it is good to summarize first the basic notions.

Some definitions

Consider first some basic notions.

- (a) The difference between crystal and lattice is that crystal structure assigns to a given point of lattice some structure, which can be rather complex. In the simplest case this structure is a Platonic solid - a polyhedron which can be regarded as an orbit of a discrete group generated by reflections and rotations.
- (b) Lattice [A3] in 3-D case can be defined group theoretically in terms of the group leaving the lattice invariant. This group - call it G - is generated by the elements of two groups, the chrystallographic point group [A24] and space-group [A31].
Point group leaves at least single point of the lattice fixed and defines the symmetries of the structure attached to the lattice point identified as the center point of the structure. There are 32 point groups and they contain reflections across plane, rotations, inversions (3-D reflecting with respect to origin), and improper rotations (rotations followed by inversion).
Space group contains pure translations, screw transformations rotating around axing and translating along it, and gliding transformation consistent of reflection with respect to plane followed by a translation. There are 230 distinct space groups. The lattice is defined as the set of cosets E^3/G , where G is so called space-group leaving the lattice invariant.
- (c) The lattice points are in the general case linear combinations of three - in general non-orthogonal - basis vectors (a, b, c) generating the discrete subgroup of translations. The condition that one has crystal consisting of say tetrahedrons as unit cells - poses additional conditions. The duals of the lattice vectors defined by their cross products generate dual lattice.

Tesselations

Tesselation or tiling is second key notion and there are many different variants of this notion. The most stringent definition of tesselations considered in following is in terms of by a $n + 1$ -dimensional regular polytope in n -dimensional sphere, Euclidian space, or hyperbolic space.

- (a) Polytopes are constructed of regular p -polygons in turn defining the 2-D faces of 3-D polyhedrons in defining the 4-D polyhedrons.
- (b) n -dimensional tesselations can be defined as boundaries of $n + 1$ -dimensional polygons. Schläfli symbol [A28] allows to represent n -dimensional tesselations in terms of integer n -tuple of integers. In 3-D case one has triple (p, k, r) . p is the number of vertices of 2-polygon defining the face of 3-D polyhedron (p, k) and k is the number of faces associated with a given vertex of the polyhedron. r is the number of 3-D polyhedra associated with a given edge of the tesselation.
- (c) In the case of 2-sphere tesselation in E^3 contains finite number of identical faces projected to the sphere. Tesselations can make sense also if the n -D space is non-compact and the replacement of sphere S^3 of E^4 with hyperbolic space H^3 gives rise to infinite tesselation of H^3 . Also tesselations in hyperbolic manifolds H^3/G are possible and in closed case contain a finite number of basic elements.

Tesselations by regular polytopes [A16] satisfy strong constraints and there are only four tesselations by regular polytopes in H^3 and one in E^3 . The list of tesselations is following.

- i. E^2 allows three regular tesselations by squares, triangles and hexagons: the Schläfli symbols for them are (4,4), (3,6), (6,3).
- ii. H^2 is exceptional and allows infinite number of tesselations.
- iii. E^3 allows single tesselation by cubes: the Schläfli symbol is (4, 3, 4).
- iv. H^3 allows four tesselations. The Schläfli symbols are (3,5,3), (4,3,5), (5,3,4), (5,3,5). Second and third tesselation are dual tesselations by cubes and dodecahedra. First and fourth tesselation correspond to self-dual tesselations by icosahedra and dodecahedra. For instance, for (5,3,5) means each edge has 5 dodecahedrons around it. The large voids with size of order 10^8 ly give rise to honeycomb like structures. Could they correspond to ordinary matter condensed around dark matter honeycomb consisting of dodecahedra?
- v. For $n > 4$ there are three regular tesselations by convex polyhedra in Euclidian space. There are no regular hyperbolic tesselations by convex polyhedra in dimensions $n > 5$.
- (d) If an infinite n -D tesselation is induced by $n + 1$ -D regular polytope, it seems obvious that the polytope must have infinite number of basic units. There indeed exists this kind of infinite polytopes known as infinite skew polytopes [A13]. 1-D lattice requires 2-D zigzag curve reflected from the real axis at the lattice points. In 1-D cases zigzag curve actually gives two parallel lines carrying lattices and the parallel lines together define a boundary of a stripe. Similar doubling is expected in higher dimensions since it is the boundaries of polytopes, which must give rise to H^n or E^n .
- (e) The tesselations having E^3/G as a unit cell are obtained by assuming G to be a subgroup of translations. As already noticed this subgroup in question is generated by 3 generators represented by - in general non-orthogonal vectors - and the fundamental domain is parallelepiped generated by these vectors. When the vectors are orthogonal and have same length one obtains the regular tesselation by cubes. The four tesselations by regular polytopes must be distinguished from the infinite number of tesselations defined by the orbit of discrete subgroup $G \subset PSL(2, C)$ in H^3 with fundamental domain H^3/G replacing the polyhedron as a basic unit. The case of E^3 suggests that these tesselations give as a special case the 4-tesselations using regular polytopes. A good first guess is that G is generated by Lorentz boosts with same velocity in 3 orthogonal directions.

Tesselations of H^3

Consider now the case of H^3 more closely.

- (a) In the case of H^3 a discrete subgroup G of Lorentz group $SL(2, C)$ with infinite number of elements representing Lorentz boosts replaces discrete subgroup of translations in E^3 . G is known as Kleinian group [A14]. G can be also restricted to be a subgroup of the modular group $SL(2, Z)$. Note that $G = SL(2, Z)$ is braid group for 3-braid divided by its center and isomorphic to the knot group of trefoil as one learns from Wikipedia [A19]. Therefore the subgroups of the knot group of trefoil are very interesting concerning lattices in H^3 . The complement of trefoil and any torus knot however fails to defined hyperbolic 3-manifold. For larger subgroups of $SL(2, C)$ one obtains smaller fundamental domain and more lattice points.
- (b) For non-compact discrete subgroups of $SL(2, Z)$ (and also $SL(2, C)$!) the lattice consists in the language of cosmologist of locations of astrophysical objects (possibly consisting of dark matter) with quantized redshifts and direction angles. The counterparts of parallelepipeds are interiors of hyperbolic 3-manifolds and there are very many of them. For prime knot complements which very often are hyperbolic 3-manifolds, the boundary is torus and allows a constant sectional curvature metric with vanishing sectional curvature. This motivates the question whether $g > 1$ negative constant sectional curvature 2-surfaces could appear as boundaries of hyperbolic 3-manifolds.
- (c) It is not completely obvious how to define the edges and faces of hyperbolic polygons. Edges are naturally defined as geodesic lines but what about faces. In E^3 they are pieces of plane which are minimal surfaces but also geodesic sub-manifolds with vanishing second fundamental form meaning that all geodesics of these surfaces are also geodesics of E^3 . Minimal 2-surfaces are by definition manifolds with a negative curvature and this seems to fit with the negative curvature property of H^3 . H^3 , E^3 , and S^3 are very closely related (they define the 3 constant sectional curvature Robertson Walker cosmologies) In the case of S^3 spheres S^2 are geodesic sub-manifolds. In the similar manner H^2 defines a geodesic sub-manifold of H^3 . If so, the faces would be 2-D hyperbolic manifolds with boundary, and having constant negative sectional curvature.
- (d) One can wonder what is the 4-D space used to define H^3 tessellations. Is it Minkowski space M^4 or is it H^4 ? The first problem is that tessellation is infinite. Second problem is that H^3 should but cannot play the same role as sphere S^2 in E^3 . The problem is that H^3 can be thought of as having boundary at infinity, and therefore is not itself a boundary unlike S^2 . It is the boundary property of S^2 , which allows to assign Platonic solid with the vertices of tetrahedron at the surface of S^2 .

Infinite tessellation requires infinite polytope as already noticed. For $1 - D$ tessellation one has zigzag curve in planar stripe, and one obtains two copies of the tessellation defining a boundary of 2-D stripe. Are the segments of zigzag curve replaced by a 4-D object having as boundary cube, icosahedron, or dodecahedron of H^3 ? Does the boundary property require that there are two lattices at hyperboloids $a = a_1$ and $a = a_2$ of M^4 . These hyperboloids define a boundary and one can speak about the interior and boundary of 4-D polytope.

An interesting question is how this relates to zero energy ontology, where CD plays a key role. Can one imagine that the pair of H^3 :s is replaced with a pairs of hyperboloids with opposite time orientation so that their intersection consists of temporal mirror images of part of H^3 glued together along 2-sphere (this could be seen as a generalization of CD)? The boundaries of CD would correspond to the limiting case $a = 0$ for H^3 giving light-cone boundary for which radial coordinate does not contribute to metric so that metrically one has 2-D sphere (this makes possible huge extension of conformal invariance in TGD Universe). How could one define tessellations of light-cone boundary?

- (e) For Platonic solids boundary is always topologically a sphere. For prime knot complements the boundary is 2-torus $S^1 \times S^1$. What does this mean geometrically in the gluing of fundamental domains together? Also 2-surface bundles over spheres are hyperbolic manifolds and are obtained by identifying the ends of $X^2 \times D^1$ by a homeomorphism. The homotopy equivalence class of the map $X^2 \rightarrow X^2$ characterizes the bundle structure. In this case one should fill the twisted torus like surface by polygon lattice.

8.6.3 Quasicrystals

One can also ask whether hyperbolic quasicrystals are possible. In the following some basic facts about quasicrystals are summarized and some questions relating to the dynamics of quasicrystals are considered before brief comments on hyperbolic quasicrystals.

Basic facts about quasicrystals

Quasicrystals are lattices, which do not have translational symmetries. Quasicrystals can be finite or infinite and only in special cases local matching rules give rise to infinite quasicrystal instead of finite local empire (to be defined later). The so called empire problem for Penrose tilings has been solved by Laura Effinger-Dean [A47].

- (a) Especially interesting example about quasiperiodic 2-D lattices are Penrose tilings [A22] for which basic objects have 5-fold local rotation symmetry: this is not allowed in ordinary crystallography. They are also self-similar. Their number is uncountably infinite. There is a theorem [A22] stating that Penrose tilings are obtained as projections of 5-dimensional lattices to 2-D plane imbedded in 5-D Euclidian space. If the parameters characterizing the plane have irrational values one obtains quasicrystal. This theorem generalizes to Euclidian spaces E^n imbedded to higher-dimensional Euclidian spaces E^{n+k} carrying lattice structure.
- (b) In the case of Penrose tiling the plane is characterized by its normal space characterizing the orientation of the plane: for rational values of the "slope" of the plane one obtains periodic lattices with finite number of points projected to same point at E^2 . For irrationals slopes just one point is projected to a given point of E^2 . One can regard the space of the plane imbeddings containing also Penrose tilings as a coset space $SO(5)/SO(2) \times SO(3)$ having dimension $D = 10 - 1 - 3 = 6$. The space for Penrose tilings (with crystals excluded) is rather delicate mathematical notion and represents basic example of a non-commutative geometry [A56].
- (c) An important concept related to Penrose tilings is the notion of empire already mentioned [A47]. One starts from a given "seed" for a quasicrystal, and builds a larger quasicrystal using local matching rules forbidding gaps. Local empire is the largest quasicrystal obtained in this manner and is a connected structure. Empire in turn is the largest set of tiles shared by all tilings containing the "seed" and is in general non-connected and can be even infinite. For ordinary crystals single unit cell fixes the lattice completely as its empire.

About dynamics of quasicrystals

Consider next possible dynamics of quasicrystals.

- (a) The fact that the local matching rules are not enough to construct infinite quasicrystal uniquely and that there is no guarantee that a given seed leads to infinite quasicrystal led Penrose to ask whether the formation of quasicrystal involves macroscopic quantum phase transition in which quasicrystal is created in single quantum leap rather than being a result of growth process. Experimentalist can of course argue that real quasicrystals are always infinite and this is just because the growth process stops because local matching rules fail at some step.
- (b) The conditions that quasicrystal property is preserved in the dynamics of quasicrystal is extremely strong. One manner to satisfy it would be the reduction of the dynamics to dynamics in the space of quasicrystals and crystals. The rigid body dynamics associated with the rotation of E^n in E^{n+k} containing the mother crystal would induce the variation of the projection of the crystal to E^n containing also quasicrystal configurations. In the case of imbeddings $E^2 \subset E^5$ containing also Penrose tilings, the analog of rigid body motion would take place in $SO(5)/SO(3) \times SO(2)$. This dynamics can be solved both classically and quantum mechanically. The special feature of the dynamics would be correlation between short and long scale aspects of the dynamics since both local consistency rules and global consistency rules are automatically satisfied.

- (c) Quasicrystal excitations are known as phasons [D15]. The intriguing observation is that they can be described using hydrodynamics (long length scale description) and microscopically as re-arrangements of nearby atoms. There is a strong correlation between short and long length scales. If quasicrystal property is preserved by the dynamics, this is expected. The reduction to rigid body dynamics with only 6 degrees of freedom might of course be quite too restrictive an assumption and it is quite possible that the excitations have nothing to do with quasicrystallinity. Macroscopic quantum transitions can be also considered. The most mundane explanation would be in terms of thermodynamics: in ZEO square root of thermodynamics could unify quantal and thermodynamical explanations.

What about hyperbolic quasicrystals?

Hyperbolic 2-D quasicrystals are of special interest in TGD since they can be assigned to the spaces H^2 imbedded to H^3 . Could one generalize the construction of Penrose tilings to a construction recipe for hyperbolic quasicrystals? For the hyperbolic counterparts of Penrose tilings one could imagine isometric imbedding of $H^2 \subset H^n$, $n > 2$. H^3 is the physically preferred option in TGD. Imbedding would represent 2-D hyperboloid $H^2 = SO(1,2)/SO(2)$ of M^3 as constant sectional curvature sub-manifold of n -dimensional hyperboloid in $H^n = SO(1,n)/SO(n)$. There is a continuum of this kind of imbeddings. In the compact case one has imbeddings of S^2 to S^3 and the space of imbeddings is $SO(3)/SO(1) \times SO(2) = S^1$. Same holds true in the hyperbolic case. For $H^n \subset H^{n+k}$ one has $SO(n+k)/SO(n) \times SO(k)$. One can consider also 3-D hyperbolic quasicrystals and the imbedding $H^3 \rightarrow H^n$, $n > 3$ might give this kind of quasicrystals. This imbedding would not however have a concrete geometric interpretation in TGD framework.

Could hyperbolic 2-planes or finite pieces of them allow a physical interpretation as 2-D physical systems in cosmological scales? Certainly the existence of quasicrystals and even more that of crystals in cosmological scales requires quantum coherence in cosmological scales, and dark matter and dark energy as phases with large and even gigantic value of Planck constant [K30] [L10] could give rise this kind of structures.

8.6.4 Could quasi-lattices and quasi-crystals emerge from the notion of p-adic manifold?

This section is inspired by the considerations of the new chapter "What p-adic icosahedron could mean? And what about p-adic manifold?" [K96]. The original purpose was to understand what the notion of p-adic icosahedron could mean but soon it turned out that the key challenge is to understand what p-adic manifold means. Also in TGD framework this is one of the basic challenges posed by the condition of number theoretical universality and the idea about algebraic continuation of physics between different number fields.

The basic problem is that p-adic topology is totally disconnected meaning that p-adic balls are either disjoint or nested so that the usual construction of manifold structure fails. The basic criticism against the notion of p-adic icosahedron, and more generally, the notion of p-adic manifold, is the technical complexity of the existing constructions by mathematicians.

TGD however suggests much simpler construction. The construction relies on a simple modification of the notion of manifold inspired by the interpretation of p-adic preferred extremals defining counterparts of real preferred extremals as cognitive representations of the latter. This requires a mapping from p-adic preferred extremals to real ones and vice versa. In manifold theory chart maps are the analogs of these maps and the only difference is that they are between different number fields.

What I have christened as canonical identification $I_{k,l}^Q$ mapping rationals $p^{rk}m/n$ with $|m|_p > p^{-k}$, $|n|_p > p^{-l}$, as $I_{k,l}^Q(p^{rk}(m/n)) = p^{-rk}I_{k,l}(m)/I_{k,l}(n)$, where $I_{k,l}(m) = \sum m_n p^{nk} = \sum_{n < l} m_n p^{-nk}$ defines canonical identification for p-adic numbers m, n satisfying the above conditions in their binary expansion with two cutoffs k and l . $I_{k,l}^Q$ is ill defined for irrational p-adic numbers since

for them the representation as rational is not unique. A generalization to algebraic extensions is straightforward.

$I_{k,l}^Q$ is a compromise between the direct identification along common rationals favored by algebra and symmetries but being totally discontinuous without the cutoff $n < l$. This cutoff breaks symmetries slightly but guarantees continuity in finite measurement resolution defined by the binary cutoff l . Symmetry breaking can be made arbitrarily small and has interpretation in terms of finite measurement resolution. Due to the binary cutoff the chart map applied to various p-adic coordinates takes discrete set of rationals to discrete set of rationals and preferred extremal property can be used to make a completion to a real space-time surface. Uniqueness is achieved only in finite measurement resolution and is indeed just what is needed. Also general coordinate invariance is broken in finite measurement resolution. In TGD framework it is however possible to find preferred coordinates in order to minimize this symmetry breaking.

TGD based view about p-adic manifolds

The construction of p-adic manifold topology somehow overcoming the difficulty posed by the fact that p-adic balls are either disjoint or nested is necessary. It should also allow a close relationship between p-adic and real preferred extremals. It will be found that TGD leads naturally to a proposal of p-adic manifold topology [K96] based on canonical identification used to map the predictions of p-adic mass calculations to real numbers. This map would define coordinate charts for p-adic space-time surfaces - not as p-adic chart leafs as in the standard approach - but as real chart leafs. The real topology induced from real map leafs to the p-adic realm would be path-connected as required.

In TGD framework one must also require finite measurement resolution meaning that the canonical identification is characterized by binary cutoff takes a discrete subset of rational points of p-adic preferred extremal to its real counterpart: for a subset of this subset rationals are mapped to themselves. One can complete this point set to a real preferred extremal in finite measurement resolution. This construction allows also to define p-adic integrals and differential forms in terms of their real counterparts by algebraic continuation. Therefore geometric notions like distance and volume make sense and there is a very close correspondence between real space-time geometries and their p-adic counterpart in the situations when they exist.

Can one consider a p-adic generalization of Penrose tiling and quasicrystals?

The mathematically rigorous generalization of Penrose Tilings and quasicrystals to p-adic context might be possible but is bound to be rather technical. The p-adic icosahedron as it is defined in the article does not seem very promising notion. The point is that it is defined in terms of fixed point set for subgroups of icosahedral group acting on Riemann sphere: the action in Euclidian 3-space is now more natural and certainly makes sense and actually simplifies the situation since Q_p^3 sd analog of E^3 is simplest possible 3-D p-adic manifold. It does not however allow Bruhat-Tits tree since the points of Q_p^n are not in 1-1 correspondence with the lattices of Q_p^n . The possibility to construct Bruhat-Tits tree is a special feature of projective spaces.

TGD based view about p-adic E^3 and S^2 as its sub-manifold allows to define also the counterpart of Penrose tiling and QCs in an elegant manner with a close relationship between real and p-adic variants of QC.

- (a) If one considers lattices in n -dimensional p-adic space Q_p^n replacing E^n , a more natural definition would be in terms of this space than in terms of sphere. For the counterpart of E^3 one can define the action of the subgroup A_5 of rotation group $SO(3)$ by introducing an algebraic extension of the p-adic numbers containing $\cos(2\pi/5)$, $\sin(2\pi/5)$ and $\cos(2\pi/3)$, $\sin(2\pi/3)$ and their products. What is interesting is that algebraic extension is forced automatically in p-adic context! In cut and project method [A44] the QC structure requires also this since the imbedded space has an algebraic dimension over integers equal to the dimension of the imbedding space over reals.

Could it be that p-adic variants of QCs might provide number theoretic insights about QCs? Subspace would define algebraic extension of p-adic numbers and this extension would be such that it allows the representation of the isometry group of the Platonic solid possibly assignable to the QC.

- (b) One can also now define the icosahedron or any Platonic solid in terms of fixed points also now. Only discrete subgroups of the rotation group can be represented p-adically since algebraic extension is required. This brings in mind the notion of finite measurement resolution leading to a discretization of p-adically representable rotations and more general symmetries. For instance, without algebraic extension only rotations for which the rotation matrices are rational numbers are representable. It seems that finite subgroups of this kind are generated by rotations with rotation angle $\pi/2$ around various coordinate axes. Pythagorean triangles correspond to rational values of cosine and sine and rotations for which rotation angle corresponds to Pythagorean angle define rational rotation matrices: these groups are discrete but contain infinite number of elements.

Altogether this suggests a hierarchy of p-adic extensions leading to higher algebraic dimensions and larger discrete symmetries. This conforms with the general number theoretic vision about TGD.

- (c) Lattices in Q_p^n with integer coefficients make also sense and are characterized by n linearly independent (over p-adic integers) basic vectors (a_1, \dots, a_n) . Most points of lattice would correspond to values of p-adic integers n_i in $\sum_i n_i a_i$ infinite as real numbers.

Consider first a non-realistic option in which p-adic integers are mapped to p-adic integers as such. Note also that most of p-adic lattice points would map to real infinity. This kind of correspondence makes sense also for rationals but would give a totally discontinuous correspondence between reals and p-adics.

p-Adic manifold topology defined in terms of the canonical identification I_{kl} allows to interpret the p-adic lattice as a cognitive representation of the real one. The presence of binary cutoffs k and l having interpretation in terms of finite cognitive resolution has two implications. Integers $n_i < p^k$ are mapped to themselves so that this portion of lattice is mapped to itself faithfully. The integers $k \leq n < l$ are not mapped to integers and the length of the image is bounded below. The real image of the p-adic lattice under I_{kl} is necessarily compressed to a finite volume of E^3 . This kind of compression and cutoff is natural for cognitive representations for which numerics with finite cutoff provides one particular analogy.

- (d) Could the notion of p-adic QC and Penrose tiling make sense if one considers p-adic counterparts of Euclidian space and a n-D cubic lattice with integer valued coefficients and spanned by unit vectors? Could the cut and project method generalize [A44]?

This is not clear since projection would lead from a lattice in Q_p^n to a QC in lower-dimensional space which is associated with algebraic extension of Q_p but having algebraic dimension equal to n . If this space is K^m , K an algebraic extension of Q_p , one has $n = \dim(K) \times m$. For prime values of n this would mean that $m = 1$ and one has n-D algebraic extension.

Projection should be generalized to a map mapping points of n-D space to m-dimensional subspace K^m associated with algebraic extension of Q_p . Maybe it is better to formally extend Q_p^n to K^n and restrict the lattice to integer lattice in $Q_p^n \subset K^n$. In this manner the projection becomes well-defined as map from $Q_p^n \subset K^n$ to a subspace K^m of K^n . The basic condition could be that the points of the subspace K^m in K^n with algebraic dimension $n \times \dim(K)$ define an m -dimensional subspace over K and n-dimensional subspace of Z_p . The "irrational angles" associated with the lower-dimensional subspace defining quasilattice defining algebraic extension of Q_p should be such that it allows the representation of the isometry group of the p-adic Platonic solid possibly assignable to the QC in question.

Cut and project construction of quasicrystals from TGD point of view

Cut and project [?] method is used to construct quasicrystals (QCs) in sub-spaces of a higher-dimensional linear space containing an ordinary space filling lattice, say cubic lattice. For

instance, 2-D Penrose tiling is obtained as a projection of part of 5-D cubic lattice - known as Voronyi cell - around 2-D sub-space imbedded in five-dimensional space. The orientation of the 2-D sub-space must be chosen properly to get Penrose tiling. The nice feature of the construction is that it gives the entire 2-D QC. Using local matching rules the construction typically stops.

1. *Sub-manifold gravity and generalization of cut and project method*

The representation of space-time surfaces as sub-manifolds of 8-D $H = M^4 \times CP_2$ can be seen as a generalization of cut and project method.

- (a) The space-time surface is not anymore a linear 4-D sub-space as it would be in cut and project method but becomes curved and can have arbitrary topology. The imbedding space ceases to be linear $M^8 = M^4 \times E^4$ since E^4 is compactified to CP_2 . Space-time surface is not a lattice but continuum.
- (b) The induction procedure geometrizing metric and gauge fields is nothing but projection for H metric and spinor connection at the continuum limit. Killing vectors for CP_2 isometries can be identified as classical gluon fields. The projections of the gamma matrices of H define induced gamma matrices at space-time surface. The spinors of H contain additional components allowing interpretation in terms of electroweak spin and hyper-charge.

2. *Finite measurement resolution and construction of p-adic counterparts of preferred extremals forces "cut and project" via discretization*

In finite measurement resolution realized as discretization by finite binary cutoff one can expect to obtain the analog of cut and project since 8-D imbedding space is replaced with a lattice structure.

- (a) The p-adic/real manifold structure for space-time is induced from that for H so that the construction of p-adic manifold reduces to that for H .
- (b) The definition of the manifold structure for H in number theoretically universal manner requires for H discretization in terms of rational points in some finite region of M^4 . Binary cutoffs- two of them - imply that the manifold structures are parametrized by these cutoffs characterizing measurement resolution. Second cutoff means that the lattice structure is piece of an infinite lattice. First cutoff means that only part of this piece is a direct image of real/p-adic lattice on p-adic/real side obtained by identifying common rationals (now integers) of real and p-adic number fields. The mapping of this kind lattice from real/p-adic side to p-adic/real side defines the discrete coordinate chart and the completion of this discrete structure to a preferred extremal gives a smooth space-time surface also in p-adic side if it is known on real side (and vice versa).
- (c) Cubic lattice structures with integer points are of course the simplest ones for the purposes of discretization and the most natural choice for M^4 . For CP_2 the lattice is completely analogous to the finite lattices at sphere defined by orbits of discrete subgroups of rotation group and the analogs of Platonic solids emerge. Probably some mathematician has listed the Platonic solids in CP_2 .
- (d) The important point is that this lattice like structure is defined at the level of the 8-D imbedding space rather than in space-time and the lattice structure at space-time level contains those points of the 8-D lattice like structure, which belong to the space-time surface. Finite measurement resolution suggests that all points of lattice, whose distance from space-time surface is below the measurement resolution for distance are projected to the space-time surface. Since space-time surface is curved, the lattice like structure at space-time level obtained by projection is more general than QC.

The lattice like structure results as a manifestation of finite measurement resolution both at real and p-adic sides and can be formally interpreted in terms of a generalization of cut and project but for a curved space-time surface rather than 4-D linear space, and for H rather than 8-D Minkowski space. It is of course far from clear whether one can obtain anything looking like say 3-D or 4-D version of Penrose tiling.

- (a) The size scale of CP_2 is so small (10^4 Planck lengths) that space-time surfaces with 4-D M^4 projection look like M^4 in an excellent first approximation and using M^4 coordinates the projected lattice looks like cubic lattice in M^4 except that the distances between points are not quite the M^4 distances but scaled by an amount determined by the difference between induced metric and M^4 metric. The effect is however very small if one believes on the general relativistic intuition.

In TGD framework one however can have so called warped imbeddings of M^4 for which the component of the induced metric in some direction is scaled but curvature tensor and thus gravitational field vanishes. In time direction this scaling would imply anomalous time dilation in absence of gravitational fields. This would however cause only a the compression or expansion of M^4 lattice in some direction.

- (b) For Euclidian regions of space-time surface having interpretation as lines of generalized Feynman diagrams M^4 projection is 3-dimensional and at elementary particle level the scale associated with M^4 degrees of freedom is roughly the same as CP_2 scale. If CP_2 coordinates are used (very natural) one obtains deformation of a finite lattice-like structure in CP_2 analogous to a deformation of Platonic solid regarded as point set at sphere. Whether this lattice like structure could be seen as a subset of infinite lattice is not clear.
- (c) One can consider also string like objects $X^2 \times Y^2 \subset M^4 \times CP_2$ with 2-D M^4 projection and their deformations. In this case the projection of M^4 lattice to X^2 - having subset of two M^4 coordinates as coordinates - can differ considerably from a regular lattice since X^2 can be locally tilted with respect to M^4 lattice. This cannot however give rise to Penrose tiling requiring 5-D flat imbedding space. This argument applies also to 2-D string world sheets carrying spinor modes. In the idealized situation that string world sheet is plane in M^4 one might obtain an analog of Penrose tiling but with 4-D imbedding space.

The above quasi lattice like structures (QLs) are defined by a gravitational deformation of the cubic lattice of M^4 . Is there any hope about the 4-D QLs in M^4 so that gravitation would give rise to the analogs of phason waves deforming them? Could cut and project method be generalized to give QL in M^4 as projection of 8-D cubic lattice in M^8 ?

3. $M^8 - H$ duality

Before considering an explicit proposal I try to describe what I call $M^8 - H$ duality ($H = M^4 \times CP_2$).

- (a) What I have christened $M^8 - H$ duality is a conjecture stating that TGD can be equivalently defined in M^8 or $M^4 \times CP_2$. This is the number theoretic counterpart of spontaneous compactification of string models but has nothing to do with dynamics: only two equivalent representations of dynamics would be in question.
- (b) Space-time surfaces (preferred extremals) in M^8 are postulated to be quaternionic sub-manifolds of M^8 possessing a fixed $M^2 \subset M^4 \subset M^8$ as sub-space of tangent space. "Quaternionic" means that the tangent space of M^4 is quaternionic and thus associative. Associativity conditions would thus determine classical dynamics. More generally, these subspaces $M^2 \subset M^8$ can form integrable distribution and they define tangent spaces of a 2-D sub-manifold of M^4 . If this duality really holds true, space-time surfaces would define a lattice like structure projected from a cubic M^8 lattice. This of course does not guarantee anything: $M^8 - H$ duality itself suggests that these lattice like structures differ from regular M^4 crystals only by small gravitational effects.
- (c) The crucial point is that quaternionic sub-spaces are parametrized by CP_2 . Quaternionic 4-surfaces of $M^8 = M^4 \times CP_2$ containing the fixed $M^2 \subset M^8$ can be mapped to those of $M^4 \times CP_2$ by defining M^4 coordinates as projections to preferred $M^4 \subset M^8$ and CP_2 coordinates as those specifying the tangent space of 4-surface at given point.
- (d) A second crucial point is that the preferred subspace $M^4 \subset M^8$ can be chosen in very many manners. This imbedding is a complete analog of the imbedding of lower-D subspace to higher-D one in cut and project method. M^4 can be identified as any 4-D subspace

imbedded in M^4 and the group $SO(1, 7)$ of 8-D Lorentz transformations defines different imbeddings of M^4 to M^8 . The moduli space of different imbeddings of M^4 is the Grassmannian $SO(1, 7)/SO(1, 3) \times SO(4)$ and has dimension $D = 28 - 6 - 6 = 16$.

When one fixes two coordinate axes as the real and one imaginary direction (physical interpretation is as an identification of rest system and spin quantization axes), one obtains $SO(1, 7)/SO(2) \times SO(4)$ with higher dimension $D = 28 - 1 - 6 = 21$. When one requires also quaternionic structure one obtains the space $SO(1, 7)/SU(1) \times SU(2)$ with dimension $D = 28 - 4 = 24$. Amusingly, this happens to be the number of physical degrees of freedom in bosonic string model.

5. How to obtain quasilattices and quasi-crystals in M^4 ?

Can one obtain quasi-lattice like structures (QLs) at space-time level in this framework? Consider first the space-time QLs possibly associated with the standard cubic lattice L_{st}^4 of M^4 resulting as projections of the cubic lattice structure L_{st}^8 of M^8 .

- (a) Suppose that one fixes a cubic crystal lattice in M^8 , call it L_{st}^8 . Standard M^4 cubic lattice L_{st}^4 is obtained as a projection to some M^4 sub-space of M^8 by simply putting 4 Euclidian coordinates for lattice points constant. These sub-spaces are analogous to 2-D coordinate planes of E^3 in fixed Cartesian coordinates. There are $7!/3!4! = 35$ choices of this kind.

One can consider also E_8 lattice is an interesting identification for the lattice of M^8 since E_8 is self-dual and defines the root lattice of the exceptional group E_8 . E_8 is union of Z^8 and $(Z + 1/2)^8$ with the condition that the sum of all coordinates is an even integer. Therefore all lattice coordinates are either integers or half-integers. E_8 is a sub-lattice of 8-D cubic lattice with 8 generating vectors $e_i/2$, with e_i unit vector. Integral octonions are obtained from E_8 by scaling with factor 2. For this option one can imbed L_{st}^4 as a sub-lattice to Z^8 or $(Z + 1/2)^8$.

- (b) Although $SO(1, 3)$ leaves the imbedded 4-plane M^4 invariant, it transforms the 4-D crystal lattice non-trivially so that all 4-D Lorentz transforms are obtained and define different discretizations of M^4 . These are however cubic lattices in the Lorentz transformed M^4 coordinates so that this brings nothing new. The QLs at space-time surface should be obtained as gravitational deformations of cubic lattice in M^4 .
- (c) L_{st}^4 indeed defines 4-D lattice at space-time surface apart from small gravitational effects in Minkowskian space-time regions. Elementary particles are identified in TGD a Euclidian space-time regions - deformed CP_2 type vacuum extremals. Also black-hole interiors are replaced with Euclidian regions: black-hole is like a line of a generalized Feynman diagram, elementary particle in some sense in the size scale of the black-hole. More generally, all physical objects, even in everyday scales, could possess a space-time sheet with Euclidian metric signature characterizing their size (AdS⁵/CFT correspondence could inspire this idea). At these Euclidian space-time sheets gravitational fields are strong since even the signature of the induced metric is changed at their light-like boundary. Could it be that in this kind of situation lattice like structures, even QCs, could be formed purely gravitationally? Probably not: an interpretation as lattice vibrations for these deformations would be more natural.

It seems that QLs are needed *already at the level of M^4* . $M^8 - H$ duality indeed provides a natural manner to obtain them.

- (a) The point is that the projections of L_{str}^8 to sub-spaces M^4 defined as the $SO(1, 7)$ Lorentz transforms of L_{st}^4 define generalized QLs parametrized by 16-D moduli space $SO(1, 7)/SO(1, 3) \times SO(4)$. These QLs include also QCs. Presumably QC is a QL possessing a non-trivial point group just like Penrose tiling has the isometry group of dodecagon as point group and 3-D analog of Penrose tiling has the isometries of icosahedron as point group.

This would allow to conclude that the discretization at the level of M^8 required by the definition of p-adic variants of preferred extremals as cognitive representations of their real counterparts would make possible 4-D QCs. M^8 formulation of TGD would explain

naturally the QL lattices as discretizations forced by finite measurement resolution and cognitive resolution.

A strong number theoretical constraint on these discretizations come from the condition that the 4-D lattice like structure corresponds to an algebraic extension of rationals. Even more, if this algebraic extension is 8-D (perhaps un-necessarily strong condition), there are extremely strong constraints on the 22-parameters of the imbedding. Note that in p-adic context the algebraic extension dictates the maximal isometry group identified as subgroup of $SO(1,7)$ assignable to the imbedding as the discussion of p-adic icosahedron demonstrates.

- (b) What about the physical interpretation of these QLs/QCs? As such QLs define only natural discretizations rather than physical lattices. It is of course quite possible to have also physical QLs/QCs such that the points - rather time like edge paths - of the discretization contain real particles. What about a "particle" localized to a point of 4-D lattice? In positive energy ontology there is no obvious answer to the question. In zero energy ontology the lattice point could correspond to a small causal diamond containing a zero energy state. In QFT context one would speak of quantum fluctuation. In p-adic context it would correspond to "though bubble" lasting for a finite time.
- (c) It is also possible to identify physical particles as edge paths of the 4-D QC, and one can consider time= constant snapshots as candidates for 3-D QCs. It is quite conceivable that the non-trivial point group of QCs favors them as physical QLs.

5. *Expanding hyperbolic tessellations and quasi tessellations obtained by imbedding $H^3 \subset M^4$ to $H^7 \subset M^8$*

M^8 - $M^4 \times CP_2$ duality and the discretization required by the notion of p-adic manifold relates in an interesting manner to expanding hyperbolic tessellations and quasi tessellations in $H^7 \subset M^8$, and possible expanding quasi-tessellations in obtained by imbedding $H^3 \subset M^4$ to $H^7 \subset M^8$

- (a) Euclidian lattices E_8, E_7, E_6

I have already considered E_8 lattice in M^8 . The background space has however Minkowskian rather than Euclidian metric natural for the carrier space of the E_8 lattice. If one assigns some discrete subgroup of isometries to it, it is naturally subgroup of $SO(8)$ rather than $SO(1,7)$. Both these groups have $SO(7)$ as a subgroup meaning that preferred time direction is chosen as that associated with the real unit and considers a lattice formed from imaginary octonions.

E_8 lattice scaled up by a factor 2 to integer lattice allows octonionic integer multiplication besides sums of points so that the automorphism group of octonions: discreted subgroups of $G_2 \subset SO(7)$ would be the natural candidates for point groups crystals or lattice like structures.

If one assumes also fixed spatial direction identified as a preferred imaginary unit, G_2 reduces to $SU(3) \subset SO(6) = SU(4)$ identifiable physically as color group in TGD framework. From this one ends up with the idea about $M^8 - M^4 \times CP_2$ duality. Different imbeddings of $M^4 \subset M^8$ are quaternionic sub-spaces containing fixed M^2 are labelled by points of CP_2 .

All this suggests that E_7 lattice in time=constant section of even E_6 lattice is a more natural object lattice to consider. Kind of symmetry breaking scenario $E_8 \rightarrow E_7 \rightarrow E_6 \rightarrow G_2 \rightarrow SU(3)$ is suggestive. This Euclidian lattice would be completely analogous to a slicing of 4-D space-time by 3-D lattices labelled by the value of time coordinate and is of course just what physical considerations suggest.

- (b) Hyperbolic tessellations

Besides crystals defined by a cubic lattice or associated with E_6 or E_7 , one obtains an infinite number of hyperbolic tessellations in the case of M^8 . These are much more natural in Minkowskian signature and could be also cosmologically very interesting. Quite generally, one can say that hyperbolic space is ideal for space-filling packings defined by hyperbolic manifolds H^n/Γ : they are completely analogous to space-filling packings of E^3 defined by

discrete subgroups of translation group producing packings of E^3 by rhombohedra. One only replaces discrete translations with discrete Lorentz transformations. This is what makes these highly interesting from the point of view of quantum gravity.

- i. In M^{n+1} one has tessellations of n -dimensional hyperboloid H^n defined by $t^2 - x_1^2 - \dots - x_n^2 = a^2 > 0$, where a defines Lorentz invariant which for $n = 4$ has interpretation as cosmic time in TGD framework. Any discrete subgroup Γ of the Lorentz group $SO(1, n)$ of M^{n+1} with suitable additional conditions (finite number of generators at least) allows a tessellation of H^n by basic unit H^n/Γ . These tessellations come as 1-parameter families labelled by the cosmic time parameter a . These 3-D tessellations participate cosmic expansion. Of course, also ordinary crystals are crystals only in spatial directions. One can of course discretize the values of a or some function of a in integer multiples of basic unit and assign to each copy of H^n/Γ a "center point" to obtain discretization of M^{n+1} needed for p-adicization.
- ii. For $n = 3$ one has M^4 and H^3 , and this is very relevant in TGD cosmology. The parameter a defines a Lorentz invariant cosmic time for the imbeddings of Robertson-Walker cosmologies to $M^4 \times CP_2$. The tessellations realized as physical lattices would have natural interpretation as expanding 3-D lattice like structures in cosmic scales. What is new is that discrete translations are replaced by discrete Lorentz boosts, which correspond to discrete velocities and observationally to discrete red shifts for distant objects. Interestingly, it has been found that red shift is quantized along straight lines [E136]: "God's fingers" is the term used. I proposed for roughly two decades ago an explanation based on closed orbits of photons around cosmic strings [K24]. but explanation in terms of tessellations would also give rise to periodicity. A fascinating possibility is that these tessellation have defined macroscopically quantum coherent structures during the very early cosmology the the size scale of H^3/Γ was very small. One can also ask whether the macroscopic quantum coherence could still be there. Hyperbolic manifold property has purely local signatures such as angle surplus: the very fact that there are infinite number of hyperbolic tessellations is in conflict with the the fact that we have Euclidian 3-geometry in every day length scales. In fact, for critical cosmologies, which allow a one-parameter family of imbeddings to $M^4 \times CP_2$ (parameter characterizes the duration of the cosmology) one obtains flat 3-space in cosmological scales. Also overcritical cosmologies for which $a = constant$ section is 3-sphere are possible but only with a finite duration. Many-sheeted space-time picture also leads to the view that astrophysical objects co-move but do not co-expand so that the geometry of time=constant snapshot is Euclidian in a good approximation.
- (c) Does the notion of hyperbolic quasi-tessellation make sense?

Can one construct something deserving to be called quasi tessellations (QTs)? For QCs translational invariance is broken but in some sense very weakly: given lattice point has still an infinite number of translated copies. In the recent case translations are replaced by Lorentz transformations and discrete Lorentz invariance should be broken in similar weak manner.

If cut and project generalizes, QTs would be obtained using suitably chosen non-standard imbedding $M^4 \subset M^8$. Depending on what one wants to assume, M^4 is now image of M_{st}^4 by an element of $SO(1, 7)$, $SO(7)$, $SO(6)$ or G_2 . The projection - call it P - must take place to M^4 sliced by scaled copies of H^3 from M_{st}^8 sliced by scaled copies of H^7/Γ tessellation. The natural option is that P is directly from H^7 to $H^3 \subset H^7$ and is defined by a projecting along geodesic lines orthogonal to H^3 . One can choose always the coordinates of M^4 and M^8 in such a manner that the coordinates of points of M^4 are $(t, x, y, z, 0, 0, 0, 0)$ with $t^2 - r^2 = a_4^2$ whereas for a general point of H^7 the coordinates are $(t, x, y, z, x_4, \dots, x_7)$ with $t^2 - r^2 - r_4^2 = a_8^2$ for $H^3 \subset H^7$. The projection is in this case simply $(t, x, y, z, x_4, \dots, x_7) \rightarrow (t, x, y, z, 0, \dots, 0)$. The projection is non-empty only if one has $a_4^2 - a_8^2 \geq 0$ and the 3-sphere S^3 with radius $r_4 = \sqrt{a_4^2 - a_8^2}$ is projected to single point. The images of points from different copies of H^7/Γ are identical if S^3 intersects both copies. For r_4 much larger than the size of the projection $P(H^7/\Gamma)$ of single copy overlaps certainly occurs. This brings strongly in mind the overlaps of the dodecagons of Penrose tiling and icosahedrons of 3-D icosahedral QC. The point group of tessellation would be Γ .

- (d) Does one obtain ordinary H^3 tessellations as limits of quasi tessellations?

Could one construct expanding 3-D hyperbolic tessellations H^3/Γ_3 from expanding 7-D hyperbolic tessellations having H^7/Γ_7 as a basic building brick? This seems indeed to be the outcome at the limit $r_4 \rightarrow 0$. The only projected points are the points of H^3 itself in this case. The counterpart of the group $\Gamma_7 \subset SO(1, 7)$ is the group obtained as the intersection $\Gamma_3 = \Gamma_7 \cap SO(1, 3)$: this tells that the allowed discrete symmetries do not lead out from H^3 . This seems to mean that the 3-D hyperbolic manifold is H^3/Γ_3 , and one obtains a space-filling 3-tessellation in complete analogy for what one obtains by projecting cubic lattice of E^7 to E^3 imbedded in standard manner. Note that $\Gamma_3 = \Gamma_7 \cap SO(1, 3)$, where $SO(1, 3) \subset SO(1, 7)$, depends on imbedding so that one obtains an infinite family of tessellations also from different imbeddings parametrized by the coset space $SO(1, 7)/SO(1, 3)$. Note that if Γ_3 contains only unit element $H^3 \subset H^7/\Gamma_7$ holds true and tessellation trivializes.

Chapter 9

TGD and Astrophysics

9.1 Introduction

The concept of 3-space in TGD is considerably more general than in the conventional theories. 3-space is not any more connected but can have arbitrary many disjoint components. Even macroscopic boundaries are allowed: macroscopic bodies are interpreted as 3-surfaces having outer boundary. There are strong indications that 3-space has a hierarchical fractal structure: 3-surfaces topologically condensed on 3-surfaces condensed on..., where topological condensation means that 'small' 3-surface is 'glued' to a larger 3-surface by connected sum operation.

The fundamental feature of the topological condensation is the generation of Kähler electric fields if the minimization of Kähler action is assumed. This long-held assumption is of course ad hoc and it is an open question whether the recent view about preferred extremals as critical extremals for which a large number of deformations exist with a vanishing second variation of Kähler action. Gravitational fields are always accompanied by long range electro-weak gauge fields with Kähler charge, which in the astrophysical scales is apart from a small but non-vanishing numerical factor equal the mass of particle using Planck mass as unit. In shorter length scales the Kähler charge can be larger and reflects the development of long range classical Z^0 fields. Also long ranged classical color fields with U(1) holonomy are present.

Topological field quantization is a central concept: the presence of Kähler charge implies that 3-surface has outer boundary: the larger the charge the smaller the size of the 3-surface. This makes it possible to relate the size of the 3-surface (topological field quantum) to the Kähler charge of a typical particle in the condensate. The formation of macroscopic quantum systems, such as super conductors, corresponds to the formation of bonds between the boundaries of the neighboring topological field quanta. A possible astrophysical example is neutron star: join along boundaries bonds are formed between neutrons so that single giant nucleus results.

9.1.1 p-Adic length scale hypothesis and astrophysics

Various levels of the topological condensate obey effective p-adic topology and form p-adic hierarchy ($p_1 < p_2$ can condense on p_2). Physically interesting length scales should come as square roots of powers of 2: $L(k) \simeq 2^{\frac{k}{2}} l$, $l = 1.288 \cdot 10^4 \sqrt{G}$ and various considerations suggest that prime powers are especially interesting values of k . For astrophysical applications interesting prime values of n are: $n = 229, 233, 239, 241, 251, 257, 263...$ and it is of considerable interest to find whether these length scales correspond to astro-physically interesting length scales.

The combination of p-adic length scale hierarchy idea with the concepts of topological evaporation and condensation, join along boundaries bond and long ranged weak and color forces, is an exciting challenge. In this chapter these concepts are applied in astrophysical length scales. The identification of the prime power length scales as fundamental astrophysical length scales is proposed and the identification of the fundamental cosmological length scale identified by Einasto *et al* [E110] as a p-adic length scale is proposed. One of the most interesting implications of

p-adicity is the possibility of series of phase transitions changing the value of cosmological constant behaving as $\Lambda \propto 1/L^2(k)$ as a function of p-adic length scale characterizing the size of the space-time sheet.

9.1.2 Quantum criticality, hierarchy of dark matters, and dynamical \hbar

Quantum criticality is the basic characteristic of TGD Universe and quantum critical superconductors provide an excellent test bed to develop the ideas related to quantum criticality into a more concrete form.

Quantization of Planck constants and the generalization of the notion of imbedding space

The recent geometric interpretation for the quantization of Planck constants is based on Jones inclusions of hyper-finite factors of type II_1 [K30] .

- (a) One can argue that different values of Planck constant correspond to imbedding space metrics involving scalings of M^4 resp. CP_2 parts of the metric deduced from the requirement that distances scale as $\hbar(CP_2)$ resp. $\hbar(M^4)$. Denoting the Planck constants by $\hbar(M^4) = n_a \hbar_0$ and $\hbar(CP_2) = n_b \hbar_0$, one has that covariant metric of M^4 is proportional to n_b^2 and covariant metric of CP_2 to n_a^2 .

This however leads to difficulties with the isometric gluing of CP_2 factors of different copies of H together. Kähler action is however invariant under over-all scaling of H metric so that one can scale it down by $1/n_a^2$ meaning that M^4 covariant metric is scaled by $(n_b/n_a)^2$ and CP_2 metric remains invariant and the difficulties in isometric gluing are avoided. This means that if one regards Planck constant as a mere conversion factor, the effective Planck constant scales as n_a/n_b .

In Kähler action only the effective Planck constant $\hbar_{eff}/\hbar_0 = \hbar(M^4)/\hbar(CP_2)$ appears and by quantum classical correspondence same is true for Schrödinger equation. Elementary particle mass spectrum is also invariant. Same applies to gravitational constant. The alternative assumption that M^4 Planck constant is proportional to n_b would imply invariance of Schrödinger equation but would not allow to explain Bohr quantization of planetary orbits and would to certain degree trivialize the theory.

- (b) M^4 and CP_2 Planck constants do not fully characterize a given sector $M^4_{\pm} \times CP_2$. Rather, the scaling factors of Planck constant given by the integer n characterizing the quantum phase $q = \exp(i\pi/n)$ corresponds to the order of the maximal cyclic subgroup for the group $G \subset SU(2)$ characterizing the Jones inclusion $\mathcal{N} \subset \mathcal{M}$ of hyper-finite factors realized as subalgebras of the Clifford algebra of the "world of the classical worlds". This means that subfactor \mathcal{N} gives rise to G -invariant configuration space spinors having interpretation as G -invariant fermionic states.
- (c) $G_b \subset SU(2) \subset SU(3)$ defines a covering of M^4_{\pm} by CP_2 points and $G_a \subset SU(2) \subset SL(2, C)$ covering of CP_2 by M^4_{\pm} points with fixed points defining orbifold singularities. Different sectors are glued together along CP_2 if G_b is same for them and along M^4_{\pm} if G_a is same for them. The degrees of freedom lost by G -invariance in fermionic degrees of freedom are gained back since the discrete degrees of freedom provided by covering allow many-particle states formed from single particle states realized in G group algebra.
- (d) Phases with different values of scalings of M^4 and CP_2 Planck constants behave like dark matter with respect to each other in the sense that they do not have direct interactions except at criticality corresponding to a leakage between different sectors of imbedding space glued together along M^4 or CP_2 factors. In large $\hbar(M^4)$ phases various quantum time and length scales are scaled up which means macroscopic and macro-temporal quantum coherence. In particular, quantum energies associated with classical frequencies are scaled up by a factor n_a/n_b which is of special relevance for cyclotron energies and phonon energies (superconductivity). For large $\hbar(CP_2)$ the value of \hbar_{eff} is small: this leads to interesting

physics: in particular the binding energy scale of hydrogen atom increases by the factor $(n_b/n_a)^2$.

Preferred values of Planck constants

Number theoretic considerations favor the hypothesis that the integers corresponding to Fermat polygons constructible using only ruler and compass and given as products $n_F = 2^k \prod_s F_s$, where $F_s = 2^{2^s} + 1$ are distinct Fermat primes, are favored. The reason would be that quantum phase $q = \exp(i\pi/n)$ is in this case expressible using only iterated square root operation by starting from rationals. The known Fermat primes correspond to $s = 0, 1, 2, 3, 4$ so that the hypothesis is very strong and predicts that p-adic length scales have satellite length scales given as multiples of n_F of fundamental p-adic length scale. $n_F = 2^{11}$ corresponds in TGD framework to a fundamental constant expressible as a combination of Kähler coupling strength, CP_2 radius and Planck length appearing in the expression for the tension of cosmic strings, and the powers of 2^{11} seem to be especially favored as values of n_a in living matter [K26] .

How Planck constants are visible in Kähler action?

$\hbar(M^4)$ and $\hbar(CP_2)$ appear in the commutation and anticommutation relations of various super-conformal algebras. Only the ratio of scalings of M^4 and CP_2 metrics appears in Kähler action. The most natural assumption at the level of hyper-octonion space $HO = M^8$ is that M^4 metric is proportional to n_b^2 and E^4 metric to n_a^2 . For $H = M^4 \times CP_2$ the assumption that CP_2 metric is proportional to n_a^2 however leads to mathematical difficulties and to a rather weird looking prediction that CP_2 can have arbitrarily large size. Hence the most natural conclusion is that the scaling of CP_2 metric is universal [K30] . This is achieved elegantly by performing over-all scaling of scaled up H metric allowed by the invariance of Kähler action in this scaling so that a scaling of M^4 covariant metric by $(n_b/n_a)^2$ results and effective Planck constant as a mere conversion factor is scaled by n_a/n_b .

This implies that Kähler function through its dependence on n_a/n_b codes for radiative corrections to the classical action, which makes possible to consider the possibility that higher order radiative corrections to functional integral vanish as one might expect at quantum criticality. For a given p-adic length scale space-time sheets with all allowed values of Planck constants are possible. Hence the spectrum of quantum critical fluctuations could in the ideal case correspond to the spectrum of \hbar coding for the scaled up values of Compton lengths and other quantal lengths and times. If so, large \hbar phases could be crucial for understanding of quantum critical superconductors, in particular high T_c superconductors.

Phase transitions changing the level in dark matter hierarchy

The identification of the precise criterion characterizing dark matter phase is far from obvious. TGD actually suggests an infinite number of phases which are dark relative to each other in some sense and can transform to each other only via a phase transition which might be called de-coherence or its reversal and which should be also characterized precisely.

A possible solution of the problem comes from the general construction recipe for S-matrix. Fundamental vertices correspond to partonic 2-surfaces representing intersections of incoming and outgoing light-like partonic 3-surfaces.

- (a) If the characterization of the interaction vertices involves all points of partonic 2-surfaces, they must correspond to definite value of Planck constant and more precisely, definite groups G_a and G_b characterizing dark matter hierarchy. Particles of different phases could not appear in the same vertex and a phase transition changing the particles to each other analogous to a de-coherence would be necessary.
- (b) If transition amplitudes involve only a discrete set of common orbifold points of 2-surface belonging to different sectors then the phase transition between relatively dark matters can be described in terms of S-matrix. It seems that this option is the correct one. In

fact, also propagators are essential for the interactions of visible and dark matter and since virtual elementary particles correspond at space-time level CP_2 type extremals with 4-dimensional CP_2 projection, they cannot leak between different sectors of imbedding space and therefore cannot mediate interactions between different levels of the dark matter hierarchy. This would suggest that the direct interactions between dark and ordinary matter are very weak.

If the matrix elements for real-real partonic transitions involve all or at least a circle of the partonic 2-surface as stringy considerations suggest [K22], then one would have clear distinction between quantum phase transitions and ordinary quantum transitions. Of course, the fact that the points which correspond to zero of Riemann Zeta form only a small subset of points common to real partonic 2-surface and corresponding p-adic 2-surface, implies that the rate for phase transition is in general small. On the other hand, for the non-diagonal S-matrix elements for ordinary transitions would become very small by almost randomness caused by strong fluctuations and the rate for phase transition could begin to dominate.

Transition to large \hbar phase and failure of perturbation theory

A further idea is that the transition to large \hbar phase occurs when perturbation theory based on the expansion in terms of gauge coupling constant ceases to converge: Mother Nature would take care of the problems of theoretician. The transition to large \hbar phase obviously reduces gauge coupling strength α so that higher orders in perturbation theory are reduced whereas the lowest order "classical" predictions remain unchanged. A possible quantitative formulation of the criterion is that maximal 2-particle gauge interaction strength parameterized as $Q_1 Q_2 \alpha$ satisfies the condition $Q_1 Q_2 \alpha \simeq 1$.

A justification for this picture would be that in non-perturbative phase large quantum fluctuations are present (as functional integral formalism suggests). At space-time level this would mean that space-time sheet is near to a non-deterministic vacuum extremal. At parton level this would mean that partonic surface contains large number of CP_2 orbifold points so that S-matrix elements for the phase transition becomes large. At certain critical value of coupling constant strength one expects that the transition amplitude for phase transition becomes very large.

Dark matter as large \hbar phase

D. Da Rocha and Laurent Nottale have proposed that Schrödinger equation with Planck constant \hbar replaced with what might be called gravitational Planck constant $\hbar_{gr} = \frac{GmM}{v_0}$ ($\hbar = c = 1$). v_0 is a velocity parameter having the value $v_0 = 144.7 \pm .7$ km/s giving $v_0/c = 4.6 \times 10^{-4}$. This is rather near to the peak orbital velocity of stars in galactic halos. Also subharmonics and harmonics of v_0 seem to appear. The support for the hypothesis coming from empirical data is impressive.

Nottale and Da Rocha believe that their Schrödinger equation results from a fractal hydrodynamics. Many-sheeted space-time however suggests astrophysical systems are not only quantum systems at larger space-time sheets but correspond to a gigantic value of gravitational Planck constant. The gravitational (ordinary) Schrödinger equation would provide a solution of the black hole collapse (IR catastrophe) problem encountered at the classical level. The resolution of the problem inspired by TGD inspired theory of living matter is that it is the dark matter at larger space-time sheets which is quantum coherent in the required time scale. Schrödinger equation need not be involved. Rather, Bohr orbitology could reflect the fact that dark matter is in anyonic phase and confined by charge fractionization at large partonic 2-surfaces with a gigantic value of Planck constant. These surfaces could have complex topologies involving flux tubes around planetary orbits connected by radial spokes to a spherical surface associated with Sun.

Prediction for the parameter v_0

TGD predicts correctly the value of the parameter v_0 assuming that cosmic strings and their decay remnants are responsible for the dark matter. The harmonics of v_0 can be understood as corresponding to perturbations replacing cosmic strings with their n -branched coverings so that tension becomes n^2 -fold: much like the replacement of a closed orbit with an orbit closing only after n turns. $1/n$ -sub-harmonic would result when a magnetic flux tube split into n disjoint magnetic flux tubes.

Also a heuristic formula for the dependence of v_0 on p -adic length scale can be deduced and predicts a logarithmic dependence on the p -adic length scale. This gives some flexibility so that the prediction of mass ratios following from ruler and compass quantum phases is not so deadly strong anymore. The planetary mass ratios can be produced with an accuracy better than 10 per cent assuming ruler and compass phases, and the dependence of v_0 on p -adic length scale characterizing the space-time sheets carrying the planet-Sun gravitational force might relate to the discrepancies.

Further predictions

The study of inclinations (tilt angles with respect to the Earth's orbital plane) leads to a concrete model for the quantum evolution of the planetary system. Only a stepwise breaking of the rotational symmetry and angular momentum Bohr rules plus Newton's equation (or geodesic equation) are needed, and gravitational Schrödinger equation holds true only inside flux quanta for the dark matter.

- (a) During pre-planetary period dark matter formed a quantum coherent state on the (Z^0) magnetic flux quanta (spherical cells or flux tubes). This made the flux quantum effectively a single rigid body with rotational degrees of freedom corresponding to a sphere or circle (full $SO(3)$ or $SO(2)$ symmetry).
- (b) In the case of spherical shells associated with inner planets the $SO(3) \rightarrow SO(2)$ symmetry breaking led to the generation of a flux tube with the inclination determined by m and j and a further symmetry breaking, kind of an astral traffic jam inside the flux tube, generated a planet moving inside flux tube. The semiclassical interpretation of the angular momentum algebra predicts the inclinations of the inner planets. The predicted (real) inclinations are 6 (7) resp. 2.6 (3.4) degrees for Mercury resp. Venus). The predicted (real) inclination of the Earth's spin axis is 24 (23.5) degrees.
- (c) The $v_0 \rightarrow v_0/5$ transition allowing to understand the radii of the outer planets in the model of Da Rocha and Nottale can be understood as resulting from the splitting of (Z^0) magnetic flux tube to five flux tubes representing Earth and outer planets except Pluto, whose orbital parameters indeed differ dramatically from those of other planets. The flux tube has a shape of a disk with a hole glued to the Earth's spherical flux shell.

It is important to notice that effectively a multiplication $n \rightarrow 5n$ of the principal quantum number is in question. This allows to consider also alternative explanations. Perhaps external gravitational perturbations have kicked dark matter from the orbit or Earth to $n = 5k$, $k = 2, 3, \dots, 7$ orbits: the fact that the tilt angles for Earth and all outer planets except Pluto are nearly the same, supports this explanation. Or perhaps there exist at least small amounts of dark matter at all orbits but visible matter is concentrated only around orbits containing some critical amount of dark matter and these orbits satisfy $n \bmod 5 = 0$ for some reason.

- (d) A remnant of the dark matter is still in a macroscopic quantum state at the flux quanta. It couples to photons as a quantum coherent state but the coupling is extremely small due to the gigantic value of \hbar_{gr} scaling alpha by \hbar/\hbar_{gr} : hence the darkness.

The rather amazing coincidences between basic bio-rhythms and the periods associated with the states of orbits in solar system suggest that the frequencies defined by the energy levels of the gravitational Schrödinger equation might entrain with various biological frequencies such as the cyclotron frequencies associated with the magnetic flux tubes. For instance,

the period associated with $n = 1$ orbit in the case of Sun is 24 hours within experimental accuracy for v_0 .

9.1.3 Dark matter as a source of long ranged weak and color fields

Long ranged classical electro-weak and color gauge fields are unavoidable in TGD framework. The smallness of the parity breaking effects in hadronic, nuclear, and atomic length scales does not however seem to allow long ranged electro-weak gauge fields. The problem disappears if long range classical electro-weak gauge fields are identified as space-time correlates for massless gauge fields created by dark matter. The identification explains chiral selection in living matter and unbroken $U(2)_{ew}$ invariance and free color in bio length scales become characteristics of living matter and of bio-chemistry and bio-nuclear physics. An attractive solution of the matter antimatter asymmetry is based on the identification of also antimatter as dark matter.

9.2 p-Adic length scale hypothesis at astrophysical and cosmological length scales

p-Adic length scale hierarchy gives quantitative contents for the idea about fractal many-sheeted cosmology and therefore deserves a brief discussion.

9.2.1 List of long p-adic length scales

There are not very many p-adic lengths scales $L(k)$ ($p \simeq 2^k$, k power of prime) between 1 meter and 10^{11} light years as the approximate density $\Psi(n) \simeq \frac{1}{\ln(n)}$ of prime numbers as function of n shows. Therefore the length scale hypothesis is nontrivial and the attempt to identify physically the length scales is perhaps worth of the trouble although detailed identifications are not attempted in the following. If physics is indeed p-adic below length scale L_p at level p , one expects p-adic fractality, when length scale resolution is smaller than L_p . Length scales $L(k)$ coming as twin pairs corresponding to primes k and $k + 2$ seem to define particularly interesting biological length scales. Therefore it is of interest look whether something similar might happen in astrophysical context. L_p is the infrared cutoff scale for p-adic field theory limit of TGD but the idea that quantum effects might be important in astrophysical length scales looks admittedly rather wild.

k	227	229	233	239	241
L_p/m	$2.3E+3$	$4.6E+3$	$1.9E+4$	$1.5E+5$	$3.0E+5$
k	251	257	263	269	271
L_p/m	$.96E+7$	$7.7E+7$	$6.0E+8$	$4.8E+9$	$.9E+10$
k	277	289	293	307	311
L_p/m	$7.7E+10$	$5.0E+12$	$2.0E+13$	$2.5E+15$	$1.0E+16$
k	313	317	329	331	337
L_p/ly	2.2	$5.4E+2$	$1.0E+3$	$2.2E+3$	$8.4E+3$
k	347	349	353	359	367
L_p/ly	$2.8E+5$	$5.6E+5$	$2.2E+6$	$1.8E+7$	$2.9E+8$
k	373	379			
L_p/ly	$2.2E+9$	$1.9E+10$			

Table 1. p-Adic length scales $L_p = 2^{(k-127)/2} L_{127}$, $p \simeq 2^k$, k prime, $L_{127} \equiv \sqrt{5+Y}\pi/m_e$, $Y \simeq .0317$ possibly relevant to astrophysics. The definition of the length scale involves an unknown factor r of order one and the requirement $L(151) \simeq 10^{-8}$ meters, the thickness of the cell membrane, implies that this factor is $r \simeq 1.1$.

The length scales can contain some overall factor r of order order one. If this factor is chosen so that the length scale $L(151)$ is the thickness of the cell membrane, one must multiply p-adic length scales of the table by a factor $r \simeq 1.1$ to obtain $\hat{L}(k) = r * L(k)$.

- (a) $L(227) \sim 2.3$ kilometers, $L(229) \sim 4.6$ kilometers (twin pair) and $L(233) = 19.0$ kilometers. It would be interesting to find whether these length scales could be identified as geophysically important length scales or/and length scales relevant to the internal structure of stars or planets. $L(233)$ is the order of magnitude for the size of neutron star.
- (b) $L(239) \simeq 1.5E + 5 m$ and $L(241) \simeq 3.0E + 5 m$ form a twin pair and could represent geophysically/astrophysically interesting length scales.
- (c) $L(251) = .96E + 7 m$ and $L(257) = 7.7E + 7 m$. The radii of the planets are of this order of magnitude.
- (d) $L(263) = 6.0E + 8 m$ is of same order of magnitude as solar radius ($\sim 6.96E + 8 m$). Note that $\hat{L}(263) \simeq 6.6E + 8 m$ is considerably nearer to the solar radius. $L(269) \simeq 4.8E + 9$ meters and $L(271) \simeq .9E + 10$ meters form a twin pair. Titius-Bode law for planetary distances reads as $r = r_0 + r_1 2^n AU$, $r_0 = .4$ and $r_1 = .3$. A(stromical) U(nit) corresponds to distance between Earth and Sun: $r_1 \simeq .3AU \simeq 4.5E + 10m \sim 2^2 L(271)$ holds in a reasonable approximation. $2^2 \hat{L}(271) \simeq 4.4E + 10 m$ is quite near to $r_1!$ $L(271)$ is a member of twin pair and it might be that length scales corresponding to twin primes lead to approximate 2-adicity of the mass distribution. If primordial mass distribution is 2-adic and of form $((r - r_0)/r_1)^n$ it has peaks at $r - r_0 = r_1 2^k$ and Titius-Bode law is natural consequence. If this is the case then the planetary distance ratios might be universal!
- (e) For $k = 277, 289 = 17^2, 293, 307$, $L(k)$ varies between $7.7E + 10 m$ and about $2.5E + 15 m$. $L(277)$ is of same order as the distance from Earth to Sun. The size of the solar system is about $L(289)$. $L(311) \simeq 1.0 ly$ and $L(313) \simeq 2.0 ly$ form a twin pair. Could these distances have a tendency to appear as distances between binaries? Or could the distances have a tendency to come as powers $2^n L(313)$?
- (f) $L(329) \simeq 1.0E + 3$ and $L(331) \simeq 2.0E + 3$ light years form a twin pair. Sizes for the galactic nuclei are of this order of magnitude. The very powerful energy sources in the nuclei of the galaxies are associated with regions of this distance. A suggested explanation is black hole in the region between the object and also TGD allows galactic black holes. $L(337) \simeq 8.4 \cdot 10^3$ light years corresponds to the size of the central region of the galaxy. $L(353) \simeq 2.2 \cdot 10^6$ light years corresponds to a typical size scale of the galaxy [E99] .
- (g) $L(367) \simeq 2.2 \cdot 10^8$ light years is same order of magnitude as the size of the large voids and perhaps corresponds to the length scale identified by Einasto.

9.2.2 p-Adic evolution of cosmological constant

One of the most fascinating outcomes of the new view about gravitational energy is the resolution of the most gigantic failure in the art of order magnitude estimates. The naive estimate for the cosmological constant predicted also by TGD is by a factor 10^{120} larger than its value deduced from the accelerated expansion of the Universe. The resolution comes naturally from the p-adic fractality predicting that cosmological constant is reduced by a factor of 2 in a step wise manner in phase transitions occurring at times $T(k) \propto 2^{k/2}$, which correspond to p-adic time scales. On the average $\Lambda(k)$ behaves as $1/a^2$, where a is the light-cone proper time. This predicts correctly the observed value of Λ .

p-Adic length scale hypothesis plus the detailed study of membrane like vacuum extremals lead to the hypothesis that cosmological constant depends on p-adic length scale $\Lambda/R^2 \propto 1/R^2 L^2(k) \propto 2^{-k}$. Amazingly, the recent value of the cosmological constant suggested by the accelerated expansion of the Universe comes out as a correct prediction!

Cosmological expansion at a particular space-time sheet becomes a TGD counterpart for a sequence of periods of increasingly slow inflation which a reduction of Λ by a factor of 2 at each time when the size of space-time sheet exceeds a p-adic length scale. It must be however emphasized that Kähler action determines the classical dynamics and it is by no means clear

that exponential expansion is involved. What certainly occurs is liberation of gravitational energy, which means that the difference of inertial energy densities for matter and antimatter is reduced in a phase transition like manner. Maybe the interpretation in terms of annihilation of matter and antimatter is appropriate. Perhaps particles with masses of order p-adic length scale become non-relativistic and annihilate to lighter particles, most naturally those corresponding to the next p-adic length scale.

9.2.3 Evidence for a new length scale in cosmology

There is evidence [E110] for a cubic lattice structure in the length scale of the large cosmic voids containing matter near their boundaries. Single void having galaxies on its boundaries would be the basic unit of this structure. This means a characteristic length scale of order 1.2 Megaparsecs, which in light years makes $7.8E + 8$ light years. As noticed in the paper, these observations do not fit with the prediction of the cold dark matter scenarios predicting random distribution of galaxies and galaxy clusters at long length scales.

The first task is to find whether one could understand the length scale of order 1.2 Megaparsecs p-adically. In TGD, the cosmological evolution means the gradual emergence of longer and longer p-adic length scales, that is space-time sheets with size of order not too many p-adic length scales $L(p)$, where p is assumed to be near prime power of two by experience with the p-adic mass calculations: $p \simeq 2^k$, k power of prime. These regions (3-surfaces with outer boundaries!) do not expand any more but move like comoving particles in the expanding background (surface of larger p-adic prime).

There are not too many physically interesting p-adic primes near prime powers of two and the p-adic length scale associated with the prime $p \simeq 2^k$, $k = 367$ is $\hat{L}(367) \simeq 3.2E + 8$ light years, whereas the length scale $L(\text{Einasto}) = 7.8E + 8$ light years, deduced by Einasto *et al* is roughly *two times* this length scale. The two nearest length scales correspond to $p \simeq 2^k$, $k = 359$ with 16 times smaller length scale and $k = 373$ with 8 times larger length scale so that identification is unique. Therefore, it seems that p-adic length scale hypothesis might work even in the cosmological length scales.

The problem is to understand the origin of the lattice like structure. The least radical suggestion mentioned in [E110] is that some kind of acoustic waves during the early cosmology have left their trace in the background and caused the periodicity. Also a new physics in the inflation period has been speculated.

A priori, one can consider in TGD framework two alternative scenarios for the origin of the lattice structure. Either the structure is created during the very early cosmology and during cosmic expansion its size has gradually increased to its recently measured value. Or the structure is created later. TGD inspired cosmology is based on the hypothesis that new p-adic length scales emerge in the topological condensate during the cosmic evolution. Therefore one can consider the possibility that the large voids are structures, which have appeared later rather than having been present all the time. Of course, nothing excludes the possibility that the voids have expanded until they have reached the critical p-adic size for which the expansion has ceased.

The mechanism creating lattice structure could be based on so called p-adic fractals and be a consequence of the effective p-adic topology rather than result from some delicate dynamical mechanism. Already the existence of the p-adic length scales implies one kind of fractality. There is however also a second kind of fractality associated with a given value of the p-adic prime p . This latter kind of fractality, p-adic fractality for short, might provide an explanation for the lattice like structures as the following argument suggests.

p-Adic fractality for the real mass density ρ_R means that the density can be regarded as a map

$$\rho_R = I^{-1} \circ \rho \circ I ,$$

where ρ is the p-adic valued mass density in p-adic space-time and I denotes the so called *canonical identification* ,

$$I : \sum_n x_n p^n \rightarrow \sum_n x_n p^{-n} ,$$

mapping p-adics to reals and inducing a map from real space-time region to p-adic space-time region. Thus, given a p-adically analytic mass density function ρ , the map $\rho_R = I \circ \rho \circ I^{-1}$ induces real density function ρ_R , which turns out to be a fractal as the numerical study of simple examples for small values of p shows.

This lattice structure of the p-adic fractals follows directly from the basic properties of the canonical identification mapping p-adics to reals. The point is that canonical identification in range $[0, p)$ for the real numbers induces discontinuities of the real density $\rho_R = I \circ \rho \circ I^{-1}$ at the points $x = k = 0, 1, \dots, p-1$. Same occurs in each interval $[n, n+1)$ at $x = n + kp$, k integer, which are mapped to the reals in the interval $[n, n+1)$ and so on ad infinitum. Therefore the powers $p^{k/2}$ of the basic length scale are preferred scales for this structure. In higher-dimensional case one clearly obtains lattice like structure for the discontinuities. The lattice structure is not quite obvious in the illustrations of the 2-dimensional p-adic fractals represented in the first part of the book. If one plots p-adic fractal of the planar coordinates using different colors for different value ranges of the function, the cubic structure becomes manifest and one obtains extremely beautiful pictures.

9.2.4 Sunspot cycle

To begin with, consider the general properties of the solar magnetic fields and Sunspots [E198].

- (a) The average magnetic field of the Sun is dipole field and reverses its polarity with a period of eleven years. The actual solar magnetic field consists of the discrete elements (flux tubes) and all element sizes and magnetic field strengths seem to be possible. The appearance of the discrete structures is not in accordance with the naive magnetohydrodynamics expectations [E198]: the stability argument (magnetic pressure plus the plasma pressure inside the flux tube equals to the plasma pressure outside the flux tube) gives a lower bound of about $0.1 T$ for the magnetic field of a stable flux tube and smaller field strengths have been observed.
- (b) The short time scales associated with the dynamics of the magnetic structures are not in accordance with the magnetohydrodynamics expectations [E198]: in magnetohydrodynamics diffusion determines the time scale for the change of the magnetic fields and the time scale for changes in length scale L is of the order of $T \simeq L^2/\sigma$, where σ is the conductivity of the plasma. For the changes taking place in the length scale of Sun the time is of the order of $T \simeq 10^{10}$ years: dipole field changes its direction during a year! For Sunspots having typically the size of the order of $L \simeq 10^7 m$, the corresponding time is of the order of $T \simeq 10^6$ years.
- (c) The appearance of the Sunspots is related to the change of the polarity of the Solar magnetic field. Sunspots appear first at latitudes ± 40 degrees and gradually the region, where new Sunspots appear, drifts to the direction of the equator. Sunspot magnetic field is bipolar and the field strength is typically about $0.1 T$. The magnetic pole is referred to as p or f pole depending on whether the pole in question precedes or follows in the solar rotation (the western pole is by definition the leading pole). The polarity of the leading spots is same (Hale-Nicholson law) for all Sunspots in a given hemisphere and for a given solar cycle. The polarity of the p spot is opposite for the two hemispheres and for two successive cycles. The opposite polarity of the southern and northern p spots guarantees the dipole field nature of the average magnetic field. The change of the polarity in the beginning of the solar cycle (implying the change of the polarity of the dipole field) is however not well understood in the present models.
- (d) Sunspots seem to be related to the convective motion of the matter. There is a net outward and inward flow of the matter with a velocity of order $\beta \simeq 10^{-5}$ at p and f poles of the Sunspot respectively so that Sunspots take part in the convection. There are also

indications that the fibril like structures on the penumbra of p pole are convective rolls [E198]. These features suggest that Sunspots are magnetized helical vortices.

- (e) The appearance of the Sunspots is accompanied by a reduction of the solar constant: a possible explanation is that part of the solar energy is stored as a kinetic energy of the fluid motion associated with the Sunspots and as a magnetic field energy [E198].

9.2.5 Sunspots as helical vortices

TGD suggests an explanation of the discrete magnetic structures as a direct manifestation of the CP_2 geometry. The TGD inspired model for the Sunspot is motivated by the general ideas described earlier and by the basic features of Sunspots. For the reader's convenience only the general ideas are described and calculational details are left later.

- (a) In accordance with the ideas about the generation of hydrodynamical turbulence as spontaneous Z^0 magnetization, it is assumed that the structures of the solar magnetic field correspond to Z^0 magnetized domains, i.e. vortices of some kind.
- (b) The TGD based concept of the 3-space suggests strongly that vortices correspond to topological field quanta, that is 3-surfaces of a finite size and with outer boundary, glued to a background 3-space. The outer boundary corresponds to the critical radius for the imbedding of the Z^0 magnetic field created by the moving matter. The requirement that the critical radius of the magnetic flux tube is of the order of Sunspot size or smaller, implies that the values of the vacuum quantum numbers associated with the Sunspots must be considerably smaller than those associated with the background 3-space.
- (c) Also the background space is a carrier of a Z^0 magnetic field (which can be weak) and helical vortex interacts with this field by Z^0 magnetic dipole interaction, which explains the motion of the ends of the helical vortex in the Sunspot cycle.
- (d) The simplest (Z^0) magnetized domains are vortex like structures and Sunspots are identified as helical vortices, one of whose functions, besides maximizing Kähler function, is the convective transport of heat. This function explains why the ends of the Sunspot are at the surface of the Sun and why the main part of the structure is beneath the surface of the Sun, possibly at the bottom of the convective zone. It should be emphasized that Sunspots are not the only structures of this type: also smaller structures are possible and the radius of the vortex is determined by the value of the fractal quantum number m and magnetic quantum numbers. The small size of these structures however makes them invisible.
- (e) The velocity field of the vortex serves as a source of Z^0 magnetic field:

$$\nabla \times \bar{B}_Z = NK_Z \bar{v} , \quad (9.2.1)$$

where $N \equiv \rho_m/m_p$ denotes nucleon density and $K_Z = \epsilon_1 10^{-19} = g_Z/\sqrt{\epsilon_Z}$ describes the strength of the Z^0 force. By neutrino screening, the average Z^0 charge density is expected to be much smaller than the density of the nuclei. It has been assumed that neutrinos do not participate in the rotational motion so that nucleons serve effectively as the source of the Z^0 magnetic field. This means that ϵ_Z appearing in the formula refers to the Z^0 gauge flux coming from the 'previous' condensate level. For the condensate level at which the elementary particles feed their Z^0 charges, one has therefore $\epsilon_Z = 1$. At the astrophysical scales ϵ_1 is smaller than one.

- (f) The magnetic field of the Sunspot is generated, when the integers n_i change so that their ratio differs from the value $n_1/n_2 = \omega_1/\omega_2$ guaranteeing the vanishing of the electromagnetic fields. This process implies that Z^0 magnetic line dipole becomes also an ordinary magnetic line dipole and therefore visible, when the ends of the vortex are at the surface of the Sun. This mechanism implies also that magnetic and Z^0 magnetic fields are parallel to each other.

- (g) Magnetohydrodynamic stability conditions are satisfied if the magnetic field of the Sunspot is parallel with the electric current so that the Lorentz force vanishes: $\nabla \times \bar{B} = \bar{v} \times \bar{B}_{em}$ [E198]. This condition holds true also for the Z^0 magnetic field. If the magnetic field is generated by changing the values of the magnetic quantum numbers n_1 and n_2 , then Z^0 magnetic and magnetic fields are parallel so that also Z^0 magnetic and velocity fields are parallel:

$$\bar{B}^Z \propto \bar{v} . \quad (9.2.2)$$

Helical vortices are the simplest objects allowing this kind of structure. A more detailed model for the helical vortices is postponed to the last subsection.

9.2.6 A model for the Sunspot cycle

Consider now a simplified model of the Sunspot cycle in terms of the helical vortices.

- (a) Sunspots correspond to helical vortices, whose main part is parallel to the surface of the Sun and whose ends are vertical vortices. In accordance with the idea that 3-space is a hierarchical condensate of 3-surfaces of various sizes, it is assumed that helical vortices correspond to topological field quanta condensed to the background 3-space. Also the background 3-space is a carrier of Z^0 magnetic field B_Z , which might be identified as the "average" or "self consistent" magnetic field created by the other topological field quanta. Helical vortices possess a definite Z^0 magnetic moment $d\bar{\mu}_Z/dl$ per unit length in the direction of the vortex: magnetic moment is due to the rotational motion of the matter inside the helical vortices. Therefore the vortices interact with the average Z^0 magnetic field of the Sun by the usual dipole interaction. Observations suggests that the poles of the Sunspot behave like independent dynamical objects so that in the first approximation the constraint forces can be neglected the ends of the vortex and vortices suffer a force per unit length given as the gradient of the dipole interaction energy per unit length

$$\frac{d\bar{F}}{dl} = \nabla \left(\frac{d\bar{\mu}_Z}{dl} \cdot \bar{B}_Z \right) . \quad (9.2.3)$$

At the beginning of the Sun spot cycle only the radial component of the magnetic field contributes to the force since p and f poles of the Sunspot are to a good approximation at the same latitude. The force is in the direction of the meridian. Since the sign of $d\bar{\mu}/dl$ is opposite for p and f poles they begin to move in opposite directions. The contribution of B_r to the force changes its sign at equator and this motivates the assumption that the p end of the Sunspots oscillates between the latitudes $+40$ and -40 degrees.

The nice feature of the proposal is that the force is indeed in the right direction at the beginning of the solar cycle and the forces on p and f have opposite directions. The details of the force are not important for the estimate of the duration of solar cycle. It is the latitude at which the Sunspot formation begins, which depends on the detailed properties of the force.

- (b) The motion of poles and in particular, differential rotation of the Sun implies the stretching of the vortex. If the flow is incompressible the volume of the vortex remains constant (V_0) so that the area (S) of the vortex decreases as $1/L$ as function of the vortex length L :

$$L = L_0 \frac{S_0}{S} . \quad (9.2.4)$$

Typical initial values of S and L are $S_0 \simeq \pi \cdot 10^{12} m^2$ and $L_0 \simeq 10^7 m$. The decrease of the cross sectional area implies that the Sunspot becomes invisible after having reached some critical radius.

- (c) After having reached a certain critical radius of the order of the radiation length $L_{rad} \simeq 3 \cdot 10^4 m$, vortex becomes unstable against pinch and splits to two pieces. The reason is that vortex must be cooler than its surroundings by the magnetic equilibrium conditions ($B^2/2 + nkT_{in} = nT_{out}$) and this is not possible if the radius of the vortex is too small since the radiation flux of the Sun destroys all temperature gradients in the length scales smaller than $L_{rad} \simeq 3 \cdot 10^4 m$. The critical length of the vortex is therefore given by $L_f \sim L_0 S_0 / S_f \simeq 4 \cdot 10^{11} m$.
- (d) Since the stretching of the vortex results mainly from the differential rotation of the Sun (rotation period is $T_{rot} = 25 d(ays)$ and $T_{rot} = 30 d$ on poles and equator respectively). This means that the upper bound for the time required to achieve instability is of the order of $T_{cycle} \leq (L_f / R_{Sun}) T_{rot} \simeq 4 \cdot 11$ years ($R_{Sun} \simeq 8 \cdot 10^8 m$) and of the same order of magnitude as the period of the Sunspot cycle (recall that the naive magnetohydrodynamic estimate is about 10^{10} years!). The actual value is smaller since in the beginning of the cycle the effect of the differential rotation is considerably smaller than at the end of the cycle.
- (e) The stretched magnetized vortices give the dominant contribution to the average dipole field of the Sun and the entanglement of the dipole field lines resulting from the freezing of the magnetic field lines to differentially rotating matter corresponds to the stretching of the co-rotating vortices. The dipole nature of the average solar magnetic field requires that p type poles must have same polarity on the given hemisphere and that the polarities of p type poles are opposite for Southern and Northern hemispheres.
- (f) The vortices started from the latitude of 40 (-40) degrees achieve critical length at the latitude -40 (40) degrees begin to split to pieces. The resulting pieces achieve their equilibrium volume V_0 by increasing their transverse size from the critical size S_f to S_0 implying the increase of the radius by a factor of order $10^{3/2}$. The pieces are observed as new Sunspots and the gradual splitting starting from the end explains why the Sunspot active region proceeds gradually to the direction of equator. The mysterious reversal of p type polarity results from the opposite polarities of p poles at Northern and Southern hemispheres. This in turn implies the change of polarity of the solar magnetic field at each Sunspot cycle.
- (g) The energy needed to generate the magnetic field of the thickened vortex and the kinetic energy of the vortex motion is provided by the energy production in the interior of the Sun and the process explains the decrease of the Solar constant.

9.2.7 Helical vortex as a model for a magnetic flux tube

The detailed model of the magnetic flux tube as a helical vortex is based on the following physical picture.

- (a) The velocity field of the vortex serves as source of Z^0 magnetic field

$$\begin{aligned} \nabla \times \bar{B}^Z &= K_Z N \bar{v} , \\ K_Z &= -\frac{g_Z^2}{4\sqrt{\epsilon_Z}} \frac{A-Z}{A} . \end{aligned} \quad (9.2.5)$$

where $N \equiv \rho_m / m_p$ denotes nucleon density and K_Z describes the strength of Z^0 force. $\epsilon_1 \leq 1$ measures the relative strength of Z^0 and gravitational forces. For the gravitational interaction to dominate over Z^0 force the condition $\epsilon_Z > 10^{36}$ must hold true.

- (b) The magnetic field is generated, when the integers n_i change so that their ratio differs from the value $n_1/n_2 = \omega_1/\omega_2$ guaranteeing electrovac property. This mechanism implies that magnetic and Z^0 magnetic fields are parallel to each other.
- (c) Magnetohydrodynamic stability conditions are satisfied if the magnetic field of the Sunspot is parallel with the electric current so that the Lorentz force vanishes: $\nabla \times \bar{B} = \bar{v} \propto \bar{B}_{em}$

[E198] . If the magnetic field is generated by changing the values of the magnetic quantum numbers n_1 and n_2 then Z^0 magnetic and magnetic fields are parallel so that also Z^0 magnetic and velocity fields are parallel:

$$\bar{B}^Z \propto \bar{v} . \quad (9.2.6)$$

Helical vortices are the simplest objects allowing this kind of structure and cylindrical symmetry fixes the structure of the helical vortex almost completely.

The helical vortex possesses cylindrical symmetry in the sense that Z^0 magnetic field and velocity field have only z and ϕ components, which depend on the cylindrical coordinate ρ only, so that one has

$$\begin{aligned} \Phi &= \omega_1 t + k_1 z + n_1 \phi , \\ \Psi &= k\Phi = \omega_2 t + k_2 z + n_2 \phi , \\ r &= \tan(X(u)) , \\ X(u) &= \ln((k+u)/C)\epsilon/2 \quad u = u(\rho) , \\ \frac{\omega_2}{\omega_1} &= \frac{k_2}{k_1} = \frac{n_2}{n_1} . \end{aligned} \quad (9.2.7)$$

The relationship between the velocity field and Z^0 magnetic field is dictated by the condition that matter flow serves as source of the Z^0 magnetic field.

The expressions for the non-vanishing components of the induced Z^0 magnetic field are given by

$$\begin{aligned} B_z^Z &= -\frac{3}{(3+p)} n_1 \sin^2 X \frac{\partial_\rho u}{\rho} , \\ B_\phi^Z &= -\frac{3}{(3+p)} k_z \sin^2 X \frac{\partial_\rho u}{\rho} . \end{aligned} \quad (9.2.8)$$

The requirement $\nabla \times \bar{B}^Z \propto \bar{B}^Z$ implies the condition

$$\frac{\partial_\rho B_z^Z}{\partial_\rho B_\phi^Z} = -\frac{B_\phi^Z}{\rho^2 B_z^Z} . \quad (9.2.9)$$

Using the explicit representation as an induced gauge field one obtains the differential equation

$$\begin{aligned} \partial_\rho Y &= \frac{(1 - (\rho/\rho_1)^2)}{(1 + (\rho/\rho_1)^2)\rho} Y \\ Y &= \sin^2 X \partial_\rho u , \\ \rho_1 &= \frac{n_1}{k_z^1} , \end{aligned} \quad (9.2.10)$$

which gives

$$\begin{aligned}\partial_\rho Y &= \frac{(1 - (\rho/\rho_1)^2)}{\rho(1 + (\rho/\rho_1)^2)} Y , \\ Y &= \sin^2 X \partial_\rho u .\end{aligned}\tag{9.2.11}$$

By integrating this equation, one obtains

$$\begin{aligned}B_z^Z &= -\frac{3}{(3+p)} \frac{n_1}{[(1 + (\rho/\rho_1)^2)\rho_0^2]} , \\ B_\phi^Z &= \frac{k_z^1}{n_1} \rho^2 B_z^Z ,\end{aligned}\tag{9.2.12}$$

where ρ_0 is an integration constant possessing the dimension of length.

The magnitudes of the velocity components β_z and β_ϕ are

$$\begin{aligned}\beta_z &= \frac{2k_z^1}{NK_Z \rho_0^2} \frac{p}{2(3+p)} \frac{1}{(1 + (\frac{\rho}{\rho_1})^2)} , \\ \beta_\phi &= \frac{\rho}{\rho_1} \beta_z .\end{aligned}\tag{9.2.13}$$

Stability requirements for helical vortices [E83] suggest that the value of n_1/k_z^1 is of the same order as critical radius. Notice that the vortex rotates like a rigid body near the z-axis and that the longitudinal velocity is also approximately constant near the z-axis.

The above described imbedding of the helical Z^0 magnetic field fails at the critical radius $\rho = \rho_{cr}$, which corresponds to the value of $r = \infty$. The expression for the critical radius in present case is obtained from the condition $r = \infty$ and reads as

$$\begin{aligned}\rho_{cr} &= \rho_1 \left\{ \exp\left[4\left(\frac{\rho_0}{\rho_1}\right)^2 (u_0 + k) \exp\left(-\frac{2\pi m}{\epsilon}\right) X_0\right] - 1 \right\}^{1/2} , \\ &\simeq 2\rho_0 \exp\left(-\frac{m\pi}{\epsilon}\right) [(u_0 + k) X_0]^{1/2} , \\ X_0 &= \frac{(2 + \epsilon^2) \exp\left(\frac{\pi}{\epsilon}\right) + \epsilon^2}{1 + \epsilon^2} ,\end{aligned}\tag{9.2.14}$$

where it has been assumed that the value of the exponent is small. It will shortly be found that the assumption is physically well founded. Notice that the critical radius depends extremely sensitively on the value of the "fractal" quantum number m and that the critical radii are related by a power of a discrete scaling transformation in the approximation used.

If one requires that Z^0 magnetic flux is quantized with n_1 multiple of some integer n , one has simpler condition

$$\begin{aligned}\frac{3}{3+p} 2(u_0 + k) \exp(-2\pi m/\epsilon) X_0 &= \frac{1}{n} , \\ \rho_{cr} &= \rho_1 \left\{ \exp\left[2\frac{\rho_0^2}{n\rho_1^2}\right] - 1 \right\}^{1/2} .\end{aligned}\tag{9.2.15}$$

If one requires flux quantization without any conditions on n_1 , one must assume $n = 1$.

Vortex carries also radial Z^0 electric field: the magnitude of this field is given by

$$|E^Z| = |B_\phi^Z|(\omega_1\rho/n_1) . \quad (9.2.16)$$

The parametrization $\omega_1 = \sqrt{\epsilon_Z}x$, $x \sim 1$ is expected to hold true for ω_1 .

9.2.8 Estimates for the vacuum parameters of magnetic flux tube

Consider next the values of the various vacuum parameters appearing in the embedding of the helical vortex.

An estimate for the quantum number ω_1

From the requirement that gravitational interaction is stronger than Z^0 force in long length scales one obtains $\omega_1 \leq 1/R \sim 10^{-4}m_{Planck}$ and $\epsilon_Z > 10^{38}$. The other extreme correspond to the condensate level $n = n_Z$ with $\epsilon_Z(n_Z) \sim 10^{20}$. One must however remember that neutrinos are not expected to serve as the source of Z^0 magnetic field and therefore $\epsilon_Z(n-1)$ appears in the expression of the magnetic field at level n and at level n_Z the total unscreened nuclear charge serves therefore as the source of B_Z . Lorentz invariance implies that the value of k_z^1 is given by

$$k_z^1 \simeq \omega_1\beta_z . \quad (9.2.17)$$

An estimate for the quantum number n_1

The requirement that angular momentum density is of correct order of magnitude gives an estimate for the value of the parameter n_1 . The expression of the conserved angular momentum current in the z-direction is given by

$$J^\alpha = T^{\alpha\beta}\partial_\beta m^k m_{kl}j^l , \quad (9.2.18)$$

where j^k denotes the vector field associated with an infinitesimal rotation and $T^{\alpha\beta}$ denotes energy momentum tensor. For the angular momentum density one obtains in the cylindrical M^4 coordinates for X^4 the expression

$$\begin{aligned} J^t &= T^{t\phi}\rho^2 , \\ T^{\alpha\beta} &= \frac{1}{16\pi G}G^{\alpha\beta} , \end{aligned} \quad (9.2.19)$$

where the second equation is Einstein's equation.

Case a:

If the contribution of CP_2 curvature to the curvature tensor is not dominating the leading order contribution to $G^{t\phi} = R^{t\phi} - g^{t\phi}R/2$ comes from the non-vanishing of the metric component $g_{t\phi}$:

$$g_{t\phi} = s_{\Phi\Phi}^{eff} \omega_1 n_1 = -\frac{R^2}{4} (\cos^2(X)(k+u)^2 + 1 - u^2) \sin^2(X) \omega_1 n_1 , \quad (9.2.20)$$

and one obtains the order of magnitude estimate

$$J^t \simeq -T^{tt} g_{t\phi} \simeq \rho_m \frac{R^2}{4} \omega_1 n_1 . \quad (9.2.21)$$

In order to obtain a correct order of magnitude for the angular momentum density associated with rotational flow one must have

$$\frac{R^2}{4} \omega_1 n_1 \sim \rho \beta(\rho) , \quad (9.2.22)$$

which implies

$$\begin{aligned} n_1 &\simeq \frac{L}{R^2 \omega_1} \beta \sim \frac{10^{19} L}{\sqrt{\epsilon_Z x} R} \beta , \\ \omega_1 &\equiv x \sqrt{\epsilon_Z} m(\text{proton}) , \end{aligned} \quad (9.2.23)$$

where L and β are typical scale and velocity associated with the flow and $x \sim 1$ is expected to hold true. If L is taken to be the radius of the vortex ($L \sim 10^7 m$) and $\beta_\phi \sim 10^{-5}$ the rotation velocity of the vortex, one obtains: $n_1 \sim \frac{10^{55}}{x \sqrt{\epsilon_Z}}$. If L is taken to be the radius of the Sun and β , the rotation velocity of the Sun the value of n_1 is about hundred times larger. The order of magnitude for E^Z is

$$E^Z \sim a \frac{B^Z}{\beta_{rot}} ,$$

with

$$a = x \sqrt{\epsilon_Z} G m_p \omega_1 \ll 1 ,$$

and is consistent with the assumption that the density of Z^0 charge is much smaller than the density of the nucleons.

Case b:

If Z^0 field is strong as compared to the gravitational field, the dominating contribution to $G^{t\phi}$ comes from the contribution of the CP_2 curvature to $R^{t\phi}$ and is proportional to the quantity $J^t_\rho J^{\rho\phi}$: in this case the previous estimate doesn't hold anymore and one obtains the estimate

$$\frac{n_1}{\omega_1} \simeq \beta L . \quad (9.2.24)$$

Since Z^0 field is strong inside the Sunspots one must use this estimate for n_1/ω_1 and one obtains the estimate

$$E^Z \sim \frac{B^Z}{\beta_{rot}} .$$

The result would mean that the density of Z^0 charge is of same order of magnitude as the density of the nucleons and by the presence neutrino screening this is not possible. Therefore case 1) is closer to the actual physical situation.

An estimate for the radius ρ_0

An estimate for the radius ρ_0 is obtained by substituting the estimate of k_z to the general expression of β_z at z-axis and one obtains the condition

$$\begin{aligned}\rho_0 &\sim \left[10^{19} \frac{p}{(3+p)} \frac{1}{\sqrt{GN\epsilon_1}}\right]^{1/2} \\ &\sim \left(\frac{1}{\epsilon_1}\right)^{1/2} 10^{11} m , \\ \epsilon_1 &\equiv K_Z 10^{19} ,\end{aligned}\tag{9.2.25}$$

where the estimate $N \sim 10^{30}/m^3$ for the nucleon density has been used.

An estimate for the fractal quantum number m

An estimate for the value of the fractal quantum number m is obtained from the condition that the exponent appearing in the expression of the critical radius is small:

$$4\left(\frac{\rho_0}{\rho_1}\right)^2 \exp(-2m\pi\epsilon)[(u_0 + k)X_0] \ll 1 .\tag{9.2.26}$$

Since one has $\rho_0 \simeq \sqrt{1/\epsilon_1} 10^{11} m$ and $\rho_1 \sim \rho_{cr} \sim 10^6 m$, one obtains an order of magnitude estimate $\exp(-2m\pi/\epsilon) \ll 10^{-10} \epsilon_1/(u_0 + k)$ so that the value of m must be rather large unless the value of the parameter $u_0 + k = u_0 + n_2/n_1$ is very small or the value of ϵ_1 is sufficiently large: the value $\epsilon_1 \geq 10^5$ implies that m is of order 2: a rather natural looking value unlike the large values implied by $\epsilon - 1 \sim 1$.

Estimate for the magnetic field

If the magnetic field is generated by the change of n_1 so that the condition $\omega_1/\omega_2 = n_1/n_2$ ceases to hold true one obtains the following approximate expression for the magnetic field at the z-axis

$$B_z^{em} \simeq \frac{\Delta n_1(3+p)}{\rho_0^2} .\tag{9.2.27}$$

The requirement that the magnetic field is of the order of $B_{em} = 10^3$ Gauss gives the estimate $\delta n_1 \simeq 10^{36}/\epsilon_1$ so that the relative change of n_1 is given by $\Delta n_1/n_1 = 10^{-19} x \sqrt{\epsilon_Z}/\epsilon_1 \ll 1$ for alternative 1) in which n_1 is very large. The argument related to the destruction of the super fluidity by the generation of Z^0 magnetic fields suggests the range $\epsilon_Z \in (10^{20} - 10^{22})$ at the condensation level level n_Z , at which elementary particles feed their Z^0 gauge fluxes for ϵ_Z (recall that $1/\sqrt{\epsilon_Z(n)}$ tells which fraction of total nuclear Z^0 charge the unscreened Z^0 charge is at the condensate level n and therefore flows to level $n+1$ via the # throats located near the boundaries of level n surface). This number corresponds to $\epsilon_1(n_Z) = 10^{19} g_Z/\sqrt{\epsilon_Z} \in (10^8 - 10^9)$. Quite strong Z^0 magnetic fields are possible: the strength of the Z^0 magnetic field at the level $n = n_Z + 1$ is below 10^4 Tesla for $\epsilon_Z(n_Z) = 10^{22}$ and $\rho_{cr} \sim 10^6 m$!

9.3 Explanation for the high temperature of solar corona

The mysterious feature of the solar corona is its high temperature $T \sim 10^6 K$, as compared with the temperature of the chromosphere of order $10^4 K$ [E198] (the book of Zirin provides excellent introduction to the physics of Sun). The temperature rises very rapidly to $10^6 K$ at height $h \sim 2 \cdot 10^6 m$ from the surface of Sun. The problem is to identify the mechanism leading to the heating of the particles of the solar wind after leaving solar surface: no convincing mechanism has been identified and this suggests that many-sheeted space-time concept might be involved in an essential manner. Indeed, the high temperature matter in the solar corona can be interpreted as a dark matter leaked from the highly curved portions of magnetic flux tubes to the space-time sheets where it becomes visible.

9.3.1 Topological model for the magnetic field of Sun

The basic observation is that solar corona cannot behave like single homogenous object possessing high temperature $T \sim 10^6 K$: the effective black body temperature deduced from the net radiation flux is not larger than 7000 K [E198] corresponding energy density is more than 10^{-9} times smaller than the energy density associated with T . This suggests the existence of local high temperature regions giving rise to characteristic spectral lines in X ray region serving as a signature of the high temperature.

It is also known that the dynamics of the solar atmosphere and convective zone is very strongly correlated with magnetic fields, which from Zeeman splitting are known to have typical magnitudes of order .3 Tesla [E198] . Furthermore, only those stars which have convective zone, possess corona and the size and shape of corona varies during the sunspot cycle.

Also solar constant is found to vary during sunspot cycle, which is difficult to understand in the standard picture about solar energy transfer. Solar wind is known to be associated with the non-closed magnetic fields lines and with the coronal holes in which temperature is lower than in the surroundings. High temperature regions in corona in turn correspond to regions at which field lines tend to be tangential to the surface and temperature. This suggests that magnetic fields provide the basic mechanism of convective energy transfer and that magnetic fields somehow make it possible to heat the solar corona locally.

These considerations suggests that magnetic flux tubes realized as tube like space-time sheets having radius $\rho \geq \rho_0 = \sqrt{1/eB}$ provide a TGD based topological realization for the convective energy transfer. This hypothesis reduces the problem to microscopic level and rather precise quantitative predictions should become possible. Protons and electrons can topologically condense at the magnetic flux tubes and move along them. It is assumed that in good approximation all protons, electrons and also heavier elements are condensed at the magnetic flux tubes.

The magnetic field of the flux tube confines charged particles and in transversal degrees of freedom they behave quantum mechanically like 2-dimensional harmonic oscillators with wave functions localized around Landau orbits with radius of order $\sqrt{n}\rho_0$, $n = 0, 1, 2..$ whereas in longitudinal degrees of freedom they behave like free particles locally. If n is sufficiently large, classical description as continuous matter should become possible. In the classical description charged particles are confined around magnetic lines of force and rotate with frequency $\omega = eB/E$, where E is total relativistic energy. The radius of the orbit is $\rho = \beta/\omega$, where β is rotational velocity. For sufficiently small values of β the radius of orbit is so small that particle is confined inside the flux tube. The dominant component of velocity is along the direction of flux tube.

In magneto-hydrodynamical description the basic equations state the conservation of magnetic flux, of various particle numbers (electron and proton numbers for magnetic flux tubes and neutron and neutrino numbers for Z^0 magnetic flux tubes) and conservation of momentum and energy along the flow lines. Energy density contains the energy density σT^4 of from black body radiation, kinetic energy density $\rho v^2/2$ of the macroscopic motion, pressure contribution p and the density $B^2/2$ of the magnetic energy. Gravitation is assumed to couple to the size and shape of the flux tube rather than to individual particles inside the flux tube so that gravitational energy density does not contribute to energy conservation conditions. If the particles slow down

somewhat as they approach to the highly curved portions of the flux tubes, the increase of the temperature along the flux tube is implied by the conservation of energy $\sigma T^4 + \rho v^2/2 \simeq \text{constant}$. This explains why the local temperature of the corona is higher than the temperature at the surface of Sun and why the temperature is lowest and streaming velocity highest at the coronal holes with non-closed magnetic field lines extending to interplanetary space. The leakage of the particles to other space-time sheets at the highly curved portions of the flux tubes could in turn cause local heating of the matter.

Since the particles entering the closed flux tubes have some kinetic energy and since most of them return to the convective zone, there must be a momentum transfer from particles to the flux tube and flux tube must receive momentum. In equilibrium this force and gravitational force affecting the shape and size of the entire flux tube cancel each other. This is nothing but a topological representation for the freezing of magnetic field lines to moving matter. In this picture it is possible to understand the mysterious looking ability of the solar prominences to defy the force of gravity. Solar wind corresponds to particles glued to open flux tubes or closed flux tubes formed via the recombination of flux lines in solar atmosphere and having velocity larger than the escape velocity.

The model predicts correctly the basic qualitative properties of the solar wind [E198] .

- (a) The highest velocity streams come from the coolest part of corona, coronal holes: these regions correspond to open magnetic field lines extending into interplanetary space. This follows from the energy conservation and from the fact that temperature is lower for coronal holes so that kinetic energy must be larger.
- (b) The velocity of the solar wind protons is found to decrease with the increasing density of electrons at the base of Corona [E198] . By charge neutrality inside flux tubes also proton density is reduced and conservation law for energy requires the increase of the velocity of protons. Streaming velocity is also found to increase with the electron temperature at the base of the corona [E198] . Assuming thermal equilibrium this means that the radiative contribution to energy is reduced so that kinetic energy density must increase.

If flux tube is closed, particles return to the convective zone and one can indeed speak about convective motion also in solar atmosphere. The confinement of radiative energy to the closed magnetic flux tubes (space-time sheets actually!) might explain why solar constant depends on the phase of the sunspot cycle being smallest at sunspot maximum when the number of closed field lines is maximum. Neutrinos and neutrons are expected to suffer topological condensation on Z^0 magnetic flux tubes and the obvious explanation for the solar neutrino deficit is that some fraction of neutrinos is confined to these tubes returns back to Sun. The reduction of the neutrino flux is possible even without absolute confinement inside flux tubes: already the dispersion of the neutrino flux caused by the change in the direction of motion during the travel inside the flux tube reduces neutrino flux from the solar core.

9.3.2 Quantitative formulation

Magnetic flux tubes are assumed to have fractal 'flux tubes inside flux tubes' structure and decompose ultimately into microscopically thin flux tubes. Furthermore that protons and electrons are assumed to suffer magnetic confinement inside these flux tubes. Classical rotational motion around field lines occurs with frequency $\omega = eB/m$ and the rotational velocity satisfies $\beta = \omega\rho$. For small values of rotational velocity the particle remains confined inside the flux tube. The observed Zeeman splitting suggests that B is of order .1 Tesla. Quantum mechanically the confined particle is essentially equivalent with a harmonic oscillator with frequency ω in transversal degrees of freedom and behaves like free particle in longitudinal degrees of freedom. $B \simeq .3$ Tesla gives in case of proton the estimate $\omega \sim 10^{-7}$ eV for the frequency ω serving as the energy unit of the harmonic oscillator in question. Clearly, quasi-continuous spectrum is in question. The width of the ground state Gaussian wave function is $\rho_0 = \sqrt{\frac{1}{eB}}$ giving $\rho_0 \sim 10^{-8}$ meters for $B \sim .3$ Tesla. This gives the constraint $\rho > \rho_0$ to the thickness of the flux tube.

Higher Landau levels correspond to the radii $\rho_n = \sqrt{n}\rho_0$, $n = 1, 2, \dots$ with energy spectrum given by $E_{n,m} = (n + m/2)\omega$, with angular momentum quantum number m varying in the range $-2n \leq m \leq 2n$. Transversal excitations with energies up to thermal energy must be allowed and this allows excitations up to $n = 10^7$ and thermal stability against the transfer of proton to larger space-time sheets requires $\rho > 10^{-5}$ meters. Since rather large values of n are excited thermally, it is possible to treat the matter inside flux tubes as continuous matter obeying hydrodynamic equations and ordinary Boltzmann statistics (rather than behaving as degenerate Fermi gas). The dominant component of the velocity is along the flux tube. The requirement that the Compton wavelength of the thermal photon is smaller than ρ gives $\rho > 10^{-8}$ meters for $T \sim 10^2$ eV.

The effective black body temperature for the radiation from corona determined from the entire energy flux is not larger than 7000 K and corresponding energy density is roughly a fraction 10^{-9} of black body radiation temperature associated with the real temperature of order $T \sim 10^6$ K. Near the solar surface the density of matter is roughly 10^9 times that in corona [E198]. In the approximation that the matter density inside flux tubes is same in the corona and at the solar surface these observations suggest that the matter inside the magnetic flux tubes behaves as a dark matter and that the matter visible in the corona corresponds to a fraction 10^{-9} of dark matter leaked out from the magnetic flux tubes to space-time sheets where it becomes visible. This interpretation is consistent with the TGD based explanation of dark energy and dark matter in terms of magnetic energy of magnetic and Z^0 magnetic flux tubes and particles residing inside them (see the chapter "Cosmic Strings").

The particle density in the corona is of order $10^{14}/m^3$ particles [E198]. This implies a density of order $10^{23}/m^3$ particles (protons dominate in the mass density) inside flux tubes in corona. The density of solar wind particles is roughly $10^6/m^3$ at the solar surface [E198] and forms a fraction of order 10^{-17} of the density of matter at solar surface. If all solar wind particles are condensed at magnetic flux tubes, this means that only a fraction 10^{-17} of all magnetic flux tubes runs out of Sun! If flux tube structure is described as ordinary classical magnetic field one would say that most of magnetic energy resides in turbulent magnetic fields.

The basic equations of the model state the conservation of magnetic flux, particle number, energy and momentum. The requirement that the magnetic flux is conserved implies that the magnitude of BS , where S is the transverse area of the flux tube, is constant along the flux tube. Together with the conservation of particle number this gives the conditions

$$\begin{aligned} BS &= B_0 S_0 \ , \\ n_p v S &= n_p^0 v_0 S_0 \ . \end{aligned} \tag{9.3.1}$$

Since the flux tubes turns back to the solar surface in corona, the vertical component of v is reduced at the corona whereas the tangential component increases by energy conservation. If the particle density inside the flux tubes were much smaller at the solar surface than in corona, the fraction of volume occupied by the magnetic flux tubes at solar surface would be larger than one so that the changes of ρ and v must be rather small.

The conservation of energy, assuming that gravitational force couples to the flux tube geometry rather than the matter inside flux tube, gives

$$\sigma T^4 + \frac{1}{2}\rho v^2 + \frac{1}{2}B^2 + p = \text{constant} \ . \tag{9.3.2}$$

Here one has $\sigma \simeq 51.95/2\pi^2 \sim 3$. The pressure term associated with matter is in a good approximation negligible as compared to the energy density of the kinetic energy since the thermal velocity of proton at corona is about $10^{-3-1/2}$. The dominating part in the energy density at solar surface corresponds to the density of kinetic energy which is roughly 10^2 times larger than the thermal energy density of photons at corona and 10^4 times larger than the density

of the magnetic energy. If one assumes that the thickness of the flux tubes does not change, magnetic energy remains constant and one has $\rho v = \rho_0 v_0$, and energy conservation gives

$$\sigma \Delta(T^4) = -\frac{1}{2} \rho_0 v_0 \Delta v \quad ,$$

which gives

$$\frac{\Delta v}{v_0} = -\frac{2\sigma \Delta(T^4)}{\rho_0 v_0^2} \quad . \quad (9.3.3)$$

For $T = 10^2$ eV and $v_0 = 10^{-2}$ [E198] and $\rho_0 = 10^{23} m_p/m^3$ this gives $|\Delta\rho/\rho| = |\Delta v/v_0| = 6 \cdot 10^{-2} \ll 1$ so that the scenario is internally consistent. The slowing down of the particles as they approach the highly curved portion of the flux tube inside corona is natural.

As such the matter inside flux tubes is invisible and the high temperature matter in the corona results from a partial leakage of the particles from the magnetic flux tubes to other space-time sheets. The leakage of a fraction 10^{-9} would be caused by the large centrifugal acceleration at the highly curved portion of the flux tube. This would also explain why coronal holes are cooler than other regions of the corona.

The conservation of momentum together with the assumption that (most) matter flowing around flux tube returns back to the Sun implies that the matter topologically condensed at the flux tube feeds momentum in the degrees of freedom characterizing the size and shape of the flux tube and this must give rise to over all cm motion of the flux tube. The net force acting on the flux tube is obtained by integrating the divergence of the energy momentum tensor over the entire flux tube. Assuming that the velocity of matter at the return end is not considerably reduced, the contributions from the two ends are roughly identical and the expression for the resulting force acting on the cm of the flux tube reads as

$$F \simeq 2\rho_0 v_0^2 A \quad , \quad (9.3.4)$$

where A is the transverse area of the flux tube. Also gravitational force acts on the cm motion of the flux tube and in equilibrium the two forces must cancel each other.

$$GM(Sun)L \left\langle \frac{\rho}{(R(Sun) + h)^2} \right\rangle = \rho_0 v_0^2 \quad , \quad (9.3.5)$$

where h is the height from the surface of Sun and brackets denote averaging along the length of the flux tube of length L .

It can quite well happen that the momentum feed is so large that equilibrium is not possible and flux tube rises gradually and, if recombination of the flux tube ends giving rise to a closed flux tube occurs, runs away. This effect is enhanced by the fact that at large values of distance from Sun, where gravitational force is weakest, the mass density of the flux tube is largest. From the dependence of the gravitational force on height h it is clear that the eruption should occur when the height of prominence is same order of magnitude as solar radius: solar prominences have indeed the mysterious looking property of being unstable against upwards rather than downwards perturbations.

9.4 A quantum model for the formation of astrophysical structures and dark matter?

D. Da Rocha and Laurent Nottale, the developer of Scale Relativity, have ended up with an highly interesting quantum theory like model for the evolution of astrophysical systems [E175] (I am grateful for Victor Christianito for informing me about the article). In particular, this model applies to planetary orbits. I learned later that also A. Rubric and J. Rubric have proposed a Bohr model for planetary orbits [E176] already 1998.

The model is simply Schrödinger equation with Planck constant \hbar replaced with what might be called gravitational Planck constant

$$\hbar \rightarrow \hbar_{gr} = \frac{GmM}{v_0} . \quad (9.4.1)$$

Here I have used units $\hbar = c = 1$. v_0 is a velocity parameter having the value $v_0 = 144.7 \pm .7$ km/s giving $v_0/c = 4.6 \times 10^{-4}$. The peak orbital velocity of stars in galactic halos is 142 ± 2 km/s whereas the average velocity is 156 ± 2 km/s. Also sub-harmonics and harmonics of v_0 seem to appear.

The model makes fascinating predictions which hold true. For instance, the radii of planetary orbits fit nicely with the prediction of the hydrogen atom like model. The inner solar system (planets up to Mars) corresponds to v_0 and outer solar system to $v_0/5$.

The predictions for the distribution of major axis and eccentricities have been tested successfully also for exoplanets. Also the periods of 3 planets around pulsar PSR B1257+12 fit with the predictions with a relative accuracy of few hours/per several months. Also predictions for the distribution of stars in the regions where morphogenesis occurs follow from the gravitational Schrödinger equation.

What is important is that there are no free parameters besides v_0 . In [E175] a wide variety of astrophysical data is discussed and it seem that the model works and has already now made predictions which have been later verified. In the following I shall discuss Nottale's model from the point of view of TGD.

9.4.1 TGD prediction for the parameter v_0

One of the basic questions is the origin of the parameter v_0 , which according to a rich amount of experimental data discussed in [E175] seems to play a role of a constant of Nature. One of the first applications of cosmic strings in TGD sense was an explanation of the velocity spectrum of stars in the galactic halo in terms of dark matter which could consists of cosmic strings. Cosmic strings could be orthogonal to the galactic plane going through the nucleus (jets) or they could be in galactic plane in which case the strings and their decay products would explain dark matter assuming that the length of cosmic string inside a sphere of radius R is or has been roughly R [K24]. The predicted value of the string tension is determined by the CP_2 radius whose ratio to Planck length is fixed by electron mass via p-adic mass calculations. The resulting prediction for the v_0 is correct and provides a working model for the constant orbital velocity of stars in the galactic halo.

The parameter $v_0 \simeq 2^{-11}$, which has actually the dimension of velocity unless one puts $c = 1$, and also its harmonics and sub-harmonics appear in the scaling of \hbar . v_0 corresponds to the velocity of distant stars in the model of galactic dark matter. TGD allows to identify this parameter as the parameter

$$\begin{aligned} v_0 &= 2\sqrt{TG} = \sqrt{\frac{1}{2\alpha_K}} \sqrt{\frac{G}{R^2}} , \\ T &= \frac{1}{8\alpha_K} \frac{\hbar_0}{R^2} . \end{aligned} \quad (9.4.2)$$

Here T is the string tension of cosmic strings, R denotes the "radius" of CP_2 ($2R$ is the radius of geodesic sphere of CP_2). α_K is Kähler coupling strength, the basic coupling constant strength of TGD, whose evolution as a function of p-adic length scale is fixed by quantum criticality. The condition that G is invariant in the p-adic coupling constant evolution and number theoretical arguments predict

$$\alpha_K(p) = k \frac{1}{\log(p) + \log(K)} ,$$

$$K = \frac{R^2}{\hbar_0 G} = 2 \times 3 \times 5 \times 7 \times 11 \times 13 \times 17 \times 19 \times 23 , \quad k \simeq \pi/4 . \tag{9.4.3}$$

The predicted value of v_0 depends logarithmically on the p-adic length scale and for $p \simeq 2^{127} - 1$ (electron's p-adic length scale) one has $v_0 \simeq 2^{-11}$.

9.4.2 Model for planetary orbits without $v_0 \rightarrow v_0/5$ scaling

Also harmonics and sub-harmonics of v_0 appear in the model of Nottale and Da Rocha. For instance, the outer planets (Jupiter, Saturn,...) correspond to $v_0/5$ whereas inner planets correspond to v_0 . Quite generally, it is found that the values seem to come as harmonics and sub-harmonics of v_0 : $v_n = nv_0$ and v_0/n , and the argument [E175] is that the different values of n relate to fractality. This scaling is not necessary for the planetary orbits in TGD based model.

Effectively a multiplication $n \rightarrow 5n$ of the principal quantum number is in question in the case of outer planets. If one accepts the interpretation that visible matter has concentrated around dark matter, which is in macroscopic quantum phase around Bohr orbits, this allows to consider also the possibility that \hbar_{gr} has the same value for all planets.

- (a) Some gravitational perturbation has kicked dark matter from the region of the asteroid belt to $n \simeq 5k$, $k = 2, \dots, 6$, orbits. The best fit is obtained by using values of n deviating somewhat from multiples of 5 which suggests that the scaling of v_0 is not needed. Gravitational perturbations might have caused the same for the visible matter. The fact that the tilt angles of Earth and outer planets other than Pluto are nearly the same suggests that the orbits of these planets might be an outcome of some violent quantum process for dark matter preserving the orbital plane in a good approximation. Pluto might in turn have experienced some violent collision changing its orbital plane.
- (b) There could exist at least small amounts of dark matter at all orbits but visible matter is concentrated only around orbits containing some critical amount of dark matter.

Planet	Exp. R/R_M	T-B R/R_M	Bohr ₁ $[n, R/R_M]$	Bohr ₂ $[n, R/R_M]$
Mercury	1	1	[3, 1]	
Venus	1.89	1.75	[4, 1.8]	
Earth	2.6	2.5	[5, 2.8]	
Mars	3.9	4	[6, 4]	
Asteroids	6.1-8.7	7	[(7, 8, 9), (5.4, 7.1, 9)]	
Jupiter	13.7	13	[11, 13.4]	[2 × 5, 11.1]
Saturn	25.0	25	[3 × 5, 25]	[3 × 5, 25]
Uranus	51.5	49	[22, 53.8]	[4 × 5, 44.4]
Neptune	78.9	97	[27, 81]	[5 × 5, 69.4]
Pluto	105.2	97	[31, 106.7]	[6 × 5, 100]

Table 1. The table represents the experimental average orbital radii of planets, the predictions of Titius-Bode law (note the failure for Neptune), and the predictions of Bohr orbit model assuming

a) that the principal quantum number n corresponds to best possible fit, b) the scaling $v_0 \rightarrow v_0/5$ for outer planets. Option a) gives the best fit with errors being considerably smaller than the maximal error $|\Delta R|/R \simeq 1/n$ except for Uranus. R_M denotes the orbital radius of Mercury. T-B refers to Titius-Bode law.

How to understand the harmonics and sub-harmonics of v_0 in TGD framework?

Also harmonics and sub-harmonics of v_0 appear in the model of Nottale and Da Rocha. In particular, the outer planets (Jupiter, Saturn,...) correspond to $v_0/5$ whereas inner planets correspond to v_0 in this model. As already found, TGD allows also an alternative explanation.

Quite generally, it is found that the values seem to come as harmonics and sub-harmonics of v_0 : $v_n = nv_0$ and v_0/n , and the argument [E175] is that the different values of n relate to fractality. This quantization is a challenge for TGD since v_0 certainly defines a fundamental constant in TGD Universe.

- (a) Consider first the harmonics of v_0 . Besides cosmic strings of type $X^2 \times S^2 \subset M^4 \times CP_2$ one can consider also deformations of these strings defining their multiple coverings so that the deformation is n -valued as a function of S^2 -coordinates (Θ, Φ) and the projection to S^2 is thus an $n \rightarrow 1$ map. The solutions are higher dimensional analogs of originally closed orbits which after perturbation close only after n turns. This kind of surfaces emerge in the TGD inspired model of quantum Hall effect naturally [K88] and $n \rightarrow \infty$ limit has an interpretation as an approach to chaos [K83].

Using the coordinates (x, y, θ, ϕ) of $X^2 \times S^2$ and coordinates m^k for M^4 of the unperturbed solution the space-time surface the deformation can be expressed as

$$\begin{aligned} m^k &= m^k(x, y, \theta, \phi) , \\ (\Theta, \Phi) &= (\theta, n\phi) . \end{aligned} \tag{9.4.4}$$

The value of the string tension would be indeed n^2 -fold in the first approximation since the induced Kähler form defining the Kähler magnetic field would be $J_{\theta\phi} = n \sin(\Theta)$ and one would have $v_n = nv_0$. At the limit $m^k = m^k(x, y)$ different branches for these solutions collapse together.

- (b) Consider next how sub-harmonics appear in TGD framework. Cosmic strings are predicted to decay to magnetic flux tube structures by absolute minimization of Kähler action. The Kähler magnetic flux $\Phi = BS$ is conserved in the process but the thickness of the M^4 projection of the cosmic string increases field strength is reduced. This means that string tension, which is proportional to B^2S , is reduced (so that also Kähler action is reduced). The fact that space-time surface is Bohr orbit in generalized sense means that the reduced string tension (magnetic energy per unit length) is quantized.

The task is to guess how the quantization occurs. There are two options.

- (a) The simplest explanation for the reduction of v_0 is based on the decay of a flux tube resembling a disk with a hole to n identical flux tubes so that $v_0 \rightarrow v_0/n$ results for the resulting flux tubes. It turns out that this mechanism is favored and explains elegantly the value of \hbar_{gr} for outer planetary system. One can also consider small-p p-adicity so that n would be prime.
- (b) Second explanation is more intricate. Consider a magnetic flux tube. Since magnetic flux is quantized, the magnetic field strengths are quantized in integer multiples of basic strength: $B = nB_0$ and would rather naturally correspond to the multiple coverings of the original magnetic flux tube with magnetic energy quantized in multiples of n^2 . The idea is to require internal consistency in the sense that the allowed reduced field strengths are such that the spectrum associated with B_0 is contained to the spectrum associated with the quantized field strengths $B_1 > B_0$. This would allow only field strengths $B = B_S/n^2$, where B_S denotes the field strength of the fundamental cosmic string and one would have $v_n = v_0/n$. Flux conservation requires that the area of the flux tube scales as n^2 .

Sub-harmonics might appear in the outer planetary system and there are indications for the higher harmonics below the inner planetary system [E175] : for instance, solar radius corresponds to $n = 1$ orbital for $v_3 = 3v_0$. This would suggest that Sun and also planets have an onion like structure with highest harmonics of v_0 and strongest string tensions appearing in the solar core and highest sub-harmonics appearing in the outer regions. If the matter results as decay remnants of cosmic strings this means that the mass density inside Sun should correlate strongly with the local value of n characterizing the multiple covering of cosmic strings.

One can ask whether the very process of the formation of the structures could have excited the higher values of n just like closed orbits in a perturbed system become closed only after n turns. The energy density of the cosmic string is about one Planck mass per $\sim 10^7$ Planck lengths so that $n > 1$ excitation increasing this density by a factor of n^2 is obviously impossible except under the primordial cosmic string dominated period of cosmology during which the net inertial energy density must have vanished. The structure of the future solar system would have been dictated already during the primordial phase of cosmology when negative energy cosmic string suffered a time reflection to positive energy cosmic strings.

Nottale equation is consistent with the TGD based model for dark matter

TGD allows two models of dark matter. The first one is spherically symmetric and the second one cylindrically symmetric. The first thing to do is to check whether these models are consistent with the gravitational Schödinger equation/Bohr quantization.

1. Spherically symmetric model for the dark matter

The following argument based on Bohr orbit quantization demonstrates that this is indeed the case for the spherically symmetric model for dark matter. The argument generalizes in a trivial manner to the cylindrically symmetric case.

- (a) The gravitational potential energy $V(r)$ for a mass distribution $M(r) = xTr$ (T denotes string tension) is given by

$$V(r) = Gm \int_r^{R_0} \frac{M(r)}{r^2} dr = GmxT \log\left(\frac{r}{R_0}\right) . \tag{9.4.5}$$

Here R_0 corresponds to a large radius so that the potential is negative as it should in the region where binding energy is negative.

- (b) The Newton equation $\frac{mv^2}{r} = \frac{GmxT}{r}$ for circular orbits gives

$$v = xGT . \tag{9.4.6}$$

- (c) Bohr quantization condition for angular momentum by replacing \hbar with \hbar_{gr} reads as $mvr = n\hbar_{gr}$ and gives

$$\begin{aligned} r_n &= \frac{n\hbar_{gr}}{mv} = nr_1 , \\ r_1 &= \frac{GM}{vv_0} . \end{aligned} \tag{9.4.7}$$

Here v is rather near to v_0 .

- (d) Bound state energies are given by

$$E_n = \frac{mv^2}{2} - xT \log\left(\frac{r_1}{R_0}\right) + xT \log(n) . \tag{9.4.8}$$

The energies depend only weakly on the radius of the orbit.

- (e) The centrifugal potential $l(l+1)/r^2$ in the Schrödinger equation is negligible as compared to the potential term at large distances so that one expects that degeneracies of orbits with small values of l do not depend on the radius. This would mean that each orbit is occupied with same probability irrespective of value of its radius. If the mass distribution for the stars does not depend on r , the number of stars rotating around galactic nucleus is simply the number of orbits inside sphere of radius R and thus given by $N(R) \propto R/r_0$ so that one has $M(R) \propto R$. Hence the model is self consistent in the sense that one can regard the orbiting stars as remnants of cosmic strings and thus obeying same mass distribution.

2. Cylindrically symmetric model for the galactic dark matter

TGD allows also a model of the dark matter based on cylindrical symmetry. In this case the dark matter would correspond to the mass of a cosmic string orthogonal to the galactic plane and traversing through the galactic nucleus. The string tension would be the one predicted by TGD. In the directions orthogonal to the plane of galaxy the motion would be free motion so that the orbits would be helical, and this should make it possible to test the model. The quantization of radii of the orbits would be exactly the same as in the spherically symmetric model. Also the quantization of inclinations predicted by the spherically symmetric model could serve as a sensitive test. In this kind of situation general theory of relativity would predict only an angle deficit giving rise to a lens effect. TGD predicts a Newtonian $1/\rho$ potential in a good approximation.

Spiral galaxies are accompanied by jets orthogonal to the galactic plane and a good guess is that they are associated with the cosmic strings. The two models need not exclude each other. The vision about astrophysical structures as pearls of a fractal necklace would suggest that the visible matter has resulted in the decay of cosmic strings originally linked around the cosmic string going through the galactic plane and creating $M(R) \propto R$ for the density of the visible matter in the galactic bulge. The finding that galaxies are organized along linear structures [E197] fits nicely with this picture.

MOND and TGD

TGD based model explains also the MOND (Modified Newton Dynamics) model of Milgrom [E166] for the dark matter. Instead of dark matter the model assumes a modification of Newton's laws. The model is based on the observation that the transition to a constant velocity spectrum seems in the galactic halos seems to occur at a constant value of the stellar acceleration equal to $a_0 \simeq 10^{-11}g$, where g is the gravitational acceleration at the Earth. MOND theory assumes that Newtonian laws are modified below a_0 .

The explanation relies on Bohr quantization. Since the stellar radii in the halo are quantized in integer multiples of a basic radius and since also rotation velocity v_0 is constant, the values of the acceleration are quantized as $a(n) = v_0^2/r(n)$ and a_0 correspond to the radius $r(n)$ of the smallest Bohr orbit for which the velocity is still constant. For larger orbital radii the acceleration would indeed be below a_0 . a_0 would correspond to the distance above which the density of the visible matter does not appreciably perturb the gravitational potential of the straight string. This of course requires that gravitational potential is that given by Newton's theory and is indeed allowed by TGD.

The MOND theory [E166] and its variants predict that there is a critical acceleration below which Newtonian gravity fails. This would mean that Newtonian gravitation is modified at large distances. String models and also TGD predict just the opposite since in this regime General Relativity should be a good approximation.

- (a) The $1/r^2$ force would transform to $1/r$ force at some critical acceleration of about $a = 10^{-10}$ m/s²: this is a fraction of 10^{-11} about the gravitational acceleration at the Earth's surface.
- (b) The recent empirical study [E195] giving support for this kind of transition in the dynamics of stars at large distances and therefore breakdown of Newtonian gravity in MOND like theories.

In TGD framework critical acceleration is predicted but the recent experiment does not force to modify Newton's laws. Since Big Science is like market economy in the sense that funding is more important than truth, the attempts to communicate TGD based view about dark matter [K30, K72, K61, K73, K24] have turned out to be hopeless. Serious Scientist does not read anything not written on silk paper.

- (a) One manner to produce this spectrum is to assume density of dark matter such that the mass inside sphere of radius R is proportional to R at last distances [K24]. Decay products of and ideal cosmic strings would predict this. The value of the string tension predicted correctly by TGD using the constraint that p-adic mass calculations give electron mass correctly [K48].
- (b) One could also assume that galaxies are distributed along cosmic string like pearls in necklace. The mass of the cosmic string would predict correct value for the velocity of distant stars. In the ideal case there would be no dark matter outside these cosmic strings.
 - i. The difference with respect to the first mechanism is that this case gravitational acceleration would vanish along the direction of string and motion would be free motion. The prediction is that this kind of motions take place along observed linear structures formed by galaxies and also along larger structures.
 - ii. An attractive assumption is that dark matter corresponds to phases with large value of Planck constant is concentrated on magnetic flux tubes. Holography would suggest that the density of the magnetic energy is just the density of the matter condensed at wormhole throats associated with the topologically condensed cosmic string.
 - iii. Cosmic evolution modifies the ideal cosmic strings and their Minkowski space projection gets gradually thicker and thicker and their energy density - magnetic energy - characterized by string tension could be affected

TGD option differs from MOND in some respects and it is possible to test empirically which option is nearer to the truth.

- (a) The transition at same critical acceleration is predicted universally by this option for all systems-now stars- with given mass scale if they are distributed along cosmic strings like like pearls in necklace. The gravitational acceleration due the necklace simply wins the gravitational acceleration due to the pearl. Fractality encourages to think like this.
- (b) The critical acceleration predicted by TGD_r depends on the mass scale as $a \propto GT^2/M$, where M is the mass of the object- now star. Since the recent study considers only stars with solar mass it does not allow to choose between MOND and TGD and Newton can continue to rest in peace in TGD Universe. Only a study using stars with different masses would allow to compare the predictions of MOND and TGD and kill either option or both. Second test distinguishing between MOND and TGD is the prediction of large scale free motions by TGD option.

TGD option explains also other strange findings of cosmology.

- (a) The basic prediction is the large scale motions of dark matter along cosmic strings. The characteristic length and time scale of dynamics is scaled up by the scaling factor of \hbar . This could explain the observed large scale motion of galaxy clusters -dark flow [E13]- assigned with dark matter in conflict with the expectations of standard cosmology.
- (b) Cosmic strings could also relate to the strange relativistic jet like structures [E37] meaning correlations between very distant objects. Universe would be a spaghetti of cosmic strings around which matter is concentrated.
- (c) The TGD based model for the final state of star [K85] actually predicts the presence of string like object defining preferred rotation axis. The beams of light emerging from supernovae would be preferentially directed along this lines- actually magnetic flux tubes. Same would apply to the gamma ray bursts [E18] from quasars, which would not be distributed evenly in all directions but would be like laser beams along cosmic strings.

9.4.3 The interpretation of \hbar_{gr} and pre-planetary period

\hbar_{gr} could correspond to a unit of angular momentum for quantum coherent states at magnetic flux tubes or walls containing macroscopic quantum states. Quantitative estimate demonstrates that \hbar_{gr} for astrophysical objects cannot correspond to spin angular momentum. For Sun-Earth system one would have $\hbar_{gr} \simeq 10^{77} \hbar$. This amount of angular momentum realized as a mere spin would require 10^{77} particles! Hence the only possible interpretation is as a unit of orbital angular momentum. The linear dependence of \hbar_{gr} on m is consistent with the additivity of angular momenta in the fusion of magnetic flux tubes to larger units if the angular momentum associated with the tubes is proportional to both m and M .

Just as the gravitational acceleration is a more natural concept than gravitational force, also $\hbar_{gr}/m = GM/v_0$ could be more natural unit than \hbar_{gr} . It would define a universal unit for the circulation $\oint v \cdot dl$, which is apart from $1/m$ -factor equal to the phase integral $\oint p_\phi d\phi$ appearing in Bohr rules for angular momentum. The circulation could be associated with the flow associated with outer boundaries of magnetic flux tubes surrounding the orbit of mass m around the central mass $M \gg m$ and defining light like 3-D CDs analogous to black hole horizons.

The expression of \hbar_{gr} depends on masses M and m and can apply only in space-time regions carrying information about the space-time sheets of M and the orbit of m . Quantum gravitational holography suggests that the formula applies at 3-D light like causal determinant (CD) X_l^3 defined by the wormhole contacts gluing the space-time sheet X_l^3 of the planet to that of Sun. More generally, X_l^3 could be the space-time sheet containing the planet, most naturally the magnetic flux tube surrounding the orbit of the planet and possibly containing dark matter in super-conducting state. This would give a precise meaning for \hbar_{gr} and explain why \hbar_{gr} does not depend on the masses of other planets.

The simplest option consistent with the quantization rules and with the explanatory role of magnetic flux structures is perhaps the following one.

- (a) X_l^3 is a torus like surface around the orbit of the planet containing delocalized dark matter. The key role of magnetic flux quantization in understanding the values of v_0 suggests the interpretation of the torus as a magnetic or Z^0 magnetic flux tube. At pre-planetary period the dark matter formed a torus like quantum object. The conditions defining the radii of Bohr orbits follow from the requirement that the torus-like object is in an eigen state of angular momentum in the center of mass rotational degrees of freedom. The requirement that rotations do not leave the torus-like object invariant is obviously satisfied. Newton's law required by the quantum-classical correspondence stating that the orbit corresponds to a geodesic line in general relativistic framework gives the additional condition implying Bohr quantization.
- (b) A simple mechanism leading to the localization of the matter would have been the pinching of the torus causing kind of a traffic jam leading to the formation of the planet. This process could quite well have involved a flow of matter to a smaller planet space-time sheet Y_l^3 topologically condensed at X_l^3 . Most of the angular momentum associated with torus like object would have transformed to that of planet and situation would have become effectively classical.
- (c) The fact that \hbar_{gr} is proportional to m means that it could have varied continuously during the accumulation of the planetary mass without any effect in the planetary motion: this is of course nothing but a manifestation of Equivalence Principle.
- (d) It is interesting to look for the scaled up versions of Planck mass $m_{Pl} = \sqrt{\hbar_{gr}/\hbar} \times \sqrt{\hbar/G} = \sqrt{M_1 M_2 / v_0}$ and Planck length $L_{Pl} = \sqrt{\hbar_{gr}/\hbar} \times \sqrt{\hbar/G} = G \sqrt{M_1 M_2 / v_0}$. For $M_1 = M_2 = M$ this gives $m_{Pl} = M/\sqrt{v_0} \simeq 45.6 \times M$ and $L_{Pl} = r_S/2\sqrt{v_0} \simeq 22.8 \times r_S$, where r_S is Schwarzschild radius. For Sun r_S is about 2.9 km so that one has $L_{Pl} \simeq 66$ km. For a few years ago it was found that Sun contains "inner-inner" core of radius about $R = 300$ km [F34] which is about $4.5 \times L_{Pl}$.

9.4.4 Inclinations for the planetary orbits and the quantum evolution of the planetary system

The inclinations of planetary orbits provide a test bed for the theory. The semiclassical quantization of angular momentum gives the directions of angular momentum from the formula

$$\cos(\theta) = \frac{m}{\sqrt{j(j+1)}} \quad , \quad |m| \leq j \quad . \quad (9.4.9)$$

where θ is the angle between angular momentum and quantization axis and thus also that between orbital plane and (x,y)-plane. This angle defines the angle of tilt between the orbital plane and (x,y)-plane.

$m = j = n$ gives minimal value of angle of tilt for a given value of n of the principal quantum number as

$$\cos(\theta) = \frac{n}{\sqrt{n(n+1)}} \quad . \quad (9.4.10)$$

For $n = 3, 4, 5$ (Mercury, Venus, Earth) this gives $\theta = 30.0, 26.6,$ and 24.0 degrees respectively.

Only the relative tilt angles can be compared with the experimental data. Taking as usual the Earth's orbital plane as the reference the relative tilt angles give what are known as inclinations. The predicted inclinations are 6 degrees for Mercury and 2.6 degrees for Venus. The observed values [E46] are 7.0 and 3.4 degrees so that the agreement is satisfactory. If one allows half-odd integer spin the fit is improved. For $j = m = n - 1/2$ the predictions are 7.1 and 2.9 degrees for Mercury and Venus respectively. For Mars, Jupiter, Saturn, Uranus, Neptune, and Pluto the inclinations are 1.9, 1.3, 2.5, 0.8, 1.8, 17.1 degrees. For Mars and outer planets the tilt angles are predicted to have wrong sign for $m = j$. In a good approximation the inclinations vanish for outer planets except Pluto and this would allow to determine m as $m \simeq \sqrt{5n(n+1)}/6$: the fit is not good.

The assumption that matter has condensed from a matter rotating in (x,y)-plane orthogonal to the quantization axis suggests that the directions of the planetary rotation axes are more or less the same and by angular momentum conservation have not changed appreciably. The prediction for the tilt of the rotation axis of the Earth is 24 degrees of freedom in the limit that the Earth's spin can be treated completely classically, that is for $m = j \gg 1$ in the units used for the quantization of the Earth's angular momentum. What is the value of \hbar_{gr} for Earth is not obvious (using the unit $\hbar_{gr} = GM^2/v_0$ the Earth's angular momentum would be much smaller than one). The tilt of the rotation axis of Earth with respect to the orbit plane is 23.5 degrees so that the agreement is again satisfactory. This prediction is essentially quantal: in purely classical theory the most natural guess for the tilt angle for planetary spins is 0 degrees.

The observation that the inner planets Mercury, Venus, and Earth have in a reasonable approximation the predicted inclinations suggest that they originate from a primordial period during which they formed spherical cells of dark matter and had thus full rotational degrees of freedom and were in eigen states of angular momentum corresponding to a full rotational symmetry. The subsequent $SO(3) \rightarrow SO(2)$ symmetry breaking leading to the formation of torus like configurations did not destroy the information about this period since the information about the value of j and m was coded by the inclination of the planetary orbit.

In contrast to this, the dark matter associated with Earth and outer planets up to Neptune formed a flattened magnetic or Z^0 magnetic flux tube resembling a disk with a hole and the subsequent symmetry breaking broke it to separate flux tubes. Earth's spherical disk was joined to the disk formed by the outer planets. The spherical disk could be still present and contain super-conducting dark matter. The presence of this "heavenly sphere" might closely relate to the fact that Earth is a living planet. The time scale $T = 2\pi R/c$ is very nearly equal to 5 minutes and defines a candidate for a bio-rhythm.

If this flux tube carried the same magnetic flux as the flux tubes associated with the inner planets, the decomposition of the disk with a hole to 5 flux tubes corresponding to Earth and to the outer planets Mars, Jupiter, Saturn and Neptune, would explain the value of v_0 correctly and also the small inclinations of outer planets. That Pluto would not originate from this structure, is consistent with its anomalously large values of inclination $i = 17.1$ degrees, small value of eccentricity $e = .248$, and anomalously large value of inclination of equator to orbit about 122 degrees as compared to 23.5 degrees in the case of Earth [E46] .

9.4.5 Eccentricities and comets

Bohr-Sommerfeld quantization allows also to deduce the eccentricities of the planetary and comet orbits. One can write the quantization of energy as

$$\frac{p_r^2}{2m_1} + \frac{p_\theta^2}{2m_1 r^2} + \frac{p_\phi^2}{2m_1 r^2 \sin^2(\theta)} - \frac{k}{r} = -\frac{E_1}{n^2} ,$$

$$E_1 = \frac{k^2}{2\hbar_{gr}^2} \times m_1 = \frac{v_0^2}{2} \times m_1 . \quad (9.4.11)$$

Here one has $k = GMm_1$. E_1 is the binding energy of $n = 1$ state. In the orbital plane ($\theta = \pi/2, p_\theta = 0$) the conditions are simplified. Bohr quantization gives $p_\phi = m\hbar_{gr}$ implying

$$\frac{p_r^2}{2m_1} + \frac{k^2 \hbar_{gr}^2}{2m_1 r^2} - \frac{k}{r} = -\frac{E_1}{n^2} . \quad (9.4.12)$$

For $p_r = 0$ the formula gives maximum and minimum radii r_\pm and eccentricity is given by

$$e^2 = \frac{r_+ - r_-}{r_+} = \frac{2\sqrt{1 - \frac{m^2}{n^2}}}{1 + \sqrt{1 - \frac{m^2}{n^2}}} . \quad (9.4.13)$$

For small values of n the eccentricities are very large except for $m = n$. For instance, for ($m = n - 1, n$) for $n = 3, 4, 5$ gives $e = (.93, .89, .86)$ to be compared with the experimental values (.206, .007, .0167). Thus the planetary eccentricities with Pluto included ($e = .248$) must vanish in the lowest order approximation and must result as a perturbation of the magnetic flux tube.

The large eccentricities of comet orbits might however have an interpretation in terms of $m < n$ states. The prediction is that comets with small eccentricities have very large orbital radius. Oort's cloud is a system weakly bound to a solar system extending up to 3 light years. This gives the upper bound $n \leq 700$ if the comets of the cloud belong to the same family as Mercury, otherwise the bound is smaller. This gives a lower bound to the eccentricity of not nearly circular orbits in the Oort cloud as $e > .32$.

9.4.6 Why the quantum coherent dark matter is not visible?

The obvious objection against quantal astrophysics is that astrophysical systems look extremely classical. Quantal dark matter in many-sheeted space-time resolves this counter argument. As already explained, the sequence of symmetry breakings of the rotational symmetry would explain nicely why astral Bohr rules work. The prediction is however that delocalized quantal dark matter is probably still present at (the boundaries of) magnetic flux tubes and spherical shells. It is however the entire structure defined by the orbit which behaves like a single extended

particle so that the localization in quantum measurement does not mean a localization to a point of the orbit. Planet itself corresponds to a smaller localized space-time sheet condensed at the flux tube.

One should however understand why this dark matter with a gigantic Planck constant is not visible. The simplest explanation is that there cannot be any direct quantum interactions between ordinary and dark matter in the sense that particles with different values of Planck constant could appear in the same particle vertex. This would allow also a fractal hierarchy copies of standard model physics to exist with different p-adic mass scales.

There is also second argument. The inability to observe dark matter could mean inability to perform state function reduction localizing the dark matter. The probability for this should be proportional to the strength of the measurement interaction. For photons the strength of the interaction is characterized by the fine structure constant. In the case of dark matter the fine structure constant is replaced with

$$\alpha_{em,gr} = \alpha_{em} \times \frac{\hbar}{\hbar_{gr}} = \alpha_{em} \times \frac{v_0}{GMm} . \quad (9.4.14)$$

For $M = m = m_{Pl} \simeq 10^{-8}$ kg the value of the fine structure constant is smaller than $\alpha_{em} v_0$ and completely negligible for astrophysical masses. However, for processes for which the lowest order classical rates are non-vanishing, rates are not affected in the lowest order since the increase of the Compton length compensates the reduction of α . Higher order corrections become however small. What makes dark matter invisible is not the smallness of α_{em} but the fact that the binding energies of say hydrogen atom proportional to $\alpha^2 m_e$ are scaled as $1/\hbar^2$ so that the spectrum is scaled down.

9.4.7 Quantum interpretation of gravitational Schrödinger equation

Schrödinger equation in astrophysical length scales with a gigantic value of Planck constant looks sheer madness idea from the standard physics point of view. In TGD Universe situation might be different.

- (a) In TGD inertial four-momentum (or conserved four-momentum) is not positive definite and the net four-momentum of the Universe vanishes. Already in cosmological length scales the density of inertial mass vanishes. Gravitational masses and inertial masses can be identified only at the limit when one can neglect the interaction between positive and negative energy matter. The masses appearing in the gravitational Schrödinger equation are gravitational masses and one can ask whether inertial and gravitational Planck constants are different.
- (b) The fractality of the many-sheeted space-time predicts that quantum effects appear in all length and time scales. In particular, dark matter is at larger space-time sheets and hence almost invisible.
- (c) An even more weirder looks the idea that Planck constant could have a gigantic value in astrophysical length scales being of order of magnitude of product of masses using Planck mass as a unit for $\hbar = c = 1$. This would mean that gravitation at space-time sheets of astrophysical size would have super quantal character! But even the gigantic value of Planck constant might be understood in TGD framework.

Bohr quantization of planetary orbits and prediction for Planck constant

The predictions of the generalization of the p-adic length scale hypothesis are consistent with the TGD based model for the Bohr quantization of planetary orbits and some new non-trivial predictions follow.

1. Generalization of the p-adic length scale hypothesis

The evolution in phase resolution in p-adic degrees of freedom corresponds to emergence of algebraic extensions allowing increasing variety of phases $exp(i\pi/n)$ expressible p-adically. This evolution can be assigned to the emergence of increasingly complex quantum phases and the increase of Planck constant.

One expects that quantum phases $q = exp(i\pi/n)$ which are expressible using only square roots of rationals are number theoretically very special since they correspond to algebraic extensions of p-adic numbers involving only square roots which should emerge first and therefore systems involving these values of q should be especially abundant in Nature.

These polygons are obtained by ruler and compass construction and Gauss showed that these polygons, which could be called Fermat polygons, have $n_F = 2^k \prod_s F_{n_s}$ sides/vertices: all Fermat primes F_{n_s} in this expression must be different. The analog of the p-adic length scale hypothesis emerges since larger Fermat primes are near a power of 2. The known Fermat primes $F_n = 2^{2^n} + 1$ correspond to $n = 0, 1, 2, 3, 4$ with $F_0 = 3, F_1 = 5, F_2 = 17, F_3 = 257, F_4 = 65537$. It is not known whether there are higher Fermat primes. $n = 3, 5, 15$ -multiples of p-adic length scales clearly distinguishable from them are also predicted and this prediction is testable in living matter. I have already earlier considered the possibility that Fermat polygons could be of special importance for cognition and for biological information processing [K57].

This condition could be interpreted as a kind of resonance condition guaranteeing that scaled up sizes for space-time sheets have sizes given by p-adic length scales. The numbers n_F could take the same role in the evolution of Planck constants assignable with the phase resolution as Mersenne primes have in the evolution assignable to the p-adic length scale resolution.

2. Do the values of gravitational Planck constant correspond to polygons obtained by ruler and compass construction?

Since the macroscopic quantum phases with minimum dimension of algebraic extension should be especially abundant in the universe, the natural guess is that the values of the gravitational Planck constant correspond to n_F -multiples of ordinary Planck constant.

- (a) The model can explain the enormous values of gravitational Planck constant $\hbar_{gr}/\hbar_0 = \simeq GMm/v_0 = n_a/n_b$. The favored values of this parameter should correspond to n_{F_a}/n_{F_b} so that the mass ratios $m_1/m_2 = n_{F_{a,1}}n_{F_{b,2}}/n_{F_{b,1}}n_{F_{a,2}}$ for planetary masses should be preferred. The general prediction $GMm/v_0 = n_a/n_b$ is of course not testable.
- (b) Nottale [E175] has suggested that also the harmonics and subharmonics of λ are possible and in fact required by the model for planetary Bohr orbits (in TGD framework this is not absolutely necessary). The prediction is that favored values of n should be of form $n_F = 2^k \prod F_i$ such that F_i appears at most once. In Nottale's model for planetary orbits as Bohr orbits in solar system $n = 5$ harmonics appear and are consistent with either $n_{F,a} \rightarrow F_1 n_{F_a}$ or with $n_{F,b} \rightarrow n_{F_b}/F_1$ if possible.

The prediction for the ratios of planetary masses can be tested. In the table below are the experimental mass ratios $r_{exp} = m(pl)/m(E)$, the best choice of $r_R = [n_{F,a}/n_{F,b}] * X$, X common factor for all planets, and the ratios $r_{pred}/r_{exp} = n_{F,a}(planet)n_{F,b}(Earth)/n_{F,a}(Earth)n_{F,b}(planet)$. The deviations are at most 2 per cent.

planet	Me	V	E	M	J
y	$\frac{2^{13} \times 5}{17}$	$2^{11} \times 17$	$2^9 \times 5 \times 17$	$2^8 \times 17$	$\frac{2^{23} \times 5}{7}$
y/x	1.01	.98	1.00	.98	1.01
planet	S	U	N	P	
y	$2^{14} \times 3 \times 5 \times 17$	$\frac{2^{21} \times 5}{17}$	$\frac{2^{17} \times 17}{3}$	$\frac{2^4 \times 17}{3}$	
y/x	1.01	.98	.99	.99	

Table 1. The table compares the ratios $x = m(pl)/(m(E))$ of planetary mass to the mass of Earth to prediction for these ratios in terms of integers n_F associated with Fermat polygons.

y gives the best fit for the allowed factors of the known part y of the rational $n_{F,a}/n_{F,b} = yX$ characterizing planet, and the ratios y/x . Errors are at most 2 per cent.

A stronger prediction comes from the requirement that GMm/v_0 equals to $n = n_{F,a}/n_{F,b} n_F = 2^k \prod_k F_{n_k}$, where $F_i = 2^{2^i} + 1$, $i = 0, 1, 2, 3, 4$ is Fibonacci prime. The fit using solar mass and Earth mass gives $n_F = 2^{254} \times 5 \times 17$ for $1/v_0 = 2044$, which within the experimental accuracy equals to the value $2^{11} = 2048$ whose powers appear as scaling factors of Planck constant in the model for living matter [K26]. For $v_0 = 4.6 \times 10^{-4}$ reported by Nottale the prediction is by a factor $16/17.01$ too small (6 per cent discrepancy).

A possible solution of the discrepancy is that the empirical estimate for the factor GMm/v_0 is too large since m contains also the the visible mass not actually contributing to the gravitational force between dark matter objects whereas M is known correctly. The assumption that the dark mass is a fraction $1/(1 + \epsilon)$ of the total mass for Earth gives

$$1 + \epsilon = \frac{17}{16} \tag{9.4.15}$$

in an excellent approximation. This gives for the fraction of the visible matter the estimate $\epsilon = 1/16 \simeq 6$ per cent. The estimate for the fraction of visible matter in cosmos is about 4 per cent so that estimate is reasonable and would mean that most of planetary and solar mass would be also dark (as a matter dark energy would be in question).

That $v_0(eff) = v_0/(1 - \epsilon) \simeq 4.6 \times 10^{-4}$ equals with $v_0(grav) = 1/(2^7 \times F_2) = 4.5956 \times 10^{-4}$ within the experimental accuracy suggests a number theoretical explanation for the visible-to-dark fraction.

3. Can one really identify gravitational and inertial Planck constants?

The original unconsciously performed identification of the gravitational and inertial Planck constants leads to some confusing conclusions but it seems that the new view about the quantization of Planck constants resolves these problems and allows to see \hbar_{gr} as a special case of \hbar_I .

- (a) \hbar_{gr} is proportional to the product of masses of interacting systems and not a universal constant like \hbar . One can however express the gravitational Bohr conditions as a quantization of circulation $\oint v \cdot dl = n(GM/v_0)\hbar_0$ so that the dependence on the planet mass disappears as required by Equivalence Principle. This suggests that gravitational Bohr rules relate to velocity rather than inertial momentum as is indeed natural. The quantization of circulation is consistent with the basic prediction that space-time surfaces are analogous to Bohr orbits.
- (b) \hbar_{gr} seems to characterize a relationship between planet and central mass and quite generally between two systems with the property that smaller system is topologically condensed at the space-time sheet of the larger system. Thus it would seem that \hbar_{gr} is not a universal constant and cannot correspond to a special value of ordinary Planck constant. Certainly this would be the case if \hbar_I is quantized as λ^k -multiplet of ordinary Planck constant with $\lambda \simeq 2^{11}$.

The recent view about the quantization of Planck constant in terms of coverings of M^4 seems to resolve these problems.

- (a) The integer quantization of Planck constants is consistent with the huge values of gravitational Planck constant within experimental resolution and the killer test for $\hbar = \hbar_{gr}$ emerges if one takes seriously the stronger prediction $\hbar_{gr} = n_{F,a}/n_{F,b}$.
- (b) One can also regard \hbar_{gr} as ordinary Planck constant \hbar_{eff} associated with the space-time sheet along which the masses interact provided each pair (M, m_i) of masses is characterized by its own sheets. These sheets could correspond to flux tube like structures carrying the gravitational flux of dark matter. If these sheets corresponds to n_{F_a} -fold covering of M^4 , one can understand \hbar_{gr} as a particular instance of the \hbar_{eff} .

Quantization as a means of avoiding gravitational collapse

Schrödinger equation provided a solution to the infrared catastrophe of the classical model of atom: the classical prediction was that electron would radiate its energy as brehmstrahlung and would be captured by the nucleus. The gravitational variant of this process would be the capture of the planet by a black hole, and more generally, a collapse of the star to a black hole. Gravitational Schrödinger equation could obviously prevent the catastrophe.

For $1/r$ gravitation potential the Bohr radius is given by $a_{gr} = GM/v_0^2 = r_S/2v_0^2$, where $r_S = 2GM$ is the Schwartzchild radius of the mass creating the gravitational potential: obviously Bohr radius is much larger than the Schwartzchild radius. That the gravitational Bohr radius does not depend on m conforms with Equivalence Principle, and the proportionality $\hbar_{gr} \propto Mm$ can be deduced from it. Gravitational Bohr radius is by a factor $1/2v_0^2$ larger than black hole radius so that black hole can swallow the piece of matter with a considerable rate only if it is in the ground state and also in this state the rate is proportional to the black hole volume to the volume defined by the black hole radius given by $2^3v_0^6 \sim 10^{-20}$.

The $\hbar_{gr} \rightarrow \infty$ limit for $1/r$ gravitational potential means that the exponential factor $\exp(-r/a_0)$ of the wave function becomes constant: on the other hand, also Schwartzchild and Bohr radii become infinite at this limit. The gravitational Compton length associated with mass m does not depend on m and is given by GM/v_0 and the time $T = E_{gr}/\hbar_{gr}$ defined by the gravitational binding energy is twice the time taken to travel a distance defined by the radius of the orbit with velocity v_0 which suggests that signals travelling with a maximal velocity v_0 are involved with the quantum dynamics.

In the case of planetary system the proportionality $\hbar_{gr} \propto mM$ creates problems of principle since the influence of the other planets is not taken account. One might argue that the generalization of the formula should be such that M is determined by the gravitational field experienced by mass m and thus contains also the effect of other planets. The problem is that this field depends on the position of m which would mean that \hbar_{gr} itself would become kind of field quantity.

Does the transition to non-perturbative phase correspond to a change in the value of \hbar ?

Nature is populated by systems for which perturbative quantum theory does not work. Examples are atoms with $Z_1Z_2e^2/4\pi\hbar > 1$ for which the binding energy becomes larger than rest mass, non-perturbative QCD resulting for $Q_{s,1}Q_{s,2}g_s^2/4\pi\hbar > 1$, and gravitational systems satisfying $GM_1M_2/4\pi\hbar > 1$. Quite generally, the condition guaranteeing troubles is of the form $Q_1Q_2g^2/4\pi\hbar > 1$. There is no general mathematical approach for solving the quantum physics of these systems but it is believed that a phase transition to a new phase of some kind occurs.

The gravitational Schrödinger equation forces to ask whether Nature herself takes care of the problem so that this phase transition would involve a change of the value of the Planck constant to guarantee that the perturbative approach works. The values of \hbar would vary in a stepwise manner from $\hbar(\infty)$ to $\hbar(3) = \hbar(\infty)/4$. The non-perturbative phase transition would correspond to transition to the value of

$$\frac{\hbar}{\hbar_0} \rightarrow \left[\frac{Q_1Q_2g^2}{v} \right] \quad (9.4.16)$$

where $[x]$ is the integer nearest to x , inducing

$$\frac{Q_1Q_2g^2}{4\pi\hbar} \rightarrow \frac{v}{4\pi} \quad (9.4.17)$$

The simplest (and of course ad hoc) assumption making sense in TGD Universe is that v is a harmonic or subharmonic of v_0 appearing in the gravitational Schrödinger equation. For instance,

for the Kepler problem the spectrum of binding energies would be universal (independent of the values of charges) and given by $E_n = v^2 m / 2n^2$ with v playing the role of small coupling. Bohr radius would be $g^2 Q_2 / v^2$ for $Q_2 \gg Q_1$.

This provides a new insight to the problems encountered in quantizing gravity. QED started from the model of atom solving the infrared catastrophe. In quantum gravity theories one has started directly from the quantum field theory level and the recent decline of the M-theory shows that we are still practically where we started. If the gravitational Schrödinger equation indeed allows quantum interpretation, one could be more modest and start from the solution of the gravitational IR catastrophe by assuming a dynamical spectrum of \hbar determined by Beraha numbers. The implications would be profound: the whole program of quantum gravity would have been misled as far as the quantization of systems with $GM_1 M_2 / \hbar > 1$ is considered. In practice, these systems are the most interesting ones and the prejudice that their quantization is a mere academic exercise would have been completely wrong.

An alternative formulation for the occurrence of a transition increasing the value of \hbar could rely on the requirement that classical bound states have reasonable quantum counterparts. In the gravitational case one would have $r_n = n^2 \hbar_{gr}^2 / GM_1^2 M$, for $M_1 \ll M$, which is extremely small distance for $\hbar_{gr} = \hbar$ and reasonable values of n . Hence, either n is so large that the system is classical or \hbar_{gr} / \hbar is very large. Equivalence Principle requires the independence of r_n on M_1 , which gives $\hbar = kGM_1 M_2$ giving $r_n = n^2 kGM$. The requirement that the radius is above Schwarzschild radius gives $k \geq 2$. In the case of Dirac equation the solutions cease to exist for $Z \geq 137$ and which suggests that \hbar is large for hypothetical atoms having $Z \geq 137$.

9.4.8 How do the magnetic flux tube structures and quantum gravitational bound states relate?

In the case of stars in galactic halo the appearance of the parameter v_0 characterizing cosmic strings as orbital rotation velocity can be understood classically. That v_0 appears also in the gravitational dynamics of planetary orbits could relate to the dark matter at magnetic flux tubes. The argument explaining the harmonics and sub-harmonics of v_0 in terms of properties of cosmic strings and magnetic flux tubes identifiable as their descendants strengthens this expectation.

The notion of magnetic body

In TGD inspired theory of consciousness the notion of magnetic body plays a key role: magnetic body is the ultimate intentional agent, experiencer, and performer of bio-control and can have astrophysical size: this does not sound so counter-intuitive if one takes seriously the idea that cognition has p-adic space-time sheets as space-time correlates and that rational points are common to real and p-adic number fields. The point is that infinitesimal in p-adic topology corresponds to infinite in real sense so that cognitive and intentional structures would have literally infinite size.

The magnetic flux tubes carrying various supra phases can be interpreted as special instance of dark energy and dark matter. This suggests a correlation between gravitational self-organization and quantum phases at the magnetic flux tubes and that the gravitational Schrödinger equation somehow relates to the ordinary Schrödinger equation satisfied by the macroscopic quantum phases at magnetic flux tubes. Interestingly, the transition to large Planck constant phase should occur when the masses of interacting is above Planck mass since gravitational self-interaction energy is $V \sim GM^2/R$. For the density of water about 10^3 kg/m^3 the volume carrying a Planck mass correspond to a cube with side 2.8×10^{-4} meters. This corresponds to a volume of a large neuron, which suggests that this phase transition might play an important role in neuronal dynamics.

Could gravitational Schrödinger equation relate to a quantum control at magnetic flux tubes?

An infinite self hierarchy is the basic prediction of TGD inspired theory of consciousness ("everything is conscious and consciousness can be only lost"). Topological quantization allows to assign to any material system a field body as the topologically quantized field pattern created by the system [K86, K33]. This field body can have an astrophysical size and would utilize the material body as a sensory receptor and motor instrument.

Magnetic flux tube and flux wall structures are natural candidates for the field bodies. Various empirical inputs have led to the hypothesis that the magnetic flux tube structures define a hierarchy of magnetic bodies, and that even Earth and larger astrophysical systems possess magnetic body which makes them conscious self-organizing living systems. In particular, life at Earth would have developed first as a self-organization of the super-conducting dark matter at magnetic flux tubes [K33].

For instance, EEG frequencies corresponds to wavelengths of order Earth size scale and the strange findings of Libet about time delays of conscious experience [J5, J2] find an elegant explanation in terms of time taken for signals propagate from brain to the magnetic body [K86]. Cyclotron frequencies, various cavity frequencies, and the frequencies associated with various p-adic frequency scales are in a key role in the model of bio-control performed by the magnetic body. The cyclotron frequency scale is given by $f = eB/m$ and rather low as are also cavity frequencies such as Schumann frequencies: the lowest Schumann frequency is in a good approximation given by $f = 1/2\pi R$ for Earth and equals to 7.8 Hz.

1. Quantum time scales as "bio-rhythms" in solar system?

To get some idea about the possible connection of the quantum control possibly performed by the dark matter with gravitational Schrödinger equation, it is useful to look for the values of the periods defined by the gravitational binding energies of test particles in the fields of Sun and Earth and look whether they correspond to some natural time scales. For instance, the period $T = 2GM_S n^2/v_0^3$ defined by the energy of n^{th} planetary orbit depends only on the mass of Sun and defines thus an ideal candidate for a universal "bio-rhythm".

For Sun black hole radius is about 2.9 km. The period defined by the binding energy of lowest state in the gravitational field of Sun is given $T_S = 2GM_S/v_0^3$ and equals to 23.979 hours for $v_0/c = 4.8233 \times 10^{-4}$. Within experimental limits for v_0/c the prediction is consistent with 24 hours! The value of v_0 corresponding to exactly 24 hours would be $v_0 = 144.6578$ km/s (as a matter fact, the rotational period of Earth is 23.9345 hours). As if as the frequency defined by the lowest energy state would define a "biological" clock at Earth! Mars is now a strong candidate for a seat of life and the day in Mars lasts 24hr 37m 23s! $n = 1$ and $n = 2$ are orbitals are not realized in solar system as planets but there is evidence for the $n = 1$ orbital as being realized as a peak in the density of IR-dust [E175]. One can of course consider the possibility that these levels are populated by small dark matter planets with matter at larger space-time sheets. Bet as it may, the result supports the notion of quantum gravitational entrainment in the solar system.

The slower rhythms would become as n^2 sub-harmonics of this time scale. Earth itself corresponds to $n = 5$ state and to a rhythm of .96 hours: perhaps the choice of 1 hour to serve as a fundamental time unit is not merely accidental. The magnetic field with a typical ionic cyclotron frequency around 24 hours would be very weak: for 10 Hz cyclotron frequency in Earth's magnetic field the field strength would about 10^{-11} T. However, $T = 24$ hours corresponds with 6 per cent accuracy to the p-adic time scale $T(k = 280) = 2^{13}T(2, 127)$, where $T(2, 127)$ corresponds to the secondary p-adic time scale of .1 s associated with the Mersenne prime $M_{127} = 2^{127} - 1$ characterizing electron and defining a fundamental bio-rhythm and the duration of memetic codon [K39].

Comorosan effect [K91], [I6, I14] demonstrates rather peculiar looking facts about the interaction of organic molecules with visible laser light at wavelength $\lambda = 546$ nm. As a result of irradiation molecules seem to undergo a transition $S \rightarrow S^*$. S^* state has anomalously long lifetime and stability in solution. $S \rightarrow S^*$ transition has been detected through the interaction of S^* molecules

with different biological macromolecules, like enzymes and cellular receptors. Later Comorosan found that the effect occurs also in non-living matter. The basic time scale is $\tau = 5$ seconds. p-Adic length scale hypothesis does not explain τ , and it does not correspond to any obvious astrophysical time scale and has remained a mystery.

The idea about astro-quantal dark matter as a fundamental bio-controller inspires the guess that τ could correspond to some Bohr radius R for a solar system via the correspondence $\tau = R/c$. As observed by Nottale, $n = 1$ orbit for $v_0 \rightarrow 3v_0$ corresponds in a good approximation to the solar radius and to $\tau = 2.18$ seconds. For $v_0 \rightarrow 2v_0$ $n = 1$ orbit corresponds to $\tau = AU/(4 \times 25) = 4.992$ seconds: here $R = AU$ is the astronomical unit equal to the average distance of Earth from Sun. The deviation from τ_C is only one per cent and of the same order of magnitude as the variation of the radius for the orbit due to orbital eccentricity $(a - b)/a = .0167$ [E46] .

2. Earth-Moon system

For Earth serving as the central mass the Bohr radius is about 18.7 km, much smaller than Earth radius so that Moon would correspond to $n = 147.47$ for v_0 and $n = 1.02$ for the sub-harmonic $v_0/12$ of v_0 . For an aficionado of cosmic jokes or a numerologist the presence of the number of months in this formula might be of some interest. Those knowing that the Mayan calendar had 11 months and that Moon is receding from Earth might rush to check whether a transition from $v/11$ to $v/12$ state has occurred after the Mayan culture ceased to exist: the increase of the orbital radius by about 3 per cent would be required! Returning to a more serious mode, an interesting question is whether light satellites of Earth consisting of dark matter at larger space-time sheets could be present. For instance, in [K33] I have discussed the possibility that the larger space-time sheets of Earth could carry some kind of intelligent life crucial for the bio-control in the Earth's length scale.

The period corresponding to the lowest energy state is from the ratio of the masses of Earth and Sun given by $M_E/M_S = (5.974/1.989) \times 10^{-6}$ given by $T_E = (M_E/M_S) \times T_S = .2595$ s. The corresponding frequency $f_E = 3.8535$ Hz frequency is at the lower end of the theta band in EEG and is by 10 per cent higher than the p-adic frequency $f(251) = 3.5355$ Hz associated with the p-adic prime $p \simeq 2^k$, $k = 251$. The corresponding wavelength is 2.02 times Earth's circumference. Note that the cyclotron frequencies of Nn, Fe, Co, Ni, and Cu are 5.5, 5.0, 5.2, 4.8 Hz in the magnetic field of $.5 \times 10^{-4}$ Tesla, which is the nominal value of the Earth's magnetic field. In [K67] I have proposed that the cyclotron frequencies of Fe and Co could define biological rhythms important for brain functioning. For $v_0/12$ associated with Moon orbit the period would be 7.47 s: I do not know whether this corresponds to some bio-rhythm.

It is better to leave for the reader to decide whether these findings support the idea that the superconducting cold dark matter at the magnetic flux tubes could perform bio-control and whether the gravitational quantum states and ordinary quantum states associated with the magnetic flux tubes couple to each other and are synchronized.

9.4.9 p-Adic length scale hypothesis and $v_0 \rightarrow v_0/5$ transition at inner-outer border for planetary system

$v_0 \rightarrow v_0/5$ transition would allow to interpret the orbits of outer planets as $n \geq 1$ orbits. The obvious question is whether inner to outer zone as $v_0 \rightarrow v_0/5$ transition could be interpreted in terms of the p-adic length scale hierarchy.

- (a) The most important p-adic length scale are given by primary p-adic length scales $L(k) = 2^{(k-151)/2} \times 10$ nm and secondary p-adic length scales $L(2, k) = 2^{k-151} \times 10$ nm, k prime.
- (b) The p-adic scale $L(2, 139) = 114$ Mkm is slightly above the orbital radius 109.4 Mkm of Venus. The p-adic length scale $L(2, 137) \simeq 28.5$ Mkm is roughly one half of Mercury's orbital radius 57.9 Mkm. Thus strong form of p-adic length scale hypothesis could explain why the transition $v_0 \rightarrow v_0/5$ occurs in the region between Venus and Earth ($n = 5$ orbit for v_0 layer and $n = 1$ orbit for $v_0/5$ layer).

- (c) Interestingly, the *primary* p-adic length scales $L(137)$ and $L(139)$ correspond to fundamental atomic length scales which suggests that solar system be seen as a fractally scaled up "secondary" version of atomic system.
- (d) Planetary radii have been fitted also using Titius-Bode law predicting $r(n) = r_0 + r_1 \times 2^n$. Hence one can ask whether planets are in one-one correspondence with primary and secondary p-adic length scales $L(k)$. For the orbital radii 58, 110, 150, 228 Mkm of Mercury, Venus, Earth, and Mars indeed correspond approximately to $k = 276, 278, 279, 281$: note the special position of Earth with respect to its predecessor. For Jupiter, Saturn, Uranus, Neptune, and Pluto the radii are 52,95,191,301,395 Mkm and would correspond to p-adic length scales $L(280 + 2n)$, $n = 0, \dots, 3$. Obviously the transition $v_0 \rightarrow v_0/5$ could occur in order to make the planet-p-adic length scale one-one correspondence possible.
- (e) It is interesting to look whether the p-adic length scale hierarchy applies also to the solar structure. In a good approximation solar radius .696 Mkm corresponds to $L(270)$, the lower radius .496 Mkm of the convective zone corresponds to $L(269)$, and the lower radius .174 Mkm of the radiative zone (radius of the solar core) corresponds to $L(266)$. This encourages the hypothesis that solar core has an onion like sub-structure corresponding to various p-adic length scales. In particular, $L(2, 127)$ ($L(127)$ corresponds to electron) would correspond to 28 Mm. The core is believed to contain a structure with radius of about 10 km: this would correspond to $L(231)$. This picture would suggest universality of star structure in the sense that stars would differ basically by the number of the onion like shells having standard sizes.

Quite generally, in TGD Universe the formation of join along boundaries bonds is the space-time correlate for the formation of bound states. This encourages to think that (Z^0) magnetic flux tubes are involved with the formation of gravitational bound states and that for $v_0 \rightarrow v_0/k$ corresponds either to a splitting of a flux tube resembling a disk with a whole to k pieces, or to the scaling down $B \rightarrow B/k^2$ so that the magnetic energy for the flux tube thickened and stretched by the same factor k^2 would not change.

9.4.10 About the interpretation of the parameter v_0

The formula for the gravitational Planck constant contains the parameter $v_0/c = 2^{-11}$. This velocity defines the rotation velocities of distant stars around galaxies. The presence of a parameter with dimensions of velocity should carry some important information about the geometry of dark matter space-time sheets.

Velocity like parameters appear also in other contexts. There is evidence for the Tiff's quantization of cosmic redshifts in multiples of $v_0/c = 2.68 \times 10^{-5}/3$: also other units of quantization have been proposed but they are multiples of v_0 [E187].

The strange behavior of graphene includes high conductivity with conduction electrons behaving like massless particles with light velocity replaced with $v_0/c = 1/300$. The TGD inspired model [K15] explains the high conductivity as being due to the Planck constant $\hbar(M^4) = 6\hbar_0$ increasing the delocalization length scale of electron pairs associated with hexagonal rings of mono-atomic graphene layer by a factor 6 and thus making possible overlap of electron orbitals. This explains also the anomalous conductivity of DNA containing 5- and 6-cycles [K15].

Is dark matter warped?

The reduced light velocity could be due to the warping of the space-time sheet associated with dark electrons. TGD predicts besides gravitational red-shift a non-gravitational red-shift due to the warping of space-time sheets possible because space-time is 4-surface rather than abstract 4-manifold. A simple example of everyday life is the warping of a paper sheet: it bends but is not stretched, which means that the induced metric remains flat although one of its component scales (distance becomes longer along direction of bending). For instance, empty Minkowski space represented canonically as a surface of $M^4 \times CP_2$ with constant CP_2 coordinates can become periodically warped in time direction because of the bending in CP_2 direction. As a

consequence, the distance in time direction shortens and effective light-velocity decreases when determined from the comparison of the time taken for signal to propagate from A to B along warped space-time sheet with propagation time along a non-warped space-time sheet.

The simplest warped imbedding defined by the map $M^4 \rightarrow S^1$, S^1 a geodesic circle of CP_2 . Let the angle coordinate of S^1 depend linearly on time: $\Phi = \omega t$. g_{tt} component of metric becomes $1 - R^2\omega^2$ so that the light velocity is reduced to $v_0/c = \sqrt{1 - R^2\omega^2}$. No gravitational field is present.

The fact that M^4 Planck constant $n_a \hbar_0$ defines the scaling factor n_a^2 of CP_2 metric could explain why dark matter resides around strongly warped imbeddings of M^4 . The quantization of the scaling factor of CP_2 by $R^2 \rightarrow n_a^2 R^2$ implies that the initial small warping in the time direction given by $g_{tt} = 1 - \epsilon$, $\epsilon = R^2\omega^2$, will be amplified to $g_{tt} = 1 - n_a^2\epsilon$ if ω is not affected in the transition to dark matter phase. $n_a = 6$ in the case of graphene would give $1 - x \simeq 1 - 1/36$ so that only a one per cent reduction of light velocity is enough to explain the strong reduction of light velocity for dark matter.

Is c/v_0 quantized in terms of ruler and compass rationals?

The known cases suggests that c/v_0 is always a rational number expressible as a ratio of integers associated with n-polygons constructible using only ruler and compass.

- (a) $c/v_0 = 300$ would explain graphene. The nearest rational satisfying the ruler and compass constraint would be $q = 5 \times 2^{10}/17 \simeq 301.18$.
- (b) If dark matter space-time sheets are warped with $c_0/v = 2^{11}$ one can understand Nottale's quantization for the radii of the inner planets. For dark matter space-time sheets associated with outer planets one would have $c/v_0 = 5 \times 2^{11}$.
- (c) If Tift's red-shifts relate to the warping of dark matter space-time sheets, warping would correspond to $v_0/c = 2.68 \times 10^{-5}/3$. $c/v_0 = 2^5 \times 17 \times 257/5$ holds true with an error smaller than .1 per cent.

Tift's quantization and cosmic quantum coherence

An explanation for Tift's quantization in terms of Jones inclusions could be that the subgroup G of Lorentz group defining the inclusion consists of boosts defined by multiples $\eta = n\eta_0$ of the hyperbolic angle $\eta_0 \simeq v_0/c$. This would give $v/c = \sinh(n\eta_0) \simeq nv_0/c$. Thus the dark matter systems around which visible matter is condensed would be exact copies of each other in cosmic length scales since G would be an exact symmetry. The property of being an exact copy applies of course only in single level in the dark matter hierarchy. This would mean a delocalization of elementary particles in cosmological length scales made possible by the huge values of Planck constant. A precise cosmic analog for the delocalization of electron pairs in benzene ring would be in question.

Why then η_0 should be quantized as ruler and compass rationals? In the case of Planck constants the quantum phases $q = \exp(im\pi/n_F)$ are number theoretically simple for n_F a ruler and compass integer. If the boost $\exp(\eta)$ is represented as a unitary phase $\exp(im\eta)$ at the level of discretely delocalized dark matter wave functions, the quantization $\eta_0 = n/n_F$ would give rise to number theoretically simple phases. Note that this quantization is more general than $\eta_0 = n_{F,1}/n_{F,2}$.

9.4.11 The challenge of six planets

NASA has published the first list of exoplanets found by Kepler satellite. In particular, the NASA team led by Jack Lissauer reports a discovery of a system of six closely packed planets [E4] around a Sun-like star christened as Kepler-11_a located in the direction of constellation Cygnus at distance of about 2000 light years. The basic data about the six planets Kepler-11_i, $i = b, c, d, e, f, g$ and star Kepler-11_a can be found in Wikipedia. Below I will refer to the star

by Kepler-11 and planets with label $i = b, c, d, e, f, g$. Lissauer regards it as quite possible that there are further planets at larger distances. The fact that the radius of planet g is only .462AU together with what we know about solar system suggests that this could be the case. This leaves door for Earth like planet.

The conclusions from the basic data

Let us list the basic data.

- (a) The radius and mass and surface temperature of Kepler-11 are very near to those of Sun.
- (b) The orbital radii using AU as unit are given by

$$(.091, .106, .159, .194, .250, .462) .$$

The orbital radii can be deduced quite accurately from the orbital periods by using Kepler's law stating that the squares of periods are proportional to cubes of orbital radii. The orbital periods of the five inner planets are between 10 and 47 days whereas g has a longer period of 118.37774 days (note the amazing accuracy). The orbital radii of e and f are .194 AU and .250 AU so that the temperature is expected to be much higher than at Earth so that life as we know it is not expected to be there. The average temperature of the radiation from Kepler-11 scaling as $1/r^2$ would be 4 times the temperature at Earth. The fact that gas forms a considerable fraction of the planet's mass could however mean that this does not give a good estimate for the temperature of the planet.

- (c) The mass estimates using Earth mass as unit are

$$(4.3, 13.5, 6.1, 8.4, 2.3, \leq 300) .$$

There are considerable uncertainties involved here, of order factor of 1/2.

- (d) The estimates for the radii of the planets using the radius of Earth as unit are

$$(1.97, 3.15, 3.43, 4.52, 2.61, 3.66) .$$

The uncertainties are about 20 per cent.

- (e) From the estimates for the radii and mass estimates one can conclude that the estimates for the densities of the planets are considerably lower than those for Earth. Density of (e, f) is about $(1/8, 1/4)$ of that for Earth. The surface gravitation for e and f is roughly 1/2 of that at Earth. For g it is same as for Earth if g has mass roughly $m(g) \simeq 15$. The upper bound $m(g) \leq 300$ implies that surface gravity is weaker than 20g for g .

The basic conclusions from the Wikipedia data are following. One cannot exclude the possibility that the planetary system could contain Earth like planets. Furthermore, the distribution of the orbital radii of the planets differs dramatically from that in solar system.

How to understand the tight packing of the inner planets?

The striking aspect of the planetary system is how tightly packed it is. The ratio for the radii of g and b is about 5. This is areal puzzle for model builders. TGD suggests three phenomenological approaches.

- (a) Titius-Bode law

$$r(n) = r_0 + 2^n r_1$$

is supported by p-adic length scale hypothesis. Stars would have onion-like structure consisting of spherical shells with inner and outer radii of the shell differing by factor two. The formation of planetary system involves condensation of matter to planets at these spherical shells. The preferred extremals of Kähler action describing stationary axially symmetric

system corresponds to spherical shells containing most of the matter. A rough model for star would be in terms of this kind of spherical shells defined an onion-like structure defining a hierarchy of space-time sheets topologically condensed on each other. The value of the parameter r_0 could be vanishing in the initial situation but subsequent gravitational dynamics could make it positive reducing the ratio $r(n)/r(n - 1)$ from its value 2.

- (b) Bohr orbitology suggested by the proposal that gravitonic space-time sheets assigned with a given planet-star pair correspond to a gigantic value of gravitational Planck constant given by

$$\hbar_{gr} = \frac{GMm}{v_0} ,$$

where v_0 has dimensions of velocity and actually equal to the orbital velocity for the lowest Bohr orbit. For inner planets in solar system one has $v_0/c \simeq 2^{-11}$.

The physical picture is visible matter concentrates around dark matter and in this matter makes it astrosopic quantum behavior visible. The model is extremely predictive since the spectrum of orbital radii would depend only on the mass of the star and planetary systems would be much like atoms with obvious implications for the probability of Earth like systems supporting life. This model is consistent with the Titius-Bode model only if the Bohr orbitology is a late-comer in the planetary evolution.

- (c) The third model is based on same general assumptions as the second one but only assumes that dark matter in astrophysical length scales associated with anyonic 2-surfaces (with light-like orbits in induced metric in accordance with holography) characterized by the value of the gravitational Planck constant. In this case the hydrogen atom inspired Bohr orbitology is just the first guess and cannot be taken too seriously. What would be important would be genuinely quantal dynamics for the formation of planetary system.

Can one interpret the radii in this framework in any reasonable manner?

- (a) Titius-Bode predicts

$$\frac{r(n) - r(n - 1)}{r(n - 1) - r(n - 2)} = 2 ,$$

which works excellently for c, f , and g . For b, d and e the law fails. This suggests that the four inner planets a, b, c, d , whose radii span single 2-adic octave in good approximation (!) correspond to single system which has split from single plane or will fuse to single planet distant future.

- (b) Hydrogenic Bohr orbitology works only if g corresponds to $n = 2$ orbit. $n = 1$ orbit would have radius .116AU. From the proportionality $r \propto \hbar_{gr}^2 \propto 1/v_0^2$, one obtains that the value one must have

$$R \equiv \frac{v_0^2(Kepler)}{v_0^2(Sun)} \simeq 3.04 .$$

This would result as in reasonable approximation for $v_0(Kepler)/v_0(Sun) = 7/4$ (the values of Planck constant are predicted to integer multiples of the standard value) giving $R = 7/4^2 \simeq 3.06$.

Note that the planets would correspond to those missing in Earth-Sun system for which one has $n = 3, 4, 5$ for the inner planets Mercury, Venus, Earth.

One could argue that Bohr orbits result as the planets fuse to two planets at these radii. This picture is not consistent with Titius-Bode law which predicts three planets in the final situation unless $n = 2$ planet remains unrealized. By looking the graphical representation of the orbital radii of the planet system one has tendency to say that b, c, d, e , and f form a single subsystem and could eventually collapse to single planet. The ratio of gravitational forces between g and f is larger than that between f and e for $m(g) \geq 6m_E$ so that one can ask whether f could be eventually caught be g in this case. Also the fact that one has $r(g)/r(f) \leq 2$ mildly suggests this.

9.5 Further evidence for dark matter

The notion of many-sheeted space-time has been continually receiving qualitative support from various anomalies. In the following some candidates for anomalies are summarized briefly.

9.5.1 Some anomalies

New dark matter anomaly

One of the most radical parts of quantum TGD is the view about dark matter as a hierarchy of phases of matter with varying values of Planck constant realized in terms of generalization of the 8-D imbedding space to a book like structure. The latest blow against existing models of dark matter is the discovery of a new strange aspect of dark matter discussed in New Scientist popular article "Galaxy study hints at cracks in dark matter theories" [E88]. The original article in Nature is titled as *Universality of galactic surface densities within one dark halo scale-length* [E140]. I glue here a short piece of the New Scientist article.

A galaxy is supposed to sit at the heart of a giant cloud of dark matter and interact with it through gravity alone. The dark matter originally provided enough attraction for the galaxy to form and now keeps it rotating. But observations are not bearing out this simple picture.

Since dark matter does not radiate light, astronomers infer its distribution by looking at how a galaxy's gas and stars are moving. Previous studies have suggested that dark matter must be uniformly distributed within a galaxy's central region a confounding result since the dark matter's gravity should make it progressively denser towards a galaxy's centre.

Now, the tale has taken a deeper turn into the unknown, thanks to an analysis of the normal matter at the centres of 28 galaxies of all shapes and sizes. The study shows that there is always five times more dark matter than normal matter where the dark matter density has dropped to one-quarter of its central value.

In TGD framework both dark energy and dark matter are assumed to correspond to dark matter but with widely different values of Planck constant. The point is that very large value of Planck constant for dark matter implies that its density is in an excellent approximation constant as is also the density of dark energy. Planck constant is indeed predicted to be gigantic at the space-time sheets mediating gravitational interaction.

The appearance of number five as a ratio of mass densities sounds mysterious. Why the average mass in a large volume should be proportional to \hbar if \hbar is not too large? Intriguingly, number five appears also in the Bohr model for planetary orbits. The value of the gravitational Planck constant GMm/v_0 assignable to the space-time sheets mediating gravitational interaction between planet and star is gigantic: $v_0/c \simeq 2^{-11}$ holds true inner planets. For outer planets v_0/c is by a factor $1/5$ smaller so that corresponding gravitational Planck constant is 5 times larger. Do these two fives represent a mere coincidence?

- (a) In accordance with TGD inspired cosmology suppose that visible matter and also the matter which is conventionally called dark matter has emerged from the decay and widening of cosmic strings to magnetic flux tubes. Assume that the string tension can be written as $k \times \hbar/G$, k a numerical constant.
- (b) Suppose that the values of \hbar come as pairs $\hbar = n \times \hbar_0$ and $5 \times \hbar$. Suppose also that for a given value of \hbar the length of the cosmic string (if present at all) inside a sphere or radius R is given by $L = x(n)R$, $x(n)$ a numerical constant which can depend on the pair but is same for the members of the pair $(\hbar, 5 \times \hbar)$. This assumption is supported by the velocity curves of distant stars around galaxies.
- (c) These assumptions imply that the masses of matter for a pair $(\hbar, 5 \times \hbar)$ corresponding to a given value of \hbar in a volume of size R are given by $M(\hbar) = k \times x(\hbar) \times \hbar \times R/G$ and $M(5 \times \hbar) = 5 \times M(\hbar)$. This would explain the finding if visible matter corresponds to \hbar_0 , and $x(n)$ is much smaller for pairs $(n > 1, 5 \times n)$ than for the pair $(1, 5)$.

- (d) One can explain the pairing in TGD framework. Let us accept the earlier hypothesis that the preferred values of \hbar correspond to number theoretically maximally simple quantum phases $q = \exp(i2\pi/n)$ emerging first in the number theoretical evolution having a nice formulation in terms of algebraic extensions of rationals and p-adics and the gradual migration of matter to the pages of the book like structure labeled by large values of Planck constant. These number theoretically simple quantum phases correspond to n-polygons drawable by ruler and compass construction. This predicts that the preferred values of \hbar correspond to a power of 2 multiplied by a product of Fermat primes $F_k = 2^{2^k} + 1$. The list of known Fermat primes is short and given by $F_k, k = 0, 1, 2, 3, 4$ giving the Fermat primes 3, 5, 17, 257, $2^{16} + 1$. This hypothesis indeed predicts that Planck constants \hbar and $5 \times \hbar$ appear as pairs.
- (e) Why the pair $(1, F_1 = 5)$ should be then favored? Could the reason be that $n = 5$ corresponds also to the smallest integer making possible universal topological quantum computer: the quantum phase $q = \exp(i2\pi/5)$ characterizes the braiding coding for the topological quantum computer program. Or is the reason simply that this pair corresponds to the number theoretically simplest pair which must have emerged first in the number theoretic evolution?
- (f) This picture supports the view that ordinary matter and most what is usually called dark matter are characterized by Planck constants \hbar_0 and $5 \times \hbar_0$, and that the space-time sheets mediating gravitational interaction correspond to dark energy because the density of matter at these space-time sheets must be constant in an excellent approximation since Compton lengths are so gigantic.
- (g) Using the fact that 4 per cent of matter is visible this means that $n = 5$ corresponds to 20 per cent of dark matter in standard sense. Pairs $(n > 1, 5n)$ should contribute the remaining 2 per cent of dark matter. The fractal scaling law $x(n) \propto 1/n^r$ allowing pairs defined by all Fermat integers not divisible by 5 would give for the mass fraction of conventional dark matter with $n > 1$ the expression

$$p = 6 \times \sum_k 2^{-kr} [2^{-r} + \sum n_F^{-r}] \times \frac{4}{100} = \frac{24}{100} \times \frac{1}{1 - 2^{-r}} \times [2^{-r} + \sum n_F^{-r}] .$$

Here n_F denotes a Fermat integer which is product of some Fermat primes in the set $\{3, 17, 257, 2^{16} + 1\}$. The contribution from $n = 2^k, k > 0$, gives the term not included to the sum over n_F . $r = 4.945$ predicts $p = 2.0035$ and that the mass density of dark matter would scale down as $1/\hbar^{r-1} = 1/\hbar^{3.945}$.

- (h) The prediction brings in mind the scaling $1/a^{r-1}$ for the cosmological mass density. a^{-4} scaling for radiation dominated cosmology is very near to this scaling. $r = 5$ (sic!) would predict $p = 1.9164$ which is of course consistent with the data. This inspires the working hypothesis that the density of the dark matter as function of \hbar scales just like the density of matter as function of cosmic time during particular epoch. In matter dominated cosmology with mass density behaving as $1/a^3$ one would have $r = 4$ and $p = 4.4502$ and in asymptotic cosmology with mass density behaving as $1/a^2$ (according to TGD) one would have $r = 3$ and $p = 11.68$.
- (i) Living systems would represent a deviation from the "fractal thermodynamics" for \hbar since for the typical values of \hbar associated with the magnetic bodies in living systems (say $\hbar = 2^{44}\hbar_0$ for EEG to guarantee the the energies of EEG photons are above the thermal threshold) the density of the dark matter would be extremely small. Bio-rhythms are assumed to come as powers of 2 in the simplest model for the bio-system: the above considerations raise the question whether these rhythms could be accompanied by 5-multiples and perhaps also by Fermat integer multiples. For instance, the fundamental 10 Hz alpha frequency could be accompanied by 2 Hz frequency and the 40 Hz thalamocortical resonance frequency by 8 Hz frequency.

This model is an oversimplification obtained by assuming only singular coverings of CD . In principle both coverings and factor spaces of both CD and CP_2 are possible. If singular covering of both CP_2 and M^4 is involved and if one has $n = 5$ for both then the ratio of mass densities

is $1/25$ or about 4 per cent. This equals to the experimental ratio of about 4 per cent of the density of visible matter to the density of ordinary, dark matter and dark energy. I interpret this as an accident: dark energy can correspond to dark matter only if the Planck constant is very large and a natural place for dark energy is at the space-time sheets mediating gravitational interaction.

Some further observations about number five are in order. The angle $2\pi/5$ relates closely to Golden Mean appearing almost everywhere in biology. $n = 5$ makes itself manifest also in the geometry of DNA (the twist per single nucleotide is $\pi/5$ and aromatic 5-cycles appear in DNA nucleotides). Could it be that electron pairs associated with aromatic rings correspond to $\hbar = 5 \times \hbar_0$ as I have proposed? Note that DNA as topological quantum computer hypothesis plays a key role in TGD inspired quantum biology.

The planet that should not exist

There is an interesting news story about an exoplanet that should not exist [E61]. The exoplanet is so called hot-Jupiter and so close to its Sun that it should have been torn by pieces by tidal forces and spiralled long ago to the Sun. For some reason this has not happened. The abstract of the article gives a more quantitative view about the discovery.

The 'hot Jupiters' that abound in lists of known extrasolar planets are thought to have formed far from their host stars, but migrate inwards through interactions with the proto-planetary disk from which they were born, or by an alternative mechanism such as planetplanet scattering. The hot Jupiters closest to their parent stars, at orbital distances of only approximately 0.02 astronomical units, have strong tidal interactions and systems such as OGLE-TR-56 have been suggested as tests of tidal dissipation theory. Here we report the discovery of planet WASP-18b with an orbital period of 0.94 days and a mass of ten Jupiter masses (10 M_{Jup}), resulting in a tidal interaction an order of magnitude stronger than that of planet OGLE-TR-56b. Under the assumption that the tidal-dissipation parameter Q of the host star is of the order of 106, as measured for Solar System bodies and binary stars and as often applied to extrasolar planets, WASP-18b will be spiralling inwards on a timescale less than a thousandth that of the lifetime of its host star. Therefore either WASP-18 is in a rare, exceptionally short-lived state, or the tidal dissipation in this system (and possibly other hot-Jupiter systems) must be much weaker than in the Solar System.

The finding brings in mind more than hundred year old problem: why the electron orbiting atom did not spiral into atomic nucleus? The solution of the puzzle was provided by the discovery of quantum theory. The postulate was that electron moves on Bohr orbits and can make only transitions between the Bohr orbits emitting light in these transitions. There is minimum value for the radius of Bohr orbit. Later wave mechanism emerged from Bohr model.

TGD view about dark matter suggests an analogous solution to the astrophysical variant of this puzzle. Planets correspond to Bohr orbits but for a gigantic value of Planck constant whose value is dictated by Equivalence Principle to high degree. This Planck constant could be assigned to the space-time sheet mediating gravitational interaction or even with matter. This means astrosopic quantum coherence and the interpretation is that astrosopic quantum coherence is associated with dark matter around which visible matter condenses and makes in this manner visible the quantum character of dark matter. That the planet does not spiral to the star means smallness of dissipation and this is guaranteed by the large value of \hbar . The naive estimate is that dissipation rate is proportional to the inverse of \hbar and anomalously small dissipation in astrophysical scales is basic prediction of quantum astrophysics. Also Mars-Phobos forms a similar mysterious system and the explanation would be the same.

A more refined view about the situation is in terms of light-like 3-surfaces, which are basic dynamical objects in quantum TGD. At elementary particle level their size is about CP_2 size (about 10^4 Planck lengths). Also macroscopic and even astrosopic sizes are possible and this would be the case for dark matter for which Planck constant and thus also quantum scales are scaled up. Note that light-like 3-surfaces are boundaries between regions of space-time with Euclidian and Minkowskian signature of metric. The recent TGD inspired vision about Universe is as a kind of Indra's net formed by light-like 3-surfaces appearing in all length scales and having

extremely complex topology. Quantum Hall Effect is described in terms of macroscopic light-like 3-surfaces in [K63] and it is suggested that this kind of anyonic phases are realized also in astrophysical scales for dark matter. In this framework it is not necessary to Bohr rules are replaced by quantization rules for the light-like 3-surfaces satisfied by the preferred extremals of Kähler action and expressing quantum criticality.

Amusingly, the counterpart of Planck length scaling as $(\hbar G)^{1/2}$ is apart from numerical constant equal to $v_0^{-1/2} GM$ ($2GM$ is Schwarzschild radius) if one assumes that $\hbar = GM^2/v_0$ is associated with an astrophysical system with mass M : $v_0/c \simeq 2^{-11}$ holds true for the gravitational space-time sheets mediating gravitational interaction between inner planets and Sun in the solar system. Planck length would be few orders of magnitude larger than Schwarzschild radius so that Planck scale physics would be scaled up to astrophysical length scale. Black-hole entropy which is proportional to $1/\hbar$ is of order unity and would be extremely small for the ideally dark black-hole if this picture is correct. This looks strange. If one accepts the proposal that the hierarchy of Planck constants is implied by the basic TGD so that only covering spaces of $CD \times CP_2$ are possible [K61, K30], the natural interpretation of the scaled down blackhole entropy is as the entropy for single sheet of the covering. The total entropy would be given by the standard formula since the number of sheets is given by $\hbar/\hbar_0 = n_a n_b$. This would suggest that entropy serves as a control variable in the sense that when it exceeds the threshold value, the partonic 2-surfaces at the ends of CD split to a surfaces in the covering. Second law suggests the increase of the Planck constant not only for blackholes but quite generally. On the other hand, large values of Planck constant mean failure of second law below the time scale defined by the Planck constant so that the increase of entropy and evolution would accompany each other.

First dark matter galaxy found

The propose model for dark matter suggests an existence of dark matter planets and even dark matter galaxies. Therefore the news about finding of the first dark galaxy in New Scientist [E16] came as a pleasant surprise. The galaxy is located at a distance of 10^7 light years. It contains 1 per cent hydrogen gas and and 99 per cent dark matter and is identified by 21 cm hydrogen line: hence the name VIRGOH21. The amount of dark matter counts as 10^8 average stars.

Anomalous chemical compositions at the surface of Sun as evidence for dark matter

Physics in Action, February 2005 contained the popular article "Chemical Controversy at the Solar Surface" by J. Bahcall in Physics in Action [E70]. The article describes the problems created by results reported in the article "The Solar Chemical Decomposition" by M. Asplund, N. Grevesse, J. Sauval [E52]. The abundances of C, N, O, Ne, Ar at the solar surface are about 30-40 per cent less than predicted by the standard solar model. If these abundances are feeded into the standard solar model as input the predictions change in the range $.45R - .73R$ of distances from solar interior (R is solar radius). In particular, sound velocity is predicted incorrectly. Interestingly, these abundances are consistent with the abundances in the gaseous medium in the neighborhood of our galaxy.

In TGD framework a possible solution of paradox comes from already old model of solar corona and solar magnetic field. Part of matter resides as dark matter at magnetic and Z^0 magnetic flux tubes of Sun (dark energy) and enters to the solar corona along these. That also gaseous medium in the neighborhood of our galaxy contains same abundances suggests that the formation of Sun has proceeded by a transformation of part of dark matter to a visible matter by leakage to space-time sheets visible to us. This is indeed what TGD inspired model for the formation of solar system based on quantal dark matter suggests.

Does Sun have a solid surface?

$n = 1$ Bohr orbit corresponds in a reasonable approximation to $L(276)/9 \simeq L(270)$ and thus to solar radius. This raises the question whether solar surface could contain spherical shell

representing a topological condensate of dense matter around dark matter, kind of spherical preform of planet below the photosphere.

Recently new satellites have begun to provide information about what lurks beneath the photosphere. The pictures produced by Lockheed Martin's Trace Satellite and YOHKOH, TRACE and SOHO satellite programs are publicly available in the web. SERTS program for the spectral analysis suggest a new picture challenging the simple gas sphere picture [E168]. The visual inspection of the pictures combined with spectral analysis has led Michael Moshina to suggest that Sun has a solid, conductive spherical surface layer consisting of calcium ferrite. The article of [E168] [E168] provides impressive pictures, which in my humble non-specialist opinion support this view. Of course, I have not worked personally with the analysis of these pictures so that I do not have the competence to decide how compelling the conclusions of Moshina are. In any case, I think that his web article [E168] deserves a summary.

Before SERTS people were familiar with hydrogen, helium, and calcium emissions from Sun. The careful analysis of SERTS spectrum however suggest the presence of a layer or layers containing ferrite and other heavy metals. Besides ferrite SERTS found silicon, magnesium, manganese, chromium, aluminum, and neon in solar emissions. Also elevated levels of sulphur and nickel were observed during more active cycles of Sun. In the gas sphere model these elements are expected to be present only in minor amounts. As many as 57 different types of emissions from 10 different kinds of elements had to be considered to construct a picture about the surface of the Sun.

Moshina has visually analyzed the pictures constructed from the surface of Sun using light at wave lengths corresponding to three lines of ferrite ions (171, 195, 284 Angstroms). On basis of his analysis he concludes that the spectrum originates from rigid and fixed surface structures, which can survive for days. A further analysis shows that these rigid structures rotate uniformly.

The existence of a rigid structure idealizable as spherical shell in the first approximation could by previous observation be interpreted as a spherical shell corresponding to $n = 1$ Bohr orbit of a planet not yet formed. This structure would already contain the germs of iron core and of crust containing Silicon, Ca and other elements.

There is also another similar piece of evidence [E97]. A new planet has been discovered orbiting around a star in a triple-star system in the constellation Cygnus. The planet is a so-called hot Jupiter but it orbits the parent star at distance of .05 AU, which much less than allowed by current theories of planetary formation. Indeed, the so called migration theory predicts that the gravitational pull of the two stars should have stripped away the proto-planetary disk from the parent star. If an underlying dark matter structure serves as a condensation template for the visible matter, the planetary orbit is stabilized by Bohr quantization.

There is however a problem: ordinary iron and also ordinary iron topologically condensed at dark space-time sheets, becomes liquid at temperature 1811 K at atmospheric pressure. Using for the photospheric pressure p_{ph} , the ideal gas approximation $p_{ph} = n_{ph}T_{ph}$, the values of photospheric temperature $T_{ph} \sim 5800$ K and density $\rho_{ph} \sim 10^{-2}\rho_{atm}$, and idealizing photosphere as a plasma of hydrogen ions and atmosphere as a gas of O_2 molecules, one obtains $n_{ph} \sim .32n_{atm}$ giving $p_{ph} \sim 6.4p_{atm}$. This suggests that calcium ferrite cannot be solid at temperatures of order 5800 K prevailing in the photosphere (the material with highest known melting temperature is graphite with melting temperature of 3984 K at atmospheric pressure). Thus it would seem that dark calcium ferrite at the surface of the Sun cannot be just ordinary calcium ferrite at dark space-time sheets.

The following explanation for the solid surface is perhaps the simplest one found hitherto. Since the atomic energy spectrum is unaffected it seems that $n_a = n_b = 1$ holds true and the radii of Bohr orbitals are scaled up by the factor $n_a^2/n_b = n_a$. If the density of dark matter is roughly the same as that of ordinary matter, the larger size of atoms suggests that melting temperature must be higher than for ordinary matter. Ordinary photons would result via dark-visible phase transition from dark photons emitted by these atoms. Quite generally, spectral lines of molecules in environments in which they should not be thermally stable, would serve as a signature of dark matter with $n_a/n_b = 1$.

How to create dark matter in laboratory...

The creation of dark matter at laboratory is of course the crucial test. The hints for what to do come already from the findings of Tesla, which did not fit completely with Maxwell's electrodynamics (, which, using M-theory inspired jargon, had become "the only known classical theory of electromagnetism",) and were thus forgotten.

To transform visible matter to dark matter in laboratory one might try to generate conditions in which visible matter leaks to larger space-time sheets. What one could try is to generate pulsed current of electrons. For instance, current could flow to a circuit component acting as a charge reservoir. When the circuit is opened, and current cannot leave the charge reservoir, a situation analogous to a traffic jam occurs and some electrons might leak to larger space-time sheets via join along boundaries bonds generated in the process. Di-electric breakdown along larger space-time sheet would be in question. Recoil effects and zero point kinetic energy liberated as ionizing radiation would serve as a signature of the process. The production of dark matter might occur also in the usual di-electric breakdown and lead to the appearance of electrons in much larger volume after it partially re-enters original space-time sheets. The change of zero point kinetic energy would be liberated as radiation and would cause formation of plasma. Tesla detected dramatic effects of this kind in experiments utilizing sharp pulses.

..or has it already been done?

In their article "Investigation of high voltage discharges in low pressure gases through large ceramic super-conducting electrodes", Modanese and [H8] [H7] report a fascinating discovery suggesting that some new form of radiation is generated in the di-electric breakdown of a capacitor at low temperature and having super-conductor as a second electrode. This radiation induces oscillatory motion of test penduli but, and this is very strange, its intensity is not reduced with distance.

The TGD based explanation [K28] would be in terms of either "topological light rays" or what I call in honor of Tesla "scalar wave pulses" (much like a capacitor moving with velocity of light predicted by TGD but not allowed by Maxwell's ED). This radiation would induce the formation of join along boundaries bonds between atomic and larger space-time sheets and part of electrons from penduli would leak to larger space-time sheets and their motion would result as a recoil effect. The radiation would have only the role of control signal and this would explain why its intensity is not weakened.

From the point of view of single sheeted space-time an over-unity device would be in question since the zero point kinetic energy would be transformed to kinetic energy. The transformation of visible matter to dark matter is in TGD Universe the basic mechanism of metabolism predicting universality of metabolic energy currencies and living matter in TGD Universe has developed a refined machinery to recycle the dropped charges back to the atomic space-time sheets to be used again. Combined with time mirror mechanism this makes, not a perpetuum mobile, but an extremely flexible mechanism of metabolism.

9.5.2 Anti-matter and dark matter

The usual view about matter anti-matter asymmetry is that during early cosmology matter-antimatter asymmetry characterized by the relative density difference of order $r = 10^{-9}$ was somehow generated and that the observed matter corresponds to what remained in the annihilation of quarks and leptons to bosons. A possible mechanism inducing the CP asymmetry is based on the CP breaking phase of CKM matrix.

The TGD based view about energy [K85, K73] forces the conclusion that all conserved quantum numbers including the conserved inertial energy have vanishing densities in cosmological length scales. Therefore fermion numbers associated with matter and antimatter must compensate each other. Therefore the standard option as such is definitely excluded in TGD framework although CKM matrix might well relate to the generation of matter antimatter asymmetry as discussed in [K35] .

An early TGD based scenario explains matter antimatter asymmetry by assuming that antimatter is in topological vapor phase. This requires that matter and antimatter have slightly different topological evaporation rates with the relative difference of rates characterized by the parameter r . A more general scenario assumes that matter and antimatter reside at different space-time sheets.

The reader can easily guess the next step. The strict non-observability of antimatter finds an elegant explanation if matter and anti-matter are dark relative to each other. For instance, the masses of particles of antimatter could be scaled down so that antimatter could be practically everywhere without appreciably affecting the density of gravitational mass.

The matter antimatter asymmetry should be generated during cosmic evolution already before the formation of nucleons during the primordial synthesis of matter and antimatter. The number theoretical model for topological condensation based on formation of $\#$ contacts between space-time sheets of opposite time orientations (and thus opposite signs for energies) leads to a more detailed view about what might happen.

$\#$ contacts can be modeled as CP_2 type extremals which simultaneously topologically condense to the two space-time sheets with Minkowskian signature of induced metric. The resulting two causal horizons are carriers of elementary particle quantum numbers and are identifiable as partons. The $\#$ contacts with vanishing net quantum numbers could be generated spontaneously and the splitting of $\#$ contact would create positive particle and negative energy particle at the two space-time sheets involved. The requirement that the net quantum numbers of Universe vanish is consistent with this kind of pairing of positive and negative energy space-time sheets.

Number theoretical vision [K35, K79] leads to a vision in which elementary particles correspond to infinite primes, perhaps also integers, or even rationals which in turn can be mapped to finite rationals. To infinite primes, integers, and rationals it is possible to associate a finite rational $q = m/n$ by a homomorphism. q defines an effective q -adic topology of space-time sheet consistent with p -adic topologies defined by the primes dividing m and n ($1/p$ -adic topology is homeomorphic to p -adic topology). m and n are exchanged by super-symmetry and the primes dividing m (n) correspond to space-time sheets with positive (negative) time orientation. The largest prime dividing m (n) determines the mass scale of the space-time sheet in p -adic thermodynamics. Two space-time sheets characterized by rationals having common prime factors can be connected by a $\#_B$ contact and can interact by exchange of particles characterized by divisors of m or n . Thus fundamental topological selection rules would be coded by the hierarchy of infinite primes.

A possible interpretation is that particle (in extremely general sense that even entire universe can be regarded as a particle) corresponds to a pair of positive and negative energy space-time sheets labeled by m and n characterizing the p -adic topologies consistent with m - and n -adicities. This looks natural since Universe has necessary vanishing net quantum numbers. Unless one allows the non-uniqueness due to $m/n = mr/nr$, positive and negative energy space-time sheets can be connected only by $\#$ contacts so that positive and negative energy space-time sheets cannot interact via the formation of $\#_B$ contacts and would be therefore dark relative to each other. Negative energy antiparticles would also have different p -adic mass scales. If the rate for the creation of $\#$ contacts and their CP conjugates are slightly different, say due to the presence of electric components of gauge fields, matter antimatter asymmetry could be generated primordially.

9.6 Explanations of some astrophysical and cosmological anomalies

In the sequel some astrophysical and cosmological anomalies such as the apparent shrinking of solar system observed by Masreliez, Pioneer anomaly, Flyby anomaly and new anomalies in cosmic microwave background.

9.6.1 Apparent shrinking of solar system

The findings of Masreliez

There are two means of determining the positions of planets in the solar system [E155, E170]. The first method is based on optical measurements and determines the position of planets with respect to the distant stars. Already thirty years ago [E170] came the first indications that the planetary positions determined in this manner drift from their predicted values as if planets were in accelerated motion. The second method determines the relative positions of planets using radar ranging: this method does not reveal any such acceleration.

C. J. Masreliez [E161] has proposed that this acceleration could be due to a gradual scaling of the planetary system so that the sizes L of the planetary orbits are reduced by an over-all scale factor $L \rightarrow L/\lambda$, which implies the acceleration $\omega \rightarrow \lambda^{3/2}\omega$ in accordance with the Kepler's law $\omega \propto 1/L^{3/2}$. This scaling would exactly compensate the cosmological scaling $L \rightarrow (R(t)/R_0) \times L$ of the solar system size L , where $R(t)$ the curvature parameter of Robertson-Walker cosmology having the line element

$$ds^2 = dt^2 - R^2(t) \left(\frac{dr^2}{1+r^2} + r^2 d\Omega^2 \right) . \quad (9.6.1)$$

According to Masreliez, the model explains also some other anomalies in the solar system, such as angular momentum discrepancy between the lunar motion and the spin-down of the Earth [E161]. The model also changes the rate for the estimated drift of the Moon away from the Earth so that the Moon could have very well formed together with Earth some five billion years ago.

Bohr quantization of planetary orbits predicts that orbital radii are constant in Minkowski coordinates. Hence solar system would not participate cosmic expansion and the radii of planets shrink in Robertson-Walker coordinates. This model is definitely the simplest one.

The basic coordinate systems

Consider now the previous argument in more detail. The first task is to identify the coordinates appearing in the equations of motion of the planetary system. Denote the standard spherical Minkowski coordinates by (m^0, r_M, θ, ϕ) . The line element reads as

$$ds^2 = d(m^0)^2 - dr_M^2 - r_M^2 d\Omega^2 . \quad (9.6.2)$$

Light cone coordinates are related to these coordinates by the relationship

$$a = \sqrt{m_0^2 - r_M^2} , \quad r = r_M/a . \quad (9.6.3)$$

Here a is the light cone proper time along radii from the tip of the light cone $a = \text{constant}$ surfaces are hyperboloids. The line element is given

$$ds^2 = da^2 - a^2 \left(\frac{dr^2}{1+r^2} + r^2 d\Omega^2 \right) \quad (9.6.4)$$

and is nothing but the empty space Minkowski metric.

The Robertson-Walker metric for the space-time sheet reads as

$$ds^2 = g_{aa}da^2 - a^2\left(\frac{dr^2}{1+r^2} + r^2d\Omega^2\right) . \quad (9.6.5)$$

The space-time sheet possessing this metric as induced metric is obtained as a map $M_+^4 \rightarrow CP_2$ having the form $s^k = s^k(a)$, where s^k denote CP_2 coordinates satisfying the constraint

$$g_{aa} = 1 - s_{kl}\partial_a s^k \partial_a s^l , \quad (9.6.6)$$

where s_{kl} denotes the metric tensor of CP_2 .

One can introduce cosmic time as proper time coordinate t , or Hubble time as it is called, by the equation

$$\frac{dt}{da} = \sqrt{g_{aa}} . \quad (9.6.7)$$

For the matter-dominated cosmology one as

$$\frac{t}{t_0} = \left(\frac{a}{a_0}\right)^{3/2} . \quad (9.6.8)$$

$t \simeq 1.5 \times 10^{10}$ ly is the value which explains the planetary acceleration in the model of Masreliez.

The basic question concerns the connection between cosmic coordinates and the radial and time coordinates (r_{PN}, t_{PN}) used in Post-Newtonian approximation. The correspondence $(t = t_{PN}, r = r_{PN})$ is the natural first approximation.

The cosmic time dilation would slow down the time scale of the planetary dynamics and cosmic expansion would lead to adiabatic expansion of the size of the solar system. This would predict the scaling $L(a)/L(a_0) = a/a_0$ for the sizes of the planetary orbits as measured using the r_M coordinate of M_+^4 metric whereas angular velocities of planets would remain constant $\omega(a)/\omega(a_0) = \text{constant}$. The solar system would gradually decay.

The condition that solar system does not participate cosmic expansion

If the solar system does not participate in cosmic expansion, one has $L(a)/L(a_0) = \text{constant}$ and the scalings

$$\frac{\omega(a)}{\omega(a_0)} = \left(\frac{a}{a_0}\right)^{3/2} = \frac{t}{t_0} , \quad \frac{v(a)}{v(a_0)} = \left(\frac{a}{a_0}\right)^{1/2} = \left(\frac{t}{t_0}\right)^{1/2} \quad (9.6.9)$$

for the angular velocity ω and and tangential velocity v along the orbit. The equation for the angular acceleration is $d\omega/dt = \omega/t$. This result differs by a factor of 3 from the equation $d\omega/dt = 3\omega/t$ of [E160, E161]. On basis of work of Masreliez one can conclude this kind of scaling indeed explains the observed drift quite satisfactorily for $t \simeq 5$ billion years (instead of $t = 15$ billion years of [E161]). Thus the effect would allow to see the effects of the cosmic expansion in human time scale and would make possible to determine the value of cosmic time t from the planetary dynamics.

Compensation of cosmic expansion from Bohr quantization of planetary orbits?

The Bohr quantization for planetary orbits predicts that the orbital radii measured in terms of M^4 radial coordinate r_M are constant. This means that planetary system does not participate cosmic expansion so that the orbital radii expressed in terms of the coordinate $r = r_M/a$ shrinking. Therefore the stars accelerate with respect to the Robertson-Walker coordinates (t, r, Ω) defined by the distant stars since in this case the radii correspond naturally to the coordinate $r = r_M/a$ and time variable corresponds to the $dt/da = \sqrt{g_{aa}}$ giving $dr/dt = -Hr_M$ so that cosmic expansion is exactly compensated. This model for the anomaly brings in no additional assumptions besides Bohr quantization and is favored by Occam's razor.

There is an objection against the model based on the effective shift of the space-time sheet of solar system towards geometric future in each quantum jump so that cosmic expansion is compensated and time effectively ceases to flow. The simplest model for the arrow of psychological time found hitherto [K29] assumes however that this kind of effective shifting indeed occurs but in the reverse direction so that the radii would seem to increase rather than decrease. If the M^4 size remains constant, apparent reduction of radii is predicted.

Quite recently (August 2008) there appeared a new experimental claim related to the problem discussed. There is evidence that the value of astronomical unit AU (distance between Sun and Earth) is increasing with a rate about $dAU/dt = 7$ cm/year [E156]. Expressed in terms of the Minkowski proper time $a = R(t)$ the rate is about

$$\frac{d\log(AU)}{da} \simeq 4.6 \times 10^{-13} .$$

If the solar system indeed participates cosmic expansion, one has $\frac{d\log(AU)}{da} = 1/a$ and the prediction for the recent Minkowski age of the Universe is $a_{now} = 2.2 \times 10^{12}$ years. If one assumes $a_R \simeq 3.3 \times 10^7$ y for the time when matter began to dominate, one obtains

$$t - t_R = \int_{a_R}^a \sqrt{g_{aa}} da , \quad g_{aa} = \left(\frac{a}{a_R}\right)^{1/2} .$$

This would give $t_{now} \simeq 4 \times 10^{10}$ years which is about 8 times longer than the age $t_{now} = 0.5 \times 10^{10}$ ly explaining the claims of Mazreliez. The latter would give $a_{now} \simeq 4 \times 10^{11}$ y, which is ten times shorter than the value required by the interpretation of the increase of AU as being due to the cosmic expansion.

In any case, if the increase of AU is real, it challenges the hypothesis that the quantum size of the solar system remains exactly constant and increases only in the phase transitions increasing the value of the gravitational Planck constant. One could consider the possibility that some new effect which is by a factor 1/10 smaller than that caused by the cosmic expansion is present. A possible explanation consistent with the constant M^4 size of the solar system is based on the idea that the space-time sheet along which the radar radiation propagates, develops gradually ripples. Also the emergence of new space-time sheets condensed to the space-time sheet along which radar photons propagate could be involved. This increasing metric noise would mean that the distance traveled by the radar photons along the space-time sheet in question gradually increases so that the time taken by the radar signal to travel from Earth to Sun and back increases.

9.6.2 In what sense speed of light could be changing in solar system?

There have been continual claims that the speed of light in solar system is decreasing. The latest paper about this is by Sanejouand [E178] and to my opinion must be taken seriously. The situation is summarized by an excerpt from the abstract of the article:

The empirical evidences in favor of the hypothesis that the speed of light decreases by a few centimeters per second each year are examined. Lunar laser ranging data are found to be consistent with this hypothesis, which also provides a straightforward explanation for the so-called Pioneer anomaly, that is, a time-dependent blue-shift observed when analyzing radio tracking data from

distant spacecrafts, as well as an alternative explanation for both the apparent time-dilation of remote events and the apparent acceleration of the Universe.

Before one can speak about change of c seriously, one must specify precisely what the measurement of speed of light means. In GRT framework speed of light is by definition a constant in local Minkowski coordinates. It seems very difficult to make sense about varying speed of light since c is purely locally defined notion.

- (a) In TGD framework [K85] space-time as abstract manifold is replaced by 4-D surface in $H = M^4 \times CP_2$ (forgetting complications due to the hierarchy of Planck constants) and this brings in something new: the sub-manifold geometry allowing to look space-time surfaces "from outside", from H-perspective. The shape of the space-time surface appears as new degrees of freedom. This leads to the explanation of standard model symmetries, elementary particle quantum numbers and geometrization of classical fields, the dream of Einstein. Furthermore, CP_2 length scale provides a universal unit of length and p-adic length scale hypothesis brings in an entire hierarchy of fixed meter sticks defined by p-adic length scales. The presence of imbedding space $M^4 \times CP_2$ brings in light-like geodesics of M^4 for which c is maximal and by suitable choice of units could be taken $c = 1$. These geodesics serve as universal comparison standards when one measures speed of light: something which GRT does not provide.
- (b) In TGD framework the operational definition for the speed of light at given space-time sheet is in terms of the time taken for light to propagate from point A to B along space-time surface. The time to propagate along space-time sheet is in general longer than along light-like geodesic of M^4 . Even if the space-time surface is only warped (no curvature), this time is longer than along a light-like geodesic of $M^4(\times CP_2)$ and the speed of light measured in this manner is reduced from its maximal value. Secondly, in TGD framework the propagation can occur via several routes because of many-sheeted structure and each sheet gives its own value for c .

What TGD then predicts?

- (a) TGD inspired cosmology predicts that c measured in this manner increases in cosmological scales, just the opposite for what Louise Riofrio [E59] suggests. The reason is that strong gravitation makes space-surface strongly curved and it takes more time to travel from A to B during early cosmology. This means that TGD based explanation has different cosmological consequences as that of Riofrio. For instance, Hubble constant depends on space-time sheet in TGD framework.
- (b) The paradox however disappears that *local systems* like solar system do not normally participate in cosmic expansion as predicted by TGD. This is known also experimentally. In TGD Universe local systems could however participate cosmic expansion in average sense via phase transitions increasing Planck constant of the appropriate space-time sheet and thus increasing its size. The transition would occur in relatively short time scales: this provides new support for expanding Earth hypothesis needed to explain the fact that continents fit nicely together to form single super continent covering entire Earth if the radius of Earth is by a factor 1/2 smaller than its recent radius [K61].
- (c) If one measures the speed of light in local system and uses its cosmic value taken constant by definition (fixing particular coordinate time) then one indeed finds that the speed of light is decreasing locally and the decrease should be expressible in terms of Hubble constant.
- (d) TGD based explanation of Pioneer anomaly is also based on completely analogous reasoning.

9.6.3 Pioneer anomaly

The data gathered during one quarter of century [C17] seem to suggest that spacecrafts do not obey the laws of Newtonian gravitation. What has been observed is anomalous constant acceleration of order $(8 \pm 3) \times 10^{-11} g$ ($g = 9.81 m/s^2$ is gravitational acceleration at the surface

of Earth) for the Pioneer/10/11, Galileo and Ulysses ganomaly. The acceleration is directed towards Sun and could have an explanation in terms of $1/r^2$ long range force if the density of charge carriers of the force has $1/r$ dependence on distance from the Sun. From the data in [C17], the anomalous acceleration of the spacecraft is of order

$$\delta a \sim .8 \times 10^{-10} g ,$$

where $g \simeq 9.81 \text{ m/s}^2$ is gravitational acceleration at the surface of Earth. Using the values of Jupiter distance $R_J \simeq .8 \times 10^{12}$ meters, radius of Earth $R_E \simeq 6 \times 10^6$ meters and the value Sun to Earth mass ratio $M_S/M_E \simeq .3 * 10^6$, one can relate the gravitational acceleration

$$a(R) = \frac{GM_S}{R^2} = \frac{M_S}{M_E} \frac{R_E^2}{R^2}$$

of the spacecraft at distance $R = R_J$ from the Sun to g , getting roughly $a \simeq 1.6 \times 10^{-5}g$. One has also

$$\frac{\delta a}{a} \simeq 1.3 \times 10^{-4} .$$

The value of the anomalous acceleration has been found to be $a_F = (8.744 \pm 1.33) \times 10^{-8} \text{ cm/s}^2$ and given by Hubble constant: $a_F = cH$. $H = 82 \text{ km/s/Mpc}$ gives $a_F = 8 \times 10^{-8} \text{ cm/s}^2$. It is very difficult to believe that this could be an accident. There are also diurnal and annual variations in the acceleration anomaly [E115]. These variations should be due to the physics of Earth-Sun system. I do not know whether they can be understood in terms of a temporal variation of the Doppler shift due to the spinning and orbital motion of Earth with respect to Sun.

The model of Pioneer anomaly based on Doppler shift

It came as a surprise that also Pioneer anomaly has a simple explanation in terms of Doppler shift assuming that solar system is not participating in cosmic expansion. This predicts that the measured wavelength behaves as

$$\lambda_{meas} = \frac{c(t)}{f} \simeq (1 + \frac{a_c}{c_0}t)/f . \tag{9.6.10}$$

Here $c(t)$ is the local light velocity using as unit the light velocity in cosmological length scales. Since one has $a_c < 0$ in the lowest order, the measured wavelength behaves as if the source were accelerating towards observer with a constant acceleration. The value of a_c is consistent with that obtained from the argument explaining apparent reduction of light velocity in solar system.

Original model for the anomaly

The original explanation for the acceleration anomaly was based on the presence of dark matter increasing the effective solar mass at larger distances. Although this explanation did not survive Occam's razor, it deserves to be mentioned.

Since acceleration anomaly is constant, a dark matter density behaving like $\rho_d = (3/4\pi)(H/Gr)$, where H is Hubble constant giving $M(r) \propto r^2$, is required. For instance, at the radius R_J of Jupiter the dark mass would be about $(\delta a/a)M(\text{Sun}) \simeq 1.3 \times 10^{-4}M(\text{Sun})$ and would become comparable to M_{Sun} at about $100R_J = 520 \text{ AU}$. Note that the standard theory for the formation of planetary system assumes a solar nebula of radius of order 100AU having 2-3 solar masses. For Pluto at distance of 38 AU the dark mass would be about one per cent of solar mass.

This model would suggest that planetary systems are formed around dark matter system with a universal mass density. For this option dark matter could perhaps be seen as taking care of the contraction compensating for the cosmic expansion by using a suitable dark matter distribution.

In [E115] the possibility that the acceleration anomaly for Pioneer 10 (11) emerged only after the encounter with Jupiter (Saturn) is raised. The model explaining Hubble constant as being due to a radial contraction compensating cosmic expansion would predict that the anomalous acceleration should be observed everywhere, not only outside Saturn. The model in which universal dark matter density produces the same effect would allow the required dark matter density $\rho_d = (3/4\pi)(H/Gr)$ be present only as a primordial density able to compensate the cosmic expansion. The formation of dark matter structures could have modified this primordial density and visible matter would have condensed around these structures so that only the region outside Jupiter would contain this density.

9.6.4 Fly-by anomaly

The so called flyby anomaly [E115] might relate to the Pioneer anomaly. Fly-by mechanism used to accelerate space-crafts is a genuine three body effect involving Sun, planet, and the space-craft. Planets are rotating around sun in an anticlockwise manner and when the space-craft arrives from the right hand side, it is attracted by a planet and is deflected in an anticlockwise manner and planet gains energy as measured with respect to solar center of mass system. The energy originates from the rotational motion of the planet. If the space-craft arrives from the left, it loses energy. What happens is analyzed in [E115] using an approximately conserved quantity known as Jacobi's integral $J = \mathcal{E} - \omega \bar{e}_z \cdot \bar{r} \times \bar{v}$. Here \mathcal{E} is total energy per mass for the space-craft, ω is the angular velocity of the planet, \bar{e}_z is a unit vector normal to the planet's rotational plane, and various quantities are with respect to solar cm system.

This as such is not anomalous and flyby effect is used to accelerate space-crafts. For instance, Pioneer 11 was accelerated in the gravitational field of Jupiter to a more energetic elliptic orbit directed to Saturn and the encounter with Saturn led to a hyperbolic orbit leading out from solar system.

Consider now the anomaly. The energy of the space-craft in planet-space-craft cm system is predicted to be conserved in the encounter. Intuitively this seems obvious since the time and length scales of the collision are so short as compared to those associated with the interaction with Sun that the gravitational field of Sun does not vary appreciably in the collision region. Surprisingly, it turned out that this conservation law does not hold true in Earth flybys. Furthermore, irrespective of whether the total energy with respect to solar cm system increases or decreases, the energy in planet-spacecraft cm system increases during flyby in the cases considered.

Five Earth flybys have been studied: Galileo-I, NEAR, Rosetta, Cassina, and Messenger and the article of Anderson and collaborators [E115] gives a nice quantitative summary of the findings and of the basic theoretical notions. Among other things the tables of the article give the deviation $\delta\mathcal{E}_{g,S}$ of the energy gain per mass in the solar cm system from the predicted gain. The anomalous energy gain in rest Earth cm system is $\Delta\mathcal{E}_E \simeq \bar{v} \cdot \Delta\bar{v}$ and allows to deduce the change in velocity. The general order of magnitude is $\Delta v/v \simeq 10^{-6}$ for Galileo-I, NEAR and Rosetta but consistent with zero for Cassini and Messenger. For instance, for Galileo I one has $v_{\infty,S} = 8.949$ km/s and $\Delta v_{\infty,S} = 3.92 \pm .08$ mm/s in solar cm system.

Many explanations for the effect can be imagined but dark matter looks at first the most obvious candidate in TGD framework. The model for the Bohr quantization of planetary orbits assumes that planets are concentrations of the visible matter around dark matter structures. These structures could be tubular structures around the orbit or a nearly spherical shell containing the orbit. The contribution of the dark matter to the gravitational potential increases the effective solar mass $M_{eff,S}$. This of course cannot explain the acceleration anomaly which has constant value. One can also consider dark matter rings associated with planets and perhaps even Moon's orbit is an obvious candidate now. It turns out that the tube associated with Earth's orbit and deformed by Earth's presence to equatorial plane of Earth explains qualitatively the known facts.

Roughly half year after writing this, a rather convincing and very simple model explaining the effect as a relativistic transverse Doppler effect appeared [E162] (see the comment at the

end of this section). Therefore the dark matter ring - if present - can give only an additional contribution to the transverse Doppler effect. Therefore it seems that all anomalous effects are related to Doppler shifts and thus basically kinematical: the only new element is the fact that solar system does not participate in cosmic expansion.

Dark matter at a spherical cell containing Earth's orbit?

For instance, if the space-craft traverses shell structure, its kinetic energy per mass in Earth cm system changes by a constant amount not depending on the mass of the space-craft:

$$\frac{\Delta E}{m} \simeq v_{\infty,E} \Delta v = \Delta V_{gr} = \frac{G \Delta M_{eff,S}}{R} . \quad (9.6.11)$$

Here R is the outer radius of the shell and $v_{\infty,E}$ is the magnitude of asymptotic velocity in Earth cm system. This very simple prediction should be testable. If the space-craft arrives from the direction of Sun the energy increases. If the space-craft returns back to the sunny side, the net anomalous energy gain vanishes. This has been observed in the case of Pioneer 11 encounter with Jupiter [E115] .

The mechanism would make it possible to deduce the total dark mass of, say, spherical shell of dark matter. One has

$$\begin{aligned} \frac{\Delta M}{M_S} &\simeq \frac{\Delta v}{v_{\infty,E}} \frac{2K}{V} , \\ K &= \frac{v_{\infty,E}^2}{2} , \quad V = \frac{GM_S}{R} . \end{aligned} \quad (9.6.12)$$

For the case considered $\Delta M/M_S \geq 2 \times 10^{-6}$ is obtained. Note that the amount of dark mass within sphere of 1 AU implied by the explanation of Pioneer anomaly would be about $6.2 \times 10^{-6} M_S$ from Pioneer anomaly whereas the mass of Earth is $M_E \simeq 5 \times 10^{-6} M_S$. Since the orders of magnitude are same one might consider the possibility that the primordial dark matter has concentrated in spherical shells in the case of inner planets as indeed suggested by the model for quantization of radii of planetary orbits. Of course, the total mass associated with $1/r$ density quite too small to explain entire mass of the solar system.

In the solar cm system the energy gain is not constant. Denote by $\bar{v}_{i,E}$ and $\bar{v}_{f,E}$ the initial and final velocities of the space-craft in Earth cm. Let $\Delta \bar{v}$ be the anomalous change of velocity in the encounter and denote by θ the angle between the asymptotic final velocity $\bar{v}_{f,S}$ of planet in solar cm. One obtains for the corrected $\mathcal{E}_{g,S}$ the expression

$$\mathcal{E}_{g,S} = \frac{1}{2} [(\bar{v}_{f,E} + \bar{v}_P + \Delta \bar{v})^2 - (\bar{v}_{i,E} + \bar{v}_P)^2] . \quad (9.6.13)$$

This gives for the change $\delta \mathcal{E}_{g,S}$

$$\begin{aligned} \delta \mathcal{E}_{g,S} &\simeq (\bar{v}_{f,E} + \bar{v}_P) \cdot \Delta \bar{v} \simeq v_{f,S} \Delta v \times \cos(\theta_S) \\ &= v_{\infty,S} \Delta v \times \cos(\theta_S) . \end{aligned} \quad (9.6.14)$$

Here $v_{\infty,S}$ is the asymptotic velocity in solar cm system and in excellent approximation predicted by the theory.

Using spherical shell as a model for dark matter one can write this as

$$\delta\mathcal{E}_{g,S} = \frac{v_{\infty,S}}{v_{\infty,E}} \frac{G\Delta M}{R} \cos(\theta_S) . \quad (9.6.15)$$

The proportionality of $\delta\mathcal{E}_{g,S}$ to $\cos(\theta_S)$ should explain the variation of the anomalous energy gain.

For a spherical shell $\Delta\bar{v}$ is in the first approximation orthogonal to v_P since it is produced by a radial acceleration so that one has in good approximation

$$\begin{aligned} \delta\mathcal{E}_{g,S} &\simeq \bar{v}_{f,S} \cdot \Delta\bar{v} \simeq \bar{v}_{f,E} \cdot \Delta\bar{v} \simeq v_{f,S} \Delta v \times \cos(\theta_S) \\ &= v_{\infty,E} \Delta v \times \cos(\theta_E) . \end{aligned} \quad (9.6.16)$$

For Cassini and Messenger $\cos(\theta_S)$ should be rather near to zero so that $v_{\infty,E}$ and $v_{\infty,S}$ should be nearly orthogonal to the radial vector from Sun in these cases. This provides a clear cut qualitative test for the spherical shell model.

Dark matter at the orbit of Earth?

An alternative model is based on dark matter on the orbit of Earth. One can estimate the change of the kinetic energy in the following manner.

- (a) Assume that the the orbit is not modified at all in the lowest order approximation and estimate the kinetic energy gained as the work done by the force caused by the dark matter on the space-craft.

$$\begin{aligned} \frac{\Delta E}{m} &= -G \frac{d\rho_{dark}}{dl} \int_{\gamma_E} dl_E \int_{\gamma_S} d\bar{r}_S \cdot \frac{\bar{r}_{SE}}{r_{SE}^3} , \\ \bar{r}_{SE} &\equiv \bar{r}_S - \bar{r}_E . \end{aligned} \quad (9.6.17)$$

Here γ_S denotes the portion of the orbit of space-craft during which the effect is noticeable and γ_E denotes the orbit of Earth.

This expression can be simplified by performing the integration with respect to r_S so that one obtains the difference of gravitational potential created by the dark matter tube at the initial and final points of the portion of γ_S :

$$\begin{aligned} \frac{\Delta E}{m} &= V(\bar{r}_{S,f}) - V(\bar{r}_{S,i}) , \\ V(\bar{r}_S) &= -G \frac{d\rho_{dark}}{dl} \times \int_{\gamma_E} dl_E \frac{1}{r_{SE}} . \end{aligned} \quad (9.6.18)$$

- (b) Use the standard approximation (briefly described in [E115]) in which the orbit of the spacecraft consists of three parts joined continuously together: the initial Kepler orbit around Sun, the piece of orbit which can be approximate with a hyperbolic orbit around Earth, and the final Kepler orbit around Sun. The piece of the hyperbolic orbit can be chosen to belong inside the so called sphere of influence, whose radius r is given in terms of the distance R of planet from Sun by the Roche limit $r/R = (3m/M_{Sun})^{2/5}$. γ_S could be in the first approximation taken to correspond to this portion of the orbit of spacecraft.
- (c) The explicit expression for the hyperbolic orbit can be obtained by using the conservation of energy and angular momentum and reads as

$$u = \frac{r_s}{r} = \frac{2GM}{r} = \frac{u_0^2}{2v_0^2} \left[1 + \sqrt{1 + 4u_0^2 \frac{v_\infty^2 v_0^2}{\sin^2(\phi)}} \right] ,$$

$$u_0 \equiv \frac{r_s}{a} , \quad |v \times r| \equiv vr \times \sin(\phi) . \quad (9.6.19)$$

The unit $c = 1$ is used to simplify the formulas. r_s denotes Schwarzschild radius and v_∞ the asymptotic velocity. v_0 and a are the velocity and distance at closest approach and the conserved angular momentum is given by $L/m = v_0 a$. In the situation considered value of r_s is around 1 cm, the value of a around 10^7 m and the value of v_∞ of order 10 km/s so that the approximation

$$u \simeq u_0 \frac{v_\infty}{v_0} \sin(\phi) \quad (9.6.20)$$

is good even at the distance of closest approach. Recall that the parameters characterizing the orbit are the distance a of the closest approach, impact parameter b , and the angle 2θ characterizing the angle between the two straight lines forming the asymptotes of the hyperbolic orbit in the orbital plane P_E .

Consider first some conclusions that one can make from this model.

- (a) Simple geometric considerations demonstrate that the acceleration in the region between Earth's orbit and the part of orbit of spacecraft for which the distance from Sun is larger than that of Earth is towards Sun. Hence the distance of the spacecraft from Earth tends to decrease and the kinetic energy increases. In fact, one could also choose the portion of γ_S to be this portion of the spacecraft's orbit.
- (b) ΔE depends on the relative orientation of the normal n_S of the the orbital plane P_E of spacecraft with respect to normal n_O the orbital plane P_O of Earth. The orientation can be characterized by two angles. The first angle could be the direction angle Θ of the position vector of the nearest point of spacecraft's orbit with respect to cm system. Second angle, call it Φ , could characterize the rotation of the orbital plane of space-craft from the standard orientation in which orbital plane and space-craft's plane are orthogonal. Besides this ΔE depends on the dynamical parameters of the hyperbolic orbit of space-craft given by the conserved energy $E_{tot} = E_\infty$ and angular momentum or equivalently by the asymptotic velocity v_∞ and impact parameter b .
- (c) Since the potential associated with the closed loop defined by Earth's orbit is expected to resemble locally that of straight string one expects that the potential varies slowly as a function of \bar{r}_S and that ΔE depends weakly on the parameters of the orbit.

The most recent report [E114] provides additional information about the situation.

- (a) ΔE is reported to be proportional to the total orbital energy E_∞/m of the space-craft. Naively one would expect $\sqrt{E_\infty/m}$ behavior coming from the proportionality ΔE to $1/r$. Actually a slower logarithmic behavior is expected since a potential of a linear structure is in question.
- (b) ΔE depends on the initial and final angles θ_i and θ_f between the velocity \bar{v} of the space-craft with respect to the normal \bar{n}_E of the equatorial plane P_E or Earth and the authors are able to give an empirical formula for the energy increment. The angle between P_E and P_O is 23.4 degrees. One might hope that the formula could be written also in terms of the angle between v and the normal n_O of the orbital plane. For $\theta_i \simeq \theta_f$ the effect is known to be very small. A particular example corresponds to a situation in which one has $\theta_i = 32$ degrees and $\theta_f = 31$ degrees. Obviously the $P_O \simeq P_E$ approximation cannot hold true. Needless to say, also the model based on spherical shell of dark matter fails.

Is the tube containing the dark matter deformed locally into the equatorial plane?

The previous model works qualitatively if the interaction of Earth and flux tube around Earth's orbit containing the dark matter modifies the shape of the tube locally so that the portion of the tube contributing to the anomaly lies in a good approximation in P_E rather than P_O . In this case the minimum value of the distance r_{ES} between γ_E and γ_S is maximal for the symmetric situation with $\theta_i = \theta_f$ and the effect is minimal. In an asymmetric situation the minimum value of r_{ES} decreases and the size of the effect increases. Hence the model works at least qualitatively of the motion of Earth induces a moving deformation of the dark matter tube to P_E . One can actually write ΔE in a physically rather transparent form showing that it is consistent with the basic empirical findings.

- (a) By using linear superposition one can write the potential as sum of a potential associated with a tube associated with Earth's orbit plus the potential associated with the deformed part minus the potential associated with corresponding non-deformed portion of Earth's orbit:

$$\begin{aligned}
 \frac{\Delta E}{m} &= V(\bar{r}_{S,f}) - V(\bar{r}_{S,i}) , \\
 V(\bar{r}_S) &= -G \frac{d\rho_{dark}}{dl} Z(\bar{r}_S) , \\
 Z(\bar{r}_S) &= X(\gamma_{orb}; \bar{r}_S) + X(\gamma_d; \bar{r}_S) - X(\gamma_{nd}; \bar{r}_S) , \\
 X(\gamma_i; \bar{r}_S) &= \int_{\gamma_i} dl \frac{1}{r_{Si}} .
 \end{aligned} \tag{9.6.21}$$

Here the subscripts "orb", "d" and "nd" refer to the entire orbit of Earth, to its deformed part, and corresponding non-deformed part. The entire orbit is analogous to a potential of straight string and is expected to give a slowly varying term which is however non-vanishing in the asymmetric situation. The difference of deformed and non-deformed parts gives at large distances dipole type potential behaving like $1/r^2$ and thus being proportional to v_∞^2 by the above expression for the $u = r_s/r$. The fact that ΔE is proportional to v_∞^2 suggests that dipole approximation is good.

- (b) One can therefore parameterize ΔE as

$$\begin{aligned}
 \frac{\Delta E}{m} &= V(\bar{r}_{S,f}) - V(\bar{r}_{S,i}) , \\
 V(\bar{r}_S) &= -G \frac{d\rho_{dark}}{dl} Z , \\
 Z(\bar{r}_S) &= X(\gamma_{orb}; \bar{r}_S) + \frac{d \cos(\Theta)}{r_S^2} .
 \end{aligned} \tag{9.6.22}$$

where Θ is the angle between \bar{r} and the dipole \bar{d} , which now has dimension of length. The direction of the dipole is in the first approximation in the equatorial plane and directed orthogonal to the Earth's orbit.

Consider now the properties of ΔE .

- (a) In a situation symmetric with respect to the equator E_d vanishes but E_{nd} is non-vanishing which gives as a result potential difference associated with entire Earth's orbit minus the part of orbit contributing to the effect so that the result is by the definition of the approximation very small.
- (b) As already noticed, dipole field like behavior that the large contribution to the potential is proportional to the conserved total energy $v_\infty^2/2$ at the limit of large kinetic energy.

- (c) From the fact that potential difference is in question it follows that the expression for the energy gain is the difference of parameters characterizing the initial and final situations. This conforms qualitatively with the observation that this kind of difference indeed appears in the empirical fit. $1/r^2$ -factor is also proportional to $\sin^2(\phi)$ which by the symmetry of the situation is expected to be same for initial and final situation. Furthermore, ΔE is proportional to the difference of the parameter $\cos(\Theta_f) - \cos(\Theta_i)$ and this should correspond to the reported behavior: it indeed does as I learned after having received the article in email (the prices of PRL on line articles are too dirty for me!). Note that the result vanishes for the symmetric situation in accordance with the empirical findings.

To sum up, it seems that the qualitative properties of ΔE are indeed consistent with the empirical findings. The detailed fit of the formula of [E114] should allow to fix the shape of the deformed part of the orbit.

What induces the deformation?

Authors suggest that the Earth's rotation is somehow involved with the effect. The first thing to notice is that the gravimagnetic field of Earth, call it B_E , predicted by General Relativity is quite too weak to explain the effect as a gravimagnetic force on spacecraft and fails also to explain the fact that energy increases always. Gravitto-Lorentz force does not do any work so that the total energy is conserved and $\Delta E = -\Delta V = -\nabla V \cdot \Delta \bar{r}$ holds true, where $\Delta \bar{r}$ is the deflection caused by the gravimagnetic field on the orbit during flyby. Since $\Delta \bar{r}$ is linear in v , ΔE changes sign as the velocity of space-craft changes sign so that this option fails in several manners.

Gravimagnetic force of Earth could be however involved but in a different manner. The gravimagnetic force between Earth and flux tube containing the dark matter could explain this deformation as a kind of frame drag effect: dark matter would tend to follow the spinning of Earth.

- (a) If the dark matter inside the tube is at rest in the rest frame of Sun (this is not a necessary assumption), it moves with respect to Earth with a velocity $v = -v_E$, where v_E is the orbital velocity of Earth. If the tube is thin, the gravito-Lorentz force experienced by dark matter equals in the first approximation to $F = -v_E \times B_E$ with B_E evaluated at the axis of the tube. TGD based model for B_E [K85] does not allow B_E to be a dipole field. B_E has only the component B^θ and the magnitude of this component relates by a factor $1/\sin(\theta)$ to the corresponding component of the dipole field and becomes therefore very strong as one approaches poles. The consistency with the existing experimental data requires that B_E at equator is very nearly equal to the strength of the dipole field. The magnitude of B_E and thus of F is minimal when the deformation of the tube is in P_E , and the deformation occurs very naturally into P_E since the non-gravitational forces associated with the dark matter tube must compensate a minimal gravitational force in dynamical equilibrium.
- (b) B_E^θ at equator is in the direction of the spin velocity ω of the Earth. The direction of v_E varies. It is convenient to consider the situation in the rest system of Sun using Cartesian coordinates for which the orbital plane of Earth corresponds to (x,y) plane with x- and y-axis in the direction of semi-minor and semi-major axes of the Earth's orbit. The corresponding spherical coordinates are defined in an obvious manner. v_E is parallel to the tangent vector $e_\phi(t) = -\sin(\Omega t)e_x + \cos(\Omega t)e_y$ of the Earth's orbit. The direction of B_E at equator is parallel to ω and can be parameterized as $e_\omega = \cos(\theta)e_z + \sin(\theta)(\cos(\alpha)e_x + \sin(\alpha)e_y)$. F is parallel to the vector $-\cos(\theta)e_\rho(t) + \sin(\theta)\cos(\Omega t - \alpha)e_z$, where $e_\rho(t)$ is the unit vector directed from Sun to Earth. The dominant component is directed to Sun.

Fly-by anomaly as transverse relativistic Doppler effect?

A new twist in the story of fly-by anomaly emerged at September twelfth 2007. The proposal of Jean-Paul Mbelek [E162] explains fly-by effect as a relativistic transverse Doppler effect and thus purely kinematic effect. Also the functional dependence of the parameter K characterizing

the size of the effect on the kinematic parameters is predicted and the prediction is consistent with the empirical findings in the example considered. Therefore the story of fly-by anomaly might be finished and dark matter at the orbit of Earth could bring in only an additional effect. It is probably too much to hope for this kind of effect to be large enough if present.

9.7 Do we really understand the solar system?

The recent experimental findings have shown that our understanding of the solar system is surprisingly fragmentary. As a matter of fact, so fragmentary that even new physics might find place in the description of phenomena like the precession of equinoxes and the recent discoveries about the bullet like shape of heliosphere and strong magnetic fields near its boundary bringing in mind incompressible fluid flow around obstacle. TGD inspired model is based on the heuristic idea that stars are like pearls in a necklace defined by long magnetic flux tubes carrying dark matter and strong magnetic field responsible for dark energy and possibly accompanied by the analog of solar wind. Heliosphere would be like bubble in the flow defined by the magnetic field inside the flux tube inducing its local thickening. A possible interpretation is as a bubble of ordinary and dark matter in the flux tube containing dark energy. This would provide a beautiful overall view about the emergence of stars and their helio-spheres as a phase transition transforming dark energy to dark and visible matter. Among other things the magnetic walls surrounding the solar system would shield the solar system from cosmic rays. The model leads to a vision about formations of stars and galaxies as "boiling" of dark energy to matter. Also a model for the cosmic rays emerges allowing to identify the acceleration mechanism using recent findings about cosmic rays.

9.7.1 Motivations

The inspiration to this little contribution came from a discussion with my friend Pertti Kärkkäinen who told me about the work of Walter Cruttenden [E94]. Cruttenden is a free researcher working with an old problem related to the astronomy of the solar system, namely the precession of equinoxes [E34]. Equinoxes [E15] correspond to the two points at the orbit of Earth at which the Sun is in the plane of the equator (if Earth's spin axes were not tilted this would be the case always). What has been observed is an apparent movement of fixed stars relative to the Earth bound observer. The period of the equinox precession is about 26,000 years. The angular radius of the precession cone is about 23.5 degrees. The rate of precession is approximately 50 arc seconds per year but is not strictly constant.

The precession of equinoxes reduces to precession which is a well-known phenomenon associated with the motion of a rigid body with one point fixed. Precession [E33] means that the spin axis of the spinning system rotates around fixed axis along the surface of a cone. One can distinguish between a torque free precession and precession induced by torque. Precession can be accompanied by a nutation [E30]: the tilt angle of the spin axes with respect to fixed axes varies with time. The nutation for Earth is well-understood process determined by the local gravitational physics. In the case of precession the situation is not so clear.

Two basic theories explaining the precession of equinoxes

There are two basic theories of precession.

- (a) The precession of equinoxes could be governed by a local dynamics being due to the precession of the Earth with respect to solar system. Earth is indeed a prolate ellipsoid and the precession would be caused mainly by the gravitational fields of Sun and Moon (lunisolar model). According to the summary of Cruttenden [E94], Newton's equations did not work and d'Alembert and others have added and changed input values to fit the observed precession. The latest 2000A version includes almost 1400 terms but it still fails to accurately predict variations in the precession rate. The theory is also plagued by a "measurement paradox". Studies show that the changes in Earth's orientation relative to Sun and other

planets are small (few arc seconds per year instead of 50 arc seconds) as compared to the equinox precession.

- (b) The precession of equinoxes could be also due to the precession of the entire solar system regarded as a rigid body with one point fixed and would be caused by some hypothetical binary companion of Sun. Usually the binary companion is thought to be star of planet like system but this is not necessary. This model is known as binary model and was first proposed by Indian astronomer Sri Yukteswar. The predicted period was 24,000 years. According to the summary of Cruttenden, the binary model of Yukteswar has turned out to be more accurate over 100 year period [E94].

In principle the observation of the precession from some other planet could select between the two approaches. If the precession were similar at two planets then the precession of the entire solar system would be strongly favored as an explanation of the equinox precession.

Some hints

The basic challenge for the binary theory is of course the identification of the binary. There are some hints in this respect listed by W. Cruttenden in the articles at his homepage. Consider first what has been learned from the structure of heliosphere during last years.

- (a) The data from Voyager 1 and Voyager 2 have revealed that heliosphere is asymmetric [E93]. The edge of the heliosphere (the place where the solar wind slows down to sub-sonic speeds and is heated) appears to be 1.2 billion kilometers shorter on the south side of the solar system than it is on the edge of the planetary plane. This indicates the heliosphere is not a sphere but has a shape of a bullet. In a sharp contrast with the naive expectations, the magnetosphere of Sun would not be like that of Earth which is compressed on the day side by solar wind and has a long tail on the night side.
- (b) There is also evidence from Voyager 2 for a strong magnetic field [E82]. Also the temperature just outside the boundary zone defining the boundary of the solar inner magnetosphere was ten times cooler than expected. The presence of the strong magnetic field is not easy to understand since the interstellar space consists of extremely tenuous gas. The proposal is that the interstellar magnetic field could be forced to flow around the helio-magnetosphere much like fluid flows around obstacle. This increases the density of flux lines and interstellar magnetic field would become stronger locally. Heliosphere would be like a bubble inside magnetic flux tube expanding it locally.

The direction of the local magnetic field at the edge of the heliosphere differs considerably from that for the interstellar magnetic field thought to be parallel to the galactic plane. The tilt angle is about 60 degrees. Therefore one can challenge the identification of the strong local magnetic field as galactic magnetic field.

- (c) Between June and October 2007, the STEREO spacecraft [E48] "detected atoms originating from the same spot in the sky: the shock front and the helio-sheath beyond, where the sun plunges through the interstellar medium, and found energetic neutral particles from beyond the heliosphere that are moving towards the sun [E54]. This would suggest magnetic flux tube like structure and the flow of neutral particles along the flux tube towards the Sun so that an analog of solar wind would be in question.

Also the behavior of comets suggests that the understanding of the solar system is far from complete. The behavior of the comet Sedna thought to belong to the inner Oort cloud [E31] cannot be explained in terms of theory assuming only solar and planetary gravitational fields. Typically comets move along periodic orbits returning repeatedly near some planet of solar system (typically Neptune) which has kicked the comet to its highly eccentric orbit. Sedna [E2] (thought to be a "dwarf planet") seems to be an exception in this respect. Sedna has an exceptionally long and elongated orbit (aphelion about 937 AU and perihelion about 89.6 AU), period is estimated to be 11,400 years, and Sedna does not return near any planet periodically as the assumption that it belongs to the scattered disk would require.

What could be the origin of Sedna?

- (a) It has been suggested that that Sun has an dim binary companion - christened as Nemesis [E29]- at a distance of thousands of AUs. This companion could explain the behavior of Sedna, and has been also proposed to be responsible for the conjectured periodicity of mass extinctions, the lunar impact record, and the common orbital elements of a number of long period comets.
- (b) Second proposal is that Sedna has been kicked to its orbit by some object. This object could be an unseen planet much beyond the Kuiper belt [E23] (Kuiper belt is outside planet Neptune and extends from 30 AU to 55 AU). It would have mass about 5 times the mass of Jupiter and be at distance of roughly 7850 AU from the Sun in the inner Oort cloud. It could be a single passing star or one of the young stars embedded with the Sun in the stellar cluster in which it formed. This might have happened already in the Sun's birth cluster (cluster of stars).
- (c) Also the behavior of the comets in outer Oort cloud (very eccentric orbits and long orbital periods) might reflect the influence of a binary companion whose mass distribution is such that this kind of orbits are generic. For spherical objects one would expect nearly circular orbits. String like object would satisfy this condition as will be found.

The identification of the companion of the Sun in the framework of standard physics

Consider first the identification of the companion of the Sun responsible for the precession of the solar system as a whole but staying in the framework of the standard physics. In this context only objects with a spherical symmetry can be considered.

- (a) The strange behavior of Sedna suggests that binary could be an unseen planet at distance of about 7850 AU in the inner Oort cloud. Note that Oort could extend up to 50,000 AUs which corresponds to .75 ly whereas the closest star - Proxima Centauri- is at distance of about 4.2 light years.
- (b) The identification of the binary as the hypothetical Nemesis might explain the analog of the solar wind. If the dim Nemesis is at the same distances as the hypothetical planet, its mass would be only .5 per cent of solar mass.
- (c) An analog of solar wind flowing along magnetic flux tubes could also come from some other star, say Proxima Centauri [E35]. Proxima Centauri is however too light as red dwarf and too distant to induce the precession of the solar system as whole.

The identification of the companion of the Sun in TGD framework

In TGD framework one can consider more speculative ideas concerning the identification of the binary of the Sun.

- (a) In TGD Universe dark matter and dark energy can be understood as phases of matter with large Planck constant [K30]. For the dark energy assignable to the flux tubes mediating gravitational interaction between Sun and given planet the value of the Planck constant is of order GMm/v_0 , where $v_0/c \simeq 2^{-11}$ holds true for the inner planets. For dark matter the value of Planck constant is much smaller integer multiple of its minimal value identified as the ordinary Planck constant. Whether only magnetic energy should be counted as dark energy or whether also dark particles with a gigantic value of Planck constant should be identified as dark energy is not quite clear.
- (b) Magnetic flux tubes are identified as carriers of dark matter. This hypothesis plays a key role in TGD inspired quantum biology and cosmology. The flux tubes can have arbitrary large length scales. During the cosmology space-time would have consisted of cosmic strings of form $X^2 \times Y^2 \subset M^4 \times CP_2$ with X^2 minimal surface and Y^2 complex sub-manifold of CP_2 . In the course of the cosmic evolution their M^4 projection would have become 4-dimensional and they would have become magnetic flux tubes. The proposal is that galaxies are like pearls in a necklace formed by flux tubes [K24].

The density ρ_{dark} of the magnetic energy is enormous for cosmic strings: the length L of cosmic string corresponds to a mass which is a fraction $G/\hbar_0 R^2 \sim 10^{-4}$ of the mass of a black hole with radius L . The thickening of the cosmic string to a flux tube respects the conservation of the magnetic flux so that the strength of the magnetic field scales down like $B \propto 1/S$, where S is the area for the transversal cross section of the flux tube. By a simple scaling argument the density of the magnetic energy per unit length of the flux tube scales down like $dE_m/dl \propto 1/S$.

If energy is conserved if the length of the cosmic string scales up like S in the cosmic expansion: $d \propto \sqrt{L}$ proportionality analogous to that encountered in the case of diffusion would relate to each other flux tube radius and length. Also the primary p-adic length scales L_p assignable to particles and the secondary p-adic length scales $L_{p,2}$ characterizing the corresponding causal diamond CD relate in a similar manner. This would suggest that the p-adic length scale assignable to a given particle (of order Compton length) corresponds to the thickness of the magnetic flux tube(s) assignable to the particle and the size of CD to the length of the(se) magnetic flux tube(s). Similar scaling holds true for the density of dark matter per unit length of the flux tube.

The dark matter associated with the flux tubes would generate transversal $1/\rho$ gravitational field explaining the constant velocity spectrum of distance stars in the galactic halo. The basic prediction is free motion along the direction of the cosmic string perturbed only by the mass of the galaxy itself.

- (c) The fractality of the TGD Universe suggests the pearls in the necklace model applies also to stars. The magnetic flux tube idealizable straight string would be roughly orthogonal to the plane of the planetary system possibly associated with the star and the spin axis of the star would be nearly parallel to the flux tube. If one combines this picture with the previous discussion, the simplest proposal is obvious. The binary companion of the Sun is the magnetic flux tube containing dark matter. An analog of the solar wind could blow from the nearest star associated with the flux tube.

Newtonian theory for the gravitation in planetary system works excellently and this poses strong constraints on the pearls in a necklace model will be discussed in more detail.

- (a) If the magnetic flux tube idealizable as a straight string carries dark matter, this dark matter gives an additional transversal $1/\rho$ contribution to the gravitational field in the exterior of the flux tube experienced by comets and also by planets. Near the Sun this contribution should be small as compared to the contribution of the Sun but this is not obvious. Inside the flux tube the gravitational potential would be apart from a constant proportional to ρ^2 . It could affect much the gravitational potential of Sun in a detectable manner.
- (b) The contribution of the gravitational potential of dark matter to the dynamics of the solar system is certainly negligible if the heliosphere is a bubble inside the magnetic flux tube having fluid flow as an analog. Stars could be bubbles of ordinary and dark matter inside flux tubes containing dark energy with a gigantic value of Planck constant. Fractality suggests that this picture might apply also to galactic magnetospheres and even in biological systems where TGD inspired quantum biology predicts that the flux tubes containing dark matter use visible matter as sensory receptor and motor instrument [K25, K26]. Cell would be a fractal analog of the solar heliosphere in this framework!
- (c) At long distances the transversal gravitational field created by the dark matter at the magnetic flux tube begins to dominate and the situation is very much like in the case of galaxies. In particular, for circular orbits the rotation velocity is constant. The logarithmic behavior of the gravitational potential implies that the orbits tend to be highly eccentric and the it might be that the behavior of comets in the outer Oort cloud at least could be dictated by the gravitational field of the flux tube.

How thick the flux tube in question is and is its thickness affected by the presence of Sun and heliosphere?

- (a) The magnetic flux tube should have transversal dimensions not must larger than those of planetary system or heliosphere. The heliosphere has radius of about 80-100 AU to be compared to the distance 40 AU of Neptune. The distance of Neptune about 30 AU gives the first guess for the thickness of the flux tube. Kuiper belt extends from 30 AU to 55 AU and would surround the flux tube in this case.
- (b) Second guess is that the flux tube is so thick that it contains also Kuiper belt.
- (c) Third guess motivated by the above experimental findings is that the magnetic flux flows past the heliosphere like fluid flow: this would apply also to the dark matter inside flux tube. Heliosphere corresponds to a hollow bullet like bubble of ordinary and dark matter formed inside the flux tube carrying dark energy and carrying only the magnetic fields of Sun and planets.

The dark energy and possible dark matter inside the flux tube (particular kind of space-time sheet) would have no effect on the gravitational field inside heliosphere so that no modifications of the existing model of solar system would be needed. Outside the heliosphere the effect would be in a good approximation described by a logarithmic gravitational potential created by an infinitely thin string like structure. The strong magnetic field of the flux wall surrounding the heliosphere would form a shield against the effects of cosmic rays coming from interstellar space.

The third guess seems to be consistent with the recent findings about the heliosphere boundary.

- (a) The strong magnetic field detected by Voyager 2 [E50] has been identified as galactic magnetic field which has changed its direction locally and for which the density of flux tubes has increased. Near the helio-sheath heliosphere would have deformed it locally inducing a tilt angle of 60 degrees with respect to the galactic plane.

The article contains a video giving an artist's view about the magnetic field suggesting strongly that flux tube develops a hole representing heliosphere. Could the magnetic field actually correspond to the dark magnetic field associated with the proposed magnetic flux tube? Helio-sheath has radius of order 80-100 AU so that this interpretation could make sense. This would challenge the interpretation as a galactic magnetic field unless the galactic magnetic field itself decomposes into flux tubes some of which contain stars as bubbles of ordinary and dark matter.

- (b) The findings of STEREO suggest that neutral atoms - presumably hydrogen atoms- arrive from a spot in the sky. It is not clear to me whether the spot refers to something in interstellar space (say another star) or just to the tip of the bullet like structure defined by the heliosphere. The simplest guess is that Proxima Centauri belongs to the same flux tube as Sun: this hypothesis is easy to kill if one assumes that the flux tube connecting Sun and Proxima Centauri is straight. The red dwarf character of Proxima Centauri does not however favor this hypothesis. Unfortunately I could not find any data about the direction of the analog of the solar wind.
- (c) Interstellar Explorer discovered a narrow ribbon in heliosphere [E28]. This ribbon could correspond to the locus in which the deflection for the magnetic magnetic flux tubes caused by the heliosphere is such that the neutral particle of the solar wind can return back. The proposal is that magnetic walls act as mirrors. The reflection would involve ionization of neutral particle following by a confinement around flux tube plus possible motion in the direction of the flux tube and subsequent neutralization followed by a free linear motion possible back to Sun. Only when the neutral particle arrives to the magnetic flux wall in approximately orthogonal direction, the reflection would occur via this process. Otherwise the particle would leak out along the magnetic flux wall.

An interesting question concerns the criteria for what it is to be pearls in the same necklace.

- (a) One possible criterion would be correlated motion in the absence of gravitational binding. The moving groups of stars [E47] not bound by gravitational interaction would satisfy this criterion.

- (b) Another criterion that one can imagine is that the stars are in the same developmental stage. Maybe stellar nurseries contain tangled magnetic flux tubes inside which bubbles of ordinary and dark matter are formed in a phase transition transforming dark energy to ordinary and dark matter: the flux tubes mediating gravitational interaction would still carry dark energy as magnetic energy and have a gigantic value of Planck constant.

One can imagine also other dark options besides the proposed one: such as dark planets or dark Nemesis but these options are more speculative and might fail to explain the analog of the solar wind. Also the proposed dark matter matter at the orbits of the planets might have some role and fractality suggests that dark matter is present in in all scales so that one has bubbles inside bubbles inside....

In the following the idea that magnetic flux tube containing dark matter is tested by building simple models for the orbits of comets in the gravitational field of the flux tube and for the precession of the solar system in this field. The models are oversimplified and can be taken only as first steps to test whether the proposed vision might work.

9.7.2 A model for the motion of comet in the gravitational field of flux tube

One should derive tests for the idea that also stars are mass concentrations around magnetic flux tube like structures evolved from extremely thin cosmic strings forming linear structures analogous to pearls in a necklace.

- (a) One possible signature might be the motion of comets. If the general structure of the orbits of comets in outer (at least) Oort cloud [E31] are determined by the gravitational field of the magnetic flux tube structure their general characteristics should reflect the very slowly variation of the logarithmic gravitational potential of the flux tube. What one would expect is typically very eccentric orbits in the plane of the solar system orthogonal to the flux tube and having very long orbital periods. Comet orbits in the outer Oort cloud indeed have these characteristics.
- (b) Second characteristic signature is free motion in direction parallel to the flux tube apart from effects caused by the solar gravitational field. This could imply the leakage of the comets from the system if the velocity is higher than the escape velocity from the solar system in presence of only solar gravitational field. Also the concentration of comets strongly in the plane of the solar system would imply that the total number of comets is much lower than predicted by the spherically symmetric model for the Oort cloud: this conforms with experimental facts [E31]. A more complex situation corresponds to a motion to which the gravitational fields of Sun and flux tube are both important. This could be relevant for motions which are not in the plane of planetary system.

Gravitational potential of a straight flux tube with constant mass density

The gravitational potential for a straight flux tube with constant density of dark energy (or matter) ρ_{dark} will be needed in the sequel.

- (a) Gravitational potential satisfies the Poisson equation

$$\nabla^2 \phi_{gr} = 4\pi G \rho_{dark} . \quad (9.7.1)$$

- (b) For a straight flux tube of radius d the mass density is constant and the situation is cylindrically symmetric and the solution inside the flux tube reads as

$$\begin{aligned} \phi_{gr} &= G\pi\rho_{dark}d^2 = GT\frac{\rho^2}{d} , \\ T &= \frac{dM}{dl} . \end{aligned} \quad (9.7.2)$$

T is the linear mass density.

Outside the straight flux tube the potential is given by Gauss theorem as

$$\phi_{gr} = 2TG \times \log\left(\frac{\rho}{\rho_0}\right) . \quad (9.7.3)$$

The choice of the value ρ_0 is dictated by boundary conditions at the boundary of the flux tube if one assumes that the potential energy vanishes at origin. Its change induces only an additive constant to the total energy and does not effect equations of motion.

Motion of a test particle in the region exterior to the flux tube

One can construct a model for the motion of comet in gravitational field of flux tube by idealizing it with an infinitely thin straight string with string tension kept as a free parameter. For simplicity the motion will be assumed to take place in the plane orthogonal to the flux tube.

- (a) The gravitational potential energy of mass in the field of straight string like object is given by

$$V(\rho) = k \log(x) , \quad x = \frac{\rho}{\rho_0} , \quad k = 2TG \quad (9.7.4)$$

Here ρ_0 is a parameter which can be chosen rather freely since only the value of the conserved energy changes as ρ_0 is changed. One possible choice is $\rho_0 = \rho_{min}$, the minimum value of the radial distance from the flux tube idealized to be infinitely thin.

- (b) Conserved quantities are angular momentum

$$L = m\rho^2 \frac{d\phi}{dt} , \quad (9.7.5)$$

and energy

$$E = \frac{m}{2} \left(\frac{d\rho}{dt}\right)^2 + \frac{L^2}{2m\rho^2} + V(\rho) . \quad (9.7.6)$$

- (c) One can integrate these equations to get for the period of the motion the expression

$$\frac{T}{\rho_0} \sqrt{2Em} = 2 \int_{x_-}^{x_+} \frac{dx}{\sqrt{1 - \frac{L^2}{E^2 \rho_0^2 x^2} - k \log(x)}} , \quad (9.7.7)$$

$$x_- = \frac{\rho_-}{\rho_0} , \quad x_+ = \frac{\rho_+}{\rho_0} .$$

- (d) The turning points of the motion corresponds to the vanishing of the argument of the square root. At x_+ the logarithmic term dominates under rather general conditions whereas logarithmic term can be neglected at x_- , and one has in good approximation

$$x_+ \simeq e^{\frac{L}{k}} , \quad x_- = \frac{L}{E\rho_0} . \quad (9.7.8)$$

Without a loss of generality one can choose $\rho_0 = L/E$ giving $x_- = 1$ which gives

$$\rho_- \simeq \frac{L}{E} , \quad \rho_+ \simeq \rho_- \times e^{\frac{L}{k}} , \quad (9.7.9)$$

For large values of L/k the orbits is very eccentric since one has $\rho_+/\rho_- \simeq \exp(L/k)$.

A highly eccentric orbit with a very long orbital period is expected to represent the generic situation so that the model could indeed explain the characteristics of the comets in the outer Oort cloud. In the inner Oort cloud the eccentricities are smaller and the natural explanation would be that the gravitational field of Sun determines the characteristics of these orbits in good approximation.

9.7.3 A model for the precession of the solar system in the gravitational field of flux tube

The model for the precession of the solar system in the gravitational field of the flux tube is obtained by idealizing the solar system with a cylindrically symmetry top with one point fixed in the gravitational field of the flux tube. The calculation is a little modification of that appearing in any text book of classical mechanics: I have used Herbert Goldstein's "Classical Mechanics" familiar from my student days [B36].

- (a) The model above requires that the solar system is a bullet like bubble inside the flux tube and dark energy induces no gravitational interaction inside the bubble. The bubble is approximated as a rigid body with one point fixed, which can thus perform precession. The torque must be due to the dependence of the total gravitational potential energy on the tilt angle θ of the bubble with respect to the axis of the flux tube.
- (b) One can apply the same trick as in the case of estimating the force on levitating superconductor in external magnetic field. Since the magnetic field does not penetrate the superconductor, the interaction energy is the negative of the magnetic energy of the external field in the volume occupied by the superconductor. Now one obtains the *negative* of the interaction energy of the dark matter with its own gravitational potential. This can be written as

$$E_{gr} = -\frac{1}{8\pi G} \int (\nabla\phi_{gr})^2 dV . \quad (9.7.10)$$

The value of the interaction energy depends on the orientation of the heliosphere which gives rise to a torque.

Calculation of the gravitational potential energy

The value of the potential energy must be calculated for various orientations of the bubble. Cylindrical coordinates (ρ, z, ϕ) are obviously the proper choice of coordinates. Cylindrical rotational symmetry implies that the potential energy depends on the inclination angle θ only characterizing the cone of precession. Potential energy is defined as an integral over the bubble. Potential energy is proportional to the transverse distance from the axis of the magnetic flux tube and this simplifies the analytical calculations considerably.

- (a) The change of the orientation of the bubble by a rotation which can be taken to be a rotation in (y, z) plane by angle θ means that the expression for the transverse distance squared - call it $(\rho')^2$ - from the axis of the flux tube is given by

$$\begin{aligned} (\rho')^2 &= x^2 + (\sin(\theta)z + \cos(\theta)y)^2 \\ &= \rho^2 \cos^2(\phi) + \rho^2 \cos^2(\theta) \sin^2(\phi) + z^2 \sin^2(\theta) + 2z\rho \cos(\theta) \sin(\theta) \sin(\phi) \end{aligned} \quad (9.7.11)$$

By the rotational symmetry the contribution of the term linear in $\sin(\phi)$ vanishes in the integral and the integral of $(\rho')^2$ over ϕ can be done trivially so that one obtains the integral of quantity

$$I = \pi [\rho^2 + \rho^2 \cos^2(\theta) + 2z^2 \sin^2(\theta)] . \quad (9.7.12)$$

over z and ρ . The integral of the ρ^2 gives a term which does not depend on θ and therefore does not contribute to torque and can be dropped and one obtains

$$I = \int dV [\rho^2 \cos^2(\theta) + 2z^2 \sin^2(\theta)] . \quad (9.7.13)$$

To simplify the situation one can assume that bullet is hemisphere so that one has $z^2 = d^2 - \rho^2$ at the upper boundary. It is convenient to introduce scaled coordinates $x = \rho/d$ and $y = z/d$.

The integration over ϕ can be carried out trivially so that apart from additive constant term one has

$$\begin{aligned} I &= \pi d^5 (I_1 \cos^2(\theta) + I_2 \sin^2(\theta)) , \\ I_1 &= \int_0^1 dy \int_0^{\sqrt{1-y^2}} x^3 dx = \frac{1}{4} \int_0^1 dy (1-y^2)^2 = \frac{44}{45} , \\ I_2 &= 2 \int_0^1 dx x \int_0^{\sqrt{1-x^2}} dy y^2 = \frac{2}{3} \int_0^1 dx x (1-x^2)^{3/2} = \frac{2}{15} \end{aligned} \quad (9.7.14)$$

(b) By replacing the upper limit of x integral with $z = f(\rho)$ one obtains the more general situation.

(c) The value of the integral I is given by

$$\begin{aligned} I &= \pi d^5 \left[\frac{44}{45} \cos^2(\theta) + \frac{2}{15} \sin^2(\theta) \right] \equiv \frac{38}{45} \pi u^2 , \\ u &= \cos(\theta) . \end{aligned} \quad (9.7.15)$$

Here a constant term not contributing to the torque has been dropped away.

(d) By substituting the explicit expression for the gravitational potential one obtains the following expression for the gravitational potential

$$V = V_1 u^2 , \quad V_1 = -\frac{19}{15} \times \frac{3}{8\pi} \frac{GM_{dark}^2}{d} . \quad (9.7.16)$$

The proportionality to GM_{dark}^2/d could have been guessed using dimensional analysis.

Solving the equations of motion from conservation laws

The equations of motion can be solved using standard procedure applicable to cylindrically symmetry top with one point fixed. The potential has the following general form for the bubble model;

$$V(u) = V_1 u^2 \text{ (bubble)} . \quad (9.7.17)$$

Note that one has $V_1 < 0$ is by previous arguments more realistic than the potential when the magnetic flux penetrates the solar system (note that solar system would repel the magnetic flux like super-conductor). In the latter case analytical calculation would be also impossible although also now the potential depends on u only.

The calculation proceeds in the following manner [B36].

- (a) The Lagrangian is given in terms of Euler angles (θ, ϕ, ψ) by

$$L = \frac{I_1}{2} \left[\left(\frac{d\theta}{dt} \right)^2 + (1 - u^2) \left(\frac{d\phi}{dt} \right)^2 \right] + \frac{I_3}{2} \left(\frac{d\psi}{dt} + u \frac{d\phi}{dt} \right)^2 - V_1 u^2 . \quad (9.7.18)$$

Here $I_1 = I_2$ resp. I_3 are the eigen values of the inertia tensor in the directions orthogonal resp. parallel to symmetry axis. In the recent case I_1 and I_2 correspond to the two directions orthogonal to the the symmetry axis of the bullet like heliosphere and I_3 to the direction of the symmetry axis of the heliosphere.

- (b) ϕ and ψ are cyclic coordinates and give rise to two conserved quantities corresponding to conserved angular momentum components

$$\begin{aligned} p_\psi &= I_3 \left(\frac{d\psi}{dt} + u \frac{d\phi}{dt} \right) \equiv I_1 a , \\ p_\phi &= [I_1(1 - u^2) + I_3 u^2] \frac{d\phi}{dt} + I_3 u \frac{d\psi}{dt} \equiv I_1 b . \end{aligned} \quad (9.7.19)$$

From these equations one can solve $d\psi/dt$ and $d\phi/dt$ (recession velocity) in terms of u and various parameters and integrate this equations with respect to time if $u(t)$ is known.

- (c) Energy conservation gives an additional condition. By noticing that also the quantity $p_\psi^2/2I_3$ is conserved and one obtains

$$E' = E - \frac{p_\psi^2}{2I_3} = \frac{I_1}{2} \left(\frac{d\theta}{dt} \right)^2 + (1 - u^2) \left(\frac{d\phi}{dt} \right)^2 + V_1 u^2 \quad (9.7.20)$$

is conserved. By little manipulations one can integrate θ or equivalently t from this equation and one obtains for the period T of motion the expression of form

$$\begin{aligned} T &= 2 \int_{u_-}^{u_+} \frac{du}{\sqrt{(1 - u^2)(\alpha - \beta u^2) - (b - au)^2}} , \\ \alpha &= \frac{2E'}{I_1} , \quad \beta = \frac{2V_1}{I_1} , \quad V_1 = -\frac{19}{15} \times \frac{3}{8\pi} \frac{GM_{dark}^2}{d} . \end{aligned} \quad (9.7.21)$$

The coefficients α and β can be deduced from the conservation laws for p_ψ and p_ϕ . Note that for the cylindrically symmetric rotating rigid body in Earth's magnetic field the negative $V_1 u^2$ term is replaced with $2GMl \times u$ term having positive sign. By replacing u_+ with u as the upper integration limit one obtains the relationship $t = t(u)$ and can in principle invert this relationship to get $u = u(t)$.

The integral in question is elliptic integral [A6, A5], whose general form is

$$P(a, b) = \int_a^b R(u, \sqrt{P(u)}) du , \quad (9.7.22)$$

where R is rational function of its arguments and $P(t)$ is a polynomial with degree not higher than 4. Now the degree of P is maximal and the rational function reduces to a rational function $R(u, \sqrt{P(u)}) = 1/\sqrt{P(u)}$ of single variable. The limits are given by $(a, b) = (u_-, u)$ in the general case. By an appropriate change of variables elliptic integrals can be always reduced to three canonical elliptic integrals known as Legendre forms [A15].

(a) In the recent case the elliptic integral is of the standard form

$$\begin{aligned} t &= \int_{u_-}^u dv \frac{1}{\sqrt{P_4(v)}} , \quad P_4(v) = a_4 v^4 + a_3 v^3 + a_2 v^2 + a_1 v + a_0 , \\ a_4 &= -\beta , \quad a_3 = 0 , \quad a_2 = -\alpha - a^2 , \quad a_1 = 2ab , \quad a_0 = \alpha - b^2 . \end{aligned} \quad (9.7.23)$$

It can be computed analytically [A5] in terms of Weierstrass elliptic function $\mathcal{P}(t; g_2, g_3)$ [A37, A38] with invariants

$$\begin{aligned} g_2 &= a_0 a_4 - 4a_1 a_3 + 3a_2^2 , \\ g_3 &= a_0 a_2 a_4 - 2a_1 a_2 a_3 - a_4 a_1^2 - a_3^2 a_0 . \end{aligned} \quad (9.7.24)$$

(b) Weierstrass elliptic function is the inverse of the function defined by the elliptic integral

$$t = \int_t^\infty \frac{ds}{4s^3 - g_2 s - g_3} . \quad (9.7.25)$$

g_2 and g_3 are expressible in terms of zeros e_1, e_2, e_3 of $4s^3 - g_2 s + g_3$ satisfying $e_1 + e_2 + e_3 = 0$ (the quadratic term in the polynomial vanishes)

$$\begin{aligned} g_2 &= -4(e_1 e_2 + e_1 e_3 + e_2 e_3 = 2(e_1^2 + e_2^2 + e_3^2)) , \\ g_3 &= 4e_1 e_2 e_3 . \end{aligned} \quad (9.7.26)$$

The zeros of this polynomial must correspond to the zeros of the third order polynomial obtained when the zero u_- of P_4 is factorized out but for variable which is not u anymore. Either all the zeros are real or one is real and two complex conjugates of each other. This depends on the sign of the discriminant $\Delta = g_2^3 - 27g_3^2$. The possibly complex half periods ω_i (in the generic case) are related to the roots by $\mathcal{P}(\omega_1) = e_1$, $\mathcal{P}(\omega_2) = e_2$, $\mathcal{P}(\omega_3) = e_3 = -e_1 - e_2$ and satisfy $\omega_3 = -\omega_1 - \omega_2$. For real roots e_i ω_1 is real and ω_3 purely imaginary so that $\omega_2 = -\omega_1 - \omega_3$ is complex.

The ratio $\tau = \omega_1/\omega_2$ defines so called modular parameter τ characterizing the periodicity properties of the Weierstrass function in complex plane (or effectively on torus whose conformal structures is characterized by τ).

(c) If u_- is root of the P_4 as in the recent case, the expression for integral is given by

$$u = u_- + \frac{1}{4} P_4'(u_-) \left[\mathcal{P}(t; g_2, g_3) - \frac{1}{24} P_4''(u_-) \right]^{-1} . \quad (9.7.27)$$

Here $\mathcal{P}(t; g_2, g_3)$ is the Weierstrass elliptic function. This expression gives $u = \cos(\theta)$ as function of time t . The period T corresponds to the situation $u = u_+$ and must correspond to the $t = \omega_1$ (real period in the argument of \mathcal{P}). The values of this function can be calculated numerically using Mathematica.

(d) The relationship $u = u(t)$ giving by the above expression allows to integrate the equations for ψ and ϕ from the corresponding conservation laws by substituting the expression for $u(t)$ to these eqtions. Note that if nutation is absent so that $d\theta/dt = 0$ holds true and the above description fails since P_4 has a pair of degenerate real roots $u_+ = u_-$ meaning that nutation amplitudes becomes vanishing. This situation must be treated separately.

Exact solution when nutation is neglected

In the recent case the nutation can be neglected in the first approximation so that one has $d\theta/dt = 0$. In this case the two roots of the fourth order polynomial whose roots define the turning points are degenerate. This situation must be treated separately since the previous treatment fails.

- (a) The Lagrange equations of motion for θ give $\partial L/\partial\theta = 0$ stating that the torque vanishes in the equilibrium position for θ . The condition allows three solutions

$$\begin{aligned} u &= \pm 1 \text{ (no precession) ,} \\ u &= \frac{1}{r_{13} - 1} \times \frac{\left(\frac{d\psi}{dt}\right)^2}{\left(\frac{d\phi}{dt}\right)^2} \text{ (precession) ,} \\ r_{13} &\equiv \frac{I_1}{I_3} . \end{aligned} \tag{9.7.28}$$

If the bubble were a hemisphere with constant mass density one would have $r_{13} = 1/2$. Since the mass is concentrated in the orbital plane of planets, the value of I_3 is however smaller than I_1 and r_{13} is large suggesting that $r_{31} \equiv 1/r_{13}$ is a more convenient parameter for numerical calculations. If dark matter and energy do not contribute significantly inside helisphere, Jupiter would give the dominating contribution to I_1 and Sun to I_3 inside planetary system. Kuiper belts are expected to give a large contribution to I_1 . A rough estimate for r_{31} using various masses, solar radius, and planetary distances as basic data and neglecting Kuiper belt would give $r_{31} \sim 10^{-3}$. The actual value would be smaller than this unless dark matter changes the situation.

- (b) The conservation laws for p_ψ and p_ϕ read as

$$\begin{aligned} p_\psi &= I_3 \left(\frac{d\psi}{dt} + u \frac{d\phi}{dt} \right) \equiv I_1 a , \\ p_\phi &= [I_1(1 - u^2) + I_3 u^2] \frac{d\phi}{dt} + I_3 u \frac{d\psi}{dt} \equiv I_1 b , \end{aligned} \tag{9.7.29}$$

and give

$$\begin{aligned} \left(\frac{\frac{d\psi}{dt}}{\frac{d\phi}{dt}} \right) &= \frac{1}{1 - u^2} \left(\begin{array}{c} a [r_{13}(1 - u^2) + u^2] - bu \\ b - au \end{array} \right) , \\ \frac{\frac{d\psi}{dt}}{\frac{d\phi}{dt}} &= \pm \frac{a [r_{13}(1 - u^2) + u^2] - bu}{b - au} . \end{aligned} \tag{9.7.30}$$

Note that $d\psi/dt$ and $d\phi/dt$ are constants.

- (c) By substituting the expression for the ratio of these angular velocities to the equation for the equilibrium value of u , one obtains

$$u(b - au)^2 = \frac{1}{r_{13} - 1} \{ a [r_{13}(1 - u^2) + u^2] - bu \}^2 . \tag{9.7.31}$$

This is fourth order polynomial and the number of real roots is at most four. $u \rightarrow -u, b \rightarrow -b$ is a symmetry of this equation. The interpretation is as change of the direction of spin axis and precession axis.

- (d) By feeding $d\theta/dt = 0$ into the conservation law of energy, one obtains an expression for the conserved energy

$$E = \frac{I_1}{2} [(1 - u^2)(b - au)^2 + r_{13} b^2] + V_1 u^2 . \tag{9.7.32}$$

An interesting possibility is that the rotational motion of the bubble is stabilized against dissipation by the negativity of even the total energy E . The problem is that r_{13} is large and b is non-vanishing for precession so that the negativity of the total energy does not seem plausible.

A weaker condition is that $E' = E - p_\psi^2/2I_3$ is negative. This gives

$$E' = \frac{I_1}{2} [(1 - u^2)(b - au)^2 + r_{13}(b^2 - a^2)] + V_1 u^2 < 0 . \quad (9.7.33)$$

For $b^2 < a^2$ the sign of the large term in the kinetic energy changes. What this would mean that the rate of rotation of solar system around the instantaneous precessing instantaneous rotation axis is large as compared to the precession rate.

- (e) The estimate for the period of precession given by $T = 2.6 \times 10^4$ years. In the approximation that nutation is absent $d\phi/dt = \omega$ is constant, and one has $d\phi/dt = 2\pi/T = 2.4 \times 10^{-4}$ /year. The actual precession rate is not constant but its order of magnitude is same as the estimate obtained neglecting the nutation. Nutation would induce a time dependence of the precession rate. A reasonable expectation is that nutation represents a small oscillation around the solution representing mere precession.

Approximate solution when nutation is allowed

The model for non-nutating precession and the fact that precession rate is not quite constant suggest that a small nutation is present and induces the variation of the precession rate. A natural guess is that nutation represents a small perturbation around of non-nutating solutions. If this the case one can consider a standard treatment using standard perturbation theory assuming $u = u - 0 + \Delta u(t)$ and assuming that angular velocities are not affected at all so that only the u is perturbed.

- (a) The Lagrangian for small perturbations of this kind is

$$\Delta L = \frac{I_1}{2} \left(\frac{d\Delta u}{dt} \right)^2 + \left[\frac{(I_3 - I_1)}{2} \omega_\phi^2 - \frac{V_1}{2} \right] \Delta u^2 . \quad (9.7.34)$$

Here the shorthand notation $d\phi/dt \equiv \omega_\phi$ is introduced.

- (b) The equation for small oscillations is

$$\begin{aligned} \frac{d^2 \Delta u}{dt^2} + \omega_0^2 \Delta u &= 0 , \\ \omega_0^2 &= \left[(1 - r_{31}) \omega_\phi^2 + \frac{V_1}{I_1} \right] \Delta . \end{aligned} \quad (9.7.35)$$

- (c) Stability requires $\omega_0^2 > 0$. Since r_{13} is small the first term in ω_0^2 is positive. The second term is negative and this poses an upper bound for the magnitude of V_1 or alternatively lower bound for the magnitude of ω_ϕ :

$$\frac{I_1 \omega_\phi^2}{|V_1|} > \frac{1}{1 - r_{31}} = \frac{r_{13}}{r_{13} - 1} . \quad (9.7.36)$$

A possible interpretation of this condition that sufficiently high precession rate prevents the instability causing the value of u to increase. Note that $V_1 u^2$ is analogous to harmonic oscillator potential with a wrong sign. Note that for $\omega_\phi = 0$ which corresponds to $u_0 = 0$ the situation is unstable so that precession is necessary to stabilize the system against gravitational torque.

- (d) The period of nutation defines the period of oscillation for the rate of precession and this condition gives additional constraint on the parameters of the model.

9.7.4 Cosmic evolution as transformation of dark energy to matter

The proposed bubble option favored by the fact that Newtonian theory works so well inside planetary system favors bound state precessing solutions without nutation. These solutions are expected to be stable against dissipation. Small nutation around the equilibrium solution could explain the slow variation of the precession rate. The variation could be also caused by external perturbations. What is amusing from the mathematical point of view is that the model is analytically solvable and that the solution involves elliptic functions just as the Newtonian two-body problem does.

The model suggests a universal fractal mechanism leading to the formation of astrophysical and even biological structures as a formation of bubbles of ordinary or dark matter inside magnetic flux tubes carrying dark energy identified as magnetic energy of the flux tubes. In primordial cosmology these flux tubes would have been cosmic strings with enormous mass density, which is however below the black hole limit for straight strings. Strongly entangled strings could form black holes if general relativistic criteria hold true in TGD.

One must be very critical concerning the model since in TGD framework the accelerated cosmic expansion has several alternative descriptions, which should be mutually consistent. It seems that these descriptions corresponds to the descriptions of one and same thing in different length scales.

- (a) The critical and over-critical cosmologies representable as four-surfaces in $M^4 \times CP_2$ are unique apart from their duration [K73]. The critical cosmology corresponds to flat 3-space and would effectively replace inflationary cosmology in TGD framework and criticality would serve as a space-time correlate for quantum criticality in cosmological scales natural if hierarchy of Planck constants is allowed. The expansion is accelerating for the critical cosmology and is caused by a negative "pressure" basically due to the constraint force induced by the imbeddability condition, which is actually responsible for most of the explanatory power of TGD (say geometrization of standard model gauge fields and quantum numbers).
- (b) A more microscopic manner to understand the accelerated expansion would be in terms of cosmic strings. Cosmic strings [K24] expand during cosmic evolution to flux tubes and serve as the basic building bricks of TGD Universe. The magnetic tension along them generates a negative "pressure", which could explain the accelerated expansion. Dark energy would be magnetic energy.

The proposed boiling of the flux tubes with bubbles representing galaxies, stars, ..., cells, etc.. would serve as a universal mechanism generating ordinary and dark matter. The model should be consistent with the Bohr orbitology for the planetary systems [K72] in which the flux tubes mediating gravitational interaction between star and planet have a gigantic Planck constant. This is the case if the magnetic flux tubes quite generally correspond to gigantic values of Planck constant of form $\hbar_{gr} = GM_1M_2/v_0$, $v_0/c < 1$, where M_1 and M_2 are the masses of the objects connected by the flux tube.

- (c) Even more microscopic description of the accelerated expansion would be in terms of elementary particles. In TGD framework space-time decomposes into regions having both Minkowskian and Euclidian signatures of the induced metric [K85]. The Euclidian regions are something totally new as compared to the more conventional theories and have interpretation as space-time regions representing lines of generalized Feynman diagrams.

The simplest GRT limit of TGD relies of Einstein-Maxwell action with a non-vanishing cosmological constant in the Euclidian regions of space-time [K85]: this allows both Reissner-Nordström metric and CP_2 as special solutions of field equations. The cosmological constant is gigantic but associated only with the Euclidian regions representing particles having typical size of order CP_2 radius. The cosmological constant explaining the accelerated expansion at GRT limit could correspond to the space-time average of the cosmological constant and therefore would be of a correct sign and order of magnitude (very small) since most of the space-time volume is Minkowskian.

This picture can be consistent with the idea that magnetic flux tubes which have Minkowskian signature of the induced metric are responsible for the effective cosmological constant if

the magnetic energy inside the magnetic flux tubes transforms to elementary particles in a phase transition generating dark and ordinary matter from dark energy and therefore gives rise to various visible astrophysical objects.

9.7.5 The origin of cosmic rays

The origin of cosmic rays remains still one of the mysteries of astrophysics and cosmology. The recent finding of a super bubble [E144] emitting cosmic rays might cast some light in the problem.

What has been found?

The following is the abstract of the article published in Science [E102].

The origin of Galactic cosmic rays is a century-long puzzle. Indirect evidence points to their acceleration by supernova shockwaves, but we know little of their escape from the shock and their evolution through the turbulent medium surrounding massive stars. Gamma rays can probe their spreading through the ambient gas and radiation fields. The Fermi Large Area Telescope (LAT) has observed the star-forming region of Cygnus X. The 1- to 100-gigaelectronvolt images reveal a 50-parsec-wide cocoon of freshly accelerated cosmic rays that flood the cavities carved by the stellar winds and ionization fronts from young stellar clusters. It provides an example to study the youth of cosmic rays in a superbubble environment before they merge into the older Galactic population. The usual thinking is that cosmic rays are not born in states with ultrahigh energies but are boosted to high energies by some mechanism. For instance, super nova explosions could accelerate them. Shock waves could serve as an acceleration mechanism. Cosmic rays could also result from the decays of heavy dark matter particles.

The story began when astronomers detected a mysterious source of cosmic rays in the direction of the constellation Cygnus X [E183]. Supernovae happen often in dense clouds of gas and dust, where stars between 10 to 50 solar masses are born and die. If supernovae are responsible for accelerating of cosmic rays, it seems that these regions could also generate cosmic rays. Cygnus X is therefore a natural candidate to study. It need not however be the source of cosmic rays since magnetic fields could deflect the cosmic rays from their original direction. Therefore Isabelle Grenier and her colleagues decided to study, not cosmic rays as such, but gamma rays created when cosmic rays interact with the matter around them since they are not deflected by magnetic fields. Fermi gamma-ray space telescope was directed toward Cygnus X. This led to a discovery of a superbubble with diameter more than 100 light years. Superbubble contains a bright regions which looks like a duck. The spectrum of these gamma rays implies that the cosmic rays are energetic and freshly accelerated so that they must be close to their sources.

The important conclusions are that cosmic rays are created in regions in which stars are born and gain their energies by some acceleration mechanism. The standard identification for the acceleration mechanism are shock waves created by supernovas but one can imagine also other mechanisms.

Cosmic rays in TGD Universe?

In TGD framework one can imagine several mechanisms producing cosmic rays. According to the vision already discussed, both ordinary and dark matter would be produced from dark energy identified as Kähler magnetic energy and producing as a by product cosmic rays. What causes the transformation of dark energy to matter, was not discussed earlier, but a local phase transition increasing the value of Planck constant of the magnetic flux tube could be the mechanism. A possible acceleration mechanism would be acceleration in an electric field along the magnetic flux tube. Another mechanism is super-nova explosion scaling-up rapidly the size of the closed magnetic flux tubes associated with the star by \hbar increasing phase transition preserving the Kähler magnetic energy of the flux tube, and accelerating the highly energetic dark matter at the flux tubes radially: some of the particles moving along flux tubes would leak out and give rise to cosmic rays and associated gamma rays.

1. *The mechanism transforming dark energy to dark matter and cosmic rays*

Consider first the mechanism transforming dark energy to dark matter.

- (a) The recent model for the formation of stars and also galaxies is based on the identification magnetic flux tubes as carriers of mostly dark energy identified as Kähler magnetic energy giving rise to a negative "pressure" as magnetic tension and explaining the accelerated expansion of the Universe. Stars and galaxies would be born as bubbles of ordinary are generated inside magnetic flux tubes. Inside these bubbles dark energy would transform to dark and ordinary matter. Kähler magnetic flux tubes are characterized by the value of Planck constant and for the flux tubes mediating gravitational interactions its value is gigantic. For a start of mass M its value for flux tubes mediating self-gravitation it would be $\hbar_{gr} = GM^2/v_0$, $v_0 < 1$ (v_0 is a parameter having interpretation as a velocity).
- (b) On possible mechanism liberating Kähler magnetic energy as cosmic rays would be the increase of the Planck constant for the magnetic flux tube occurring locally and scaling up quantal distances. Assume that the radius of the flux tube is this kind of quantum distance. Suppose that the scaling $\hbar \rightarrow r\hbar$ implies that the radius of the flux tube scales up as r^n , $n = 1/2$ or $n = 1$ ($n = 1/2$ turns out to be the sensible option). Kähler magnetic field would scale as $1/r^{2n}$. Magnetic flux would remain invariant as it should and Kähler magnetic energy would be reduced as $1/r^{2n}$. For both options Kähler magnetic energy would be liberated. The liberated Kähler magnetic energy must go somewhere and the natural assumption is that it transforms to particles giving rise to matter responsible for the formation of star.

Could these particles include also cosmic rays? This would conform with the observation that stellar nurseries could be also the birth places of cosmic rays. One must of course remember that there are many kinds of cosmic rays. For instance, this mechanism could produce ultra high energy cosmic rays having nothing to do with the cosmic rays in 1-100 GeV rays studied in the recent case.

- (c) The simplest assumption is that the thickening of the magnetic flux tubes during cosmic evolution is based on phase transitions increasing the value of Planck constant in step-wise manner. This is not a new idea and I have proposed that entire cosmic expansion at the level of space-time sheets corresponds to this kind of phase transitions. The increase of Planck constant by a factor of two is a good guess since it would increase the size scale by two. In fact, Expanding Earth hypothesis having no standard physics realization finds a beautiful realization in this framework. Also the periods of accelerating expansion could be identified as these phase transition periods.
- (d) For the values of gravitational Planck constant assignable to the space-time sheets mediating gravitational interactions, the Planck length scaling like $r^{1/2}$ would scale up to black-hole horizon radius. The proposal would imply for $n = 1/2$ option that magnetic flux tubes having M^4 projection with radius of order Planck length primordially would scale up to blackhole horizon radius if gravitational Planck constant has a value GM^2/v_0 , $v_0 < 1$, assignable to a star. Obviously this evolutionary scenario is consistent with with what is known about the relationship between masses and radii of stars.

2. *What is the precise mechanism transforming dark energy to matter?*

What is the precise mechanism transforming the dark magnetic energy to ordinary or dark matter? This is not clear but this mechanism could produce very heavy exotic particles not yet observed in laboratory which in turn decay to very energetic ordinary hadrons giving rise to cosmic rays spectrum. I have considered a mechanism for the production of ultrahigh energy cosmic rays based on the decays of hadrons of scaled up copies of ordinary hadron physics [K52]. In this case no acceleration mechanism would be necessary. Cosmic rays lose their energy in interstellar space. If they correspond to a large value of Planck constant, situation would change and the rate of the energy loss could be very slow. The above described experimental finding about Cygnus X however suggests that acceleration takes place for the ordinary cosmic rays with relatively low energies. This of course does not exclude particle decays as the primary production

mechanism of very high energy cosmic rays. In any case, dark magnetic energy transforming to matter gives rise to both stars and high energy cosmic rays in TGD based proposal.

3. *What is the acceleration mechanism of cosmic rays or is there any such mechanism?*

How cosmic rays are created by this general process giving rise to the formation of stars?

- (a) Cosmic rays could be identified as newly created matter leaking out from the system. Even in the absence of accelerating fields the particles created in the boiling of dark energy to matter, particles moving along magnetic flux tubes would move essentially like free particles whereas in orthogonal directions they would feel $1/\rho$ gravitational force. For large values of \hbar this could explain very high energy cosmic rays. The recent findings about gamma ray spectrum however suggests that there is an acceleration involved for cosmic rays with energies 1-100 GeV.
- (b) One possible alternative acceleration mechanism relies on the motion along magnetic flux tubes deformed in such a manner that there is an electric field orthogonal to the magnetic field in such a manner that the field lines of these fields rotate around the direction of the flux tube. The simplest imbeddings of constant magnetic fields allow deformations allowing also electric field [K45], and one can expect the existence of preferred extremals with similar structure. Electric field would induce an acceleration along the flux tube. If the flux tube corresponds to large non-standard value of Planck constant, dissipation rate would be low and the acceleration mechanism would be very effective.

Similar mechanism might even explain the observations about ultrahigh energy electrons associated with lightnings at the surface of Earth: they should not be there because the dissipation in the atmosphere should not allow free acceleration in the radial electric field of Earth.

Here one must be very cautious: the findings are based on a model in which gamma rays are generated with collisions of cosmic rays with matter. If cosmic rays travel along magnetic flux tubes with a gigantic value of Planck constant, they should dissipate extremely slowly and no gamma rays would be generated. Hence the gamma rays must be produced by the collisions of cosmic rays which have leaked out from the magnetic flux tubes. If the flux tubes are closed (say associated with the star) the leakage must indeed take place if the cosmic rays are to travel to Earth.

- (c) There could be a connection with supernovae although it would not be based on shock waves. Also supernova expansion could be accompanied by a phase transition increasing the value of Planck constant. Suppose that Kähler magnetic energy is conserved in the process. This is the case if the lengths of the magnetic flow tubes r and radii by $r^{1/2}$. The closed flux tubes associated with supernova would expand and the size scale of flux tubes would increase by factor r . The fast radial scaling of the flux tubes would accelerate the dark matter at the flux tubes radially.

Cosmic rays having ordinary value of Planck constant could be created when some of the dark matter leaks out from the magnetic flux tubes as their expanding motion in radial direction accelerates or slows down. High energy dark particles moving along flux tube would leak out in the tangential direction. Gamma rays would be generated as the resulting particles interact with the environment. The energies of cosmic rays would be the outcome of acceleration process: only their leakage would be caused by it so that the mechanism differs in a decisive manner from the mechanism involving shock waves.

- (d) The energy scale of cosmic rays - let us take it to be about $E=100$ GeV for definiteness - gives an order of magnitude estimate for the Planck constant of dark matter at the Kähler magnetic flux tubes if one assumes that supernovae is producing the cosmic rays. Assume that electro-magnetic field equals to induced Kähler field (the space-time projection of space-time surface to CP_2 belongs homologically non-trivial geodesic sphere). Assume that E equals the cyclotron energy scale given by $E_c = \hbar e B / m_e$ in non-relativistic situation and by $E_c = \sqrt{\hbar e B}$ in relativistic situation. The situation is relativistic for both proton and electron now and at this limit the cyclotron energy scale does not depend on the mass of the charged particle at all. This means that same value of \hbar produces same energy for both electron and proton.

- i. The magnetic field of pulsar can be estimated from the knowledge how much the field lines are pulled together and from the conservation of magnetic flux: a rough estimate is $B = 10^8$ Tesla and will be used also now. This field is $2 \times 10^{12} B_E$ where $B_E = .5$ Gauss is the nominal value of Earth's magnetic field.
- ii. The cyclotron frequency of electron in Earth's magnetic field is $f_c(e) = 6 \times 10^5$ Hz in a good approximation and correspond to cyclotron energy $E_c = 10^{-14} (f_c/\text{Hz})$ eV from the approximate correspondence $eV \leftrightarrow 10^{14} \text{ Hz}$ true for $E = hf$. For the ordinary value of Planck constant electron's cyclotron energy would be for supernova magnetic field $B_S = 10^8$ Tesla equal to $E_c = 2 \times 10^{-2} (f_c/\text{Hz})$ eV and much below the energy scale $E = 100$ GeV.
- iii. The required scaling $\hbar \rightarrow r\hbar$ of Planck constant is obtained from the condition $E_c = E$ giving in the case of electron one can write

$$r = \left(\frac{E}{E_c}\right)^2 \times = \frac{B_E}{B_S} \times \frac{\hbar e B_E}{m_e^2} .$$

The dimensionless parameter $\hbar e B_E / m_e^2 = 1.2 \times 10^{-14}$ follows from $m_e = .5$ MeV. The estimate gives $r \sim 2 \times 10^{12}$. Values of Planck constant of this order of magnitude and even larger ones appear in TGD inspired model of brain but in this case magnetic field is Earth's magnetic field and the large thickness of the flux tube makes possible to satisfy the quantization of magnetic flux in which scaled up \hbar defines the unit.

To sum up, large values of Planck constant would be absolutely essential making possible high energy cosmic rays and just the presence of high energy cosmic rays could be seen as an experimental support for the hierarchy of Planck constants. The acceleration mechanism of cosmic rays are poorly understood and TGD option predicts that there is no acceleration mechanism to search for.

9.8 Inflation and TGD

The comparison of TGD with inflationary cosmology combined with new results about TGD inspired cosmology provides fresh insights to the relationship of TGD and standard approach and shows how TGD cures the lethal diseases of the eternal inflation. Very roughly: the replacement of the energy of the scalar field with magnetic energy replaces eternal inflation with a fractal quantum critical cosmology allowing to see more sharply the TGD counterpart of inflation and accelerating expansion as special cases of criticality. Wikipedia gives a nice overall summary inflationary cosmology [E11] and I recommend it to the non-specialist physics reader as a manner to refresh his or her memory.

9.8.1 Brief summary of the inflationary scenario

Inflationary scenario relies very heavily on rather mechanical unification recipes based on GUTs. Standard model gauge group is extended to a larger group. This symmetry group breaks down to standard model gauge group in GUT scale which happens to correspond to CP_2 size scale. Leptons and quarks are put into same multiplet of the gauge group so that enormous breaking of symmetries occurs as is clear from the ratio of top quark mass scale and neutrino mass scale. These unifiers want however a simple model allowing to calculate so that neither aesthetics nor physics does not matter. The instability of proton is one particular prediction. No decays of proton in the predicted manner have been observed but this has not troubled the gurus. As a matter fact, even Particle Data Tables tell that proton is not stable! The lobbies of GUTs are masters of their profession!

One of the key features of GUT approach is the prediction Higgs like fields. They allow to realize the symmetry breaking and describe particle massivation. Higgs like scalar fields are also the key ingredient of the inflationary scenario and inflation goes to down to drain tub if Higgs is not found at LHC. It is looking more and more probable that this is indeed the case. Inflation has

endless variety of variants and each suffers from some drawback. In this kind of situation one would expect that it is better to give up but it has become a habit to say that inflation is more than a theory, it is a paradigm. When superstring models turned out to be a physical failure, they did not same thing and claimed that super string models are more like a calculus rather than mere physical theory.

The problems that inflation was proposed to solve

The basic problems that inflation was proposed to solve are magnetic monopole problem, flatness problem, and horizon problem. Cosmological principle is a formulation for the fact that cosmic microwave radiation is found to be isotropic and homogenous in an excellent approximation. There are fluctuations in CMB believed to be Gaussian and the prediction for the spectrum of these fluctuations is an important prediction of inflationary scenarios.

- (a) Consider first the horizon problem. The physical state inside horizon is not causally correlated with that outside it. If the observer today receives signals from a region of past which is much larger than horizon, he should find that the universe is not isotropic and homogenous. In particular, the temperature of the microwave radiation should fluctuate wildly. This is not the case and one should explain this.

The basic idea is that the potential energy density of the scalar field implies exponential expansion in the sense that the "radius" of the Universe increases with an exponential rate with respect to cosmological time. This kind of Universe looks locally like de-Sitter Universe. This fast expansion smooths out any inhomogenities and non-isotropies inside horizon. The Universe of the past observed by a given observer is contained within the horizon of the past so that it looks isotropic and homogenous.

- (b) GUTs predict a high density of magnetic monopoles during the primordial period as singularities of non-abelian gauge fields. Magnetic monopoles have not been however detected and one should be able to explain this. The idea is very simple. If Universe suffers an exponential expansion, the density of magnetic monopoles gets so diluted that they become effectively non-existent.
- (c) Flatness problem means that the curvature scalar of 3-space defined as a hyper-surface with constant value of cosmological time parameter (proper time in local rest system) is vanishing in an excellent approximation. de-Sitter Universe indeed predicts flat 3-space for a critical mass density. The contribution of known elementary particles to the mass density is however much below the critical mass density so that one must postulate additional forms of energy. Dark matter and dark energy fit the bill. Dark energy is very much analogous to the vacuum energy of Higgs like scalar fields in the inflationary scenario but the energy scale of dark energy is by 27 orders of magnitude smaller than that of inflation, about 10^{-3} eV.

Evolution of inflationary models

The inflationary models developed gradually more realistic.

- (a) Alan Guth was the first to realize that the decay of false (unstable) vacuum in the early universe could solve the problem posed by magnetic monopoles. What would happen would be the analog of super-cooling in thermodynamics. In super-cooling the phase transition to stable thermodynamical phase does not occur at the critical temperature and cooling leads to a generation of bubbles of the stable phase which expand with light velocity.

The unstable super-cooled phase would locally correspond to exponentially expanding de-Sitter cosmology with a non-vanishing cosmological constant and high energy density assignable to the scalar field. The exponential expansion would lead to a dilution of the magnetic monopoles and domain walls. The false vacuum corresponds to a value of Higgs field for which the symmetry is not broken but energy is far from minimum. Quantum tunneling would generate regions of true vacuum with a lower energy and expanding with a velocity of light. The natural hope would be that the energy of the false vacuum would

generate radiation inducing reheating. Guth however realized that nucleation does not generate radiation. The collisions of bubbles do so but the rapid expansion masks this effect.

- (b) A very attractive idea is that the energy of the scalar field transforms to radiation and produces in this manner what we identify as matter and radiation. To realize this dream the notion of slow-roll inflation was proposed. The idea was that the bubbles were not formed at all but that the scalar field gradually rolled down along almost flat hill. This gives rise to an exponential inflation in good approximation. At the final stage the slope of the potential would come so steep that reheating would take place and the energy of the scalar field would transform to radiation. This requires a highly artificial shape of the potential energy. There is also a fine tuning problem: the predictions depend very sensitively on the details of the potential so that strictly speaking there are no predictions anymore. Inflaton should have also a small mass and represent new kind of particle.
- (c) The tiny quantum fluctuations of the inflaton field have been identified as the seed of all structures observed in the recent Universe. These density fluctuations make them visible also as fluctuations in the temperature of the cosmic microwave background and these fluctuations have become an important field of study (WMAP).
- (d) In the hybrid model of inflation there are two scalar fields. The first one gives rise to slow-roll inflation and second one puts end to inflationary period when the first one has reached a critical value by decaying to radiation. It is of course imagine endless number of speculative variants of inflation and Wikipedia article summarizes some of them.
- (e) In eternal inflation the quantum fluctuations of the scalar field generate regions which expand faster than the surrounding regions and gradually begin to dominate. This means that there is eternal inflation meaning continual creation of Universes. This is the basic idea behind multiverse thinking. Again one must notice that scalar fields are essential: in absence of them the whole vision falls down like a card house.

The basic criticism of Penrose against inflation is that it actually requires very specific initial conditions and that the idea that the uniformity of the early Universe results from a thermalization process is somehow fundamentally wrong. Of course, the necessity to assume scalar field and a potential energy with a very weird shape whose details affect dramatically the observed Universe, has been also criticized.

9.8.2 Comparison with TGD inspired cosmology

It is good to start by asking what are the empirical facts and how TGD can explain them.

What about magnetic monopoles in TGD Universe?

Also TGD predicts magnetic monopoles. CP_2 has a non-trivial second homology and second geodesic sphere represents a non-trivial element of homology. Induced Kähler magnetic field can be a monopole field and cosmic strings are objects for which the transversal section of the string carries monopole flux. The very early cosmology is dominated by cosmic strings carrying magnetic monopole fluxes. The monopoles do not however disappear anywhere. Elementary particles themselves are string like objects carrying magnetic charges at their ends identifiable as wormhole throats at which the signature of the induced metric changes. For fermions the second end of the string carries neutrino pair neutralizing the weak isospin. Also color confinement could involve magnetic confinement. These monopoles are indeed seen: they are essential for both the screening of weak interactions and for color confinement!

The origin of cosmological principle

The isotropy and homogeneity of cosmic microwave radiation is a fact as are also the fluctuations in its temperature as well as the anomalies in the fluctuation spectrum suggesting the presence of large scale structures. Inflationary scenarios predict that fluctuations correspond to those

of nearly gauge invariant Gaussian random field. The observed spectral index measuring the deviation from exact scaling invariance is consistent with the predictions of inflationary scenarios.

Isotropy and homogeneity reduce to what is known as cosmological principle. In general relativity one has only local Lorentz invariance as approximate symmetry. For Robertson-Walker cosmologies with sub-critical mass density one has Lorentz invariance but this is due to the assumption of cosmological principle - it is not a prediction of the theory. In inflationary scenarios the goal is to reduce cosmological principle to thermodynamics but fine tuning problem is the fatal failure of this approach.

In TGD inspired cosmology [K73] cosmological principle reduces sub-manifold gravity in $H = M^4 \times CP_2$ predicting a global Poincare invariance reducing to Lorentz invariance for the causal diamonds. This represents an extremely important distinction between TGD and GRT. This is however not quite enough since it predicts that Poincare symmetries treat entire partonic 2-surfaces at the end of CD as points rather than affecting on single point of space-time. More is required and one expects that also now finite radius for horizon in very early Universe would destroy the isotropy and homogeneity of 3 K radiation. The solution of the problem is simple: cosmic string dominated primordial cosmology has infinite horizon size so that arbitrarily distance regions are correlated. Also the critical cosmology, which is determined part from the parameter determining its duration by its imbeddability, has infinite horizon size. Same applies to the asymptotic cosmology for which curvature scalar is extremized.

The hierarchy of Planck constants [K30] and the fact that gravitational space-time sheets should possess gigantic Planck constant suggest a quantum solution to the problem: quantum coherence in arbitrary long length scales is present even in recent day Universe. Whether and how this two views about isotropy and homogeneity are related by quantum classical correspondence, is an interesting question to ponder in more detail.

Three-space is flat

The flatness of three-space is an empirical fact and can be deduced from the spectrum of microwave radiation. Flatness does not however imply inflation, which is much stronger assumption involving the questionable scalar fields and the weird shaped potential requiring a fine tuning. The already mentioned critical cosmology is fixed about the value value of only single parameter characterizing its duration and would mean extremely powerful predictions since just the imbeddability would fix the space-time dynamics almost completely.

Exponentially expanding cosmologies with critical mass density do not allow imbedding to $M^4 \times CP_2$. Cosmologies with critical or over-critical mass density and flat 3-space allow imbedding but the imbedding fails above some value of cosmic time. These imbeddings are very natural since the radial coordinate r corresponds to the coordinate r for the Lorentz invariant $a=\text{constant}$ hyperboloid so that cosmological principle is satisfied.

Can one imbed exponentially expanding sub-critical cosmology? This cosmology has the line element

$$ds^2 = dt^2 - ds_3^2 \quad , \quad ds_3^2 = \sinh^2(t) d\Omega_3^2 \quad ,$$

where ds_3^2 is the metric of the $a = \text{constant}$ hyperboloid of M_+^4 (future light-cone).

- (a) The simplest imbedding is as vacuum extremal to $M^4 \times S^2$, S^2 the homologically trivial geodesic sphere of CP_2 . The imbedding using standard coordinates (a, r, θ, ϕ) of M_+^4 and spherical coordinates (Θ, Φ) for S^2 is to a geodesic circle (the simplest possibility)

$$\Phi = f(a) \quad , \quad \Theta = \pi/2 \quad .$$

- (b) $\Phi = f(a)$ is fixed from the condition

$$a = \sinh(t) \quad ,$$

giving

$$g_{aa} = (dt/da)^2 = \frac{1}{\cosh^2(t)}$$

and from the condition for the g_{aa} as a component of induced metric tensor

$$g_{aa} = 1 - R^2 \left(\frac{df}{da} \right)^2 = \frac{1}{\cosh^2(t)} .$$

(c) This gives

$$\frac{df}{da} = \pm \frac{1}{R} \times \tanh(t)$$

giving $f(a) = (\cosh(t) - 1)/R$. Inflationary cosmology allows imbedding but this imbedding cannot have a flat 3-space and therefore cannot make sense in TGD framework.

Replacement of inflationary cosmology with critical cosmology

In TGD framework inflationary cosmology is replaced with critical cosmology. The vacuum extremal representing critical cosmology is obtained has 2-D CP_2 projection- in the simplest situation geodesic sphere. The dependence of Φ on r and Θ on a is fixed from the condition that one obtains flat 3- metric

$$\frac{a^2}{1+r^2} - R^2 \sin^2(\Theta) \left(\frac{d\Phi}{dr} \right)^2 = a^2 .$$

This gives

$$\sin(\Theta) = \pm ka , \quad \frac{d\Phi}{dr} = \pm \frac{1}{kR} \frac{r}{\sqrt{1+r^2}} .$$

The imbedding fails for $|ka| > 1$ and is unique apart from the parameter k characterizing the duration of the critical cosmology. The radius of the horizon is given by

$$R = \int \frac{1}{a} \sqrt{1 - \frac{R^2 k^2}{1 - k^2 a^2}}$$

and diverges. This tells that there are no horizons and therefore cosmological principle is realized. Infinite horizon radius could be seen as space-time correlate for quantum criticality implying long range correlations and allowing to realize cosmological principle. Therefore thermal realization of cosmological principle would be replaced with quantum realization in TGD framework predicting long range quantal correlations in all length scales. Obviously this realization is a in well-defined sense the diametrical opposite of the thermal realization. The dark matter hierarchy is expected to correspond to the microscopic realization of the cosmological principle generating the long range correlations.

Critical cosmology could describe the phase transition increasing Planck constant associated with a magnetic flux tube leading to its thickening. Magnetic flux would be conserved and the magnetic energy for the thickened portion would be reduced via its partial transformation to radiation giving rise to ordinary and dark matter.

Fractal hierarchy of cosmologies within cosmologies

Many-sheeted space-time leads to a fractal hierarchy of cosmologies within cosmologies. In zero energy ontology the realization is in terms of causal diamonds within causal diamonds with causal diamond identified as intersection of future and past directed light-cones. One can say that everything can be created from vacuum. The temporal distance between the tips of CD is given as an integer multiple of CP_2 time in the most general case and boosts of CD s are allowed.

There are also other moduli associated with CD and discretization of the moduli parameters is strongly suggestive.

Critical cosmology corresponds to a negative value of "pressure" so that it also gives rise to accelerating expansion. This suggests strongly that both the inflationary period and the accelerating expansion period which is much later than the inflationary period correspond to critical cosmologies differing from each other by scaling. Continuous cosmic expansion is replaced with a sequence of discrete expansion phases in which the Planck constant assignable to a magnetic flux quantum increases and implies its expansion. This liberates magnetic energy as radiation so that a continual creation of matter takes place in various scales.

This fractal hierarchy is the TGD counterpart for the eternal inflation. This fractal hierarchy implies also that the TGD counterpart of the inflationary period is just a scaled up invariant of critical cosmologies within critical cosmologies. Of course, also radiation and matter dominated phases as well as asymptotic string dominated cosmology are expected to be present and correspond to cosmic evolutions within given CD .

Vacuum energy density as magnetic energy of magnetic flux tubes and accelerating expansion

TGD allows a more microscopic view about cosmology based on the vision that the primordial period is dominated by cosmic strings which during cosmic evolution develop 4-D M^4 projection meaning that the thickness of the M^4 projection defining the thickness of the magnetic flux tube gradually increases [K73]. The magnetic tension corresponds to negative pressure and can be seen as a microscopic cause of the accelerated expansion. Magnetic energy is in turn the counterpart for the vacuum energy assigned with the inflaton field. The gravitational Planck constant assignable to the flux tubes mediating gravitational interaction nowadays is gigantic and they are thus in the macroscopic quantum phase. This explains the cosmological principle at the quantum level.

The phase transitions inducing the boiling of the magnetic energy to ordinary matter are possible. What happens is that the flux tube suffers a phase transition increasing its radius. This however reduces the magnetic energy so that part of the magnetic energy must transform to ordinary matter. This would give rise to the formation of stars and galaxies. This process is the TGD counterpart for the re-heating transforming the potential energy of the inflaton to radiation. The local expansion of the magnetic flux could be described in good approximation by critical cosmology since quantum criticality is in question.

One can of course ask whether inflationary cosmology could describe the transition period and critical cosmology could correspond only to the outcome. This does not look very attractive an idea since the CP_2 projections of these cosmologies have dimension $D=1$ and $D=2$ respectively.

In the TGD framework the fluctuations of the cosmic microwave background correspond to mass density gradients assignable to the magnetic flux tubes. An interesting question is whether the flux tubes could reveal themselves as a fractal network of linear structures in the CMB. The prediction is that galaxies are like pearls in a necklace: smaller cosmic strings around long cosmic strings. The model discussed for the formation of stars and galaxies discussed in the previous section gives a more detailed view about this.

What is the counterpart of the cosmological constant in the TGD framework?

In the TGD framework cosmological constants emerge when one asks what might be the GRT limit of TGD [K85], [L8]. Space-time surface decomposes into regions with both Minkowskian and Euclidian signature of the induced metric and Euclidian regions have interpretation as counterparts of generalized Feynman graphs. Also the GRT limit must allow space-time regions with Euclidian signature of the metric - in particular CP_2 itself - and this requires a positive cosmological constant in these regions. The action principle is naturally the Maxwell-Einstein action with a cosmological constant which is vanishing in Minkowskian regions and very large in Euclidian regions of space-time. Both the Reissner-Nordström metric and CP_2 are solutions of the field equations with

deformations of CP_2 representing the GRT counterparts of Feynman graphs. The average value of the cosmological constant is very small and of correct order of magnitude since only Euclidian regions contribute to the spatial average. This picture is consistent with the microscopic picture based on the identification of the density of magnetic energy as vacuum energy since Euclidian particle like regions are created as magnetic energy transforms to radiation.

Dark energy and cosmic consciousness

The hierarchy of Planck constants makes possible macroscopic quantum coherence in arbitrarily long scales. Macroscopic quantum coherence is essential for life and the notion of magnetic body is central in TGD inspired biology. For instance, the braiding of flux tubes making possible topological quantum computation like processes [K29]. The findings of Peter Gariaev [I8, I9, I13] provide support for the notion of magnetic body containing dark matter [K2]. The notion of magnetic body also inspires science fictive ideas like remote replication of DNA [K97] for which there is also some support and which could be essential for understanding water memory [I11, I7].

The gravitational Planck constant $\hbar_{gr} = GM_1M_2/v_0$ (v_0 is dimensionless parameter in units for which $c = 1$ but has interpretation as velocity) assumed in the model of planetary system based on Bohr orbitology [K72, K61] is assigned to the magnetic flux quanta mediating gravitational interaction between objects with masses M_1 and M_2 ($M_1 = M_2$ for self gravitation). For these values of Planck constant the quantum scales are gigantic. Even for gravitational magnetic flux tubes connecting electron with Sun, the Compton length would be of the order of the radius of Sun. If there are ordinary particles at these flux tubes, their Compton length is enormous and their density is essentially constant.

The fractality of TGD Universe and of the magnetic flux tube hierarchy forces to ask whether intelligent consciousness could be possible in cosmic scales and be based on the Indra's net of the magnetic flux tubes. This cosmic nervous system would carry dark energy as magnetic energy with magnetic tension responsible for the negative "pressure" causing accelerated expansion. This Indra's web would act as super-intelligence taking the role of God by creating stars and galaxies by transforming magnetic energy to radiation and matter in phase transitions increasing the Planck constant and driving the evolution of this cosmic intelligence. In inflationary scenario inflaton field would have similar role. In zero energy ontology there is no deep reason preventing for the creation of entire sub-cosmologies from vacuum.

9.9 Matter-antimatter asymmetry, baryo-genesis, lepto-genesis, and TGD

The generation of matter-antimatter asymmetry is still poorly understood. There exists a multitude of models but no convincing one. In TGD framework the generation of matter-antimatter asymmetry can be explained in terms of cosmic strings carrying dark energy identified as Kähler magnetic energy. Their decay to ordinary and dark matter would be the analog for the decay of the inflaton field to matter and the asymmetry would be generated in this process. The details of the process have not been considered hitherto.

The stimulus for constructing a general model for this process came from attempt to understand the notion of sphaleron [B16] claimed to allow a non-perturbative description for a separate non-conservation of baryon and lepton numbers in standard model. The separate non-conservation of B and L would make possible models of baryo-genesis and even lepto-genesis assuming that in the primordial situation only right-handed inert neutrinos are present. To my opinion these models however fail mathematically because they equate the non-conservation of axial fermion numbers - which is on a mathematically sound basis - with the non-conservation of fermion numbers. This kind of assumption is unjustified and to my opinion is misuse of the attribute "non-perturbative".

The basic vision about lepto-genesis followed by baryo-genesis is however very attractive. This even more so because right-handed neutrino is in a completely unique role in TGD Universe.

The obvious question therefore is whether this vision could make sense also in TGD framework. It would be wonderful if cosmic strings - infinitely thin Kähler magnetic flux tubes carrying magnetic monopole field, which later develop finite sized and expanding M^4 projection - carrying only right-handed neutrinos were the fundamental objects from which matter would have emerged in a manner analogous to the decay of vacuum expectations of instanton fields. Even better, Kähler magnetic energy has interpretation as dark energy and magnetic tension gives rise to the negative "pressure" inducing accelerated expansion of the Universe.

The basic question is whether B and L are conserved separately or not. In TGD Universe one can consider two options depending on the answer to this question. For option I - the "official" version of TGD - quarks and leptons correspond to opposite 8-D chiralities of the induced spinor fields and B and L are conserved separately. For option II [K23] only leptonic spinor fields would be fundamental, and the idea is that quarks could be fractionally charged leptons. This option could lead to genuine baryo-genesis, and in the simplest model baryons would be generated from 3-leptons as 3-sheeted structures for which fractionization of color hyper-charge occurs. Leptonic imbedding space spinors moving in triality zero color partial waves would be replaced with triality ± 1 partial waves assigned with quarks. Whether this replacement is on a mathematically sound basis, is far from obvious since induced spinor fields at space-time level would couple to induced spinor fields with leptonic couplings.

In any case, one can check whether leptogenesis, baryogenesis, and matter antimatter asymmetry are possible for either of both of these options. It turns out that for both option I and II one can construct simple model in terms for the generation of quarks from leptons via emission of lepto-quarks analogous to gauge bosons but differing from their counterparts in GUTs. Option II allows also genuine baryogenesis from leptons. The conclusion is that the "official" version of TGD predicting separate conservation of B and L allows an elegant vision about the generation of matter from cosmic strings containing only right-handed neutrinos in the initial states.

9.9.1 Background

A brief summary about conditions for the generation of matter-antimatter asymmetry and some of existing theories explaining it is in order.

Basic conditions for the generation of matter-antimatter asymmetry by baryon number generating interaction

The basic conditions for the generation of matter-antimatter asymmetry by baryon number generating interaction [B2] were deduced by Saharov and are following.

- (a) Baryon number non-conservation.
- (b) C breaking and CP breaking. Matter-antimatter asymmetry requires these symmetry breakings.
- (c) Thermal non-equilibrium which naturally corresponds to a phase transition. In a typical cosmological situation the reactions responsible for preserving thermal equilibrium become slower than the rate for the cosmological expansion so that the particles participating in the reactions decouple from each other and from thermal equilibrium. Otherwise these reactions destroy matter-antimatter asymmetry.

Also scenarios in which baryon number and lepton number are conserved are possible - TGD in its standard form allows one such option. The basic idea is that the universe decomposes into regions dominated by matter or antimatter. If slight matter-antimatter asymmetries - necessarily of opposite sign - are generated in region and its environment, the annihilation of particles and antiparticles leads to a situation in which there is only matter or antimatter present in both regions. If cosmic strings correspond to carriers of dark energy decaying to dark matter, they correspond naturally to the regions, where the asymmetry is generated. These cosmic strings could correspond "big" cosmic strings (magnetic flux tubes) going through large voids or the strings containing galaxies like pearls in necklace along them [K24] [L7]. Cosmic strings would

serve as seats of antimatter whereas the surrounding regions would contain matter. What is lacking is a more detailed view about how cosmic strings burn to ordinary and dark matter and the identification of an exact mechanism for the generation of matter-antimatter asymmetry.

Generation of matter-antimatter asymmetry in GUTs and standard model

Most of models for the generation of matter anti-matter asymmetry rely on GUT philosophy and give up the assumption about separate conservation of B and L so that these theories are also theories of baryo-genesis (for the theories of baryo-genesis see the article by Riotto [B60]). For GUTs the non-conservation is present at the level of action but there is also a proposal that standard model could accommodate the non-conservation non-perturbatively.

- (a) In a typical model B and L are not conserved separately. Only B-L is conserved (the convention is that proton has $B=1$, and electron $L=1$). B and L are defined as vectorial fermion numbers. Axial B and L are not conserved for massive fermions and Higgs mechanism leads to the massivation of a theory which is originally massless.
- (b) In GUTs one arranges quarks and leptons of given generation into same multiplet. This implies that B and L are not conserved separately whereas B-L is. The exchanges of lepto-quarks (gauge bosons) assumed to have mass of order 10^{-4} Planck masses (of order CP_2 mass) induce proton decay. No proton decays have been observed yet and this has led to a fine-tuning of the parameters of these theories to avoid too fast proton decay.

Some theoreticians believe that even standard model could allow to understand baryo-genesis and generation of matter-antimatter asymmetry. Instanton [B8] and sphaleron [B16] (see also the introductory article about sphalerons [B44] and conference slides [B59] about instantons/sphalerons and possible new physics within standard model) are the key notions of this approach. Perturbative approach to standard model predicts that both vectorial and axial quark and lepton numbers are separately conserved for massless fermions. The non-conservation of B and L is claimed to have a non-perturbative origin. The picture is roughly following.

- (a) Axial fermion numbers are not conserved for massive fermions even when the mass results from Higgs mechanism. Non-conservation is due to the fact that axial gauge symmetries are not genuine symmetries quantum mechanically because the integration measure for the path integral is not invariant under the axial gauge symmetries for which left and right handed fermions have opposite gauge charges.
- (b) By using refined topological arguments one can express the divergence $D_\mu A^\mu$ for the axial fermion current in terms of so called instanton density for the gauge field [B6]. Each fermion family gives a similar contribution to the divergence. One can calculate the changes of axial fermion numbers for an instanton connecting two states as the integral of instanton density reducing to the difference of so called Chern-Simons charges for final and initial field configurations.

A numerical study of the situation using lattice gauge theories is possible [B30] and provides information about rates for the appearance of instantons. Axial B-L is still conserved because the divergence of axial current is same for all fermions. Anomaly argument does not however force the non-conservation vectorial B and L (briefly B and L) and perturbatively they are conserved: here the weakness of the standard model approach obviously lies.

- (c) As noticed, the notion of instantons is crucial for the approach. Instantons are solutions of pure YM field equations (without Higgs field) in 4-D Euclidian 4-sphere S^4 or Euclidian space E^4 : the Wick rotation to M^4 is of course mathematically and physically questionable step. Instantons connected two field configuration characterized by different Chern-Simons charges. The change of the Chern-Simons charge is integer valued. One can say that instantons transform two topologically non-equivalent vacua to each other. The proposed interpretation is that instanton transforms incoming Dirac sea so that filled vacancy representing fermion with definite handedness becomes superposition of a hole and filled vacancy (fermions of opposite handedness). This would lead to the non-conservation of axial fermion numbers. It is important to stress again that the fermion numbers are axial - not vectorial-

and that fermion number non-conservation does not follow from the presence of instantons alone.

- (d) The notion of sphalerons is a related concept. Sphalerons are static but unstable solutions of YM equations in Euclidian space E^4 in presence of Higgs field and are interpreted as a signature for the phase transition leading to generation of baryons from leptons. Since in Euclidian metric time and space do not differ in any manner, one can interpret one of the spatial directions as time direction so that the situation becomes dynamical. Since there is a change of the sign of the Higgs vacuum expectation between diametrically opposite points of sphere S^3 at infinity, there is also a change of Higgs vacuum expectation in time direction. With a sufficient amount of good will one can say that sphaleron connects to in-equivalent local Higgs vacua. Sphaleron is hoped to give a simplified description of the situation, which might have something to do with reality.
- (e) The vision about non-perturbative breaking of baryon conservation has inspired models for the generation of matter-antimatter asymmetry and for how originally purely leptonic state generates baryons.

These models can be however criticized for sloppy mathematics.

- (a) The additional assumption that the change of the axial fermion number equals to the change of the vectorial fermion number is highly questionable and actually forces non-conservation of B and L by hand. To me this assumption looks like a misuse of the attribute "non-perturbative". This assumption can hold true only if one assumes that the fermionic handedness correlates with the sign of ΔQ_{C-S} . The instanton region would contain only left or right handed fermions depending on the sign of the integer characterizing instanton.
- (b) It is difficult to imagine what the non-conservation of (vectorial) B and L could mean in terms of particle reactions. Why not to be happy with what good mathematics gives: B and L are conserved and only axial fermion numbers fail to do so? This is perfectly natural since axial fermion numbers are opposite for right and left handed fermions. If this is accepted, baryo-genesis and related generation of matter-antimatter asymmetry are impossible in standard model framework.
- (c) Also the allowance of anomalies in path integral measure is questionable. For instance, in super string models the basic condition selecting the various candidates is that anomalies are absent.

The idea that leptons could transform to baryons in or without presence of instantons and at the same time generate matter-antimatter asymmetry is very attractive, and one can wonder whether one could find a more coherent theoretical framework allowing this. The most ambitious models based on a small modification of it assume the existence of inert right-handed neutrinos (for which there is some cosmological support). They would have been the only particles present during the primordial phase and would have generated leptons, which in turn have generated baryons by instantons. This idea is especially interesting from TGD point of view since right-handed neutrinos are in completely exceptional role in TGD Universe and the phase consisting of them possesses 4-D generalization of conformal SUSY (much larger symmetry algebra than ordinary super-conformal algebra of M^4) so that the generation of matter from right handed neutrinos would have interpretation as breaking of this gigantic super-conformal symmetry.

9.9.2 Could TGD allow matter-antimatter asymmetry and baryo-genesis?

What makes the idea about non-conservation of B attractive is that TGD allows two variants.

- (a) For Option I quarks and leptons correspond to different chiralities of H spinors. Chirality is now not M^4 chirality (handedness) but 8-D H -chirality. B and L are separately conserved and proton is stable against decays predicted by GUTs.

A possible but rather weak objection is following. The naive expectation is that various bosons come in two varieties. Vector bosons in 8-D sense would couple to 8-D vector

currents and thus have same coupling to both quarks and leptons. Axial bosons in 8-D sense would couple to 8-D axial currents and have opposite couplings to quarks and leptons. Axial and vectorial bosons can of course mix but one would expect more bosons than observed (W bosons are vectorial in 8-D sense, photon and Z^0 couple are mixtures of axial and vector bosons, and gluons in TGD framework couple vectorially (also leptons are predicted to have colored excitations)).

- (b) For Option II only leptons appear as fundamental fermions. Leptons instead of quarks are favored by the supersymmetry (actually super-conformal symmetry) generated by right-handed neutrinos. In fractional quantum Hall effect (FQHE) charge fractionization takes place and this inspires the question whether quarks inside hadrons could be leptons with fractional charge. I considered this alternative already around 2005 as a side product of work with hyper-finite factors of type II_1 [K23].

Charge fractionization would result from the replacement $Q_L \rightarrow Q_L - 1/3$ for antileptons. Lepton number would be the only conserved quantity and quarks and baryons could result by a phase transition in which leptons would somehow transform to quarks or to baryons.

This raises several questions. What charge fractionization means? What lepto-quarks could be? What is this phase transition?

Could the option assuming only leptonic spinors make sense?

The stability of proton supports Option I but since only lower bounds for proton lifetime can be deduced experimentally, one must be ready to consider also Option II.

- (a) One cannot deny the attractiveness of the idea that quarks could be fractionally charged variants of leptons. For this option the process leading to the generation of baryons would not break any conservation laws and the mathematically highly questionable anomalous path integral would not be needed. In fact, path integral over gauge fields is replaced with functional integral over 3-surfaces in TGD framework.
- (b) Right-handed neutrino behaves like inert neutrino and in TGD ν_R has a unique role. The reason is that the conservation of electric charge forces to assume that all fermions except purely right-handed neutrino are localized at 2-D surfaces, "string world sheets". Pure right-handed neutrino is delocalized at entire space-time sheets - which could be identifiable magnetic flux tubes assignable to elementary particles. ν_R can give rise to a SUSY, which is however not the $\mathcal{N} = 1$ SUSY considered usually - almost excluded at LHC at TeV energy scale. The reason is that 8-D spinors cannot be Majorana spinors [B17]. Right-handed neutrino obeys also maximal super-conformal symmetry extending 2-D conformal symmetry to $D = 4$ [K94] so that the generation of matter could be seen as a symmetry breaking.
- (c) One can indeed imagine a scenario in which right handed neutrinos mix with left-handed neutrinos localized at string world sheets. The weak interactions of left handed neutrinos (or actually mixtures of right and left handed neutrinos) would generate other leptons. Leptonic phase could in turn generate fractionally charged quarks (or baryons) and hadronization would lead to generation of baryons and other hadrons.

This vision can be coupled with the earlier proposal for how matter-antimatter asymmetry is generated. Right handed neutrinos could reside at magnetic flux tubes representing cosmic strings and the process leading to generation of leptons and quarks would take place here.

What it could be to be a fractionally charged lepton?

For option I quark-like and leptonic spinors appear at both space-time level and imbedding space level.

- (a) At space-time level one has second quantized induced spinor fields satisfying modified Dirac equation. The condition that modes have well-defined electromagnetic charge together

with the fact that classical W fields are present and mix different em charges implies that this condition can be satisfied only if the induced spinor fields are localized at 2-D surfaces - string world sheets. Right-handed neutrino is an exception and delocalized into entire space-time sheet. The functional integral over preferred extremals gives rise to a perturbative expansion in terms of fermionic propagators when one expresses the spinor modes as functionals of space-time sheet of preferred extremal [K94].

- (b) Imbedding space spinors identified as leptonic and quark spinors differ in one aspect only. Their coupling to CP_2 Kähler gauge potentials is $n = -1$ for quarks and $n = 3$ for leptons. Imbedding space spinors can be assigned to the center of mass degrees of partonic 2-surfaces (or possibly the position of the tip of CD associated with fermion). Spinor modes represent the ground states for the representations of the symplectic algebra of $\Delta M_{\pm}^4 \times CP_2$ and also for the representations of Kac-Moody algebra associated with isometries and deforming on the light-like orbits of partonic 2-surfaces at which the signature of the induced metric changes from Minkowskian to Euclidian.

For leptons the spinor harmonics correspond to triality zero ($t = 0$) color partial waves in CP_2 . For quarks the spinor harmonics correspond to $t = \pm 1$ color partial waves. These modes do not correspond directly to the physical quarks and leptons. States with correct correlation between electro-weak and color quantum numbers are obtained by allowing the action of the colored generators of the symplectic algebra on the physical states. The state construction is represented in [K48].

At the space-time level, where the fundamental spinorial dynamics takes place, the coupling of fermions to the Kähler gauge potential must be unique. If only single fermionic chirality is present, it must be either $n = 3$ or $n = -1$ and $n = 3$ is favored by the possible SUSY generated by right-handed neutrino.

What about imbedding space level? How could the above picture of option I change if one assumes that only leptonic spinors are present at the space-time level?

- (a) For Option I it is natural to assume that the induced space-time spinors correspond to imbedding space spinors with the same chirality and same value of n . Could one loosen this correspondence? Could imbedding space spinors, which are not second quantized, and are assigned to cm degrees of freedom, be associated with imbedding space spinor having both $n = -1$ and $n = 3$ for fermions.
- i. Are these two state basis orthogonal? Certainly not as CP_2 spinors. As vacua for WCW spinor fields this could be the case if there is some topological distinction between the 3-surfaces assignable with these state basis. The idea about fractionization of charges (color hyper-charge) suggests that for quark states the space-time surface are 3-valued maps of CP_2 to M^4 analogous to Riemann surface of $z^{1/3}$ so that a color hyper-charge rotation of 2π in CP_2 (say at homologically non-trivial geodesic sphere of CP_2 defining coordinates of the partonic 2-surface) does not lead to the original point and only the rotation by 6π does this. This would be an analog for spin fractionization. This could justify the use of quark spinor harmonics for the imbedding space spinors.
 - ii. Could the two state basis be non-orthogonal and provide alternative state basis? Many-quark states can correspond to many-lepton states only if the differences $N_q - N_{\bar{q}}$ of numbers of quarks and antiquarks is a multiple of 3 so that the many-fermion state has triality $t = 0$. Color confinement is consistent with this condition and implies it. This option does not look attractive and will not be assumed in the sequel.
- (b) A serious problem is caused by the $n = -1$ coupling of the induced leptonic spinor fields. Internal consistency could quite well force the imbedding space spinors to have the same coupling.

How leptons could transform directly to baryons for Option II?

If the direct transformation of leptons to quarks identified as fractionally charged leptons is possible, it must be non-perturbative in the sense that it involves several leptons and quarks

simultaneously in order to satisfy the conservation of color and em charge. Since the resulting many quark state must have a vanishing triality, the number of quarks and therefore also leptons must be a multiple of 3. The simplest situation corresponds to a transformation of 3 leptons to 3 quarks forming a color singlet - perhaps identifiable as baryon.

The geometric view about color spin fractionization suggests that three leptonic space-time sheets defining 1-fold coverings of CP_2 fuse to form a 3-fold covering of CP_2 (so that M^4 coordinates are 3-valued as functions of CP_2 coordinates). The proposed explanation for the effective hierarchy of Planck constants $\hbar_{eff} = n\hbar$ is in terms of n -furcations of 3-surface: the recent case might correspond $n = 3$. Each sheet of the covering would carry lepton number 1. These 3-quark states would be only a special case of more general states containing $n = 1, 2$ or 3 quarks at the 3-sheeted structure.

In the process transforming 3 anti-leptons to baryon - say proton - one unit of em charge must be carried away and W^+ boson could do this. In the reverse process proton would decay to 3 leptons and W^- boson. W^\pm boson must be virtual and absorbed by another particle so that weak interactions are also involved. The probability for this process must be very low, probably much lower than beta decay rate (I do not know whether possible decays of baryon to leptons and W boson have been studied). This means that the coupling for the fusion vertex must be very small.

If this picture is correct, the key non-perturbative element would be a phase transition changing the effective value of \hbar to $3\hbar$. These phase transitions for large values of n are essential in the TGD inspired model of living matter. There is also a proposal that gravitons possess a very large value of \hbar and decay to bursts of ordinary gravitons. This could explain the failure to observe gravitational waves [K61]. This mechanism forces to consider a geometric description of proton as a 3-sheeted structure presumably assignable to the magnetic body of proton.

It is too early to say whether this picture is consistent with the existing view about hadrons in which quarks space-time sheets are assumed to be connected by Kähler-magnetically charged color flux tubes. Also the question whether quarks understood as 3-sheeted structures containing only single quark could be allowed remains open. In any case, many-quark states must have triality zero so that quark number must be a multiple of 3.

Generation of matter-antimatter asymmetry without breaking the separate conservation of B and L

Cosmic strings dominate the TGD inspired cosmology [K73] during the primordial period after which a phase transition leading to radiation dominated cosmology takes place. The transformation of neutrinos to leptons inside cosmic strings which in turn decays to quarks and lepto-quarks which partially leak out from the system is an attractive mechanism for the generation of matter-antimatter asymmetry.

The mechanism to be discussed conserves B and L and thus works for option I. It works also for option II, if it makes sense to speak about quarks rather than only color singlet bound states of quarks formed as 3-sheeted structures with quark number 3, and treat quarks as independent objects. Many-quark states must however have quark number coming as a multiple of 3.

What can one say about the transformation of leptons to quarks by lepto-quark emission?

- (a) The charges of lepton and corresponding quark are different but this not a problem if one assumes the existence of lepto-quarks identified as gauge boson like states with quark (lepton with fractional charge) and lepton at opposite wormhole throats. For option I there is no reason why leptoquarks could not exist.
- (b) The most general assumption is that all possible combinations of quarks and leptons are allowed. Lepto-quarks qL and $\bar{q}\bar{L}$ have vanishing B-L for option I and vanishing L for option II: this makes them highly analogous to gauge bosons for option II. Lepto-quarks $q\bar{L}$ and $\bar{q}L$ have vanishing B+L for option I and have $L=2$ for option II. In the following only the option involving only qL and $\bar{q}\bar{L}$ is considered but the arguments generalize to the remaining cases trivially.

- (c) The transformation of antilepton to quark would take place by emission of lepto-quark $\bar{L}\bar{q}$ taking care of the conservation of various quantum numbers. The exchange of lepto-quarks is B and L conserving process and cannot lead to a decay of proton. It however predicts a new and presumably very slow decay channel for the decay of proton-antiproton pair to leptons.

In the transformation $e^- \rightarrow \bar{u}$ a lepto-quark e^-u with charge $-1/3$ is emitted. In the transformation $e^- \rightarrow \bar{d}$ lepto-quark e^-d with charge $-4/3$ is emitted. More generally, $L \rightarrow \bar{q}$ proceeds via the emission of Lq type lepto-quark. Note that the lepton number of the lepto-quark vanishes for option II so that it represents an ordinary gauge boson with vanishing fermion number.

- (d) What happens to the emitted lepto-quarks? The lepto-quark can decay to $L + q$ so that the situation is the original one plus quark antiquark pair unless the lepto-quark has leaked outside the cosmic string. If the decay occurs inside cosmic string, the process can continue and in principle single lepton or anti-lepton can generate a larger number of $q\bar{q}$ pairs. Kinematically these decays are not possible for ordinary on mass shell leptons but TGD allows the existence of scaled up copies of leptons, say leptons characterized by Mersenne prime M_{89} having mass scale about $2^{(127-89)/2}m_e \simeq 250$ GeV. These leptons could generate ordinary quarks through their decays.
- (e) This mechanism alone cannot generate matter-antimatter asymmetry. Suppose that the rates for the decays $\bar{L} \rightarrow q + \bar{L}\bar{q}$ are slightly lower than those for $L \rightarrow \bar{q} + qL$. A surplus of lepto-quarks Lq over $\bar{L}\bar{q}$ is generated. If there is a transfer of lepto-quarks Lq and their antiparticles from the interior of cosmic string to the environment and transfer rates are same, more Lq s are transferred and their decays generate a net density of quark and lepton numbers in the environment. Inside cosmic string net density of opposite sign is generated by B and L conservation.
- (f) If the decay rate of lepto-quark is of order g^2M with M of order CP_2 mass, leakage is possible if the M^4 projection of the cosmic string is below $1/g^2M_{CP_2}$. Therefore the process could become active after the cosmic string dominated primordial period and could be associated with the phase transition from string dominated phase to radiation dominated phase during which space-time sheets corresponding to preferred extremals with large 4-D M^4 projection in the transversal scale of cosmic string emerge. Since the process conserves B and L separately, it could however take place also in much longer p-adic length scales.

The masses of the lepto-quark could result from couplings to Higgs like bosons but the mass scale of the vacuum expectation value inside cosmic string corresponds to a rather small p-adic prime instead of M_{89} for weak interactions. Mersenne primes are the first guess for p-adic primes assignable to gauge bosons and $M_7 = 127$ is a reasonable guess for the p-adic prime during the transition to radiation dominated phases.

The conclusion is that lepto-quark mechanism works for both Option I and II and therefore Option II is not needed to understand generation of matter-antimatter asymmetry or even leptogenesis and baryogenesis. This does not of course mean that Option II would be necessarily excluded.

Generation of matter asymmetry accompanied with a genuine baryo-genesis for option II

One can also consider a generation of matter-antimatter asymmetry and baryo-genesis based on fusion of leptons to baryons by the proposed mechanism for the formation of baryons from anti-leptons at cosmic strings. If the rates for the fusion process are different for leptons and anti-leptons, a net density of baryon number is generated in environment.

Suppose that in the interior of cosmic string anti-leptons transform to baryons with a rate slightly higher than leptons to anti-baryons. As a consequence, the number densities of baryons and leptons become higher than those for anti-baryons and anti-leptons inside cosmic string. If the transfer rates for baryons and anti-baryons to environment are same, the outcome would be net density of baryon number in environment. The faster transfer of anti-leptons than leptons

from environment to cosmic string induced by the larger density gradient would induce net density of lepton number in environment. As a consequence, opposite net densities of B and L in environment and interior of string would be generated.

Could all matter be generated from right-handed neutrinos at magnetic flux tubes?

The idea about leptogenesis [B32] initiated from right-handed neutrinos and followed by baryogenesis [B60] is highly attractive. TGD leads to the vision that matter and dark matter has been generated from dark energy identified as Kähler magnetic energy for magnetic flux tubes which have evolved from cosmic strings by the gradual thickening of M^4 projection [L7]. I have not yet considered any detailed model for this process.

Right-handed neutrino has a unique role in TGD framework [K94] and an attractive idea is that during primordial phase - and perhaps even at magnetic flux tubes evolved from them - the physics started from something extremely simple and symmetric: only magnetic flux tubes containing right-handed neutrinos. This situation would correspond to a 4-D extension of super-conformal symmetry [K94], and the emergence of string world sheets would reduce this 4-D to super-conformal symmetry to ordinary 2-D one. Other fermions localized at string world sheets would have emerged only after the mixing of right handed neutrino to mixtures of left and right handed neutrinos localized at string worlds sheets. Neutrinos in turn would decay to charged leptons and W bosons by weak interactions. The decay $L \rightarrow \bar{q} + Lq$ in turn would have generated baryons and matter-antimatter asymmetry for both options. For option II also the direct fusion of leptons to baryons or more general color singlet quark triplets could have occurred.

One should construct a model for the mixing of right- and left-handed neutrinos.

- (a) Mixing should reduce to fermionic propagation and be dictated by the dynamics of the modified Dirac operator alone. The mixing amplitude would be obtained by calculating a transition amplitude between ν_R and ν_L located at partonic 2-surfaces at opposite ends of CD . This requires integration over CD inducing perturbation theory using fermionic propagator defined by the modified Dirac action with coupling to WCW degrees of freedom via the gauge coupling to induced CP_2 spinor connection. ν_R propagates 4-dimensionally and the other leptonic modes only 2-dimensionally. Also the mixing of lepton generations induced by the mixing of the topologies of fermion number carrying partonic 2-surfaces must be taken into account.
- (b) The overall parametrization at the QFT limit would be in terms of a generalization of CKM matrix, which is known to be non-trivial and force also neutrino massivation in turn forcing mixing of the right- and left-handed neutrinos.

Conclusions

The cautious conclusion is that option I - that is the "official" version of TGD identifying quarks and leptons and two chiralities of imbedding space spinors - leads to an elegant model for leptogenesis, baryogenesis, and generation of matter antimatter asymmetry and at the same time to a more detailed model for how the Kähler magnetic energy of magnetic flux tubes transforms to matter and dark matter. One cannot however exclude option II involving only leptons whose anyonic states would give rise to baryons.

9.10 Updated view about the hierarchy of Planck constants

The original hypothesis was that the hierarchy of Planck constants is real. In this formulation the imbedding space was replaced with its covering space assumed to decompose to a Cartesian product of singular finite-sheeted coverings of M^4 and CP_2 .

Few years ago came the realization that it could be only effective but have same practical implications. The basic observation was that the effective hierarchy need not be postulated

separately but follows as a prediction from the vacuum degeneracy of Kähler action. In this formulation Planck constant at fundamental level has its standard value and its effective values come as its integer multiples so that one should write $\hbar_{eff} = n\hbar$ rather than $\hbar = n\hbar_0$ as I have done. For most practical purposes the states in question would behave as if Planck constant were an integer multiple of the ordinary one. In this formulation the singular covering of the imbedding space became only a convenient auxiliary tool. It is no more necessary to assume that the covering reduces to a Cartesian product of singular coverings of M^4 and CP_2 but for some reason I kept this assumption.

The formulation based on multi-furcations of space-time surfaces to N branches. For some reason I assumed that they are simultaneously present. This is too restrictive an assumption. The N branches are very much analogous to single particle states and second quantization allowing all $0 < n \leq N$ -particle states for given N rather than only N -particle states looks very natural. As a matter fact, this interpretation was the original one, and led to the very speculative and fuzzy notion of N -atom, which I later more or less gave up. Quantum multi-furcation could be the root concept implying the effective hierarchy of Planck constants, anyons and fractional charges, and related notions- even the notions of N -nuclei, N -atoms, and N -molecules.

9.10.1 Basic physical ideas

The basic phenomenological rules are simple and there is no need to modify them.

- (a) The phases with non-standard values of effective Planck constant are identified as dark matter. The motivation comes from the natural assumption that only the particles with the same value of effective Planck can appear in the same vertex. One can illustrate the situation in terms of the book metaphor. Imbedding spaces with different values of Planck constant form a book like structure and matter can be transferred between different pages only through the back of the book where the pages are glued together. One important implication is that light exotic charged particles lighter than weak bosons are possible if they have non-standard value of Planck constant. The standard argument excluding them is based on decay widths of weak bosons and has led to a neglect of large number of particle physics anomalies [K84].
- (b) Large effective or real value of Planck constant scales up Compton length - or at least de Broglie wave length - and its geometric correlate at space-time level identified as size scale of the space-time sheet assignable to the particle. This could correspond to the Kähler magnetic flux tube for the particle forming consisting of two flux tubes at parallel space-time sheets and short flux tubes at ends with length of order CP_2 size.

This rule has far reaching implications in quantum biology and neuroscience since macroscopic quantum phases become possible as the basic criterion stating that macroscopic quantum phase becomes possible if the density of particles is so high that particles as Compton length sized objects overlap. Dark matter therefore forms macroscopic quantum phases. One implication is the explanation of mysterious looking quantal effects of ELF radiation in EEG frequency range on vertebrate brain: $E = hf$ implies that the energies for the ordinary value of Planck constant are much below the thermal threshold but large value of Planck constant changes the situation. Also the phase transitions modifying the value of Planck constant and changing the lengths of flux tubes (by quantum classical correspondence) are crucial as also reconnections of the flux tubes.

The hierarchy of Planck constants suggests also a new interpretation for FQHE (fractional quantum Hall effect) [K63] in terms of anyonic phases with non-standard value of effective Planck constant realized in terms of the effective multi-sheeted covering of imbedding space: multi-sheeted space-time is to be distinguished from many-sheeted space-time.

- (c) In astrophysics and cosmology the implications are even more dramatic if one believes that also \hbar_{gr} corresponds to effective Planck constant interpreted as number of sheets of multi-furcation. It was Nottale [E175] who first introduced the notion of gravitational Planck constant as $\hbar_{gr} = GMm/v_0$, $v_0 < 1$ has interpretation as velocity light parameter in units $c = 1$. This would be true for $GMm/v_0 \geq 1$. The interpretation of \hbar_{gr} in TGD framework

is as an effective Planck constant associated with space-time sheets mediating gravitational interaction between masses M and m . The huge value of \hbar_{gr} means that the integer \hbar_{gr}/\hbar_0 interpreted as the number of sheets of covering is gigantic and that Universe possesses gravitational quantum coherence in super-astronomical scales for masses which are large. This would suggest that gravitational radiation is emitted as dark gravitons which decay to pulses of ordinary gravitons replacing continuous flow of gravitational radiation.

It must be however emphasized that the interpretation of \hbar_{gr} could be different, and it will be found that one can develop an argument demonstrating how \hbar_{gr} with a correct order of magnitude emerges from the effective space-time metric defined by the anticommutators appearing in the modified Dirac equation.

- (d) Why Nature would like to have large effective value of Planck constant? A possible answer relies on the observation that in perturbation theory the expansion takes in powers of gauge couplings strengths $\alpha = g^2/4\pi\hbar$. If the effective value of \hbar replaces its real value as one might expect to happen for multi-sheeted particles behaving like single particle, α is scaled down and perturbative expansion converges for the new particles. One could say that Mother Nature loves theoreticians and comes in rescue in their attempts to calculate. In quantum gravitation the problem is especially acute since the dimensionless parameter GMm/\hbar has gigantic value. Replacing \hbar with $\hbar_{gr} = GMm/v_0$ the coupling strength becomes $v_0 < 1$.

9.10.2 Space-time correlates for the hierarchy of Planck constants

The hierarchy of Planck constants was introduced to TGD originally as an additional postulate and formulated as the existence of a hierarchy of imbedding spaces defined as Cartesian products of singular coverings of M^4 and CP_2 with numbers of sheets given by integers n_a and n_b and $\hbar = n\hbar_0$. $n = n_a n_b$.

With the advent of zero energy ontology, it became clear that the notion of singular covering space of the imbedding space could be only a convenient auxiliary notion. Singular means that the sheets fuse together at the boundary of multi-sheeted region. The effective covering space emerges naturally from the vacuum degeneracy of Kähler action meaning that all deformations of canonically imbedded M^4 in $M^4 \times CP_2$ have vanishing action up to fourth order in small perturbation. This is clear from the fact that the induced Kähler form is quadratic in the gradients of CP_2 coordinates and Kähler action is essentially Maxwell action for the induced Kähler form. The vacuum degeneracy implies that the correspondence between canonical momentum currents $\partial L_K/\partial(\partial_\alpha h^k)$ defining the modified gamma matrices [K94] and gradients $\partial_\alpha h^k$ is not one-to-one. Same canonical momentum current corresponds to several values of gradients of imbedding space coordinates. At the partonic 2-surfaces at the light-like boundaries of CD carrying the elementary particle quantum numbers this implies that the two normal derivatives of h^k are many-valued functions of canonical momentum currents in normal directions.

Multi-furcation is in question and multi-furcations are indeed generic in highly non-linear systems and Kähler action is an extreme example about non-linear system. What multi-furcation means in quantum theory? The branches of multi-furcation are obviously analogous to single particle states. In quantum theory second quantization means that one constructs not only single particle states but also the many particle states formed from them. At space-time level single particle states would correspond to N branches b_i of multi-furcation carrying fermion number. Two-particle states would correspond to 2-fold covering consisting of 2 branches b_i and b_j of multi-furcation. N -particle state would correspond to N -sheeted covering with all branches present and carrying elementary particle quantum numbers. The branches co-incide at the partonic 2-surface but since their normal space data are different they correspond to different tensor product factors of state space. Also now the factorization $N = n_a n_b$ occurs but now n_a and n_b would relate to branching in the direction of space-like 3-surface and light-like 3-surface rather than M^4 and CP_2 as in the original hypothesis.

In light of this the working hypothesis adopted during last years has been too limited: for some reason I ended up to propose that only N -sheeted covering corresponding to a situation in which all N branches are present is possible. Before that I quite correctly considered more

general option based on intuition that one has many-particle states in the multi-sheeted space. The erratic form of the working hypothesis has not been used in applications.

Multi-furcations relate closely to the quantum criticality of Kähler action. Feigenbaum bifurcations represent a toy example of a system which via successive bifurcations approaches chaos. Now more general multi-furcations in which each branch of given multi-furcation can multi-furcate further, are possible unless one poses any additional conditions. This allows to identify additional aspect of the geometric arrow of time. Either the positive or negative energy part of the zero energy state is "prepared" meaning that single n -sub-furcations of N -furcation is selected. The most general state of this kind involves superposition of various n -sub-furcations.

9.10.3 Basic phenomenological rules of thumb in the new framework

It is important to check whether or not the refreshed view about dark matter is consistent with existent rules of thumb.

- (a) The interpretation of quantized multi-furcations as WCW anyons explains also why the effective hierarchy of Planck constants defines a hierarchy of phases which are dark relative to each other. This is trivially true since the phases with different number of branches in multi-furcation correspond to disjoint regions of WCW so that the particles with different effective value of Planck constant cannot appear in the same vertex.
- (b) The phase transitions changing the value of Planck constant are just the multi-furcations and can be induced by changing the values of the external parameters controlling the properties of preferred extremals. Situation is very much the same as in any non-linear system.
- (c) In the case of massless particles the scaling of wavelength in the effective scaling of \hbar can be understood if dark n -photons consist of n photons with energy E/n and wavelength $n\lambda$.
- (d) For massive particle it has been assumed that masses for particles and their dark counterparts are same and Compton wavelength is scaled up. In the new picture this need not be true. Rather, it would seem that wave length are same as for ordinary electron.

On the other hand, p-adic thermodynamics predicts that massive elementary particles are massless most of the time. ZEO predicts that even virtual wormhole throats are massless. Could this mean that the picture applying on massless particle should apply to them at least at relativistic limit at which mass is negligible. This might be the case for bosons but for fermions also fermion number should be fractionalized and this is not possible in the recent picture. If one assumes that the n -electron has same mass as electron, the mass for dark single electron state would be scaled down by $1/n$. This does not look sensible unless the p-adic length defined by prime is scaled down by this fact in good approximation.

This suggests that for fermions the basic scaling rule does not hold true for Compton length $\lambda_c = \hbar/m$. Could it however hold for de-Broglie lengths $\lambda = \hbar/p$ defined in terms of 3-momentum? The basic overlap rule for the formation of macroscopic quantum states is indeed formulated for de Broglie wave length. One could argue that an $1/N$ -fold reduction of density that takes place in the delocalization of the single particle states to the N branches of the cover, implies that the volume per particle increases by a factor N and single particle wave function is delocalized in a larger region of 3-space. If the particles reside at effectively one-dimensional 3-surfaces - say magnetic flux tubes - this would increase their de Broglie wave length in the direction of the flux tube and also the length of the flux tube. This seems to be enough for various applications.

One important notion in TGD inspired quantum biology is dark cyclotron state.

- (a) The scaling $\hbar \rightarrow k\hbar$ in the formula $E_n = (n + 1/2)\hbar eB/m$ implies that cyclotron energies are scaled up for dark cyclotron states. What this means microscopically has not been obvious but the recent picture gives a rather clearcut answer. One would have k -particle state formed from cyclotron states in N -fold branched cover of space-time surface. Each branch would carry magnetic field B and ion or electron. This would give a total cyclotron

energy equal to kE_n . These cyclotron states would be excited by k -photons with total energy $E = khf$ and for large enough value of k the energies involved would be above thermal threshold. In the case of Ca^{++} one has $f = 15$ Hz in the field $B_{end} = .2$ Gauss. This means that the value of \hbar is at least the ratio of thermal energy at room temperature to $E = hf$. The thermal frequency is of order 10^{12} Hz so that one would have $k \simeq 10^{11}$. The number branches would be therefore rather high.

- (b) It seems that this kinds of states which I have called cyclotron Bose-Einstein condensates could make sense also for fermions. The dark photons involved would be Bose-Einstein condensates of k photons and wall of them would be simultaneously absorbed. The biological meaning of this would be that a simultaneous excitation of large number of atoms or molecules can take place if they are localized at the branches of N -furcation. This would make possible coherent macroscopic changes. Note that also Cooper pairs of electrons could be $n = 2$ -particle states associated with N -furcation.

There are experimental findings suggesting that photosynthesis involves delocalized excitations of electrons and it is interesting so see whether this could be understood in this framework.

- (a) The TGD based model relies on the assumption that cyclotron states are involved and that dark photons with the energy of visible photons but with much longer wavelength are involved. Single electron excitations (or single particle excitations of Cooper pairs) would generate negentropic entanglement automatically.
- (b) If cyclotron excitations are the primary ones, it would seem that they could be induced by dark n -photons exciting all n electrons simultaneously. n -photon should have energy of a visible photon. The number of cyclotron excited electrons should be rather large if the total excitation energy is to be above thermal threshold. In this case one could not speak about cyclotron excitation however. This would require that solar photons are transformed to n -photons in N -furcation in biosphere.
- (c) Second - more realistic looking - possibility is that the incoming photons have energy of visible photon and are therefore $n = 1$ dark photons delocalized to the branches of the N -furcation. They would induce delocalized single electron excitation in WCW rather than 3-space.

9.10.4 Charge fractionalization and anyons

It is easy to see how the effective value of Planck constant as an integer multiple of its standard value emerges for multi-sheeted states in second quantization. At the level of Kähler action one can assume that in the first approximation the value of Kähler action for each branch is same so that the total Kähler action is multiplied by n . This corresponds effectively to the scaling $\alpha_K \rightarrow \alpha_K/n$ induced by the scaling $\hbar_0 \rightarrow n\hbar_0$.

Also effective charge fractionalization and anyons emerge naturally in this framework.

- (a) In the ordinary charge fractionalization the wave function decomposes into sharply localized pieces around different points of 3-space carrying fractional charges summing up to integer charge. Now the same happens at the level of WCW ("world of classical worlds") rather than 3-space meaning that wave functions in E^3 are replaced with wave functions in the space-time of 3-surfaces (4-surfaces by holography implied by General Coordinate Invariance) replacing point-like particles. Single particle wave function in WCW is a sum of N sharply localized contributions: localization takes place around one particular branch of the multi-sheeted space time surface. Each branch carries a fractional charge q/N for teh analogs of plane waves.

Therefore all quantum numbers are additive and fractionalization is only effective and observable in a localization of wave function to single branch occurring with probability $p = 1/N$ from which one can deduce that charge is q/N .

- (b) This is consistent with the proposed interpretation of dark photons/gravitons since they could carry large spin and this kind of situation could decay to bunches of ordinary photons/gravitons. It is also consistent with electromagnetic charge fractionalization and fractionalization of spin.
- (c) The original - and it seems wrong - argument suggested what might be interpreted as a genuine fractionalization for orbital angular momentum and also of color quantum numbers, which are analogous to orbital angular momentum in TGD framework. The observation was that a rotation through 2π at space-time level moving the point along space-time surface leads to a new branch of multi-furcation and $N + 1$:th branch corresponds to the original one. This suggests that angular momentum fractionalization should take place for M^4 angle coordinate ϕ because for it 2π rotation could lead to a different sheet of the effective covering.

The orbital angular momentum eigenstates would correspond to waves $\exp(i\phi m/N)$, $m = 0, 2, \dots, N - 1$ and the maximum orbital angular momentum would correspond to the sum $\sum_{m=0}^{N-1} m/N = (N - 1)/2$. The sum of spin and orbital angular momentum be therefore fractional.

The different prediction is due to the fact that rotations are now interpreted as flows rotating the points of 3-surface along 3-surface rather than rotations of the entire partonic surface in imbedding space. In the latter interpretation the rotation by 2π does nothing for the 3-surface. Hence fractionalization for the total charge of the single particle states does not take place unless one adopts the flow interpretation. This view about fractionalization however leads to problems with fractionalization of electromagnetic charge and spin for which there is evidence from fractional quantum Hall effect.

9.10.5 What about the relationship of gravitational Planck constant to ordinary Planck constant?

Gravitational Planck constant is given by the expression $\hbar_{gr} = GMm/v_0$, where $v_0 < 1$ has interpretation as velocity parameter in the units $c = 1$. Can one interpret also \hbar_{gr} as effective value of Planck constant so that its values would correspond to multifurcation with a gigantic number of sheets. This does not look reasonable.

Could one imagine any other interpretation for \hbar_{gr} ? Could the two Planck constants correspond to inertial and gravitational dichotomy for four-momenta making sense also for angular momentum identified as a four-vector? Could gravitational angular momentum and the momentum associated with the flux tubes mediating gravitational interaction be quantized in units of \hbar_{gr} naturally?

- (a) Gravitational four-momentum can be defined as a projection of the M^4 -four-momentum to space-time surface. Its length can be naturally defined by the effective metric $g_{eff}^{\alpha\beta}$ defined by the anticommutators of the modified gamma matrices. Gravitational four-momentum appears as a measurement interaction term in the modified Dirac action and can be restricted to the space-like boundaries of the space-time surface at the ends of CD and to the light-like orbits of the wormhole throats and which induced 4- metric is effectively 3-dimensional.
- (b) At the string world sheets and partonic 2-surfaces the effective metric degenerates to 2-D one. At the ends of braid strands representing their intersection, the metric is effectively 4-D. Just for definiteness assume that the effective metric is proportional to the M^4 metric or rather - to its M^2 projection: $g_{eff}^{kl} = K^2 m^{kl}$.

One can express the length squared for momentum at the flux tubes mediating the gravitational interaction between massive objects with masses M and m as

$$g_{eff}^{\alpha\beta} p_\alpha p_\beta = g_{eff}^{\alpha\beta} \partial_\alpha h^k \partial_\beta h^l p_k p_l \equiv g_{eff}^{kl} p_k p_l = n^2 \frac{\hbar^2}{L^2} . \quad (9.10.1)$$

Here L would correspond to the length of the flux tube mediating gravitational interaction and p_k would be the momentum flowing in that flux tube. $g_{eff}^{kl} = K^2 m^{kl}$ would give

$$p^2 = \frac{n^2 \hbar^2}{K^2 L^2} .$$

\hbar_{gr} could be identified in this simplified situation as $\hbar_{gr} = \hbar/K$.

- (c) Nottale's proposal requires $K = GMm/v_0$ for the space-time sheets mediating gravitational interaction between massive objects with masses M and m . This gives the estimate

$$p_{gr} = \frac{GMm}{v_0} \frac{1}{L} . \quad (9.10.2)$$

For $v_0 = 1$ this is of the same order of magnitude as the exchanged momentum if gravitational potential gives estimate for its magnitude. v_0 is of same order of magnitude as the rotation velocity of planet around Sun so that the reduction of v_0 to $v_0 \simeq 2^{-11}$ in the case of inner planets does not mean that the propagation velocity of gravitons is reduced.

- (d) Nottale's formula requires that the order of magnitude for the components of the energy momentum tensor at the ends of braid strands at partonic 2-surface should have value GMm/v_0 . Einstein's equations $T = \kappa G + \Lambda g$ give a further constraint. For the vacuum solutions of Einstein's equations with a vanishing cosmological constant the value of \hbar_{gr} approaches infinity. At the flux tubes mediating gravitational interaction one expects T to be proportional to the factor GMm simply because they mediate the gravitational interaction.
- (e) One can consider similar equation for gravitational angular momentum:

$$g_{eff}^{\alpha\beta} L_\alpha L_\beta = g_{eff}^{kl} L_k L_l = l(l+1)\hbar^2 . \quad (9.10.3)$$

This would give under the same simplifying assumptions

$$L^2 = l(l+1) \frac{\hbar^2}{K^2} . \quad (9.10.4)$$

This would justify the Bohr quantization rule for the angular momentum used in the Bohr quantization of planetary orbits.

Maybe the proposed connection might make sense in some more refined formulation. In particular the proportionality between $m_{eff}^{kl} = Km^{kl}$ could make sense as a quantum average. Also the fact, that the constant v_0 varies, could be understood from the dynamical character of m_{eff}^{kl} .

9.10.6 Summary

The hierarchy of Planck constants reduces to second quantization of multi-furcations in TGD framework and the hierarchy is only effective. Anyonic physics and effective charge fractionization are consequences of second quantized multi-furcations. This framework also provides quantum version for the transition to chaos via quantum multi-furcations and living matter represents the basic application. The key element of dynamics of TGD is vacuum degeneracy of Kähler action making possible quantum criticality having the hierarchy of multi-furcations as basic aspect. The potential problems relate to the question whether the effective scaling of Planck constant involves scaling of ordinary wavelength or not. For particles confined inside linear structures such as magnetic flux tubes this seems to be the case.

There is also an intriguing connection with the vision about physics as generalized number theory. The conjecture that the preferred extremals of Kähler action consist of quaternionic or co-quaternionic regions led to a construction of them using iteration and also led to the hierarchy of multi-furcations [K94]. Therefore it seems that the dynamics of preferred extremals might indeed

reduce to associativity/co-associativity condition at space-time level , to commutativity/co-commutativity condition at the level of string world sheets and partonic 2-surfaces, and to reality at the level of stringy curves (conformal invariance makes stringy curves causal determinants [K92] so that conformal dynamics represents conformal evolution) [K81].

9.11 Do blackholes and blackhole evaporation have TGD counterparts?

The blackhole information paradox is often believed to have solution in terms of holography stating in the case of blackholes that blackhole horizon can serve as a holographic screen representing the information about the surrounding space as a hologram. The situation is however far from settled. The newest challenge is so called firewall paradox proposed by Polchinsky et al [B31]. Lubos Motl has written several postings about firewall paradox and they inspired me to look the situation in TGD framework.

These paradoxes strengthen the overall impression that the blackhole physics indeed represent the limit at which GRT fails and the outcome is recycling of old arguments leading nowhere. Something very important is lacking. On the other hand, some authors like Susskind claim that the physics of this century more or less reduces to that for blackholes. I however see this endless tinkering with blackholes as a decline of physics. If super string had been a success as a physical theory, we would have got rid of blackholes.

If TGD is to replace GRT, it must also provide new insights to blackholes, blackhole evaporation, information paradox and firewall paradox. This inspired me to look for what blackholes and blackhole evaporation could mean in TGD framework and whether TGD can avoid the paradoxes. This kind of exercises allow also to sharpen the TGD based view about space-time and quantum and build connections to the mainstream views.

9.11.1 Background

Hawking radiation and information paradox

A theoretical argument supporting the existence of Hawking radiation from blackhole was suggested by Hawking in 1974. Before this Bekenstein had proposed that blackholes are characterized temperature and entropy. The implication is that blackholes radiate their mass gradually as thermal radiation. Since thermal radiation carries no information, this leads to black hole information paradox if one assumes that the blackhole evolves unitarily.

Hawking's original conclusion - which he later gave up - was that information is indeed lost. Susskind and t'Hooft proposed holographic principle stating that the information is actually contained in the radiation emitted from the blackhole. There are several approaches to the information paradox: information is destroyed, information gradually leaks out, information suddenly escapes in the final states of evaporation, or is stored in Planck sized remnant. Basic assumptions have been Equivalence Principle and unitary of the emission process of blackhole evolution. Penrose's disagreed about the necessity of assuming unitary evolution: state function reduction is non-unitary process and his proposal was that gravitation induces state function reductions.

Firewall paradox

The firewall paradox was introduced by Polchinski et al One considers two observers: distant observer and observer falling in late stage blackhole. If one assumes both Equivalence principle in the sense that M^4 QFT applies in low curvature regions (therefore also somewhat below the horizon) and requires unitary of emission of Hawking radiation, one ends up with the prediction that falling observer must encounter a firewall at horizon (quite concretely destroying her) or there is new nonlocal long length scale dynamics involved. EP however predicts that no such

firewall should be encountered since low curvature regions are in question and M^4 QFT should work. Therefore unitary and EP lead to conflicting predictions.

In the following Bob refers to distant observer and Alice is the observer jumping into blackhole. The core of the argument goes as follows.

- (a) Bob: Unitarity requires maximal entanglement BR , R early Hawking radiation. If one assumes that entanglement matrix is unitary or product of projection operator and unitary matrix then this is the case but I do not quite understand why this should be the case.
- (b) Alice: Horizon approximated by Rindler wedge [B29, ?, B14]. Minkowski vacuum superposition of state pairs at different sides of the Rindler wedge. Nearly maximal entanglement for Minkowski vacuum represented in terms of states associated with the right and left wedges is easy to understand. EP requires maximal entanglement BA , A inside blackhole. Therefore B is maximally entangled with both A and R . This is contradiction by the monogamy of maximal entanglement (more precisely with the sub-additivity of entanglement entropy).

There has been an intense debate about the firewall paradox. For instance, Bouzzo has written two articles with different conclusions.

Bouzzo's first article has title Observer complementary resolves firewall paradox [B23]. The argument goes as follows. By EP Alice falling in blackhole can approximate local physics in low curvature regions by the physics in empty Minkowski space: the region above and also somewhat below horizon is low curvature region. Blackhole looks like membrane for Bob. Alice observers no membrane. Therefore the descriptions of the two observers are inconsistent. Observer complementarity is claimed to save the situation. Observers are not able to communicate to each other their contradictory findings concerning the existence horizon, and therefore cannot discover the inconsistency. The measurements of Alice and Bob are analogous to measurement of non-commuting observables. These are to my opinion lawyer arguments. Laws of physics could be violated when no-one is seeing it!

Bouzzo's second article is titled Observer complementarity is not enough [B22]. The new argument developed by Bouzzo states that Alice can actually gather information about the existence of horizon and avoid falling into blackhole and therefore communicate the information to Bob so that paradox becomes observable.

To my opinion observer complementary and blackhole complementarity suggested by Susskind [?] and involves the assumption of stretched horizon with thickness of Planck length sound questionable hypothesis.

9.11.2 About basic assumptions about blackhole evaporation as seen in TGD context

- (a) For GRT blackholes the interior does not allow geodesic lines to escape to blackhole exterior: in other words the escape velocity is larger than light velocity. Also the roles of time coordinate and radial coordinate are exchanged.

In TGD sub-manifold gravity leads the replacement of blackhole interior with an Euclidian region [L8]. Motivation for this comes from the study of small perturbations of the Reissner-Nordström metric transforming horizon to light-like 3-surfaces and making 4-metric degenerate at horizon so that Euclidian metric signature becomes natural in the interior. This leads to a new view about the microscopic origin of cosmological constant: there are actually many manners to interpret cosmological constant and the recent progress in the understanding of preferred extremals predicts Einstein's equations with cosmological constant which - like also Newton's constant- can in principle depend on extremal [K94].

Horizon property is preserved since nothing can escape from Euclidian region to Minkowskian region. The reason is that in Euclidian region the square of four-velocity is negative and in Minkowskian region positive or zero unless a tachyon is in question. Note that the 4-metric becomes degenerate at horizon in time direction. Minkowskian QFT description inside TGD blackhole is definitely lost. As a matter of fact, it seems that any physical

object by definition corresponds to a system with horizon in which the signature of the induced metric changes. One can also say that any physical object can appear as a line of generalized Feynman diagram understood as Euclidian space-time region whose M^4 projection can be arbitrarily large. Blackholes would be replaced with a much larger variety of objects with horizon to which an appropriate generalization of the ideas of blackhole physics might apply. This would represent TGD counterpart for AdS/CFT correspondence with AdS replaced with space-time surface and conformal field theory assigned with light like 3-surface and partonic 2-surface and tangent space data by strong form of holography.

- (b) The assumption about fixed space-time might be unacceptable in the case of blackhole even in the length scales of order Schwarzschild radius.

In TGD framework the notion of many-sheeted space-time leads to the hierarchy of effective Planck constants [L10]. This hierarchy suggests that black holes could be macroscopic quantum systems. In particular, the degrees of freedom associated with the "world of classical worlds" (WCW) could not be approximated as being frozen anymore so that QFT description would fail. Even outside the blackhole the presence of magnetic flux quanta suggested to mediate gravitational and also other interactions [K72] brings in new highly non-trivial essentially non-local degrees of freedom.

- (c) In GRT framework EP is assumed in the form that M^4 QFT describes physics locally in the low curvature regions, and applies also below horizon as long as curvature is not too large.

In TGD framework this form of EP need not make sense in TGD, and certainly not so at the boundary of Minkowskian and Euclidian regions defining the TGD counterpart of blackhole horizon. EP as Einstein's equations makes sense in TGD although the equations do not follow from a variational principle but as a property of preferred extremals guaranteeing a generalization of 2-D conformal invariance to 4-D context. Gravitational constant and parameter Λ are predictions of classical theory rather than inputs.

- (d) Blackhole thermodynamics suggests that information about the state of matter collapsed into blackhole is lost. This leads to blackhole information paradox [B4].

The Unruh effect [B18] (see the article article [B29] suggests a possible solution to the problem.

- i. Consider a system accelerated with constant acceleration a . A convenient coordinate system is $M^2 \times E^2$ such that acceleration in M^2 . The coordinates for M^2 are 2-D variant of Robertson-Walker coordinates: $(t, x) = a(\sinh(\eta), \pm \cosh(\eta))$, where \pm corresponds to the two disjoint components L and R of the set $t^2 - x^2 < 0$ of M^2 . The orbit of the accelerated system correspond to the $a = \text{constant}$ hyperbola with a proportional to the inverse of acceleration. At the limit of infinite acceleration one obtains orbit at the boundary of 2-D light-cone defining Rindler horizon [B14].
- ii. For an accelerated observer it is natural to quantize field theory in the right wedge R and the vacuum of full M^4 QFT is sum over products of state in L and R . For large values of acceleration these states have nearly maximal entanglement. The tracing over L or R yields thermal density matrix with temperature equal to $a/2\pi$, a the acceleration.
- iii. The analogies with blackhole horizon are obvious, which leads to the idea that Hawking radiation is like Unruh radiation and Hawking temperature is analogous to Unruh temperature. The problem is that speaking about acceleration in Minkowski space in GRT, where geodesic motion corresponds to a vanishing acceleration, does not seem to make sense.

TGD can be seen as sub-manifold gravity and this changes the situation. The geodesic lines at space-time surface are not geodesic lines of the imbedding space, and therefore have non-vanishing trace of second fundamental form as curves of imbedding space rather than space-time surface. The M^4 part of the second fundamental form defines acceleration. What is also intriguing that $M^4 = M^2 \times E^2$ decomposition appears in quantum TGD at fundamental level having both purely physical and number theoretical justification. Could this decomposition define also the analogs of Rindler wedges and Unruh decomposition?

Could one see the TGD counterpart of Hawking gravitation as a "kinematic effect" very much analogous to Unruh radiation?

- (e) Blackhole time evolution is assumed to be unitary and Hawking evaporation is assumed to be a unitary process.

In TGD M-matrix replaces S-matrix and M-matrices define the rows of unitary U-matrix. Quantum dynamics can be seen as a sequence of quantum jumps to which one can assign state preparation, state function reduction and unitary process. At ensemble level (for sub-CDs of CD) one has dissipation and blackhole like system is like any other macroscopic quantum system. There is also hierarchy of space-time sheets and small space-time sheets defined dissipating ensembles. The entire system however behaves unitarily. In reality one must take also the interactions of blackhole with environment into account so that exact unitarity holds only for this system.

In TGD based quantum theory state function reduction (describe in more detail in the chapter About the Nature of time [K6] is the basic element of quantum dynamics. One has sequences of unitary evolutions followed by state function reductions. TGD space-time is many-sheeted so that these evolutions appear in many scales characterized by the size scales of causal diamonds (CDs). In the scale of CD assignable to blackhole the time scale characterizing the unitary evolution at the space-time sheet of blackhole is certainly very long so that unitarity at this space-time sheet should be a good approximation. For small sub-CDs situation changes and one can assign the ensembles formed by them growing entropy.

- (f) In quantum gravity Planck length scale is often assumed to be something fundamental. This could quite well be an illusion produced by dimensional analysis.

In TGD framework CP_2 length scale which is of order 10^4 times Planck length scale defines the fundamental length scale with concrete geometric interpretation and Planck length scale emerge only as formal scale which need not have any geometrical correlate.

9.11.3 Relating the terminology of blackhole evaporation to TGD framework

It is useful to consider the terminology related to blackhole, black hole evaporation, and entanglement from TGD point of view.

Blackhole and observers

- (a) *Horizon*: the surface inside which the escape velocity for particles larger than c . Time coordinate and radial coordinate change their roles. For the imbedding of Schwarzschild metric in $M^4 \times CP_2$ this happens quite concretely.

In TGD interior of blackhole like state has Euclidian metric and the boundary between Minkowskian and Euclidian regions acts like a causal horizon.

- (b) *Stretched horizon*: Horizon replaced with a layer of thickness Planck length.

This notion could have a counterpart in TGD although the scale in question is much larger than Planck length. Particles just outside the TGD horizon as wormhole contacts connected by magnetic flux tubes to the horizon which is very large wormhole contacts as far as M^4 projection is considered.

- (c) *Rindler wedges*: Blackhole horizon approximated as Rindler horizon in GRT. One approximates the situation using QFT in $M^4 = M^2 \times E^2$ where M^2 has hyperbolic coordinates motivated by the fact that the orbit of particle with constant acceleration is hyperbola. Minkowski vacuum in the accelerating system described by right Rindler wedge is seen as almost maximally entangled state in tensor product of the two sides of the wedge. In GRT framework this approximation is questionable since acceleration is questionable notion: it vanishes for geodesic lines.

What about TGD?

- i. In TGD framework blackhole horizon cannot be approximated as Rindler horizon since the interior of TGD blackhole is Euclidian. What is how intriguing that $M^2 \subset M^4$ inclusion appears in TGD framework in key role. Also Rindler wedge involves preferred M^2 determined by the direction of acceleration. The trace of the second fundamental form defines acceleration like variable for any sub-manifold and for 1-D curve in particular. Only the right Rindler wedge is realized as Minkowskian region at wormhole throats. Therefore it does not make sense to speak about Unruh effect and Hawking radiation at horizon since Minkowski vacuum is not a sensible approximation here.
- ii. Generalized form of holography however suggests that horizon is mathematically and physically equivalent with any parallel light-like 3-surfaces forming a slicing around the horizon. For them Rindler wedges make sense and one would obtain the analog of Hawking radiation as Unruh effect.
- iii. Rindler edges could be also interpreted as outside of the CD and the motion of particle in this region as motion in gravitational field created by matter outside CD. CD resembles blackhole at the level of imbedding space. Outside has also interpretation in terms of interior of another CD.

Entanglement

There are some notions related to entanglement. Purifying entanglement for density matrix of system B means existence of a system R_B such that $R_B B$ is pure - in other words the density matrix of B is obtained by tracing over R_B .

Almost maximal entanglement means that the density matrix of second entangled system obtained by tracing is in near unit matrix. The monogamy of maximal entanglement states that a given system cannot have maximal entanglement with two disjoint systems is the core of the argument leading to the firewall paradox.

Alice is argued to see a mirror system inside horizon maximally entangled with Bob: $A \heartsuit B$ in the notation half-jokingly introduced by Lubos Notl who seems maximal entanglement as love (personally I prefer see negentropic entanglement as correlate of love and various kinds of positive emotions such as experience of understanding).

Hawking radiation

Early radiation R and late radiation R' are assumed to combine to form a pure state RR' , which is maximally entangled. If a unitary matrix multiplied by a projection operators to R and R' ($P_1 S P_2$) defines the entanglement coefficients, maximal entanglement is obtained.

What could this correspond in TGD? ZEO implies that density matrix is replaced with M-matrix defining time-like entanglement coefficients. M-matrix as counterpart of S-matrix is not unitary. Unitary matrix U however exists and has M-matrices as its rows. Quantum evolution is a sequence of quantum jumps reducing to state function reductions at the upper and lower boundaries of CD. Unitary evolution relates to each other the two basis of zero energy associated with opposite boundaries. These differ in that positive/zero energy part of state is prepared whereas the second part of state is superposition of states with different particle numbers and with ill-defined single particle quantum numbers.

9.11.4 Could blackhole evaporation have a TGD counterpart?

Basically any burning process is analogous to blackhole evaporation in TGD framework since Euclidian region defines a space-time counterpart for a system in any length scale. Blackhole is different only because the gravitational field outside horizon is so strong that its stability with respect to small perturbations forced the generation of Euclidian region. This is enough to explain what we can observe about blackholes.

TGD counterparts of blackholes

In TGD based on ZEO the description of the TGD counterpart of blackhole looks different.

- (a) The TGD counterpart of blackhole is described by zero energy state to which one can assign a CD. At imbedding space level of CD is very much like horizon since the induced metric is degenerate. The region outside CD is like Rindler wedge for $M^2 \subset M^4$. For sub-CDs these wedges would look natural and gravitational field could correspond to that created by sub-CD. Therefore it seems that horizons are obtained both at imbedding space level and space-time level.
- (b) Wormhole throats are counterparts of black hole like states at space-time level. Blackhole horizon is replaced by horizon at which the induced metric becomes Euclidian. This horizon is also a causal horizon: nothing leaks from the interior since 4-metric becomes degenerate at the horizon. One cannot anymore apply Rindler wedge argument at the horizon and the argument that Alice sees a state in which blackhole interior and distant observer are maximally entangled is lost. One gets rid of firewall paradox since one does not anymore have maximal entanglement of same system B with two different systems.
- (c) Strong form of holography holds true. Partonic 2-surfaces and their 4-D tangent space data (string world sheets) code for physics. Generalized blackhole horizon can be said to carry the matter. Particles can condense around horizon. Elementary particles correspond to structures involving wormhole contacts connected by Minkowskian magnetic flux tubes at parallel space-time sheets and combining to form a closed magnetic flux tube. The wormhole contact at the second end of the flux tube can attach to the horizon. This gives rise to a real firewall [K63], and the simplest model for blackhole would be as this kind of hollow spherical structure. The topology of Euclidian region can be more complex than that of the interior of sphere since wormhole flux tubes with Minkowskian signature can be present in interior.
- (d) The interior of the ordinary blackhole can be isolated from the external world. In TGD framework one cannot assume this. Magnetic flux tubes can connect the wormhole contacts associated with particles very near to horizon and horizon itself to distant system. Gravitational and also other interactions are mediated along this kind of flux tubes and make possible for black hole to exchange energy with external world. At the microscopic level the description in the case of fermions (right handed neutrino is an exception) reduces to ??string world sheets at which the fermionic modes are localized [K94] by very general arguments. Hence the analog of AdS/CFT duality is realized.
- (e) The exterior of TGD counterpart of genuine blackhole like in general relativity apart from imbedding to $M^4 \times CP_2$. Also the interior of blackhole allows imbedding down to some critical radius. At horizon, where $g_{tt} = 1/g_{rr} = 0$ holds true, a small deformation of g_{rr} makes the horizon a light-like surface and 4-metric degenerate. Hence it is natural to assume that blackhole interior has Euclidian metric in TGD framework. In the simplest case matter resides very near to the causal horizon which is now light-like 3-surface at which space-time surface is effectively 3-dimensional metrically. Approximation by Minkowskian physics certainly fails at horizon and below it. The argument leading to firewall paradox is lost.
- (f) In TGD framework evolution by quantum jumps realized as state function reductions is a key element of quantal evolution. Also blackhole evolution takes place as a sequence of quantum jumps between zero energy states assignable to light-like boundaries of causal diamond (CD) accompanying blackhole. Therefore loss of information is not a problem. TGD view about quantum jump leads to a rather radical revision of views about the relationship between geometric time and experienced time as well as about the notion of arrow of time already characterizing zero energy states in the sense that positive/negative energy state at upper/lower boundary of CD is prepared and the state at opposite boundary is superposition of states with different particle numbers and ill defined single particle quantum numbers.
- (g) Density matrix is replaced by M-matrix defined as a product of a hermitian square root of density matrix and unitary S-matrix. M-matrices form rows of unitary U-matrix. Square

root of thermodynamics. The series of state function reductions thermalizes ensembles. Subsystems consisting of sub-CDs become thermal ensemble. CD itself can be said to evolve unitarily at the level of U-matrix. If density matrix is projection operator, then maximal entanglement is obtained between positive and negative energy states.

Could TGD counterparts of blackholes evaporate?

Could TGD counterparts of blackholes evaporate?

- (a) One could see the most general TGD counterparts of blackholes as ordinary macroscopic bodies with the space-time sheet representing the object having Euclidian signature of metric in the space-time region defined by the body. As noticed, this region can be topologically a sphere with handles represented as Minkowskian wormholes connecting separate parts of spherical horizon. Therefore the analog of thermal radiation would make sense. Hawking evaporation poses much stronger condition. Elementary particles represent limiting cases of Euclidian regions and electron is stable against decays and also against evaporation of this kind. General TGD blackholes need not have any special gravitational properties. In the case of genuinely blackhole like states, one can also restrict the situation so that the exterior metric is Reissner-Nordström vacuum in good approximation.
- (b) An attractive manner to interpret Hawking evaporation in the standard framework is by approximating the horizon by Rindler horizon. This leads the study of effectively 2-D Rindler wedge in Minkowski space assignable to accelerated system. The two sides of the wedge correspond to their own Rindler vacua and Minkowski vacuum is sum over pairs of states at both sides so that one obtains thermal spectrum of particle states with Unruh temperature. Accelerated observer would be continually boosted so that the hyperbolic angle η would grow. Accelerated observer would see Hawking radiation.

Does it make sense to speak about accelerated observers at fundamental level? The following little argument suggests that one cannot speak about Hawking radiation at horizon. This conforms with the intuitive idea that Hawking radiation is created outside the horizon.

- (a) One can assign to each point of space-time surface a generalization of acceleration vector as M^4 part of the trace of second fundamental form. For preferred extremals the trace of the second fundamental form would actually vanish since they are minimal surfaces. One can also consider second fundamental form for curves - say geodesics. This has both M^4 and CP_2 parts and does not vanish in general. The orbit of the boundary of string world sheet along light-like 3-surface is one possible identification. Braid strands, which can be both time-like and space-like, could be seen as analogs of accelerated observers with acceleration defined by M^k . The decomposition $M^4 = M^2 \times E^2$ with Rindler coordinates and Rindler decomposition of the M^4 vacuum at each point of the curve would give one further function for $M^2 \subset M^4$ dictated by several general arguments.
- (b) At the horizon of TGD blackhole the metric changes to Euclidian. Also the dimension of M^4 projection becomes at most $D = 3$ if the proposed general solution ansatz for preferred extremals is correct [K94]. Hence the description as Rindler horizon and the approximation by M^4 QFT fails at and below the horizon. This is counterpart for the firewall. This holds true for all braid strands defining orbits along wormhole throats. For space-like string curves situation is different but now a tachyon would be in question. Hence one cannot speak about Unruh radiation and Hawking radiation at horizons and below them.

Could one generalize the notion of hologram from wormhole orbit so that Hawking radiation would result as Unruh radiation? This is possible to imagine.

- (a) One can consider a slicing of space-time sheet by "parallel" light-like 3-surfaces in the vicinity of given wormhole throat. If it is possible to make measurements at these light-like 3-surfaces, one could have QFT in M^4 as an approximation and have Rindler decomposition, Unruh effect, and Hawking radiation beyond Schwarzschild radius r_s .

- (b) In WCW geometry strong form of GCI implying strong form of holography suggests that any choice of light-like 3-surface in a slicing of space-time sheet by light-like 3-surfaces is equally good, and means only a transformation of the Kähler function of WCW by adding to it a real part of holomorphic function induced gauge transformation of Kähler gauge potential of WCW. This does not affect WCW metric and should not affect physics either. Wormhole throats would be of course in a preferred position physically.
- (c) More precisely, at the wormhole throat the vacuum state is right Rindler vacuum R . At larger distances Minkowski vacuum makes sense approximately and is in reasonable approximation expressible as a sum over tensor products of states of R and L , and both L and R have thermal density matrix resulting in tracing with acceleration defining the Unruh temperature given by the trace of the second fundamental form for the curve (geodesic in question) [B18]. At very small distances from wormhole throat QFT approximation works only for very high energies at the left hand side.

Final remark: I have suggested a p-adic version of Hawking-Bekenstein formula holding true at elementary particle level [K58]. Maybe p-adic thermodynamics could replace blackhole thermodynamics in the case of elementary particles at least.

The conclusion is that blackhole and blackhole evaporation have TGD based generalization. The notion of blackhole like state would be very general and can be assigned with any physical system with a well-defined geometric shape (defined by the Euclidian space-time sheet). Gravitational blackholes would be only special cases. The notion of Hawking radiation identified as Unruh radiation could also make sense, and one could understand Rindler coordinates in terms of $M^2 \subset M^4$ decomposition central for quantum TGD. It is however essential that the acceleration parameter characterizing this radiation is defined by the trace of second fundamental form in the imbedding space: here GRT approach can be criticized of internal inconsistency. Since the interior of any TGD blackhole is Euclidian - this is absolutely essential- the argument leading to the firewall paradox fails. Horizon is in TGD framework a genuine firewall but this does not mean a failure of Equivalence Principle which only says only that Einstein's equations hold true for preferred extremals: Minkowskian QFT is always a good local approximation.

Acknowledgements

I am grateful for Victor Christianito for informing me about the article of Nottale and Da Rocha. Also the highly useful discussions with him and Carlos Castro are acknowledged. I want also to express my gratitude to my friend Pertti Kärkkäinen for informing me about the theoretical problems related to the precession of equinoxes and for a careful proof reading of the section inspired by the problem.

Chapter 10

Quantum Astrophysics

10.1 Introduction

The mechanisms behind the formation of planetary systems, galaxies and larger systems are poorly understood but planar structures seem to define a common denominator and the recent discovery of dark matter ring in a galactic cluster in Mly scale [E124] suggest that dark matter rings might define a universal step in the formation of astrophysical structures.

Also the dynamics in planet scale is poorly understood. In particular, the rings of Saturn and Jupiter are very intricate structures and far from well-understood. Assuming spherical symmetry it is far from obvious why the matter ends up to form thin rings in a preferred plane. The latest surprise [E43] is that Saturn's largest, most compact ring consist of clumps of matter separated by almost empty gaps. The clumps are continually colliding with each other, highly organized, and heavier than thought previously.

The situation suggests that some very important piece might be missing from the existing models, and the vision about dark matter as a quantum phase with a gigantic Planck constant [K30] is an excellent candidate for this piece. The vision that the quantum dynamics for dark matter is behind the formation of the visible structures suggests that the formation of the astrophysical structures could be understood as a consequence of Bohr rules [K72] .

10.1.1 Generalization of the notion of imbedding space

Quite generally, the hierarchy of Planck constants is realized by generalizing the notion of imbedding space such that one has a book like structure with various almost-copies of imbedding space glued together like pages of book. Each page of book correspond to a particular level of dark matter hierarchy and darkness means that there are no Feynman diagrams in which particles with different value of Planck constant would appear. The interactions between different levels of hierarchy involve the transfer of the particles mediating the interaction between different pages of the book. Physically this means a phase transition changing the value of Planck constant assignable to the particle so that particle's quantum size is scaled. At classical level the interactions correspond to the leakage of magnetic and electric fluxes and radiation fields between different pages of the book.

The development of the view about generalized imbedding space

The development of precise formulation of the realization of Planck constants in terms of the book like structure of imbedding space has been a sequence of improved trials.

- (a) Since space-time surfaces are 4-surfaces in the generalized imbedding space, Bohr rules can be formulated in a manner which is general coordinate invariant and Lorentz invariant. The rules are actually for dark matter structures obeying Z_n symmetry for very large n

characterizing a symmetry of field bodies associated with the structure in question. Z_n was identified as a maximal cyclic subgroup for any subgroup $G \subset SO(3)$ appearing in the series of Jones inclusions with index $\mathcal{M}/\mathcal{N} < 4$ but also $\mathcal{M}/\mathcal{N} \geq 4$ can be considered. Two questions arise. What distinguishes between these two cases and what is the precise action of G .

- (b) The first generalization of the imbedding space assigned Z_n to rotations in M^4 degrees of freedom acting as symmetries of factor space obtained dividing with subgroup of $G \subset SO(3)$ having Z_n as maximal cyclic subgroup. The outcome was a book like structure associated with $M^4 \setminus M^2$ with M^2 defining the back of the book and characterizing the direction of quantization axes for spin. The choice of M^2 has interpretation as fixing choice of the direction of quantization axes. The world of classical worlds (WCW) would be union over different choices of M^2 .
- (c) This generalization was not enough to really understand the physics behind gravitational Planck constant, and the next generalization assigned the groups associated with Jones inclusions also with CP_2 degrees of freedom and acting also now as invariance group of orbifold structure associated with CP_2 . In CP_2 degrees of freedom the back of the book is defined by homologically trivial geodesic sphere S^2 of CP_2 . Therefore one has book like structure in both M^4 and CP_2 degrees of freedom.
- (d) The attempts to understand Quantum Hall effect suggested a generalization, which allowed both factor spaces and coverings of both M^4 and CP_2 . In the case of coverings the action of Z_n contained by the group assignable to Jones inclusion permutes the sheets of the singular covering space of $M^4 \setminus M^2$ ($CP_2 \setminus S^2$). In the similar manner the group acts in the singular factor space associated with $M^4 \setminus M^2$ ($CP_2 \setminus S^2$). The coverings were assigned with Jones inclusions having index $\mathcal{M}/\mathcal{N} \geq 4$.
- (e) The emergence of zero energy ontology induced further detail to this picture. In zero energy ontology causal diamond (CD) of M^4 defined as the intersection of future and past directed light-cones is basic structure. $CD \times CP_2$ contains positive (negative) energy parts of the zero energy state at the lower (upper) light-like boundary δM_+^4 δM_-^4 . Each CD defines sector in the world of classical worlds (WCW) consisting of light-like 3-surfaces and corresponding 4-surfaces inside $CD \times CP_2$. Each sector of this kind in turn corresponds a union over copies of CD s corresponding to different choices of quantization axes for Poincare and color quantum numbers so that the selection of quantization axis means a localization to one particular variant of given CD . Temporal and spatial localization in turn fixes the lower tip of CD : the location of upper tip is fixed by the condition that the temporal distance between upper and lower tip is quantized in powers of two: this assumption implies p-adic length scale hypothesis. The singular covering and factor spaces of CD s become the pages of the book like structures. One can say that these books are like rigid bodies located in $M^4 \times CP_2$ and that they have also rotational and color rotational degrees of freedom so that WCW is kind of gigantic quantum library.
- (f) The most tortuous piece of the tortuous development of the ideas were the guesses for the formula for Planck constant in terms of integers n_a and n_b characterizing the orders of maximal cyclic subgroups of G_a and G_b . The realization that the formula could be interpreted as homomorphism from the set of pages of the book left still two options for which expressions for the Planck constant were inverses of each other. Four options are possible and it seems that the correct option was found in the fourth trial! A heuristic argument based on $1/\hbar$ proportionality of the fine structure constant combined with the earlier condition that Compton length is proportional to n_a led to what I believe is the correct formula. For the Cartesian product of n_a resp. n_b -fold coverings of CD and CP_2 one has $\hbar = n_a n_b$. When covering is replaced with a factor space, n_i goes to $1/n_i$ in the formula. The model for quantum Hall effect is consistent with this [K63], and this option is also favored by the gravitational Bohr orbitology and the model for dark graviton emission. The notion of generalized imbedding space is describe in detail in Appendix.
- (g) For this identification of the Planck constant the huge value of h_{gr} requires that CD or CP_2 or both correspond to a singular covering space. These options can be denoted by $C - C$, $C - F$ and $F - C$. Rotational symmetries Z_{n_a} with small n_a are possible for $F - C$

option for very large value of n_b . For $C - F$ option dark matter symmetries with large Z_n acts in the covering of CD so that no discrete rotational invariance in CD is predicted. The $F - F$ option for which both G_a and G_b act as orbifold symmetries is not favored in gravitation nor living matter since one $\hbar/\hbar_0 = 1/n_a n_b$.

The extension of imbedding space to a book-like structure

The allowance of coverings means an extension of the imbedding space by allowing also G_a resp. G_b -fold coverings of $\hat{CD} = CD \setminus M^2$ resp. $\hat{CP}_2 = CP_2 \setminus S^2$. Here M^2 corresponds to 2-D Minkowski space defined by the fixing of rest frame and direction of quantization axis of angular momentum and S^2 to a homologically trivial geodesic sphere of CP_2 which corresponds to a particular choice of group $SO(3) \subset SU(3)$ and thus fixing of quantization axes of color isospin. The surfaces $X^4 \subset M^4 \times S^2$ are vacuum extremals as required by internal consistency of the theory. The leakage between different pages of book occurs via manifolds $CD \times S^2$ and $(M^2 \cap CD) \times CP_2$ which correspond to quantum criticality. The extreme form of quantum criticality corresponds to leakage through $M^2 \times S^2$.

There are four options corresponding to $C - C$, $F - F$, $C - F$ and $F - C$.

- (a) Options $C - C$ and $C - F$ for which G_a acts in the covering space of CD are perhaps the most promising candidates for the modeling of dark gravitons and gravitational Bohr orbitology but also $F - C$ option can be considered. $C - C$ maximizes the value of \hbar . Also fractional quantum Hall effect is possible only for these options (see Appendix). These options allow large values of Planck constant and could be involved also with living matter.
- (b) G_a could act as factor space symmetries in living matter for $F - C$ option. Molecular rotational symmetries correspond typically to small groups $G_a = Z_n$, $n = 5, 6$ are favored for molecules containing aromatic cycles and could correspond to factor spaces in M^4 degrees of freedom and coverings in CP_2 degrees of freedom ($r = n_b/n_a$). Also genuinely 3-dimensional tetrahedral, octahedral, and icosahedral symmetries appear in living matter. Even the symmetries of snow flakes could be understood for $F - C$ option if n_b is large enough so that quantum scale proportional to n_b/n_a is macroscopic.
- (c) Also astrophysical systems might possess small G_a as orbifold symmetries and one can ask whether the hexagonal structure at the North Pole of Saturn could be an example of $n_a = 6$ fold symmetry. One must remember that these symmetries are exact at the level of dark matter but need not be so at the level of visible matter.

It must be emphasized that this interpretation differs quite a lot from the earlier ones which assumed different formulae of Planck constant.

Does the hierarchy follow from the basic quantum TGD?

One can consider also the possibility that the hierarchy of Planck constants follows from the basic quantum TGD rather than being assumed as a separate postulate. The argument goes as follows.

- (a) By the extreme non-linearity of the Kähler action the correspondence between the time derivatives of the imbedding space coordinates and canonical momentum densities is many-to-one. This leads naturally to the introduction of covering spaces of $CD \times CP_2$, which are singular in the sense that the sheets of the covering co-incide at the ends of CD and at wormhole throats. One can say that quantum criticality means also the instability of the 3-surfaces defined by the throats and the ends against the decay to several space-time sheets and consequent charge fractionization. The interpretation is as an instability caused by too strong density of mass and making perturbative description possible since the matter density at various branches is reduced. The nearer the vacuum extremal the system is, the lower the mass density needed to induce the instability is and the larger is the number of sheets resulting in this manner is.

- (b) The singular regions of the covering are regions in which the integer characterizing the multiple-valuedness of the time derivatives of the imbedding space coordinates as functions of canonical momentum densities is reduced from the maximal value. The reduction to single sheeted covering could (but need not!) take place over any Lagrangian manifold of CP_2 rather than only over a homologically trivial geodesic sphere and would thus directly correspond to the vacuum degeneracy of Kähler action. One can also imagine the reduction of the integer characterizing multivaluedness to a smaller value different from one in non-vacuum regions.
- (c) In M^4 degrees of freedom branching to a single sheeted covering can occur over any partonic 2-surface which does not enclose the tip of CD . In this case the Kähler gauge potential would contain a singular gauge term having an archetypal form $\Delta A = d\phi/n_a$ at say upper hemisphere so that the magnetic flux would receive a non-vanishing contribution from North pole and give rise to a fractionized Kähler magnetic and therefore also to Kähler electric charge. This term is pure gauge for all partonic 2-surface not containing the tip of CD . Thus one species of anyons would be associated with this kind of partonic 2-surfaces. Second species would correspond to singular gauge transforms about which example would be $\Delta A = d\Psi/n_b$, where Ψ is the angle coordinate associated with a homologically non-trivial geodesic sphere. The modification of the Kähler gauge potential could be interpreted in terms of a measurement interaction term added to the Dirac action and their sum at the ends would give rise to the non-fractional contribution to the measurement interaction term. This kind of term would be also associated with Noether charges such as 4-momentum. Depending on whether one considers the end of space-time sheet or at wormhole throat, the measurement interaction term would be given as $1/n_b$ or $1/n_a$ multiple of the measurement interaction term in absence of branching and would be more complex than the simple archetypal forms. The general form of the measurement interaction term is discussed in [K31].
- (d) Classically the fractional Noether charges would emerge from Chern-Simons representation of Kähler function with the Lagrangian multiplier term realizing the weak form of electric-magnetic duality as a constraint. The latter term would be responsible for the non-vanishing values of four-momentum and angular momentum. The isometry charges in CP_2 degrees of freedom would receive a contribution also from the Chern-Simons term.
- (e) The situation can be described mathematically either by using effectively only single sheet but an integer multiple of Planck constant or many-sheeted covering and ordinary value of Planck constant. In [K30] the argument that this indeed leads to hierarchy of Planck constants including charge fractionization is developed in detail. The restriction to singular coverings is consistent with the experimental constraints and means that only integer valued Planck constants are possible. A given value of Planck constant corresponds only to a finite number of the pages of the Big Book and that the evolution by quantum jumps is analogous to a diffusion at half-line and tends to increase the value of Planck constant.
- (f) The following argument would suggest a direct connection between vacuum degeneracy, coverings, and the hierarchy of infinite primes. For vacuum extremal the number of sheets is formally infinite but the sheets are in a well-define sense "passive". On the other hand, by the arguments of [K31] the numbers n_a and n_b for sheets correspond to powers p^{n_a} and p^{n_b} for a prime appearing in infinite prime characterizing the partonic 3-surface and having interpretation as particle numbers. The unit infinite primes $X \pm 1$ correspond to the two basic infinite primes having interpretation as fermionic vacua are interpreted as Dirac sea: the numbers of bosons and fermions are vanishing for them. This suggests that the fermions of Dirac sea correspond to the "passive" sheets. This raises the question whether one could characterize the infinite degeneracy associated with vacuum extremals by these two infinite primes and non-vacuum extremals by infinite primes for which boson and fermion numbers are non-vanishing. The two infinite primes would correspond to CD and CP_2 degrees of freedom. They could also correspond to the space-time sheets of Euclidian and Minkowskian signature of the induced metric meeting at the wormhole throat at which the induced 4-metric is degenerate. Bose-Einstein condensate of n_i bosons ($i = a, b$) or fermion plus $n_i - 1$ bosons would correspond to n_i sheets of covering.

Arithmetic quantum field theory allows infinite number of conservation laws corresponding to the conservation of the number theoretic momentum $p = \sum_i n_i \log(p_i)$ which forces separate conservation of each number theoretic momentum $n_i \log(p_i)$ since the logarithms of primes are linearly independent in the realm of rationals. This conservation law could correlate the partonic lines arriving in the interaction vertices and state that the total number of sheets of the covering is conserved although it can be shared by several partonic space-time sheets in the final state.

The reduction of the hierarchy of Planck constants to basic quantum TGD is of course only an interesting idea and the best strategy to proceed is to develop objections against it.

- (a) The branching of partonic 2-surfaces at the ends of space-time sheets and wormhole throats is analogous to the branching of the line of Feynman graph. The 3-D lines of generalized Feynman graphs indeed branch at the vertices and this leads to the basic objection against the proposed interpretation of the fractionization. Could one consider the possibility that branching corresponds to what happens in the vertices of Feynman diagrams? This cannot seem to be the case. The point is that canonical momentum densities are identical so that also the conserved classical Noether and Kähler charges associated with various branches should be the same.
- (b) The value of gravitational Planck constant is enormous and one would mean enormously many-fold branching of partonic 2-surfaces of astrophysical size. Does this really make sense? Is this simply due the fact that the basic parameter GM_1M_2 characterizing the strength of gravitational interaction is much larger than unity so that perturbation theory in terms of it fails to converge and the splitting to \hbar_{gr}/\hbar_0 sheets guarantees that the perturbation theory at each sheet converges.
- (c) One can also ask whether the fractional charges can be observed directly since it seems that only the partonic 2-surfaces at the ends of the space-time sheet are observable.
- (d) Perhaps the most serious objection relates to the basic intuition about scaling of quantum lengths by \hbar since this scaling is fundamental for all predictions in the model of quantum biology. It is not obvious why the basic quantum lengths in M^4 degrees of freedom - in particular the size scale of CD - should be scaled up by $n_a n_b$. Could this scaling up result dynamically or can one find some simple kinematic argument forcing the size scale spectrum of CD s? Kinematic argument is more plausible and indeed exists. Suppose that one can speak about plane waves $\exp(inEt/\hbar_0)$, where t is proper time coordinate associated with the line connecting the tips of CD . Periodic boundary conditions at $t = T$ imply $E = n\hbar_0/2\pi T$ where T is the proper time distance between the tips of CD . Suppose that \hbar_0 is replaced with its $n_a n_b$ multiple in the plane wave. As a consequence, the plane waves for sheets and for same value of E do not anymore satisfy periodic boundary conditions at $t = T$ anymore. These conditions are however satisfied for $t = n_a n_b T$.

10.1.2 Gravitational Bohr orbitology

The basic question concerns justification for gravitational Bohr orbitology. The basic vision is that visible matter identified as matter with $\hbar = \hbar_0$ ($n_a = n_b = 1$) concentrates around dark matter at Bohr orbits for dark matter particles. The question is what these Bohr orbits really mean. Should one in the improved approximation relate Bohr orbits to 3-D wave functions for dark matter as ordinary Bohr rules would suggest or do the Bohr orbits have some deeper meaning different from that in wave mechanics.

The first vision

The first vision about gravitational Bohr orbitology was inspired by the finding that surprisingly complex geometric structures possessing relatively small subgroups of rotational group as approximate symmetry groups appear in astrophysical scales (say the hexagonal structure associated with Saturnus). This would suggest circles and spokes representing dark matter structures,

gravi-electric flux quanta, and also circles representing gravi-magnetic flux tubes orthogonal to the quantization plane become building blocks of dark matter structures. This makes sense for $F - C$ option and the group G_a acting as orbifold symmetries would be behind these symmetries. This would require very large G_b acting as covering space symmetry in CP_2 degrees of freedom. Simplest of these structures are rings and cart-wheel like structures with rather small symmetry groups which are however badly broken. One could however argue that this breaking occurs only at the level of visible manner.

Z_{n_a} would act as rotational symmetries of magnetic body and its subgroups could act as approximate symmetries of the visible matter and if one accepts ruler-and-compass hypothesis powerful predictions follow. On the other hand,

This option works nicely in the case of quantum Hall effect if spin fractionization is involved. If one assumes that the dark space-time sheets associated with gravitons and matter correspond to same page of the Big Book, this picture leads to difficulties since large n_b for covering and small n_a for orbifold does not lead to a plausible picture about what dark gravitons should be.

Quantum Hall effect and dark anyonic systems

Bohr orbitology could be understood if dark matter concentrates on 2-dimensional partonic surfaces usually assigned with elementary particles and having size of order CP_2 radius. The interpretation is in terms of wormhole throats assignable to topologically condensed CP_2 type extremals (fermions) and pairs of them assignable to wormhole contacts (gauge bosons). Wormhole throat defines the light-like 3-surface at which the signature of metric of space-time surface changes from Minkowskian to Euclidian.

The large value of Planck constant allows gigantic partons. Since anyonic systems are 2-dimensional, the natural idea is that dark matter corresponds to systems carrying large fermion number residing at partonic 2-surfaces of astrophysical size and that visible matter condenses around these. Not only black holes but also ordinary stars, planetary systems, and planets could correspond at the level of dark matter to atom like structures consisting of anyonic 2-surfaces which can have complex topology (flux tubes associated with planetary orbits connected by radial flux tubes to the central spherical anyonic surface). Charge and spin fractionization are key features of anyonic systems and Jones inclusions inspiring the generalization of imbedding space indeed involve quantum groups central in the modeling of anyonic systems. Hence one has could hopes that a coherent theoretical picture could emerge along these lines.

This seems to be the case. Anyons and charge and spin fractionization are discussed in detail in the chapter [K63] and leads to a precise identification of the delicacies involved with the Kähler gauge potential of CP_2 Kähler form in the sectors of the generalized imbedding space corresponding to various pages of book like structures assignable to CD and CP_2 . The basic outcome is that anyons correspond geometrically to partonic 2-surfaces at the light-like boundaries of CD containing the tip of CD inside them. This is what gives rise to charge fractionization and also to confinement like effects since elementary particles in anyonic states cannot as such leak to the other pages of the generalized imbedding space. G_a and G_b invariance of the states imply that fractionization occurs only at single particle level and total charge is integer valued.

In this framework various astrophysical structures such as spokes and circles would be parts of anyonic 2-surfaces with complex topology representing geometrically quantum coherence in the scale of say solar system. Planets would have formed by the condensation of ordinary matter in the vicinity of the anyonic matter. This would predict stars, planetary system, and even planets to have onion-like structure consisting of shells at the level of dark matter. Similar conclusion is suggested also by purely classical model for the final state of star predicting that matter is strongly concentrated at the surface of the star [K85].

Quantum criticality and quantum chaos

TGD Universe is quantum critical and quantum criticality corresponds very naturally to what has been identified as the transition region to quantum chaos. The basic formulation of quantum

TGD is indeed consistent with what has been learned from the properties of quantum chaotic systems and quantum chaotic scattering [B39]. Wave functions are concentrated around Bohr orbits in the limit of quantum chaos, which is just what dark matter picture assumes. In this framework the chaotic motion of astrophysical object becomes the counterpart of quantum chaotic scattering and classical description is predicted to fail. By Equivalence Principle the value of the mass of the object does not matter at all so that the motion of sufficiently light objects in solar system might be understandable only as quantum chaotic scattering. The motion of gravitationally unbound comets and rings of Saturn and Jupiter and the collisions of galactic structures known to exhibit the presence of cart-wheel like structures define possible applications.

The description of gravitational radiation provides a stringent test for the idea about dark matter hierarchy with arbitrary large values of Planck constants. In accordance with quantum classical correspondence, one can take the consistency with classical formulas as a constraint allowing to deduce information about how dark gravitons interact with ordinary matter. The standard facts about gravitational radiation are discussed first and then TGD based view about the situation is sketched in two cases corresponding to large value of n_a characterizing singular CD covering or orbifold and n_b characterizing singular CP_2 covering.

This discussion forces an important conclusion. The sequential de-coherence leading from dark gravitons with $(n_a > 1, n_b > 1)$ in stepwise manner to visible gravitons having $(n_a = 1, n_b = 1)$ necessary involves steps in which the frequency of the resulting lower level gravitons is subharmonic of the original frequency. Ruler and compass hypothesis favors period doubling since powers of two are favored for n_a and n_b . The generation of sub-harmonics is one of the basic routes to chaos which suggests that chaos in astrophysical systems corresponds to large values of n_b with powers of 2 favored. Quite generally, the approach to quantum chaos would transform \hbar/\hbar_0 from integer to a rational with increasing denominator.

The planetary Bohr orbitology has been already discussed in the chapter "TGD and Astrophysics" [K72] with applications solar system and exo-planets. This discussion is not based on the full generalization of the imbedding space but the general results are not changed since they depend on the value of Planck constant only. Instead of repeating this discussion, a formulation of these rules which is general coordinate invariant and Lorentz invariant is proposed.

About the spectrum of v_0

The proposed generalization of the imbedding space allows in principle any rational multiple of \hbar_0 as the value of Planck constant and given value of Planck constant is realized by very many pages of the book like structure. For instance, for $F - C$ and $C - F$ options all integer multiples of (n_a, n_b) produce the same Planck constant.

The dependence of the gravitational Planck constant on masses is fixed by Equivalence Principle. Its strongest form would require a universal value of $v_0/c \equiv v_0$ (although in the following units with $c = 1$ are used, it is important to remember that v_0 is basically velocity like parameter). This form is not realized.

- (a) Different value of v_0 is required for inner and outer planets. I have discussed a simple model explaining why inner and outer planets must have different values of v_0 by taking into account cosmic string contribution to the gravitational potential which is negligible nowadays but was not so in primordial times. Among other things this implies that planetary system has a finite size, at least about 1 ly in case of Sun (nearest star is at distance of 4 light years). The proposed anyonic picture would suggest that the anyonic 2-surface assignable to outer and inner planets is different.
- (b) Quantization rules have been applied to exoplanets in the case that the central mass and orbital radius are known (the discussion is moved from the chapter "Astrophysics" to the the Appendix of this chapter). Errors are around 10 per cent for the most favored value of $v_0 = 2^{-11}$. The "anomalous" planets with very small orbital radius correspond to $n = 1$ Bohr orbit ($n = 3$ is the lowest orbit in solar system). The universal velocity spectrum $v = v_0/n$ in simple systems perhaps the most remarkable prediction and certainly testable:

this alone implies that the Bohr radius GM/v_0^2 defines the universal size scale for systems involving central mass. Obviously this is something new and highly non-trivial.

- (c) The recently observed dark ring in Mly scale is a further success and also the rings and Moons of Saturn and Jupiter obey the same universal length scale ($n \geq 5$ and $v_0 \rightarrow (16/15) \times v_0$ and $v_0 \rightarrow 2 \times v_0$).
- (d) For our own Moon orbital radius is much larger than Bohr radius for $v_0 = 2^{-11}$: one would have $n \simeq 138$. $n \simeq 7$ results for $v_0 \rightarrow v_0/20$ giving $r_0 \simeq 1.2R_E$. The small value of v_0 could be understood to result from a sequence of phase transitions reducing the value of v_0 to guarantee that solar system participates in the average sense to the cosmic expansion and from the fact inner planets are older than outer ones in the proposed scenario. The findings of Masreliez [E160] discussed in the last section of [K72] support the prediction that planetary system does not participate cosmic expansion in a smooth manner.

The question becomes how to explain what is the correct manner to weaken Equivalence Principle and why the values of v_0 are what they are. The simplest hypothesis is that v_0 has a fixed value for orbits connected by radial flux tubes to a given anyonic 2-surface. If the value of v_0 characterizes different anyonic 2-surfaces to which flux tubes around planetary orbits are connected by radial flux tubes then inner and outer planets would correspond to different anyonic two-surfaces. This would also give a precise characterization for the weakened form of Equivalence Principle. One could see outer planets as planets of the central object formed by Sun and inner planets. This picture would raise spherical surface at the distance of Earth to a very special role as the boundary of this central object and one can wonder whether the very special properties of Earth relate to this special role.

Planetary Bohr orbitology was born as a generalization of atomic Bohr orbitology. One can however turn the situation upside down and ask whether also atom could be seen as an anyonic system in which flux tubes surrounding classical electronic orbits are connected to an anyonic 2-surface assignable to nucleus by radial flux tubes mediating Coulomb interaction. Charge and spin fractionization do not support this idea and anyonic systems are also many-particle systems. It is indeed quite conceivable that atoms in electrons corresponds to CP_2 sized partonic 2-surfaces with atomic wave function assignable to the position of this 2-surface in the interior of larger 3-surface.

There is still one question to be considered. Could one understand why the values of v_0 are what they are?

- (a) The condition that $\hbar = GM^2/v_0$ gives for the dark Planck length $L_P = \sqrt{\hbar G}$ a value of order Schwarzschild radius $r_S = 2GM$ forces $v_0 = 1/4$. The Planck length for $\hbar = GM(\text{sun})M(\text{Planet})/v_0$ corresponds to

$$L_P(\hbar) = \sqrt{\frac{r_S(\text{Sun})r_S(\text{Planet})}{4v_0}} = r_S(\text{Sun})\sqrt{\frac{M(\text{Planet})}{M(\text{Sun})}}\sqrt{\frac{1}{4v_0}}.$$

The smaller mass of planet is compensated by the smallness of v_0 so that $G(\hbar)$ is not too far from $r_S(\text{Sun})$: maybe this condition might fix at least the order of magnitude of v_0 somehow. In the case of Earth and Jupiter having $v_0 = 2^{-11}/5$ one has $G(\hbar) \simeq .27r_S(\text{Sun})$ and $G(\hbar) \simeq 1.6r_S(\text{Sun})$.

- (b) One can also find justification for why just $v_0 = 2^{-11}$ is preferred. This number corresponds to the rotation velocity v/c of matter around cosmic string like objects assignable to galaxies and is expressible in terms of basic constants of quantum TGD (CP_2 length and Kähler coupling strength) appearing in the expression of string tension of cosmic strings.

10.1.3 How General Coordinate Invariance and Lorentz invariance are achieved?

The basic objection of General Relativist against the planetary Bohr orbitology model is the lack of the manifest General Goordinate invariance and Lorentz symmetry. In GRT context this objection would be fatal. In TGD framework the lack of these symmetries is only apparent.

One can use Minkowski coordinates of the M^4 factor of the imbedding space $H = M^4 \times CP_2$ as preferred space-time coordinates. The basic aspect of dark matter hierarchy is that it realizes quantum classical correspondence at space-time level by fixing preferred M^4 coordinates as a rest system. This guarantees preferred time coordinate and quantization axis of angular momentum. The physical process of fixing quantization axes thus selects preferred coordinates and affects the system itself at the level of space-time, imbedding space, and configuration space (world of classical worlds). This is definitely something totally new aspect of observer-system interaction. One can identify in this system gravitational potential Φ_{gr} as the g_{tt} component of metric and define gravi-electric field E_{gr} uniquely as its gradient. Also gravi-magnetic vector potential A_{gr} and and gravi-magnetic field B_{gr} can be identified uniquely.

Quantization condition for simple systems

Consider now the quantization condition for angular momentum with Planck constant replaced by gravitational Planck constant $\hbar_{gr} = GMm/v_0$ in the simple case of point like central mass. The condition is

$$m \oint v \bullet dl = n \times \hbar_{gr} . \quad (10.1.1)$$

The condition reduces to the condition on velocity circulation

$$\oint v \bullet dl = n \times \frac{GM}{v_0} . \quad (10.1.2)$$

In simple systems with circular orbits the condition reduces to a universal velocity spectrum $v = v_0/n$ so that only the radii of orbits depend on mass distribution. For systems for which cosmic string dominates only $n = 1$ is possible. This is the case in the case of stars in galactic halo if primordial cosmic string going through the center of galaxy in direction of jet dominates the gravitational potential. The velocity of distant stars is correctly predicted.

For circular orbits there is no need to apply the condition for other canonical momenta (radial canonical momentum in Kepler problem). The nearly circular orbits of visible matter objects would be naturally associated with dark matter rings or more complex structures dark matter rings could suffer partial or complete phase transition to visible matter.

Generalization of the quantization condition

By Equivalence Principle dark ring mass disappears from the quantization conditions and the left hand side of the quantization condition equals to a generalized velocity circulation applying when central system rotates

$$\oint (v - A_{gr}) \bullet dl. \quad (10.1.3)$$

Note that the geodesic motion of visible matter does not mean closed orbit (perihelion shift of Mercury) and cannot therefore correspond exactly to a motion concentrated at partonic 2-surface containing anyonic dark matter unless dark matter itself is rotating slowly. This is not a problem if the dark matter is concentrated at flux tube surrounding the orbit in turn connected by flux tubes to an anyonic 2-surface assignable to Sun.

The right hand side of the quantization condition would be the generalization of GM by the replacement

$$GM \rightarrow \oint e \bullet r^2 E_{gr} \times dl. \quad (10.1.4)$$

e is a unit vector in direction of quantization axis of angular momentum, \times denotes cross product, and r is the radial M^4 coordinate in the preferred system. Everything is Lorentz and General Coordinate Invariant and for Schwarzschild metric this reduces to the expected form and reproduces also the contribution of cosmic string to the quantization condition correctly.

10.2 General quantum vision about formation of structures

The basic observation is that in the case of a straight cosmic string creating a gravitational potential of form v_1^2/ρ Bohr quantization does not pose any conditions on the radii of the circular orbits so that a continuous mass distribution is possible.

This situation is obviously exceptional. If one however accepts the TGD based vision [K73] that the very early cosmology was cosmic string dominated and that elementary particles were generated in the decay of cosmic strings, this situation might have prevailed at very early times. If so, the differentiation of a continuous density of ordinary matter to form the observed astrophysical structures would correspond to an approach to a stationary situation governed by Bohr rules and in the first approximation one could neglect the intermediate stages.

Cosmic string need not be infinitely long: it could branch into flux tubes or flux sheets carrying the return flux. For large distances the whole structure would behave as a single mass point creating ordinary Newtonian gravitational potential. Also phase transitions in which the system emits magnetic flux tubes so that the contribution of the cosmic string to the gravitational force is reduced, are possible.

What is of utmost importance is that the cosmic string induces a breaking of the rotational symmetry selecting a unique preferred orbital plane in which gravitational acceleration is parallel to the plane. This is just what is observed in astrophysical systems and not easily explained in the Newtonian picture. In TGD framework this relates directly to the choice of quantization axis of angular momentum at the level of dark matter. This mechanism could be behind the formation of planar systems in all length scales including planets and their moons, planetary systems, galaxies, galaxy clusters in the scale of Mly, and even the concentration of matter at the walls of large voids in the scale of 100 Mly.

10.2.1 Simple quantitative model

The following elementary model allows to see how the addition of central mass forces the matter to quantized Bohr orbits via the formation of dark matter rings.

The equation for gravitational acceleration

The elementary model for circular orbits involves two equations: the identification radial kinetic acceleration with the acceleration due to the gravitational force and the condition stating quantization of the angular momentum, which requires some additional thought when cosmic string has infinite length.

In cylindrical coordinates the gravitational acceleration due to cosmic string is given by

$$\begin{aligned} a &= \frac{v_1^2}{\rho}, \\ v_1^2 &= G \frac{dM}{dL}. \end{aligned} \quad (10.2.1)$$

Here v_1 is the rotational velocity of the matter around cosmic string neglecting its own gravitational effects.

The condition for the radial acceleration gives

$$u = \frac{1}{\rho} = \frac{v^2 - v_1^2}{GM} . \quad (10.2.2)$$

Quantization of angular momentum

The condition for the quantization of angular momentum is not quite obvious since taking into account the mass of entire cosmic string would give an infinite Planck constant. The resolution of the problem relies on the effective 2-dimensionality and Z_n symmetry of the dark matter for $F - C$ option meaning that it forms rings.

Consider first the situation when only cosmic is present. For dark matter rings it is angular momentum per unit length which is quantized so that Planck constant is replaced with Planck constant per unit length. Hence one has

$$\frac{d\hbar}{dl} = G \times \frac{m}{2\pi} \times \frac{dM}{dL} \times \frac{1}{v_0} = \frac{m}{2\pi} \times \frac{v_1^2}{v_0} . \quad (10.2.3)$$

where m is the mass of dark matter ring. The inclusion of 2π is necessary in order to obtain internal consistency.

The quantization condition for the circular orbits in the presence of only cosmic string would read as

$$\frac{dm}{dl} \times v\rho = n \times \frac{d\hbar}{dl} = n \times \frac{m}{2\pi} \times \frac{v_1^2}{v_0} . \quad (10.2.4)$$

By using $dm/dl = m/2\pi\rho$, one obtains

$$v = n \frac{v_1^2}{v_0} . \quad (10.2.5)$$

Only $n = 1$ is consistent with $v = v_1^2/v_0$ resulting from the condition for the radial acceleration and there is no condition on ρ .

The contribution of the cosmic string to the Planck constant can be identified as

$$\hbar(\text{string}) = m \times \frac{v_1^2}{v_0} \rho . \quad (10.2.6)$$

One can say that a length ρ of cosmic string contributes to the Planck constant, and that the active part of that cosmic string and point on ring define an equilateral triangle with sides 1 and $\sqrt{5}$ so that Golden Mean emerges.

The generalization of this equation to the case when also central mass is present reads as

$$v\rho = n \frac{GM + \frac{v_1^2}{v_0} \rho}{v_0} . \quad (10.2.7)$$

This gives the quantization condition

$$u = \frac{vv_0 - nv_1^2}{nGM} . \quad (10.2.8)$$

Combination of the conditions

The two equations for $u = 1/\rho$ fix the spectrum of velocities and orbital radii. By introducing the parameter $v_1/v_0 = \epsilon$ and the variable $x = v/v_0$ one can write the basic equation as

$$x^2 - \frac{x}{n} = 0 . \quad (10.2.9)$$

The solutions are $x = 0$ and $x = 1/n$. Only the latter solution corresponds to $u > 0$. The same spectrum $v = v_0/n$ of velocities is obtained as in the case of hydrogen atom model so that only the radii are modified. The universality of the velocity spectrum corresponds to the reduction of the quantization of angular momentum to that of circulation implied by the Equivalence Principle.

The radii of the orbits are given by

$$\begin{aligned} \rho(n) &= \frac{n^2}{1 - n^2\epsilon^2} \times r_0 , \\ r_0 &= \frac{GM}{v_0^2} . \end{aligned} \quad (10.2.10)$$

For small values of n one obtains Bohr orbits for hydrogen atom like model. For $n = 1$ there is an upwards scaling of Bohr radius by $1/(1 - \epsilon^2)$. For large values of n the distances between sub-sequent radii begin to rapidly increase and at the limit $n \rightarrow 1/\epsilon$ the radius becomes infinite. Hence only $n < 1/\epsilon$ orbits are possible meaning that the system has necessarily a finite size for a given value of v_0 . Several values of v_0 are however suggested by the Bohr orbit model for the solar system.

10.2.2 Formation of ring like structures

One can consider an initial situation in which one has a continuous mass density rotating with a constant velocity around cosmic string defining the rotation axis of the planet. The situation is inherently unstable and a small perturbation forces the accumulation of both dark and visible matter to Bohr orbits and the upper bound for the value of n implies finite size of the system proportional to the central mass.

Rings of Saturn and Jupiter

The rings of Saturn and Jupiter [E40, E39] could be seen a intermediate states in the process leading to the formation of satellites. Both planets indeed possess a large number of satellites [E40, E39]. This would suggest that Saturn and Jupiter and outer planets in general are younger than the inner planets in accordance with the different values of v_0 . The orbital radii for lowest satellites correspond to $v_0 \rightarrow 16/15v_0$, and $n = 5$ for Saturn and $v_0 \rightarrow 2v_0$ and $n = 5$ for Jupiter from the requirement that the two lowest satellites correspond in a reasonable approximation to the two lowest Bohr orbits. The radii of satellites do not directly correspond to the radii for Bohr orbits. Also the formation of inner and outer satellite systems differing by a fractal scaling from each other can be considered. Same mechanism would be at work in all length

scales and the recently observed dark matter ring associated with a galactic cluster could result by a similar mechanism [E124] .

The hierarchy of dark matters continues to elementary particle level and the differentiation by Bohr rules continues down to these levels. In particular, the formation of clumps of matter in Saturn rings [E43] could be seen as a particular instance of this process.

NASA Hubble Space Telescope Detects Ring of Dark Matter

The following announcement caught my attention during my morning webwalk.

NASA will hold a media teleconference at 1 p.m. EDT on May 15 to discuss the strongest evidence to date that dark matter exists. This evidence was found in a ghostly ring of dark matter in the cluster CL0024+17, discovered using NASA's Hubble Space Telescope. The ring is the first cluster to show a dark matter distribution that differs from the distribution of both the galaxies and the hot gas. The discovery will be featured in the May 15 issue of the Astrophysical Journal.

"Rings" puts bells ringing! Recall that in TGD Universe dark matter characterized by a gigantic value of constant [K30] making dark matter a macroscopic quantum phase in astrophysical length and time scales. In the model of planetary orbits the rings of dark matter around Bohr orbits force the visible matter at Bohr orbits. Rings- and also shell like structures - connected by radial flux tubes to central anyonic surface are expected in all length scales, even that for galaxy clusters and large voids.

Recall that the number theoretic hypothesis for the preferred values of Planck constants states that the gravitational Planck constant

$$\hbar = \frac{GMm}{v_0}$$

equals to a ruler-and-compass rational which is ratio $q = n_1/n_2$ of ruler-and-compass integers n_i expressible as a product of form $n = 2^k \prod F_s$, where all Fermat primes F_s are different. Only four of them are known and they are given by 3, 5, 17, 257, $2^{16} + 1$. $v_0 = 2^{-11}$ applies to inner planets and $v_0 = 2^{-11}/5$ to outer planets and the conditions from the quantization of \hbar are satisfied.

The obvious TGD inspired hypothesis is that the dark matter ring corresponds to Bohr orbit. If so, the radius of the ring is given by

$$r_n = n^2 r_0 \ ,$$

where r_0 is Bohr radius and n is integer. The Bohr radius is given

$$r_0 = \frac{GM}{v_0^2} \ ,$$

where one has $1/v_0 = k \times 2^{11}$, k a small integer with preferred value $k = 1$. M is the total mass in the dense core region inside the ring. This would give a radius of about 2000 times Schwarzschild radius for the lowest orbit.

This prediction can be confronted with the data [E124] .

- (a) From the "Summary and Conclusions" of the article the radius of the ring is about .4 Mpc, which makes in a good approximation $r=1.2$ Mly. The ring corresponds actually to a bump in the interval 60"-85" centered at 75" (figure 10 of [E124] gives idea about the bump). The mass in the dense core within radius which is almost half of the ring radius is about $M = 1.5 \times 10^{14} \times M_{Sun}$. The mass estimate based on gravitational lensing gives $M = 1.8 \times 10^{14} \times M_{Sun}$. If the gravitational lensing involves dark mass not in the central core, the first value can be used as the estimate. The Bohr radius this system is therefore

$$r_0 = 1.5 \times 10^{14} \times r_0(\text{Sun}) ,$$

where I have assumed $v_0 = 2^{-11}$ as for the inner planets in the model for the solar system.

- (b) The Bohr orbit for our planetary system predicts correctly Mercury's orbital radius as $n=3$ Bohr orbit for $v_0 = 2^{-11}$ so that one has

$$r_0(\text{Sun}) = \frac{r_M}{9} ,$$

where r_M is Mercury's orbital radius. This gives

$$r_0 = 1.5 \times 10^{14} \times \frac{r_M}{9} .$$

Mercury's orbital radius is in a good approximation $r_M = .4 \text{ AU} = .016 \text{ ly}$. This gives $r_0 = 11 \text{ Mly}$ to be compared with $r_0 = 1.2 \text{ Mly}$ deduced from the observations. The result is 9 times too large.

- (c) If one replaces v_0 with $3v_0$ one obtains downwards scaling by a factor of 1/9, which gives $r_0 = 1.2 \text{ Mly}$ which can be found from the Summary and Conclusions of [E124]. The general hypothesis indeed allows to scale v_0 by a factor 3.
- (d) If one considers instead of Bohr orbits genuine solutions of Schrödinger equation then only $n > 1$ structures can correspond to rings like structures. Minimal option would be $n = 2$ with v_0 replaced with $6v_0$.

The conclusion would be that the ring could correspond to the lowest possible Bohr orbit for $v_0 = 3 \times 2^{-11}$. I would have been really happy if the favored value of v_0 had appeared in the formula but the consistency with the ruler-and-compass hypothesis serves as a consolation. Skeptic can of course always argue that this is a pure accident. If so, it would be an addition to long series of accidents (planetary radii in solar system and radii of exoplanets). One can of course search rings at radii corresponding to $n = 2, 3, \dots$

10.2.3 A quantum model for the dark part of the central mass and rings

It is interesting to look for a simple quantum model for the dark part of the central mass and possibly also of rings. As a first approximation one can consider a cylindrically symmetric pan-cake of height L and radius R . Approximate spherical symmetry suggest $L = 2R$.

The governing conditions are

$$\begin{aligned} v^2(\rho) &= G(dM/dl)(\rho) + v_1^2 , \\ v(\rho) &= \frac{v_0}{n} . \end{aligned} \tag{10.2.11}$$

Previous considerations suggest that the v_1^2 term from the cosmic string can be neglected. The general prediction is that the system has finite size and mass irrespective of the form of the distribution.

Four options

One can consider four kinds of mass distributions.

- (a) The scaling law $(dM/dl)(\rho) \propto K(\rho/\rho_0)^k$, $k \geq 0$, implies

$$\begin{aligned} v(\rho) &= \sqrt{GK}(\rho/\rho_0)^{k/2} , \\ \omega(\rho) &= \sqrt{GK}(\rho/\rho_0)^{k/2-1} , \\ \rho(n) &= \rho_0(v_0/\sqrt{GK})^{2/k} \times n^{-2/k} . \end{aligned} \tag{10.2.12}$$

The radii decrease as $n^{-2/k}$ and largest radius is $\rho_0(v_0^2/GK)$. For constant mass density one obtains $k = 2$, rigid body rotation, and $\rho = \rho_0/n$ so that kind of reverted harmony of spheres would result. Quite generally, $v(\rho)$ is a non-decreasing function of ρ from the first condition. This reflects the 2-dimensionality of the situation.

- (b) If the mass distribution is logarithmic $M(\rho) = K \log^2(\rho/\rho_0)$ one has $v = \sqrt{GK} \log(\rho/\rho_0)$ and $\rho(n) = \rho_0 \exp(k/n)$, $k = v_0/\sqrt{GK}$. One obtains what might be regarded as a cylindrical shell $\rho/\rho_0 \in [1, e^k]$ and with density $dM/dl \propto 2 \log(\rho)/\rho$. This kind of distribution could work in the case of planetary rings if the tidal effects of the central mass can be neglected.
- (c) p-Adic length scale hypothesis suggest the distribution $\rho(n) = 2^{-k} \rho_0$ for the radii of the "mass shells". This would give $v(\rho) = v_0/|\log_2(\rho/\rho_0)|$ and

$$(dM/dl)(\rho) = \frac{v_0^2}{G|\log_2(\rho/\rho_0)|^2} = \frac{M}{r_0|\log_2(\rho/\rho_0)|^2} .$$

Note that the most general form of p-adic length scale hypothesis allows $\rho(n) = 2^{-k/2} \rho_0$. This option defines the only working alternative for the dark central mass. Note that this would explain Titius-Bode law [E53] if planets have formed around dark matter shells or rings which have formed part of Sun during primordial stage.

- (d) The distribution of radii of form $\rho(n)/\rho_0 = x - n$ might serve as a model for planetary rings if the tidal effects of the central mass can be neglected. In this case one as

$$(dM/dl)(\rho) = \frac{M}{r_0(x - \frac{\rho}{\rho_0})^2} .$$

The radius R must satisfy $R < x\rho_0$. The masses of the annuli must increase with ρ .

Only the p-adic variant works as a model for central mass

It is interesting to look what the three variants of the model would predict for the radius of Earth. If the pancake has height $2R$, the relationship between radius and total mass can be expressed as $M = 2\pi(dM/dl)R^3$. Using $M_E = 3 \times 10^{-6} M_{Sun}$, and $r_0(Sun) \simeq R_M/9$, where $r_M = 5.8 \times 10^4$ Mm is the orbital radius of Mercury, one obtains by scaling $r_0 = GM_E/v_0^2 \simeq 20$ km for $v_0 = 2^{-11}$.

- (a) The options 1) and 2) fail. Constant density would give $R = 140$ km, which is about 2 per cent of the actual radius $R_E = 6.372797$ Mm and 10 percent about the radius 1.2 Mm of the inner core. The "inner inner core" of Earth happens to have radius of 300 km. For the logarithmic mass distribution one would obtain $R = r_0/2 \simeq 10$ km.
- (b) The option 3) inspired by the p-adic length scale hypothesis works and predicts $k^2 |\log_2(R/\rho_0)|^2 = 2R/r_0$. $\rho_0 = 2R$ gives $k \simeq 25$. This alternative works also in the more general case since one can make the radius arbitrarily large by a proper choice of the integer k . The universal prediction would be that dark matter appears as shells corresponding to decreasing p-adic length scales coming as powers $p \simeq 2^k$. The situation would be very much analogous to that in atomic physics. The prediction conforms with the many-sheeted generalization of the model for the asymptotic state of the star for which the matter is concentrated on a thin cell [K85]. The model brings in mind also the large voids of size about 100 Mly.

- (c) The suspiciously small value of r_0 forces to ask whether the value of v_0 for Earth should be much smaller than $v_0 = 2^{-11}$. Also the radius of Moon's orbit would require $n \sim 138$ for this value to be compared with $n \geq 5$ for the moons of Saturn and Jupiter. If the age of Earth is much longer than that of outer planets, one would expect that more phase transitions reducing v_0 forced by the cosmic expansion in average sense have taken place. $v_0 \rightarrow v_0/20$ would give $r_0 \simeq 8$ Mm to be compared with $R_E = 6.4$ Mm. Moon's orbit would correspond to $n = 7$ in a reasonable approximation. This choice of v_0 would allow $k = 1$.

The small value of v_0 might be understood from the fact that inner planets are older than outer ones so that the cosmic expansion in the average sense has forced larger number of phase transitions reducing the value of v_0 inducing a fractal scaling of the system. Ruler-and-compass hypothesis [K72] suggests preferred values of cosmic times for the occurrence of these transitions. Without this hypothesis the phase transitions could form almost continuum. For this option the failure of options 1) and 2) is even worse.

10.2.4 Two stellar components in the halo of Milky Way

Bohr orbit model for astrophysical objects suggests that also galactic halo should have a modular structure analogous to that of planetary system or the rings of Saturn rather than that predicted by continuous mass distribution. Quite recently it was reported that the halo of Milky Way - earlier thought to consist of single component - seems to consist of two components [E108, E185]. Even more intriguingly, the stars in these halos rotate in opposite directions. The average velocities of rotation are about 25 km/s and 50 km/s for inner and outer halos respectively. The inner halo corresponds to a range 10-15 kpc of orbital radii and outer halo to 15-20 kpc. Already the constancy of rotational velocity is strange and its increase even stranger. The orbits in inner halo are more eccentric with axial ratio $r_{min}/r_{max} \simeq .6$. For outer halo the ratio varies in the range .9 - 1.0. The abundances of elements heavier than Lithium are about 3 times higher in the inner halo which suggests that it has been formed earlier.

Bohr orbit model would explain halos as being due to the concentration of visible matter around ring like structures of dark matter in macroscopic quantum state with gigantic gravitational Planck constant. This would explain also the opposite directions of rotation.

One can consider two alternative models predicting constant rotation velocity for circular orbits. The first model allows circular orbits with arbitrary plane of rotation, second model and the hybrid of these models only for the orbits in galactic plane.

- (a) The original model assumes that galactic matter has resulted in the decay of cosmic string like object so that the mass inside sphere of radius R is $M(R) \sim kR$.
- (b) In the second model the gravitational acceleration is due to gravitational field of a cosmic string like object transversal to the galactic plane. String creates no force parallel to string but $1/\rho$ radial acceleration orthogonal to the string. Of course, there is the gravitational force created by galactic matter itself. One can also associate cosmic string like objects with the circular halos themselves and it seems that this is needed in order to explain the latest findings.

The big difference in the average rotation velocities $\langle v_\phi \rangle$. or inner and outer halos cannot be understood solely in terms of the high eccentricity of the orbits in the inner halo tending to reduce $\langle v_\phi \rangle$. Using the conservation laws of angular momentum ($L = mv_{min}\rho_{max}$) and of energy in Newtonian approximation one has $\langle v_\phi \rangle = \rho_{max}v_{min}\langle 1/\rho \rangle$. This gives the bounds

$$v_{min} < \langle v_\phi \rangle < v_{max} = v_{min} \frac{\rho_{max}}{\rho_{min}} \simeq 1.7v_{min} .$$

For both models $v = v_0 = \sqrt{k}$, $k = TG$, (T is the effective string tension) for circular orbits. Internal consistency would require $v_{min} < \langle v_\phi \rangle \simeq .5v_0 < v_{max} \simeq 1.7v_{min}$. On the other hand,

$v_{max} > v_0$ and thus $v_{min} > .6v_0$ must hold true since the sign of radial acceleration for ρ_{min} is positive. $.5v_0 > v_{min} > .6v_0$ means a contradiction.

The big increase of the average rotation velocity suggests that inner and outer halos correspond to closed cosmic string like objects around which the visible matter has condensed. The inner string like object would create an additional gravitational field experienced by the stars of the outer halo. The increase of the effective string tension by factor x corresponds to the increase of $\langle v_\phi \rangle$ by a factor \sqrt{x} . The increase by a factor 2 plus higher eccentricity could explain the ratio of average velocities.

10.3 Quantum chaos in astrophysical length scales

The stimulus for writing this section came from the article "Quantum Chaos" by Martin Gurtzwiller [B39]. Occasionally it can happen that even this kind of a masterpiece of scientific writing manages to stimulate only an intention to read it more carefully later. When you indeed read it again years later it can shatter you into a wild resonance. Just this occurred at this time.

10.3.1 Brief summary about quantum chaos

The article discusses of Gurtzwiller the complex regime between quantal and classical behavior as it was understood at the time of writing (1992). As a non-specialist I have no idea about possible new discoveries since then.

The article introduces the division of classical systems into regular (R) and chaotic (P in honor of Poincare) ones. Besides this one has quantal systems (Q). There are three transition regions between these three realms.

- (a) R-P corresponds to transition to classical chaos and KAM theorem is a powerful tool allowing to organize the view about P in terms of surviving periodic orbits.
- (b) Quantum-classical transition region R-Q corresponds to high quantum number limit and is governed by Bohr's correspondence principle. Highly excited hydrogen atom - Rydberg atom - defines a canonical example of the situation.
- (c) Somewhat surprisingly, it has turned out that also P-Q region can be understood in terms of periodic classical orbits (nothing else is available!). P-Q region can be achieved experimentally if one puts Rydberg atom in a strong magnetic field. At the weak field limit quantum states are delocalized but in chaotic regime the wave functions become strongly concentrated along a periodic classical orbits.

At the level of dynamics the basic example about P-Q transition region discussed is the chaotic quantum scattering of electron in atomic lattice. Classical description does not work: a superposition of amplitudes for orbits, which consist of pieces which are fragments of a periodic orbit plus localization around atom is necessary.

The fractal wave function patterns associated with say hydrogen atom in strong magnetic field are extremely beautiful and far from chaotic. Even in the case of chaotic quantum scattering one has interference of quantum amplitudes for classical Bohr orbits and also now Fourier transform exhibits nice peaks corresponding to the periods of classical orbits. The term chaos seems to be an unfortunate choice referring to our limited cognitive capacities rather than the actual physical situation and the term quantum complexity would be more appropriate.

- (d) For a consciousness theorist the challenge is to try to formulate in a more precise manner this fact. Quantum measurement theory with a finite measurement resolution indeed provide the mathematics necessary for this purpose.

10.3.2 What does the transition to quantum chaos mean?

The transition to quantum chaos in the sense the article discusses it means that a system with a large number of virtually independent degrees of freedom (in very general sense) makes a transition to a phase in there is a strong interaction between these degrees of freedom. Perturbative phase becomes non-perturbative. This means emergence of correlations and reduction of the effective dimension of the system to a finite fractal dimension. When correlations become complete and the system becomes a genuine quantum system, the dimension of the system is genuinely reduced and again non-fractal. In this sense one has transition via complexity to new kind of order.

The level of stationary states

At the level of energy spectrum this means that the energy of system which correspond to sums of virtually independent energies and thus is essentially random number becomes non-random. As a consequence, energy levels tend to avoid each other, order and simplicity emerge but at the collective level. Spectrum of zeros of Zeta has been found to simulate the spectrum for a chaotic system with strong correlations between energy levels. Zeta functions indeed play a key role in the proposed description of quantum criticality associated with the phase transition changing the value of Planck constant.

The importance of classical periodic orbits in chaotic scattering

Poincare with his immense physical and mathematical intuition foresaw that periodic classical orbits should have a key role also in the description of chaos. The study of complex systems indeed demonstrates that this is the case although the mathematics and physics behind this was not fully understood around 1992 and is probably not so even now. The basic discovery coming from numerical simulations is that the Fourier transform of a chaotic orbits exhibits peaks at frequencies which correspond to the periods of closed orbits. From my earlier encounters with quantum chaos I remember that there is quantization of periodic orbits so that their periods are proportional to $\log(p)$, p prime in suitable units. This suggests a connection of arithmetic quantum field theory and with p -adic length scale hypothesis.

The chaotic scattering of electron in atomic lattice is discussed as a concrete example. In the chaotic situation the notion of electron consists of periods spend around some atom continued by a motion along along some classical periodic orbit. This does not however mean loss of quantum coherence in the transitions between these periods: a purely classical model gives non-sensible results in this kind of situation. Only if one sums scattering amplitudes over all piecewise classical orbits (not all paths as one would do in path integral quantization) one obtains a working model.

In what sense complex systems can be called chaotic?

Speaking about quantum chaos instead of quantum complexity does not seem appropriate to me unless one makes clear that it refers to the limitations of human cognition rather than to physics. If one believes in quantum approach to consciousness, these limitations should reduce to finite resolution of quantum measurement not taken into account in standard quantum measurement theory.

In the framework of hyper-finite factors of type II_1 finite quantum measurement resolution is described in terms of inclusions $\mathcal{N} \subset \mathcal{M}$ of the factors and sub-factor \mathcal{N} defines what might be called \mathcal{N} -rays replacing complex rays of state space. The space \mathcal{M}/\mathcal{N} has a fractal dimension characterized by quantum phase and increases as quantum phase $q = \exp(i\pi/n)$, $n = 3, 4, \dots$, approaches unity which means improving measurement resolution since the size of the factor \mathcal{N} is reduced.

Fuzzy logic based on quantum qbits applies in the situation since the components of quantum spinor do not commute. At the limit $n \rightarrow \infty$ one obtains commutativity, ordinary logic, and

maximal dimension. The smaller the n the stronger the correlations and the smaller the fractal dimension. In this case the measurement resolution makes the system effectively strongly correlated as n approaches its minimal value $n = 3$ for which fractal dimension equals to 1 and Boolean logic degenerates to single valued totalitarian logic.

Non-commutativity is the most elegant description for the reduction of dimensions and brings in reduced fractal dimensions smaller than the actual dimension. Again the reduction has interpretation as something totally different from chaos: system becomes a single coherent whole with strong but not complete correlation between different degrees of freedom. The interpretation would be that in the transition to non-chaotic quantal behavior correlation becomes complete and the dimension of system again integer valued but smaller. This would correspond to the cases $n = 6$, $n = 4$, and $n = 3$ ($D = 3, 2, 1$).

10.3.3 Quantum chaos in astrophysical scales?

The following considerations represent an updated form of the first sketch about how quantum chaos could emerge in astrophysical length scales.

Transition to quantum chaos as reduction of the symmetry groups G_a and G_b

Anyonic 2-surfaces formed by flux tubes around orbits of massive objects connected to the central nearly spherical anyonic 2-surfaces by radial flux tubes and characterized by a fixed value of v_0 is the first key element of the picture. Second key element is the general formula for Planck constant forcing to conclude that the sequential de-coherence reducing (n_a, n_b) gradually to $(n_a, n_b) = (1, 1)$ requires generation of sub-harmonics of the original graviton frequency in the situation when $r = \hbar/\hbar_0$ is genuine rational $r = m/n$.

The transition to chaos must always correspond to a reduction of the symmetries so that $(n_a, n_b) = (1, 1)$ phase is maximally chaotic. Only for $C - C$ option this process corresponds always to a reduction of Planck constant. There are two mechanisms of de-coherence: the first one is favored for the factor space option and second one for the covering space option.

- (a) Assuming conservation of energy and number of quanta in phase transitions (so that quanta leak between the pages of the Big Book) one has $E = \hbar\omega = \hbar_0\omega_0$ giving $\omega = \omega_0/r$, $r = \hbar/\hbar_0$. For $C - C$ resp. $F - C$ option this gives $\omega = \omega_0/(n_a n_b)$ resp. $\omega = \omega_0 \times (n_a/n_b)$. For $C - C$ option de-coherence process would mean a sequence of transitions in which frequencies steadily increase: this does not look plausible in the case of large \hbar gravitons. For $F - C$, $C - F$ and $F - F$ options de-coherence can also reduce frequencies. If n_i are proportional to multiples of 2^k as ruler and compass hypothesis implies, period doubling regarded as a possible route to chaos is also involved but the number of period doublings is always finite. For classical orbits this would correspond to the emergence of small perturbations with n -fold period spoiling exact periodicity. Ruler-and-compass hypothesis implies very powerful predictions for the resulting frequency spectrum. This mechanism is natural for the reduction of n_i in the case of factor space option.
- (b) For the second mechanism frequencies are not affected so that energy conservation requires the decay of quantum to a bundle of quanta with a smaller value of Planck constant. The reduction factor for the energy is $R = r_f/r_i$ and the number of quanta is $N = r_i/r_f$ and integer if the reduction of Planck constant occurs only for the reduction of n_i for covering space option, which is thus favored.

Quantum criticality and chaos

- (a) TGD Universe is quantum critical. The most important implication of quantum criticality of TGD Universe is that it fixes the value of Kähler coupling strength, the only free parameter appearing in definition of the theory as the analog of critical temperature. The dark matter hierarchy characterized partially by the increasing values of Planck constant allows

to characterize more precisely what quantum criticality might mean. By quantum criticality space-time sheets are analogs of Bohr orbits. Since quantum criticality corresponds to P-Q region, the localization of wave functions around generalized Bohr orbits should occur quite generally in some scale.

- (b) Elementary particles are maximally quantum critical systems analogous to H₂O at tricritical point and can be said to be in the intersection of imbedding spaces labeled by various values of Planck constants. Planck constant does not characterize the elementary particle proper. Rather, each field body of particle (em, weak, color, gravitational) is characterized by its own Planck constant and this Planck constant characterizes interactions. The generalization of the notion of the imbedding space allows to formulate this idea in precise manner and each sector of imbedding space is characterized by discrete symmetry groups G_a and G_b acting in CD and CP_2 degrees of freedom either on covering or orbifold.
- (c) Dark matter hierarchy makes TGD Universe an ideal laboratory for studying P-Q transitions with chaos identified as quantum critical phase between two values of Planck constant with larger value of Planck constant defining the "quantum" phase and smaller value the "classical" phase. Dark matter is localized near Bohr orbits and is analogous to quantum states localized near the periodic classical orbits. Planetary Bohr orbitology provides a particularly interesting astrophysical application of quantum chaos.
- (d) The above described picture applies about chaotic quantum scattering applies quite generally in quantum TGD. Path integral is replaced with a functional integral over classical space-time evolutions and the failure of the complete classical non-determinism is analogous to the transition between classical orbits. Functional integral also reduces to perturbative functional integral around maxima of Kähler function.

Dark matter structures as generalization of periodic orbits

The matter with ordinary or smaller value of Planck constant can form bound states with these dark matter structures. The dark matter circles would be the counterparts for the periodic Bohr orbits dictating the behavior of the quantum chaotic system. Visible matter (and more generally, dark matter at the lower levels of hierarchy behaving quantally in shorter length and time scales) tends to stay around these periodic orbits and in the ideal case provides a perfect classical mimicry of quantum behavior. Dark matter structures would effectively serve as selectors of the closed orbits in the gravitational dynamics of visible matter.

As one approaches classicality the binding of the visible matter to dark matter gradually weakens. Mercury's orbit is not quite closed, planetary orbits become ellipses, comets have highly eccentric orbits or even non-closed orbits. For non-closed quantum description in terms of binding to dark matter does not make sense at all.

The classical regular limit (R) would correspond to a decoupling between dark matter and visible matter. A motion along geodesic line is obtained but without Bohr quantization in gravitational sense since Bohr quantization using ordinary value of Planck constant implies negative energies for $GMm \geq 1$. The preferred extremal property of the space-time sheet could however still imply some quantization rules but these might apply in "vibrational" degrees of freedom.

Quantal chaos in gravitational scattering?

The chaotic motion of astrophysical object becomes the counterpart of quantum chaotic scattering. By Equivalence Principle the value of the mass of the object does not matter at all so that the motion of sufficiently light objects in solar system might be understandable only by assuming quantum chaos.

The orbit of a gravitationally unbound object such as comet could define the basic example. The rings of Saturn and Jupiter could represent interesting shorter length scale phenomena possible involving quantum scattering. One can imagine that the visible matter object spends some time around a given dark matter circle (binding to atom), makes a transition along a radial spoke to the next circle, and so on.

The prediction is that dark matter forms rings and cart-wheel like structures of astrophysical size. These could become visible in collisions of say galaxies when stars get so large energy as to become gravitationally unbound and in this quantum chaotic regime can flow along spokes to new Bohr orbits or to gravi-magnetic flux tubes orthogonal to the galactic plane. Hoag's object represents a beautiful example of a ring galaxy [E128]. Remarkably, there is direct evidence for galactic cart-wheels (for pictures of them see [E7]). There are also polar ring galaxies consisting of an ordinary galaxy plus ring approximately orthogonal to it and believed to form in galactic collisions [E32]. The ring rotating with the ordinary galaxy can be identified in terms of gravi-magnetic flux tube orthogonal to the galactic plane.

10.4 Gravitational radiation and large value of gravitational Planck constant

The description of gravitational radiation provides a stringent test for the idea about dark matter hierarchy with arbitrary large values of Planck constants. In accordance with quantum classical correspondence, one can take the consistency with classical formulas as a constraint allowing to deduce information about how dark gravitons interact with ordinary matter. In the following standard facts about gravitational radiation are discussed first and then TGD based view about the situation is sketched.

10.4.1 Standard view about gravitational radiation

Gravitational radiation and the sources of gravitational waves

Classically gravitational radiation corresponds to small deviations of the space-time metric from the empty Minkowski space metric [E19]. Gravitational radiation is characterized by polarization, frequency, and the amplitude of the radiation. At quantum mechanical level one speaks about gravitons characterized by spin and light-like four-momentum.

The amplitude of the gravitational radiation is proportional to the quadrupole moment of the emitting system, which excludes systems possessing rotational axis of symmetry as classical radiators. Planetary systems produce gravitational radiation at the harmonics of the rotational frequency. The formula for the power of gravitational radiation from a planetary system given by

$$P = \frac{dE}{dt} = \frac{32}{5} \frac{G^4 M_1^2 M_2^2 (M_1 + M_2)}{R^5} . \quad (10.4.1)$$

This formula can be taken as a convenient quantitative reference point.

Planetary systems are not very effective radiators. Because of their small radius and rotational asymmetry supernovas are much better candidates in this respect. Also binary stars and pairs of black holes are good candidates. In 1993, Russell Hulse and Joe Taylor were able to prove indirectly the existence of gravitational radiation. Hulse-Taylor binary [E20] consists of ordinary star and pulsar with the masses of stars around 1.4 solar masses. Their distance is only few solar radii. Note that the pulsars have small radius, typically of order 10 km. The distance between the stars can be deduced from the Doppler shift of the signals sent by the pulsar. The radiated power is about 10^{22} times that from Earth-Sun system basically due to the small value of R . Gravitational radiation induces the loss of total energy and a reduction of the distance between the stars and this can be measured.

How to detect gravitational radiation?

Concerning the detection of gravitational radiation the problems are posed by the extremely weak intensity and large distance reducing further this intensity. The amplitude of gravitational radiation is measured by the deviation of the metric from Minkowski metric, denote by h .

Weber bar [E19] provides one possible manner to detect gravitational radiation. It relies on a resonant amplification of gravitational waves at the resonance frequency of the bar. For a gravitational wave with an amplitude $h \sim 10^{-20}$ the distance between the ends of a bar with length of 1 m should oscillate with the amplitude of 10^{-20} meters so that extremely small effects are in question. For Hulse-Taylor binary the amplitude is about $h = 10^{-26}$ at Earth. By increasing the size of apparatus one can increase the amplitude of stretching.

Laser interferometers provide second possible method for detecting gravitational radiation. The masses are at distance varying from hundreds of meters to kilometers [E19]. LIGO (the Laser Interferometer Gravitational Wave Observatory) consists of three devices: the first one is located with Livingston, Louisiana, and the other two at Hanford, Washington. The system consist of light storage arms with length of 2-4 km and in angle of 90 degrees. The vacuum tubes in storage arms carrying laser radiation have length of 4 km. One arm is stretched and one arm shortened and the interferometer is ideal for detecting this. The gravitational waves should create stretchings not longer than 10^{-17} meters which is of same order of magnitude as intermediate gauge boson Compton length. LIGO can detect a stretching which is even shorter than this. The detected amplitudes can be as small as $h \sim 5 \times 10^{-22}$.

10.4.2 Quantum mechanisms for the emission of gravitational radiation

Whether the classical gravitational radiation corresponds to that coming from the transitions between Bohr orbits is far from being a trivial question. At this moment it is not possible to calculate the transition rates but it turns out that $n = 3 \rightarrow 1$ transition is consistent with classical radiation formula for Hulse-Taylor binary [E20] under reasonable assumption about the reaction rate. Ordinary gravitational radiation could be also associated with the sequence of phase transitions reducing h_{gr} . Under same assumption the rate is of the same order of magnitude. Both options force to consider the possibility that gravitational radiation generated in spontaneous transitions is a rather rare phenomenon.

Some quantitative estimates for gravitational quantum transitions in planetary system

To get a concrete grasp about the situation it is useful to study the energies of dark gravitons in the case of planetary system assuming Bohr model.

The expressions for the energies of dark gravitons can be deduced from those of hydrogen atom using the replacements $Ze^2 \rightarrow 4\pi GMm$, $\hbar \rightarrow GMm/v_0$. The energies are given by

$$\begin{aligned} E_n &= \frac{1}{n^2} E_1, \\ E_1 &= (Z\alpha)^2 \frac{m}{4} = \left(\frac{Ze^2}{4\pi\hbar}\right)^2 \times \frac{m}{4} \rightarrow \frac{m}{4} v_0^2. \end{aligned} \quad (10.4.2)$$

E_1 defines the energy scale. Note that v_0 defines a characteristic velocity if one writes this expression in terms of classical kinetic energy using virial theorem $T = -V/2$ for the circular orbits. This gives $E_n = T_n = mv_n^2/2 = mv_0^2/4n^2$ giving

$$v_n = \frac{v_0}{\sqrt{2}n}.$$

Orbital velocities are quantized as sub-harmonics of the universal velocity $v_0/\sqrt{2} = 2^{-23/2}$ and the scaling of v_0 by $1/n$ scales does not lead out from the set of allowed velocities.

Bohr radius scales as

$$r_0 = \frac{\hbar}{Z\alpha m} \rightarrow \frac{GM}{v_0^2} . \quad (10.4.3)$$

For $v_0 = 2^{11}$ this gives $r_0 = 2^{22}GM \simeq 4 \times 10^6 GM$. In the case of Sun this is below the value of solar radius but not too much.

The frequency $\omega(n, n-k)$ of the dark graviton emitted in $n \rightarrow n-k$ transition and orbital rotation frequency ω_n are given by

$$\begin{aligned} \omega(n, n-k) &= \frac{v_0^3}{GM} \times \left(\frac{1}{n^2} - \frac{1}{(n-k)^2} \right) \simeq 2k\omega_n . \\ \omega_n &= \frac{v_0^3}{GMn^3} . \end{aligned} \quad (10.4.4)$$

The emitted frequencies at the large n limit are harmonics of the orbital rotation frequency so that quantum classical correspondence holds true. For low values of n the emitted frequencies differ from harmonics of orbital frequency.

The energy emitted in $n \rightarrow n-k$ transition would be

$$E(n, n-k) = mv_0^2 \times \left(\frac{1}{n^2} - \frac{1}{(n-k)^2} \right) , \quad (10.4.5)$$

and obviously enormous. Single giant (spherical) dark graviton would be emitted in the transition and should decay to gravitons with smaller values of \hbar . Bunch like character of the detected radiation might serve as the signature of the process. The bunch like character of liberated dark gravitational energy means coherence and might play role in the coherent locomotion of living matter. For a pair of systems of masses $m = 1$ kg this would mean $Gm^2/v_0 \sim 10^{20}$ meaning that exchanged dark graviton corresponds to a bunch containing about 10^{20} ordinary gravitons. The energies of graviton bunches would correspond to the differences of the gravitational energies between initial and final configurations which in principle would allow to deduce the Bohr orbits between which the transition took place. Hence dark gravitons could make possible the analog of spectroscopy in astrophysical length scales.

The power of graviton radiation emitted in the transition between two Bohr orbits

If dark matter is at stationary states and does not leak between pages of the Big Book with different Planck constant, it does not radiate at all except during the transitions reducing the value of n . Gravitational radiation would be emitted as bursts and these transitions need not have anything to do with quadrupole radiation.

The shortening of the orbital period of Hulse-Taylor binary can be explained with .2 per cent accuracy in terms of energy loss due to gravitational radiation so that the task is to check whether the average power from the transitions between Bohr orbits is consistent with the classical formula or not. To achieve this, one must estimate the average power associated with the transition $n \rightarrow n+k$ for the Bohr orbit model of a two-body system.

(a) For the energy liberated energy as gravitational radiation one obtains

$$E_{tot} = E_n - E_{n-k} = \hbar_{gr}\omega = \frac{mv_0^2}{4}((n-k)^{-2} - n^{-2}) \simeq \frac{2kmv_0^2}{n^3} . \quad (10.4.6)$$

- (b) In order to estimate the average power of radiation one must have an estimate for the time T during which the radiation is emitted. $T \sim 2\pi/\omega$ gives lower bound for T . A more general guess is $T \simeq a(2\pi/\omega)v_0^{-p}$, where a is a numerical constant of order unity. This gives estimate for the total average power

$$P_q \sim \frac{E_{tot}}{T} = \frac{\hbar_{gr}\omega^2 v_0^p}{2\pi a} = \frac{GMm v_0^{p+1}}{2\pi a r_n^2} F(n) ,$$

$$F(n, k) = \left(\left(\frac{n}{n-k} \right)^2 - 1 \right)^2 \simeq \frac{4k^2}{n^2} , \quad r_n = n^2 \frac{GM}{v_0^2} .$$
(10.4.7)

r_n denotes the radius of n :th Bohr orbit. Note that P_q increases as n^2 for large values of n .

- (c) If the radius R in the formula for the quadrupole radiation powers is identified as Bohr radius r_{n-1} , the ratio of the power P_{cl} emitted by quadrupole radiation to P_q is

$$R \equiv \frac{P_{cl}}{P_q} \simeq ax \times y \times F(n, k)^{-1} \times v_0^{5-p} ,$$

$$x = \frac{2^6 \pi}{5} , \quad y = \frac{(M+m)m}{M^2} .$$
(10.4.8)

The dependence on v_0 disappears for $p = 5$. For a binary system with $m = M$ the orders of magnitude are same so that $p = 5$ is the the unique choice of one wants an approximate consistency with the classical formula. For $M = m$, $(n, k) = (3, 2)$, $n = 3$, $(a, p) = (.796, 5)$ gives $R = 1$. For $(n, k) = (3, 1)$ $a = .112$ is required for $R = 1$. For larger values of n the needed value of a increases because R decreases as $1/n^4$.

For the Hulse-Taylor binary [E20] the masses are $1.441M_S$ and $1.387M_S$ and nearly identical. The semi-major axis is $R = 1.95 \times 10^6$ km and the orbital period is $T = 7.75$ hr. From $T = 2\pi/\omega = 2\pi GM(n/v_0)^3$ one can estimate $(n/v_0)^3$ using the mnemonic $r_s = 2GM = (M/M_S) \times 2.95$ km. This gives $v_0 = n \times 1.2 \times 10^{-3}$. From $r_n = n^2 GM/v_0^2 \sim R$ one obtains $v_0 = n \times 1.0 \times 10^{-3}$. These conditions are not actually independent. Assuming that $n = 3 \rightarrow 1$ transition is in question one has $v_0 \simeq 3 \times 10^{-3}$. That v_0 is larger for Hulse-Taylor binary than solar system conforms with the general expectation that at black-hole limit v_0 approaches to $v_0 = 1$.

The estimated time before the final spiral takes place is $\tau = 3 \times 10^8$ years. For the estimated value of v_0 the time for the transition between states n and $n-1$ would be $\tau \sim av_0^{-5} 5T \simeq 2.8972 \times 10^9$ years, which is consistent with the classical estimate. It seems that the interpretation as quantum transition could make sense. If the interpretation is correct it could mean that gravitational radiation is rather rare phenomenon since the quantum transitions between stationary states are expected to be rare occurrences.

Could ordinary gravitational radiation be radiation emitted in the reduction of gravitational Planck constant

The Bohr model for Hulse-Taylor binary predicts a reasonable value of v_0 and the interpretation as a transition between Bohr orbits makes sense if the transition in question is $n = 3 \rightarrow 1$ transition leading to the ground state. One can consider also other mechanism producing gravitational radiation.

- (a) The model for Hulse-Taylor and also other data suggest that v_0 increases as the planetary system gets older. This raises the possibility that gravitational radiation is emitted in transitions increasing the value of the velocity parameter v_0 as as dark matter leaks to the pages of the Big Book with smaller Planck constant. This assumption is consistent with second law and with the vision about how system approaches to chaos. If $1/v_0$ is integer the number of these transitions would be relatively small. If v_0 is a ratio of very big

integers situation changes. v_0 cannot exceed light velocity so that in the limiting situation $v_0 \leq 1$ holds true. The asymptotic value $\hbar_{gr} \geq GMm$ and would make possible to avoid gravitational collapse. $v_0 = 1$ might have interpretation in terms of the light-likeness of the asymptotic wormhole throat containing only dark matter.

After the asymptotic value of v_0 has been reached, the transitions could occur as transitions between Bohr orbits if one has $n > 1$ in the original situation. This picture conforms with the idea that genuine quantum realm is realized only at the radii comparable to gravitational Planck length $L_{Pl} = \sqrt{\hbar_{gr}G} = G\sqrt{Mm}$. For $M = m$ this length is one half of Schwarzschild radius.

- (b) Assume that all energy liberated in the transitions goes to gravitational radiation, and that the rate is determined by the condition $\tau = a \times 2\pi v_0^5/\omega$. This gives

$$\hbar_{gr}\omega = \frac{m}{4} \frac{\Delta v_0^2}{n^2} . \quad (10.4.9)$$

This gives for the ratios of transition times and radiation powers in the two kinds of transitions the estimates

$$\begin{aligned} \frac{\tau_{\Delta v_0}}{\tau_{\Delta n}} &= \frac{v_0^2}{n^2} \frac{\Delta(\frac{1}{n^2})}{\Delta v_0^2} , \\ \frac{P_{\Delta v_0}}{P_{\Delta n}} &= \left(\frac{v_0^2}{n^2} \frac{\Delta(\frac{1}{n^2})}{\Delta v_0^2} \right)^2 . \end{aligned} \quad (10.4.10)$$

The ratio is of order u power of radiated energy is of same order as in the previous case.

A couple of further remarks about the model are in order.

- (a) Bohr energies are proportional to $(\hbar_{gr}n)^{-2}$. In case of $F - C$ option this allows to consider the possibility that common factor drops out from both n and $1/\hbar_{gr}$ without any change in the energy of the state since the Bohr orbit is not affected. The Planck constant for the outer planets in solar system is by a factor 5 larger than for inner planets and this kind of transition is in principle possible.
- (b) At formal level at least one can also consider gravitationally bound states of light particles. For $GMm < 1$ the value of gravitational Planck constant would become smaller than \hbar_0 for $v_0 \rightarrow 1$. In this case the asymptotic situation would correspond to $v_0 = GMm$.

One can consider also an alternative model in which one treats the change of v_0 as an effectively continuous process, drops the assumption about τ , and equates the radiation power to the classically predicted power.

- (a) The condition that \hbar changes almost continuously combined with the condition \hbar is reduced by dividing factors out from n_a and n_b requires that \hbar contains a product of ratios of almost identical integers associated with n_a and n_b : $n_a/n_b = \prod_i (r_i/s_i)$, $r_i/s_i < 1$. This condition is quite stringent and one can argue that it makes the model un-natural.
- (b) Using $E_n = mv_0^2/4n^2$ for circular Bohr orbits, the power radiated as gravitational radiation would be

$$P_n = \frac{dE_n}{dt} = 2E_n \frac{d \log(v_0)}{dt} . \quad (10.4.11)$$

This gives

$$\frac{d \log(E_n)}{dt} = 2 \frac{d \log(v_0)}{dt} = 2 \frac{d \log(\frac{v_0}{n})}{dt} . \quad (10.4.12)$$

Note that the formula is scaling invariant.

- (c) Using classical radiation formula for which the radiated power is proportional to $1/r_n^5$ and $r_n = GMn^2/v_0^2$ one has $P_n \propto (v_n/n)^{10}$ and $P_n/E_n \propto (v_n/n)^8/n^2$. Combining this with the above result one has

$$\begin{aligned} \frac{d \log(x_n)}{dt} &= \frac{k}{GMn^2} x_n^8, \\ x &= \frac{v_0}{n}, \quad k = \frac{2^6}{5} \left(\frac{m}{M}\right)^2 \frac{M+m}{m}. \end{aligned} \quad (10.4.13)$$

This gives

$$v_0 = n \left(\frac{v_0(0)}{n} - 7k \frac{t}{GM} \right)^{-1/7}. \quad (10.4.14)$$

The time devolution of v_0 depends on Bohr orbit. This conforms with the fact that to each planet there corresponds a particular space-time sheet mediating gravitational interaction. The different time dependence of v_0 for different Bohr orbits however implies that Bohr model with single value of v_0 cannot explain the radii of planetary orbits for large values of t . For $v_0(0) = 2^{-11} v_0(0)^{-7}$ equals to 2^{77} so that the rate for the change is very slow.

- (d) The velocity becomes infinite in time

$$t_\infty = \frac{GM}{8k} \frac{v_0(0)^{-8}}{n}.$$

Light velocity of course sets an upper bound for the velocity and is never achieved and the formula must break down at relativistic velocities. A rough estimate for the time during which light velocity is achieved is as

$$t_1 = \frac{GM}{8k} \left(\frac{v_0(0)}{n}^{-8} - 1 \right).$$

The time depends on Bohr orbit.

- (e) The model does not say anything about the emission process itself. Gravitons could be also emitted as dark gravitons. The value of Planck constant for them must be however considerably smaller than the value of \hbar_{gr} .

10.4.3 Model for dark gravitons

If one wants to understand how dark gravitons possibly affect the standard predictions for graviton detection, one must develop a model for dark gravitons and their transformation to ordinary gravitons.

Gravitons in TGD

Unlike the naive application of Mach's principle would suggest, gravitational radiation is possible in empty space in general relativity. In TGD framework it is not possible to speak about small oscillations of the metric of the empty Minkowski space imbedded canonically to $M^4 \times CP_2$ since Kähler action is non-vanishing only in fourth order in the small deformation and the deviation of the induced metric is quadratic in the deviation. Same applies to induced gauge fields. Even the induced Dirac spinors associated with the modified Dirac action fixed uniquely by supersymmetry allow only vacuum solutions in this kind of background. Mathematically this means that both the perturbative path integral approach and canonical quantization fail completely in TGD framework. This led to the vision about physics as Kähler geometry of "world of classical worlds" with quantum states of the universe identified as the modes of classical configuration space spinor fields.

The resolution of various conceptual problems is provided by the parton picture and the identification of elementary particles as light-like 3-surfaces associated with the wormhole throats. Gauge bosons correspond to pairs of wormholes and fermions to topologically condensed CP_2 type extremals having only single wormhole throat.

Gravitons are string like objects in a well defined sense. This follows from the mere spin 2 property and the fact that partonic 2-surfaces allow only free many-fermion states. This forces gauge bosons to be wormhole contacts whereas gravitons must be identified as pairs of wormhole contacts (bosons) or of fermions connected by flux tubes. The strong resemblance with string models encourages to believe that general relativity defines the low energy limit of the theory. Of course, if one accepts dark matter hierarchy and dynamical Planck constant, the notion of low energy limit itself becomes somewhat delicate.

The number of states is conserved in the phase transitions changing Planck constant

The number of states is conserved in phase transitions changing Planck constant as the following argument demonstrates.

- (a) The units of charges are scaled by $1/n_i$ for the covering space option (C) and by n_i for factor space option (F). Without any constraints the number of states would be scaled by n_i for C and $1/n_i$ for F . The modification of fermionic anti-commutation (bosonic commutation) relations involving \hbar at the right hand side implies that particle numbers become as multiples of \hbar/\hbar_0 so that particle number is fractionized in the general case. This implies a change in the number of states which compensates the change caused by the change of the charge units so that the total number of states remains unchanged in the phase transitions affecting the value of \hbar .
- (b) For F -option particle number becomes fractional implying that angular momentum and charge units are not changed. If the anyonic state is created from an ordinary one in a phase transition, the total particle number for the entire anyonic state must be integer, which gives rise to a confinement mechanism. For C -option the charge units are fractional but since particle numbers become as integer multiples of n_i , the net result is that total charges have the standard spectrum. Single particle states can however have fractional charges. In anyonic many-particle states this kind of spin and charge fractionization can take place at single particle level [K63].
- (c) If one assumes G_i -singletness for the states of the covering, the unit of angular momentum is scaled up by n_i and the interpretation is in terms of n_i copies of ordinary single particle states at the sheets of the covering. For factor space option already single particle states are by definition G_i singlets.

What kind of dark gravitons can one consider?

First of all one must decide what sector of the generalized imbedding space dark graviton correspond to. There are four options of which two ($C - C$ and $F - C$) can give rise to large angular momentum and only these options will be discussed in the sequel. It should be noticed that if one accepts the proposal that the hierarchy of Planck constants follows from basic TGD then only the $C - C$ option remains. This option is favored also because it implies evolution as increase of Planck constants and because for given value of Planck constant there is only a finite number of different pages of the Big Book corresponding to the factorizations of $n = n_a n_b$ of the integer $n = \hbar/\hbar_0$.

- (a) $C - C$ option corresponds to Planck constant $r \equiv \hbar/\hbar_0 = n_a n_b$. Both G_a and G_b would act in their respective covering spaces assignable to the gravitational field body. Either n_a or n_b or both must be very large. For large n_b G_a singletness implies that the unit of angular momentum of the giant graviton is proportional to n_b and thus very large and the interpretation is as a bundle of ordinary gravitons. In this case also gravitons with small net angular momentum are possible.

- (b) $F - C$ option: corresponds to $\hbar/\hbar_0 = n_b/n_a$ with very large value of n_b . In this case graviton has G_a -fold rotational symmetry and would have very large angular momentum proportional to n_b .

Consider first the general view about de-coherence process assumed to reduce the symmetries defined by G_a and G_b .

- (a) Assuming singletness with respect to G_a and G_b , de-coherence could be seen as a sequence of symmetry breakdowns for both coverings and factor spaces. At given step the orders of the resulting symmetry groups G_a and G_b are divisors of the orders of the original groups. The final step would lead to trivial covering and factor spaces. Number theoretically the process is like determining the factors of a very large number by dividing them away in the de-coherence process.
- (b) Once the sector of the generalized imbedding space is selected, one has still two options corresponding to spherical and plane waves. Spherical dark gravitons could be emitted in quantum transitions of the dark part of the astrophysical object. Emission process could also yield a sufficiently large number of MEs (massless extremals/ topological light rays [K11]) with large value of \hbar .
- (c) Spherical dark graviton can de-cohere into spherical gravitons with smaller groups G_a and G_b . Sooner or later spherical giant graviton must de-cohere into topological light rays ("MEs") defining the TGD counterparts of plane waves of finite width and define second model for dark graviton. They are expected to be detectable by human built detectors. Note that for $F - C$ option the meaning of G_a for the MEs is different from that for spherical gravitons since the directions of quantization axes of angular momentum are in general different.

Emission of dark gravitons

One must answer several non-trivial questions if one is to defend dark gravitational radiation.

Frequencies of dark gravitons turn out to correspond to orbital frequencies at large quantum number limit. However, if gravitational radiation is emitted as dark gravitons, they have enormous energies since the energy must correspond to the change of the energy of an astrophysical object jumping to a smaller Bohr orbit.

Hulse-Taylor binary system was used to demonstrate that the energy loss of the binary system equals to the classically predicted power of gravitational radiation. The power of gravitational radiation was deduced from the gradual reduction of the distance between the two stars. The obvious question is whether the consistency of the power emitted by Hulse-Taylor binary with the prediction of the classical theory kills the hypothesis about gigantic gravitational Planck constant.

- (a) If one assumes that v_0 is of same order of magnitude as for planetary systems as the value of the orbital radius indeed suggests, single spherical dark graviton emitted in the transition would carry away an essentially astrophysical energy. If MEs are emitted and one assumes that sufficiently high number of them is emitted so that the total recoil momentum is small.
- (b) If dark graviton is spherical or -more generally - corresponds to a partial wave with a definite value of angular momentum (in a sense to be specified), it must decay gradually to spherical or ME type gravitons with smaller values of Planck constant. The measurement process should induce this kind of decay.
- (c) The prediction that energy is emitted in bunches should have testable experimental implications. The case of hydrogen atom inspires the question whether the lowest orbit is stable and does not emit gravitational radiation meaning that the binary ends up to the stable state rather than collapsing. Of course, the idealization as hydrogen atom like system might fail. The identification of dark gravitons as dark topological light rays (massless extremals, MEs) containing topologically condensed ordinary gravitons will be discussed later.

By quantum classical correspondence this process must have a space-time description.

- (a) The natural proposal is that below the time scale associated with the emission process the space-time picture about the emission process looks like a continuous process, at least asymptotically when the space-time itself is replaced repeatedly with a new one. Thus the transition between orbitals at the level of space-time correlates must occur continuously below the time scale assigned to it classically. Quantum emission would quite generally mean in sub-quantum time scales continuous classical process at space-time level.
- (b) TGD based quantum model for living system suggests that the transition occurs in a fractal manner proceeding from long to short dark time scales. First a quantum jump in the longest time scale occurs and induces the replacement of the entire space-time with a new one differing dramatically from the previous one. This quantum jump is followed by quantum jumps in shorter time scales. At each step space-time sheet characterizing the system is replaced by a new one and eventually by a space-time surface which describes the process as more or less continuous one. The final space-time could be regarded as symbolic description of the process as a classical continuous process.
- (c) The time interval for the occurrence of the transition at space-time level should correspond to a dark p-adic time scale and in the case of Hulse-Taylor binary be of same order as the lifetime of the period during which the system ends up to a stable state. In the Hulse-Taylor case the emission would correspond to small values of n , most naturally $n = 2 \rightarrow n = 1$ transition so that the frequency of the gravitational radiation would not correspond to the orbital frequency. This might some day be used as a test for the theory. The time duration T for the transition can be estimated from $T = \Delta E/P$, where P is the classical formula for the emission power.

Model for the spherical graviton

Detector, giant graviton, source, and topological light ray will be denoted simply by D, G, and S, and ME in the following. Consider first the model for the giant graviton.

- (a) Orbital plane defines the natural quantization axis of angular momentum for spherical graviton. Spherical graviton corresponds to a graviton with very large unit of angular momentum corresponding to G_a invariance acting in covering space degrees of freedom but can be regarded as a Bose-Einstein condensate like state of ordinary gravitons.
- (b) The total angular momentum of the giant graviton(s) must correspond to the change of angular momentum in the quantum transition between initial and final orbit. Orbital angular momentum in the direction of quantization axis should be a small multiple of dark Planck constant associated with the system formed by giant graviton and source. These states correspond to Bose-Einstein condensates of ordinary gravitons in eigen state of orbital angular with ordinary Planck constant. Unless S-wave is in question the intensity pattern of the gravitational radiation depends on the direction in a characteristic non-classical manner. The coherence of dark graviton regarded as Bose-Einstein condensate of ordinary gravitons is what distinguishes the situation in TGD framework from that in GRT.

Dark graviton as topological light ray

Second kind of dark graviton is analog for plane wave with a finite transversal cross section. TGD indeed predicts what I have called topological light rays, or massless extremals (MEs) as a very general class of solutions to field equations [K11].

MEs are typically cylindrical structures carrying induced gauge fields and gravitational field without dissipation and dispersion and without weakening with the distance. These properties are ideal for targeted long distance communications which inspires the hypothesis that they play a key role in living matter [K60, K13] and make possible a completely new kind of communications over astrophysical distances. Large values of Planck constant allow to resolve the problem posed by the fact that for long distances the energies of these quanta would be below the thermal energy of the receiving system.

Giant gravitons are expected to decay to this kind of dark gravitons having smaller value of Planck constant via de-coherence and that it is these gravitons which are detected. Quantitative estimates indeed support this expectation.

The same general picture that applies to spherical gravitons applies to MEs. The only difference is that quantization axis of angular momentum left point-wise invariant under G_a is parallel to the direction of propagation. Thus the de-coherence of a spherical graviton into MEs means dispersion to a sector of the world of classical worlds possessing different quantization axes.

10.4.4 Detection of gravitational radiation

One should also understand how the description of the gravitational radiation at the space-time level relates to the picture provided by general relativity to see whether the existing measurement scenarios really measure the gravitational radiation as they appear in TGD. There are more or less obvious questions to be answered (or perhaps obvious after a considerable work).

What is the value of dark gravitational constant which must be assigned to the pair formed by the measuring system and gravitational radiation from a given source? Is the detection of primary giant graviton possible by human means or is it possible to detect only dark gravitons produced in the sequential de-coherence of giant graviton? Do dark gravitons enhance the possibility to detect gravitational radiation as one might expect? What are the limitations on detection due to energy conservation in de-coherence process?

TGD counterpart for the classical description of detection process

The oscillations of the distance between the two masses defines a simplified picture about the receive of gravitational radiation.

Now ME would correspond to n_a -”Riemann-sheeted” covering of M^4 with each sheet oscillating with the same frequency: simply a stack of ordinary MEs defining a bundle of ordinary gravitons. Classical interaction would suggest that the measuring system topologically condenses at the topological light ray so that the distance between the test masses measured along the topological light ray in the direction transverse to the direction of propagation starts to oscillate. This (or these) topological light rays must however result via de-coherence to $n_a = n_b = 1$ sector of the imbedding space unless measurement system itself corresponds to dark matter. If only single topological light ray results it must carry large number of gravitons. Topological light rays can be indeed regarded as space-time correlates for massless collinear bosons of various kinds. One can also consider the possibility that measurement system is quantum critical itself.

Obviously the classical behavior is essentially the same as predicted by general relativity. If all elementary particles are maximally quantum critical systems and therefore also gravitons, then gravitons can be absorbed at each step of the process, and the number of absorbed gravitons and energy is N -fold.

One can ask whether one should treat the detector as a $(n_a, n_b) = (1, 1)$ system or whether one could assume that the Planck constant is large and given by a formula $\hbar(D)/\hbar_0 = GM^2(D)/v_D$ so that the gravitational field body would catch the incoming dark graviton. In this case the value of \hbar for incoming gravitons should be equal to $\hbar(D)$. This number theoretic condition is not in general true. Unless the gravitational field body of the detector is quantum critical in the sense of having branches in a large number of pages of the Big Book, this kind of detection is not possible in general and gravitons must end up to ordinary gravitons or gravitons with relatively small value of \hbar before they can be detected.

The time interval during which the interaction with dark graviton takes place?

If the duration of the bunch is $T = E/P$, where P is the classically predicted radiation power in the detector and T the detection period, the average power during bunch is identical to that predicted by GRT. Also T would be proportional to r , and therefore code information about the masses appearing in the sequential de-coherence process.

An alternative, and more attractive possibility, is that T is same always and correspond to $r = 1$. The intuitive justification is that absorption occurs simultaneously for all r "Riemann sheets". This would multiply the power by a factor r and dramatically improve the possibilities to detect gravitational radiation. The measurement philosophy based on standard theory would however reject these kind of events occurring with $1/r$ time smaller frequency as being due to the noise (shot noise, seismic noise, and other noise from environment). This might relate to the failure to detect gravitational radiation.

10.4.5 Quantitative model

In this subsection a rough quantitative model for the de-coherence of giant (spherical) graviton to topological light rays (MEs) is discussed and the situation is discussed quantitatively for hydrogen atom type model of radiating system. The basic assumption is irreversibility in the sense that the integers n_a and n_b approach to unity in the de-coherence process.

De-coherence of spherical dark gravitons to ordinary gravitons

The proposed general model for de-coherence can be applied to build a model for the de-coherence of spherical dark gravitons to ordinary spherical gravitons.

- (a) For $C - C$ option one can assume that de-coherence occurs through the decays of gravitons to multi-graviton states with smaller \hbar . These decay sequences correspond to all possible factorizations of the integer $N = n_a n_b$ to a product $N = \prod n_i$ of factors (same factor can appear several times) and taken in all possible orders distinguishable from each other. A particular decay sequence means following. At the first step any factor n_i is divided from N producing a bundle of n_i gravitons with energy E/n_i . Briefly: $N \rightarrow N/n_i$, $E \rightarrow E/n_i$. This corresponds to a node of a tree with incoming graviton defining the root and having n_i branches. This process repeats itself for each new branch independently creating new branches at each node. This process repeats itself until only ordinary gravitons are left. Note that the last decay could take place at detector. This picture suggests that the flow of ordinary gravitons is not steady but takes place in bunches of ordinary gravitons so that standard detector arrangements might regard these bunches as noise.
- (b) For $F - C$ option one has $r = n_b/n_a$ which corresponds to non-integer valued graviton number. n_a is eliminated by a sequence of divisions of n_a by its factors and also now all possible sequences are possible. In this case graviton does not decay to multi-graviton state but suffers only a leakage to a sector with a smaller value of n_a so that frequency is scaled as $f \rightarrow f/n_i$, n_i a factor of n_a . The eventual replacement of the original frequency with its sub-harmonic f/n_a means that at least for large enough values of n_a the standard measurement arrangements estimating the typical value of f from orbital period fail to detect gravitons. If ruler and compass rule holds true, the analogy with the approach to chaos by period doubling is obvious.
- (c) The estimate for the number of ordinary gravitons gives estimate for the radiated energy per solid angle. This estimate follows also from the energy conservation for the transition. The requirement that average power equals to the prediction of GRT allows to estimate the geometric duration associated with the transition. The condition $\hbar\omega = E_f - E_i$ is consistent with the identification of \hbar for the pair of systems formed by giant-graviton and emitting system.

Transformation of spherical giant gravitons to topological light-rays

The model for the transformation of dark spherical gravitons to ordinary gravitons via a transition to MEs differs from the above model only in that there is a step in which a transformation to MEs takes place.

- (a) Giant graviton leaks to sectors of H with a smaller value of Planck constant via quantum critical points common to the original and final sector of H . If ordinary gravitons are quantum critical they can be regarded as leakage points.
- (b) It is natural to assume that the resulting dark graviton corresponds to a radial topological light ray (ME).
- (c) Energy should be conserved in the leakage process. The secondary dark graviton receives the fraction $\Delta\Omega/4\pi = S/4\pi r^2$ of the energy of giant graviton, where $S(ME)$ is the transversal area of ME, and r the radial distance from the source, of the energy of the giant graviton. Energy conservation gives

$$\frac{S(ME)}{4\pi r^2} \hbar(G, S)\omega = \hbar(G, ME)\omega , \quad (10.4.15)$$

where S and ME refer to spherical and ME . From this one obtains

$$\frac{S(ME)}{4\pi r^2} = \frac{\hbar(G, ME)}{\hbar(G, S)} \simeq \frac{E(ME)}{M(S)} . \quad (10.4.16)$$

The larger the distance is, the larger the area of ME. This means a restriction to the measurement efficiency at large distances for realistic detector sizes since the number of gravitons must be proportional to the ratio $S(D)/S(ME)$ of the areas of detector and ME.

- (d) After the transformation to MEs the MEs decay to bundles of MEs with smaller value of \hbar just as spherical gravitons would do. The values of \hbar appearing in the sequence are same as for spherical cascade.

Estimate for the total number of detected ordinary gravitons

For $F - C$ option the frequencies of detected gravitons are sub-harmonics f/n_a . For $C - C$ option the frequency is the original one. Suppose that the detector has a disk like shape with disk radius d . This gives for the total number $n(D)$ of ordinary gravitons going to the detector the estimate

$$n(D) = \frac{\Delta\Omega}{4\pi \times n_b(G, S)} = \frac{1}{4} \times \left(\frac{d}{r}\right)^2 \times n_b(G, S) , \quad (10.4.17)$$

This implies

$$n(D) = x \frac{GMm}{v_0} \frac{1}{4} \times \left(\frac{d}{r}\right)^2 ,$$

$$x = 1 \text{ for } C - C \text{ option, } x = n_a \text{ for } F - C \text{ option} . \quad (10.4.18)$$

$$(10.4.19)$$

If the actual area of detector is smaller than d^2 by a factor x one has

$$n(D) \rightarrow xn(D) .$$

$$E(D) = E_{tot} \times \frac{1}{4} \left(\frac{d}{r}\right)^2 , \quad E_{tot} = \hbar_{gr}\omega , \quad \frac{GMm}{v_0} . \quad (10.4.20)$$

Assuming that the radiation is emitted during time $T \sim 2\pi/\omega$ one obtains the estimate for the total power

$$P_q \sim \frac{E_{tot}}{T} = \frac{1}{2\pi} \hbar_{gr} \omega^2 . \quad (10.4.21)$$

10.4.6 Generalization to gauge interactions

The situation is expected to be essentially the same for gauge interactions. The first guess is that one has $r = Q_1 Q_2 g^2 / v_0$, where g is the coupling constant of appropriate gauge interaction. v_0 need not be same as in the gravitational case. The value of $Q_1 Q_2 g^2$ for which perturbation theory fails defines a plausible estimate for v_0 . The basic constraint is $v_0 \leq 1$. In the case of gravitation this interpretation would mean that perturbative approach fails for $GM_1 M_2 = v_0$. For $r > 1$ Planck constant is quantized with rational values with ruler-and-compass rationals as favored values. For gauge interactions r would have rather small values. The above criterion applies to the field body connecting two gauge charged systems. One can generalize this picture to self interactions assignable to the "personal" field body of the system. In this case the condition would read as $\frac{Q^2 g^2}{v_0} > 1$.

Some applications

One can imagine several applications.

- (a) A possible application would be to electromagnetic interactions in heavy ion collisions.
- (b) Gamma ray bursts might be one example of dark photons with very large value of Planck constant. The MEs carrying gravitons could carry also gamma rays and this would amplify the value of Planck constant from them too.
- (c) Atomic nuclei are good candidates for systems for which electromagnetic field body is dark. The value of \hbar would be $r = Z^2 e^2 / v_0$, with $v_0 \sim 1$. Electromagnetic field body could become dark already for $Z > 3$ or even for $Z = 3$. This suggest a connection with nuclear string model [L2], [L2] in which $A \leq 4$ nuclei (with $Z < 3$) form the basic building bricks of the heavier nuclei identified as nuclear strings formed from these structures which themselves are strings of nucleons.
- (d) Color confinement for light quarks might involve dark gluonic field bodies.
- (e) Dark photons with large value of \hbar could transmit large energies through long distances and their phase conjugate variants could make possible a new kind of transfer mechanism [K44] essential in TGD based quantum model of metabolism and having also possible technological applications. Various kinds of sharp pulses [H1] suggest themselves as a manner to produce dark bosons in laboratory. Interestingly, after having given us alternating electricity, Tesla spent the rest of his professional life by experimenting with effects generated by electric pulses. Tesla claimed that he had discovered a new kind of invisible radiation, scalar wave pulses, which could make possible wireless communications and energy transfer in the scale of globe (for a possible but not the only TGD based explanation [K28]). This notion of course did not conform with Maxwell's theory, which had just gained general acceptance so that Tesla's fate was to spend his last years as a crackpot. Great experimentalists seem to be able to see what is there rather than what theoreticians tell them they should see. They are often also visionaries too much ahead of their time.

In what sense dark matter is dark?

The notion of dark matter as something which has only gravitational interactions brings in mind the concept of ether and is very probably only an approximate characterization of the situation. As I have been gradually developing the notion of dark matter as a hierarchy of phases of

matter with an increasing value of Planck constant, the naivete of this characterization has indeed become obvious.

If the proposed view is correct, dark matter is dark only in the sense that the process of receiving the dark bosons (say gravitons) mediating the interactions with other levels of dark matter hierarchy, in particular ordinary matter, differs so dramatically from that predicted by the theory with a single value of Planck constant that the detected dark quanta are unavoidably identified as noise. Dark matter is there and interacts with ordinary matter and living matter in general and our own EEG in particular provide the most dramatic examples about this interaction. Hence we could consider the dropping of "dark matter" from the glossary altogether and replacing the attribute "dark" with the spectrum of Planck constants characterizing the particles (dark matter) and their field bodies (dark energy).

10.4.7 Can graviton have mass?

The latest news from LIGO is that it has not detected gravitational waves from black holes with masses in the range 25-100 solar masses [E45]. This conforms with theoretical predictions. Earlier searches from Super Novae give also null result: in this case the searches are already at the boundaries of resolution so that one can start to worry.

The reduction of the spinning rate of Hulse-Taylor binary [E20] is consistent with the emission of gravitational waves with the predicted rate so that it seems that gravitons are emitted. One can however ask whether gravitational waves might remain undetected for some reason.

Massive gravitons is the first possibility. For a nice discussion see the article of Goldhaber and Nieto [E143] giving in their conclusions a table summarizing upper bounds on graviton mass coming from various arguments involving model dependent assumptions. The problem is that it is not at all clear what massive graviton means and whether a simple Yukawa like behavior (exponential damping) for Newtonian gravitational potential is consistent with the general coordinate invariance. In the case of massive photons one has similar problem with gauge invariance. One can of course naively assume Yukawa like behavior for the Newtonian gravitational potential and derive lower bounds for the Compton wave length of gravitons. The bound is given by $\lambda_c \geq 100$ Mpc.

Second bound comes from the pulsar timing measurements [E107]. The photons emitted by the pulsar are assumed to surf in the sea of gravitational waves created by the pulsar. If gravitons are massive in Yukawa sense they arrive with velocities which are below light velocity, a dispersion of both graviton and photon arrival times is predicted. This gives a much weaker lower bound $\lambda_c \geq 1$ pc. Note that the distance of Hulse-Taylor binary is 6400 pc so that this upper bound for graviton mass could explain the possible absence of gravitational waves from Hulse-Taylor binary. There are also other bounds on graviton mass [E143] but all are plagued by model dependent assumptions.

Also in TGD framework one can imagine explanations for the possible absence of gravitational waves. I have already discussed the possibility that gravitons are emitted as dark gravitons with gigantic value of \hbar , which decay eventually to bunches of ordinary gravitons meaning that continuous stream of gravitons is replaced with bursts which would not be interpreted in terms of gravitons but as noise.

One of the breakthroughs of the last year was related to the twistor approach to TGD [K92] in zero energy ontology (ZEO).

- (a) This approach leads to the vision that all building blocks (light-like wormhole throats) of physical particles -including also virtual particles and also string like objects- are massless. On mass shell particles are bound states of massless particles but virtual states do not satisfy bound state constraint and because negative energies are possible, also space-like virtual momenta are possible.
- (b) Massive physical particles are identified as bound states of massless wormhole throats: since the three momenta can have different (as a special case opposite) directions, the bound states of light-like wormhole throats can be indeed massive.

- (c) Masslessness of the fundamental objects saves from problems with gauge invariance and general coordinate invariance. It also makes it possible to apply twistor formalism, implies the absence of UV divergences, and yields an enormous simplification of generalized Feynman diagrammatics since mass shell constraints are satisfied at lines besides momentum conservation at vertices.
- (d) A simple argument forces to conclude that all spin one and spin two particles- in particular graviton- identified in terms of multi-wormhole throat states must have arbitrary small but non-vanishing mass. The resulting physical IR cutoff guarantees the absence of IR divergences. This allows to preserve the exact Yangian symmetry of the M-matrix. One implication is that photon eats the TGD counterpart of the neutral Higgs and that only pseudoscalar counterpart of Higgs survives. The scalar counterparts of gluons suffer the same fate whereas their pseudoscalar partners would survive.

Is the massivation of gauge bosons and gravitons in this sense consistent with the Yukawa type behavior?

- (a) The first thing to notice is that this massivation would be essentially a non-local quantal effect since both emitter and receiver both emit and receive light-like momenta. Therefore the description of the massivation in terms of Yukawa potential and using ordinary QFT might well be impossible or be a good approximation at best.
- (b) If the massive gauge bosons (gravitons) correspond to wormhole throat pair (pair of these) such that the three-momenta are light-like but in exactly opposite directions, no Yukawa type screening and velocity dispersion should take place.
- (c) If the three momenta are not exactly opposite as is possible in quantum theory, Yukawa screening could take place since the classical cm velocity calculated from the total momentum for a massive particle is smaller than maximal signal velocity. The massivation of intermediate gauge bosons and the fact that Yukawa potential description works for them satisfactorily supports this interpretation.
- (d) If the space-time sheets mediating gravitational interaction have gigantic values of gravitational Planck constant Compton length of graviton is scaled up dramatically so that screening would be absent but velocity dispersion would remain. This leaves open the possibility that gravitons from Hulse-Taylor binary could reveal the velocity dispersion if they are detected some day.

Bibliography

- [1] LIGO Collaboration(2011), *Search for gravitational waves from binary black hole inspiral, merger and ringdown*. <http://arxiv.org/abs/1102.3781>.
- [2] A. S. Goldhaber and M. M. Nieto (2010), *Photon and Graviton Mass Limits*. <http://arxiv.org/pdf/0809.1003v5>.
- [3] D. Baskaran *et al* (2008), *Limits on the speed of gravitational waves from pulsar timing*. <http://arxiv.org/pdf/0805.3103>.

10.5 New view about black-holes

In TGD framework the imbedding of the interior metric of ordinary black-holes fails and there is a good argument suggesting that horizon is transformed to a "partonic" light-like 3-surface at which the signature of the induced metric changes [K85] . Black-hole would be replaced by a gigantic particle having no electro-weak interactions since the state would be created using super-symplectic generators and generate its mass via p-adic thermodynamics. Schwarzschild radius equals to Compton length if the generalization of Nottale formula for Planck constant holds true. Super-symplectic black-holes behave as dark matter and are very natural final states of the star and follow naturally neutron star phase. Also a microscopic description of black-hole as a gigantic hadron emerges. $\mathcal{N} = \infty$ SUSY formulated in [K32] is a good candidate for the formulation of a first principle theory for the description of the anyonic state.

10.5.1 Anyonic view about blackholes

A new element to the model of black hole comes from the vision that black hole horizon as a light-like 3-surface corresponds to a light-like orbit of light-like partonic 2-surface. This allows two kinds of black holes. Fermion like black hole would correspond to a deformed CP_2 type extremal which Euclidian signature of metric and topologically condensed at a space-time sheet with a Minkowskian signature. Boson like black hole would correspond to a large wormhole contact connecting two space-time sheets with Minkowskian signature. Wormhole contact would be a piece deformed CP_2 type extremal possessing two light-like throats defining two black hole horizons very near to each other. It does not seem absolutely necessary to assume that the interior metric of the black-hole is realized in another space-time sheet with Minkowskian signature.

Second new element relates to the value of Planck constant. For $\hbar_{gr} = 4GM^2$ the Planck length $L_P(\hbar) = \sqrt{\hbar G}$ equals to Schwarzschild radius and Planck mass equals to $M_P(\hbar) = \sqrt{\hbar/G} = 2M$. If the mass of the system is below the ordinary Planck mass: $M \leq m_P(\hbar_0)/2 = \sqrt{\hbar_0/4G}$, gravitational Planck constant would be smaller than the ordinary Planck constant. If only coverings are allowed -as is the case if the hierarchy of Planck constants follows from basic TGD- these values of Planck constant are not possible.

Black hole surface contains ultra dense matter so that perturbation theory is not expected to converge for the standard value of Planck constant but do so for gravitational Planck constant. If the phase transition increasing Planck constant is a friendly gesture of Nature making perturbation theory convergent, one expects that only the black holes for which Planck constant

is such that $GM^2/4\pi\hbar < 1$ holds true are formed. Black hole entropy for given sheet of the covering -being proportional to $1/\hbar$ - is of order unity so that TGD black holes are not very entropic. The entire blackhole entropy is just the standard black hole entropy since there are \hbar/\hbar_0 sheets in the covering. This would suggest that entropy serves as a control variable in the sense that when it exceeds the threshold value, the partonic 2-surfaces at the ends of CD split to a surfaces in the covering.

The model of anyons and fractional quantum Hall effect [K63] leads to the conclusion that various charges are fractionized so that a partonic 2-surface possessing given charges splits in the interior of space-time surface to $n_a n_b$ components with same fractional charge $1/n_a n_b$. The ends of space-time sheet split to n_b components with charges coming as multiples of $1/n_b$ and wormholes to n_a components with charges coming as multiples of $1/n_a$. In CD degrees of freedom fractionization can occur only if the partonic 2-surface encloses the tip of CD . This would mean spin fractionization.

If the partonic 2-surface surrounds the tip of causal diamond CD , the matter at its surface is in anyonic state with fractional M^4 charges and CP_2 . Otherwise only CP_2 charges are fractional. Anyonic black hole can be seen as single gigantic elementary particle stabilized by fractional quantum numbers of the constituents preventing them from escaping from the system and transforming to ordinary visible matter. For F-C option a huge number of different black holes are possible for a given value of \hbar since there is infinite variety of pairs (n_a, n_b) of integers giving rise to same value of \hbar . For C-C option possibly - which possibly reduces to the basic quantum TGD - the number of black holes corresponds to the number of decompositions of $n = n_a n_b$ to a product.

One can imagine that the partonic surface is not exact sphere except for ideal black holes but contains large number of magnetic flux tubes giving rise to handles. Also a pair of spheres with different radii can be considered with surfaces of spheres connected by braided flux tubes. The braiding of these handles can represent information and one can even consider the possibility that black hole can act as a topological quantum computer. There would be no sharp difference between the dark parts of black holes and those of ordinary stars. Only the volume containing the complex flux tube structures associated with the orbits of planets and various objects around star would become very small for black hole so that the black hole might code for the topological information of the matter collapsed into it.

10.5.2 Super-symplectic bosons

TGD predicts also exotic bosons which are analogous to fermion in the sense that they correspond to single wormhole throat associated with CP_2 type vacuum extremal whereas ordinary gauge bosons corresponds to a pair of wormhole contacts assignable to wormhole contact connecting positive and negative energy space-time sheets. These bosons have super-conformal partners with quantum numbers of right handed neutrino and thus having no electro-weak couplings. The bosons are created by the purely bosonic part of super-symplectic algebra [K20, K19], whose generators belong to the representations of the color group and 3-D rotation group but have vanishing electro-weak quantum numbers. Their spin is analogous to orbital angular momentum whereas the spin of ordinary gauge bosons reduces to fermionic spin. Recall that super-symplectic algebra is crucial for the construction of configuration space Kähler geometry. If one assumes that super-symplectic gluons suffer topological mixing identical with that suffered by say U type quarks, the conformal weights would be (5,6,58) for the three lowest generations. The application of super-symplectic bosons in TGD based model of hadron masses is discussed in [K56] and here only a brief summary is given.

As explained in [K56], the assignment of these bosons to hadronic space-time sheet is an attractive idea.

- (a) Quarks explain only a small fraction of the baryon mass and that there is an additional contribution which in a good approximation does not depend on baryon. This contribution should correspond to the non-perturbative aspects of QCD. A possible identification of this contribution is in terms of super-symplectic gluons. Baryonic space-time sheet with

$k = 107$ would contain a many-particle state of super-symplectic gluons with net conformal weight of 16 units. This leads to a model of baryons masses in which masses are predicted with an accuracy better than 1 per cent [K48] .

- (b) Hadronic string model provides a phenomenological description of non-perturbative aspects of QCD and a connection with the hadronic string model indeed emerges. Hadronic string tension is predicted correctly from the additivity of mass squared for $J = 2$ bound states of super-symplectic quanta. If the topological mixing for super-symplectic bosons is equal to that for U type quarks then a 3-particle state formed by 2 super-symplectic quanta from the first generation and 1 quantum from the second generation would define baryonic ground state with 16 units of conformal weight. A very precise prediction for hadron masses results by assuming that the spin of hadron correlates with its super-symplectic particle content.
- (c) Also the baryonic spin puzzle caused by the fact that quarks give only a small contribution to the spin of baryons, could find a natural solution since these bosons could give to the spin of baryon an angular momentum like contribution having nothing to do with the angular momentum of quarks.
- (d) Super-symplectic bosons suggest a solution to several other anomalies related to hadron physics. The events observed for a couple of years ago in RHIC [C15] suggest a creation of a black-hole like state in the collision of heavy nuclei and inspire the notion of color glass condensate of gluons, whose natural identification in TGD framework would be in terms of a fusion of hadronic space-time sheets containing super-symplectic matter materialized also from the collision energy. In the collision, valence quarks connected together by color bonds to form separate units would evaporate from their hadronic space-time sheets in the collision, and would define TGD counterpart of Pomeron, which experienced a reincarnation for few years ago [C22]. The strange features of the events related to the collisions of high energy cosmic rays with hadrons of atmosphere (the particles in question are hadron like but the penetration length is anomalously long and the rate for the production of hadrons increases as one approaches surface of Earth) could be also understood in terms of the same general mechanism.
- (e) RHIC events have features which suggest that color glass condensate is very much analogous to a black-hole. This analogy has a precise formulation. Super-symplectic matter has no electro-weak interactions and is therefore dark matter in a strict sense. The exchange of super-symplectic $J = 2$ quanta brings in gravitation and string mass formula holds true. The value of the gravitational constant is however determined by hadronic p-adic length scale rather than CP_2 length scale so that strong gravitation is in question. This picture leads naturally to the question whether ordinary black-holes should be replaced by super-symplectic black-holes in TGD Universe as a natural final step of stellar evolution after the neutron star phase during which star already behaving like a gigantic hadron in super-symplectic degrees of freedom.

10.5.3 Are ordinary black-holes replaced with super-symplectic black-holes in TGD Universe?

Some variants of super string model predict the production of small black-holes at LHC. I have never taken this idea seriously but in a well-defined sense TGD predicts black-holes associated with super-symplectic gravitons with strong gravitational constant defined by the hadronic string tension. The proposal is that super-symplectic black-holes have been already seen in Hera, RHIC, and the strange cosmic ray events [K52] .

Baryonic super-symplectic black-holes of the ordinary M_{107} hadron physics would have mass 934.2 MeV, very near to proton mass. The mass of their M_{89} counterparts would be 512 times higher, about 478 GeV. "Ionization energy" for Pomeron, the structure formed by valence quarks connected by color bonds separating from the space-time sheet of super-symplectic black-hole in the production process, corresponds to the total quark mass and is about 170 MeV for ordinary proton and 87 GeV for M_{89} proton. This kind of picture about black-hole formation expected to occur in LHC differs from the stringy picture since a fusion of the hadronic mini black-holes to a larger black-hole is in question.

An interesting question is whether the ultrahigh energy cosmic rays having energies larger than the GZK cut-off of 5×10^{10} GeV are baryons, which have lost their valence quarks in a collision with hadron and therefore have no interactions with the microwave background so that they are able to propagate through long distances.

In neutron stars the hadronic space-time sheets could form a gigantic super-symplectic black-hole and ordinary black-holes would be naturally replaced with super-symplectic black-holes in TGD framework (only a small part of black-hole interior metric is representable as an induced metric). This obviously means a profound difference between TGD and string models.

- (a) Hawking-Bekenstein black-hole entropy would be replaced with its p-adic counterpart given by

$$S_p = \left(\frac{M}{m(CP_2)}\right)^2 \times \log(p) , \quad (10.5.1)$$

where $m(CP_2)$ is CP_2 mass, which is roughly 10^{-4} times Planck mass. M is the contribution of p-adic thermodynamics to the mass. This contribution is extremely small for gauge bosons but for fermions and super-symplectic particles it gives the entire mass.

- (b) If p-adic length scale hypothesis $p \simeq 2^k$ holds true, one obtains

$$S_p = k \log(2) \times \left(\frac{M}{m(CP_2)}\right)^2 . \quad (10.5.2)$$

Here one has $m(CP_2) = \hbar_0/R$, R the length of the geodesic of CP_2 .

- (c) Hawking-Bekenstein area law gives in the case of Schwarzschild black-hole

$$S = \frac{A}{4G\hbar} = \frac{\pi GM^2}{\hbar} . \quad (10.5.3)$$

For the p-adic variant of the law Planck mass is replaced with CP_2 mass and $k \log(2) \simeq \log(p)$ appears as an additional factor. Area law is obtained in the case of elementary particles if k is prime and wormhole throats have M^4 radius given by p-adic length scale $L_k = \sqrt{k}R$ which is exponentially smaller than L_p . For macroscopic super-symplectic black-holes modified area law results if the radius of the large wormhole throat equals to Schwarzschild radius. Schwarzschild radius is indeed natural: in [K85] I have shown that a simple deformation of the Schwarzschild exterior metric to a metric representing rotating star transforms Schwarzschild horizon to a light-like 3-surface at which the signature of the induced metric is transformed from Minkowskian to Euclidian. For large values of \hbar the Hawking-Bekenstein entropy becomes very small.

- (d) The formula for the gravitational Planck constant appearing in the Bohr quantization of planetary orbits and characterizing the gravitational field body mediating gravitational interaction between masses M and m [K72] reads as

$$\hbar_{gr} = \frac{GMm}{v_0} \hbar_0 .$$

$v_0 = 2^{-11}$ is the preferred value of v_0 . One could argue that the value of gravitational Planck constant is such that the Compton length \hbar_{gr}/M of the black-hole equals to its Schwarzschild radius. This would give

$$\hbar_{gr} = \frac{GM^2}{v_0} \hbar_0 , \quad v_0 = 1/2 . \quad (10.5.4)$$

The requirement that \hbar_{gr} is a ratio of ruler-and-compass integers expressible as a product of distinct Fermat primes (only four of them are known) and power of 2 would quantize the mass spectrum of black hole [K72]. Even without this constraint M^2 is integer valued using p-adic mass squared unit and if p-adic length scale hypothesis holds true this unit is in an excellent approximation power of two.

- (e) The gravitational collapse of a star would correspond to a process in which the initial value of v_0 , say $v_0 = 2^{-11}$, increases in a stepwise manner to some value $v_0 \leq 1/2$. For a supernova with solar mass with radius of 9 km the final value of v_0 would be $v_0 = 1/6$. The star could have an onion like structure with largest values of v_0 at the core as suggested by the model of planetary system. Powers of two would be favored values of v_0 . If the formula holds true also for Sun one obtains $1/v_0 = 3 \times 17 \times 2^{13}$ with 10 per cent error.

For $\hbar_{gr} = GM^2/v_0$ assignable to binary star with identical masses and for $v_0 = 1/2$ the black-hole entropy for an ideal dark black-hole would be

$$S = \pi \tag{10.5.5}$$

- (f) Black-hole evaporation could be seen as means for the super-symplectic black-hole to get rid of its electro-weak charges and fermion numbers (except right handed neutrino number) as the antiparticles of the emitted particles annihilate with the particles inside super-symplectic black-hole. This kind of minimally interacting state is a natural final state of star. Ideal super-symplectic black-hole would have only angular momentum and right handed neutrino number.
- (g) In TGD light-like partonic 3-surfaces are the fundamental objects and space-time interior defines only the classical correlates of quantum physics. The space-time sheet containing the highly entangled cosmic string might be separated from environment by a wormhole contact with size of black-hole horizon.

This looks the most plausible option but one can of course ask whether the large partonic 3-surface defining the horizon of the black-hole actually contains all super-symplectic particles so that super-symplectic black-hole would be single gigantic super-symplectic parton. The interior of super-symplectic black-hole would be a space-like region of space-time, perhaps resulting as a large deformation of CP_2 type vacuum extremal. Black-hole sized wormhole contact would define a gauge boson like variant of the black-hole connecting two space-time sheets and getting its mass through Higgs mechanism. A good guess is that these states are extremely light.

10.6 Piece-wise accelerated cosmic expansion as basic prediction of quantum cosmology

Quantum cosmology predicts that astrophysical objects do not follow cosmic expansion except in jerk-wise quantum leaps increasing the value of the gravitational Planck constant. This assumption provides explanation for the apparent cosmological constant. Also planets are predicted to expand in this manner. This provides a new version of Expanding Earth theory originally postulated to explain the intriguing findings suggesting that continents have once formed a connected continent covering the entire surface of Earth but with radius which was one half of the recent one.

10.6.1 Experimental evidence for accelerated expansion is consistent with TGD based model

There are several pieces of evidence for accelerated expansion, which need not mean cosmological constant, although this is the interpretation adopted in [E58, E24]. It is interesting to see whether this evidence is indeed consistent with TGD based interpretation.

The four pieces of evidence for accelerated expansion

1. Supernovas of type Ia

Supernovas of type *Ia* define standard candles since their luminosity varies in an oscillatory manner and the period is proportional to the luminosity. The period gives luminosity and from this the distance can be deduced by using Hubble's law: $d = cz/H_0$, H_0 Hubble's constant. The observation was that the farther the supernova was the more dimmer it was as it should have been. In other words, Hubble's constant increased with distance and the cosmic expansion was accelerating rather than decelerating as predicted by the standard matter dominated and radiation dominated cosmologies.

2. Mass density is critical and 3-space is flat

It is known that the contribution of ordinary and dark matter explaining the constant velocity of distance stars rotating around galaxy is about 25 per cent from the critical density. Could it be that total mass density is critical?

From the anisotropy of cosmic microwave background one can deduce that this is the case. What criticality means geometrically is that 3-space defined as surface with constant value of cosmic time is flat. This reflects in the spectrum of microwave radiation. The spots representing small anisotropies in the microwave background temperature is 1 degree and this correspond to flat 3-space. If one had dark matter instead of dark energy the size of spot would be .5 degrees!

Thus in a cosmology based on general relativity cosmological constant remains the only viable option. The situation is different in TGD based quantum cosmology based on sub-manifold gravity and hierarchy of gravitational Planck constants.

3. The energy density of vacuum is constant in the size scale of big voids

It was observed that the density of dark energy would be constant in the scale of 10^8 light years. This length scale corresponds to the size of big voids containing galaxies at their boundaries.

4. Integrated Sachs-Wolf effect

Also so called integrated Sachs-Wolf effect supports accelerated expansion. Very slow variations of mass density are considered. These correspond to gravitational potentials. Cosmic expansion tends to flatten them but mass accretion to form structures compensates this effect so that gravitational potentials are unaffected and there is no effect of CMB. Situation changes if dark matter is replaced with dark energy the accelerated expansion flattening the gravitational potentials wins the tendency of mass accretion to make them deeper. Hence if photon passes by an over-dense region, it receives a little energy. Similarly, photon loses energy when passing by an under-dense region. This effect has been observed.

Comparison with TGD

The minimum TGD based explanation for accelerated expansion involves only the fact that the imbeddings of critical cosmologies correspond to accelerated expansion. A more detailed model allows to understand why the critical cosmology appears during some periods.

1. Accelerated expansion in classical TGD

The first observation is that critical cosmologies (flat 3-space) imbeddable to 8-D imbedding space H correspond to negative pressure cosmologies and thus to accelerating expansion. The negativity of the counterpart of pressure in Einstein tensor is due to the fact that space-time sheet is forced to be a 4-D surface in 8-D imbedding space. This condition is analogous to a force forcing a particle at the surface of 2-sphere and gives rise to what could be called constraint force. Gravitation in TGD is sub-manifold gravitation whereas in GRT it is manifold gravitation. This would be minimum interpretation involving no assumptions about what mechanism gives rise to the critical periods.

2. Accelerated expansion and hierarchy of Planck constants

One can go one step further and introduce the hierarchy of Planck constants. The basic difference between TGD and GRT based cosmologies is that TGD cosmology is quantum cosmology. Smooth cosmic expansion is replaced by an expansion occurring in discrete jerks corresponding to the increase of gravitational Planck constant. At space-time level this means the replacement of 8-D imbedding space H with a book like structure containing almost-copies of H with various values of Planck constant as pages glued together along critical manifold through which space-time sheet can leak between sectors with different values of \hbar . This process is the geometric correlate for the phase transition changing the value of Planck constant.

During these phase transition periods critical cosmology applies and predicts automatically accelerated expansion. Neither genuine negative pressure due to "quintessence" nor cosmological constant is needed. Note that quantum criticality replaces inflationary cosmology and predicts a unique cosmology apart from single parameter. Criticality also explains the fluctuations in microwave temperature as long range fluctuations characterizing criticality.

3. Accelerated expansion and flatness of 3-cosmology

Observations 1) and 2) about super-novae and critical cosmology (flat 3-space) are consistent with this cosmology. In TGD dark energy must be replaced with dark matter because the mass density is critical during the phase transition. This does not lead to wrong sized spots since it is the increase of Planck constant which induces the accelerated expansion understandable also as a constraint force due to imbedding to H .

4. The size of large voids is the characteristic scale

The TGD based model in its simplest form model assigns the critical periods of expansion to large voids of size 10^8 ly. Also larger and smaller regions can express similar periods and dark space-time sheets are expected to obey same universal "cosmology" apart from a parameter characterizing the duration of the phase transition. Observation 3) that just this length scale defines the scale below which dark energy density is constant is consistent with TGD based model.

The basic prediction is jerkwise cosmic expansion with jerks analogous to quantum transitions between states of atom increasing the size of atom. The discovery of large voids with size of order 10^8 ly but age much longer than the age of galactic large voids conforms with this prediction. On the other hand, it is known that the size of galactic clusters has not remained constant in very long time scale so that jerkwise expansion indeed seems to occur.

5. Do cosmic strings with negative gravitational mass cause the phase transition inducing accelerated expansion

Quantum classical correspondence is the basic principle of quantum TGD and suggest that the effective antigravity manifested by accelerated expansion might have some kind of concrete space-time correlate. A possible correlate is super heavy cosmic string like objects at the center of large voids which have negative gravitational mass under very general assumptions. The repulsive gravitational force created by these objects would drive galaxies to the boundaries of large voids. At some state the pressure of galaxies would become too strong and induce a quantum phase transition forcing the increase of gravitational Planck constant and expansion of the void taking place much faster than the outward drift of the galaxies. This process would repeat itself. In the average sense the cosmic expansion would not be accelerating.

Does TGD allow description of accelerated expansion in terms of cosmological constant?

The introduction of cosmological constant seems to be the only manner to explain accelerated expansion and related effects in the framework of General Relativity. TGD allows different explanation of these effects. It is however interesting to look whether TGD allows a description based on finite cosmological constant as a small deformation of De Sitter space represented as a vacuum extremal. Before this a clarifying comment about the term "vacuum energy".

The term vacuum energy density is bad use of language since De Sitter space [B7] is a solution of field equations with cosmological constant at the limit of vanishing energy momentum tensor carries *vacuum curvature* rather than vacuum energy. Thus theories with non-vanishing cosmological constant represent a family of gravitational theories for which vacuum solution is not flat so that Einstein's basic identification matter = curvature is given up. No wonder, Einstein regarded the introduction of cosmological constant as the biggest blunder of his life.

De Sitter space is representable as a hyperboloid $a^2 - u^2 = -R^2$, where one has $a^2 = t^2 - r^2$ and $r^2 = x^2 + y^2 + z^2$. The symmetries of de Sitter space are maximal but Poincare group is replaced with Lorentz group of 5-D Minkowski space and translations are not symmetries. The value of cosmological constant is $\Lambda = 3/R^2$. The presence of non-vanishing dimensional constant is from the point of view of conformal invariance a feature raising strong suspicions about the correctness of the underlying physics.

1. Imbeddings of De Sitter space

De Sitter space is possible as a vacuum extremal in TGD framework. There exists infinite number of imbeddings as a vacuum extremal into $M^4 \times CP_2$. Take any infinitely long curve X in CP_2 not intersecting itself (one might argue that infinitely long curve is somewhat pathological) and introduce a coordinate u for it such that its induced metric is $ds^2 = du^2$. De Sitter space allows the standard imbedding to $M^4 \times X$ as a vacuum extremal. The imbedding can be written as $u = \pm[a^2 + R^2]^{1/2}$ so that one has $r^2 < t^2 + R^2$. One example is curve in S^2 which spirals around chosen point infinitely many times so that at the vicinity of point it almost fills 2-dimensional region of S^2 . One can also combine spirals associated with two distinct points so that u coordinate spans range $[-\infty, \infty]$.

The curve in question can also fill 2-D or higher-dimensional sub-manifold of CP_2 densely. An example is torus densely filled by the curve $\phi = \alpha\psi$ where α is irrational number. Note that even a slightest local deformation of this object induces an infinite number of self-intersections. Space-time sheet fills densely 5-D set in this case. One can ask whether this kind of objects might be analogs of $D > 4$ branes in TGD framework. As a matter fact, CP_2 projections of 1-D vacuum extremals could give rise to both the analogs of branes and strings connecting them if space-time surface contains both regular and "brany" pieces. Perhaps this might provide a new (possibly) approach to the understanding of branes in M-theory context.

It might be that the 2-D Lagrangian manifolds representing CP_2 projection of the most general vacuum extremal, can fill densely $D > 2$ -dimensional sub-manifold of CP_2 . One can imagine construction of very complex Lagrange manifolds by gluing together pieces of 2-D Lagrangian sub-manifolds by arbitrary 1-D curves. One could also rotate 2-Lagrangian manifold along a 2-torus - just like one rotates point along 2-torus in the above example - to get a dense filling of 4-D volume of CP_2 .

The M^4 projection of the imbedding corresponds to the region $a^2 > -R^2$ containing future and past lightcones. If u varies only in range $[0, u_0]$ only hyperboloids with a^2 in the range $[-R^2, -R^2 + u_0^2]$ are present in the foliation. In zero energy ontology the space-like boundaries of this piece of De Sitter space, which must have $u_0^2 > R^2$, would be carriers of positive and negative energy states. The boundary corresponding to $u_0 = 0$ is space-like and analogous to the orbit of partonic 2-surface. For $u_0^2 < R^2$ there are no space-like boundaries and the interpretation as a zero energy state is not possible. Note that the restriction $u_0^2 \geq R^2$ plus the choice of the branch of the imbedding corresponding to future or past directed lightcone is natural in TGD framework.

2. Could negative cosmological constant make sense in TGD framework?

The questionable feature of slightly deformed De Sitter metric as a model for the accelerated expansion is that the value of a would be same order of magnitude as the recent age of the Universe. Why should just this value of cosmic time be so special? In TGD framework one could of course consider space-time sheets having De Sitter cosmology characterized by a varying value of R . Also the replacement of one spatial coordinate with CP_2 coordinate implies very strong breaking of translational invariance. Hence the explanation relying on quantization of gravitational Planck constant looks more attractive to me.

It is however always useful to make an exercise in challenging the cherished beliefs.

- (a) Could the complete failure of the perturbation theory around canonically imbedded M^4 make De Sitter cosmology natural vacuum extremal. De Sitter space appears also in the models of inflation and long range correlations might have something to do with the intersections between distant points of 3-space resulting from very small local deformations. Could both the slightly deformed De Sitter space and quantum critical cosmology represent cosmological epochs in TGD Universe?
- (b) Gravitational energy defined as a non-conserved Noether charge in terms of Einstein tensor TGD is infinite for de-Sitter cosmology (Λ as characterizer of vacuum energy). If one includes to the gravitational momentum also metric tensor gravitational four-momentum density vanishes (Λ as characterizer of vacuum curvature). TGD does not involve Einstein-Hilbert action as fundamental action and gravitational energy momentum tensor should be dictated by finiteness condition so that negative cosmological constant might make sense in TGD.
- (c) The imbedding of De Sitter cosmology involves the choice of a preferred lightcone as does also quantization of Planck constant. Quantization of Planck constant involves the replacement of the lightcones of $M^4 \times CP_2$ by its finite coverings and orbifolds glued to together along quantum critical sub-manifold. Finite pieces of De Sitter space are obtained for rational values of α and there is a covering of lightcone by CP_2 points. How can I be sure that there does not exist a deeper connection between the descriptions based on cosmological constant and on phase transitions changing the value Planck constant?

Note that Anti de Sitter space [B1] having similar imbedding to 5-D Minkowski space with two time like dimensions does not possess this kind of imbedding to H . Very probably no imbeddings exist so that TGD would allow only imbeddings of cosmologies with correct sign of Λ whereas M-theory in its basic form predicts a wrong sign for it. Note also that Anti de Sitter space appearing in AdS-CFT dualities contains closed time-like loops and is therefore also physically questionable.

The mystery of mini galaxies and the hierarchy of Planck constants

New Scientist [E85] informs that a team led by Pieter van Dokkum at Yale University measured the light of distant galaxies from around 3 billion years after the big bang. They had the same mass as the Milky Way, but were 10 times smaller (The Astrophysical Journal, vol. 677, p. L5). Peering at younger regions of the sky shows that galaxies this size are no longer around, but it's not clear what happened to them. "This is a very puzzling result," says Simon White of the Max Planck Institute for Astrophysics in Garching, Germany. "Galaxies cannot disappear." Team member Marijn Franx of Leiden Observatory, the Netherlands, suspects they have since merged with extremely massive galaxies. The disappearance of the mini galaxies would be due to this mechanism. From the assumption that this mechanism gives rise to the same outcome as smooth expansion within factor of two at given moment, one could estimate their recent size. If the galaxies are assumed to have roughly the size of Milky Way now, an upwards scaling would be roughly by a factor 8. This would mean that recent age of Universe would be about 24 billion years.

10.6.2 Quantum version of Expanding Earth theory

TGD predicts that cosmic expansion at the level of individual astrophysical systems does not take place continuously as in classical gravitation but through discrete quantum phase transitions increasing gravitational Planck constant and thus various quantum length and time scales. The reason would be that stationary quantum states for dark matter in astrophysical length scales cannot expand. One would have the analog of atomic physics in cosmic scales. Increases of \hbar by a power of two are favored in these transitions but also other scalings are possible.

This has quite far reaching implications.

- (a) These periods have a highly unique description in terms of a critical cosmology for the expanding space-time sheet. The expansion is accelerating. The accelerating cosmic expansion can be assigned to this kind of phase transition in some length scale (TGD Universe is fractal). There is no need to introduce cosmological constant and dark energy would be actually dark matter.
- (b) The recently observed void which has same size of about 10^8 light years as large voids having galaxies near their boundaries but having an age which is much higher than that of the large voids, would represent one example of jerk-wise expansion.
- (c) This picture applies also to solar system and planets might be perhaps seen as having once been parts of a more or less connected system, the primordial Sun. The Bohr orbits for inner and outer planets correspond to gravitational Planck constant which is 5 times larger for outer planets. This suggests that the space-time sheet of outer planets has suffered a phase transition increasing the size scale by a factor of 5. Earth can be regarded either as $n=1$ orbit for Planck constant associated with outer planets or $n=5$ orbit for inner planetary system. This might have something to do with the very special position of Earth in planetary system. One could even consider the possibility that both orbits are present as dark matter structures. The phase transition would also explain why $n=1$ and $n=2$ Bohr orbits are absent and one only $n=3,4$, and 5 are present.
- (d) Also planets should have experienced this kind of phase transitions increasing the radius: the increase by a factor two would be the simplest situation.

The obvious question - that I did not ask - is whether this kind of phase transition might have occurred for Earth and led from a completely granite covered Earth - Pangeia without seas - to the recent Earth. Neither it did not occur to me to check whether there is any support for a rapid expansion of Earth during some period of its history.

Situation changed when my son visited me last Saturday and told me about a Youtube video [F35] by Neal Adams, an American comic book and commercial artist who has also produced animations for geologists. We looked the amazing video a couple of times and I looked it again yesterday. The video is very impressive artwork but in the lack of references skeptic probably cannot avoid the feeling that Neal Adams might use his highly developed animation skills to cheat you. I found also a polemic article [F1] of Adams but again the references were lacking. Perhaps the reason of polemic tone was that the concrete animation models make the expanding Earth hypothesis very convincing but geologists refuse to consider seriously arguments by a layman without a formal academic background.

The claims of Adams

The basic claims of Adams were following.

- (a) The radius of Earth has increased during last 185 million years (dinosaurs [I2] appeared for about 230 million years ago) by about factor 2. If this is assumed all continents have formed at that time a single super-continent, Pangeia, filling the entire Earth surface rather than only 1/4 of it since the total area would have grown by a factor of 4. The basic argument was that it is very difficult to imagine Earth with 1/4 of surface containing granite and 3/4 covered by basalt. If the initial situation was covering by mere granite -as would look natural- it is very difficult for a believer in thermodynamics to imagine how the granite would have gathered to a single connected continent.
- (b) Adams claims that Earth has grown by keeping its density constant, rather than expanded, so that the mass of Earth has grown linearly with radius. Gravitational acceleration would have thus doubled and could provide a partial explanation for the disappearance of dinosaurs: it is difficult to cope in evolving environment when you get slower all the time.
- (c) Most of the sea floor is very young and the areas covered by the youngest basalt are the largest ones. This Adams interprets this by saying that the expansion of Earth is accelerating. The alternative interpretation is that the flow rate of the magma slows down as it recedes from the ridge where it erupts. The upper bound of 185 million years for

the age of sea floor requires that the expansion period - if it is already over - lasted about 185 million years after which the flow increasing the area of the sea floor transformed to a convective flow with subduction so that the area is not increasing anymore.

- (d) The fact that the continents fit together - not only at the Atlantic side - but also at the Pacific side gives strong support for the idea that the entire planet was once covered by the super-continent. After the emergence of subduction theory this evidence has been dismissed.
- (e) I am not sure whether Adams mentions the following objections [F5] . Subduction only occurs on the other side of the subduction zone so that the other side should show evidence of being much older in the case that oceanic subduction zones are in question. This is definitely not the case. This is explained in plate tectonics as a change of the subduction direction. My explanation would be that by the symmetry of the situation both oceanic plates bend down so that this would represent new type of boundary not assumed in the tectonic plate theory.
- (f) As a master visualizer Adams notices that Africa and South-America do not actually fit together in absence of expansion unless one assumes that these continents have suffered a deformation. Continents are not easily deformable stuff. The assumption of expansion implies a perfect fit of *all* continents without deformation.

Knowing that the devil is in the details, I must admit that these arguments look rather convincing to me and what I learned from Wikipedia articles supports this picture.

The critic of Adams of the subduction mechanism

The prevailing tectonic plate theory [F23] has been compared to the Copernican revolution in geology. The theory explains the young age of the seafloor in terms of the decomposition of the lithosphere to tectonic plates and the convective flow of magma to which oceanic tectonic plates participate. The magma emerges from the crests of the mid ocean ridges representing a boundary of two plates and leads to the expansion of sea floor. The variations of the polarity of Earth's magnetic field coded in sea floor provide a strong support for the hypothesis that magma emerges from the crests.

The flow back to would take place at so called oceanic trenches [F16] near continents which represent the deepest parts of ocean. This process is known as subduction. In subduction oceanic tectonic plate bends and penetrates below the continental tectonic plate, the material in the oceanic plate gets denser and sinks into the magma. In this manner the oceanic tectonic plate suffers a metamorphosis returning back to the magma: everything which comes from Earth's interior returns back. Subduction mechanism explains elegantly formation of mountains [F17] (orogeny), earth quake zones, and associated zones of volcanic activity [F33] .

Adams is very polemic about the notion of subduction, in particular about the assumption that it generates steady convective cycle. The basic objections of Adams against subduction are following.

- (a) There are not enough subduction zones to allow a steady situation. According to Adams, the situation resembles that for a flow in a tube which becomes narrower. In a steady situation the flow should accelerate as it approaches subduction zones rather than slow down. Subduction zones should be surrounded by large areas of sea floor with constant age. Just the opposite is suggested by the fact that the youngest portion of sea-floor near the ridges is largest. The presence of zones at which both ocean plates bend down could improve the situation. Also jamming of the flow could occur so that the thickness of oceanic plate increases with the distance from the eruption ridge. Jamming could increase also the density of the oceanic plate and thus the effectiveness of subduction.
- (b) There is no clear evidence that subduction has occurred at other planets. The usual defense is that the presence of sea is essential for the subduction mechanism.
- (c) One can also wonder what is the mechanism that led to the formation of single super continent Pangeia covering 1/4 of Earth's surface. How probable the gathering of all separate continents to form single cluster is? The later events would suggest that just the opposite should have occurred from the beginning.

Expanding Earth theories are not new

After I had decided to check the claims of Adams, the first thing that I learned is that Expanding Earth theory [F5], whose existence Adams actually mentions, is by no means new. There are actually many of them.

The general reason why these theories were rejected by the main stream community was the absence of a convincing physical mechanism of expansion or of growth in which the density of Earth remains constant.

- (a) 1888 Yarkovski postulated some sort of aether absorbed by Earth and transforming to chemical elements (TGD version of aether could be dark matter). 1909 Mantovani [F25] postulated thermal expansion but no growth of the Earth's mass.
- (b) Paul Dirac's idea about changing Planck constant led Pascual Jordan in 1964 to a modification of general relativity predicting slow expansion of planets. The recent measurement of the gravitational constant imply that the upper bound for the relative change of gravitational constant is 10 times too small to produce large enough rate of expansion. Also many other theories have been proposed but they are in general conflict with modern physics.
- (c) The most modern version of Expanding Earth theory is by Australian geologist Samuel W. Carey. He calculated that in Cambrian period (about 500 million years ago) all continents were stuck together and covered the entire Earth. Deep seas began to evolve then.

Summary of TGD based theory of Expanding Earth

TGD based model differs from the tectonic plate model but allows subduction which cannot imply considerable back-flow of magma. Let us sum up the basic assumptions and implications.

- (a) The expansion is or was due to a quantum phase transition increasing the value of gravitational Planck constant and forced by the cosmic expansion in the average sense.
- (b) Tectonic plates do not participate to the expansion and therefore new plate must be formed and the flow of magma from the crests of mid ocean ridges is needed. The decomposition of a single plate covering the entire planet to plates to create the mid ocean ridges is necessary for the generation of new tectonic plate. The decomposition into tectonic plates is thus prediction rather than assumption.
- (c) The expansion forced the decomposition of Pangeia super-continent covering entire Earth for about 530 million years ago to split into tectonic plates which began to recede as new non-expanding tectonic plate was generated at the ridges creating expanding sea floor. The initiation of the phase transition generated formation of deep seas.
- (d) The eruption of plasma from the crests of ocean ridges generated oceanic tectonic plates which did not participate to the expansion by density reduction but by growing in size. This led to a reduction of density in the interior of the Earth roughly by a factor 1/8. From the upper bound for the age of the seafloor one can conclude that the period lasted for about 185 million years after which it transformed to convective flow in which the material returned back to the Earth interior. Subduction at continent-ocean floor boundaries and downwards double bending of tectonic plates at the boundaries between two ocean floors were the mechanisms. Thus tectonic plate theory would be more or less the correct description for the recent situation.
- (e) One can consider the possibility that the subducted tectonic plate does not transform to magma but is fused to the tectonic layer below continent so that it grows to an iceberg like structure. This need not lead to a loss of the successful predictions of plate tectonics explaining the generation of mountains, earthquake zones, zones of volcanic activity, etc...
- (f) From the video of Adams it becomes clear that the tectonic flow is East-West asymmetric in the sense that the western side is more irregular at large distances from the ocean ridge at the western side. If the magma rotates with slightly lower velocity than the surface of Earth (like liquid in a rotating vessel), the erupting magma would rotate slightly slower than the tectonic plate and asymmetry would be generated.

- (g) If the planet has not experienced a phase transition increasing the value of Planck constant, there is no need for the decomposition to tectonic plates and one can understand why there is no clear evidence for tectonic plates and subduction in other planets. The conductive flow of magma could occur below this plate and remain invisible.

The biological implications might provide a possibility to test the hypothesis.

- (a) Great steps of progress in biological evolution are associated with catastrophic geological events generating new evolutionary pressures forcing new solutions to cope in the new situation. Cambrian explosion indeed occurred about 530 years ago (the book "Wonderful Life" of Stephen Gould [I10] explains this revolution in detail) and led to the emergence of multicellular creatures, and generated huge number of new life forms living in seas. Later most of them suffered extinction: large number of phylae and groups emerged which are not present nowadays.

Thus Cambrian explosion is completely exceptional as compared to all other dramatic events in the evolution in the sense that it created something totally new rather than only making more complex something which already existed. Gould also emphasizes the failure to identify any great change in the environment as a fundamental puzzle of Cambrian explosion. Cambrian explosion is also regarded in many quantum theories of consciousness (including TGD) as a revolution in the evolution of consciousness: for instance, micro-tubuli emerged at this time. The periods of expansion might be necessary for the emergence of multicellular life forms on planets and the fact that they unavoidably occur sooner or later suggests that also life develops unavoidably.

- (b) TGD predicts a decrease of the surface gravity by a factor 1/4 during this period. The reduction of the surface gravity would have naturally led to the emergence of dinosaurs 230 million years ago as a response coming 45 million years after the accelerated expansion ceased. Other reasons led then to the decline and eventual catastrophic disappearance of the dinosaurs. The reduction of gravity might have had some gradually increasing effects on the shape of organisms also at microscopic level and manifest itself in the evolution of genome during expansion period.
- (c) A possibly testable prediction following from angular momentum conservation ($\omega R^2 = \text{constant}$) is that the duration of day has increased gradually and was four times shorter during the Cambrian era. For instance, genetically coded bio-clocks of simple organisms during the expansion period could have followed the increase of the length of day with certain lag or failed to follow it completely. The simplest known circadian clock is that of the prokaryotic cyanobacteria. Recent research has demonstrated that the circadian clock of *Synechococcus elongatus* can be reconstituted in vitro with just the three proteins of their central oscillator. This clock has been shown to sustain a 22 hour rhythm over several days upon the addition of ATP: the rhythm is indeed faster than the circadian rhythm. For humans the average innate circadian rhythm is however 24 hours 11 minutes and thus conforms with the fact that human genome has evolved much later than the expansion ceased.
- (d) Scientists have found a fossil of a sea scorpion with size of 2.5 meters [I15], which has lived for about 10 million years for 400 million years ago in Germany. The gigantic size would conform nicely with the much smaller value of surface gravity at that time. The finding would conform nicely with the much smaller value of surface gravity at that time. Also the emergence of trees could be understood in terms of a gradual growth of the maximum plant size as the surface gravity was reduced. The fact that the oldest known tree fossil is 385 million years old [I12] conforms with this picture.

Did intra-terrestrial life burst to the surface of Earth during Cambrian expansion?

Intra-terrestrial hypothesis [K33] is one of the craziest TGD inspired ideas about the evolution of life and it is quite possible that in its strongest form the hypothesis is unrealistic. One can however try to find what one obtains from the combination of the IT hypothesis with the idea of pre-Cambrian granite Earth. Could the harsh pre-Cambrian conditions have allowed only

intra-terrestrial multicellular life? Could the Cambrian explosion correspond to the moment of birth for this life in the very concrete sense that the magma flow brought it into the day-light?

- (a) Gould emphasizes the mysterious fact that very many life forms of Cambrian explosion looked like final products of a long evolutionary process. Could the eruption of magma from the Earth interior have induced a burst of intra-terrestrial life forms to the Earth's surface? This might make sense: the life forms living at the bottom of sea do not need direct solar light so that they could have had intra-terrestrial origin. It is quite possible that Earth's mantle contained low temperature water pockets, where the complex life forms might have evolved in an environment shielded from meteoric bombardment and UV radiation.
- (b) Sea water is salty. It is often claimed that the average salt concentration inside cell is that of the primordial sea: I do not know whether this claim can be really justified. If the claim is true, the cellular salt concentration should reflect the salt concentration of the water inside the pockets. The water inside water pockets could have been salty due to the diffusion of the salt from ground but need not have been same as that for the ocean water (higher than for cell interior and for obvious reasons). Indeed, the water in the underground reservoirs in arid regions such as Sahara is salty, which is the reason for why agriculture is absent in these regions. Note also that the cells of marine invertebrates are osmoconformers able to cope with the changing salinity of the environment so that the Cambrian revolutionaries could have survived the change in the salt concentration of environment.
- (c) What applies to Earth should apply also to other similar planets and Mars [E25] is very similar to Earth. The radius is .533 times that for Earth so that after quantum leap doubling the radius and thus Schumann frequency scale (7.8 Hz would be the lowest Schumann frequency) would be essentially same as for Earth now. Mass is .131 times that for Earth so that surface gravity would be .532 of that for Earth now and would be reduced to .131 meaning quite big dinosaurs! have learned that Mars probably contains large water reservoirs in it's interior and that there is an un-identified source of methane gas usually assigned with the presence of life. Could it be that Mother Mars is pregnant and just waiting for the great quantum leap when it starts to expand and gives rise to a birth of multicellular life forms. Or expressing freely how Bible describes the moment of birth: in the beginning there was only darkness and water and then God said: Let the light come!

To sum up, TGD would not only provide the long sought mechanism of expansion of Earth but also a possible connection with the biological evolution. It would be indeed fascinating if Planck constant changing quantum phase transitions in planetary scale would have profoundly affected the biosphere.

10.7 Implications of Expanding Earth model for the pre-Cambrian evolution of continents, of climate, and of life

Expanding Earth hypothesis is by no means not new. It was proposed by Mantovani and I learned about it from the video animations of [F35, F1] demonstrating that the continents fit nicely to form a single continent covering entire Earth if the radius is one half of the recent radius. What TGD has to give is a new physics justification for Expanding Earth hypothesis: cosmic expansion is replaced with a sequence of fast expansion periods increasing the value of Planck constant and these transitions occur in all scales.

If Expanding Earth hypothesis is correct it forces to modify dramatically the view about pre-Cambrian period. The super-continent theory could be replaced by much simpler theory and it might be possible to give up the assumption about hypothetical super continents and super oceans. The view about glaciations [F7] must be modified dramatically. Concerning the evolution of life the natural hypothesis is that it escaped to the underground seas formed as a consequence of expansion during pre-Cambrian era and returned back to the surface in Cambrian Explosion. In this section super-continent and super-ocean theory is discussed from TGD point of view. A model for glaciations based on the assumption that the radius of Earth was in good approximation one half of the recent radius during pre-Cambrian era is developed and

shown to reduce to a sequence of ordinary glaciations initiated at pole caps. Snowball theory serves as a convenient reference. Expanding Earth theory is discussed also from paleomagnetic point of view and some experimental signatures of $R/2$ scenario differentiating it from standard scenarios are developed. Finally the hypothesis about underground evolution is discussed.

10.7.1 Super-continent theory

Super-continent theory assumes a cyclic formation of hypothetical super continents [F28] . Rodinia [F26] , Pannotia [F21] , and Pangea [F20] might have preceded by earlier super-continents. The period would be roughly 250 Myr.

- (a) The super-continent Rodinia [F26] is assumed to have existed during interval: 1100-750 Myr. 750 Myr ago Rodinia rifted into three continents: Proto-Laurasia which broke up and eventually reformed to form Laurasia (North America and Asia), the continental craton of Congo (part of Africa), and Gondwana (now southern hemisphere plus India).
- (b) Pannotia [F21] existed during time interval 600-540 Myr. Pannotia rifted in the beginning of Cambrian era to Laurentia (North America), Baltica, Siberia and Gondwana. See the illustration of Pannotia at [F10] .
- (c) Wegener [F2] ended up to postulate that super-continent Pangea should have existed about 250 Myr ago [F20] . The support for its existence is rather strong since tectonic plate model and paleo-magnetic methods allows to trace the drift of the tectonic plates.

One can criticize the cyclic model. The concentration of land mass to Southern Hemisphere during Rodinia period does not look very probable event. The cyclically occurring formation of connected land mass surrounded by much larger ocean looks even less probable unless one can develop some very good physical mechanism forcing this. The basic motivation for super-continent theory are various correlations between distant parts of Earth which would cannot be understood otherwise. In $R/2$ model the the continents would have been quite near to each other during the expansion and the notion of cyclic formation of super-continents becomes unnecessary since land bridges between the continents could explain the correlations. There would have been just single super-continent all the time.

10.7.2 Standard view about oceans

In the standard model the total area covered by oceans has reduced since pre-Cambrian era due to the increase of the continental cover, which is nowadays 29 per cent. Oceans cover the remaining 71 per cent with Antarctica and Arctica included. The evolution of Oceans in standard model requires the introduction of hypothetical oceans which left no trace about their existence (subduction mechanism provides perhaps too convenient trash bin for hypothetical theoretical constructs).

- (a) Proto-Atlantic Ocean was introduced to explain some contradictions with Wegener's Pangea model allowing to conclude which parts at opposite sides of Atlantic Ocean had been in contact. Proto-Atlantic Ocean closed as Pangea formed and opened again in slightly different manner to form Atlantic Ocean. This process implied mixing of older pieces of the continents and explained the contradictions. Large inland sea is a natural counterpart of the Proto-Atlantic Ocean in $R/2$ option.
- (b) Mirovia [F14] was the super-ocean surrounding Rodinia. It transformed to Pan-African Ocean surrounding Pannotia. Pan-African ocean was then closed so that the ocean floor of Mirovia disappeared by subduction and left no signs about its existence.
- (c) In the rifting [F24] of Pannotia Panthalassic ocean [F22] emerged and was the predecessor of the Pacific ocean.

The presence of super-oceans is forced by the assumption that the radius of Earth was the recent one during the pre-Cambrian era plus the local data related to the evolution of continents. The

questionable aspect is that these oceans did not leave any direct trace about their existence. In $R/2$ model there is no need for these super-oceans except possibly the counterpart of Panthalassic Ocean [F22] .

10.7.3 Glaciations during Neoproterozoic period

Glaciations dominated the Neoproterozoic period [F15] between 1-.542 billion years. The period is divided into Tonian [F32] , Cryogenian [F3] , and Ediacaran periods [F4] . The most severe glaciations occurred during Cryogenian period.

It is believed that during Cryogenian period [F3] two worldwide glaciations -Sturtian and Marinoan glaciations- took place. This involves extrapolation of continental drift model and plate tectonics theory. Also hypothesis about hypothetical super-continent is needed so that one must take these beliefs with some skepticism. In $R/2$ model the world wide glaciations are replaced with ordinary glaciations proceeding from poles.

- (a) Sturtian glaciation occurred 750-700 Myr. The breakup of Rodinia is believed to have occurred at this time. One can wonder whether there is a correlation between these events. $R/2$ model suggest that the energy needed to compensate the reduction of gravitational energy in expansion could have caused the cooling.
- (b) Marinoan (Varanger) glaciation ended around 635 Myr ago.

Deposits of glacial tillites [F31] at low latitudes serve as support for the claim that these glaciations were world wide. In $R/2$ model Equator corresponds to North pole in TGD framework where Rodinia covered entire Earth and the interpretation would as ordinary glaciations.

After the end of Marinoan glaciation followed Ediacaran period during 635-542 Myr [F4] . The first multicellular fossils appeared at this time. Their relationship to Cambrian fossils is unclear. The standard interpretation for the small number of fossils in pre-Cambrian period is that hard shells needed for fossilization were not yet developed. The problem is that these shells should have developed almost instantaneously in Cambrian explosion.

10.7.4 Snowball Earth model for the glaciation during pre-Cambrian era

Snowball Earth [F39, F38, F27] is recently the leading model for the glaciations [F8] during Proterozoic era. The term is actually somewhat misleading: Iceball Earth would more to the point. Slushball earth [F37] is a variant of Snowball Earth which does not assume total freezing near equator.

The history behind the Snowball Earth concept is roughly following [F27] .

- (a) Mawson studied the Neoproterozoic stratigraphy of South Australia and identified extensive glacial sediments and speculated with the possibility of global glaciation. He did not know anything about continental drift hypothesis and plate tectonic theory and thought that the ancient position of Australia was the same as it is today. Continent drifting hypothesis however explained the finding as sediments deposited at the higher latitudes the hypothesis was forgotten.
- (b) Later Harland suggested on basis of geomagnetic data that glacial tillites [F31] in Svalbard and Greenland were deposited at tropical latitudes. In TGD framework with $R \rightarrow R/2$ these tillites would have been at higher latitudes towards North Pole.
- (c) The facts are that Sun was 6 per cent fainter at that time and glaciations are known to occur. The question is whether they were global and long-lasting or a sequence of short-lasting possibly local glaciations. The Russian climatologist Budyko constructed a model based on energy balance and found that it is possible to have a global glaciation if the ice sheets proceeded enough from polar regions (to about 30 degree latitude). The model was based on the increased reflectiveness (albedo) of the Earth's surface due to the ice covering

giving rise to positive feedback loop. Budyko did not believe that global glaciation had occurred since the model offered no way to escape eternal glaciation.

- (d) Kirschvink introduced the term Snowball Earth, which is actually misleading. Iceball Earth would be more to the point. He found that the so called banded iron formations are consistent with a global glaciation. He also proposed a mechanism for melting the snowball. The accumulation of CO₂ from volcanoes would have caused ultra-greenhouse effect causing warming of the atmosphere and melting of the ice.
- (e) Slushball Earth [F37] differs from Snowball Earth in that that only a thin ice cover or even its absence near equator is assumed. The model allows to explain various findings in conflict with Snowball Earth, such as the evidence for the presence of melt-water basins.
- (f) Zipper rift model [F40] assumes that there was a sequence of glaciations rather similar to the glaciations that have occurred later. The model assumes that the rifts [F24] of the super-continent Rodinia occurred simultaneously with glaciations. The associated tectonic uplift led to the formation of high plateaus hosting the glaciers. The iron band formation can be assigned with inland seas allowing complex chemistries and anoxicity near the sea floor.

The basic ideas of the Snowball Earth model

Snowball Earth [F39, F38, F27] differs from ordinary glaciations in that only oceans are frozen whereas in the ordinary glaciation land mass is covered by ice. The basic ideas of the snowball Earth relate to the mechanism initiating the global freezing and melting.

- (a) The glaciation would have been initiated by some event, say a creation of super-volcano. Also astrophysical mechanism might be involved. Somewhat paradoxically, tropical continents during cryogenian period [F3] are needed for the initiation because they reflect the solar radiation more effectively than tropical oceans.
- (b) The positive ice-albedo feedback is an essential concept: the more ice the larger the fraction of the radiation reflected back so that the more ice is generated. If the glaciation proceeds over a critical latitude about 30 degrees positive feedback forces a global glaciation.
- (c) The problem of the model is how to get rid of the glaciation. The proposal of Kirschvink was that the accumulation of CO₂ from volcanoes could have led to a global super-warming. The time scale for CO₂ emissions is measured in millions of years. The needed atmospheric concentration of CO₂ is by a factor 350 higher than the recent concentration. Due the ice cover the CO₂ could not be absorbed to the siliceous rocks and concentration would increase. The melting of the ice meant higher absorption of heat by uncovered land. Positive feedback loop was at work again but in different direction.

Evidence for and objections against Snowball Earth

Wikipedia article about Snowball Earth [F27] discusses both evidence for and objections against Snowball Earth. Low latitude sediments at tropical latitudes and tropical tillites at Equatorial latitudes provide strong piece of evidence for Snowball Earth. Calcium carbonate deposits having ¹³C signature (per cent for the depletion of ¹³ isotope and large for organic material) consistent with that for mantle meaning abiotic origin is second evidence. Iridium anomaly located at the base of Calcium Carbonate deposits is third piece of evidence. The evidence for Snowball Earth will be discussed in more detail later since it is convenient to relate the evidence to $R/2$ model for glaciations.

- (a) Paleomagnetic data [F19] used to the dating of sediments assuming tectonic plate theory and super-continent drifting might be misleading. No pole wandering maps exist and the polarity of the magnetic field must be deduced by statistical methods. The primary magnetization could have been reset and the orientation of the magnetic minerals could have changed from the original one. It is also possible that magnetic field patterns were not dipolar. Also the assumption of hypothetical super-continent and oceans brings in uncertainties. In $R/2$ model of course the determination of the positions changes completely.

- (b) Carbon isotope ratios are not what they should be. There are rapid variations of $^{12}\text{C}/^{13}\text{C}$ ratio with organic origin. Suggests that freezing and melting followed each other in rapid succession. In standard framework this would suggest Slushball Earth meaning ice-free and ice-thin regions around the equator and hydrological cycles. In $R/2$ model the regions at Equator are near North Pole and the explanation would be in terms of ordinary glaciations.
- (c) The distribution of isotopes of element Boron suggest variations of pH of oceans. The explanation is in terms of buildup of carbon dioxide in atmosphere dissolved into oceans/seas. In $R/2$ model a sequence of glaciations would explain the findings.
- (d) Banded iron formations providing support for the model are actually rather rare and absent during Marinoan glaciation.
- (e) Wave-formed ripples, far-traveled ice-rafted debris and indicators of photosynthetic activity, can be found throughout sediments dating from the 'Snowball Earth' periods. This serves as evidence open-water deposits. In snow-ball model these could be 'oases' of melt-water but computer simulations suggest that large areas of oceans would have left ice-free. In $R/2$ model these would be signatures of ordinary glaciations.
- (f) Paleomagnetic data have led to the conclusion that Australia was at Equator. In $R/2$ model it would have been near North Pole. Namibia was also thought to be near Equator [F29]. Indirect arguments forced the conclusion that it was at 75 degree Southern latitude. In $R/2$ model this corresponds to 60 degrees Southern latitude and ordinary glaciation proceeding from South Pole is a natural explanation and ordinary glaciation would be in question in both cases.
- (g) There is evidence for the continental ice cover does not fit with Snowball Earth predicts that there should be no continental ice-cover. The reason is that freezing of the ocean means that there is no evaporation from oceans and no water circulation so that ice-cover cannot develop on continents. There is considerable evidence that continents were covered by thick ice [F27]. This suggests ordinary glaciations possible in $R/2$ model.

10.7.5 TGD point of view about pre-Cambrian period

What is new in TGD based view about pre-Cambrian period is basically due to the $R/2$ hypothesis.

TGD view about evolution of continents

The hypothesis about the existence of the super-continent Pangea [F20] was inspired by the work of Wegener [F2]. The hypothesis about the existence of former super-continents were forced by the correlations with fossil records suggesting connected continent. This is not necessary if the gigantic ocean was absent during $R/2$ era. The continent Rodinia [F26] could look much like the Rodinia of standard geology except that they formed single connected region with radius $R/2$.

- (a) It is possible that there was only single super-continent with widening inland seas all the time until 250 billion Myr. The first option is R increased slowly and that inland lake formed. Rifts could have got wider gradually during this era. If there were land bridges between the continents there would be no need for postulating the cyclic re-formation of super-continent.
- (b) One can pose many questions about the character of the expansion.
 - i. What was the duration of the expansion? Could the expansion have occurred in the time period 750-100 Myr (100 Myr corresponds to the age of dinosaurs with large body size made possible by the reduced gravitation and oxygenation of the atmosphere)? Duration would have been about 650 Myr in this case. Or did it begin already at the beginning of Neoproterozoic period [F15] when super-continent Rodinia began to break up? In this case the duration would be about 1 Myr. The estimate based on the quantum model of gravitational radiation predicts that the transition lasted for about 1.1 Gy so that the latter option would be more plausible in this framework.

- ii. Did the expansion accelerate as does also cosmic expansion in TGD based universal model for the expansion periods containing only the duration of the expansion period as a parameter [K73] and applying in all scales? It seems that accelerated expansion is the only sensible option since around 540 Myr the size of Earth should have been rather near to $R/2$ (perhaps so even at the period of Pangea around 250 My) unless one assumes that super-continent re-formed again.
- (c) One can also consider the possibility that the continents indeed broke up and reformed again during Cambrian era. One should however have a good physical reason for why this happened. Something must have connected the pieces together and created correlations. Gravitational magnetic flux tubes and phase transitions increasing and reducing Planck constant? Or could it be that the bridges connecting the continents acted like strings inducing oscillation of the distance between continents so that Pangea was surrounded by a large ocean?
- (d) The formation of the rift [F24] feeding magma from core to the surface would be due to the expansion leading to the formation of fractures. The induced local elevations would be like mountains. As in zipper-rift model ice could have covered these plateaus because the temperature was lower. This is not however essential for TGD based model of glaciations.
- (e) TGD based variant of Expanding Earth allows subduction but its role could have been small before the Pangeia period if the expansion was accelerating and led only to a relatively small increase of the radius before the Mesozoic period [F13] and continued with an accelerating rate during Mesozoic from 250 Myr to 65 Myr. It is interesting that Mesozoic period begins with the most intense known extinction of history- so called Permian-Triassic extinction event [I4] - known as Great Dying. About 95 of marine species and 70 percent of terrestrial species became extinct. Maybe genetically determined bio-rhythms could not follow the rapidly changing circadian rhythm. Another explanation for the extinction is the warming of the climate. For this there is indeed support: there is evidence that Antarctica was climate refuge during the extinction [I5] . Perhaps both factors were involved and were not independent of each other since rapid expansion might have generated massive methane leakages from underground seas and lakes.

TGD based view about evolution of oceans

Continents would have covered most of the area during $R/2$ era and the covered fraction was slightly smaller than $1/4$ of the recent area of Earth. This depends on the area taken by inland seas and polar caps. Nowadays the area covered by continents and inland seas is about 31 per cent so that continental area has increased and would be due to the expansion in vertical direction and deepening of the oceans. The area covered by oceans has increased from a small value to about 70 per cent. Only a small fraction of ocean floor would be subducted in Expanding Earth model. The Proto-Atlantic would have been only a small inland sea. Panthalassic Ocean was inland sea, which expanded to Pacific Ocean during expansion. Pacific Ocean could contain data about ancient ice ages if it was frozen. It however seems that data are consistent with the absence of global glaciation.

Model for glaciations

In TGD framework single super continent covering most of Earth becomes the counterpart of Rodinia [F26] . The hypothetical oceans are replaced with inland seas and polar caps. The super-continent covering most of Earth absorbs less solar heat than tropical oceans so that glaciations become more probable. Snowball Earth is replaced with a series of ordinary glaciations proceeding from poles since the places at Equator were near North Pole. There is no need for the glaciations to progress to the equator. The rifting for the counterpart of Rodinia is consistent with the formation of fractures due to the expansion of Earth. The reduction of gravitational binding energy due to the increase of the radius requires feed of energy and this could be one reason for the cooling and initiation of the glaciation.

There are several questions which must be answered if one wants to gain a more detailed understanding.

- (a) How does $R/2$ model modify the view about glaciations? Very probably there was a frozen polar cap. Snowball Earth could be replaced with ordinary glaciations proceeding from North and South Pole.
- (b) How does the predicted 3+3 hour diurnal cycle modify the ordinary picture? Certainly 3-hour day reduces the amplitude of the diurnal temperature variations. Could this period have left genetic traces to the mono-cellulars, say biological clocks with this period?
- (c) How does the predicted four times stronger surface gravity affect the glaciation process? Could strong gravity leave detectable signatures such as anomalously strong effects on the shape of surface of Earth or deeper signatures about the motion of ice.

There are also questions related to the energetics of the expansion.

- (a) The expansion required energy and could have induce glaciations in this manner. Energy conservation would hold for the total mechanical and gravitational energy of Earth given by

$$E = \frac{L^2}{2I} - k \frac{GM^2}{R} < 0 . \quad (10.7.1)$$

Here L is the conserved angular momentum of order $L \simeq I\omega$ and ω increases from $1/4\omega_{now}$ to ω_{now} during the expansion. The moment of inertia I is of order of magnitude $I \sim MR^2$ and k is a numerical constant not too far from unity. The kinetic energy is actually negligible as compared to the gravitational potential energy. The reduction of the gravitational binding energy requires a compensating energy, which could come both from Earth interior or from the Earth's surface. Both effects would induce a cooling possibly inducing glaciations.

- (b) One expects that in the initial stages of the expansion there was just an expansion. This meant stretching requiring also energy. The formation of rifts leading to the formation of oceans as magma flowed out would have started already in the beginning of Proterozoic period. Eventually fractures were formed and in TGD framework one might expect that the distribution of fractures could have been fractal. A considerable fraction of fractures was probably volcanoes so that CO_2 begun to leak to the atmosphere and local 'oasis' were formed. Also hot springs liberating heat energy from Earth crust could have been formed as in Island. The pockets inside Earth increased in size and were filled with water. Life started to escaped to the walls of the fractures and to the water pockets. Also the recent oceans can be seen as widened cracks which transformed to the expanding sea floors whereas continents did not expand. As the continental crust ceased to expand no heat was needed for the expansion and this together with increased CO_2 content of atmosphere would explain why there was no further glaciations and heating of the Earth. At this period the flow of the magma from Earth core provided the energy needed to compensate the reduction of gravitational energy.
- (c) It must be emphasized that TGD variant of Expanding Earth theory is not in conflict with tectonic plate theory. It explains the formation of tectonic plates and the formation of magma flow from rifts giving also rise to subduction and is therefore a natural extension of the tectonic plate theory to times before the expansion ceased.

Estimate for the duration of the transition changing gravitational Planck constant

The reader without background in quantum physics and TGD can skip this section developing an estimate for the duration of the transition changing Planck constant and inducing the scaling of the radius of Earth by a factor two. The estimate is about 1.1 Gy. It must be emphasized that the estimate is not first principle calculation and relies strongly on quantum classical correspondence.

The duration of the quantum transition inducing the expansion of the gravitational space-time sheet of Earth and thus of Earth itself by a factor two can be estimated by using the same general formula as used to estimate the power of gravitational radiation emitted in a transition in which gravitational Planck constant assignable to star-planet system is reduced [K61] .

- (a) The value of gravitational Planck constant characterizing the gravitational field body of Earth is GM^2/v_0 , where the velocity parameter $v_0 < 1$ ($c = 1$) is expected to be larger than $v_0 \simeq 2^{-11}$ characterizing Sun-Earth system.
- (b) Assuming a constant mass density for Earth the gravitational potential energy of Earth is given by

$$V = \frac{M}{2}\omega^2 r^2, \quad \omega = \sqrt{\frac{6GM}{R^3}}. \quad (10.7.2)$$

As far as radial oscillations are considered, the system is mathematically equivalent with a harmonic oscillator with mass M . The energies for the radial oscillations are quantized as $E = (n + 1/2)\hbar_{gr}\omega$.

- (c) The radii of Bohr quantized orbits for the harmonic oscillator scale like $\sqrt{\hbar}$ so that $\hbar \rightarrow 4\hbar$ is needed to obtain $R \rightarrow 2R$ rather than $\hbar \rightarrow 2\hbar$ as the naive Compton length argument would suggest. This requires the scaling $v_0 \rightarrow v_0/4$. The change of the ground state energy in this quantum transition is

$$\begin{aligned} \Delta E &= \frac{1}{2}(\hbar_{gr,f}\omega_f - \hbar_{gr,i}\omega_i), \\ \hbar_{gr,f} &= 4\hbar_{gr,i} = \frac{4GMm}{v_{0,i}}, \\ \omega_i &= 2^{3/2}\omega_f = 2^{3/2}\sqrt{\frac{6GM}{R_f^3}}. \end{aligned} \quad (10.7.3)$$

$R_f = R$ denotes the recent radius of Earth.

- (d) From the estimate for the power of gravitational radiation in similar transition the estimate for the duration τ of the quantum transition is

$$\begin{aligned} \tau &= a(v_{0,i}v_{0,f})^{-k/2} \times \frac{(\hbar_{gr,i} + \hbar_{gr,f})}{2\Delta E}, \\ &= a2^{-k}v_{0,f}^{-k} \times \frac{1+r}{r\omega_f - \omega_i}, \quad r = \frac{\hbar_f}{\hbar_i} = 4. \end{aligned} \quad (10.7.4)$$

The average of Planck constants associated with the initial and final states and geometric mean of the parameters $v_{0,i}$ and $v_{0,f}$ is dictated by time reversal invariance. The exponent k is chosen to be same as that obtained for from the condition that that the ratio of the power to the classical radiation power emitted in the transition between planetary Bohr orbits does not depend on v_0 (quantum classical correspondence). This gives $k = 5$. The condition that the power of gravitational radiation from Hulse-Taylor binary is same as the power predicted by the classical formula (quantum classical correspondence) gives $a = .75$.

- (e) The explicit expression for τ reads as

$$\begin{aligned} \tau &= K \times av_{0,f}^{-5} \times \left(\frac{R}{2GM}\right)^{1/2} \times \frac{R}{c}, \\ K &= \frac{5 \times 2^{-7} \times (2 + 2^{1/2})}{3^{1/2}}. \end{aligned} \quad (10.7.5)$$

- (f) The basic data are $M_{Sun} = 332900M$ (mass of Sun using Earth's mass as unit) and the mnemonic $r_{S,Sun} = 2GM_{Sun} = 2.95 \times 10^3$ m: together with $R = 6371 \times 10^3$ m these data allow a convenient estimation of $R/2GM$. For $k = 10$ and $a = .75$ this gives $\tau = 1.17$ Gyr. This is twice the estimate obtained by requiring that the transition begins at about 750 Myr (the beginning of Sturtian glaciation) and ends around 100 My (the age of gigantic animals whose evolution would be favored by the reduction of surface gravity). The estimate would suggest that the quantum transition began already around 1.1 Gyr, which in the accuracy used corresponds to the beginning of Neoproterozoic at 1 Gyr [F15]. The breaking of super-continent Rodinia indeed began already at this time.
- (g) Note that the value of v_{0f} for the gravitational field body of Earth as it is now would be $v_{0f} = 2^{-10}$ to be compared with $v_0 \simeq 2^{-11}$ for Sun-Earth gravitational field body.

Snowball Earth from TGD point of view

In TGD framework the main justification for Snowball Earth disappears since the samples believed to be from Equator would be from North pole and glaciation could be initiated from pole caps. Consider next in more detail the evidence for Snowball Earth from TGD point of view.

- (a) Low latitude glacial deposits, glacial sediments at tropical latitudes, tropical tillites, etc. providing support for snowball Earth [F27] would be near North pole of at Northern latitudes. Ordinary glaciations proceeding from poles would explain the findings [F9]. If total glaciations were present, a rough scaling suggests that the evidence from them should be found from southern latitudes around 45 degrees in the standard model framework.

The testable prediction is that the evidence for glaciations in ice-ball Earth framework should be found only below Equator and near South Pole. This finding would be of course extremely weird and would strongly favor $R/2$ option. Interestingly, in Southern Brasil all indicators for glaciations are absent (see [F36] and references therein). This region belonged to Gondwana continent and there is evidence that its location was at middle latitudes at Southern Hemisphere.

- (b) Banded iron formations [F27] are regarded as evidence for Snowball Earth and occur at tropical levels (near North Pole in $R/2$ model). Iron dissolved in anoxic ocean would have become in a contact with photosynthetically produced oxygen and implied the formation of iron-oxide. The iron formation would have been produced at the tipping points of anoxic and oxygenated ocean. One can consider also an explanation in terms of deep inland seas, which become stagnant and anoxic near the sea floor.

In TGD framework sea floor near North Pole could contain banded iron formations. This would explain also why the banded iron formations are rather rare. The oxygen could have come also from underground after the formation of cracks and led to the oxygenation of inland seas from bottom. The assumption that oxygenation took place already during the first glaciation, could explain why banded iron formations are absent during the second glaciation.

- (c) Calcium carbonate deposits [F27] have ^{13}C signature (per cent for the depletion of ^{13}C isotope and large for organic material) is consistent with that for mantle meaning abiotic origin. The explanation of Calcium carbonate deposits in TGD framework could be the same as in Snowball Earth model. Atmospheric CO_2 could come from the volcanoes and react with the silicates during the ice-free periods to form calcium carbonate which then formed the deposits. CO_2 could have also biological origin and come from the underground life at the walls of the expanding fractures/volcanoes or in underground seas or lakes. In this case also methane is expected. This option would predict ^{13}C signature characteristic for organic matter. Also this kind of signatures have been observed and support ordinary glaciations. Also rapid fluctuations of the signature from positive to negative take place and might have signatures of temporary melting induced organic contribution to the calcium carbonate.
- (d) Iridium anomaly [F27] is located at the base of Calcium Carbonate deposits. In Snowball Earth model Iridium deposits derive from the Iridium of cosmic rays arriving at the frozen

ice surface. As the ice melts, Iridium deposits are formed. In $R/2$ model the condensation of Iridium would proceed through the same mechanism. The possible problem is whether the time is long enough for the development of noticeable deposits. Near poles (Equator and South pole in standard model) this could be the case.

10.7.6 Paleo-magnetic data and Expanding Earth model

Paleomagnetic data from pre-Cambrian period might allow to test $R/2$ hypothesis. This data could in principle help to trace out the time development $R(t)$ from $R/2$ to R if the non-dipole contribution to magnetic field depends on $R(t)$.

About paleo-magnetism

Paleomagnetism [F19] provides quantitative methods to determine the latitude at which the sample of sedimentary rock was originally. Magnetic longitude cannot be determined because of rotational symmetry so that other information sources must be used. There are several methods allowing to deduce the direction and also the magnitude of the local magnetic field and from this the position of the sample during the time the sample was formed.

- (a) Below the Curie point thermal remanent magnetization is preserved in basalts of the ocean crust and not affected by the later magnetic fields unless they are too strong. This allows to deduced detail maps from continental drifting and polar wander maps after 250 Myr (Pangea period). During pre-Cambrian period the ocean floors of hypothetical oceans would have disappeared by subduction. In $R/2$ model there are no oceans: only inland seas.
- (b) In the second process magnetic grains in sediments may align with the magnetic field during or soon after deposition; this is known as detrital remnant magnetization (DRM). If the magnetization is acquired as the grains are deposited, the result is a depositional detrital remnant magnetization (dDRM); if it is acquired soon after deposition, it is a post-depositional detrital remnant magnetization (pDRM).
- (c) In the third process magnetic grains may be deposited from a circulating solution, or be formed during chemical reactions, and may record the direction of the magnetic field at the time of mineral formation. The field is said to be recorded by chemical remnant magnetization (CRM). The mineral recording the field commonly is hematite, another iron oxide. Red-beds, clastic sedimentary rocks (such as sandstones) that are red primarily because of hematite formation during or after sedimentary diagenesis, may have useful CRM signatures, and magnetostratigraphy [F12] can be based on such signatures. Snowball model predicts that nothing came to the bottoms of big oceans! How can we know that they existed at all!

During pre-Cambrian era the application of paleomagnetic methods [F19] is much more difficult.

- (a) Reliable paleomagnetic data range up to 250 My, the period of Pangea, and magnetization direction serves as a reliable information carrier allowing detailed polar wander maps. During pre-Cambrian era one cannot use polar wander maps and the polarity of the magnetic field is unknown. Therefore theoretical assumptions are needed including hypothetical super-continent, hypothetical oceans, and continental drift and plate tectonics. All this is on shaky grounds since no direct information about super-continent and ancient oceans exists. $R/2$ model suggests that continental drift and plate tectonics have not been significant factors before the expansion period when only inland seas and polar ice caps were present. Measurements have been however carried out about magnetization for pre-Cambrian sediments at continents recently and gives information about the strength of the magnetic field [F11] : the overall magnitude of the magnetic field is same as nowadays.
- (b) At Precambrian period the orientation of iron rich materials can serve as a record. The original records can be destroyed by various mechanisms (diagenesis). Also the orientations of the sediments can change in geological time scales.

- (c) Tens of thousands of reversals of the magnetic polarity [F6] have occurred during Earth's history. There have been long periods of stability and periods with a high frequency of reversals. The average duration of glaciation is around one Myr. The determination of the polarity of B possible by using samples from different points.
- (d) Mountain building orogeny [F18] releases hot water as a byproduct. This water can circulate in rocks thousands of kilometers and can reset the magnetic signature. The formation of fractures during the expansion of Earth could have released hot water having the same effect.

Could paleomagnetic data kill or prove $R/2$ model?

The first question is how one might kill $R/2$ model using data from pre-Cambrian era. Paleomagnetic data could do the job.

- (a) Remanent magnetization is proportional to the value of magnetic field causing it in weak magnetic fields. Therefore the magnetization in principle gives information about the magnetic fields that prevailed in early times.
- (b) Suppose that the currents generating the magnetic field can be idealized to conserved surface currents K around cylindrical surfaces of radius r and height h scaled down to $r/2$ and $h/2$ and that the value of K is not affected in the process. With this assumptions the magnetic moment behaves $\mu \sim Ir^2h \rightarrow \mu/8$. A continuous current vortices with $j = k/\rho$, which is ir-rotational outside the symmetry axis, produce a similar result if the radius of the vortices scales as $r \rightarrow r/2$. Since dipole magnetic field scales as $1/r^3$ and is scaled up by a factor 8 in $R \rightarrow R/2$, the scalings compensate and the dipole magnetic fields at surface do not allow to distinguish between the two options. Non-dipole contributions might allow to make the distinction.
- (c) The group led by Lauri J. Pesonen in Helsinki University [F11] has studied paleomagnetic fields at pre-Cambrian era. The summary of results is a curve at the home page of the group and shows that the scale of the magnetic during pre-Cambrian era is same as nowadays. On the other hand, the recent thesis by Johanna Salminen- one of the group members- reports abnormally high values of magnetization in Pre-Cambrian intrusions and impact structures in both Fennoscandia and South Africa [F41]. No explanation for these values has been found but it is probably not the large value of primary magnetization.

Another manner to do test the $R/2$ model is by comparing the signs of the magnetizations at magnetic equator and poles. They should be of opposite sign for dipole field. The polarity of magnetic field varies and there are no pre-Cambrian polar wander maps. One can deduce from the condition $B_r/rB_\theta = 2\cot(\theta)$ holding true for dipole field the azimuthal distance $\Delta\theta$ along the direction of the measured magnetic field to the pole along geodesic circle in the direction of the tangential component of B . One cannot however tell the sign of $\Delta\theta$, in other words whether a given pre-Cambrian sample belongs to Northern or Southern magnetic hemisphere. There are however statistical methods allowing to estimate the actual pole position using samples from several positions (for an excellent summary see [F41]).

For instance, if the magnetic field is in North-South direction during Rodinian period [F26], standard model would predict that the sign at the Equator is opposite to that at South Pole. In $R/2$ model the sample would be actually near North Pole and polarizations would have same sign. The sign of magnetization at apparent southern latitude around 45 degrees would have been opposite to that at South pole which is in conflict with dipole field character. Maybe the global study of magnetization directions when magnetic field was approximately in North-South direction could allow to find which option is correct. Also the dependence of the strength of the magnetic field as function of θ could reveal whether $R/2$ model works or not. The testing requires precise dating and position determination of the samples and a detailed model for the TGD counterpart of Rodinia and its construction requires a specialist.

If the expansion continued after 250 Myr with an accelerating rate and Earth radius was still considerably below its recent value, the comparison of pole wandering charts deduced from ocean

floor paleomagnetic data at faraway locations might allow to show that the hypothesis about dipole field is not globally consistent for R option. Even information about the time evolution of the radius could be deduced from the requirement of global consistency.

10.7.7 Did life go underground during pre-Cambrian glaciations?

The basic idea of Expanding Earth model is that the life developed in underground seas and emerged to the surface of Earth in Cambrian explosion. The series of pre-Cambrian glaciations explains why the life escaped underground and how the underground seas were formed.

- (a) If one believes that the reduction of gravitational binding energy was responsible the cooling, then the expansion of Earth could have begun at the same time as Sturtian glaciation [F3]. On the other hand, the TGD estimate for the duration of the expansion period giving 1.1 Gyr, suggests that the breakup of the Rodinia, which began in the beginning of Proterozoic period corresponds to the beginning of the expansion. The simplest assumption is that the radius of R at the beginning of Cambrian period was not yet much larger than $R/2$ and continued to increase during Cambrian period and ended up around 100 My, when dinosaurs and other big animals had emerged (possibly as a response to the reduction of gravity). This means that there were land bridges connecting the separate continents.
- (b) One must explain the scarcity of fossils during pre-Cambrian era. If the more primitive life forms at the surface of Earth did not have hard cells and left no fossils one can understand the absence of highly evolved fossils before Cambrian explosion [I1]. If life-forms emerged cracks and underground seas there would be no fossils at the surface of Earth. In the case of volcanoes dead organisms would have ended to gone to the bottom of the water containing volcano and burned away.
- (c) The expansion had formed the underground pockets and fractures made possible for the water to flow from the surface to the pockets. Life would have evolved in fractures and pockets. The first multicellular fossils appeared during Ediacaran period (segmented worms, fronds, disks, or immobile bags) [F4] and have little resemblance to recent life forms and their relationship with Cambrian life forms is also unclear. Ediacaran life forms could have migrated from the fractures and Cambrian fossils from from the underground seas and lakes. The highly evolved life-forms in Cambrian explosion could have emerged from underground seas through fractures.

One can make also questions about the underground life.

- (a) The obvious question concerns the sources of metabolic energy in underground seas. In absence of solar radiation photosynthesis was not possible plants were absent. The lowest levels in the metabolic hierarchy would have received their metabolic energy from the thermal or chemical energy of Earth crust or from volcanoes. The basic distinction between plants and animals might be that the primitive forms of plants developed at the surface of Earth and those of animals in underground seas.
- (b) At first it seems strange that the Cambrian life-forms had eyes although there was no solar radiation in the underground seas. This is actually not a problem. These life-forms had excellent reasons for possessing eyes and in absence of sun-light the life forms had to invent lamp. Indeed, many life forms in deep sea and sea trenches produce their own light [I3]. It would be interesting to try to identify from Cambrian fossils the body parts which could have served as the light source.

10.8 About the anomalies of the cosmic microwave background

Depending on one's attitudes, the anomalies of the fluctuation spectrum of the cosmic microwave background (CMB) can be seen as a challenge for people analyzing the experiments or that of

the inflationary scenario. I do not pretend to be deeply involved with CMB. What interests me is whether the replacement of inflation with quantum criticality and \hbar changing phase transitions could provide fresh insights about fluctuations and the anomalies of CMB. In the following I try first to explain to myself what the anomalies are and after that I will consider some TGD inspired crazy (as always) ideas. My motivations for commuting these ideas are indeed strong: the consideration of the anomalies led to a generalization of the notion of conformal QFT to what might be called symplectic QFT having very natural place also in quantum TGD proper.

10.8.1 Background

Consider first some background.

- (a) The fluctuations of CMB reflect directly the fluctuations of energy density (acoustic waves) responsible for the formation of various structures: this follows from the proportionality $\rho \propto T^4$: one has $\Delta T/T \propto \Delta\rho/\rho \propto \Phi$, Φ is gravitational potential created by the density fluctuations. The spectrum reflects the situation as thermal photons decoupled from matter and the matter became transparent to photons. The radiation comes from the sphere of last scattering S^2 , which corresponds to the setting on of transparency and only Thomson scattering can affect the radiation after that time. For short angular distances the 2-point correlation functions at S^2 for the fluctuations are suppressed: this is due to a rapid increase of photon free path during the transition making possible exponential damping of the fluctuations of energy density for angular separation $\theta < 1$ degree at which the amplitude is maximum. Quite generally, at the maxima of correlation function the photons almost decouple from the acoustic fluctuations.
- (b) The analysis of fluctuation spectrum of CMB in general relativistic context requires a solution of Einstein's equations for small perturbations of Robertson Walker metric in presence of matter. It is convenient to decompose the perturbation of the metric Robertson-Walker coordinates using representations of rotation group [E44]. The perturbation of g_{tt} is scalar, the perturbation of g_{ti} decomposes to a gradient of a scalar and rotor of a vector, and the perturbation of g_{ij} corresponds to a scaling of the 3-metric represented by a scalar, double gradient of scalar, and genuinely tensorial part corresponding to classical gravitational radiation. From the four scalar modes two can be eliminated as mere coordinate changes without actual physical content. It is believed that only the scalar perturbations and tensor perturbation are significant. For the WMAP data only scalar perturbations matter.
- (c) Scalar fluctuations can be divided to two classes. For adiabatic fluctuations the fluctuation of the energy density for a given particle species is proportional to the energy density associated with the species with a common constant of proportionality. When curvature scalar vanishes these fluctuations do not affect the curvature scalar. Inflationary scenario predicts adiabaticity. For iso-curvature fluctuations the sum of the fluctuations associated with different particles vanishes: cosmic strings predict this kind of spectrum. The detailed spectrum of the peaks for 2-point correlation functions is consistent with adiabaticity and excludes cosmic strings in sense of GUTs.
- (d) The predictions of the inflationary scenario follow from the assumption that fluctuations correspond to primordial quantum fluctuations of inflaton field which expanded with an exponential rate to macroscopic fluctuations during the inflationary period. The spectrum of perturbations is assumed to be Gaussian and to obey approximate scale invariance [E11]. Gaussianity holds true in 3-D momentum space and states that correlation function for the fluctuations of the energy density is proportional to 3-D delta function in momentum space. In other words, the Fourier components of the density perturbation are statistically independent. The coefficient of delta function can depend on the magnitude of 3-momentum. For exact scale invariance it would be constant. This invariance is however broken and the multiplying function is a power k^{1-n_s} of the length of the wave vector, where n_s is so called spectral index. Spectral index has been deduced from WMAP data been measured and differs slightly from unity: $n_s = .960 \pm .0014$. Gaussian distribution contains as a free parameter the scale r of the perturbations and the observed amplitude $r = \Delta T/T \simeq 10^{-5}$ of fluctuations would reflect primordial initial conditions in energy scale about 10^{-3} times

Planck mass, which has interpretation as gauge unification scale in GUTs. I am not sure whether the theories can really predict the value of r .

10.8.2 Anomalies of CMB

There are several anomalies associated with CMB corresponding to the power spectrum of fluctuations and 2-point correlation function as a function of the angle difference θ between points of the sphere of last scattering. There is also some evidence for the failure of Gaussianity reflecting itself as a non-vanishing of 3-point correlation functions.

Consider first fluctuation spectrum, or formally 1-point correlation functions for what is essentially gravitational potential due to fluctuations in Newtonian gauge.

- (a) There is dipole term in the spectrum identifiable in terms of motion of the galaxy cluster containing Milky Way relative to the reference frame of the CMB. The cluster appears to be moving with velocity 627 ± 22 km/s in the direction of galactic longitude ($l = 264.4, b = 48.4$) degrees [?].
- (b) Hemispherical power asymmetry [E112] means that the amplitude of the fluctuations is not same at the opposite sides of the galactic plane (rather near to ecliptic plane): the difference in the amplitude is about 10 per cent. This does not mean that the mean value of temperature would differ at the opposite sides. The anomaly can be parameterized by a deviation of the amplitude from constant by an additive dipole term of amplitude .114 and in the direction (l,b) = (225,-27) degrees in galactic coordinates. Freeman suggest that the asymmetry can be eliminated for $l \leq 8$ by a slight modification of the CMB dipole [E127]. In the average sense this might hold true since dipole term has odd parity. The temperature fluctuations are also stronger in southern than northern galactic hemisphere and there is a peculiar cold spot at southern hemisphere. Dipole term cannot eliminate this kind of anomalies. One might hope that the elimination of the galactic foreground - when done properly - might eliminate this asymmetry. The subtraction of the contribution from the galactic plane affects in the first approximation only the even harmonics: this would affect the interference pattern between even and odd harmonics.
- (c) There is also an anomaly christened as axis of evil.
 - i) One can assign to the l :th contribution a unique axis maximizing angular momentum dispersion and these directions turn out to be very near to each other for $l = 2$ and $l = 3$ contributions [E96]. De Oliveiro Costa *et al* noticed that this anomaly could be understood if the Universe has a compact direction in this direction of size of order horizon radius. This explanation is ruled out by other tests, including the absence of matched circles. The modification of the contribution from galactic plane would affect the direction assignable to $l = 2$ harmonic but would not affect considerably $l = 3$ contribution. Hence this effect might be due a wrong subtraction.
 - ii) The contribution from the harmonics with angular momentum l can be characterized in terms of l unit vectors: what one does is essentially expression of the contribution as a product of the direction cosines between radial unit vector and l unit vectors [E103]. $l = 2$ harmonics defined two vectors of this kind and their cross product defines what is called an area vector. For $l = 3$ there are three vectors of this kind and one can define three area vectors. It turns out that the planes defined by $l = 2$ area vector and two $l = 3$ area vectors are very near to each other and nearly orthogonal to the plane of ecliptic (and thus also galactic plane). These vectors are in reasonable approximation in galactic plane and aligned with the direction of CMB dipole whereas the direction. The direction of the third $l = 3$ area vector deviates about 10 degrees from the normal of the galactic plane.

Again the smallness of $l = 2$ contribution raises the question whether the dipole correction and galactic foreground subtraction are done properly. Freeman and collaborators [E127] have proposed that a proper subtraction of CMB dipole might allow to get rid of this anomaly. According to [E104] this is probably not possible. In the case of $l = 3$ harmonics galactic subtraction affecting only even harmonics should not have any appreciable effect. The presence of cold spot near Galactic center and hot spot near Gum Nebula, both in

the galactic plane, could also relate to the fact that the area vector is aligned with galactic plane.

Consider next two-point correlation functions.

- (a) The function $C(\theta)$ is obtained by averaging the fluctuations for all pairs of points at the sphere of last scattering separated by angle θ . $C(\theta)$ with galactic cutoff vanishes for $\theta > 60$ degrees the correlation function vanishes in good approximation [E104]. There is also a strange finding [E101] suggesting a strong correlation between the fluctuation spectrum and 2-point correlation function. Large scale cutoff of $C(\theta)$ in the full-sky maps without galactic cutoff is absent while cut-sky maps with the galactic contribution masked are anomalous. The galactic cut is also almost equivalent with the masking of the cold and hot spot assignable to the galactic plane. Accepting the hot and cold spots in the galactic plane as real would give large scale correlations of 2-point correlation functions and vice versa. Also the subtraction of the anomalous quadrupole and octopole contributions from the 1-point correlation function brings back the large scale power. It is also essential that the multipole vectors of these contributions are nearly parallel. Hence it seems that one can choose between two evils: either the power cutoff at large scales or the axis of evil.
- (b) For low l harmonics statistical isotropy assumption fails [E104]. This means that the correlation functions $\langle a_{lm} a_{l_1, -m_1} \rangle$ in the expansion of ΔT in terms of spherical harmonics $Y_{l,m}$ taken over temporal ensemble are not of form $C_l \delta_{l,l_1} \delta_{m,m_1}$, where C_l would define coefficients of $C(\theta)$ in terms of $P_l(\theta)$. Quadrupole terms ($l = 2$) are also anomalously small.

There are also other anomalous correlations.

- (a) Unexpectedly high correlation between temperature and E-mode polarization caused by Thomson scattering of CMB photons can be seen as an evidence for a large optical depth and very early star formation [E105].
- (b) Gaussianity predicts that three-point correlation functions for density fluctuations vanish. Hence also three-point correlation functions at the sphere of the last scattering should vanish. There is some evidence that this is not the case [E196]: the proposed deviation from Gaussianity is parameterized by writing the perturbation of the gravitational potential in the form $\Phi = \Phi_L + f_{NL}(\Phi_L^2 - \langle \Phi_L^2 \rangle)$.

10.8.3 What TGD could say about the anomalies?

TGD cosmology involves several new elements. Super-conformal invariance generalizes in TGD framework and one can wonder whether the fluctuations at the sphere of the last scattering could be described in terms of conformal field theory. It turns out that symplectic QFT based on the analogs of fusion rules is more natural in TGD framework. There are p-adic and dark matter hierarchies realized in terms of book like structure of imbedding space with levels labeled by Planck constant with gravitational Planck constant assignable to flux tubes mediating gravitational interactions and having gigantic values so that quantum coherence in cosmological scales is possible. Zero energy ontology implies that time like entanglement in cosmic time scales assignable to gravitational interaction is possible so that the notion of state function reduction in astrophysical and cosmic time scales might make sense. Hence one can wonder whether the strange correlations between local galactic and solar geometry and density fluctuations at surface of large scattering might be real after all.

Implications of p-adic and dark matter hierarchies

Consider next the possible implications of p-adic and dark matter hierarchies.

- (a) In TGD framework there are two hierarchies: hierarchy of p-adic space-time sheets and hierarchy of Planck constants. p-Adic length scales are defined as $L_p \propto \sqrt{p}$, where $p \simeq$

2^k is prime and k is positive integer. $L(151)$ corresponds in good approximation to 10 nm, cell membrane thickness. The hierarchy of Planck constants reflect the book like structure of the generalized imbedding space consisting of almost copies of $M^4 \times CP_2$ glued together like pages of book along common back. The proposed structure of imbedding space can be understood as a geometric correlate for the choice of quantization axes at the imbedding space level inducing it also at the level of configuration space (world of classical worlds). There are preferred quantization axes associated with both M^4 and CP_2 degrees of freedom. In the case of M^4 this means preferred plane M^2 defining a quantization axis of spin and in the case of CP_2 preferred homologically non-trivial geodesic sphere defining quantization axis of color isospin. This means breaking of symmetries at particular sector of the imbedding space but since the "world of classical worlds" is union over different choices of quantization axes, symmetries remain intact as a whole. It would seem that quantum measurement with new quantization axis means a tunneling from between this kind of sectors.

- (b) It is important to notice that in TGD Universe the fluctuations emerge during the quantum criticality at the time of decoupling rather than developing from primordial fluctuations as in the case of inflationary cosmology. This kind of periods would be quite general since the smooth cosmic expansion is in TGD Universe replaced by a sequence of quantum leaps during which Planck constant for some relevant space-time sheet increases and implies the increase of the size L of the appropriate space-time sheet scaling like \hbar . The same mechanism explains also the accelerated cosmic expansion taking place much later during cosmic expansion and probably corresponding to expansion for large voids of size of order 10^8 ly.
- (c) In TGD Universe the vanishing of the curvature scalar of 3-space (flatness) corresponds to quantum criticality associated with phase transitions changing the value of Planck constant. Robertson-Walker form of the metric, criticality constraint, and imbeddability as a vacuum extremal to $M^4 \times S^2 \subset M^4 \times CP_2$ fix the critical cosmology highly uniquely. The critical cosmology has a finite temporal duration due to the failure of the global imbedding. During early phases the critical mass density behaves as $1/a^2$ which might be interpreted in terms of dominance of string like objects, which in TGD framework are identified as long magnetic flux tubes.

Can one say anything more quantitative about the situation? In particular, can one predict the scale (variance) of $\Delta T/T$?

- (a) There are two dimensionless numbers available: the value of the integer k characterizing p-adic length scale $L_p \propto 2^{k/2}$ characterizing the surface of the last scattering and the ratio \hbar/\hbar_0 of Planck constants associated with dark and visible sectors of the configuration space.
- (b) The value of the integer k characterizing p-adic length scale at the time of the transition can be estimated from the radius for the sphere of last scattering identified as radius $R = a(t)$. The transition to matter dominated Universe began in about 400, 000 years old universe. Coupling took about 120,000 years and was finished at the age of 500,000 years. From this one can estimate the p-adic length scale in question as light-cone proper time $a(t)/a_0 = (t/t_0)^{2/3}$ in matter dominated cosmology identifiable as curvature radius R in GRT based RW cosmology. My own estimate $a = 3 \times 10^7$ ly in [K73] gives $k \sim 355$.
- (c) Identifying $\Delta\rho_i$ for a given particle as the energy density $\rho_{i,d}$ of dark variant of the particle implies adiabaticity if one has $\rho_{i,d}/\rho_i = \text{constant}$. This is achieved by assuming that the energy densities scale like ρ_{tot} , that is one has $\rho_{d,i} = (\hbar/\hbar_0)^{-n} \rho_i \propto (\hbar/\hbar_0)^{-n} a^{-n}$. $n = 2$ is suggested by the early critical cosmology discussed [K73]. This would give $\Delta\rho_i/\rho_i = (\hbar_0/\hbar)^2$. From $\Delta T/T \simeq 10^{-5}$ one would have $r = \hbar/\hbar_0 \sim 300$. The estimate for r is not too far from $k \sim 355$, which might mean that $r = k$ holds true implying that the r would increase logarithmically with the p-adic length scale of the space-time sheet.

Consider next the anomalies from phenomenological point of view.

- (a) One cannot exclude the possibility that the vanishing of the two-point correlation functions for $\theta > 60$ degrees reflects the finite size of the space-time sheets. In conformal field theory

approach this would mean that conformal field theory applies only inside patches at the sphere of last scattering. Suppose that the size of space-time sheets is typically of order p -adic length scale $L_p \propto \sqrt{p}$, where $p \simeq 2^k$ is prime and k is positive integer. For the surface of last scattering $L_p \equiv L(k)$ could be identified as the radius of the sphere and can be estimated from the value of light-cone proper time a at that time.

The first guess is that only the points of the sphere for which distance is shorter than $L(k)$ can correlate. Simple elementary geometry shows that this is the case only for $\theta < 60$ degrees! The reduction of the vanishing correlation to almost kinematics must of course be taken with a big grain of salt: if the diameter of the sphere is taken to be L_p , one would have $\theta < 180$ degrees.

The killer prediction is that the non-averaged correlation function for two fixed points of sphere obtained by averaging the fluctuations over ensemble of observations should vanish for smaller values of angular distances when points belong to different patches so that the boundaries of patches should be identifiable from CMB map.

- (b) As already noticed, the presence of galactic cold and hot spots and axis of evil seem to be the price to be paid for the presence of large scale power [E101]. The finite size of the space-time sheets forcing the vanishing of 2-point correlation function for large angular separations could thus conform with the non-CMB explanation of galactic cold and hot spots and allow to get rid of axis of evil. The pair of cold and hot spots indeed gives a large negative contribution to $C(\theta)$. The finite size of space-time sheets could also explain the hemispherical asymmetry and why fluctuations are stronger at the southern galactic hemisphere.
- (c) The particles at different pages of the "Big Book" can tunnel between the pages so that the presence of dark space-time sheets could affect the spectrum of temperature fluctuations. If dark matter is responsible for the fluctuations, the tunneling of dark photons to visible space-time sheets and vice versa might have something to do with the fluctuations of CMB spectrum. Fractality suggests that dark space-time sheets could induce a modulation of the amplitudes of CMB proposed to explain the hemispherical asymmetries but not why the hemispheres correspond to Northern and Southern galactic spheres. There would be kind of modulation hierarchy. This might relate to the fluctuations in the amplitude of ΔT , and the related small 10 percent deviation of the fluctuation amplitudes at Northern and Southern hemisphere.

A couple of warnings are in order.

- (a) The proposed mechanism does not explain the strange correlations of CMB with the local geometry. If one accepts quantum coherence in cosmic length scales predicted by the dark matter hierarchy, the choice of quantization axis in cosmic scale having direct geometric correlate in TGD Universe, could explain the asymmetries as a result of state function reduction in cosmic scale.
- (b) The decomposition into disjoint space-time sheets is not the only manner to explain the anomalies. It will be found that the approach based on symplectic QFT predicts with very general assumptions about 2-point functions hemispherical asymmetry. Symplectic approach might be also able explain the vanishing of $C(\theta)$ in large scales.

Perturbations of the critical cosmology: the naive approach

Although the naive formal application of perturbation theory around critical cosmology does not make sense in quantum TGD framework, one can start by looking what it would give at classical level.

- (a) Concerning the perturbations of the critical cosmology, a natural condition would be that only vacuum extremals of Kähler action are allowed. This means that only perturbations giving rise to 4-surfaces belonging to $M^4 \times Y^2 \subset M^4 \times CP_2$, Y^2 Lagrangian sub-manifold of CP_2 , are allowed. If all small deformations of the critical cosmology are allowed, curvature scalar cannot vanish in general. In this framework the notion of adiabaticity involving

statements about various particles does not have any obvious meaning whereas the notion of iso-curvature fluctuations can be formulated. The vanishing of the curvature scalar makes sense for the perturbations of RW metric representing vacuum extremals but would break the symplectic symmetry in CP_2 degrees of freedom. Note also that many-sheeted space-time and the generalization of imbedding space induced by hierarchy of Planck constants are quite essential piece of TGD vision and are not taken into account in this naive approach.

- (b) One can express the perturbations of the metric in terms of gradients of CP_2 coordinates and since for the unperturbed RW metric CP_2 coordinates depend on light-cone proper time only, the perturbations are gradients of CP_2 coordinates with respect to spatial coordinates so that a reduction to scalar perturbations modifying only g_{aa} and vector perturbations implying non-vanishing g_{ai} indeed takes place in the first order. Since g_{ij} remains invariant in the first order, also 3-space remains flat in this order. In second order also other modes become possible.
- (c) The absence of other than scalar modes in the first order means that classical gravitons are absent in this order. Does this mean that also quantal gravitons are not present in the first order so that the B mode polarization would be smaller than expected? Probably not: the basic reason for developing the vision about physics as the geometry of the world of classical worlds was the total failure of the perturbative path integral approach theory in TGD framework. Previous considerations also force to ask whether the phase transitions of dark gravitons to ordinary gravitons could be an essential element of detection of gravitons and mean that dark graviton with very large energy as compared to the wavelength transforms to a bunch of ordinary gravitons. This might lead to the erratic elimination of the graviton signal as a noise. One can also consider the possibility that dark gravitons with very long wave lengths transform to ordinary gravitons with much shorter wavelengths.

Could super-conformal field theory at sphere of last scattering describe the fluctuations?

I have already earlier [K73] proposed that CMB spectrum might be understood in terms of conformal field theory. If some variant of conformal field theory works, the general prediction is the breaking of conformal invariance meaning the appearance of the counterpart of the spectral index from the breaking of conformal symmetry by the generation of central extension to super-conformal algebra. In this framework $1 - n_s$ corresponds to an anomalous dimension having a discrete spectrum in conformal theories and known once the representation of Super Virasoro algebra is known. It would not be surprising if n_s would depend on the value of \hbar , which defines a quantum phase q playing also a key role in conformal field theories. Second important prediction would be that 3-point correlation functions are predictable and non-vanishing unless the conformal field theory in question is not free. This would allow the possibility of non-Gaussian behavior.

It however seems that CQFT need not be quite correct idea. Rather, a symplectic variant of conformal field theory is natural in TGD framework and could be used to characterize the ground state in terms of n-points functions. The basic objection against the use of conformal field theory is that it should apply to the construction of physical states pairs of positive and negative energy states and considering thus non-vacuum fluctuations of space-time surfaces around vacuum extremals. Now one is considering vacuum states with respect to Noether charges expressed as functionals in the space of vacuum extremals. Since symplectic transformations are symmetries of the vacuum extremals, a symplectic analogy of conformal field theory might be a more appropriate approach. In the following this argument is made more precise.

- (a) One must consider small perturbations of the critical cosmology which are also vacuum extremals. This means that the perturbations correspond to surface $X^4 \subset M^4 \times Y^2$, where Y^2 corresponds to Lagrangian sub-manifold of CP_2 having vanishing induced Kähler form. If one poses no other conditions the vacuum extremals possess symplectic transformations of CP_2 leaving given Y^2 invariant as symmetries. These transformations relate closely to so called super-symplectic symmetries which are basic super-conformal symmetries of quantum TGD besides Kac-Moody type symmetries assignable to light-like 3-surfaces identified as

basic dynamical objects. Also symplectic (or rather contact-) transformations of $r_M = \text{constant}$ sphere of light-cone boundary act as this kind of symmetries which raises the question whether the analog of conformal field theory based having the symplectic group of light-cone boundary as symmetries might be a proper manner to characterize the vacuum degeneracy in quantum TGD.

- (b) Could conformal field theory possessing these symmetries defined at the sphere of last scattering (S^2) or - as suggested by basic structure of quantum TGD - at the boundary of 3-D light-cone connecting S^2 to the observer's position - describe the quantum criticality? The hope raised by the fact that critical cosmology is fixed the by the criticality condition without any reference to matter is that the correlation functions could be deduced from universality without any reference to elementary particle physics .
- i) The naive guess would be that the deviations of CP_2 complex coordinates ξ^k from their values at S^2 should be taken as primary dynamical variables. Unfortunately, the assumption that ξ^k are holomorphic functions of the complex coordinate of the sphere of last scattering would not be consistent with the vacuum extremal property. The use of CP_2 coordinates as dynamical variables is not consistent with general coordinate invariance unless one chooses some special coordinates. This is possible since selection of preferred quantization axis selects preferred complex coordinates unique modulo $U(2) \subset SU(3)$ rotations represented linearly. The simplest manner to achieve general coordinate invariance is by using the gravitational potential defined as the perturbation $\Delta g_{aa} = \Delta(s_{ki} \partial_a \xi^k \partial_a \bar{\xi}^l)$. All perturbations of R-W metric can be arranged to the representation of rotation group corresponding to two scalars, vector, and traceless tensor. Unfortunately, the deviations of metric do not however define conformal fields in S^2 . They could however define symplectic fields. It seems that conformal field theory approach requires the expression of Δg_{aa} in terms of primary conformal fields, say various currents, and this looks too complicated.
- iii) The radial light-like coordinate r_M for the light-cone boundary plays a role analogous to that of complex coordinate for Kac-Moody representations at like 3-surfaces and for super-symplectic representations at light-cone boundary. In this case all vacuum extremals are allowed and the symplectic transformations of $S^2 \times CP_2$ localized with respect to r_M would act as analogos of conformal symmetries. In quantum TGD proper this could quite well make sense but in the recent situation only a QFT at S^2 is needed and light-like conformal invariance does not seem to say anything about the behavior of the correlation functions of temperature fluctuations at S^2 .

Could a symplectic analog of conformal field theory work?

Symplectic symmetries of $\delta M_+^4 \times CP_2$ (light-cone boundary briefly) inspire the question whether a symplectic analog of conformal field theory at S^2 could dictate the correlation functions. Therefore it makes sense to play with the idea what symplectic QFT could look like and what one could conclude about the predictions of 'symplectic QFT' in the recent situation.

- (a) In quantum TGD the symplectic transformation of the light-cone boundary would induce action in the "world of classical worlds" (light-like 3-surfaces). In the recent situation it is convenient to regard perturbations of CP_2 coordinates as fields at the sphere of last scattering (call it S^2) so that symplectic transformations of CP_2 would act in the field space whereas those of S^2 would act in the coordinate space just like conformal transformations. The deformation of the metric would be a symplectic field in S^2 . The symplectic dimension would be induced by the tensor properties of R-W metric in R-W coordinates: every S^2 coordinate index would correspond to one unit of symplectic dimension. The symplectic invariance in CP_2 degrees of freedom is guaranteed if the integration measure over the vacuum deformations is symplectic invariant. This symmetry does not play any role in the sequel.
- (b) For a symplectic scalar field $n \geq 3$ -point functions with a vanishing anomalous dimension would be functions of the symplectic invariants defined by the areas of geodesic polygons defined by subsets of the arguments as points of S^2 . Since n-polygon can be constructed

from 3-polygons these invariants can be expressed as sums of the areas of 3-polygons expressible in terms of symplectic form. n -point functions would be constant if arguments are along geodesic circle since the areas of all sub-polygons would vanish in this case. The decomposition of n -polygon to 3-polygons brings in mind the decomposition of the n -point function of conformal field theory to products of 2-point functions by using the fusion algebra of conformal fields (very symbolically $\Phi_k \Phi_l = c_{kl}^m \Phi_m$). This intuition seems to be correct.

- (c) Fusion rules stating the associativity of the products of fields at different points should generalize. In the recent case it is natural to assume a non-local form of fusion rules given in the case of symplectic scalars by the equation

$$\Phi_k(s_1) \Phi_l(s_2) = \int c_{kl}^m f(A(s_1, s_2, s_3)) \Phi_m(s) d\mu_s . \quad (10.8.1)$$

Here the coefficients c_{kl}^m are constants and $A(s_1, s_2, s_3)$ is the area of the geodesic triangle of S^2 defined by the symplectic measure and integration is over S^2 with symplectically invariant measure $d\mu_s$ defined by symplectic form of S^2 . Fusion rules pose powerful conditions on n -point functions and one can hope that the coefficients are fixed completely.

- (d) The application of fusion rules gives at the last step an expectation value of 1-point function of the product of the fields involves unit operator term $\int c_{kl} f(A(s_1, s_2, s)) I d\mu_s$ so that one has

$$\langle \Phi_k(s_1) \Phi_l(s_2) \rangle = \int c_{kl} f(A(s_1, s_2, s)) d\mu_s . \quad (10.8.2)$$

Hence 2-point function is average of a 3-point function over the third argument. The absence of non-trivial symplectic invariants for 1-point function means that $n = 1$ - an are constant, most naturally vanishing, unless some kind of spontaneous symmetry breaking occurs. Since the function $f(A(s_1, s_2, s_3))$ is arbitrary, 2-point correlation function can have both signs. 2-point correlation function is invariant under rotations and reflections.

CMB data suggest breaking of rotational and reflection symmetries. A possible mechanism of spontaneous symmetry breaking is based on the observation that in TGD framework the hierarchy of Planck constants assigns to each sector of the generalized imbedding space a preferred quantization axes. The selection of the quantization axis is coded also to the geometry of "world of classical worlds", and to the quantum fluctuations of the metric in particular. Clearly, symplectic QFT with spontaneous symmetry breaking would provide the sought-for really deep reason for the quantization of Planck constant in the proposed manner.

- (a) The coding of angular momentum quantization axis to the generalized imbedding space geometry allows to select South and North poles as preferred points of S^2 . To the three arguments s_1, s_2, s_3 of the 3-point function one can assign two squares with the added point being either North or South pole. The difference

$$\Delta A(s_1, s_2, s_3) \equiv A(s_1, s_2, s_3, N) - A(s_1, s_2, s_3, S) \quad (10.8.3)$$

of the corresponding areas defines a simple symplectic invariant breaking the reflection symmetry with respect to the equatorial plane. Note that ΔA vanishes if arguments lie along a geodesic line or if any two arguments co-incide. Quite generally, symplectic QFT differs from conformal QFT in that correlation functions do not possess singularities.

- (b) The reduction to 2-point correlation function gives a consistency conditions on the 3-point functions

$$\begin{aligned} \langle (\Phi_k(s_1)\Phi_l(s_2))\Phi_m(s_3) \rangle &= c_{kl}^r \int f(\Delta A(s_1, s_2, s)) \langle \Phi_r(s)\Phi_m(s_3) \rangle d\mu_s \\ &= \end{aligned} \quad (10.8.4)$$

$$c_{kl}^r c_{rm} \int f(\Delta A(s_1, s_2, s)) f(\Delta A(s, s_3, t)) d\mu_s d\mu_t . \quad (10.8.5)$$

Associativity requires that this expression equals to $\langle \Phi_k(s_1)(\Phi_l(s_2)\Phi_m(s_3)) \rangle$ and this gives additional conditions. Associativity conditions apply to $f(\Delta A)$ and could fix it highly uniquely.

- (c) 2-point correlation function would be given by

$$\langle \Phi_k(s_1)\Phi_l(s_2) \rangle = c_{kl} \int f(\Delta A(s_1, s_2, s)) d\mu_s \quad (10.8.6)$$

- (d) There is a clear difference between $n > 3$ and $n = 3$ cases: for $n > 3$ also non-convex polygons are possible: this means that the interior angle associated with some vertices of the polygon is larger than π . $n = 4$ theory is certainly well-defined, but one can argue that so are also $n > 4$ theories and skeptic would argue that this leads to an inflation of theories. TGD however allows only finite number of preferred points and fusion rules could eliminate the hierarchy of theories.
- (e) To sum up, the general predictions are following. Quite generally, for $f(0) = 0$ n-point correlation functions vanish if any two arguments co-incide which conforms with the spectrum of temperature fluctuations. It also implies that symplectic QFT is free of the usual singularities. For symmetry breaking scenario 3-point functions and thus also 2-point functions vanish also if s_1 and s_2 are at equator. All these are testable predictions using ensemble of CMB spectra.

Since number theoretic braids are the basic objects of quantum TGD, one can hope that the n-point functions assignable to them could code the properties of ground states and that one could separate from n-point functions the parts which correspond to the symplectic degrees of freedom acting as symmetries of vacuum extremals and isometries of the 'world of classical worlds'.

- (a) This approach indeed seems to generalize also to quantum TGD proper and the n-point functions associated with partonic 2-surfaces can be decomposed in such a manner that one obtains coefficients which are symplectic invariants associated with both S^2 and CP_2 Kähler form.
- (b) Fusion rules imply that the gauge fluxes of respective Kähler forms over geodesic triangles associated with the S^2 and CP_2 projections of the arguments of 3-point function serve basic building blocks of the correlation functions. The North and South poles of S^2 and three poles of CP_2 can be used to construct symmetry breaking n-point functions as symplectic invariants. Non-trivial 1-point functions vanish also now.
- (c) The important implication is that n-point functions vanish when some of the arguments co-incide. This might play a crucial role in taming of the singularities: the basic general prediction of TGD is that standard singularities should be absent and this mechanism might realize this expectation.

Next some more technical but elementary first guesses about what might be involved.

- (a) It is natural to introduce the moduli space for n-tuples of points of the symplectic manifold as the space of symplectic equivalence classes of n-tuples. In the case of sphere S^2 convex n-polygon allows $n + 1$ 3-sub-polygons and the areas of these provide symplectically invariant coordinates for the moduli space of symplectic equivalence classes of n-polygons (2^n -D space of polygons is reduced to $n + 1$ -D space). For non-convex polygons the number of 3-sub-polygons is reduced so that they seem to correspond to lower-dimensional sub-space. In the

case of CP_2 n -polygon allows besides the areas of 3-polygons also 4-volumes of 5-polygons as fundamental symplectic invariants. The number of independent 5-polygons for n -polygon can be obtained by using induction: once the numbers $N(k, n)$ of independent $k \leq n$ -simplices are known for n -simplex, the numbers of $k \leq n+1$ -simplices for $n+1$ -polygon are obtained by adding one vertex so that by little visual gymnastics the numbers $N(k, n+1)$ are given by $N(k, n+1) = N(k-1, n) + N(k, n)$. In the case of CP_2 the allowance of 3 analogs $\{N, S, T\}$ of North and South poles of S^2 means that besides the areas of polygons (s_1, s_2, s_3) , (s_1, s_2, s_3, X) , (s_1, s_2, s_3, X, Y) , and (s_1, s_2, s_3, N, S, T) also the 4-volumes of 5-polygons (s_1, s_2, s_3, X, Y) , and of 6-polygon (s_1, s_2, s_3, N, S, T) , $X, Y \in \{N, S, T\}$ can appear as additional arguments in the definition of 3-point function.

- (b) What one really means with symplectic tensor is not clear since the naive first guess for the n -point function of tensor fields is not manifestly general coordinate invariant. For instance, in the model of CMB, the components of the metric deformation involving S^2 indices would be symplectic tensors. Tensorial n -point functions could be reduced to those for scalars obtained as inner products of tensors with Killing vector fields of $SO(3)$ at S^2 . Again a preferred choice of quantization axis would be introduced and special points would correspond to the singularities of the Killing vector fields.

The decomposition of Hamiltonians of the "world of classical worlds" expressible in terms of Hamiltonians of $S^2 \times CP_2$ to irreps of $SO(3)$ and $SU(3)$ could define the notion of symplectic tensor as the analog of spherical harmonic at the level of configuration space. Spin and gluon color would have natural interpretation as symplectic spin and color. The infinitesimal action of various Hamiltonians on n -point functions defined by Hamiltonians and their super counterparts is well-defined and group theoretical arguments allow to deduce general form of n -point functions in terms of symplectic invariants.

- (c) The need to unify p -adic and real physics by requiring them to be completions of rational physics, and the notion of finite measurement resolution suggest that discretization of also fusion algebra is necessary. The set of points appearing as arguments of n -point functions could be finite in a given resolution so that the p -adically troublesome integrals in the formulas for the fusion rules would be replaced with sums. Perhaps rational/algebraic variants of $S^2 \times CP_2 = SO(3)/SO(2) \times SU(3)/U(2)$ obtained by replacing these groups with their rational/algebraic variants are involved. Tetrahedra, octahedra, and dodecahedra suggest themselves as simplest candidates for these discretized spaces. Also the symplectic moduli space would be discretized to contain only n -tuples for which the symplectic invariants are numbers in the allowed algebraic extension of rationals. This would provide an abstract looking but actually very concrete operational approach to the discretization involving only areas of n -tuples as internal coordinates of symplectic equivalence classes of n -tuples. The best that one could achieve would be a formulation involving nothing below measurement resolution.
- (d) This picture based on elementary geometry might make sense also in the case of conformal symmetries. The angles associated with the vertices of the S^2 projection of n -polygon could define conformal invariants appearing in n -point functions and the algebraization of the corresponding phases would be an operational manner to introduce the space-time correlates for the roots of unity introduced at quantum level. In CP_2 degrees of freedom the projections of n -tuples to the homologically trivial geodesic sphere S^2 associated with the particular sector of CH would allow to define similar conformal invariants. This framework gives dimensionless areas (unit sphere is considered). p -Adic length scale hypothesis and hierarchy of Planck constants would bring in the fundamental units of length and time in terms of CP_2 length.

These findings raise the hope that quantum TGD is indeed a solvable theory. Even if one is not willing to swallow any bit of TGD, the classification of the symplectic QFTs remains a fascinating mathematical challenge in itself. A further challenge is the fusion of conformal QFT and symplectic QFT in the construction of n -point functions. One might hope that conformal and symplectic fusion rules can be treated separately.

What symplectic QFT tells about fluctuations?

It is interesting to look what one can say about the CMB assuming symplectic QFT using the proposed poor man's formulation.

The general predictions are that all n-point functions are non-vanishing so that Gaussianity fails to be true. In the symmetric scenario there is no breaking of rotational and reflection symmetries. In symmetric breaking scenario both breakings are present.

Consider first 2-point correlation functions.

- (a) The averaged 2-point correlation function $C(\theta)$ is obtained as

$$C(\theta) = \langle \Phi(s_1)\Phi(s_2) \rangle = \sum_n f_n \langle \int [\Delta A(s_1, s_2, s)]^n d\mu_s \rangle ,$$

$$\Delta A(s_1, s_2, s) = A(s_1, s_2, s, N) - A(s_1, s_2, s, P) . \quad (10.8.7)$$

- (b) If $f(\Delta A)$ is odd function of $\Delta A = A(s_1, s_2, s_3, N) - A(s_1, s_2, s_3, P)$, the first order term of the 3-point function changes sign under reflection of the first two arguments with respect to the equatorial plane and same holds true for all odd powers of ΔA as a simple argument shows. Same holds true for the 2-point correlation function so that its average over all points with same angular distance vanishes giving $C(\theta) = 0$. $C(\theta)$ is completely determined by the even part of f and one can write the averaged correlation function as

$$C(\theta) = \sum_n f_{2n} \langle \int [\Delta A(s_1, s_2, s)]^{2n} d\mu_s \rangle . \quad (10.8.8)$$

Thus the rotational averages of the numerically calculable even 'moments' $\int [\Delta A(s_1, s_2, s)]^{2n} d\mu_s$ determine $C(\theta)$.

- (c) Since $C(\theta)$ has also negative values, some of the coefficients f_{2n} must be negative. The variation of the signs of the coefficients is also necessary to explain the presence of positive maxima and negative minima in $C(\theta)$.
- (d) An open question is whether the smallness of $C(\theta)$ for angle separation larger than 60 degrees could be understood from symplectic invariance alone.

3-point correlation functions are certainly non-trivial and this means means a non-Gaussian behavior. Non-vanishing 2-point functions are averages of the 3-point functions involving identity operator with respect to third argument multiplied by 4π . Hence the non-Gaussian behavior is significant effect. For 3-point functions not involving identity operator the coefficients c_{klm} could be smaller.

Consider next the fluctuations.

- (a) It would be nice if temperature fluctuations could be interpreted as 1-point functions rather than particular fluctuations. This is not the case since the only reasonable candidate would be obtained in terms of the area of the degenerate geodesic triangle spanned by s and poles. This means that one must interpret the data as fluctuations rather than averages of fluctuations unless one is ready to break the symmetry by shifting slightly the second preferred point, say South Pole.
- (b) The intuitive notions about distribution for the fluctuations and amplitude of fluctuations are not readily expressible in terms of n-point correlation functions since the moments $\langle \Phi(s)^k \rangle$ vanish identically. One can however perform smoothing out of these quantities and replace the quantity $\langle \Phi(s)^k \rangle$ with $\int \langle \prod_i \Phi(s_i) \rangle \prod_k d\mu_{s_k} / A^n$, where the integrations are over a small disk of area A around point s . This gives a well defined variance and one can speak about fluctuation amplitude in a given resolution defined by A . The moments define in a given resolution what the probability distribution for the fluctuations means.

- (c) This definition allows to formulate what the evidence for the hemispherical asymmetry for the probability distribution of fluctuations could mean. Hemispherical asymmetry is obtained in the smooth out sense if the two-point correlation functions with arguments differing by a reflection with respect to equatorial plane are not identical: that is if $f(\Delta A)$ contains both even and odd coefficients f_n . The reason is that the sign of ΔA changes in the reflection. This could be tested by considering the counterpart of $C(\theta)$ defined by taking only average with respect to point pairs in upper/lower hemisphere and comparing the results.

To sum up, the breaking of the rotational symmetry and parity breaking via a selection of a preferred equatorial plane conform with the general properties of the physical correlation functions and it remains to be seen whether fusion rules force f to have both odd and even parts necessary in obtain to obtain the breaking of reflection symmetry. The challenge is to understand whether the correlation between cosmic and local geometries (equatorial plane of S^2 and galactic plane) is a pure accident or whether there is something much deeper involved.

Could cosmic quantum coherence explain the correlation of the quantum fluctuations at surface of last scattering with galactic geometry?

The idea about hierarchy of Planck constants was inspired by the finding that the orbits of inner and outer planets could be regarded in a reasonable approximation as Bohr orbits but with Planck constant which was gigantic and was for outer planets smaller than for inner planets by a factor of $1/5$ [K72]. The gigantic value of the Planck constant at the flux tubes mediating gravitational interactions implies quantum coherence in cosmic scales and this could allow a radically new interpretation of CMB anomalies. In particular, it could explain why the preferred equatorial plane of the sphere of last scattering predicted by symplectic QFT with spontaneous symmetry breaking is near to the galactic plane.

- (a) Gravitational Planck constant associated with the flux tubes mediating gravitational interactions has a gigantic value, which quantum coherence in cosmological scales. This forces to ask whether the measurement of CMB background should be considered as a quantum measurement in cosmic scales and whether its outcome could be analogous to the state function reduction at the level of particle physics as far as dark space-time sheets are considered. If dark matter dictates the behavior of visible matter one must consider the possibility that quantum measurement in dark scales could dramatically affect the geometric past in cosmic scales. On the other hand, the CMB measurements as such are only about distribution of ordinary photons and can only tell which quantum fluctuation pattern has been selected in quantum measurement in dark matter scales.
- (b) The situation at quantum criticality would correspond to a superposition of quantum fluctuations having in accordance with zero energy ontology time-like entanglement with the "observer". This entanglement correlates the states of observer with the quantum fluctuations. Observer could be a dark matter system assignable to galaxy, say the field body of galactic system with gigantic Planck constant connecting observer with the sphere of last scattering which in turn might be entangled with the solar system. The question is whether the time-like entanglement correlates some geometric properties of the observing system (say various directions like normal of the ecliptic or galactic plane) with the geometric properties of the quantum fluctuation spectrum (say the direction of the quantization axis defining equatorial asymmetry)?
- (c) Could one imagine that "we" as observers are entangled with the possible states of the galactic gravito-magnetic body in turn entangled gravitationally with the quantum fluctuations at the sphere of last scattering and that the measurement of the state of galactic system telling the direction of galactic plane, etc... selects also the dark quantum fluctuation in the geometric past. If so, the selection of quantization axes for fluctuations would be same for the observer and sphere of last scattering. If the choice is dictated by the observer, the breaking of rotational symmetry and parity symmetry and choice of galactic plane as preferred plane would be induced by quantum measurement. Note that this does not lead

to any obvious contradictions since the spheres of last scattering are in principle different for observers at different positions of the Universe. If this interpretation is correct, the strange anomalies of CMB would provide a rather dramatic verification for the Wheeler's idea about participatory Universe.

10.9 Quantum fluctuations in geometry as a new kind of noise?

The motivation for writing this section came from the email of Jack Sarfatti. I learned that gravitational detectors in GEO600 experiment have been plagued by unidentified noise in the frequency range 300-1500 Hz [E86] . Craig J. Hogan has proposed an explanation in terms of holographic Universe [E150] By reading the paper I learned that assumptions needed are essentially those of quantum TGD. Light-like 3-surfaces as basic objects, holography, effective 2-dimensionality, are some of the terms appearing repeatedly in the article.

10.9.1 The experiment

Consider first the graviton detector used in GEO600 experiment. The detector consists of two long arms (the length is 600 meters)- essentially rulers of equal length. The incoming gravitational wave causes a periodic stretch of the arms: the lengths of the rulers vary. The detection of gravitons means that laser beam is used to keep record about the varying length difference. This is achieved by splitting the laser beam into two pieces using a beam splitter. After this the beams travel through the arms and bounce back to interfere in the detector. Interference pattern tells whether the beam spent slightly different times in the arms due to the stretching of arm caused by the incoming gravitational radiation. The problem of experimenters has been the presence of an unidentified noise in the range 100-1500 Hz.

The prediction of the article *Measurement of quantum fluctuations in geometry* by Craig Hogan [E150] is that holographic geometry of space-time should induce fluctuations of classical geometry with a spectrum which is completely fixed . Hogan's prediction is very general and - if I have understood correctly - the fluctuations depend only on the duration (or length) of the laser beam using Planck length as a unit. Note that there is no dependence on the length of the arms and the fluctuations characterize only the laser beam. Although Planck length appears in the formula, the fluctuations need not have anything to with gravitons but could be due to the failure of the classical description of laser beams. The great surprise was that the prediction of Hogan for the noise is of same order of magnitude as the unidentified noise bothering experiments in the range 100-700 Hz.

10.9.2 Hogan's theory

Let us try to understand Hogan's theory in more detail.

- (a) The basic quantitative prediction of the theory is very simple. The spectral density of the noise for high frequencies is given by $h_H = t_P^{1/2}$, where $t_P = (\hbar G)^{1/2}$ is Planck time. For low frequencies h_H is proportional to $1/f$ just like $1/f$ noise. The power density of the noise is given by t_P and a connection with poorly understood $1/f$ noise appearing in electronic and other systems is suggestive. The prediction depends only Planck scale so that it should very easy to kill the model if one is able to reduce the noise from other sources below the critical level $t_P^{1/2}$. The model predicts also the the distribution characterizing the uncertainty in the direction of arrival for photon in terms of the ratio l_P/L . Here L is the length or beam of equivalently its duration. A further prediction is that the minimal uncertainty in the arrival time of photons is given by $\Delta t = (t_P t)^{1/2}$ and increases with the duration of the beam.

- (b) Both quantum and classical mechanisms are discussed as an explanation of the noise. Gravitational holography is the key assumption behind both models. Gravitational holography states that space-time geometry has two space-time dimensions instead of three at the fundamental level and that third dimension emerges via holography. A further assumption is that light-like (null) 3-surfaces are the fundamental objects. Sounds familiar!

Heuristic argument

The model starts from an optics inspired heuristic argument.

- (a) Consider a light ray with length L , which ends to aperture of size D . This gives rise to a diffraction spot of size $\lambda L/D$. The resulting uncertainty of the transverse position of source is minimized when the size of diffraction spot is same as aperture size. This gives for the transverse uncertainty of the position of source $\Delta x = (\lambda L)^{1/2}$. The orientation of the ray can be determined with a precision $\Delta\theta = (\lambda/L)^{1/2}$. The shorter the wavelength the better the precision. Planck length is believed to pose a fundamental limit to the precision. The conjecture is that the transverse indeterminacy of Planck wave length quantum paths corresponds to the quantum indeterminacy of the metric itself. What this means is not quite clear to me.
- (b) The basic outcome of the model is that the uncertainty for the arrival times of the photons after reflection is proportional to

$$\Delta t = t_P^{1/2} \times (\sin(\theta))^{1/2} \times \sin(2\theta) ,$$

where θ denotes the angle of incidence on beam splitter. In normal direction Δt vanishes. The proposed interpretation is in terms of Brownian motion for the distance between beam splitter and detector the interpretation being that each reflection from beam splitter adds uncertainty. This is essentially due to the replacement of light-like surface with a new one orthogonal to it inducing a measurement of distance between detector and beam splitter.

This argument has some aspects which I find questionable.

- (a) The assumption of Planck wave length waves is certainly questionable. The underlying is that it lead to the classical formula involving the aperture size which is eliminated from the basic formula by requiring optimal angular resolution. One might argue that a special status of waves with Planck wave length breaks Lorentz invariance but since the experimental apparatus defines a preferred coordinate system this need not be a problem.
- (b) Unless one is ready to forget the argument leading to the formula for $\Delta\theta$, one can argue that the description of the holographic interaction between distant points induced by these Planck wave length waves in terms of aperture with size $D = (l_P L)^{1/2}$ should have some more abstract physical counterpart. Could elementary particles as extended 2-D objects (as in TGD) play the role of ideal apertures to which a radiation with Planck wave length arrives? If one gives up the assumption about Planck wave radiation the uncertainty increases as λ . To my opinion one should be able to deduced the basic formula without this kind of argument.

Argument based on uncertainty principle for waves with Planck wave length

Second argument can do without diffraction but still uses Planck wave length waves.

- (a) The interactions of Planck wave length radiation at null surface at two different times corresponding to normal coordinates z_1 and z_2 at these times are considered. From the standard uncertainty relation between momentum and position of the incoming particle one deduces uncertainty relation for transverse position operators $x(z_i)$, $i=1,2$. The uncertainty comes from uncertainty of $x(z_2)$ induced by uncertainty of the transverse momentum $p_x(z_i)$. The uncertainty relation is deduced by assuming that $(x(z_2) - x(z_1))/(z_2 - z_1)$ is the ratio of transversal and longitudinal wave vectors. This relates $x(z_2)$ to $p_x(z_i)$ and the uncertainty

relation can be deduced. The uncertainty increases linearly with $z_2 - z_1$. Geometric optics is used to describing the propagating between the two points and this should certainly work for a situation in which wavelength is Planck wavelength if the notion of Planck wave length wave makes sense. From this formula the basic predictions follow.

- (b) Hogan emphasizes that the basic result is obtained also classically by assuming that light-like surfaces describing the propagation of light between ends points of arm describe Brownian like random walk in directions transverse to the direction of propagation. I understand that this means that Planck wave length wave is not absolutely necessary for this approach.

Description in terms of equivalent gravitonic wave packet

Hogan discusses also an effective description of holographic noise in terms of gravitational wave packet passing through the system.

- (a) The holographic noise at frequency f has equivalent description in terms of a gravitational wave packet of frequency f and duration $T = 1/f$ passing through the system. In this description the variance for the length difference of arms using standard formula for gravitational wave packet is given by

$$\frac{\Delta l^2}{l^2} = h^2 f \ ,$$

where h characterizes the spectral density of gravitational wave.

- (b) For high frequencies one obtains

$$h = h_P = (t_P)^{1/2} \ .$$

- (c) For low frequencies the model predicts

$$h = \frac{f_{res}}{f} (t_P)^{1/2} .$$

Here f_{res} characterized the inverse residence time in detector and is estimated to be about 700 Hz in GEO600 experiment.

- (d) The predictions of the theory are compared to the unidentified noise in the frequency range 100-600 Hz which introduces amplifying factor varying from 7 to 1. The orders of magnitude are same.

10.9.3 TGD based model

In TGD based model for the claimed noise one can avoid the assumption about waves with Planck wave length. Rather Planck length corresponds to the transversal cross section of so called massless extremals (MEs) assignable to MEs and orthogonal to the direction of propagation. Further elements are so called number theoretic braids leading to the discretization of quantum TGD at fundamental level. The mechanism inducing the distribution for the travel times of reflected photon is due to the transverse extension of MEs, discretization in terms of number theoretic braids. Note that also in Hogan's model it is essential that one can speak about position of particle in the beam.

Some background

Consider first the general picture behind the TGD inspired model.

- (a) What authors emphasize can be condensed to the following statement: *The transverse indeterminacy of Planck wave length seems likely to be a feature of 3+1 D space-time emerge as a dual of quantum theory on a 2+1-D null surface.* In TGD light-like 3-surfaces indeed are the fundamental objects and 4-D space-time surface is in a holographic

relation to these light-like 3-surfaces. The analog of conformal invariance in light-like radial direction implies that partonic 2-surfaces are actually basic objects in short scales in the sense that one 3-dimensionality only in discretized sense.

- (b) Both the interpretation as almost topological quantum field theory, the notion of finite measurement resolution, number theoretical universality making possible p-adicization of quantum TGD, and the notion of quantum criticality lead to a fundamental description in terms of discrete points sets. These are defined as intersections of what I call number theoretic braids with partonic 2-surfaces X^2 at the boundaries of causal diamonds identified as intersections of future and past directed light-cones forming a fractal hierarchy. These 2-surfaces X^2 correspond to the ends of light-like three surfaces. Only the data from this discrete point set is used in the definition of M-matrix: there is however continuum of selections of this data set corresponding to different directions of light-like ray at the boundary of light-cone, and in detection one of these direction is selected and corresponds to the direction of beam in the recent case.
- (c) Fermions correspond to CP_2 type vacuum extremal with Euclidian signature of induced metric condensed to space-time sheet with Minkowskian signature and light-like wormhole throat for which 4-metric is degenerate carries the quantum numbers. Bosons correspond to wormhole contacts consisting of a piece of CP_2 vacuum extremal connecting two two space-time sheets with Minkowskian signature of induced metric. The strands of number theoretic braids carry fermionic quantum numbers and discretization is interpreted as a space-time correlate for the finite measurement resolution implying the effective grainy nature of 2-surfaces.

The model

Consider now the TGD inspired model for a laser beam of fixed duration T .

- (a) In TGD framework the beams of photons and perhaps also photons themselves would have so called massless extremals as space-time correlates. The identification of gauge bosons as wormhole contacts means that there is a pair of MEs connected by a pieces of CP_2 type vacuum extremal and carrying fermion and antifermion at the wormhole throats defining light-like 3-surfaces. The intersection of ME with light-cone boundary would represent partonic 2-surface and any transverse cross section of the M^4 projection of ME is possible.
- (b) The reflection of ME has description in terms of generalized Feynman diagrams for which the incoming lines correspond to the light-like three surfaces and vertices to partonic 2-surfaces at which the MEs are glued together. In this simplest model this surface defines transverse cross section of both incoming and outgoing ME. The incoming and outgoing braid strands end to different points of the cross section because if two points coincide the N-point correlation function vanishes. This means that in the reflection the distribution for the positions of braid points representing exact positions of photon change in non-deterministic manner. This induces a quantum distribution of transverse coordinates associated with braid strands and in the detection state function reduction occurs fixing the position of braid strands.
- (c) The transversal cross section has maximum area when it is parallel to ME. In this case the area is apart from a numerical constant equal to $d \times L$, L the length defined by the duration of laser beam defining the length of ME and d the diameter of orthogonal cross section of ME. This makes natural the assumption about Gaussian distribution for the positions of points in the cross section as Gaussian with variance equal to $d \times L$. The distribution proposed by Hogan is obtained if d is given by Planck length. This would mean that the minimum area for a cross section of ME is very small, about $S = \hbar \times G$. This might make sense if the ME represents laser beam.
- (d) The assumption susceptible to criticism is that for the primordial ME representing photon the area of cross section orthogonal to the direction of propagation is assumed to be always given by Planck length. This assumption of course replaces Hogan's Planck wave. Note that the classical four-momentum of ME is massless. One could however argue that in

quantum situation transverse momentum square is well defined quantum number and of order Planck mass squared.

- (e) In TGD Universe single photon would differ from infinitely narrow ray by having thickness defined by Planck length. There would be just single braid strand and its position would change in the reflection. The most natural interpretation indeed is that the pair of space-time sheets associated with photon consists of MEs with different transversal size scales: larger ME could represent laser beam. The noise would come from the lowest level in the hierarchy. One could argue that the natural size for M^4 projection of wormhole throat is of order CP_2 size R and therefore roughly 10^4 Planck lengths. If the cross section has area of order R^2 , where R is CP_2 size, the spectral density would be roughly by a factor 100 larger than for Planck length and this might predict too large holographic noise in GEO600 experiment if the value of f_{res} is correct. The assumption that the Gaussian characterizing the position distribution of the wormhole throat is very strongly concentrated near the center of ME with transverse size given by R looks un-natural.
- (f) It is important to notice that single reflection of primordial ME corresponds to a minimum spectral noise. Repeated reflections of ME in different directions gradually increase the transversal size of ME so that the outcome is cylindrical ME with radius of order $L = cT$, where T is the duration of ME. At this limit the spectral density of noise would be $T^{1/2}$ meaning that the uncertainty in the frequency assignable to the arrival time of photons would of same order as the oscillation period $f = 1/T$ assignable to the original ME. The interpretation is that the repeated reflections gradually generate noise and destroy the coherence of the laser beam. This would however happen at single particle level rather than for a member of fictive ensemble. Quite literally, photon would get old! This interpretation conforms with the fact that in TGD framework thermodynamics becomes part of quantum theory and thermodynamical ensemble is represented at single particle level in the sense and time like entanglement coefficients between positive and negative energy parts of zero energy state define M-matrix as a product of square root of diagonal density matrix and of S-matrix.
- (g) The notion of number theoretic braid is essential for the interpretation for what happens in detection. In detection the positions of ends of number theoretic braid are measured and this measurement fixes the exact time spent by photons during the travel. Similar position measurement appears also in Hogan's argument. Thus the overall picture is more or less same as in the popular representation where also the grainy nature of space-time is emphasized.
- (h) I already mentioned the possible connection with poorly understood $1/f$ noise appearing in very many systems. The natural interpretation would be in terms of MEs.

The relationship with hierarchy of Planck constants

It is interesting to combine this picture with the vision about the hierarchy of Planck constants (I am just now developing in detail the representation of the ideas involved from a perspective given by the intense work during last five years).

- (a) If one accepts that dark matter corresponds to a hierarchy of phases of matter labeled by a hierarchy of Planck constants with arbitrarily large values, one must conclude that Planck length l_P proportional to $\hbar^{1/2}$, has also spectrum. Primordial photons would have transversal size scalings as $\hbar^{1/2}$. One can consider the possibility that for large values of \hbar the transversal size saturates to CP_2 length $R \simeq 10^4 \times l_P$. The spectral density of the noise would scale as $\hbar^{1/4}$ at least up to the critical value $\hbar_{cr} = R^2/G$, which is in the range $[2.3683, 2.5262] \times 10^7$. The preferred values of \hbar number theoretically simple integers expressible as product of distinct Fermat primes and power of 2. $\hbar_{cr}/\hbar_0 = 3 \times 2^{23}$ is integer of this kind and belongs to the allowed range of critical values.
- (b) The order of magnitude for gravitational Planck constant assignable to the space-time sheets mediating gravitational interaction is gigantic - of order $\hbar_{gr} \simeq GM^2$ for ideal black holes - so that the noise assignable to gravitons would be gigantic in astrophysical scales

unless R serves as the upper bound for the transverse size of both primordial gauge bosons and gravitons.

- (c) If ordinary photonic space-time sheets are in question \hbar has its standard value. For dark photons which I have proposed to play a key role in living matter, the situation changes and $\Delta l^2/l^2$ would scale like $\hbar^{1/2}$ at least up to critical value of Planck constant. Above this value of Planck constant spectral density would be given by R and $\Delta l^2/l^2$ would scale like R/l and $\Delta\theta$ like $(R/l)^{1/2}$.

10.10 Appendix: Orbital radii of exoplanets as a test for the theory

In this appendix the orbital radii of exo-planets as test of the theory are considered.

Orbital radii of exoplanets serve as a test for the theory. Hundreds of them are already known and in [E26] tables listing basic data for for 136 exoplanets can be found. Tables provide also references and links to sources giving data about stars, in particular star mass M using solar mass M_S as a unit. Hence one can test the formula for the orbital radii given by the expression

$$\begin{aligned} \frac{r}{r_E} &= \frac{n^2}{5^2} \frac{M}{M_S} X , \\ X &= \left(\frac{n_1}{n_2}\right)^2 , \\ n_i &= 2^{k_i} \times \prod_{s_i} F_{s_i} , \quad F_{s_i} \in \{3, 5, 17, 257, 2^{16} + 1\} . \end{aligned} \quad (10.10.1)$$

Here a given Fermat prime F_{s_i} can appear only once.

It turns out that the simplest option assuming $X = 1$ fails badly for some planets: the resulting deviations of order 20 per cent typically but in the worst cases the predicted radius is by factor of $\sim .5$ too small. The values of X used in the fit correspond to $X \in \{(2/3)^2, (3/4)^2, (4/5)^2, (5/6)^2, (15/17)^2, (15/16)^2, (16/17)^2\} \simeq \{.44, .56, .64, .69, .78, .88, .89\}$ and their inverses. The tables summarizing the resulting fit using both $X = 1$ and value giving optimal fit are given below. The deviations are typically few per cent and one must also take into account the fact that the masses of stars are deduced theoretically using the spectral data from star models. I am not able to form an opinion about the real error bars related to the masses.

In the tables R denotes the value of minor semiaxis of the planetary orbit using AU as a unit and M the mass of star using solar mass M_S as a unit. n is the value of the principal quantum number and R_1 the radius assuming $X = (r/s)^2 = 1$ and R_2 the value for the best choice of X as ratio of "ruler and compass integers". The data about radii of planets are from tables at <http://exoplanets.org/almanacframe.html> and star masses from the references contained by the tables.

Star Name	R	M	n	R1	R1/R	r	s	R2/R
HD73256	0.037	1.05	1	0.042	1.14	16	15	1.00
HD83443	0.040	0.79	1	0.032	0.79	15	17	1.01
HD46375	0.040	1.00	1	0.040	1.00	1	1	1.00
HD179949	0.040	1.24	1	0.050	1.24	17	15	0.97
HD187123b	0.040	1.06	1	0.042	1.06	1	1	1.06
HD120136	0.050	1.30	1	0.052	1.04	1	1	1.04
HD330075	0.046	0.70	1	0.028	0.61	4	5	0.95
BD-103166	0.050	1.10	1	0.044	0.88	15	16	1
HD209458	0.050	1.05	1	0.042	0.84	16	17	0.95
HD76700	0.050	1.00	1	0.040	0.8	15	17	1.03
HD217014	0.050	1.06	1	0.042	0.85	15	16	0.96
HD9826b	0.059	1.30	1	0.052	0.88	15	16	1.00
HD49674	0.060	1.00	1	0.040	0.67	5	6	0.96
HD68988	0.070	1.20	1	0.048	0.69	5	6	0.99
HD168746	0.065	0.88	1	0.035	0.54	3	4	0.96
HD217107	0.070	0.98	1	0.039	0.56	3	4	1
HD162020	0.074	0.75	1	0.030	0.41	2	3	0.91
HD130322	0.088	0.79	1	0.032	0.36	3	5	1
HD108147	0.102	1.27	1	0.051	0.50	3	4	0.89
HD38529b	0.129	1.39	1	0.056	0.43	2	3	0.97
HD75732b	0.115	0.95	1	0.038	0.33	3	5	0.92
HD195019	0.140	1.02	2	0.163	1.17	16	15	1.02
HD6434	0.150	0.79	2	0.126	0.84	15	16	0.96
HD192263	0.150	0.79	2	0.126	0.84	15	16	0.96
GJ876c	0.130	0.32	3	0.115	0.89	15	16	1.01
HD37124b	0.181	0.91	2	0.146	0.80	15	17	1.03
HD143761	0.220	0.95	2	0.152	0.69	5	6	0.99
HD75732c	0.240	0.95	2	0.152	0.63	4	5	0.99
HD74156b	0.280	1.27	2	0.203	0.73	5	6	1.05
HD168443b	0.295	1.01	2	0.162	0.55	3	4	0.97
GJ876b	0.210	0.32	4	0.205	0.98	1	1	0.98
HD3651	0.284	0.79	3	0.284	1.00	1	1	1
HD121504	0.320	1.18	2	0.189	0.59	3	4	1.05
HD178911	0.326	0.87	3	0.313	0.96	1	1	0.96
HD16141	0.350	1.00	3	0.360	1.03	1	1	1.03
HD114762	0.350	0.82	3	0.295	0.84	15	16	0.96
HD80606	0.469	1.10	3	0.396	0.84	15	16	0.96
HD117176	0.480	1.10	3	0.396	0.83	15	16	0.94
HD216770	0.460	0.90	3	0.324	0.70	5	6	1.01

Star Name	R	M	n	R1	R1/R	r	s	R2/R
HD52265	0.49	1.13	3	0.41	0.83	15	16	0.94
HD73526	0.65	1.02	4	0.65	1	1	1	1.00
HD82943c	0.73	1.05	4	0.67	0.92	16	17	1.04
HD8574	0.77	1.17	4	0.75	0.97	1	1	0.97
HD169830	0.82	1.40	4	0.90	1.09	17	16	0.97
HD9826c	0.83	1.30	4	0.83	1.00	1	1	1.00
HD202206	0.83	1.15	4	0.74	0.89	15	16	1.01
HD89744	0.89	1.40	4	0.9	1.01	1	1	1.01
HD134987	0.81	1.05	4	0.67	0.83	15	16	0.94
HD12661b	0.82	1.07	4	0.68	0.84	15	16	0.95
HD150706	0.82	0.98	5	0.98	1.20	16	15	1.05
HD40979	0.81	1.08	4	0.69	0.85	15	16	0.97
HD92788	0.95	1.06	5	1.06	1.12	16	15	0.98
HD142	0.97	1.10	5	1.1	1.13	16	15	1.00
HD28185	1.03	0.99	5	0.99	0.96	1	1	0.96
HD142415	1.07	1.03	5	1.03	0.96	1	1	0.96
HD108874b	1.06	1.00	5	1.00	0.94	1	1	0.94
HD4203	1.09	1.06	5	1.06	0.97	1	1	0.97
HD177830	1.14	1.17	5	1.17	1.03	1	1	1.03
HD128311b	1.02	0.80	6	1.15	1.13	1	1	1.13
HD27442	1.18	1.20	5	1.20	1.02	1	1	1.02
HD210277	1.12	0.99	5	0.99	0.88	15	16	1.01
HD82943b	1.16	1.05	5	1.05	0.91	15	16	1.03
HD20367	1.25	1.17	5	1.17	0.94	1	1	0.94
HD114783	1.19	0.92	6	1.32	1.11	1	1	1.11
HD137759	1.28	1.05	5	1.05	0.82	15	17	1.05
HD19994	1.42	1.34	5	1.34	0.94	1	1	0.94
HD147513	1.26	1.11	5	1.11	0.88	15	16	1.00
HD222582	1.35	1.00	6	1.44	1.07	1	1	1.07
HD65216	1.31	0.92	6	1.32	1.01	1	1	1.01
HD141937	1.52	1.10	6	1.58	1.04	1	1	1.04
HD41004A	1.31	0.70	7	1.37	1.05	1	1	1.05
HD160691b	1.87	1.08	7	2.12	1.13	16	15	0.99

Star Name	R	M	n	R1	R1/R	r	s	R2/R
HD52265	0.49	1.13	3	0.41	0.83	15	16	0.94
HD73526	0.65	1.02	4	0.65	1	1	1	1.00
HD82943c	0.73	1.05	4	0.67	0.92	16	17	1.04
HD8574	0.77	1.17	4	0.75	0.97	1	1	0.97
HD169830	0.82	1.40	4	0.90	1.09	17	16	0.97
HD9826c	0.83	1.30	4	0.83	1.00	1	1	1.00
HD202206	0.83	1.15	4	0.74	0.89	15	16	1.01
HD89744	0.89	1.40	4	0.9	1.01	1	1	1.01
HD134987	0.81	1.05	4	0.67	0.83	15	16	0.94
HD12661b	0.82	1.07	4	0.68	0.84	15	16	0.95
HD150706	0.82	0.98	5	0.98	1.20	16	15	1.05
HD40979	0.81	1.08	4	0.69	0.85	15	16	0.97
HD92788	0.95	1.06	5	1.06	1.12	16	15	0.98
HD142	0.97	1.10	5	1.1	1.13	16	15	1.00
HD28185	1.03	0.99	5	0.99	0.96	1	1	0.96
HD142415	1.07	1.03	5	1.03	0.96	1	1	0.96
HD108874b	1.06	1.00	5	1.00	0.94	1	1	0.94
HD4203	1.09	1.06	5	1.06	0.97	1	1	0.97
HD177830	1.14	1.17	5	1.17	1.03	1	1	1.03

HD128311b	1.02	0.80	6	1.15	1.13	1	1	1.13
HD27442	1.18	1.20	5	1.20	1.02	1	1	1.02
HD210277	1.12	0.99	5	0.99	0.88	15	16	1.01
HD82943b	1.16	1.05	5	1.05	0.91	15	16	1.03
HD20367	1.25	1.17	5	1.17	0.94	1	1	0.94
HD114783	1.19	0.92	6	1.32	1.11	1	1	1.11
HD137759	1.28	1.05	5	1.05	0.82	15	17	1.05
HD19994	1.42	1.34	5	1.34	0.94	1	1	0.94
HD147513	1.26	1.11	5	1.11	0.88	15	16	1.00
HD222582	1.35	1.00	6	1.44	1.07	1	1	1.07
HD65216	1.31	0.92	6	1.32	1.01	1	1	1.01
HD141937	1.52	1.10	6	1.58	1.04	1	1	1.04
HD41004A	1.31	0.70	7	1.37	1.05	1	1	1.05
HD160691b	1.87	1.08	7	2.12	1.13	16	15	0.99

Star Name	R	M	n	R1	R1/R	r	s	R2/R
HD23079	1.65	1.10	6	1.58	0.96	1	1	0.96
HD186427	1.67	1.01	6	1.45	0.87	15	16	0.99
HD4208	1.67	0.93	7	1.82	1.09	16	15	0.96
HD114386	1.62	0.68	8	1.74	1.07	17	16	0.95
HD213240	2.03	1.22	6	1.76	0.87	15	16	0.98
HD10647	2.10	1.07	7	2.10	1.00	1	1	1
HD10697	2.13	1.10	7	2.16	1.01	1	1	1.01
HD95128b	2.09	1.03	7	2.02	0.97	1	1	0.97
HD190228	2.00	0.83	8	2.12	1.06	1	1	1.06
HD114729	2.08	0.93	7	1.82	0.88	15	16	1
HD111232	1.97	0.78	8	2.00	1.01	1	1	1.01
HD2039	2.19	0.98	7	1.92	0.88	15	16	1
HD136118	2.40	1.24	7	2.43	1.01	1	1	1.01
HD50554	2.32	1.07	7	2.09	0.9	15	16	1.02
HD9826d	2.53	1.30	7	2.55	1.01	1	1	1.01
HD196050	2.43	1.10	7	2.16	0.89	15	16	1.01
HD216437	2.43	1.07	8	2.74	1.13	17	15	0.88
HD216435	2.70	1.25	7	2.45	0.91	1	1	0.91
HD169830c	2.75	1.40	7	2.74	1	1	1	1
HD106252	2.54	0.96	8	2.46	0.97	1	1	0.97
HD12661c	2.60	1.07	8	2.74	1.05	1	1	1.05
HD23596	2.86	1.30	7	2.55	0.89	15	16	1.01
HD168443c	2.87	1.01	8	2.59	0.9	15	16	1.03
HD145675	2.85	1.00	8	2.56	0.9	15	16	1.02
HD11964b	3.10	1.10	8	2.82	0.91	16	17	1.03
HD39091	3.29	1.10	9	3.56	1.08	17	16	0.96
HD38529c	3.71	1.39	8	3.56	0.96	1	1	0.96
HD70642	3.30	1.00	9	3.24	0.98	1	1	0.98
HD33636	3.56	0.99	9	3.21	0.9	15	16	1.03
HD95128c	3.73	1.03	10	4.12	1.1	16	15	0.97
HD190360	3.65	0.96	10	3.84	1.05	1	1	1.05
HD74156c	3.82	1.27	9	4.11	1.08	1	1	1.08
HD22049	3.54	0.80	11	3.87	1.09	16	15	0.96
HD30177	3.86	0.95	10	3.80	0.98	1	1	0.98
HD89307	4.15	0.95	10	3.80	0.92	1	1	0.92
HD72659	4.50	0.95	11	4.60	1.02	1	1	1.02
HD75732d	5.90	0.95	13	6.42	1.09	16	15	0.96

Chapter 11

What are the counterparts of Einstein's equations in TGD?

11.1 Introduction

The original motivation of this work was related to Platonic solids. The playing with Einstein's equations and the attempts to interpret them physically forced the return to an old interpretational problem of TGD. TGD allows enormous vacuum degeneracy for Kähler action but the vacuum extremals are not gravitational vacua. Could this mean that TGD forces to modify Einstein's equations? Could space-time surfaces which would carry energy and momentum in GRT framework be vacua in TGD context?

Trying to understand what is involved led to the realization that the hypothesis that preferred extremals correspond to the solutions of Einstein-Maxwell equations with cosmological constant [K94, K11, K85] is too restricted in the case of vacuum extremals and also in the case of standard cosmologies imbedded as vacuum extremals. What one must achieve is the vanishing of the divergence of energy momentum tensor of Kähler action expressing the local conservation of energy momentum currents. The most general analog of Einstein's equations and Equivalence Principle would be just this condition giving in GRT framework rise to the Einstein-Maxwell equations with cosmological constant.

One can however wonder whether it could be possible to find some general ansätze allowing to satisfy this condition. This kind of ansätze can be indeed found and can be written as $kG + \sum \Lambda_i P_i = T$, where Λ_i are cosmological "constants" and P_i are mutually orthogonal projectors such that each projector contribution has a vanishing divergence. One can interpret the projector contribution in terms of topologically condensed matter, whose energy momentum tensor the projectors code in the representation $kG = -\sum \Lambda_i P_i + T$. Therefore Einstein's equations with cosmological constant are generalized. This generalization is not possible in General Relativity, where Einstein's equations follow from a variational principle. This kind of ansätze can be indeed found and involve the analogs of cosmological constant, which are however not genuine constants anymore. Therefore Einstein's equations with cosmological constant are generalized. This generalization is not possible in General Relativity, where Einstein's equations follow from a variational principle.

The suggested quaternionic preferred extremals and preferred extremals involving Hamilton-Jacobi structure could be identified as different families characterized by the little group of particles involved and assignable to time-like/light-like local direction. One should prove that this ansatz works also for all vacuum extremals. This progress - if it really is progress - provides a more refined view about how TGD Universe differs from the Universe according to General Relativity and leads also to a model for how the cosmic honeycomb structure with basic unit cells having size scale 10^8 ly could be modelled in TGD framework.

The original problem was however not this but the following one. One can decompose Euclidian icosahedron to 20 irregular tetrahedrons emanating from the center of the icosahedron. The

ratio of the lengths of the surface edges (edges connecting points at the surface of the sphere) to the radial edges is in good approximation $k = 1 + \epsilon$, $\epsilon = .05$. If one makes the edges of the tetrahedrons equal by shortening of surface edges while preserving the lengths of the radial edges, one obviously obtains a gap [D13].

Is there any manner to make the tetrahedrons regular without creating a gap?

- (a) At sphere S^3 the counterpart of icosahedron consists of 20 counterparts of regular tetrahedrons. One can say that the generation of positive curvature eliminates the gap formed and shortens the surface edges. Deforming Euclidian space to hyperbolic space in turn adds volume. In 2-D case these rules can be visualized. In fact, one can extend the icosahedron to 600-cell denoted by (3,3,5) in Schönflies notation. What the recursive notation (3,3,5) states is that there are 5 tetrahedra (3,3) with common edge and tetrahedra in turn has 3 triangles with common vertex. The 4-D 600-cell has as boundary 600 tetrahedra assignable to a surface of 3-sphere in a manner completely analogous to the Platonic solids regarded as 2-D surfaces bounding 3-D cells.
- (b) One is however interested in possibly existing Euclidian variants of tetrahedral Penrose tiling and QC, and perhaps also in tetrahedral dense packing (still poorly understood), which must be however distinguished from tetrahedral QC which can quite well contain intersecting tetrahedrons. The problem is that it is difficult to imagine a unique Euclidianization by somehow mapping S^3 to E^3 . Here different topologies pose the basic problem: one cannot avoid local deformations and the presence of singular 2-D surface. The best that one can hope of achieving are clusters of 600 tetrahedra.

The TGD inspired idea to be discussed is that sub-manifold gravity could help to achieve a unique map from S^3 to E^3 and also the counterparts the isosahedral Penrose tiling with icosahedrons consisting of regular tetrahedrons.

- (a) This would be achieved by a local deformation of the E^3 metric obtained by deforming canonically imbedded E^3 in CP_2 directions to make the 20 tetrahedra in the decomposition of the icosahedron regular and space-filling. This deformation would be just a piece of S^3 , say the upper hemisphere. Entire S^3 would require two-sheeted 3-surface and is also possible in TGD. The Euler angles (α, θ, ϕ) for S^3 would correspond to the spherical coordinates of (r, θ, ϕ) via the formula: $\alpha = \arcsin(r/R)$, where R is the radius of S^3 .
- (b) Although the S^3 tetrahedra in the induced metric are regular, they do not look so in E^3 metric, and an interesting question is whether the irregularity of the tetrahedral structures seen in 3-space usually identified as E^3 could correspond to regularity in S^3 . The correspondence between coordinates allows to predict precisely the E^3 coordinates of tetrahedral vertices in the decomposition of S^3 icosahedron so that the hypothesis is testable. The physics of water provides an especially interesting test bench for the idea.
- (c) It is also possible to imagine a construction crystal and quasicrystal (QC) like structures consisting of tetrahedrons by gluing together pieces of S^3 realized as static surfaces in $M^4 \times CP_2$ along their boundaries just as one glues together cubes along their faces to build cubic crystals. Note that this proposal for tetrahedral QC differs from the earlier proposal for twisted QC [L9] in which each supercell (icosahedron for Penrose tiling, and icosahedron, dodecahedron, or icosidodecahedron for icosahedral QC) contains single tetrahedron twisted so that it does not intersect the tetrahedra of neighboring and possibly intersecting supercells.

Deformations of pieces of E^3 to pieces of S^3 is not the only possibility. Also deformations respecting the topology of E^3 are possible.

- (a) One can consider a more general deformation of the metric of E^3 to $ds^2 = k^2(r)dr^2 + r^2d\Omega^2$. One obtains an infinite family of functions $k(r)$ satisfying the condition that an icosahedron with center at North pole $(r, \theta, \phi) = (0, 0, 0)$ of S^3 consists of regular tetrahedrons since the only condition is $\int_0^R k(r)dr = s$, where s is the length of the surface edge and integral defines the length of the radial edge. $k = 1 + \delta = \text{constant}$ option however fails as shown

in Appendix C. In Appendix B it is shown that the 1+3 decomposition $kG + \sum_{i=1,2} \Lambda_i P_i$ allow to deduce differential equation for $k(r)$ but still one has a large number of solutions guaranteeing the regularity of the icosahedral tetrahedra.

- (b) If one accepts also deformations with more general functions $k(r)$ deduced in Appendix B, quite large number of quasi-lattice like structures consisting of regular tetrahedra becomes possible. One can ask whether these geometries could define possible tetrahedral quasi-lattice structures for water clusters having interpretation as some kind of geometric coding of information so that the apparent randomness would reflect hidden geometric order.

In GRT framework the deformation of E^3 to S^3 or a non-compact manifold for more general $k(r)$ and icosahedral Penrose tiling [A45] with icosahedrons consisting of 20 *regular* tetrahedrons are not plausible in condensed matter length scales for the simple reason that the gravitational deformation of the metric is so weak. If one accepts the cautious proposal for TGD variant of Equivalence Principle, it might be possible to realize these tetrahedral dreams. The projector contributions $-\Lambda_i P_i$ would represent average density of topologically condensed whereas T would be vanishing for vacuum extremals.

It becomes also possible to build a model for cosmic honeycombs and quasicrystal like structures consisting of units with size of order 10^8 ly and having galaxies at the boundaries of otherwise almost empty regions known as cosmic voids [E55]. The basic unit would be either a piece of hyperbolic space, of Euclidian space, or of 3-sphere. In hyperbolic case there is infinite number of tessellations. In GRT framework these pieces could carry a constant mass density (sub-critical, critical, or over-critical) but in TGD framework they would be vacua and galactic mass would be associated with their boundaries and idealizable as being due to the discontinuity of the normal component g_{nn} of the induced metric at the 3-D facets along which the super-cells are glued together. The time evolution of critical and super-critical options is unique part from the duration of the nonsingular period, and leads to TGD counterpart of blackhole having Euclidian induced metric. Note that cosmic honeycomb would provide a rather concrete realization for the notion of space-time foam usually assigned with Planck length scale.

It deserves to be mentioned that cosmic honeycombs and their possible counterparts for water clusters modeled as consisting of icosahedral pieces of S^3 bring in mind foams. Soap film foam is perhaps the most familiar example about foam. Plateau's laws govern the structure of many foams. Mean curvature is constant for each film and physically derives from area minimization assuming constant pressure difference over the film. 3 films meet at angle of 120 degrees along a line known as Plateau border and 4 Plateau borders meet at each vertex at tetrahedral angle of $\arccos(-1/3) \simeq 109.47$ degrees (tetrahedral angle is defined as the angle between radii drawn from the center of tetrahedron to its vertices). This suggests spherical tetrahedron as a basic building brick in a model as a honeycomb built from pieces of S^3 . Plateau's laws can be derived mathematically for foams, for which films are minimal surfaces (pressure difference vanishes).

11.2 Does the $SO(3)$ symmetry preserving deformation of the metric of E^3 regularize the icosahedral tetrahedra?

In GRT framework quantum gravitational effects are extremely small in everyday length scales - say in condensed matter physics. In TGD the situation can be different due to sub-manifold gravity predicting new physical effects. Sub-manifold gravity and the notion of many-sheeted space-time indeed challenges the flatness of 3-space as approximation broken only by very weak gravitational effects. The field equations demand that Kähler energy momentum tensor has vanishing divergence. This can be guaranteed if Einstein-Maxwell equations with cosmological term are satisfied: both are in principle predictions of the theory and depend on the preferred extremal [K94].

This is however not the most general option if one is ready to accept TGD and allow the decomposition of the cosmological constant term to a sum of terms proportional to projectors to orthogonal subspaces multiplied with cosmological "constants", which are not constant anymore. The interpretation of the sum of these terms in $kG = -\sum_i \Lambda_i P_i + T$ is in terms of topologically

condensed matter representing topological inhomogeneities smaller than the length scale resolution used (for a more detailed discussion see Appendix A). Therefore it might be also physically possible to modify the 3-metric without giving up $SO(3)$ symmetry and the topology of E^3 , and there would be no need to map S^3 to E^3 in the hope of obtaining what might be called tetrahedral Penrose tiling. In fact, also a deformation of a piece of E^3 to that of S^3 exists and defines this kind of map uniquely.

An obvious deformation of Euclidian metric is obtained by the scaling of the radial component of the E^3 metric

$$ds^2 = dr^2 + r^2 d\Omega^2 \rightarrow k^2(r) dr^2 + r^2 d\Omega^2, \quad k = 1 + \delta. \quad (11.2.1)$$

$k(r)$ could be fixed by the condition that the radial edges of the 20 icosahedral tetrahedra have the same length as the surface edges defined as geodesic lines in the deformed metric. This poses a condition on $k(r)$ but it is not at all obvious whether any solutions to the condition exist.

- (a) $SO(3)$ symmetry alone allows $k(r)$ to be an arbitrary function of the radial coordinate. The original guess was $k = 1 + \delta(r)$ with $\delta(r) \geq 0$ non-vanishing only near the center of the icosahedron so that in the region containing surface edges the metric would be strictly Euclidian. The deviation from E^3 metric near the center of the icosahedron could be due to the presence of a particle. $\delta = \text{constant}$ option is excluded as shown in Appendix C but in Appendix B good arguments supporting $\delta(r) \rightarrow 0$ option are developed. The regularity of the tetrahedral decomposition of the icosahedron with center at $(r, \theta, \phi) = (0, 0, 0)$ follows from the assumption that radial and surface edges have same length:

$$\int_0^R k(r) dr = s, \quad (11.2.2)$$

where s is the length of the surface edge of the icosahedron identified as geodesic line.

- (b) The local deformation of E^3 metric to S^3 metric obtained by allowing CP_2 coordinates to depend on r having $k(r) = 1/(1 - (r/R)^2)$ certainly gives rise to a decomposition of S^3 icosahedron to 20 regular S^3 tetrahedrons realized as a piece of S^3 - say around North pole so that one has radial and surface edges of equal length in S^3 metric but not so in E^3 metric. Entire S^3 requires two-sheeted surface and is also possible to realize in TGD context. This would allow to realize the 600-cell consisting of 600 tetrahedrons.

These conjecture might be testable. A successful test would also provide support for sub-manifold gravity.

- (a) The correspondence $(\alpha, \theta, \phi) = (\arcsin(r/R), \theta, \phi)$ between Euler angles of S^3 and spherical coordinates of E^3 allows a precise identification of E^3 coordinates of tetrahedra and thus precisely quantifies the deviation of regular S^3 tetrahedra from regular E^3 tetrahedra.
- (b) In E^3 metric the tetrahedrons do not look regular, and an interesting possibility is that the icosahedral structures encountered in water clusters could be interpreted in terms of regular S^3 tetrahedrons, when the 3-space is not identified as E^3 but consists of icosahedral pieces of S^3 glued together along S^3 faces.
- (c) For a more general family of functions $k(r)$ similar conditions hold true and would allow quite a large number of quasi-lattice like structures consisting of icosahedra decomposing to 20 regular tetrahedrons. For a given $k(r)$ satisfying the differential equation deduced in Appendix A and the regularity condition $s = \int k dr$, one can predict the precise positions for the vertices of icosahedral tetrahedrons in the spherical coordinates for E^3 . The functions $k(r)$ could make possible to code information to the deformations of E^3 tetrahedrons from regularity. Again water provides the test bench.

Single isosahedron consisting of regular tetrahedrons or even 600-cell or half of it is not enough. One would like to have also Penrose tiling having icosahedrons as supercells. Since the proposed deformation of the metric is not translationally invariant but has the center of the icosahedron as a center of symmetry, the only possibility is to glue together their E^3 (realized as $t = \text{constant}$ hyper-plane of M^4) translates of the basic icosahedron along common faces. One must allow also intersections of icosahedrons and therefore also of tetrahedrons as already for the triangles of the ordinary Penrose tiling obtained by replacing 20 tetrahedrons with 10 triangles and icosahedron with 10-gon. Clearly, tetrahedral Penrose tiling must be distinguished from tetrahedral dense packing. Physically this means that tetrahedral supercells can have common atoms.

The following arguments try to demonstrate that in TGD framework there are good hopes for tetrahedral Penrose tiling having by definition regular S^3 tetrahedrons as possibly overlapping super-cells and induced from icosahedral Penrose tiling. Whether the icosahedral QC containing icosahedra, dodecahedra, and icosidodecahedra as super-cells allows a decomposition to regular tetrahedra for all 3 super-cells, is probably easy to answer. The argument is of course purely mathematical, and the question whether the construction is also physically realizable remains open.

11.2.1 Strong gravitation is possible in TGD framework

The basic motivation for the speculations to follow is that many-sheeted space-time makes possible large deviations from gravitation predicted by GRT, which in TGD framework can be seen as a description of gravitation at the long length scale limit. A fundamental distinction between GRT and TGD is indeed that in TGD framework gravitational constant and cosmological constant - actually space-time dependent cosmological "constants" emerge as predictions of the theory rather than as fundamental constants of Nature.

For almost two decades ago I deduced by purely dimensional considerations a formula for gravitational constant G in terms of p-adic length scale and exponent of Kähler action for CP_2 type vacuum extremal defining the line of generalized Feynman diagram representing graviton [K58]. The prediction was that G should have an entire spectrum of values and approach p-adic length scale squared $L_p^2 = pR_{CP_2}^2$ when the action of the deformed CP_2 type vacuum extremal becomes small: this happens at short length scale limit. In particular, hadronic strings would correspond to strong gravitation limit, and TGD predicts fractally scaled up variants of ordinary hadron physics so that a rich spectrum of strong gravities follows as a prediction. This means that in TGD Universe the the gravitational effects on space-time geometry can be rather dramatic even in condensed matter length scales whereas in GRT the effects are extremely small. With this background philosophy I have discussed the possible differences between General Relativity and TGD-based view about gravitation in [K95]. This chapter should help also to understand the discussion of this section.

The starting point for the following considerations was the question whether the flat geometry for a piece of E^3 could be modified by gravitational effects so that it becomes a piece of S^3 allowing the decomposition of icosahedron to 20 regular tetrahedra (in E^3 geometry the tetrahedra cannot be regular). This kind of decomposition is actually possible for much more general deformations of E^3 geometry and one ends up with the vision about quasi-lattice like structures having piece of S^3 or hyperbolic space H^3 as a basic building brick. This notion makes sense in condensed matter length scales only if gravitational constant can be of order $G \sim L_p^2$ since Schwarzschild radius $r_S = 2GM$ is the natural scale for the radius of S^3 .

The cosmic honeycomb having voids with size of order 10^8 ly as basic building bricks is one possible quasi-lattice like structure suggested by these considerations. In condensed matter length scales strong gravitation could allow similar quasi-lattice like structures and icosahedral water clusters having tetrahedrons as building bricks could be examples of structures of this kind.

Cosmic honeycombs and their possible counterparts for water clusters modeled as consisting of icosahedral pieces of S^3 bring in mind foams. Soap film foam is perhaps the most familiar example about foam. Plateau's laws govern the structure of many foams. Mean curvature is constant for each film and physically derives from area minimization assuming constant pressure

difference over the film. 3 films meet at angle of 120 degrees along a line known as Plateau border and 4 Plateau borders meet at each vertex at tetrahedral angle of $\arccos(-1/3) \simeq 109.47$ degrees (tetrahedral angle is defined as the angle between radii drawn from the center of tetrahedron to its vertices). This suggests spherical tetrahedron as a basic building brick in a model as a honeycomb built from pieces of S^3 . Plateau's laws can be derived mathematically for foams, for which films are minimal surfaces (pressure difference vanishes).

11.2.2 Construction of deformed metrics in zero energy ontology

In TGD framework the view about 3-space generalizes considerably. One assigns to physical systems space-time sheets and space-time sheets can deviate metrically from flat space much more than in general relativity. They can have even Euclidian signature of metric: this signature is assigned to the 4-D lines of generalized Feynman diagrams, which can have macroscopic scale and can be tentatively identified as the space-time regions characterizing physical objects as we "see" them.

Vacuum extremals [K11] provide some illustrative examples. Consider a geodesic circle of CP_2 with angle coordinate Φ and the 4-surface $\Phi = \omega t$, where t is M^4 time coordinate. The induced metric is $(1 - R^2\omega^2, -1, -1, -1)$ and obviously flat. There is no gravitational field present but there is anomalous time dilation, which can be detected if it is possible to use M^4 coordinates of the M^4 factor of $M^4 \times CP_2$ as preferred coordinates - as the fact that Poincare symmetries are associated with imbedding space rather than space-time surface suggests.

Causal diamonds (CDs) define an essential element of zero energy ontology (ZEO). CD is a double pyramid (with spherical cross section) defined by the intersection of future and past directed light-cones of M^4 and has two light-like boundaries. $CD \times CP_2$ defines what might be called a spot light of consciousness in TGD inspired theory of consciousness. Zero energy states correspond to pairs of positive and negative energy states having opposite total quantum numbers, and assignable to the opposite light-like boundaries $\delta M_{\pm}^4 \times CP_2$. Zero energy states correspond to quantum superpositions of pairs of 3-surfaces at the boundaries of $\delta_{\pm} CD \times CP_2$: by holography they can be also regarded as superpositions of preferred extremals. Strong form of holography allows to express physical states in terms of information associated with partonic 2-surfaces and their 4-D tangent space data.

Deformation of E^3 metric to guarantee the regularity of icosahedral tetrahedrons

Usually one thinks that in every-day length scales 3-space is flat E^3 apart from very small gravitational effects. In cosmological scales 3-space is known to be flat in good approximation on basis of CMB data. In short scales mass densities can be however much higher than in cosmic scales (one proton per cubic meter roughly) so that a local compactification to overcritical cosmology consisting of a piece of S^3 could take place. The compactification could be interpreted as being due to the presence of topologically condensed matter. These pieces could in turn be glued together along their boundaries to obtain lattices and quasi-lattice like structures. As shown in Appendix A, this kind of local S^3 compactifications can be both static and expanding. In the latter case, the cosmic time evolution is essentially unique and leads to a singularity, for which the induced metric has Euclidian signature and has interpretation as a TGD counterpart of a blackhole.

Remark: The discussion of Appendix A shows that also static deformations of E^3 to hyperbolic space H^3 are possible, and in this case one would obtain an infinite number of tessellations defined by discrete subgroups of $SO(1, 3)$ including 8 honeycomb structures. Icosahedral quasi-lattice structures encountered in the physics of water provide again a test bench. Now the correspondence $(\eta, \theta, \phi) = (\text{arsinh}(r/R), \theta, \phi)$ between hyperbolic "Euler angles" and spherical coordinates of E^3 would allow to deduce how the H^3 icosahedra (say) and the honeycombs made of them differ from their E^3 counterparts.

Before continuing, some background in TGD is needed. In TGD framework macroscopic objects correspond to 4-surfaces with effective boundaries defined by light-like 3-surfaces at which the signature of the induced metric changes from Minkowskian to Euclidian. The above observations

suggest the possibility of large physical effects on metric in the absence of effects on curvature. But even large effects on curvature cannot be excluded.

One can indeed consider more general metrics for which $g_{rr} = k^2(r)$ holds true. By previous argument, these metrics are just what one wants if one is interested in icosahedral Penrose tiling with icosahedrons decomposed to regular tetrahedra. Note that the metrics in question are highly analogous to those for Robertson-Walker cosmologies with over-critical mass density: the only difference is that time coordinate is replaced with radial coordinate r and S^3 with S^2 .

For the case $k = k(r)$ case the expressions of Ricci and Einstein tensor are given by the expressions

$$\begin{aligned} (R_{rr}, R_{\theta\theta}, R_{\phi\phi}) &= (X, Y, \sin^2(\theta)Y), \quad , \\ (G_{rr}, G_{\theta\theta}, G_{\phi\phi}) &= \left(X - \frac{k^2}{r^2}Y, -\frac{1}{2}\frac{r^2}{k^2}X, -\frac{1}{2}\frac{r^2\sin^2(\theta)}{k^2}X \right) . \\ X &= -4\frac{d\log(k)}{d\log(r)}X \quad , \quad Y = k^{-2} - 1 - \frac{1}{2}\frac{dk^{-2}}{d\log(r)} . \end{aligned} \tag{11.2.3}$$

For $k = \text{constant}$ the Ricci tensor and Einstein tensor have components

$$\begin{aligned} (R_{rr}, R_{\theta\theta}, R_{\phi\phi}) &= (0, r^2, r^2\sin^2(\theta)) \times \frac{(k^{-2}-1)}{r^2} \quad , \\ (G_{rr}, G_{\theta\theta}, G_{\phi\phi}) &= ((1 - k^2)/r^2, 0, 0) . \end{aligned} \tag{11.2.4}$$

The vanishing of $G_{\theta\theta}$ and $G_{\phi\phi}$ can be understood in terms of symmetries. For 4-D solution obtained by adding M^4 time coordinate as fourth coordinate this would mean that energy density T^{tt} is non-vanishing and proportional to $(k^{-2} - 1)/r^2$.

The modification of Einstein's equations suggested by TGD

The deformation of E^3 can be generalized in trivial manner to 4-D situation giving $G_{tt} = k^{-2}G_{rr}$ is in general not consistent with the assumption that preferred extremals (4-surfaces) at the limit of vacuum satisfy Einstein-Maxwell equations with cosmological term satisfying $T = \kappa G + \Lambda g$, where T is the energy momentum tensor associated with Kähler action satisfying $T^\alpha_\alpha = 0$ since Maxwell action is invariant under conformal scalings (in TGD this symmetry is actually broken since Maxwell field is not primary field).

This form of the conditions is however un-necessarily strong. The only condition on preferred extremals is that T has vanishing divergence:

$$D_\beta T^{\alpha\beta} = 0 . \tag{11.2.5}$$

One can however go further and ask whether there might be general ansätze allowing to satisfy this condition.

This condition can be indeed satisfied by assuming only

$$\begin{aligned} T^{\alpha\beta} &= \kappa G^{\alpha\beta} + \sum_i \Lambda_i P_i^{\alpha\beta} \quad , \\ \kappa &= \frac{1}{8\pi G} . \end{aligned} \tag{11.2.6}$$

Here P_i are projectors to mutually orthogonal sub-spaces of the tangent space of the space-time surface. The distributions of the sub-spaces must be integrable to slicings of the space-time surface by sub-manifolds and define d_i -dimensional sub-manifolds of the space-time surface ($\sum_i d_i = d$). Energy momentum tensor of Kähler action has vanishing divergence if one has

$$D_\beta(\Lambda_i P_i^{\alpha\beta}) = 0 \quad . \quad (11.2.7)$$

Λ_i need not be constant functions anymore so that cosmological constant is replaced by two - presumably slowly varying - cosmological "constants". For $\Lambda_i = \Lambda$ one obtains just the ordinary cosmological constant, which must be a genuine constant.

The condition $T_\alpha^\alpha = 0$ gives

$$\kappa R = \sum_i \Lambda_i d_i \quad . \quad (11.2.8)$$

Here R denotes curvature scalar and d_i denotes the dimension of sub-space to which P_i projects. For $\Lambda_i = \Lambda$ one obtains $\kappa R = \Lambda$ so that curvature scalar would be constant, which looks too strong a condition.

In TGD framework the most natural identification of the term $\sum \Lambda_i P_i$ would be in terms of topologically condensed matter consisting of topological in-homogenities smaller than the scales of length and time resolution. In zero energy ontology the interpretation would be in terms of zero energy states in scales below the measurement resolution and interpreted as quantum fluctuations in QFT context.

In Appendix A the situation is considered in more detail.

- (a) It is shown that for Robertson-Walker cosmologies 1+3 decomposition is natural.
- (b) For preferred extremals with what I have called Hamilton-Jacobi structure [K94] in Minkowskian regions one would have 2+2 decomposition. Maybe the 1+3 decomposition corresponds to the quaternionic solution ansatz. The motivation for this belief is that $SO(3)$ has a natural action on quaternions as their automorphism group. For Hamilton-Jacobi structure $SO(3)$ is replaced with the little group of Poincare group assignable to massless particles so that these two kinds of extremals might basically correspond to massive and massless representations of Poincare group.
- (c) For vacuum extremals the inverse images of points of at most 2-D CP_2 projection define 2+2 slicing of the space-time surface, and one can hope that this slicing could give rise to the decomposition $\sum_{i=1,2} \Lambda_i P_i$. It is of course quite possible that not all vacuum extremals can be regarded as limits of preferred extremals with this decomposition.

In the recent case one is interested on having such $k(r)$ that one has vacuum extremal with 1+1+2 decomposition satisfying

$$\begin{aligned} \kappa G^{\alpha\beta} + \sum_{i=1,2,3} \Lambda_i P_i^{\alpha\beta} &= 0 \quad , \\ D_\beta \Lambda_i P_i^{\alpha\beta} &= 0 \quad . \end{aligned} \quad (11.2.9)$$

1 + 1 + 2 decomposition corresponds to coordinate lines for t and r and to spheres (θ, ϕ) . In Appendix B the differential equations for $k(r)$ guaranteeing that $\Lambda_i P_i$ have vanishing divergence are deduced.

These equations can be integrated and give rise to a family of metrics characterized by $k(r)$. Near the center of icosahedron the deformation corresponds to S^3 in a good approximation.

S^3 and H^3 are obtained as particular solutions. For S^3 the decomposition of icosahedron to regular tetrahedrons is possible as already shown. The important and definitely new point of view is that these metrics are vacuum extremals for both Kähler action and in gravitational sense. Einstein's equations are replaced by a more general and weaker condition that the energy momentum tensor of Kähler action has a vanishing divergence.

11.2.3 Various realizations of E^3 and its deformations in TGD framework

TGD allows several realizations of E^3 and its deformations as a surface in $M^4 \times CP_2$.

Deformation of the imbedding of E^3 to $\delta M_{\pm}^4 \times CP_2$

Flat 3-metric is obviously something very fundamental, and one can ask whether one could realize flat 3-surfaces as surfaces in $\delta_{\pm}CD \times CP_2$. The metric at $\delta_{\pm}CD$ is metrically 2-D since the radial direction is light-like, and one can write the metric as

$$ds^2 = -r^2 d\Omega^2 .$$

For a given value of the radial coordinate r the metric of 2-sphere of radius r is in question.

One can have 3-surfaces in $\delta_{\pm}CD \times CP_2$ with non-degenerate 3-metric by assuming that CP_2 coordinates depend on the coordinates of $\delta_{\pm}CD$ - that is light-cone boundary. If CP_2 coordinates depend on r only, the induced metric is still rotationally symmetric, and the induced metric reads as

$$ds^2 = g_{rr} dr^2 - r^2 d\Omega^2 , \quad g_{rr} = s_{kl} \frac{ds^k}{dr} \frac{ds^l}{dr} .$$

For $g_{rr} = -1$ one obtains flat metric of E^3 . This condition has a huge number of solutions since three CP_2 coordinates can be chosen to be almost arbitrary functions of r and the fourth one can be solved from the condition for the metric. The restrictions come only from the condition $g_{rr} = -1$ combined with the Euclidian character of CP_2 metric. The simplest solution is obtained by taking the CP_2 projection to be a geodesic circle so that one obtains $r = \Phi/R$ indeed giving $g_{rr} = -1$.

One can obtain also a deformation allowing decomposition of the icosahedron to regular tetrahedrons by modifying the basic condition to $g_{rr} = -k^2$, $k = 1 + \delta$. It is however not obvious whether this deformation can be continued to a 4-surface with vanishing Einstein tensor. A natural continuation of the 3-surface at light-cone boundary to a 4-D space-time surface is obtained by using a slicing of the future light-cone by parallel light-cones along time-like line and having identical 3-metric. Since the coordinate r corresponds to a light-like coordinate v in the pair of $(u = t - r, v = t + r)$ of the standard light-like coordinates of M^4 , the line element would be

$$ds^2 = 2dudv - k^2 dv^2 - r^2 d\Omega^2 ,$$

and Einstein tensor vanishes for a constant value of the parameter k also now.

The deformations of standard imbeddings of E^3 and M^4

One can also consider the deformation of the standard imbedding of E^3 as $t = \text{constant}$ hypersurface of M^4 obtained by decomposing E^3 to icosahedra consisting of 20 irregular tetrahedra. Also now one can deform the imbedding near the center of each icosahedron so that the radial edges have same length as the surface edges. One starts from the metric of E^3

$$ds^2 = -dr^2 - r^2 d\Omega^2 ,$$

and deforms it to

$$ds^2 = -k^2(r)dr^2 - r^2d\Omega^2 . \quad (11.2.10)$$

For small deformations one has $k = +\epsilon(r)$. The deformation is of the same form as before and satisfies the conditions:

$$s^k = s^k(r) , \quad s_{kl} \frac{ds^k}{dr} \frac{ds^l}{dr} = 1 - k^2(r) = -2\delta(r) - \delta^2(r) , \quad \int \delta(r)dr = \epsilon \simeq .05 . \quad (11.2.11)$$

In this case the icosahedral Penrose tiling is essentially identical with the standard one except for the modification of the metric near the center of the icosahedron. Besides this k must satisfy also the differential equation deduced in Appendix B.

This metric can be generalized to a deformation of M^4 metric by adding the time coordinate so that one has

$$ds^2 = dt^2 - k^2(r)dr^2 - r^2d\Omega^2 . \quad (11.2.12)$$

Deformation of E^3 to hyperbolic space H^3

One can also consider a deformation of M^4 replacing E^3 hyperbolic 3-space H^3 .

- (a) In this case the imbedding, induced metric, and conditions on it are given by the following equations:

$$\begin{aligned} m^0 &= \Lambda t + h(u) , & \Phi &= f(u) + \omega t , & u &= \frac{r}{R} , \\ g_{tt} &= \Lambda^2 - R^2\omega^2 = 1 , & g_{rr} &= -1 - \left(\frac{df}{du}\right)^2 + \left(\frac{dh}{du}\right)^2 = -\frac{1}{1+r^2} , & g_{tr} &= -R\omega_1 \frac{df}{du} + \Lambda \frac{dh}{du} = 0 . \end{aligned} \quad (11.2.13)$$

- (b) The solution to the conditions reads as

$$\Lambda^2 = 1 - R^2\omega^2 , \quad h = \frac{R\omega_1}{\Lambda} f(u) , \quad f(u) = f_0 + \frac{1}{2}(1 - (\omega_1 R/\Lambda)^2)^{-1/2} \log\left(\frac{1+r^2}{1+r_0^2}\right) \quad (11.2.14)$$

The deformation is well-defined everywhere. There exists actually infinite number of deformations of this kind since the geodesic circle can be replaced with an almost arbitrary curve of CP_2 .

What about corrections to g_{tt} component of the stationary metric?

What about g_{tt} component of the metric? Should it be given in the Newtonian approximation $g_{tt} = 1 - 2\phi_{gr}$. This looks reasonable. The correction has several consequences. The 1+1+2 decomposition would be replaced with 2 + 2 decomposition, the g_{tt} metric would be slightly modified, and the imbedding to CP_2 must be replaced with 2-D vacuum extremal. Homologically trivial geodesic sphere $S^2 \subset CP_2$ would provide the simplest imbedding as a vacuum extremal, and the imbedding is of the same form as that for H^3 metric already discussed

$$m^0 = \Lambda t + h(u) , \quad \Theta = \Theta(u) , \quad \Phi = f(u) + \omega t , \quad u = \frac{r}{R} , \quad (11.2.15)$$

giving

$$\begin{aligned}
 g_{tt} &= \Lambda^2 - R^2 \omega^2 \sin^2(\Theta) \omega^2 = 1 + 2\Phi_{gr} \quad , \quad g_{rr} = -1 - \sin^2(\Theta) \left(\frac{df}{du} \right)^2 + \left(\frac{dh}{du} \right)^2 - \left(\frac{d\Theta}{du} \right)^2 = -\frac{1}{1-(r/R)^2} \quad , \\
 g_{tr} &= -R\Lambda\omega \sin(\Theta) \frac{df}{du} + \Lambda \frac{dh}{du} = 0 \quad , \quad \Phi_{gr} = K(u^2 - u_0^2) < 0 \quad , \\
 K &= nGR^2\rho \quad .
 \end{aligned}
 \tag{11.2.16}$$

n is a numerical constant. Note that the sign of Φ_{gr} should be negative as a sum of negative Coulomb contributions and the additive constant $u_0^2 > 1$ not affecting Newton's equations guarantees this for S^3 . The deviation of g_{tt} from flat metric is however very small in general.

The condition on g_{tt} gives

$$\sin^2(\Theta) = \frac{\Lambda^2 - 1 + 2K(u^2 - u_0^2)}{R^2\omega^2}$$

so that the imbedding fails at certain radii r corresponding to $\sin^2(\Theta) = 0$ and $\sin^2(\Theta) = 1$. $u = 1$ could correspond to $r = R$ and to $\sin^2(\Theta) = 1$ and $u = 0$ to $\sin^2(\Theta) = 1$.

In the hyperbolic case the sign of T^{tt} is negative which suggests that the sign of K in Φ_{gr} is also opposite so that gravitational attraction would transform to repulsion. This can make sense only if the topologically condensed matter corresponds to the negative energy part of zero energy state with non-standard arrow of geometric time. Also now the imbedding fails above some critical value of u^2 .

What is remarkable that the deviation of the 3- metric from that of E^3 can be large although the effect on geodesic lines with small average radius r is very small since the non-constancy of g_{rr} becomes visible only when the radial velocity dr/dt is non-vanishing. For instance, the deviation of g_{rr} from its expression in flat or Schwarzschild metric does not effect at all circular geodesic lines which are determined by g_{tt} . Hence one can imagine the possibility of having large gravitational effects on 3-metric not visible as large gravitational binding energies.

The cold shower is encountered when one assumes Einstein's equation for the mass density responsible for

$$\rho = T_t^t \simeq \frac{R_3}{16\pi G} = \frac{3}{8\pi GR^2} = \frac{3M}{2\pi R^3} \quad .
 \tag{11.2.17}$$

This gives $R = 4GM = 2r_S$, r_S the Schwarzschild radius, which is extremely small distance unless the density of the topologically condensed matter is huge.

In TGD framework one way out of the problem could be based on the fact that both G and Λ_i are predictions rather than fundamental constants in TGD framework. If one accepts this, one can consider the possibility that $G \sim R/M$ holds true. In fact, I have proposed for a long time ago [K85, K58] a formula for G in terms of p-adic length scale L_p and exponential of Kähler action for CP_2 type vacuum extremals as

$$G = \frac{L_p^2}{\hbar} \exp(-S_K(CP_2)) = \frac{1}{\hbar} p R_{CP_2}^2 \exp(-S_K(CP_2)) \quad .
 \tag{11.2.18}$$

Here R_{CP_2} denotes the length of CP_2 geodesic circle. For $p = M_{127} = 2^{127} - 1$ - the Mersenne prime characterizing electron and the largest Mersenne prime, which does not correspond to a completely super-astrophysical length scale - one obtains the Newtonian value of G [K85, K58].

The Kähler action assignable to the deformation of CP_2 type vacuum extremal corresponds to the generalized line of Feynman diagram assignable to graviton. S_K can vary due to the

finite length of the line so that a full vacuum extremal is not in question as well as due to the deformation of the extremal. The exponential dependence on S_K can give rise to a huge variation range of G , and in the extreme situation one G and be near to the the upper bound $G_{max} = L_p^2/\hbar$. $G = G_{max}/2n$ $M \simeq n\hbar/L_p$ would give $R = L_p = \hbar/M$. This would make sense in hadronic, nuclear and condensed matter length scales. I have indeed proposed that hadronic string tension has interpretation in terms of $G \sim L_p^2$: the interpretation would be in terms of strong gravitation made possible by spin 2 meson exchanges. I have also proposed that fractally scaled up variants of QCD like theory of strong interactions appear in biological length scales [K7] so that also strong gravity would appear in these length scales.

The above approximate construction has certain ad hoc character. The dependence of g_{tt} on r can be however constrained by requiring 1+1+2 of Einstein tensor such form $G_i^{\alpha\beta}$ having the form $\Lambda_i g_i^{\alpha\beta}$, $i = 1, 2$ and has a vanishing divergence. As a result one obtains a differential equation for the gravitational potential Φ_{gr} .

The differential equation for $G^{tt} = \Lambda_1 g^{tt}$ is trivially satisfied due to time translational invariance. The integration of the differential equation for G^{rr} gives at the first step

$$\begin{aligned} G^{rr} &= \frac{C}{g_{rr}g_{tt}} \equiv -\frac{C}{AB} , \\ g_{tt} &= B , \quad g_{rr} = -A . \end{aligned} \quad (11.2.19)$$

The expressions for G^{rr} and other components of Einstein tensor [K85] are

$$\begin{aligned} G^{rr} &= \frac{1}{A^2} \left(-\frac{\partial_r B}{Br} + \frac{(A-1)}{r^2} \right) , \\ G^{\theta\theta} &= \frac{1}{r^2} \left[-\frac{\partial_r^2 B}{2BA} + \frac{1}{2Ar} \left(\frac{\partial_r A}{A} - \frac{\partial_r B}{B} \right) \right. \\ &\quad \left. + \frac{\partial_r B}{4AB} \left(\frac{\partial_r A}{A} + \frac{\partial_r B}{B} \right) \right] , \\ G^{tt} &= \frac{1}{AB} \left(-\frac{\partial_r A}{Ar} + \frac{(1-A)}{r^2} \right) . \end{aligned} \quad (11.2.20)$$

The above equation for G^{rr} gives the differential equation

$$2\frac{dB}{du} + \frac{CA}{B} = \frac{(A-1)}{u} , \quad u = r^2 . \quad (11.2.21)$$

If gravitational potential $2\Phi_{gr} = B - 1$ is given one can solve $A - 1$ from this equation purely algebraically and obtains spherically symmetric metric.

For the S^3 ($k = 1$) and H^3 ($k = -1$) metric one has

$$A - 1 = \frac{1}{1 - kv} - 1 = \frac{kv}{1 - kv} , \quad v = \frac{u}{R^2} .$$

One obtains

$$\frac{dB}{dv} + \frac{CR^2}{2B}(1 + kv) = \frac{k}{1 - kv} . \quad (11.2.22)$$

Near origin $kvu \simeq 0$ holds true in the first approximation. This gives the approximate expression

$$B = 1 + B_1 \log\left(\frac{B + B_1}{1 + B_1}\right) + \frac{r^2}{R^2}, \quad B_1 = \frac{CR^2k}{2}. \quad (11.2.23)$$

Apart from the slowly varying logarithmic term $g_{tt} = B$ is of the same form as Newtonian approximation would predict. Note that the result is same for both $k = 1$ and $k = -1$. Near $r = R$ the right-hand side diverges for $k = 1$ and implies logarithmic behavior

$$B \simeq B_0 - \frac{k}{2} \log\left(\frac{1 - kv}{1 - kv_0}\right). \quad (11.2.24)$$

For S^3 the metric therefore develops Euclidian signature. For $k = -1$ the g_{tt} becomes very large for large values of r so that the imbeddability to $M^4 \times CP_2$ eventually fails. The results suggests that for both S^3 and H^3 metric expansion is necessary.

Constant deformation does cannot give a decomposition of icosahedron to 20 regular tetrahedrons

At the first glimpse the most attractive option from TGD point of view is $k = 1 + \delta$, where δ is constant in the entire region but one must demonstrate that for a suitable choice of the value of δ the lengths of radial and surface geodesics are identical. As shown in Appendix C, it is possible to express the condition fixing the angular distance $\Delta\phi$ between neighboring vertices of icosahedron and the equality $s = k$ of the radial and surface edge lengths in terms of elementary functions. It however turns out that the only solution to the conditions is $k = \infty$. The interpretation is following. As k giving the length of the radial edge increases, also the length of the surface edge increases and does it so fast that infinite value of k is required to obtain equality.

One however obtains an infinite family of deformations for which $k(r)$ is not constant. In TGD framework k satisfies the differential equations deduced in Appendix B. As a special case one obtains deformations transforming piece of E^3 to a piece of S^3 .

11.2.4 Cosmic honeycombs?

The deformed metric still possesses the crucial $SO(3)$ symmetry. Translational symmetry is lost but the loss can be located near the center of inside each icosahedron. Icosahedral Penrose tiling must be constructed by gluing together disjoint 3-surfaces along the faces of the icosahedra. Also intersections of icosahedra and therefore also tetrahedrons must be allowed. Since the correction to the radial distances comes from the region near the center of the icosahedron, the construction of icosahedral Penrose tiling for E^3 option proceeds just as it does usually.

For light-cone boundary option the basic icosahedron is replaced by the 2-D outer boundary of solid icosahedron expanding with light velocity in M^4 . In 2-D case a simple analogy would be the replacement of triangle with the boundary of expanding triangle: one just draws the center point of triangle so that one obtains cone with triangular cross section. The expanding icosahedra start expansion simultaneously in $t = 0$ hyperplane. At $t = t_0$ some of them meet along common face and some of them start to intersect already earlier. After this the resulting state would be a fusion of the icosahedra to 3-D Penrose tiling which do not expand anymore.

A possible cosmological application would be an explanation for the honeycomb structure in scales of 10^8 light years. Galaxies seem to be concentrated on approximately spherical surfaces of about this radius known as cosmic voids [E55]. One can imagine three options depending on whether one assigns to the local cosmology sub-critical, critical, or over-critical mass density in these scales (this is of course the GRT based interpretation). If one accepts the TGD based interpretation based on the modification of Einstein equations discussed in Appendix A, the cosmic voids would be genuine vacua in good approximation.

TGD allows also the option for which these voids carry Kähler energy having interpretation as dark energy. I have indeed proposed that the magnetic energy of Kähler magnetic flux tubes could be identified as dark energy. What makes the situation difficult is that both vacuum and non-vacuum options can give rise to accelerated cosmic expansion so that for vacuum option no dark energy would be needed. Note also that for critical and sub-critical vacuum option non-trivial long range gauge fields - in particular electromagnetic fields - are present in the vacuum. This is somewhat frustrating: I had already thought that the issue of dark energy is finally resolved in TGD framework!

All these honeycomb like structures could be realized in TGD by gluing together pieces of H^3 , E^3 or S^3 .

- (a) For TGD inspired interpretation these cosmologies are vacua and therefore also the voids identifiable as pieces of these cosmologies. The discontinuities of the normal component of metric g_{nn} at 3-D gluing regions would give rise to surface mass densities providing idealization for the mass carried by galaxies (Einstein tensor involves derivatives of metric).
- (b) For the standard interpretation these cosmologies carry a mass density perhaps identifiable as dark energy density besides the mass densities related to the discontinuities of g_{nn} at the facets at which gluing takes place.
- (c) The earlier TGD based interpretation would be that the small deformations of the cosmology manifested as particles would give rise to average energy momentum tensor satisfying Einstein's equations.

In TGD framework these options differ from each other only in that $a = \text{constant}$ hyperboloid is deformed in different manner in CP_2 directions.

- (a) There are infinite number of hyperbolic tessellations. If one requires interpretation in terms of Platonic solids there are only a finite number of tessellations (honeycombs) given in Schönflies notation by $(6, 3, 3)$, $(5, 3, 4)$, $(6, 3, 4)$, $(4, 4, 3)$, $(4, 3, 5)$, $(3, 5, 3)$, $(5, 3, 5)$, $(6, 3, 5)$. Also icosahedral and dodecahedral honeycombs $(3, 5, 3)$, $(5, 3, 3)$ and $(5, 3, 4)$ are present. Hyperbolic cosmologies are sub-critical and cosmic time evolution is not constrained by the imbedding since CP_2 projection is 1-dimensional.
- (b) 3-D icosahedral Penrose tiling or icosahedral QCin flat E^3 (by CMB data cosmology is flat in good approximation in large enough scales but is 10^8 light years large enough scale?). CP_2 projection is 2-D and time evolution which completely fixed apart from a parameter characterizing its finite duration before singularity, which in TGD framework as interpretation as a blackhole like space-time region having Euclidian signature of the induced metric.
- (c) Over-critical local cosmology and gluing together in similar manner hemi-3-spheres along their 2-D equators giving rise to 600-cells consisting of tetrahedrons. Maybe tetrahedron is too simple an object to serve as the basic unit of the cosmic honeycomb. Or perhaps a counterpart of icosahedral Penrose tiling could be obtained. Also now time duration fixed completely about from its finite duration before singularity.

It is somewhat frustrating to find, that it is difficult to distinguish experimentally between GRT in which Einstein's equations with cosmological constant characterizing genuine density of matter assignable to the vacuum expectation values of inflaton type fields on one hand, and Einstein equations introducing cosmological constant as purely gravitational parameter. In TGD framework even more general modifications are possible and treat cosmological "constants" as parameters characterizing vacua.

11.2.5 Does the replacement $E^3 \rightarrow S^3$ make sense quantum mechanically?

A possible quantum mechanical sensibility test for the S^3 deformation is based on the quantum motion of a test particle in S^3 metric replacing free motion in E^3 metric when one has two-sheeted representation of S^3 . If only a piece of S^3 is considered, the situation is more complex since the solutions must be restricted to a piece of S^3 .

The first thing to notice is that S^3 geometry requires mass density which is constant being proportional to the curvature scalar R_3 . The energy density is given by $T^{tt} = \kappa G^{tt} = -\kappa g^{tt} R_3/2$. R_3 is negative since the sign of 3-metric is negative so that positive energy density is obtained. For hyperbolic stationary case the energy density would be negative, and this might exclude this option unless one can assign this energy density with negative energy parts of zero energy states. Note that in cosmology the situation changes since R_{tt} is non-vanishing. This kind of distinction between positive and negative energy states at space-time level would be rather dramatic.

One could assign constant mass energy density to large enough atomic nuclei, to condensed matter systems involving many enough atoms such as the water molecule clusters to be discussed later, and also to gases, liquids, and solids. This is natural if the length scale resolution of the description does not allow to distinguish the basic building blocks. These criteria are not satisfied for systems such as single atom.

- (a) The situation is $SO(4) = SO(3) \times SO(3)$ symmetric and the configuration space is isomorphic with the configuration space $SO(3)$ of a rigid body. One can also consider the possibility of rigid body with half-odd integer angular momentum made possible if one replaces $SO(3)$ with its covering group in both factors of $SO(4)$. For $SO(3)$ only integer values $J = 0, 1, 2, \dots$ are allowed whereas $SU(2)$ allows half integer values $J = 0, 1/2, 1, \dots$. An interesting question is whether one should allow purely geometric half-odd integer spin which does not reduce to ordinary half-odd integer spin. The so called orientation entanglement relation allows to visualize geometrically the fact that 2π rotation is not homotopically trivial whereas 4π rotation is. This might justify the allowance of also half integer values of J .
- (b) The transition from free linear motion to free rotational motion means that momentum eigenstates with 3-momentum p_i are replaced with angular momentum eigenstates with angular momentum J and two spin components K, L corresponding to angular momentum projections for the two commuting factors of $SO(4)$, which both vary in the range $-J, -J+1, \dots, J$, and therefore have $2J+1$ values. The Laplace operator replacing momentum square is just angular momentum squared and has eigenvalues $J(J+1)$ with degeneracy $(2J+1)^2$.
- (c) The states correspond to unitary irreducible representations of $SO(4) = SO(3) \times SO(3)$ or its covering group $Spin(4) = SU(2) \times SU(2)$ in the group algebra of $SO(3)$ or of its covering $SU(2)$. By general theorems the group algebra of any compact group decomposes to a direct sum of unitary irreducible representations contains all representations such that n -dimensional representation occurs n times. This can be understood as decomposition of the representation of group element g to a direct sum of $n \times n$ matrices belonging to various irreducible representations. For $SU(2) \times SU(2)$ one obtains all angular momenta $J = 0, 1/2, 1, \dots$ with $(2J+1)^2$ -fold degeneracy. If both both half-odd integer and integer values of J are allowed, the degenerates are given by $n^2 = (2J+1)^2 = 1, 2^2, 3^2, 4^2$ and same as for hydrogen atom.
- (d) In non-relativistic approximation for energy as $E - m \equiv p^2/2m$, with $E \rightarrow i\partial_t$ and $p_i \rightarrow iD_i$ and $p_i p^i \rightarrow g^{ij} D_i D_j$ one obtains Schrödinger equation for a test particle as

$$i \frac{\partial \Psi}{\partial t} = E \Psi = \frac{1}{2mR^2} \nabla_{S^3}^2 \Psi, \quad \nabla_{S^3}^2 = D^i D_i \tag{11.2.25}$$

The energies are given by $E_J = J(J+1)/I$, $I = 2mR^2$, and identical to those of a spherically symmetric rigid body with moment of inertia $I = mR^2$. The scale of energy is given by the radius of S^3 . In atomic length scale the estimate for the radius would be size of the atom. This would give energy, which is of the same order of magnitude as zero point kinetic energy of free particle in same volume so that there are no obvious contradictions with existing physics.

- (e) Could S^3 geometry for free nucleons serve as an alternative for nuclear shell model based on harmonic oscillator Hamiltonian? In shell model single particle energies are $E_n = nE_0$ and such that even/odd integer valued angular momenta $J \leq n$ correspond to given n ($SU(3)$ dynamical symmetry). The harmonic oscillator model predicts correctly the nuclear magic

numbers as 2, 8, 20, 28, 50, 82, 126, 184. For S^3 option the energies would be concentrated on shells with $E_J = J(J+1)E_0$. Now magic numbers would correspond to full shells with $(2J+1)^2 = n^2$ states on each just as in the case of atoms in the first approximation. The magic numbers would be 2, 10, 28, 60, 92, .. and not consistent with the experimental ones. Harmonic oscillator Hamiltonian in S^3 geometry however makes sense and predicts splittings of the harmonic multiplets.

- (f) What happens for free motion if only a finite piece of S^3 is allowed? The simplest situation corresponds to $r = \sin(\alpha) = R_1 < R$. The normal derivatives of wave functions should vanish at $r = R_1$ in order to have conservation of probability. The wave functions are matrix elements $D_{J,K,L}(\alpha, \theta, \phi)$ and can be expressed as products of wave functions assignable to the Euler angles α, θ, ϕ . For α the wave function $R_{J,K,L}(\alpha)$ is the S^3 analog of Legendre polynomial $P_{l,m}(\theta)$. The simplest manner to satisfy the boundary conditions is to assume that only those partial waves in S^3 satisfying $dR_{J,K,L}(\alpha)/d\alpha = 0$ for $\alpha = \arcsin(R_1/R)$ are allowed. This leads to a quantization of R_1/R and selection of only some values of (J, K, L) .

If both both half-odd integer and integer values of J are allowed the degenerates are given by $n = (2J+1) = 1, 2^2, 3^2, \dots$ and are same as for hydrogen atom. For spherically symmetric harmonic oscillator appearing in the model of atomic nucleus only even or odd angular momenta are allowed: in this case $SU(3)$ is the dynamical symmetry which happens to be isometry group of CP_2 .

- (a) The exceptionally large degeneracy of energy eigenstates in Coulomb and harmonic oscillator potentials is due to a dynamical symmetry. Besides angular momentum also so called Runge-Lenz vector is conserved in Coulomb potential (so called generalized conserved Runge-Lenz vector can be defined for all central forces). In fact, the motion in Coulomb potential is group theoretically equivalent to the free motion of a particle in S^3 ! The conserved Runge-Lenz vector is given by $A = p \times L + mke$, where e is radial unit vector at the orbit orthogonal to angular momentum L and p is 3-momentum. Note that $A \cdot L = 0$ holds true. By dividing this with conserved quantity $1/\sqrt{2mE}$ one obtains an operator D with dimensions of angular momentum. The ordinary angular momentum L and D generate $SO(4)$ Lie algebra and the first Casimir operator $C_1 = L^2 + D^2$ for this algebra equals to $mk^2/|E|$. $E \propto 1/n^2$ implies that eigenvalues of S^3 Laplacian are proportional to $C_1 - Id$ and thus proportional to $n^2 - 1 = (2J+1)^2 - 1$. The eigenvalues of C_2 are given by n^2 with $n = 2J+1, J = 0, 1/2, 1, \dots$. As already noticed, second Casimir operator $C_1 = L \cdot D$ vanishes for the orbits in Coulomb potential.
- (b) Could the reduction of the motion Coulomb potential to free particle motion in S^3 be more than a mere mathematical curiosity? The relationship $C_1 = -mk^2/H_{Coul}$ between C_1 and Hamiltonian $H_{Coul} = \hbar^2 \nabla^2 / 2m + V(r)$ transforms to

$$H_{S^3} = \frac{\hbar^2 J(J+1)}{2mR^2} = \frac{\hbar^2}{2mR^2} (n^2 - 1) = \frac{\hbar^2}{2mR^2} \left(-\frac{mk^2}{H_{Coul}} - 1 \right) . \quad (11.2.26)$$

The relationship looks rather artificial and one can argue that the connection is purely group theoretical and cannot have a genuine geometric meaning.

- (c) In the case of atom S^3 geometry is not well-motivated. One can still look what happens if one replaces E^3 geometry with S^3 geometry. Coulomb potential has a well-defined S^3 counterpart. The straightforward generalization of Coulomb potential energy to $V(r) = -k/r$, $r = \sin(\alpha)$ is well-defined. It however replaces the singularity at origin with singularities at North and South poles of S^3 unless one considers only a piece of S^3 . Physically one would have two-sheeted structure with nucleus at both North and South poles. $SO(4)$ symmetry is reduced to $SO(3)$ symmetry, and is expected to induce the splitting of the energies of states with different values of J but same value of n . Near $r = 0$ the metric is in a good approximation flat so that for states with small n one does not expect large deviations from E^3 and perturbation theoretical treatment using $g^{rr} = 1/(1 - (r/R)^2) \simeq 1 + \frac{r^2}{R^2}$ should make sense. For states of atom with $r_n = (a_0/Z^2)n^2 \leq R$, $a_0 = \hbar/\alpha m_e \simeq .53 \times 10^{-10}$ m,

this approximation should be good. For the values of $n > Z^2(R/a_0)$ the deviations from E^3 metric are certainly since the first node of the E^3 radial wave function would be at radius $r > R$.

In principle the effects on the energy eigenvalues of hydrogen atom could be used to derive a lower bound on the value of R if hydrogen atom space-time sheet correspond locally to S^3 (which it very probably does not!). The splitting of states with same n but different values of j can be compared to the splitting predicted by Dirac equation and given exactly by the Sommerfeld formula. The approximate expression for the relativistic splitting reads as

$$\frac{\Delta E_{n,j}}{E_n} \simeq \frac{\alpha^2}{n^2} \times \frac{n}{j + \frac{1}{2} - \frac{3}{4}} .$$

This splitting can be compared with the order of magnitude estimate for the correction coming from S^3 geometry in the lowest order approximation obtained as $g^{rr} = 1 - (r/R)^2$ in the Laplacian:

$$\begin{aligned} \frac{\Delta E_{n,l}}{E_n} &= -\left\langle \left(\frac{r}{R}\right)^2 \frac{T_r}{E_n} \right\rangle_{n,l} , \\ \left\langle \left(\frac{r}{R}\right)^2 T_r \right\rangle_{n,l} &= \left\langle \frac{\hbar^2 \partial_r^2}{2m_e} \right\rangle_{n,l} = -\left\langle \left(\frac{r}{R}\right)^2 \left[E_n - \frac{\hbar^2 l(l+1)}{2m_e r^2} - V(r) \right] \right\rangle_{n,l} \\ -\left\langle \left(\frac{r}{R}\right)^2 T_r \right\rangle_{n,l} &= -\left(\frac{a_n}{R}\right)^2 \left[\langle \rho_n^2 \rangle_{n,l} + \frac{l(l+1)}{n^2} + \frac{2\pi}{\alpha^2} \langle \rho_n \rangle_{n,l} \right] \\ \rho_n &= \frac{r}{a_n} , \quad a_n = n^2 a_0 , \quad a_0 = \frac{\alpha \hbar}{m_e} , \quad E_n = \frac{\alpha}{2a_n} . \end{aligned} \quad (11.2.27)$$

The expectation values of ρ_n and ρ_n are of order unity since ρ_n appears as a natural variable in radial wave functions. The condition $R > n^3 a_0 / \alpha$ guarantees that the splittings are smaller than given by the Sommerfeld formula. Already for $n = 1$ this would give $R > 137 a_0$, which is of order .5 nm.

11.3 Appendix A: Does TGD force a modification of Einstein equations?

The discovery of preferred extremals [K94, K11] meant a decisive breakthrough in TGD. One of the implications was that Kähler energy momentum tensor must have a vanishing divergence for the preferred extremals. Einstein-Maxwell equations with cosmological term given by

$$T^{\alpha\beta} = \kappa G^{\alpha\beta} + \Lambda g^{\alpha\beta} . \quad (11.3.1)$$

guarantee this automatically. In TGD framework $T_\alpha^\alpha = 0$ implies that curvature scalar is constant. This implication seems to be too strong. One ends up with problems also with Robertson-Walker cosmologies realized as vacuum extremals if one regards them as limiting cases of preferred extremals. These observations suggest that the condition of Eq. 11.3.4 is un-necessarily strong. This is indeed the case, and a more general condition leads to appearance of several parameters analogous to cosmological constant but not being genuine constants. Even this generalization might be un-necessarily strong and minimalist could argue that just the vanishing of the divergence of Kähler energy momentum tensor might serve as the TGD counterpart of Einstein's equations and Equivalence Principle.

11.3.1 Does TGD allow several cosmological "constants"?

The introduction of cosmological constant need not be the only solution of the vanishing of the covariant divergence of T_K . If the preferred extremals have special symmetries, one can satisfy the condition by replacing cosmological term $\Lambda g^{\alpha\beta}$ with a more general term:

$$T^{\alpha\beta} = \kappa G^{\alpha\beta} + \sum_i \Lambda_i P_i^{\alpha\beta} . \quad (11.3.2)$$

Here P_i are identified as projectors to orthogonal sub-spaces of the tangent space of the space-time surface. The distributions of these sub-spaces are assumed to be integrable and define d_i -dimensional sub-manifolds of space-time surface with $\sum d_i = 4$. The maximally symmetric situation corresponds to the canonical imbedding of M^4 with $d_i = 1$.

The condition that energy momentum tensor is divergenceless is satisfied if one has

$$D_\beta(\Lambda_i P_i^{\alpha\beta}) = 0 .$$

Λ_i need not be constant functions anymore so that cosmological constant is replaced by two or more - presumably slowly varying - cosmological "constants". For $\Lambda_i = \Lambda$ one obtains just ordinary cosmological constant which must be genuine constant.

Two remarks are in order.

- (a) This generalization of the notion of cosmological does not make sense in GRT framework, where Einstein equations are deduced from a variational principle but do so in TGD framework where they characterize preferred extremals and are deduced from the vanishing of covariant divergences of Kähler-Maxwell energy momentum tensor. In TGD framework the acceptance of two cosmological "constants" is just acceptance of TGD and forcing only single one would be too strong ad hoc assumption. In GRT situation would be completely opposite.
- (b) It should be also noticed that the proposed modification is not physically equivalent to the assumption that cosmological constant characterizes the energy momentum tensor assignable to vacuum expectation values of Higgs like fields (inflaton field). In this case one would have ordinary Einstein equations without cosmological term but energy momentum tensor containing the additional terms:

$$\kappa G^{\alpha\beta} = T^{\alpha\beta} - \sum_i \Lambda_i P_i^{\alpha\beta} . \quad (11.3.3)$$

The physical interpretation of these two options is totally different.

11.3.2 Preferred extremals suggest a generalization of Einstein's equations

There is actually support for the generalization of Einstein's equations in TGD framework.

- (a) The preferred extremals possessing Hamilton Jacobi structure in Minkowskian regions indeed have the needed 2+2-decomposition of the tangent space to 2 longitudinal and 2 transversal degrees of freedom. The distributions of these tangent spaces are integrable. Physically longitudinal and transversal degrees of freedom correspond to light-like momentum and orthogonal polarization for the preferred extremals. Also number theoretical vision leads to similar 2+2 decomposition of the quaternionic tangent space. Similar 2+2 decomposition occurs for string like objects. In Euclidian regions Hamilton-Jacobi structure is replaced with complex structure in 4-D and also in this case this kind of decomposition

is possible but need not be so unique. The standard Eguchi-Hanson complex coordinate for CP_2 define this kind of decomposition.

Therefore it would be very natural to assume that the energy momentum tensor has the decomposition given by Eq. 11.3.5. This would quite generally suggest 2+2 decomposition.

11.3.3 Also vacuum extremals suggest a generalization of Einstein's equations

The vacuum extremals of Kähler action are expected to be very important piece of TGD since their small deformations are expected to give rise to physical non-vacuum extremals. These extremals have vanishing induced Kähler field but they are not vacua in gravitational sense. One can hope that at least some class of these vacuum extremals could allow a realization as limits of non-vacuum preferred extremals and would therefore satisfy a generalization of Einstein's vacuum equations.

One cannot be make these solution gravitational vacua by introducing cosmological constant so that one would have

$$\kappa G^{\alpha\beta} + \Lambda g^{\alpha\beta} = 0 . \quad (11.3.4)$$

One can however consider more general equations

$$\begin{aligned} \kappa G^{\alpha\beta} &= - \sum_i \Lambda_i P_i^{\alpha\beta} , \\ D_\beta(\Lambda_i P_i^{\alpha\beta}) &= 0 . \end{aligned} \quad (11.3.5)$$

Especially interesting vacuum extremals are defined by the imbeddings of Robertson-Walker cosmology [K73].

- (a) Robertson-Walker cosmologies for sub-critical, critical, and over-critical mass density correspond to 3-space, which is constant curvature space. For negative curvature one has hyperbolic space H^3 , for vanishing curvature Euclidian 3-space E^3 , and for positive curvature 3-sphere S^3 . The metric in these three cases is given by

$$ds^2 = g_{aa} da^2 - a^2 \left(\frac{dr^2}{1+kr^2} + r^2 d\Omega^2 \right) , \quad (11.3.6)$$

where $k = 1, -, 0, 1$ corresponds to H^3, E^3, S^3 .

- (b) All these cosmologies are imbeddable to $M^4 \times CP_2$.
- i. For H^3 signature the imbedding is obtained by assuming almost arbitrary 1-D CP_2 projection with CP_2 coordinates arbitrary functions of cosmic time a defined by M^4 light-cone proper time: $s^k = f^k(a)$. $a = \text{constant}$ surfaces correspond to hyperboloids of future light-cone $M^4_+ \subset M^4$.
 - ii. For E^3 and S^3 one must assume that CP_2 projection is 2-dimensional. The simplest option corresponds to a CP_2 projection which is homologically trivial geodesic sphere $S^2 \subset CP_2$ with vanishing induced Kähler form. Denoting by (Θ, Φ) the coordinates of $S^2 \subset CP_2$, the imbedding must be of form

$$\sin(\Theta) = \frac{a}{\tau} , \quad \Phi = f(r) . \quad (11.3.7)$$

The dependence of Θ on cosmic time is dictated by the condition that the contribution of $\sin^2(\Theta)(\partial_r \Phi)^2$ is proportional to a^2 . $f(r)$ is fixed from the condition that one obtains $k = 0$ or $k = -1$ meaning that hyperbolic metric of 3-space transforms to Euclidian or spherical one by deformation in CP_2 directions. The resulting cosmologies have only their duration τ as a free parameter [K73].

Euclidian and spherical cosmologies end up with singularity as the induced metric transforms to Euclidian signature. In TGD framework, where blackholes like objects corresponds to space-time regions with Euclidian signature, the interpretation would be in terms of blackhole collapse. What is interesting is that the "pressure" in Einstein tensor is negative so that one obtains accelerated cosmic expansion for critical mass density.

- (c) For these cosmologies 1+3 decomposition of the tangent space looks more natural than 2+2 decomposition. 1+3 decomposition corresponds to the decomposition of Einstein's tensor to $G = \rho P_1 - p P_3$, where $P_1 \leftrightarrow g^{aa}$ projects to the direction of cosmic time a and $P_3 \leftrightarrow g_3^{ij}$ to 3-space $a = \text{constant}$. It is easy to see that $p g_3^{ij}$ has vanishing divergence and Einstein's equations implies that also ρP_1 does so. This does not conform with the idea that Hamilton-Jacobi structure dictates the decomposition, which would therefore be 2+2. If this is really true, then one expects a second family of solutions for which one has 1 + 3 decomposition of the tangent space. Maybe the conjectured quaternionic space-time surfaces could correspond to this family of preferred extremals. The earlier conjecture has been that preferred extremals with Hamilton-Jacobi structure are equivalent with quaternionic ones.

Note that this kind of decomposition takes place for the deformation of E^3 or equivalently M^4 discussed above. One must deduce the conditions under which the divergence free decomposition holds true. This must pose a differential equation on $k(r)$.

One can also ask what the situation is for Schwarzschild metric and Reissner-Nordström metric. For Schwarzschild metric Einstein tensor vanishes so that $\Lambda_i = 0$ holds true trivially. A little calculation shows that for Reissner-Nordström metric Einstein tensor has the decomposition $E^2 g_1 - E^2 g_2$, where g_1 and g_2 are the projectors to (t, r) plane and (θ, ϕ) sphere. $E^2 = Q^2/r^4$ implies that the conditions $D_\beta(\Lambda_i P_i^{\alpha\beta}) = 0$ cannot be satisfied.

11.3.4 What could the modification of Einstein's equations mean from the point of view of dark energy?

The modification of Einstein's equations has highly non-trivial implications concerning the notion of dark energy. In GRT based interpretation cosmological constant does not correspond to energy density whereas in the models assigning it to vacuum expectations of Higgs like inflaton fields a genuine energy density is in question: this allows the variation of cosmological constant with time whereas in Einstein's theory Λ would be a constant of Nature subject only to coupling constant evolution. In TGD framework G, Λ would depend on space-time sheet and the set of cosmological "constants" Λ_i would depend on position for a given space-time sheet.

One must of course remember that in TGD vacuum extremals can be only limiting situations. The real space-time sheets are definitely not vacuum extremals. For instance, elementary particles correspond to space-time regions with 4-D CP_2 projection and Euclidian signature of the induced metric so that their nearby Minkowskian environment has 3-D CP_2 projection and is also non-vacuum extremal. Same applies to cosmic strings, which in the ideal situation have 2-D CP_2 projection which corresponds to homologically non-trivial 2-surfaces in CP_2 . The evolution of cosmic strings would mean gradual thickening of their originally infinitely thin E^3 projection and the remnants of cosmic strings would explain also the magnetic fields filling the Universe.

It is not easy to find any killer argument against the proposed modification of Einstein's equations.

- (a) What happens to Equivalence Principle if the modification of Einstein's equations is accepted? The basic manifestation of Equivalence Principle is as the geodesic motion of test particles. In Newtonian framework the analog of this is the cancellation of the dependence on the mass of the particles due to the identical values of inertial and gravitational masses. In this respect nothing changes since the motion is determined completely by the geometry. The independence of the effects of geometry on test particle on what one assumes about the

energetics is analogous to the disappearance of inertial and rest masses from the equation of motion for Newtonian test particle.

Also the effects caused by the background geometry on particles - say redshift or spectrum of microwave temperature fluctuations of microwave background - are same irrespective of the energetic interpretation.

- (b) Both vacuum and non-vacuum options can give rise to accelerated cosmic expansion so that for vacuum option no dark energy would be needed. Does this mean that dark energy thought to be responsible for the accelerated cosmic expansion or it is pure vacuum fiction? And could one explain the velocity spectrum of distant stars rotating around galactic nuclei by assuming that galaxies are like pearls in necklace, which is vacuum flux tube instead of Kähler magnetically charged flux tube carrying huge energy density characterized by string tension defined by CP_2 scale? Note also that for critical and sub-critical vacuum option non-trivial long range gauge fields - in particular electromagnetic fields - are present in the vacuum. The situation is admittedly somewhat frustrating: I had already thought that the issue of dark energy is finally resolved in TGD framework!

Could one see vacuum extremals and non-vacuum extremals - not as options between which to choose - but descriptions applying in different length scales. In zero energy ontology this might be possible.

- (a) The original hypothesis was that the small deformations of vacuum extremals, which microscopically correspond to the generation of particles, have average energy momentum tensor given by the Einstein tensor. If this is the case, vacuum extremals would carry information about matter topologically condensed at them coded to their own geometry. The energy momentum current of the topologically condensed matter represents simplest information of this kind. Could the energy momentum tensor defined by Einstein tensor of vacuum extremal be identified with the energy momentum tensor of the topologically condensed matter? More generally, could the sum of Kähler energy momentum tensor and of the terms corresponding to projection operators representing topologically condensed matter correspond to Einstein tensor in the case of non-vacuum extremals? If so, the deviation from Einstein's equations would have quite generally interpretation in terms of topologically condensed matter. Topologically condensed matter would replace the contribution of vacuum expectations of inflaton fields.
- (b) Could the vanishing of the actual energy momentum current for vacuum extremals be interpreted as saying that the causal diamonds assignable to the zero energy states are small in the scale of vacuum extremal so that the topologically condensed matter has interpretation as quantum fluctuations? Vacuum extremal would however carry information about the topologically condensed matter (vacuum fluctuations) and make it manifest as effects like redshift, accelerated expansion, and temperature fluctuations of CMB.

One must be however always ready to invent a counter argument.

- (a) The vacuum degeneracy of Kähler action is enormous. Any space-time surface with CP_2 projection belonging to a Lagrangian sub-manifold of CP_2 has vanishing induced Kähler form and is therefore vacuum extremal. Symplectic transformations of CP_2 give rise to new Lagrangian manifolds and diffeomorphisms of M^4 give rise to new vacuum extremals. Is it really possible to identify a canonical decomposition of Einstein tensor for these vacuum extremals to at least two non-vanishing pieces characterized by cosmological "constants" Λ_i ?
- (b) One could circumvent the objection by noticing that there is no need for every vacuum extremal to define a limit of a preferred extremal.
- (c) The only possible hope about the decomposition is given by the two-dimensional character of CP_2 projection. The inverse image of a given point of CP_2 belonging to the space-time surface is in the generic case a 2-D sub-manifold of the space-time surface and as the point of CP_2 varies one obtains a slicing of the space-time surface by these 2-surfaces. Could the Einstein tensor have a representation $G = \Lambda_1 P_1 + \Lambda_2 P_2$ as a sum of contributions associated with the tangent space and space-time complement?

11.4 Appendix B: Conditions on function $k(r)$ from the generalization of Einstein's equations for vacuum extremals

In this Appendix the conditions on the function $k(r)$ guaranteeing that the metric $ds^2 = dt^2 - k^2 dr^2 - r^2 d\Omega^2$ is imbeddable to $M^4 \times CP_2$ as vacuum extremal obtained by deforming $t = \text{constant}$ hyper-surface E^3 of M^4 in CP_2 direction are discussed. The vacuum extremal is taken to be the simplest possible one having CP_2 projection to a geodesic circle S^1 of CP_2 having angular coordinate Φ as coordinate so that one has $\Phi = f(r)$ and $k^2 = 1 + R^2(df/dr)^2$.

11.4.1 Differential equation for $k(r)$ from generalized Einstein equations

As shown, the Einstein tensor G of the solution of the metric $ds^2 = dt^2 - k^2 dr^2 - r^2 d\Omega^2$ is in general vanishing and this is not consistent with the vacuum extremal property of the imbedding meaning that the induced Kähler field vanishes. These vacuum extremals are also in conflict with the assumption that preferred extremals (4-surfaces) at the limit of vacuum satisfy Einstein-Maxwell equations with cosmological term satisfying $T_K = \kappa G + \Lambda g$. This condition is however un-necessarily strong and not actually prediction of TGD. The only condition on preferred extremals in TGD is that T_K has vanishing divergence and this condition can be satisfied by assuming only

$$\begin{aligned} T^{\alpha\beta} &= \kappa G^{\alpha\beta} + \sum_i \Lambda_i P_i^{\alpha\beta} \ , \\ D_\beta(\Lambda_i P_i^{\alpha\beta}) &= 0 \ , \quad \kappa = \frac{1}{8\pi G} \ . \end{aligned} \quad (11.4.1)$$

Λ_i need not to be constant functions anymore so that cosmological constant is replaced by several - presumably slowly varying - cosmological "constants".

In the recent case one is interested on having such $k(r)$ that one has vacuum extremal with 1+1+2 decomposition satisfying

$$\kappa G^{\alpha\beta} = - \sum_{i=1,2,3} \Lambda_i P_i^{\alpha\beta} \ . \quad (11.4.2)$$

Now one would have three terms P_i in the decomposition which is 1 + 1 + 2. corresponding to coordinate lines for t and r and spheres (θ, ϕ) . In the following the differential equations for $k(r)$ guaranteeing that $\Lambda_i P_i$ has a vanishing divergence, are deduced. These equations can be integrated and give rise to a family of metrics.

The first thing to notice is that if $\Lambda_1 P_1$ and $\Lambda_2 P_2$ have vanishing divergences then also $\Lambda_3 P_3$ does so since G has vanishing divergences and $T_K = 0$ holds true. There it is enough to show that $(G^{tt}, 0, 0, 0) = (-g^{tt} R_3/2, 0, 0, 0)$ expressible as $\Lambda_1 g^{tt}$ and $(0, G^{rr}, 0, 0) = (0, R^{rr} - g^{rr} R_3/2, 0, 0)$ have vanishing divergence.

For $G^{tt} = -g^{tt} R/2$ the divergence vanishes trivially since it involves only ordinary time derivative. For $G^{rr} = R^{rr} - g^{rr} R/2$ the condition is non-trivial and gives rise to a differential equation giving as solutions a family of functions $k(r)$. The vanishing of covariant divergence for $\Lambda_2 P_2 \leftrightarrow G^{rr}$ gives rise to the condition

$$\partial_r G^{rr} + 2 \left\{ \begin{matrix} r \\ r \ r \end{matrix} \right\} G^{rr} = 0 \ . \quad (11.4.3)$$

This equation can be integrated

$$G^{rr} = \frac{K}{k^2(r)} = -\frac{\Lambda_2}{\kappa} g^{rr} , \quad (11.4.4)$$

where Λ_2 is 1-D cosmological "constant" with dimensions of length to fourth is k is taken to be dimensionless so that r has dimension of length.

Writing the expression of G^{rr} explicitly one can cast this equation to the differential equations

$$r^2 G_r^r = \frac{1}{k^3} \frac{dk}{d \log(r)} + \frac{k^2 - 1}{k^2} = \frac{\Lambda}{\kappa} r^2 . \quad (11.4.5)$$

This differential equation is non-linear and non-homogenous and can be written also in the form

$$\frac{dk}{d \log(r)} + k(k^2 - 1) = \frac{\Lambda}{\kappa} k^3 r^2 . \quad (11.4.6)$$

The first thing to notice is that the equation allows $k = \text{constant}$ as a solution only if one has $k = 1$. Hence $k = 1 + \epsilon$ solution is not allowed as a gravitational vacuum solution in TGD sense.

11.4.2 Spherical and hyperbolic metrics satisfy modified Einstein's equations

For $\Lambda_2 = 0$ it can be however integrated. In this case one obtains

$$\int_{k_0}^k \frac{1}{k(k^2 - 1)} dk = \int_0^u du = \log\left(\frac{r}{R}\right) . \quad (11.4.7)$$

This gives

$$k^2 = \frac{1}{1 - \left(\frac{r}{R}\right)^2} . \quad (11.4.8)$$

This is nothing but the metric of S^3 with radius R . As a matter fact, one obtains only one half of the sphere and by gluing the two halves along equator one would obtain two sheeted 4-surface defining the entire 3-sphere.

Also hyperbolic metric with $k = 1/(1 + (r/R)^2)$ satisfies the generalized Einstein's equations as is easy to see by a direct calculation.

Could $k(r)$ ansatz allow other than H^3 , E^3 , and S^3 for Robertson-Walker cosmology? The deviation of $k(r)$ from the form

$$k^2(r) = \frac{1}{(1 + \epsilon(r/R)^2)} , \quad \epsilon = \pm 1, 0$$

means breaking of $SO(3,1)$, $SO(4)$, or $SO^3 \times T^3$ symmetry. Hence the 1+3 decomposition is replaced with 1+1+2 decomposition so that one obtains two conditions for $k(r)$ corresponding to G^{aa} and G^{rr} . Note that the condition $\sin(\Theta) = a/\tau$ must be satisfied unless the situation is hyperbolic. This suggests that only these 3 solutions are possible.

11.4.3 Approximate solutions for $\Lambda_1 \neq 0$

For non-vanishing values of $\Lambda = \Lambda$ one obtains candidates for solutions which one is searching provided that $k(r)$ approaches rapidly to $k(r) = 1$. Near the origin Eq. 11.4.6 reduces to that giving S^3 so that the solution looks near the center of the icosahedron. For large values of r it should give flat metric. If $k \rightarrow 1$ or $k \rightarrow 0$ the equation reduces in good approximation to

$$\frac{1}{k^3} \frac{dk}{dr} = \frac{\Lambda}{\kappa} r . \quad (11.4.9)$$

This can be integrated to give

$$k^2 = \frac{k_0^2}{\left[1 + \frac{\Lambda}{\kappa} k_0^2 (r^2 - r_0^2)\right]} . \quad (11.4.10)$$

k approaches zero asymptotically so that the result is consistent with the assumption about the asymptotic behavior. The solution becomes singular at

$$r^2 = r_0^2 - \frac{\kappa}{k_0^2 \Lambda} . \quad (11.4.11)$$

One can get rid of the singularity if one assumes

$$r_0^2 < \frac{\kappa}{k_0^2 \Lambda} . \quad (11.4.12)$$

With this assumption one can write the solution as

$$k = \left[\left(\frac{r}{r_a} \right)^2 + 1 \right]^{-1/2} ,$$

$$r_a^2 = \frac{\kappa}{\Lambda} , \quad r_1^2 = k_0^{-2} r_a^2 - r_0^2 . \quad (11.4.13)$$

The limiting case corresponds to $r_1 = 0$ taking the singularity to origin. This is nothing but H^3 metric so that the solutions would look like S^3 near origin and like H^3 at larger distances. A local S^3 like bump would be in question.

Consider now that ratio of the distance s to the Euclidian distance R and assume that the metric is non-singular also at origin so that it makes sense to use the approximation holding true at $r \rightarrow \infty$ limit. Assume that R is defined as the radius for which $k(R) = 1$ holds true. This condition gives

$$\frac{R}{r_a} = \sqrt{1 - \left(\frac{r_1}{r_a} \right)^2} . \quad (11.4.14)$$

The basic solution dependent parameters are k_0 and r_0 whereas r_a would be analogous to a constant of Nature in GRT context: in TGD framework also this parameter can be seen as a parameter characterizing space-time sheet. In any case it is convenient to express everything in terms of k_0 and r_0 . A tedious exercise gives the following formulas for various length ratios:

$$\begin{aligned} \frac{R}{r_1} &= \frac{\sqrt{1 - \left(\frac{r_1}{r_a}\right)^2}}{\frac{r_1}{r_a}} = \sqrt{k_0^2 \left[1 + \left(\frac{r_0}{r_1}\right)^2\right] - 1} \equiv X \ , \\ \frac{r_1}{r_a} &= \frac{\sqrt{1 - \left(\frac{k_0 r_0}{r_a}\right)^2}}{k_0} \ , \quad \frac{r_a}{R} = \frac{k_0}{X} \ . \end{aligned} \tag{11.4.15}$$

The ratio increases exponentially with R/r_1 .

The goal of the calculation is to deduce the ratio s/R of the deformed distance to Euclidian distance. One can estimate $s(R) = \int_0^R k(r)dr$ by approximating the metric with its asymptotic form for large values of r . This gives

$$\frac{s}{R} = \frac{r_a}{R} \operatorname{arsinh}\left(\frac{R}{r_1}\right) \simeq \frac{k_0}{X} \operatorname{arsinh}(X) \ , \quad X = \sqrt{k_0^2 \left[1 + \left(\frac{r_0}{r_1}\right)^2\right] - 1} \ . \tag{11.4.16}$$

In the recent TGD-based cosmology one has the order of magnitude estimate $\Lambda \sim \kappa/a^2$, a cosmic time defined by the light-cone proper time. In condensed matter length scale the value of a would be much smaller than in cosmology. r_a would be of order a and $r_1/r_a \sim 1/k_0$ would hold true. One would have $r_0/r_1 \simeq 0$, and $R/r_1 \sim \sqrt{k_0^2 - 1}$ giving $r_a/R = (r_a/r_1)(r_1/R) = k_0/\sqrt{k_0^2 - 1}$ giving

$$\frac{s}{R} = \frac{r_a}{R} \operatorname{arsinh}\left(\frac{R}{r_1}\right) \simeq \frac{k_0}{\sqrt{k_0^2 - 1}} \operatorname{arsinh}(\sqrt{k_0^2 - 1}) \equiv \coth(U_0) \times U_0 \ , \quad k_0 = \cosh(U_0) \tag{11.4.17}$$

Large enough value for k_0 gives large ration s/R . Hence it seems possible to have rather large values of s/R . This gives also excellent hopes about equal lengths for the edges of icosahedral tetrahedrons. It should be relatively easy to estimate numerically the length of geodesic edges of the "surface" edges in the proposed metric. In the approximation $k(r) = 1$ in the region containing the edges, the lengths of surfaces edges are just the Euclidian lengths.

The conclusion is that if one accepts the TGD based vision implying a modification of Einstein's equations, one indeed can have a situation in which the the icosahedral tetrahedra are regular. Whether this has any interesting physical meaning, remains of course open. Perhaps the only real defense for this exercise in Riemannian geometry is that it forced to question the naive assumption that all preferred extremals satisfy Einstein-Maxwell equations with cosmological term.

11.5 Appendix C: Explicit form for the regular tetrahedron property for $k = \text{constant}$ option

The generalization of Platonic solids to the deformation of E^3 is obtained by replacing their edges by geodesic lines in the deformed metric. For spherical tetrahedron at unit sphere the distances between vertices are equal to $\sqrt{8/3} \simeq 1.633$. For the irregular tetrahedrons assignable to an icosahedron the surface edges are much shorter but still by a factor $\sqrt{2^3/(5 + \sqrt{5})} \simeq 1.0515$ longer than the radial edges.

In the following only the case $k = 1 + \delta$ is considered so that radial edges have length k if unit sphere in Minkowski metric is in question. In order to see whether the condition $s = k$ for the length between the vertices of icosahedron can be satisfied for a suitable choice of δ , one

must calculate the geodesic distance between the vertices. It turns out that $k = \infty$ is the only solution. The interpretation is following. As k giving the length of the radial edge increases, also the length of the surface edge increases so fast that the radial edge remains shorter than the surface edge for all finite values of k . As already found, the condition that solution is vacuum extremal also in gravitational sense as it is understood in TGD framework allows only $k = 1$ for constant value of k .

11.5.1 Equations of geodesic lines for deformed E^3

The equations of geodesic line are in general form

$$\frac{d^2 x^k}{dt^2} + \left\{ \begin{matrix} k \\ l m \end{matrix} \right\} \frac{dx^l}{dt} \frac{dx^m}{dt} .$$

They can be solved by using angular momentum conservation and energy conservation.

- (a) Rotational symmetry allows to choose the coordinates so that the geodesic line is in $z = 0$ plane so that one has $\theta = \pi/2$. The equations reduce to

$$\begin{aligned} \frac{d^2 r}{dt^2} + \left\{ \begin{matrix} r \\ \phi \phi \end{matrix} \right\} \left(\frac{d\phi}{dt} \right)^2 &= 0 , \\ \frac{d^2 \phi}{dt^2} + 2 \left\{ \begin{matrix} \phi \\ r \phi \end{matrix} \right\} \frac{dr}{dt} \frac{d\phi}{dt} &= 0 . \end{aligned}$$

This gives

$$\begin{aligned} \frac{d^2 r}{dt^2} &= \frac{r}{k^2} \left(\frac{d\phi}{dt} \right)^2 , \\ \frac{\frac{d^2 \phi}{dt^2}}{\frac{d\phi}{dt}} &= -2 \frac{dr}{r} . \end{aligned}$$

- (b) The latter equation can be integrated just as in E^3 and gives

$$\frac{d\phi}{dt} = \omega_0 \left(\frac{r_0}{r} \right)^2 .$$

$r_0 = 1$ holds true for unit sphere. $r_0 = 1$ is assumed in the following formulas. The interpretation is in terms of angular momentum conservation.

- (c) Substituting $d\phi/dt$ to the equation for r one obtains

$$\frac{d^2 r}{dt^2} = \frac{\omega_0^2}{k^2 r^3} .$$

Energy conservation becomes explicit by multiplying with dr/dt and integrating to get

$$\begin{aligned} \left(\frac{dr}{dt} \right)^2 + \frac{K^2}{r^2} &= v_0^2 + K^2 , \\ v_0 &= \frac{dr}{dt}(0) , \quad K = \frac{\omega_0}{k} . \end{aligned}$$

This gives

$$\begin{aligned} \frac{dr}{dt} &= \pm v_0 X , \\ X &= \sqrt{1 + \frac{K^2}{v_0^2} (1 - u^2)} , \\ u &= \frac{1}{r} . \end{aligned}$$

The initial values v_0 and ω_0 - or rather their ratio- must be fixed from the condition that the geodesic line connects the neighboring vertices of the icosahedron. This condition boils down to the condition that the angular distance between the points is same as for ordinary icosahedron.

- (d) Also this equation can be integrated. It is convenient to take ϕ instead of t as the variable by using $dr/d\phi = dr/dt \times dt/d\phi$ and the expression of $d\phi/dt$ in Eq. 3b. This gives

$$\Delta\phi = \arccos\left(\frac{\Phi}{2+\Phi}\right) = \frac{\omega_0}{v_0} \oint_1^1 \frac{1}{\sqrt{X}} du ,$$

$$\Phi = \frac{1+\sqrt{5}}{2} .$$

\oint_1^1 tells that the integral is between points, which are at the surface of the sphere. The integral is two times the integral between $u = u_0 = 1$ and u_{max} at which $dr/dt = 0$ holds true. By taking $u = 1/r$ as an integration variable one obtains

$$\Delta\phi = 2k\sqrt{A} \times I(A, u_{max}) ,$$

$$I(A, u_{max}) = \int_1^{u_{max}} \frac{1}{\sqrt{1+A(1-u^2)}} du ,$$

$$A = \frac{K^2}{v_0^2} .$$

$\Delta\phi$ is fixed as the angular distance between neighboring vertices of icosahedron. u_{max} corresponds to the vanishing of X , and is given by

$$u_{max} = \sqrt{\frac{A+1}{A}} = \sqrt{1 + \frac{k^2 v_0^2}{\omega_0^2}} .$$

u_{max} increases with k meaning that the geodesic line visits nearer to origin for larger values of k unless the radial kinetic energy at the initial moment is reduced as compared to the rotational one. From these condition one can solve that initial values v_0 and ω_0 .

- (e) The variable change $v = \sqrt{A/(1+A)}u$ allows to express the integral $I(A, u_{max})$ in terms of elementary functions:

$$I(A, u_{max}) = \sqrt{\frac{1}{1+A}} \int_{\sqrt{A/(1+A)}}^1 \frac{1}{\sqrt{1-v^2}} dv = \frac{1}{\sqrt{A}} (\pi/2 - \arcsin(\sqrt{A/(1+A)})) .$$

This gives the condition

$$\Delta\phi = \arccos\left(\frac{\Phi}{2+\Phi}\right) = 2k(\pi/2 - \arcsin(\sqrt{A/(1+A)})) \quad (11.5.1)$$

$$A = \frac{\omega_0^2}{v_0^2 k^2} . \quad (11.5.2)$$

This condition relates the parameters ω_0/v_0 and k :

$$k = \frac{\arccos\left(\frac{\Phi}{2+\Phi}\right)}{2(\pi/2 - \arcsin(\sqrt{A/(1+A)}))} . \quad (11.5.3)$$

$$(11.5.4)$$

The above conditions only fix the geodesic line representing the edge of the icosahedron. Besides the condition fixing $\Delta\phi$, one must apply the condition $s = k$, where s is the geodesic length of the edge. Since the scaling up of g_{rr} increases also the distance between the vertices of the icosahedron, it is not completely clear whether any solution exists unless one gives up that assumption that $k(r)$ is constant.

One can however argue that since the variation of r for the surface edge is much shorter than for radial edge, the length of radial edge increases faster with k as that of the surface edge so that there are hopes that the lengths of the edges can be equal.

11.5.2 Explicit form for the condition $s = k$

Also the integral involved with the condition $s = k$ can be solved explicitly so that it is rather trivial exercise in numerics to find whether the solution to the condition $k = s$ exists.

- (a) The expression for the length of the surface edge is given by

$$s = \int \sqrt{k^2 + \left(\frac{d\phi}{dr}\right)^2} dr .$$

By substituting $d\phi/dr$ one obtains

$$s = 2k\sqrt{A}J(A, u_{max}) ,$$

$$J(A, u_{max}) = \int_1^{u_{max}} \frac{1}{\sqrt{1+A(1-u^2)}} \frac{du}{u^2} ,$$

$$A = \frac{K^2}{v_0^2} , \quad u_{max} = \sqrt{\frac{A+1}{A}} = \sqrt{1 + \frac{k^2 v_0^2}{\omega_0^2}} .$$

Edge length s is proportional to the radial edge length k and depends also on parameter A , which in turn depends on k both explicitly and implicitly.

The first thing to notice is that if A or equivalently u_{max} does not depend on k , both s and radial edge length are proportional to k so that their ratio does not change. Hence A must depend on k both explicitly and implicitly. The constraint of Eq. 3e for $\Delta\phi$ and the non-trivial explicit dependence of $A = x^2/k^2$ on k together imply that also the parameter $x = \omega_0/v_0 = k\sqrt{A}$ must depend on k .

- (b) The integral $J(A, u_{max})$ can be expressed in terms of elementary function by the same variable change as performed for $I(A, u_{max})$. One obtains

$$\begin{aligned} J(A, u_{max}) &= \frac{\sqrt{A}}{(1+A)} \int_{\sqrt{A/(1+A)}}^1 \frac{1}{\sqrt{1-v^2}} \frac{dv}{v^2} \\ &= -\frac{\sqrt{A}}{(1+A)} \cot(\arcsin(\sqrt{A/(1+A)})) = \frac{1}{1+A} . \end{aligned}$$

This transforms the condition $s/k = 1$ to the form

$$\begin{aligned} \frac{s}{k} &= \frac{2\sqrt{A}}{(1+A)} = 1 , \\ A &= \frac{K^2}{v_0^2} = \frac{\omega_0^2}{k^2 v_0^2} . \end{aligned} \tag{11.5.5}$$

The condition $s/k = 1$ gives

$$A = 1 . \tag{11.5.6}$$

Combining this with Eq. 3e for k , one obtains

$$\begin{aligned} A &= 1 , \\ k &= \frac{\arccos\left(\frac{\Phi}{2+\Phi}\right)}{2(\pi/2 - \arcsin(\sqrt{A/(1+A)}))} = \infty , \\ r = \frac{\omega_0}{v_0} &= k\sqrt{A} = \infty . \end{aligned} \tag{11.5.7}$$

The conclusion is that for a finite value of k it is not possible to satisfy the condition $s/k = 1$. The interpretation is that the length of radial edge does not increase fast enough to reach the length of the surface edge since it becomes also longer.

Acknowledgements: I want to thank the quantum gravity research group of Topanga, CA, for a generous support Klee Irwin, Fang Fang, Julio Kovacs, Carlos Castro, Tony Smith for highly interesting discussions concerning quasicrystals.

Part III

**TOPOLOGICAL FIELD
QUANTIZATION AND
GENERATION OF
STRUCTURES**

Chapter 12

Hydrodynamics and CP_2 Geometry

12.1 Introduction

In this chapter the basic notions related to many-sheeted space-time is briefly described.

The understanding of the turbulence is a longstanding problem in hydrodynamics [B61, B62]. This problem is acute also in astrophysics [E152], where the proper understanding of the turbulence associated with the astrophysical systems, such as the mass accretion in a binary star, is lacking. A generally accepted point of view is that Navier-Stokes equations provide a correct description of the hydrodynamics and that the problems are of purely technical nature, being analogous to the difficulties encountered in the understanding of the color confinement.

12.1.1 Basic ideas and concepts

TGD approach to the description of the fundamental interactions suggests a fresh approach to the basic problems of the hydrodynamics. The new physical ideas are the following ones.

The notion of topological condensate

The concept of topological condensate: the criticality of the Kähler function and topological arguments suggest that 3-space has many-sheeted, fractal like, hierarchical structure consisting of 3-surfaces with boundary, topological field quanta, condensed on larger topological field quanta. The n :th level of the topological condensate is characterized by a length scale $L(n)$ giving lower bound for the size of the topological quanta at this level.

Various gauge fluxes and gravitational flux associated with a given topological field quantum flow to the lower condensate level via $\#$ contacts near the boundaries of the topological field quanta, whose microscopic description in terms of partons is discussed in [K35]. The outer surfaces of the macroscopic bodies are identified as the boundaries of the topological field quanta condensed in the background 3-space.

Topological field quanta are characterized by certain vacuum quantum numbers and the space-time in the astrophysical length scales corresponds to the large vacuum quantum number limit of TGD. In the present situation hydrodynamic vortex provides a good candidate for a topological field quantum condensed on the background 3-space and at a given level vortices must have size not smaller than the length scale $L(n)$. Actually this picture of the space-time requires the generalization of the ordinary hydrodynamics to a hierarchy of hydrodynamics, one for each condensate level and also the modelling of the energy transfer between various condensate levels. In this chapter only the modifications of the hydrodynamics associated with a given condensate level are considered.

The join along boundaries bond makes it possible to glue topological field quanta together to form a larger coherent quantum systems from simpler basic units. Since dissipation corresponds to a loss of the quantum coherence, the formation of the join along boundaries bonds should play a key role in the understanding of the dissipation, in particular hydrodynamic dissipation.

A concrete topological description for the dissipation is following. The basic mechanism of the dissipation at condensate level n are the inelastic collisions of the condensed topological field quanta involving the formation and splitting of the join along boundaries bonds and leading to the transfer of the kinetic energy to the kinetic energy of the topological field quanta at higher condensate level n_1 with $L(n_1) < L(n)$. Eventually the kinetic energy of the flow ends up to the atomic condensate levels, where the collisions of atoms take care of the dissipation. The modelling of this mechanism requires a model for the coupling between hydrodynamics associated with two different condensate levels.

Long range color and electroweak gauge fields created by dark matter

TGD predicts classical long ranged color and weak forces, in particular Z^0 force. The study of the imbeddings for various metrics [K85] suggests strongly that at long length scales matter is accompanied by long range electro-weak gauge fields. For vacuum extremals em field can vanish while Z^0 field is non-vanishing: this requires that Weinberg angle satisfies $\sin^2(\theta_W) = 0$ in this phase. In the astrophysical length scales Z^0 charge is proportional to the gravitational mass of the system, when Planck mass is used as unit: $Q_Z = \epsilon_1 m/m_{Pl}$, where ϵ_1 is numerical factor smaller.

Also long ranged classical W fields are possible as well as classical long ranged color fields. The proper interpretation is in terms of scaled down hierarchy of weak and color physics assignable to a hierarchy of dark matters coupling to ordinary matter only via gravitation directly. These physics manifest themselves already in nuclear physics [K77] and condensed matter physics [K27], in particular in the physics of living matter. The appearance of classical Z^0 fields in the bio-systems could explain chirality selection in the living matter.

TGD based model for atomic nuclei predicts that nucleons are connected by color bonds connecting exotic quarks with mass of order MeV. These quarks couple to light variants of weak bosons with Compton length of order atomic radius so that the range of these exotic weak forces would be about atomic radius. These color bonds can have also net em and weak charges so that nucleus develops an anomalous weak charge. More generally, a hierarchy of scaled up variants of weak and color physics is predicted and the range 10 nm-2.5 μm containing the p-adic length scales defined by four Gaussian Mersennes is especially interesting in this respect.

As a consequence, the dark matter part of condensed matter system serves as a source of Z^0 electric and magnetic fields. These fields are vacuum screened above the relevant weak length scale L_w . This means that the space-time sheets of weak bosons are of size L_w and weak gauge fluxes are not conserved in $\#$ contacts to larger space-time sheets. The outcome is randomness and loss of coherence in length scales longer than L_w .

In particular, moving matter at given dark space-time sheet creates Z^0 magnetic field

$$\nabla \times B_Z \simeq g_Z N \beta , \quad (12.1.1)$$

where N is the density of weak isospin of dark matter using neutrino isospin as a unit. This formula makes sense below the appropriate weak length scale determined by the mass of dark weak bosons in question. Above this length scale vacuum screening occurs. Z^0 electric field satisfies also the appropriate source equation.

Although the Z^0 fields as such are extremely weak, the topological obstructions caused by the CP_2 topology for the imbeddings of the Z^0 magnetic fields are nontrivial. CP_2 topology generates structures: the hydrodynamical flow decomposes into what could be called flux quanta of the Z^0 magnetic field. It will be later found that under rather natural assumptions the sizes of the flux quanta are indeed of the same order of magnitude as the sizes of the typical structures

associated with the hydrodynamic flow. In particular, for large systems typically encountered in astrophysics, the geometry of CP_2 is bound to become important.

12.1.2 Z^0 magnetic fields and hydrodynamics

In [K77] long ranged color and weak forces associated with the color bonds between nucleons inside atomic nuclei are proposed as an explanation for the basic properties of the ordinary liquid phase and for the anomalous characteristics of liquid water. The mathematical similarity between incompressible hydrodynamical flow and Maxwell equations for magnetic field forces to ask whether Z^0 magnetic fields created by the dark matter component of condensed matter system might provide deeper insights into the physics of hydrodynamical flow. The general study of solutions of field equations [K11] indeed leads to very general mathematical insights in this respect providing a classification of asymptotic flow patterns in terms of the dimension of CP_2 projection varying in the range $2 \leq D \leq 4$.

Z^0 magnetic fields and transition to turbulence

The concept of the Z^0 magnetic field suggests a new approach to the problem of understanding how the transition to turbulence takes place. The transition to a turbulence might be understood simply as a spontaneous Z^0 magnetization. Flow decomposes into eddies carrying a Z^0 magnetic field in the direction of the rotation axis of the eddy. Due to the viscosity, the size of the eddy grows until its size becomes critical. Vortices dissipate their energy and angular momentum by the emission of daughter vortices: the emission is a generalization of the process known as a phase slippage in super fluidity [D14]. This mechanism suggests fractal like structure for the development of the hydrodynamic turbulence. In fact, it will be found CP_2 geometry implies naturally fractal like structures [A57] and the model for the turbulence relies heavily on the assumption that the sizes of the daughter eddies are related to the size of the mother eddy by a discrete scaling transformation.

Turbulence and Z^0 magnetization

TGD suggests a first principle explanation for the occurrence of a spontaneous Z^0 (and Kähler) magnetization and therefore of turbulence. The probability of the configuration is proportional to the exponent of the Kähler function. Kähler function corresponds to the absolute minimum of the Kähler action and Kähler magnetic (electric) fields give a positive (negative) contribution to the Kähler action so that a transition to a configuration containing Kähler magnetic fields can take place provided the configuration is energetically possible and corresponds to the minimum of Kähler action.

It turns out that for a certain critical values of the flow parameters, Kähler magnetization takes place and implies the generation of the eddies and turbulence. The mechanism leading to the increase of the Kähler action is however not the generation of magnetic Kähler action but the decrease of the magnitude of the Kähler electric contribution as is understandable from the fact that Kähler magnetic fields of the flow are in general by a factor β (β is the typical flow velocity) weaker than the Kähler electric fields. The decrease of the Kähler electric contribution follows from the fact that the Kähler electric field of the vortex becomes small near the core of the vortex. It should be noticed that a similar explanation might apply to other types of phase transitions, say spontaneous magnetization.

12.1.3 Topics of the chapter

The topics of the chapter are following.

- (a) The chapter begins with an updated review of the basic aspects of the many-sheeted space-time concept.

- (b) Hydrodynamical and thermodynamical hierarchies associated with the p-adic length scale hierarchy are considered. A generalization of hydrodynamics to a p-adic hierarchy of hydrodynamics is performed and a mechanism of energy transfer between condensate levels is identified. Mary Selvam has found a fascinating connection between the distribution of primes and the distribution of vortex radii in turbulent flow in atmosphere. These observations provide new insights into p-adic length scale hypothesis and suggest that TGD based generalization of Hawking-Bekenstein law holds even in macroscopic length scales and that hydrodynamical vortices behave in some aspects like elementary particles.
- (c) General ideas about the description of phase transitions in terms of configuration space geometry (configuration space understood as the space of 3-surfaces, the "world of classical worlds") are considered. The new element is the presence of several condensate levels.
- (d) Some simple cylindrically symmetric flows are studied and it is shown that the sizes of the flux structures are of a correct order of magnitude under rather natural assumptions about the vacuum parameters characterizing electrovac neutral space-time.
- (e) A detailed model for the generation of turbulence as a spontaneous Kähler (implying both em and Z^0 magnetization) magnetization in the case of the channel flow is discussed.

An encouraging result is the prediction for the size distribution of the vortices: the prediction is practically identical with that obtained from the model of Heisenberg but on rather different physical grounds. The model is rather insensitive to the p-adic scaling of vortices in the transition as long as it is smaller than $\lambda = 2^{-5}$. The model is also consistent with the assumption that the decay of a vortex to smaller vortices corresponds to a phase transition from a given level of dark matter hierarchy to a lower level so that the value of \hbar is reduced by a factor $\lambda = v_0/n \simeq 2^{-11}/n$, $n = 1, 2, \dots$ so that Compton length scales as well as sizes of vortices are reduced by this factor.

12.2 Many-sheeted space-time concept

In this section the basic phenomenology related to the many-sheeted space-time concept is introduced. In [K35] a more refined and more up-to-date review of these notions relying on number theoretic vision can be found. The vision about the role of dark matter in condensed matter and living matter is summarized in [K27].

12.2.1 Basic concepts related to topological condensation and evaporation

The most up-to-date discussion of the notions such as topological condensation and evaporation, gauge charges, transfer of gauge field between different space-time sheets,... can be found in [K35].

CP_2 type vacuum extremals

CP_2 type extremals behave like elementary particles (in particular, light-likeness of M^4 projection gives rise to Virasoro conditions). CP_2 type vacuum extremals have however vanishing four-momentum although they carry classical color charges. This raises the question how they can gain elementary particle quantum numbers.

In topological condensation of CP_2 type vacuum extremal a light-like causal horizon is created. Number theoretical considerations strongly suggest that the horizon carries elementary particle numbers and can be identified as a parton. The quantum numbers or parton would serve as sources of the classical gauge fields created by the causal horizon.

In topological evaporation CP_2 type vacuum extremal carrying only classical color charges is created. This would suggest that the scattering of CP_2 type vacuum extremals defines a topological quantum field theory resulting as a limit of quantum gravitation (CP_2 is gravitational instanton) and that CP_2 type extremals define the counterparts of vacuum lines appearing in the formulation of generalized Feynman diagrams.

contacts as parton pairs

The earlier view about # contacts as passive mediators of classical gauge and gravitational fluxes is not quite correct. The basic modification is due to the fact that one can assign parton or parton pair to the # contact so that it becomes a particle like entity. This means that an entire p-adic hierarchy of new physics is predicted.

- (a) Formally # contact can be constructed by drilling small spherical holes S^2 in the 3-surfaces involved and connecting the spherical boundaries by a tube $S^2 \times D^1$. For instance, CP_2 type extremal can be glued to space-time sheet with Minkowskian signature or space-time sheets with Minkowskian signature can be connected by # contact having Euclidian signature of the induced metric. Also more general contacts are possible since S^2 can be replaced with a 2-surface of arbitrary genus and family replication phenomenon can be interpreted in terms of the genus.

The # contact connecting two space-time sheets with Minkowskian signature of metric is accompanied by two "elementary particle horizons", which are light-like 3-surfaces at which the induced 4-metric becomes degenerate. Since these surfaces are causal horizons, it is not clear whether # contacts can mediate classical gauge interactions. If there is an electric gauge flux associated with elementary particle horizon it tends to be either infinite by the degeneracy of the induced metric. It is not clear whether boundary conditions allow to have finite gauge fluxes of electric type. A similar difficulty is encountered when one tries to assign gravitational flux to the # contact: in this case even the existence of flux in non-singular case is far from obvious. Hence the naive extrapolation of Newtonian picture might not be quite correct.

- (b) Number theoretical considerations suggests that the two light-like horizons associated with # contacts connecting space-time sheets act as dynamical units analogous to shock waves or light fronts carrying quantum numbers so that the identification as partons is natural. Quantum holography would suggest itself in the sense that the quantum numbers associated with causal horizons would determine the long range fields inside space-time sheets involved.
- (c) # contacts can be modeled in terms of CP_2 type extremals topologically condensed simultaneously to the two space-time sheets involved. The topological condensation of CP_2 type extremal creates only single parton and this encourages the interpretation as elementary particle. The gauge currents for CP_2 type vacuum extremals have a vanishing covariant divergence so that there are no conserved charges besides Kähler charge. Hence electro-weak gauge charges are not conserved classically in the region between causal horizons whereas color gauge charges are. This could explain the vacuum screening of electro-weak charges at space-time level. This is required since for the known solutions of field equations other than CP_2 type extremals vacuum screening does not occur.
- (d) In the special case space-time sheets have opposite time orientations and the causal horizons carry opposite quantum numbers (with four-momentum included) the # contact would serve the passive role of flux mediator and one could assign to the contact generalized gauge fluxes as quantum numbers associated with the causal horizons. This is the case if the contact is created from vacuum in topological condensation so that the quantum numbers associated with the horizons define naturally generalized gauge fluxes. Kind of generalized quantum dipoles living in two space-times simultaneously would be in question. # contacts in the ground state for space-time sheets with opposite time orientation can be also seen as zero energy parton-antiparton pairs bound together by a piece of CP_2 type extremal.
- (e) When space-time sheets have same time orientation, the two-parton state associated with the # contact has non-vanishing energy and it is not clear whether it can be stable.

#_B contacts as bound parton pairs

Besides # contacts also join along boundaries bonds (JABs, #_B contacts) are possible. They can connect outer boundaries of space-time sheets or the boundaries of small holes associated with

the interiors of two space-time sheets which can have Minkowskian signature of metric and can mediate classical gauge fluxes and are excellent candidates for mediators of gauge interactions between space-time sheet glued to a larger space-time sheet by topological sum contacts and join along boundaries contacts. The size scale of the causal horizons associated with parton pairs can be arbitrary whereas the size scale of $\#$ contacts is given by CP_2 radius.

The existence of the holes for real space-time surfaces is a natural consequence of the induced gauge field concept: for sufficiently strong gauge fields the imbeddability of gauge field as an induced gauge field fails and hole in space-time appears as a consequence. The holes connected by $\#_B$ contacts obey field equations, and a good guess is that they are light-like 3-surfaces and carry parton quantum numbers. This would mean that both $\#$ and $\#_B$ contacts allow a fundamental description in terms of pair of partons.

Magnetic flux tubes provide a representative example of $\#_B$ contact. Instead of $\#_B$ contact also more descriptive terms such as join along boundaries bond (JAB), color bond, and magnetic flux tube are used. $\#_B$ contacts serve also as a space-time correlate for bound state formation and one can even consider the possibility that entanglement might have braiding of bonds defined by $\#$ contacts as a space-time correlate [K88].

The formation of join along boundaries contacts could become important at the quantum limit, when the thermal de Broglie wave length $\lambda_{th} = \frac{2\pi}{\sqrt{2Tm}}$ (roughly the minimal size for the p-adic 3-surface at which particle with thermal momentum $p = \sqrt{2Tm}$ can condense) is of same order of magnitude as average separation between particles. A tempting identification for the formation of the join along boundaries bonds is as Bose-Einstein condensation taking place at same temperature range.

For solids join along boundaries binding energy E_{join} can be, at least partially, regarded as the reduction of kinetic energy resulting from the elimination of translational degrees of freedom in the join along boundaries bond. Also the delocalization energy of particles, say conduction electrons contributes to E_{join} (delocalization is made possible by the formation of bridges between p-adic blocks).

Topological condensation and evaporation

Topological condensation corresponds to a formation of $\#$ or $\#_B$ contacts between space-time sheets. Topological evaporation means the splitting of $\#$ or $\#_B$ contacts. In the case of elementary particles the process changes almost nothing since the causal horizon carrying parton quantum numbers does not disappear. The evaporated CP_2 type vacuum extremal having interpretation as a gravitational instanton can carry only color quantum numbers.

As $\#$ contact splits partons are created at the two space-time sheets involved. This process can obviously generate from vacuum space-time sheets carrying particles with opposite signs of energies and other quantum numbers. Positive energy matter and negative energy anti-matter could be thus created by the formation of $\#$ contacts with zero net quantum numbers which then split to produce pair of positive and negative energy particles at different space-time sheets having opposite time orientations. This mechanism would allow a creation of positive energy matter and negative energy antimatter with an automatic separation of matter and antimatter at space-time sheets having different time orientation. This might resolve elegantly the puzzle posed by matter-antimatter asymmetry.

The creation of $\#$ contact leads to an appearance of radial gauge field in condensate and this seems to be impossible at the limit of infinitely large space-time sheet since it involves a radical instantaneous change in field line topology. The finite size of the space-time sheet can however resolve the difficulty.

If all quantum numbers of elementary particle are expressible as gauge fluxes, the quantum numbers of topologically evaporated particles should vanish. In the case of color quantum numbers and Poincare quantum numbers there is no obvious reason why this should be the case. Despite this the cancellation of the interior quantum numbers by those at boundaries or light-like causal determinants could occur and would conform with the effective 2-dimensionality stating that quantum states are characterized by partonic boundary states associated with causal

determinants. This could be also seen as a holographic duality of interior and boundary degrees of freedom [K76].

12.2.2 Can one regard $\#$ resp. $\#_B$ contacts as particles resp. string like objects?

$\#$ -contacts have obvious particle like aspects identifiable as either partons or parton pairs. $\#_B$ contacts in turn behave like string like objects. Using the terminology of M-theory, $\#_B$ contacts connecting the boundaries of space-time sheets could be also seen as string like objects connecting two branes. Again the ends holes at the ends of $\#_B$ contacts carry well defined gauge charges.

$\#$ contacts as particles and $\#_B$ contacts as string like objects?

The fact that $\#$ contacts correspond to parton pairs raises the hope that it is possible to apply p-adic thermodynamics to calculate the masses of $\#$ contact and perhaps even the masses of the partons. If this the case, one has an order of magnitude estimate for the first order contribution to the mass of the parton as $m \sim 1/L(p_i)$, $i = 1, 2$. It can of course happen that the first order contribution vanishes: in this case an additional factor $1/\sqrt{p_i}$ appears in the estimate and makes the mass extremely small.

For $\#$ contacts connecting space-time sheets with opposite time orientations the vanishing of the net four-momentum requires $p_1 = p_2$. According to the number theoretic considerations below it is possible to assign several p-adic primes to a given space-time sheet and the largest among them, call it p_{max} , determines the p-adic mass scale. The milder condition is that p_{max} is same for the two space-time sheets.

There are some motivations for the working hypothesis that $\#$ contacts and the ends of $\#_B$ contacts feeding the gauge fluxes to the lower condensate levels or vice versa tend to be located near the boundaries of space-time sheets. For gauge charges which are not screened by vacuum charges (em and color charges) the imbedding of the gauge fields created by the interior gauge charges becomes impossible near the boundaries and the only possible manner to satisfy boundary conditions is that gauge fluxes flow to the larger space-time sheet and space-time surface becomes a vacuum extremal of the Kähler action near the boundary.

For gauge bosons the density of boundary $\#_B$ contacts should be very small in length scales, where matter is essentially neutral. For gravitational $\#_B$ contacts the situation is different. One might well argue that there is some upper bound for the gravitational flux associated with single $\#$ or $\#_B$ contact (or equivalently the gravitational mass associated with causal horizon) given by Planck mass or CP_2 mass so that the number of gravitational contacts is proportional to the mass of the system.

The TGD based explanation for Podkletnov effect [H8] is based on the assumption that magnetically charged $\#$ contacts are carries of gravitational flux equal to Planck mass and predicts effect with correct order of magnitude. The model generalizes also to the case of $\#_B$ contacts. The lower bound for the gravitational flux quantum must be rather small: the mass $1/L(p)$ determined by the p-adic prime associated with the larger space-time sheet is a first guess for the unit of flux.

Could $\#$ and $\#_B$ contacts form Bose-Einstein condensates?

The description as $\#$ contact as a parton pair suggests that it is possible to assign to $\#$ contacts inertial mass, say of order $1/L(p)$, they should be describable using d'Alembert type equation for a scalar field. $\#$ contacts couple dynamically to the geometry of the space-time since the induced metric defines the d'Alembertian. There is a mass gap and hence $\#$ contacts could form a Bose-Einstein (BE) condensate to the ground state. If $\#$ contacts are located near the boundary of the space-time surface, the d'Alembert equation would be 3-dimensional. One can also ask whether $\#$ contacts define a particular form of dark matter having only gravitational interactions with the ordinary matter.

Also the probability amplitudes for the positions of the ends of $\#_B$ contacts located at the boundary of the space-time sheet could be described using an order parameter satisfying d'Alembert equation with some mass parameter and whether the notion of Bose-Einstein condensate makes sense also now. The model for atomic nucleus assigns to the ends of the $\#_B$ contact realized as a color magnetic flux tube quark and anti-quark with mass scale given by $k = 127$ (MeV scale) [K77].

This inspires the question whether $\#$ and $\#_B$ contacts could be essential for understanding bio-systems as macroscopic quantum systems [K17]. The BE condensate associated with the $\#$ contacts behaves in many respects like super conductor: for instance, the concept of Josephson junction generalizes. As a matter fact, it seems that $\#_B$ contacts, join along boundaries, or magnetic flux tubes could indeed be a key element of not only living matter but even nuclear matter and condensed matter in TGD Universe. One application of the concept is the TGD based explanation [K91] of Comorosan1 effect [I6, I14] in terms of $\#$ contact Josephson currents appearing at molecular level.

The transfer of fields between space-time sheets and $\#$ and $\#_B$ contacts

The penetration of the external electric and magnetic fields from external world to subsystem (from larger space-time sheet to a smaller one) and vice versa must take place via the creation and re-arrangement of the $\#$ and $\#_B$ contacts and also by the generation of $\#$ and $\#_B$ contact currents. The unique coupling of the wormhole BE condensate to the geometry of the boundary of the space-time sheet together with the classical electromagnetic interaction between wormholes and electrons implies coupling between electrons and the shape and size of the 3-surface. This coupling might make it possible to understand how bio-systems are able to control their size and shape.

Exotic effects related to the many-sheeted space-time

The hopping of electrons (most probably unpaired valence electrons) from the atomic space-time sheet to non-atomic space-time sheets might be energetically favorable under some circumstances and would lead to the formation of 'exotic atoms' and effective electronic alchemy since the chemical properties of the atom are presumably determined by the electronic properties of the atomic space-time sheet [K25]. The 'exotic' electrons on non-atomic space-time sheets provide an ideal mechanism for energy and charge transfer since dissipative effects are small and even the temperature at these space-time sheets might be much smaller than the temperature at the atomic space-time sheet. In this respect bio-systems are especially interesting.

The interaction of the exotic electrons with the wormhole BE condensate takes place via the classical electromagnetic interaction generating excitations of the $\#$ contact BE condensate. The mechanism is completely analogous to the ordinary mechanism of super conductivity in which electromagnetic interaction of electrons with nuclei excites phonons. Since the gap energy is of order $1/L(p)$ characterizing the size of the p-adic space-time sheet, one can consider the possibility of high temperature super conductivity.

One can even consider the possibility that the presence of electrons on 'wrong' space-time sheets makes it favorable for some atomic nuclei to feed their electromagnetic charges to non-atomic space-time sheets. This would in principle make possible Trojan horse mechanism of cold nuclear fusion since two nuclei feeding their electromagnetic gauge fluxes on different space-time sheets do not see the Coulomb wall [K77].

Also ions can drop to larger space-time sheets. In [K15, K16] a model of ionic high T_c super conductivity explaining certain peculiar effects of the em radiation on living matter is considered. These effects actually provide support for the view that living systems are macroscopic quantum systems.

12.2.3 Number theoretical considerations

Number theoretical considerations allow to develop more quantitative vision about the how p-adic length scale hypothesis relates to the ideas just described.

How to define the notion of elementary particle?

p-Adic length scale hierarchy forces to reconsider carefully also the notion of elementary particle. p-Adic mass calculations led to the idea that particle can be characterized uniquely by single p-adic prime characterizing its mass squared. It however turned out that the situation is probably not so simple.

The work with modelling dark matter suggests that particle could be characterized by a collection of p-adic primes to which one can assign weak, color, em, gravitational interactions, and possibly also other interactions. It would also seem that only the space-time sheets containing common primes in this collection can interact. This leads to the notions of relative and partial darkness. An entire hierarchy of weak and color physics such that weak bosons and gluons of given physics are characterized by a given p-adic prime p and also the fermions of this physics contain space-time sheet characterized by same p-adic prime, say M_{89} as in case of weak interactions. In this picture the decay widths of weak bosons do not pose limitations on the number of light particles if weak interactions for them are characterized by p-adic prime $p \neq M_{89}$. Same applies to color interactions.

The p-adic prime characterizing the mass of the particle would perhaps correspond to the largest p-adic prime associated with the particle. Graviton which corresponds to infinitely long ranged interactions, could correspond to the same p-adic prime or collection of them common to all particles. This might apply also to photons. Infinite range might mean that the join along boundaries bonds mediating these interactions can be arbitrarily long but their transversal sizes are characterized by the p-adic length scale in question.

The natural question is what this collection of p-adic primes characterizing particle means? The hint about the correct answer comes from the number theoretical vision, which suggests that at fundamental level the branching of boundary components to two or more components, completely analogous to the branching of line in Feynman diagram, defines vertices [K22, K79]

- (a) If space-time sheets correspond holographically to multi-p p-adic topology such that largest p determines the mass scale, the description of particle reactions in terms of branchings indeed makes sense. This picture allows also to understand the existence of different scaled up copies of QCD and weak physics. Multi-p p-adicity could number theoretically correspond to q-adic topology for $q = m/n$ a rational number consistent with p-adic topologies associated with prime factors of m and n (1/p-adic topology is homeomorphic with p-adic topology).
- (b) One could also imagine that different p-adic primes in the collection correspond to different space-time sheets condensed at a larger space-time sheet or boundary components of a given space-time sheet. If the boundary topologies for gauge bosons are completely mixed, as the model of hadrons forces to conclude, this picture is consistent with the topological explanation of the family replication phenomenon and the fact that only charged weak currents involve mixing of quark families. The problem is how to understand the existence of different copies of say QCD. The second difficult question is why the branching leads always to an emission of gauge boson characterized by a particular p-adic prime, say M_{89} , if this p-adic prime does not somehow characterize also the particle itself.

What effective p-adic topology really means?

The need to characterize elementary particle p-adically leads to the question what p-adic effective topology really means. p-Adic mass calculations leave actually a lot of room concerning the answer to this question.

- (a) The naivest option is that each space-time sheet corresponds to single p-adic prime. A more general possibility is that the boundary components of space-time sheet correspond to different p-adic primes. This view is not favored by the view that each particle corresponds to a collection of p-adic primes each characterizing one particular interaction that the particle in question participates.
- (b) A more abstract possibility is that a given space-time sheet or boundary component can correspond to several p-adic primes. Indeed, a power series in powers of given integer n gives rise to a well-defined power series with respect to all prime factors of n and effective multi-p-adicity could emerge at the level of field equations in this manner.

One could say that space-time sheet or boundary component corresponds to several p-adic primes through its effective p-adic topology in a hologram like manner. This option is the most flexible one as far as physical interpretation is considered. It is also supported by the number theoretical considerations predicting the value of gravitational coupling constant [K79] .

An attractive hypothesis is that only space-time sheets characterized by integers n_i having common prime factors can be connected by join along boundaries bonds and can interact by particle exchanges and that each prime p in the decomposition corresponds to a particular interaction mediated by an elementary boson characterized by this prime.

Do infinite primes code for q-adic effective space-time topologies?

Besides the hierarchy of space-time sheets, TGD predicts, or at least suggests, several hierarchies such as the hierarchy of infinite primes [K79] , hierarchy of Jones inclusions [K90] , hierarchy of dark matters with increasing values of \hbar [K27, K25] , the hierarchy of extensions of given p-adic number field, and the hierarchy of selves and quantum jumps with increasing duration with respect to geometric time. There are good reasons to expect that these hierarchies are closely related.

1. Some facts about infinite primes

The hierarchy of infinite primes can be interpreted in terms of an infinite hierarchy of second quantized super-symmetric arithmetic quantum field theories allowing a generalization to quaternionic or perhaps even octonionic context [K79] . Infinite primes, integers, and rationals have decomposition to primes of lower level.

Infinite prime has fermionic and bosonic parts having no common primes. Fermionic part is finite and corresponds to an integer containing and bosonic part is an integer multiplying the product of all primes with fermionic prime divided away. The infinite prime at the first level of hierarchy corresponds in a well defined sense a rational number $q = m/n$ defined by bosonic and fermionic integers m and n having no common prime factors.

2. Do infinite primes code for effective q-adic space-time topologies?

The most obvious question concerns the space-time interpretation of this rational number. Also the question arises about the possible relation with the integers characterizing space-time sheets having interpretation in terms of multi-p-adicity. One can assign to any rational number $q = m/n$ so called q-adic topology. This topology is not consistent with number field property like p-adic topologies. Hence the rational number q assignable to infinite prime could correspond to an effective q-adic topology.

If this interpretation is correct, arithmetic fermion and boson numbers could be coded into effective q-adic topology of the space-time sheets characterizing the non-determinism of Kähler action in the relevant length scale range. For instance, the power series of $q > 1$ in positive powers with integer coefficients in the range $[0, q)$ define q-adically converging series, which also converges with respect to the prime factors of m and can be regarded as a p-adic power series. The power series of q in negative powers define in similar converging series with respect to the prime factors of n .

I have proposed earlier that the integers defining infinite rationals and thus also the integers m and n characterizing finite rational could correspond at space-time level to particles with positive *resp.* negative time orientation with positive *resp.* negative energies. Phase conjugate laser beams would represent one example of negative energy states. With this interpretation super-symmetry exchanging the roles of m and n and thus the role of fermionic and bosonic lower level primes would correspond to a time reversal.

- (a) The first interpretation is that there is single q-adic space-time sheet and that positive and negative energy states correspond to primes associated with m and n respectively. Positive (negative) energy space-time sheets would thus correspond to p-adicity ($1/p$ -adicity) for the field modes describing the states.
- (b) Second interpretation is that particle (in extremely general sense that entire universe can be regarded as a particle) corresponds to a pair of positive and negative energy space-time sheets labelled by m and n characterizing the p-adic topologies consistent with m - and n -adicities. This looks natural since Universe has necessary vanishing net quantum numbers. Unless one allows the non-uniqueness due to $m/n = mr/nr$, positive and negative energy space-time sheets can be connected only by $\#$ contacts so that positive and negative energy space-time sheets cannot interact via the formation of $\#_B$ contacts and would be therefore dark matter with respect to each other.

Positive energy particles and negative energy antiparticles would also have different mass scales. If the rate for the creation of $\#$ contacts and their CP conjugates are slightly different, say due to the presence of electric components of gauge fields, matter antimatter asymmetry could be generated primordially.

These interpretations generalize to higher levels of the hierarchy. There is a homomorphism from infinite rationals to finite rationals. One can assign to a product of infinite primes the product of the corresponding rationals at the lower level and to a sum of products of infinite primes the sum of the corresponding rationals at the lower level and continue the process until one ends up with a finite rational. Same applies to infinite rationals. The resulting rational $q = m/n$ is finite and defines q-adic effective topology, which is consistent with all the effective p-adic topologies corresponding to the primes appearing in factorizations of m and n . This homomorphism is of course not 1-1.

If this picture is correct, effective p-adic topologies would appear at all levels but would be dictated by the infinite-p p-adic topology which itself could refine infinite-P p-adic topology [K79] coding information too subtle to be caught by ordinary physical measurements.

Obviously, one could assign to each elementary particle infinite prime, integer, or even rational to this a rational number $q = m/n$. q would associate with the particle q-adic topology consistent with a collection of p-adic topologies corresponding to the prime factors of m and n and characterizing the interactions that the particle can participate directly. In a very precise sense particles would represent both infinite and finite numbers.

Under what conditions space-time sheets can be connected by $\#_B$ contact?

Assume that particles are characterized by a p-adic prime determining its mass scale plus p-adic primes characterizing the gauge bosons to which they couple and assume that $\#_B$ contacts mediate gauge interactions. The question is what kind of space-time sheets can be connected by $\#_B$ contacts.

- (a) The first working hypothesis that comes in mind is that the p-adic primes associated with the two space-time sheets connected by $\#_B$ contact must be identical. This would require that particle is many-sheeted structure with no other than gravitational interactions between various sheets. The problem of the multi-sheeted option is that the characterization of events like electron-positron annihilation to a weak boson looks rather clumsy.
- (b) If the notion of multi-p p-adicity is accepted, space-time sheets are characterized by integers and the largest prime dividing the integer might characterize the mass of the particle. In

this case a common prime factor p for the integers characterizing the two space-time sheets could be enough for the possibility of $\#_B$ contact and this contact would be characterized by this prime. If no common prime factors exist, only $\#$ contacts could connect the space-time sheets. This option conforms with the number theoretical vision. This option would predict that the transition to large \hbar phase occurs simultaneously for all interactions.

12.2.4 Physically interesting p-adic length scales in condensed matter systems

The following table lists the p-adic length scales L_p . p near prime power of 2, which might be interesting as far as condensed matter is considered. It must be emphasized that the definition of length scale is bound to contain some unknown numerical factor and numbers should not be taken too literally.

k	127	131	137	139	149
L_p/m	$2.04E - 12$	$8.19E - 12$	$6.53E - 11$	$1.31E - 10$	$4.18E - 9$
k	151	157	163	167	173
L_p/m	$8.33E - 9$	$6.69E - 8$	$5.34E - 7$	$2.13E - 6$	$1.71E - 5$
k	179	181	191	193	
L_p/m	$1.37E - 4$	$2.74E - 4$	$8.85E - 3$	$1.75E - 2$	

Table 1. p-Adic length scales $L_p = 2^{k-127} L_{127}$, $p \simeq 2^k$, $L_{127} \equiv \frac{\pi\sqrt{5+Y}}{m_e}$, $Y = .0317$, k prime, possibly relevant to condensed matter physics.

Notice that the length scales $L(137)$ and $L(139)$ are quite near to the typical atomic length scale and this suggests that the lattice structures of solid state physics might be understood in terms of structures formed by gluing together p-adic cubes with size $L(137)$ by join along boundaries contacts.

12.3 Hydrodynamical and thermodynamical hierarchies

The existence of p-adic length scale hierarchy suggests a new approach to hydrodynamics. There is hydrodynamic flow associated with each condensate level h . The particles at level are condensate blocks of the previous level having typically size $L_{upper}(k)$ larger than $L(k)$ and hydrodynamic approximation fails at this length scale. It will be found that the phenomenon of sono-luminescence can be interpreted as evidence for the hydrodynamical hierarchy. The masses of these particles are just the masses of condensate blocks. The energy dissipation at given level takes place via the collisions of condensate blocks and one can get an order of magnitude estimate for the viscosity $\nu(k)$ and other transport coefficients at level k using kinetic gas theory for condensate blocks.

There must exist also energy transfer mechanism transporting energy and angular momentum to higher condensate levels and eventually to atomic condensation level and this mechanism should be work at length scales $L < L_{upper}(k)$, at which hydrodynamic approximation fails at level k . The mechanism to be proposed is completely analogous with the penetration of magnetic fields into super conductor and should be possible in sufficiently long length scales: the convective zone of Sun provides a possible realization of the mechanism. The hierarchy means quite rich possibilities for flows: the fluid need not be in same phase at all levels, the temperatures (temperature distributions) at different levels need not be identical. The character of the flow need not be same at different levels (turbulent/ non-turbulent, rotational/irrotational, etc).

12.3.1 Dissipation by the collisions of condensate blocks

Collisions of condensate blocks at level k provide one possible dissipation mechanism and just as in molecular case the mechanism can be characterized viscosity coefficient. One can generalize kinetic gas theory estimate for the kinetic viscosity at level k in straightforward manner.

$$\begin{aligned}
 \nu(k) &= \lambda(k)\beta , \\
 \lambda(k) &= \frac{1}{N(\text{block})\sigma(k)} , \\
 \sigma(k) &\sim 4\pi L_{\text{upper}}^2(k) , \\
 N(\text{block}) &\sim \frac{1}{L_{\text{upper}}(k)^3} , \\
 \beta &\sim \beta_{\text{th}} \sim \sqrt{\frac{T(k)}{M(\text{block})}} , \\
 M(\text{block}) &\sim N(\text{nucleus})ML_{\text{upper}}^3(k) ,
 \end{aligned} \tag{12.3.1}$$

where the average velocity β is replaced with thermal velocity to obtain order of magnitude estimate. More explicitly,

$$\begin{aligned}
 \nu(k) &= \sqrt{\frac{L(139)}{L_{\text{upper}}(k)}} \nu(139) , \\
 \nu(139) &= \frac{1}{4\pi N(\text{nucleus}, 139)} \sqrt{\frac{T}{M}} L(139) .
 \end{aligned} \tag{12.3.2}$$

The order of magnitude $\nu(139)$ is roughly the same as the order of magnitude for ordinary viscosity at room temperatures determined by the size of the atom. From formula it is clear that $\nu(k)$ scales as $\sqrt{1/L(k)}$. This means that the importance of the collisions of the condensate blocks as dissipation mechanism decreases rapidly in long p-adic length scales. This does not necessarily mean the absence of dissipation since mechanisms of energy transfer between condensate levels must exist. Reynolds number criterion implies that the flow is in sufficiently long p-adic length scales always turbulent.

The collisions of the condensate block need not be elastic and the collision at level k in general involves simultaneous collisions at levels $k_1 < k$ up to atomic condensate levels so that it leads to energy dissipation at all condensate levels $k_1 \geq k$. An interesting challenge is the description of shock waves in this picture. A shock wave at level k corresponds to 'traffic jam' in shock front involving the collisions of the condensate blocks at level k . This in turn is expected to lead to shock waves propagating inside condensate blocks at level $k_{\text{prev}} < k$ and so on. Shock wave hierarchy ends up to the atomic condensate level $k = 131$.

12.3.2 Energy transfer between different condensate levels in turbulent flow

The model for the generation of hydrodynamic turbulence is based on the idea that hydrodynamic vortices correspond to topological field quanta, that is cylindrical 3-surfaces with finite radius carrying Kähler electric and magnetic fields. The completely new feature is the presence of ordinary or Z^0 magnetic fields determining the size of the hydrodynamic vortices. Even the Reynolds number criterion could be formulated in terms of these fields. The naive expectation would be that the vortices could be characterized as either em or Z^0 vortices. This is actually

not the case since induced gauge field concept implies that em fields are accompanied by Z^0 fields and vice versa for extremals of Kähler action. The study of the imbeddings for Kähler electric and magnetic fields led to the conclusion that vorticities are specified by two frequency type parameters ω_i and by two integers n_i related to the space-time dependence of the phases of the two complex CP_2 coordinates plus and integer m : the vortices with different value of fractal quantum number m were related by a power of a discrete scaling transformation to each other. The decay of vortices to smaller vortices leading to a cascade was suggested to be the basic mechanism for the generation of turbulence. The model led to estimates for Reynolds number for the transition to turbulence in channel flow and for the exponent Δ appearing in the Fourier transform $T(k) \propto k^\Delta$ of the kinetic energy density of the flow. In recent context the model for the decay of vortices can be regarded as a kinetic model for the vortices of level k appearing as particles at the level k_{next} .

p-Adic picture of condensed matter suggests a considerable generalization of this model. Of course, a lot of work is needed to construct a detailed quantitative model but some general features of the model are evident.

- (a) The proposed cascade mechanism as such works at single condensate level for vortices having size larger than $L_{upper}(k)$: below this length scale the hydrodynamic approximation fails. The lower bound for the vortex size was assumed to be some scale not much above atomic size so that description might apply as such at condensate level $k = k_Z$.
- (b) The idea already due to Kolmogorov [B50] is that the generation of turbulence involves the interaction between many length scales: in turbulent situation constant power ϵ is feeded to the system of size l and the rate of the energy flow between any subsequent levels in the hierarchy of length scales is constant and dissipation becomes important at the highest levels of the hierarchy, which correspond to the shortest length scales $L_0 \sim l/Re^{3/4}$ related by to the length scale of the entire flow. This idea leads directly to important dimensional estimates making possible to deduce the form of the velocity correlation function in length scales at which dissipation is not important. It is perhaps worth of recalling that the turbulence model gives slightly different value for the exponent Δ associated with the energy density.

This interaction between different scales corresponds to the decay of vortices to smaller vortices with scaled down values of the vorticity and critical radius: this picture probably still applies at single condensate level down to the vortex radii of order $L_{upper}(k)$, where the hydrodynamical approximation fails. If the size of the block is much larger than the size λ_0 of eddies important for energy dissipation (having Reynolds number of order one) collisions of the condensate blocks at level k cannot take care of energy dissipation. Using the standard order of magnitude estimate for λ_0 [B50] the criterion for dissipation via collisions to be possible reads as

$$\begin{aligned} L_{upper}(k) &< \lambda_0(k) , \\ \lambda_0(k) &= \frac{l}{Re^{3/4}(k)} = \left(\frac{L(139)}{L(k)}\right)^{3/8} \lambda_0(139) . \end{aligned} \tag{12.3.3}$$

$\lambda_0(139)$ is roughly of same order of magnitude as the estimate based on molecular viscosity and it is clear that in long p-adic length scales the condition cannot be met. One has $\lambda_0(k) \sim 2^{-(k-139)/2} 10^{-3} l$ (assuming for definiteness $R \sim 10^4$ in turbulent flow) and L is bound to be smaller than $L_{upper}(k)$ unless l is very large as compared with $L(k)$. Since constant energy dissipation is taking place there must exist some mechanism of energy and angular momentum transfer between condensate levels and this mechanism is expected to be at work below the length scales below, at which hydrodynamic approximation works.

The structure of the topological condensate suggests much more general realization for the idea about interacting length scales: besides vortices related by powers of discrete scaling transformation also different levels k of topological condensate correspond to the levels of the hierarchy.

The external source of energy and angular momentum is at some level $k \gg 131$ (a concrete example is provided by channel flow) and the flow of energy occurs first from large to smaller eddies at level k in accordance with the standard picture and continues to the higher level k_{prev} via some energy transfer mechanism and repeats itself at level k_{prev} .

If condensate has hierarchical structure the flow occurs in good approximation only between two subsequent condensate levels. The previous work suggests that the mechanism is based on generation of vortices at level k_{cr} and that ordinary and Z^0 magnetic fields might play key role in the mechanism. The length scale $L(k_Z)$ means clearly a borderline in the generation of turbulence. For levels with $k > k_Z$ the electro-weak gauge fields are of Z^0 and em type and there is no motion in atomic length scales. At level $k = k_Z$ the motion is transferred to atomic level since nuclei feed their Z^0 charges directly at $k = k_Z$ level. At levels $k > k_Z$ ordinary magnetic vortices should take the role of Z^0 and em vortices. $k = k_Z$ level is special in the sense that the entire fluid motion at length scales $k > k_Z$ is seen in the flow pattern of $Z^0 \#$ throats at this level. It should be also noticed that p-adic quantized version of hydrodynamics (whatever it might mean!) is in principle involved at level $k = k_Z$.

p-Adic TGD suggests a detailed mechanisms for the flow of energy, angular momentum and magnetic flux from level k to level k_{prev} .

- (a) In the simplified description there are two kind of lumps of rotational energy at level k . The rigid body rotation of the condensate blocks of level k_{prev} condensed on level k and the vortices formed by the condensate blocks, each block rotating according to the law $\beta(\rho) = K/\rho$, where K is vorticity (essentially the total angular momentum) and ρ the distance from the vortex axis. The basic energy transfer process must take place at the level of single condensate block of size not very much larger than $L(k)$ produced as the end result of the cascade process. The block is in rigid body rotation and the destruction of the super fluidity by rigid body rotation of the vessel containing super fluid suggests the mechanism. When the approximately constant magnetic field created by vortex motion at level k is sufficiently strong at the position of the block it penetrates to the level k_{prev} .
- (b) According to the previous proposal this mechanism is following. For $\Omega < \Omega_{crit}$ the Z^0 and/or em magnetic fields created by the rotation of the $\#$ throats on the boundary of the block at level k are those of an extended magnetic dipole: inside the vortex the field lines run in the direction of vortex. For $\Omega = \Omega_{cr}$ something very peculiar happens: the magnetic field created by the rotational flow penetrates to the higher condensate level via $\#$ contacts formed at the upper and lower end of the vortex, which behave as magnetic dipoles at levels k and k_{prev} . This means that the magnetic flux runs from the level k to k_{prev} and vice versa at the opposite ends of the vortex and the conservation of magnetic flux implies that average magnetic fluxes are identical on the two levels. The field inside the vortex cylinder disappears at level k and only the field lines of the return flux outside the vortex are preserved. Since magnetic flux and angular momentum are closely related this requires that the rotating block is set in rigid body motion with angular momentum opposite to the angular momentum of the entire block in vortex motion. There blocks in vortex would rotate in opposite direction as compared to the vortex and angular momentum is indeed transferred from level k to k_{prev} .
- (c) The analogy with super conductivity/super fluidity suggests that the process cannot take place for too small value of magnetic field/rotational velocity at level k . Since the vorticity can be written as $K = \beta\rho$ the condition $K > K_{cr}$ is analogous (but not equivalent) with the Reynolds number criterion $ud > Re_{cr}\nu$. The criterion $K > K_{cr}$ translates into the condition $B > B_{cr}$. The physical content of the condition is probably the following. In the absence of the vortices liquid at level k_{prev} tends to form large join along boundaries blocks: for dense liquids only very few large join along boundaries block are present whereas for the gases there are only few join along boundaries bonds present. The formation of vortices splits join along boundaries bonds at the boundaries of the vortices and some energy $E_{join}(k)$ must be taken from the flow to split single join along boundaries bonds if present.
- (d) The criterion for the penetration of magnetic field must be local in the sense that only the energetics of a single join along boundaries bond is involved. A natural guess is that the

magnetic energy contained in the volume of the bond is larger than the binding energy of the bond: $E_B > E(\text{join})$. Since B is proportional to the vorticity K , the criterion gives critical vorticity K_{cr} . The dependence of $E_B \propto b/L^3(k)$ with b integer implies that the dependence of E_B and $E(\text{join})$ on $L(k)$ is same and K_{cr} does not depend on condensate level. In this case $K_{cr} < K_{Re} \equiv ud = Re \cdot \nu$ holds true unless b is very large integer of order 10^{39} and criterion is identically satisfied for turbulent flow. If b is rational number with small denominator, one has effectively $E_{\text{join}} = b/L(k)$ for the real counter part of the energy and one obtains $K_{cr} \propto L(k)$, which is probably the correct alternative. In sufficiently long length scales (perhaps all physically interesting length scales) one has $K_{cr} > K_{Re} \equiv ud = Re \cdot \nu$, which implies a lower bound for the size of the vortices of the turbulent flow in the range $K_{Re} < K < K_{cr}$. This means that for liquids the energy transfer mechanism comes into play for very large Reynolds numbers only and should manifest itself in long (perhaps astrophysical) length scales only. For gases the situation is different since the criterion makes sense only provided the density of the join along boundaries bonds is large (incompressible flow) and in ordinary gas flow the criterion is not needed.

- (e) The disappearance of the vortices at the highest condensation levels can be regarded as resulting from the annihilation of magnetic monopoles associated with the upper and lower ends of the vortices. One possibility is self destruction, when the mopoels and upper and lower ends annihilate. Second possibility is the annihilation of two different vortices. At lower level the process implies the recombination of the magnetic field lines at positions of monopoles.
- (f) A possible astrophysical example of the proposed energy transfer process is provided by the convective zone of the Sun, where the presence of the magnetized vortex like structures of all sizes is directly visible. Only observational limitations set lower bound for the radii of the vortices. The ends of the magnetic dipoles are visible and also the recombination of field lines of magnetic fields (this can be regarded as annihilation of magnetic monopoles!) occurs frequently [E198] .
- (g) The assumption that the flow consists of vortices carrying almost constant magnetic fields, is not necessary. What is important is the behavior of the magnetic field created by the main flow in the region of single condensate block participating in the flow. If the magnetic field does not vary much in the region of the block, the penetration can take place via the same mechanism into the block. A possible test for the proposed scenario is the flow in the external magnetic field at level $k < k_Z$: for some critical value of field (probably rather high) the flow should become turbulent. One can also consider creating external Z^0 magnetic fields in the interior of, say rotating cylinder, and finding whether they affect the properties of the non-turbulent flow inside the cylinder.

12.3.3 The magnetic fields associated with vortex and rigid body flows

The magnetic field associated with vortex flow $\beta = K/\rho$ (ρ is the distance from the axis of vortex) is given by

$$\begin{aligned}
 B_C &= A_C K \ln\left(\frac{\rho}{\rho_0}\right), \quad C = em, Z, \\
 A_C &= \frac{g_C q_C}{\sqrt{\epsilon_C(k)}} n(\text{nucleus}), \\
 Q_Z &= (A - Z) Q_Z(n) \quad Q_{em} = Z,
 \end{aligned} \tag{12.3.4}$$

where ρ_0 is some finite radius at which the flow ceases to be vortex flow and is expected to change to rigid body flow (single condensate block rotates as rigid body). ϵ_C will be assumed to satisfy the simple scaling law $\epsilon_C(k) \propto L(k)^6$. The field is in good approximation constant in region of vortex so that critical field condition leading to the penetration of the field to higher level occurs almost simultaneously in vortex but proceeds from boundary to interior.

The magnetic field associated with rigid body flow $\beta = \Omega\rho$ is given by

$$B_C = A_C \Omega \frac{\rho^2}{2} , \quad (12.3.5)$$

where the parameter A_C defined in previous formula. At critical value of vortex magnetic field condensate blocks rotating in vortex flow like rigid bodies begin to rotate counterclockwise with regard to the vortex flow and the angular rotation velocity is such that

- i) the magnetic fluxes created by rigid body flow and vortex flow cancel each other or
- ii) angular momentum in the region of condensate block is transferred to higher condensate level.

Denoting the radius of a rigidly rotating block in the vortex flow by ρ_{rig} and by ρ_1 the distance of the block from the axis of vortex flow one obtains for the value of the angular velocity parameter Ω

$$\begin{aligned} \Omega &\simeq \frac{2K}{\rho_{rig}^2} X , \\ X &= \ln(\rho_1/\rho_0) . \end{aligned} \quad (12.3.6)$$

An almost identical condition

$$\Omega \simeq \frac{2K}{\rho_{rig}^2} , \quad (12.3.7)$$

is obtained if one requires that entire angular momentum of the rigidly rotating block in vortex flow is transferred to higher condensate level so that the two models are equivalent with logarithmic accuracy.

12.3.4 Criticality condition

Consider next the criticality condition for vortex magnetic field or equivalently vorticity $K \sim ud$ to derive the analog of Reynolds number criterion $ud > Re \cdot \nu$ for single vortex. The condition states that magnetic field energy in the volume of join along boundaries contact is larger than join along boundaries bonding energy E_{join} .

$$E_B(bond) > E_{join} , \quad (12.3.8)$$

to derive more quantitative criterion one must make some additional assumptions. The volume of join along boundaries bond at level k is assumed to be of order $L^3(k)$ since bond should consist of few p-adic cubes glued together along their walls. E_{join} is of form $bp^{3/2}$ p-adically. If b is integer the real counterpart of the energy behaves as $1/L(k)^3$ and if b is rational number with small denominator the real counterpart of energy behaves as $a/L(k)$, $a < 1$.

The following argument suggests that b must be a genuine rational number. The radius ρ_{cr} of the condensate block determined from the imbeddability requirement of the magnetic field as induced gauge field must be equal to the radius $L_{upper}(k) \propto L(k)$ of the block determined by the stability against topological evaporation. This is possible only provided $\rho_{cr} \propto L(k)$ holds true. It will be later found that the dependence of ρ_{cr} on p-adic length scales is as follows

$$\rho_{cr} \propto \frac{\epsilon_C^{1/4}}{K^{1/2}} \propto \frac{L(k)^{3/2}}{b^{1/2}} . \quad (12.3.9)$$

For integer b this gives $\rho_{cr} \propto L(k)^{3/2}$ so that the critical radius is larger than $L_{upper}(k)$ at large length scales. If b is rational number one indeed has $\rho_{cr} \propto L(k)$ and ρ_{cr} . In this case both K_{cr} and ρ_{cr} are proportional to $L(k)$ as suggested by fractality.

If Z^0 magnetic fields dominate at levels $k > k_Z$ levels the condition reduces for $E_{join} = b/L(k)$ to the form

$$\begin{aligned} K &> K_{cr}(k) , \\ K_{cr}(Z, k) &= K_Z L(k) , \\ K_Z &= b^{1/2} 2^{-41} \frac{\sqrt{\epsilon_Z(k_Z)}}{g_Z(A-Z)} B , \\ B &= \frac{\sqrt{2}}{N(\text{nucleus}, 139)} \frac{1}{\ln(\frac{\rho_1}{\rho_0})} , \end{aligned} \quad (12.3.10)$$

which gives $K_{cr}(k) \sim \sqrt{b} \cdot 5 \cdot 10^{-2} L(k)$ for $\epsilon_Z(k_Z) \sim 10^{24}$. At condensate levels $k < k_Z$, where ordinary magnetic fields are in question, the condition reads

$$\begin{aligned} K_{cr}(em, k) &= K_{em} L(k) , \\ K_{em} &= b^{1/2} 2^{12} \frac{\sqrt{\epsilon_Z(131)}}{Ze} B L(k) . \end{aligned} \quad (12.3.11)$$

B is given by the previous formula. This gives $K_{cr}(k) \sim \sqrt{b} 10^4 L(k)$ ($b < 1$). The value of $K_{Re} = Re \cdot \nu$ is of order $10^{-10} m$ for typical values $Re = 10^4$ and $\nu \sim 10^{-14} m$ so that K_{cr} is always larger than K_{Re} unless b is very small. This means that below the length scale $L(k_Z)$ the proposed energy transfer mechanism comes into play at very large Reynolds numbers of order

$$Re \sim \frac{K_{cr}(em, k)}{\nu} \sim 10^5 b^{1/2} \frac{L(k)}{L(107)} , \quad (12.3.12)$$

whereas for gas phase the situation is different. When $L_{upper}(k)$ is much larger than the size $L_0 \sim l/Re^{3/4}$ for dissipative eddies with $Re \sim 1$ and $K < K_{cr}$ so that the collisions of the join along boundaries blocks nor the proposed energy transfer mechanism cannot take care of the dissipation and some other mechanisms of dissipation must be active: one possibility is heating leading to the splitting of the join along boundaries bonds.

The assumption that the mechanism is at work in the convective zone of Sun gives information on the value value of the parameter b . Assuming $\beta \sim 10^{-5}$ and $L_{upper}(k) \sim 10^7 m$ one obtains from $K \sim L_{upper}\beta \sim 10^2 m$. The criterion gives $b^{1/2} L(k) \leq 2 \cdot 10^2 m$. An estimate for b is obtained using the relation $L_{upper}(k) \leq AL(k), A \sim 10^2$: for $L_{upper} \sim 10^2 L(k)$ one obtains $b \sim 4 \cdot 10^{-6}$. $L(k)$ and therefore b can be estimated if one has some idea about the value of B_Z : this together with estimate for K gives grasp on the value of $\epsilon_Z(k)$ and scaling law gives estimate for $L(k)$.

The condition implies that typical angular velocities Ω for rigid body rotation behave as $\Omega(k) \propto 1/L(k)$ and that average rotation velocities $\beta(k)$ are identical for all condensate levels. This implies that the frequency spectrum associated with the flow is superposition of form

$$F_{tot}(\omega) = \sum_{k \text{ prime}} a_k F\left(\omega \frac{L(k_0)}{L(k)}\right), \quad (12.3.13)$$

and the general form of the spectrum in principle provides a test for p-adic length scale hypothesis. $\beta(k) = \text{constant}$ suggests that spatial correlation function for velocity is constant and its Fourier spectrum corresponds to white noise spectrum.

For completeness it is useful to give the values of K_{cr} also for the $E_{join} = bL_0^2/L^3(k)$ ($L_0 \sim 10^4\sqrt{G}$ being the fundamental p-adic length scale) case.

$$K_{cr}(C) = k_C L_0. \quad (12.3.14)$$

The only difference with respect to previous formulas is the replacement $L(k) \rightarrow L_0$. For small values of b the condition is automatically satisfied for reasonable values of K and the sizes of vortices should have no lower bound above atomic length scales: this is not in accordance with the estimate $\lambda_0 \sim l/Re^{3/4}$ of Kolmogorov theory.

12.3.5 Sono-luminescence, Z^0 plasma waves, and hydrodynamic hierarchy

Sono-luminescence [D6] , [D6] is a peculiar phenomenon, which might provide an application for the hydrodynamical hierarchy. The radiation pressure of a resonant sound field in a liquid can trap a small gas bubble at a velocity node. At a sufficiently high sound intensity the pulsations of the bubble are large enough to prevent its contents from dissolving in the surrounding liquid. For an air bubble in water, a still further increase in intensity causes the phenomenon of sono-luminescence above certain threshold for the sound intensity. What happens is that the minimum and maximum radii of the bubble decrease at the threshold and picosecond flash of broad band light extending well into ultraviolet is emitted. Rather remarkably, the emitted frequencies are emitted simultaneously during very short time shorter than 50 picoseconds, which suggests that the mechanism involves formation of coherent states of photons. The transition is very sensitive to external parameters such as temperature and sound field amplitude.

A plausible explanation for the sono-luminescence is in terms of the heating caused by shock waves launched from the boundary of the adiabatically contracting bubble [D6] , [D6] . The temperature jump across a strong shock is proportional to the square of Mach number and increases with decreasing bubble radius. After the reflection from the minimum radius $R_s(\text{min})$ the outgoing shock moves into the gas previously heated by the incoming shock and the increase of the temperature after focusing is approximately given by $T/T_0 = M^4$, where M is Mach number at focusing and $T_0 \sim 300 \text{ K}$ is the temperature of the ambient liquid. The observed spectrum of sono-luminescence is explained as a brehmstrahlung radiation emitted by plasma at minimum temperature $T \sim 10^5 \text{ K}$. There is a fascinating possibility that sono-luminescence relates directly to the classical Z^0 force: this point is discussed in [K77] .

Even standard model reproduces nicely the time development of the bubble and sono-luminescence spectrum and explains sensitivity to the external parameters [D6] , [D6] . The problem is to understand how the length scales are generated and explain the jump-wise transition to sono-luminescence and the decrease of the bubble radius at sono-luminescence: ordinary hydrodynamics predicts continuous increase of the bubble radius. The length scales are the ambient radius R_0 (radius of the bubble, when gas is in pressure of 1 atm) and the minimum radius $R_s(\text{min})$ of the shock wave determining the temperature reached in shock wave heating. Zero radius is certainly not reached since shock front is susceptible to instabilities.

Since p-adic length scale hypothesis introduces a hierarchy of hydrodynamics with each hydrodynamics characterized by a p-adic cutoff length scale there are good hopes of achieving a better understanding of these length scales in TGD. The change in bubble size in turn could be understood as a change in the 'primary' condensation level of the bubble.

- (a) The bubble of air is characterized by its primary condensation level k . The minimum size of the bubble at level k must be larger than the p-adic length scale $L(k)$. This suggests that the transition to photo-luminescence corresponds to the change in the primary condensation level of the air bubble. In the absence of photo-luminescence the level can be assumed to be $k = 163$ with $L(163) \sim .76 \mu m$ in accordance with the fact that the minimum bubble radius is above $L(163)$. After the transition the primary condensation level of the air bubble is $k = 157$ with $L(157) \sim .07 \mu m$. In the transition the minimum radius of the bubble decreases below $L(163)$ but should not decrease below $L(157)$: this hypothesis is consistent with the experimental data [D6] , [D6] .
- (b) The particles of hydrodynamics at level k have minimum size $L(k_{prev})$. For $k = 163$ one has $k_{prev} = 157$ and for $k = 157$ $k_{prev} = 151$ with $L(151) \sim 11.8 nm$. It is natural to assume that the minimum size of the particle at level k gives also the minimum radius for the spherical shock wave since hydrodynamic approximation fails below this length scale. This means that the minimum radius of the shock wave decreases from $R_s(min, 163) = L(157)$ to $R_s(min, 157) = L(151)$ in the transition to sono-luminescence. The resulting minimum radius is $11 nm$ and much smaller than the radius $.1 \mu m$ needed to explain the observed radiation if it is emitted by plasma.

A quantitative estimate goes along lines described in [D6] , [D6] .

- (a) The radius of the spherical shock is given by

$$R_s = At^\alpha , \quad (12.3.15)$$

where t is the time to the moment of focusing and α depends on the equation of state (for water one has $\alpha \sim .7$).

- (b) The collapse rate of the adiabatically compressing bubble obeys

$$\frac{dR}{dt} = c_0 \left(\frac{2}{3\gamma} \frac{\rho_0}{\rho} \left(\frac{R_m}{R_0} \right)^3 \right)^{1/2} , \quad (12.3.16)$$

where c_0 is the sound velocity in gas, γ is the heat capacity ratio and ρ_0/ρ is the ratio of densities of the ambient gas and the liquid.

- (c) Assuming that the shock is moving with velocity c_0 of sound in gas, when the radius of the bubble is equal to the ambient radius R_0 one obtains from previous equations for the Mach number M and for the radius of the shock wave

$$\begin{aligned} M &= \frac{dR_s}{c_0} = (t_0/t)^{\alpha-1} , \\ R_s &= R_0(t/t_0)^\alpha , \\ t_0 &= \frac{\alpha R_0}{c_0} . \end{aligned} \quad (12.3.17)$$

where t_0 is the time that elapses between the moment, when the bubble radius is R_0 and the instant, when the shock would focus to zero radius in the ideal case. For $R_0 = L(167)$ (order of magnitude is this) and for $R_s(min) = L(151)$ one obtains $R_0/R_s(min) = 256$ and $M \simeq 10.8$ at the minimum shock radius.

(d) The increase of the temperature immediately after the focusing is approximately given by

$$\frac{T}{T_0} \simeq M^4 = \left(\frac{R_0}{R_s}\right)^{\frac{4(1-\alpha)}{\alpha}} \simeq 1.3 \cdot 10^4 . \tag{12.3.18}$$

For $T_0 = 300 \text{ K}$ this gives $T \simeq 4 \cdot 10^6 \text{ K}$: the temperature is far below the temperature needed for fusion.

In principle the further increase of the temperature can lead to further transitions. The next transition would correspond to the transition $k = 157 \rightarrow k = 151$ with the minimum size of particle changing as $L(k_{prev}) \rightarrow L(149)$. The next transition corresponds to the transition to $k = 149$ and $L(k_{prev}) \rightarrow L(141)$. The values of the temperatures reached depend on the ratio of the ambient size R_0 of the bubble and the minimum radius of the shock wave. The fact that R_0 is expected to be of the order of $L(k_{next})$ suggests that the temperatures achieved are not sufficiently high for nuclear fusion to take place.

12.3.6 p-Adic length scale hypothesis, hydrodynamic turbulence, and distribution of primes

The work of Indian meteorologists Mary Selvam [H10] related to the turbulent atmospheric flows provides additional very interesting insight to p-adic length scale hypothesis and suggests that n-ary p-adic length scales corresponding to very large values of n are realized in hydrodynamical turbulence, and that hydrodynamical vortices could be regarded as elementary particle like objects on the space-time sheets at which they are condensed topologically.

1. *The distribution of vortex sizes is same as distribution of primes*

Selvam studies the distribution for the ratio $z = R/r$ of large vortex radius R to smallest vortex radius r , and finds that this distribution is the same as the distribution of primes in region of rather small primes. This could be understood if vortex radii are prime multiples of r

$$R = kr \text{ , } k \text{ prime ,}$$

and if each prime appears with the same probability. This assumption can be actually loosened: one can also interpret r as the p-adic length scale associated with minimum size vortex interpreted as space-time sheet. Selvam also argues that vortex dynamics has quantal features and that vortices could in some aspects be regarded as quantum objects.

2. *p-Adic length scale hypothesis from elementary particle blackhole analogy*

One can try to understand results on basis of the p-adic length scale hypothesis $p \simeq 2^{k^m}$, k prime, m positive integer.

(a) At quantum level p-Adic length scale hypothesis follows from the generalization of Hawking-Bekenstein law for the radius of elementary particle horizon defined as the surface at which the Euclidian signature of the induced metric of the space-time sheet containing topologically condensed particle changes to Minkowskian signature of the metric in regions faraway from particle. Ordinary elementary particles corresponds to CP_2 type extremals condensed on larger space-time sheet with size of order $L_p = \sqrt{pl}$, $l \simeq 10^4$ Planck lengths. Generalized Hawking-Bekenstein law implies that the p-adic entropy of elementary particle characterized by p-adic prime p is proportional to the surface area of the elementary particle horizon. Since entropy is proportional to $\log(p)$, the radius r of the elementary particle horizon satisfies $r^2 \propto \log(p)$.

- (b) The idea is to require that the radius of the elementary particle horizon itself is m-ary p-adic length scale. For $p \simeq 2^{k^m}$ this is indeed the case if generalized Hawking-Bekenstein law holds and one has

$$r = \sqrt{k^m} \times l \ , \ k \text{ prime} \ .$$

For $m = 2$ one has

$$r = kl \ .$$

This is the same law as holds true for the vortex radii except that l corresponds to Planck length scale rather than macroscopic size of the minimal vortex. Therefore a generalization replacing l with the size of the minimal vortex is needed.

3. Does generalization of Hawking-Bekenstein hold true also for vortices regarded as elementary particles?

One must be able to generalize the notion of elementary particle by allowing also larger space-time surfaces than CP_2 extremals as models of particle and to assume that the metric of the space-time sheet at which particle is condensed has Euclidian metric signature inside the particle region, now inside the region covered by vortex.

- (a) A more general situation allowed by the p-adic length scale hypothesis corresponds to vortices topologically condensed at space-time sheets with size of order of n-ary p-adic length scale

$$L_p(n) = p^{n/2} L_p \ , \ p \simeq 2^{k^m} \ .$$

In this case generalized Hawking-Bekenstein law implies that the radius of the elementary particle horizon is given by

$$r = k^m \times L \ , \ L = \frac{n}{2} \times l \ .$$

$m = 2$ applies in the situation studied by Mary Selvam. Also the values of k can be small in this case. What is important is that the fundamental p-adic length scale l has been effectively replaced by $L = nl/2$. This is in accordance with the idea of fractality.

- (b) The requirement that r is also now p-adic length scale would imply that the length scale $k^m \times \frac{n}{2} \times l$ is p-adic length scale. This does not make sense except possibly as an approximation. p-Adic length scale hypothesis however suggests that the new fundamental length scale L itself is some n-ary p-adic length scale. The simplest possibility is that $n/2$ is large prime p_1 so that one has

$$n = 2p_1 \ , \ r = p_1 l \ .$$

$L = p_1 l$ and clearly corresponds to the secondary p-adic length scale associated with p_1 satisfying itself p-adic length scale hypothesis $p_1 \simeq 2^{k_1^{m_1}}$. This assumption provides the scenario with strong predictive power since the number of the secondary p-adic length scales is not very high.

3. Does atmospheric turbulence provide a fractally scaled version of elementary particle physics?

In the length scale range between .1 meters and Earth circumference the following p-adic primes $p_1 = n/2$ are possible:

$$p_1 \simeq 2^{k_1^{m_1}} \ , \\ k_1^{m_1} = 101, 103, 107, 109, 113, 11^2 = 121, 5^3 = 125, 127 \ .$$

There would be only 8 minimal vortex sizes in this length scale range, which is very strong and testable prediction. What is fascinating is that these secondary length scales correspond to the p-adic primes associated with quarks, atomic nuclei, and leptons so that the physics of vortices in atmosphere might in some sense be regarded as a fractal copy of elementary particle and nuclear physics! Note that the length scale $L(n, k)$ giving the size of the space-time sheet at which vortex is condensed, is given by

$$L(n, k^2) \simeq 2^{2^{k_1-1} \times k^2} ,$$

and is completely super-astronomical already for small values of k .

4. Does the space-time region at which vortex is condensed have Euclidian metric signature?

What this model implies is that the induced metric at the space-time sheet at which vortex is condensed, should have Euclidian signature inside radius r . TGD indeed allows huge number of vacuum extremals with Euclidian signature: signature becomes Euclidian if the dependence of the CP_2 coordinates on M_+^4 coordinates is too fast. The simplest situation is encountered when the angle coordinate ϕ associated with CP_2 geodesic circle satisfies the condition $\phi = \omega t$, $\omega \geq 1/R$, where $2\pi R$ is the length of the CP_2 geodesic circle and t is Minkowski time coordinate. From this it is clear that time gradients must be typically larger than $1/R$, where R is CP_2 size, for Euclidization to happen. Also criticality of the preferred extremals of Kähler action (there exists infinite number of deformations with a vanishing second variation) is consistent with the formation of Euclidian regions. Thus field equations support the idea that space-time sheets can contain Euclidian regions of even macroscopic size. Inside the region covered by the vortex light would not propagate at all and Euclidian regions would be in some respects analogous to black holes. Vortex space-time sheets itself would obey good old Minkowskian physics.

5. Connection with dark matter hierarchy

The remarks above were written much before the realization that TGD "predicts" a dark matter hierarchy with the values of Planck constant $\hbar(n) = \lambda^n \hbar(1)$, $\lambda = n/v_0 \simeq n \times 2^{11}$, $n = 1, 2, \dots$. λ is predicted to be integer and also sub-harmonics could be allowed. This means that also the scaled up variants of the p-adic length scale hierarchy appears. For the preferred value of $\lambda \simeq 2^{11}$ precise predictions of preferred time and length scales corresponding to small values of p-adic primes follow. In particular, the TGD based interpretation [K72, K25] of Nottale's proposal [E175] for the quantization of planetary orbits in terms of a gigantic value of gravitational Planck constant means that huge scalings are possible so that quantum effects are present in astrophysical and even cosmological length scales. The proposed picture might be consistent with this view since also $\hbar(1)$ is predicted to have a discrete spectrum varying by a factor 2.

12.3.7 Thermodynamical hierarchy

p-Adic TGD suggests the replacement of the ordinary thermodynamic description of the condensed matter with a hierarchy of p-adic thermodynamics, one for each p-adic level. Above the p-adic length scale $L(k)$ this thermodynamics is ordinary real thermodynamics. Below the length scale $L(k)$ p-adic thermodynamics is probably needed (assuming that thermodynamic description makes sense at all).

The general formulation might look like follows.

- (a) There is thermodynamics associated with each p-adic level of the condensate (in analogy with p-adic conformal field theory limit of TGD). The order parameters for ordinary condensed matter are particle densities at each level of the condensate. Besides this block densities describing the density of $p_1 < p_2$ -adic blocks of matter at level $p_2 > p_1$ are present. Join along boundaries gives rise to bound state formation and corresponding densities can also be present. In spin systems also block densities for spin are present and can be identified as densities for magnetic domains with preferred sizes given by the p-adic cutoff length scales $L(k)$ given by prime powers of two.

- (b) The basic variational principle is the absolute minimization of free energy subject to certain constraints such as the constraint fixing total pressure: absolute minimization would be in accordance with the absolute minimization of Kähler action and implies the so called Maxwell rule for phase transitions. Free energy contains three parts: the 'ordinary' free energy F_{ord} , TGD based contribution to free energy and constraint term

$$F = F_{TGD} + F_{ord} + F_{constraint} . \quad (12.3.19)$$

The 'ordinary' free energy F_{ord} at level p is sum of single particle free energies for p_1 -adic blocks with $p_1 < p$ and the block-block interaction energies plus higher order interaction energies

$$F_{ord} = \sum_i F_i + \sum_{ij} F_{ij} + \dots . \quad (12.3.20)$$

The index $p_1 \simeq 2^k$, k prime, labelling different p_1 -blocks is included in the index i . Ordinary thermodynamics suggests general forms for these terms. By fractality the various parameters appearing in free energies associated with different p-adic levels should be related by simple scaling laws. For instance, van der Waals type form should be appropriate for the free energy associated with a given block density of fluid at a given level of condensate. Also the general form for the block-block interaction terms can be guessed on general grounds.

The free energy has the general form

$$F_{TGD} = \sum_i N_i (-E_{cond} - E_{join}) + \sum_{ij} E_{int}^{ij} + F_{gr} . \quad (12.3.21)$$

The energy decomposes into a sum of the condensation energies $E_{cond} = \frac{b(k)}{L(k)}$ and join along boundaries binding energies E_{join} for blocks and of Kähler interaction energy and gravitational binding energy. According to the previous arguments, gravitational binding energy becomes important only in length scales $L(k) > \frac{1}{T}$. Depending on whether the condensate level is of electromagnetic or Z^0 type Kähler interaction energy corresponds either to electromagnetic or Z^0 Coulombic energy. Also magnetic interaction energies are possible. The general order of magnitude estimate for Kähler interaction energy is obtained if one accepts the previously proposed general picture of the electromagnetically neutral topological condensate.

One can understand these terms as coming from the Boltzmann weight $\exp(E_{cond} + E_{join} + E_{gr} - E_K)$ appearing in the partition function associated with p:th level of the condensate. Kähler interaction energy is actually thermal average of the Kähler interaction energy and contains small temperature dependence. Due to its smallness it seems however safe to neglect this dependence. There is also a second reason for separating the ordinary contributions and those present only in TGD framework. Ordinary free energy is related to short range interactions and is not sensitive to the finite size of the p-adic surface whereas Kähler interaction energy corresponds to long range interaction and depends strongly on the size of the p-adic surface.

Besides these terms also Lagrange multiplier terms, such as a term

$$F_{const} = \lambda(p_{ext} - \frac{\partial F}{\partial V}) . \quad (12.3.22)$$

fixing the pressure to the external pressure at the highest level of the condensate, are present. The condensation level at which the constraint term appears corresponds naturally to the length scale $L(k) \sim \frac{1}{T}$ determined by the temperature: above this length scales gravitational interaction

dominates. At the lower levels of the condensate this kind of pressure term is not present and the minimization of free energy fixes completely the various densities at these levels of the condensate. The important consequence is that the density of say, fluid, at short length scales should be fixed completely by the minimization conditions and should not depend on the external pressure at all. The external pressure changes the density of blocks but not the density inside blocks. An exception is provided by solid phases, for which join along boundaries implies the formation of lattice so that only single block density is present for an ideal solid.

At high temperatures and in long length scales Kähler interaction energy and condensation energy are completely negligible in general. At low temperatures and short length scales as well as in critical systems the situation is different. The formation of supra phases and also of ordinary solids by join along boundaries operation provide examples of the situation, where the Kähler energy probably must be taken into account.

12.4 Configuration space geometry and phase transitions

The definition of the configuration space Kähler geometry has beautiful catastrophe theoretic interpretation. As a matter of fact, catastrophe theory enters at two levels. First, Kähler function $K(X^3)$ is defined as the absolute minimum of Kähler action and associates a unique space-time surface $X^4(X^3)$ to a given 3-surface X^3 . It can quite well happen that the absolute minimum of the Kähler action as a function of the varied parameters changes in discontinuous manner. Secondly, 'quantum average effective space-times' correspond to the absolute minimum space-time surfaces $X^4(X_{max}^3)$ associated with the maxima of Kähler function as function of 3-surface and has so called zero modes as external control parameters and also now catastrophes are possible.

12.4.1 Basic ideas of the catastrophe theory

To understand the connection consider first the definition of the ordinary catastrophe theory [?]. In catastrophe theory one considers the extrema of a potential function depending on dynamical variables x as function of external parameters c . The basic space decomposes locally into cartesian product $E = C \times X$ of control variables c , appearing as parameters in the potential function $V(c, x)$ and of state variables x appearing as dynamical variables. Equilibrium states of the system correspond to the extrema of the potential $V(x, c)$ with respect to the variables x and in the absence of symmetries they form a sub-manifold of M with dimension equal to that of the parameter space C . In some regions of C there are several extrema of potential function and the extremum value of x as a function of c is multi-valued. These regions of $C \times X$ are referred to as catastrophes. The simplest example is cusp catastrophe (see Fig. 12.4.2) with two control parameters and one state variable.

In catastrophe regions the actual equilibrium state must be selected by some additional physical requirement. If system obeys flow dynamics defined by first order differential equations the catastrophic jumps take place along the folds of the cusp catastrophe (delay rule). On the other hand, the Maxwell rule obeyed by the thermodynamic phase transitions, states that the equilibrium state corresponds to the absolute minimum of the potential function and the state of the system changes in discontinuous manner along the Maxwell line in the middle between the folds of the cusp (see Fig. 12.4.2). As far as discontinuous behavior is considered fold catastrophe is the basic catastrophe: all catastrophes contain folds as there 'satellites' and one aim of the catastrophe theory is to derive all possible manners for the stable organization of folds into higher catastrophes. The fundamental result of the catastrophe theory is that for dimensions d of C smaller than 5 there are only 7 basic catastrophes and polynomial potential functions provide a canonical representation for the catastrophes: fold catastrophe corresponds to a third order polynomial (in the fold the two real roots become a pair of complex conjugate roots), cusp to fourth order polynomial, etc.. The development of the fold catastrophe means that the minimum of a potential function decomposes to two minima so that previous minimum becomes local maximum.

12.4.2 Configuration space geometry and catastrophe theory

Consider now how catastrophe theory emerges from the definition of the Kähler function. The most obvious identification for the parameter space C would be as the space of all 3-surfaces in $H = M_+^4 \times CP_2$. In order to get rid of the difficulties related to $Diff^4$ invariance one must however restrict the consideration to 3-surfaces belonging to H_a : the set of 3-surfaces of $M_+^4 \times CP_2$ with constant M_+^4 proper time coordinate. The counterpart of the total space $E = C \times X$ can be identified as the space of the solutions of the Euler Lagrange equations associated with Kähler action (one could consider all 4-surfaces but this is not necessary) and decomposes only locally into Cartesian product. Intuitively the space X corresponds to the time derivatives for the variables specifying the space X and in Hamiltonian formalism to the canonical momenta. If the initial value problem is well defined, the values of C and X coordinates specify the extremum uniquely. In TGD this is not in general true as the extremely large vacuum degeneracy of the Kähler action strongly suggests.

Potential function corresponds to the Kähler action restricted to the solution space of the Euler Lagrange equations. Catastrophe surface corresponds to the four-surfaces found by extremizing Kähler action with respect to the variables of X (time derivatives of coordinates of C specifying X^3 in H_a) keeping the variables of C specifying 3-surface X^3 fixed. Extremization with respect to time derivatives implies a phenomenon analogous to the Bohr quantization since canonical momenta cannot be chosen freely as in the ordinary initial value problems of the classical physics. When catastrophe occurs there are several extremizing 4-surfaces going through the given 3-surface: otherwise one obtains just the sought for absolute minimum surface.

The requirement that Kähler function corresponds to absolute minimum is just Maxwell's rule in infinite dimensional context and implies that phase transition type catastrophic quantum jumps are typical for TGD Universe. Cusp catastrophe provides a simple concretization of the situation (see Fig. 12.4.2) The set M ('Maxwell set') of the critical 3-surfaces corresponds to the Maxwell line of the cusp catastrophe and forms codimension one set in configuration space. For 3-surfaces near to the Maxwell set M small one parameter deformation in the direction normal to it can induce large deformation of the 4-surface associated with it. This implies initial value sensitivity with respect to the coordinate X_n associated with the normal direction. Kähler function itself is continuous on Maxwell surface and mathematical consistency requires that also Kähler metric is continuous on Maxwell surface. A good example of a catastrophic jump is provided by a topology changing quantum jump (3-surface decays to two disjoint 3-surfaces) identifiable as 3-particle vertex.

The present situation differs from the ordinary catastrophe theory in several respects.

- (a) The parameter space C is infinite dimensional so that there seems to be no hope of having finite classification for catastrophes in TGD Universe. Of course, all lower dimensional catastrophes are expected to be present in TGD, too.
- (b) Kähler action possesses vacuum degeneracy and one cannot exclude the possibility that the absolute minima of the Kähler action are degenerate: this implies further modifications to the standard picture of catastrophe theory.
- (c) Maxwell rule follows as a theorem in Quantum TGD whereas in ordinary catastrophe theory delay rule (jumps takes place along the folds) follows as a theorem. The latter implies that the description of phase transitions is not possible using the catastrophe theory associated with flows. These observations suggests that classical dynamics (for instance the classical dynamics associated with Kähler action) obeys delay rule whereas quantum dynamics obeys Maxwell rule and that the phenomena of super cooling and super heating are related to classical dynamics and ordinary phase transitions are induced by quantum fluctuations.

The existence of the catastrophes is implied by the vacuum degeneracy of the Kähler action. For example, for pieces of Minkowski space in $M_+^4 \times CP_2$ the second variation of the Kähler action vanishes identically and only the fourth variation is non-vanishing: these 4-surfaces correspond to the dip of the cusp catastrophe. There are also space-time surfaces for which second variation is non-vanishing but degenerate and a hierarchy of subsets in the space of extremal 4-surfaces with decreasing degeneracy of the second variation defines the boundaries of the projection of the

catastrophe surface to the space of 3-surfaces. The space-times for which the second variation is degenerate contain as subset the critical and initial value sensitive absolute minimum space-times. By p-adic fractality there are good reasons to expect that there are catastrophes in all length scales so that the increase in p-adic resolution leads to emergence of new smaller catastrophes on a given portion of the catastrophe surface.



Figure 12.1: Cusp catastrophe

12.4.3 Quantum TGD and catastrophe theory

Catastrophes appear also in a second manner in TGD. As explained in the second part of the book, configuration space allows an infinite number of zero modes. Zero modes characterize the size and shape of the 3-surface but do not appear in the line element of the configuration space metric. In good approximation configuration space functional integrals associated with the S-matrix elements can in principle be calculated using perturbation theory around the maxima of the Kähler function and one can define 'quantum average effective space-times' as the space-time surfaces $X^4(X_{max}^3)$ associated with the maxima. Since the vacuum functional of the theory is the exponent of the Kähler function, the ill-defined Gaussian and metric determinants cancel each other and what remains is an integral over the zero modes. In general, for given values of the zero modes there are several maxima of the Kähler function and zero modes are in the role of the control parameters whereas the coordinates fixing the maximum of Kähler function for given values of the zero modes are in the role of the state variables. Also now infinite-dimensional catastrophe theory is in question.

The values of the vacuum functional at the Maxwell line of the cusp catastrophe same at the two sheets of the catastrophe but when one moves away from the Maxwell line, the second sheet begins to dominate due to the exponential dependence of the vacuum functional on Kähler function. One can also consider quantum jumps associated with the catastrophes: if the states represented by the points of the catastrophe surface are quantum entangled with the states of the external world or measurement apparatus E , one has, in the case of a cusp catastrophe, entanglement of the two sheets of the catastrophe with the states of E .

According to the strong form of Negentropy Maximization Principle, the quantum jumps selecting one of the sheets can occur when the quantum entanglement/entanglement entropy is large, actually largest in the set of all possible quantum subsystems. This is indeed the case at the Maxwell line, where the values of the Kähler function defining the entanglement probabilities at two sheets are identical so that entanglement entropy is maximized. Hence the region near the Maxwell line is predicted to be the region, where macroscopic phase transition like quantum jumps can occur and it is an intriguing possibility that thermal phase transitions basically correspond to this kind of quantum jumps. Strong form of NMP actually suggests that large number of nearly degenerate maxima must be involved so that the entanglement entropy becomes large.

12.4.4 TGD based description of phase transitions

The above described mathematical structure should somehow reflect its presence also in the quantum description of the ordinary condensed matter phase transitions. Quantum criticality means that quantum states in TGD Universe are analogous to the states of a critical system and long range quantum correlations are predicted in all length scales. In principle, all quantum states are predicted to be critical in some time and length scale. The appearance of the join along boundaries condensates provides a concrete realization for quantum criticality. Spin glass analogy is in turn related to the enormous vacuum degeneracy of the Kähler action. This means the appearance of infinite number of zero modes of the Kähler function, which characterize the size and shape of the 3-surface as well as the classical induced Kähler field and play the role of universal control parameters in the catastrophe theory. Zero modes are the quantum counterparts of macroscopic state variables, to which thermodynamical variables should reduce at quantum level, and clearly they have no counterpart in the ordinary quantum field theories.

The strong form of Negentropy Maximization Principle states that the quantum jump in a given quantum state is performed by a subsystem for which the quantum jump to an eigenstate of the density matrix gives maximum negentropy gain. There are good arguments suggesting that the second law of thermodynamics follows from the strong form of Negentropy Maximization Principle [K51].

- (a) State function reductions increase the negentropy of the subsystem in ensemble but only the subsystem for which negentropy gain is maximal, can make the quantum jump and reduce its entanglement entropy. In order to get the possibility to make quantum jump (and be conscious according to TGD inspired theory of consciousness), the subsystem must be able to generate entanglement entropy very effectively: therefore strong NMP favors the generation of entanglement entropy and, rather paradoxically, implies both evolution and the second law of thermodynamics as different sides of the same coin.
- (b) The maximum for the real counterpart of the p-adic entropy is proportional to $\ln(p)$ and this implies that cosmological evolution leading to the emergence of larger p-adic length scales in the topological condensate favors also the increase of the entanglement entropy. Hence, *if* one can indeed identify thermal entropy as an entanglement entropy, there are good hopes that second law of thermodynamics follows as a consequence.

This picture leads to a straightforward generalization of Haken's non-equilibrium thermodynamics description of the self-organizing systems [B40] with configuration zero modes appearing in the role of the order parameters and the negative of the Kähler function playing the role of the potential function. The classical dynamics given by Langevin and Focker-Planck equations is replaced with the nondeterministic dynamics defined by quantum jumps. Quantum jump can be regarded as a basic step of self-organization.

As a special case, quantum description of the thermodynamical phase transitions should emerge. Quantum entanglement of the almost degenerate configurations near Maxwell line would be the purely quantal element of the quantum theory of phase transitions. The absolute minimization of the thermodynamical free energy and Maxwell rule would basically follow from the assumption that phase transition is induced by a quantum jump selecting between various maxima of the Kähler function and from the maximization of the Kähler function plus strong form of Negentropy Maximization Principle. The super cooling and super heating effects could be interpreted as produced by classical dynamics defined by the absolute minimization of the Kähler action for which the delay rule holds true.

12.5 Imbeddings of the cylindrically symmetric flows

In order to find orders of magnitude for the critical radii, the embeddings of some simple cylindrically symmetric flows will be considered. It is more convenient to consider Z^0 field instead of the Kähler field: these fields are proportional to each other for electrovac space-times: $J = pZ^0/6$ ($p = \sin^2(\theta_W)$).

12.5.1 The general form of the imbedding of the cylindrically symmetric rotational flow

In the following the flows at condensate levels $n \geq n_Z$ will be considered so that Z^0 fields are expected to dominate over the electromagnetic fields. Since the neutrinos screening the nuclear Z^0 charge are not expected to participate in the flow, only the Z^0 charge coming from level $n - 1$ contributes to the spatial components of the Z^0 gauge current density at the level n and the time like component of the current density is therefore much smaller than the spatial components. This motivates the study of the field configurations for which Z^0 electric field is negligibly small as compared to Z^0 magnetic field.

- (a) The ration of em and Z^0 fields for vacuum extremals is given by $\gamma/Z^0 = -p/2$, $p = \sin^2(\theta_W)$. Vanishing of the electromagnetic field is achieved for $p = 0$. It is indeed possible that Weinberg angle vanishes for vacuum extremals. The CP_2 projection of the imbedding is two-dimensional, which implies the orthogonality of the magnetic and electric fields belonging to the same condensate level. On basis of the results of appendix Z^0 and em fields for vacuum extremals are given by

$$\begin{aligned} Z^0 &= (k + u)du \wedge d\Phi \ , \\ \gamma &= -\frac{p}{2}Z^0 \ . \end{aligned} \tag{12.5.1}$$

Here $u = \cos(\Theta)$ and Φ corresponds to spherical coordinates.

- (b) Z^0 charge density of matter is assumed to serve as a source of Z^0 fields and in the idealization that matter consists of identical nuclei (A, Z) one can write the charge density as

$$\rho_Z = -K_Z N_n \ , \ K_Z = \frac{g_Z^2}{4\sqrt{\epsilon_Z}} \frac{N}{A} \ . \tag{12.5.2}$$

Here N_n is the density of nucleons and $N/\sqrt{\epsilon_Z}$ is the weak isospin per nucleus using neutrino isospin as a unit. ϵ_Z depends on the p-adic length scale involved and p-adic fractality suggests the scaling

$$\frac{N}{\sqrt{\epsilon_Z}} \propto N_0 \times \left(\frac{L(k_0)}{L(k)}\right)^3 = N_0 \times 2^{-3(k-k_0)/2}$$

as a function of $p \simeq 2^k$. Prime values of k are favored and $k = 113, 151, 157, 163, 167$ corresponding to Mersenne primes are especially interesting.

The general situation corresponds to a flow for which the matter rotates around the z-axis with velocity $\beta(\rho)$ and creates Z^0 magnetic field in the z-direction. The Z^0 magnetic field associated with the flow at n :th condensate level is given by

$$B^Z = K_Z N_n \int \beta(\rho) d\rho \ . \tag{12.5.3}$$

The spatial dependence of the Z^0 electric field is same as that of B^Z and this means that Z^0 charge density serving as the source of E^Z cannot be constant: a possible resolution of the problem is that the screening neutrinos at level n arrange themselves so that Z^0 charge density is not constant although the nucleon density is.

Using coordinates $(r, u = \cos(\Theta), \Psi, \Phi)$ for CP_2 , the cylindrically symmetric electromagnetically neutral imbedding of this flow is obtained in the form

$$\begin{aligned}
u &= u(\rho) , \\
\Psi &= \omega_2 m^0 + n_2 \phi , \quad \Phi = \omega_1 m^0 + n_1 \phi ,
\end{aligned} \tag{12.5.4}$$

where the relationship between the variables r and Θ is fixed by the vacuum extremal property (see Appendix of the book). The value of the parameter k is given by $k = \omega_2/\omega_1 = n_2/n_1$.

From the general expression for the Z^0 field in the vacuum extremal space-time one obtains the following differential equation for u :

$$\begin{aligned}
B^Z &= (k + u)n_1 \frac{\partial_\rho u}{\rho} , \\
&= K_Z N_n \int \beta(\rho) d\rho ,
\end{aligned} \tag{12.5.5}$$

which gives the relationship between u and ρ in the following form

$$\int (k + u) du = \frac{K_Z N_n}{n_1} \int d\rho \rho \int d\rho \beta(\rho) . \tag{12.5.6}$$

Assuming that $u = -1$ corresponds to the z-axis and the boundary of topological field quantum to $u = 1$, one obtains an expression for the critical radius:

$$\begin{aligned}
\int_0^{\rho_{cr}} d\rho \rho \int \beta(\rho) d\rho &= -\frac{n_1}{K_Z N_n} \times 2k , \\
K_Z &= \frac{g_Z^2 N}{4\sqrt{\epsilon_Z} A}
\end{aligned} \tag{12.5.7}$$

An attractive possibility is that the structures associated with the ordinary hydrodynamic flow might be understood as consequences of CP_2 geometry. It will be found that the order of magnitude estimates give quantitative support for this guess.

One obtains also a quantization of Z^0 magnetic flux as

$$\int B_Z da = 2\pi n_1 \int (k + u) du = 4\pi k n_1 , \tag{12.5.8}$$

What is nice is that the quantization condition eliminates the dependence of the critical radius on the poorly known vacuum quantum numbers totally. The least one can hope is that the condition fixes orders of magnitude correctly.

p-Adic length scale hypothesis suggests a simple scaling for the flow velocities guaranteeing that ρ_{cr} scales as $L(k)$. $K_Z \propto L(k)^{-3}$ scaling, which follows from the assumption that the number of dark Z^0 charges per p-adic volume does not depend on p , implies the scaling

$$\int \beta_k(\rho) d\rho \propto L(k)^{-3}$$

achieved for

$$\beta_k(\rho) \propto \left(\frac{\rho}{L(k)}\right)^k L(k) .$$

The decay of a structure characterized by the p-adic length scale $L(k)$ to smaller structures with smaller values of k could provide a general mechanism for generating fractal structures [A57] . The model of turbulence favors the scaling $2^k = 2^5$ for the vortices in the hierarchy. This scaling could also correspond to the Mersenne prime $M_5 = 2^5 - 1 = 31$.

CP_2 topology is bound to become important for large scale flows. The central ill understood problem in the astrophysics is the understanding of the turbulence and the dissipation of the angular momentum [E152] . From the foregoing it is clear that TGD approach might provide understanding concerning several astrophysical problems [E152] . An interesting test for the ideas is the possible existence of the nested fractal structures related by discrete scale transformations.

12.5.2 Orders of magnitude for some vacuum parameters

The space-time associated with the flow is characterized by several parameters. Besides the parameters ω_i and n_i there are integer valued parameter m and the parameter u_0 . In the following estimates for the general orders of magnitude for some of these parameters will be derived.

An estimate for the parameter ϵ_Z

The requirement that gravitational interaction is stronger than Z^0 force in long length scales implies $\epsilon_Z(n \rightarrow \infty) \geq 10^{36}$. At the condensate level $n = n_Z$ at which elementary particles feed their Z^0 charges the estimate

$$\epsilon_Z \sim 10^{20} ,$$

holds true by the argument related to the dissipation in super fluid flow, to be developed later. For the Z^0 magnetic field at level n the $\epsilon_Z(n - 1)$, rather than $\epsilon_Z(n)$, appears in the expression of B_Z (assuming that dark neutrinos do not participate in the flow) so that at level $n = n_Z$ strong B_Z fields are possible ($\epsilon_Z = 1$).

An estimate for the quantum number n_1

An essentially similar estimate have been already carried out in the previous chapter. The requirement that angular momentum density is of correct order of magnitude, gives an estimate for the value of the parameter n_1 . The expression of the conserved gravitational angular momentum current in the z-direction is given by

$$J^\alpha = T_{gr}^{\alpha\beta} \partial_\beta m^k m_{kl} j^l , \tag{12.5.9}$$

where j^k denotes the vector field associated with the infinitesimal rotation and $T_{gr}^{\alpha\beta}$ denotes gravitational energy momentum tensor defined by Einstein's equations. For the angular momentum density one obtains in the cylindrical M^4 coordinates for X^4 the expression

$$J^t = T_{gr}^{t\phi} \rho^2 . \tag{12.5.10}$$

The leading order contribution to the angular momentum density comes from the non-vanishing of the metric component

$$\begin{aligned}
g_{t\phi} &= s_{\Phi\Phi}^{eff} \omega_1 n_1 = -\frac{R^2}{4} X \times [(1-X)(k+u)^2 + 1 - u^2] \omega_1 n_1 , \\
X &= D|k+u| , \quad D = \frac{r_0^2}{1+r_0^2} \times \frac{1}{k+u_0} , \quad r_0 = r(u_0) ,
\end{aligned} \tag{12.5.11}$$

and one obtains the order of magnitude estimate

$$J^t \simeq -T_{gr}^{tt} g_{t\phi} \rho^2 \simeq \rho_m \frac{R^2}{4} \omega_1 n_1 . \tag{12.5.12}$$

In order to obtain a correct order of magnitude for the angular momentum density associated with the rotational flow one must have

$$\frac{R^2}{4} \omega_1 n_1 \simeq \rho \beta(\rho) , \tag{12.5.13}$$

which implies

$$n_1 \simeq \frac{L}{R} \beta , \tag{12.5.14}$$

where L and β are the typical scale and velocity associated with the flow. It is clear that n_1 is an enormous number: essentially the size of the rotational flow measured using CP_2 length as a unit.

Estimate for ω_2 , n_2 and m

The values of the parameters ω_2 and n_2 and m remain free and the attractive possibility is that the value of the parameter n_2 is small, perhaps of the order of one. If this the case then the value of the parameter ω_2 is also small

$$\frac{\omega_2}{\omega_1} = \frac{n_2}{n_1} \simeq \frac{R}{L} \frac{n_2}{\beta} . \tag{12.5.15}$$

The first guess is that at microscopic scales the order of magnitude for ω_2 corresponds to the p-adic lengths scale of dark matter particles in question and ω_1 is of order CP_2 mass as the imbeddings of Schwarzschild metric as a vacuum extremal suggest [K85] . $\omega_2 \sim m_e$ gives $n_2 \sim 10^{-19}(L/R)\beta$. For $L = 0.1$ meters and $\beta \simeq 10^{-8}$ one would have $n_2 \sim 10^6$.

12.5.3 Critical radii for some special flows

In order to get concrete picture of the situation it is useful to calculate the critical radius for some special flows.

Vortex flow

The velocity field is irrotational except on the z-axis and velocity and Z^0 magnetic fields are given by

$$\begin{aligned}\beta &= \frac{K}{\rho} , \\ B^Z &= K_Z N_n K \ln\left(\frac{\rho}{\rho_0}\right) .\end{aligned}\quad (12.5.16)$$

Assuming that $r = 0$ on the z-axis, one obtains for the critical radius the equation

$$\rho_{cr}^2 \left(\ln\left(\frac{\rho_{cr}}{\rho_0}\right) - \frac{1}{2} \right) = -\frac{2n_1 k}{K_Z N_n K} . \quad (12.5.17)$$

To a logarithmic accuracy, this gives the order of magnitude estimate

$$\rho_{cr} = 2\sqrt{\frac{n_1 k}{K_Z N_n K}} . \quad (12.5.18)$$

The size of the critical radius decreases as the vorticity K increases.

Rigid body flow

Velocity field and Z^0 magnetic field are given by

$$\begin{aligned}\beta &= \Omega \rho , \\ B_Z &= K_Z N \Omega \frac{\rho^2}{2} .\end{aligned}\quad (12.5.19)$$

The value of the critical radius is given by the condition

$$\rho_{cr} = \left(\frac{16kn_1}{K_Z N_n \Omega} \right)^{1/4} , \quad (12.5.20)$$

for the quantized Z^0 magnetic flux.

12.6 Transition to the turbulence in channel flow

In sequel a general model for the transition to turbulent flow is proposed. In order to see whether the proposed scenario has anything to do with the reality it is useful to look whether one can understand the generation of a turbulence in some simple situation, which is chosen to be channel flow. The consideration is restricted to the length scales $L > \xi$ so that Z^0 magnetization should play key role in the generation of turbulence if the proposed general model is correct.

12.6.1 Transition to the turbulence

In the following a general model for the transition to turbulent flow below length scale identifiable as a weak length scale characterizing dark weak bosons L_w associated with the largest vortices. Similar model might apply also in the case of magnetic fields. In the following the phrase 'Kähler field' refers either to the ordinary electromagnetic field or Z^0 field or possibly to their linear combination depending on the context.

- (a) The probability of the configuration is proportional to the exponent of the Kähler function so that the most probable configurations correspond to a large value of the Kähler action. Kähler action can be increased by making either the magnitude of the Kähler electric part smaller or the magnitude of the Kähler magnetic part larger. The first mechanism is expected to be at work at non-relativistic velocities since the ratio of the Kähler magnetic and electric contributions to the Kähler action is expected to be of the order of β^2 , where β is typical flow velocity. The transition to configuration with larger Kähler action is expected to take place provided it is energetically possible and is consistent with the minimization of the Kähler action.
- (b) Spontaneous Kähler magnetization provides the means to generate a positive action. The Kähler action of the Kähler magnetized space-time domain should be larger than that associated with the same domain without magnetization. It turns out that the Kähler electric action associated to a vortex region moving with the fluid has smaller magnitude than that associated with the same volume of the original flow: the reason is that Kähler electric field associated with the vortex is small near the core of the vortex. CP_2 geometry implies that the stable domains of the Kähler magnetization have some finite critical size. Kähler magnetized domains correspond to vortices and due to the viscosity, vortices grow until they achieve a critical size.
- (c) Vortex must get somehow rid of its angular momentum and kinetic energy and the topological quantum numbers n_1 and n_2 must become zero. One candidate for the region, where new vortices are produced is the region near the critical radius, where the velocity gradients are large so that the viscosity plays important role. The vortices created in this region cannot however lead to a decrease of n_1 and n_2 . The process leading to a decrease of n_1 and n_2 is a generalization of the process known as phase slippage in super fluidity [D3]. Daughter vortices are created at the core of the mother vortex and they propagate under the action of Magnus and friction forces to the boundary of the mother vortex and carry away the quantum numbers n_1 and n_2 of the mother vortex gradually.

For the flow $\beta = K/\rho$, which is irrotational outside the symmetry axis, which actually corresponds to a cylindrical hole of finite radius r , this hypothesis makes sense since the variation of velocity is large in normal direction in the core and dissipation rate therefore largest near the boundary of the hole. The radius r defines a natural lower bound for the sizes of vortices involved.

- (d) The transition to turbulence involves the generation vortices of various sizes related by scale transformations. That this is the case is suggested by the following argument. It is an empirical fact that the size of the daughter vortices is smaller than the size of mother vortex (this assumption forms the basis of Kolmogorow and Heisenberg theories of turbulence [B62]). The conservation laws of energy and angular momentum however imply that daughter vorticities cannot be larger than mother vorticity. The critical radii of the mother and daughter vortices are related by the scale transformation $\rho_{cr} \rightarrow \lambda \rho_{cr}$. λ is expected to be a negative power of 2 and it turns out that $\lambda < 2^{-5}$ is consistent with the Heisenberg's model for the generation of turbulence. In fact, a distribution $\lambda(k) = 2^{-k}$, $k \geq 5$, for vortex sizes might be allowed.

The hypothesis that vortex decay corresponds to a decay of higher levels in the dark matter hierarchy by de-coherence such that \hbar is reduced by could a factor $\lambda = v_0/n \simeq 2^{-11}/n$, $n = 1, 2, \dots$, is consistent with the proposal. The decay would correspond to a decay of Bose-Einstein condensates of corresponding weak bosons to those at the lower level of darkness and thus having Compton lengths reduced by λ .

- (e) The transition to turbulence can be understood as a fractal like process. In the case of the channel flow, the walls serve as sources of the mother vortices with large critical radii. These vortices in turn decay to smaller vortices. At a given condensate level the process stops, when the size of the daughter vortices is so small that the hydrodynamics approximation fails so that the radius of the smallest vortices is of same order of magnitude as the length scale $L(n)$ giving the size of smallest structures at the condensate level in question. A necessary condition for the process to occur is that the total Kähler action generated is positive. The criterion for the process to occur is that the total Kähler action associated with the cascade is positive.

It should be emphasized that the decomposition of the space-time into above described regions is very general phenomenon characteristic for TGD. It happens for a general space-time with vanishing electromagnetic fields and also for more general space-time surfaces: the condition in question might state the vanishing of the Kähler field or electromagnetic field or the proportionality of the Kähler field and electromagnetic field. This suggests rather unexpected support for the basic assumptions of TGD: many of the fractal structures encountered in Nature might be direct manifestations of CP_2 geometry!

12.6.2 Definition of the model

The transition to turbulence is cascade process.

- (a) Mother vortices having initial radius ρ_0 are created at the walls of the channel, where the velocity gradients are large and viscosity plays important role. Let ξ is the length scale above which hydrodynamic approximation works. ξ should be of the order of atomic length scale $a = 10^{-10}$ m.

In the rest frame of the vortex the velocity field is given by

$$\beta(\rho) = \frac{K}{\rho} . \quad (12.6.1)$$

The sign of the vorticity is such that the formation of the vortices tends to make velocity zero at the walls of the channel.

- (b) Mother vortices move across the channel under the combined action of the Magnus force $F = K \times v$ and friction force and reach a critical size. Mother vortices dissipate their energy and angular momentum by the emission of daughter vortices by the phase slippage process. The critical radius of the daughter vortices is by a factor λ smaller than the critical radius of the mother vortex. The value of λ remains a parameter to be fitted.
- (c) The process repeats itself until the size of the daughter vortices is of the order of ξ and hydrodynamic approximation fails.

12.6.3 Estimates for the parameters

Consider now a more quantitative definition of the process.

- (a) The order of magnitude estimates for the parameters $k(0) \equiv k$ and $\rho_{cr}(0) \equiv \rho_1$ are obtained in the following manner.
- i) ρ_1 should be smaller than the width of the channel for obvious geometric reasons:

$$\rho_1 \leq d . \quad (12.6.2)$$

This same estimate follows from the requirement that the configuration with a vortex possesses larger Kähler action than the configuration without any vortex as will be found later.

- ii) An upper bound for the vorticity K is obtained by requiring that the flow velocity at

$\rho \simeq \xi$ is not larger than the thermal velocity (sound velocity could be taken as an alternative lower bound: orders of magnitude are same): $K/\xi \leq \beta_{th}$, which gives

$$K \leq K_{max} \simeq \xi \beta_{th} . \quad (12.6.3)$$

- (b) A natural requirement is that the rotation velocity of the vortices at the critical radius is of the same order of magnitude as the velocity of the main flow

$$\frac{K}{\rho_1} \simeq \beta . \quad (12.6.4)$$

This condition guarantees that the angular momentum of the vortex is of the same order of magnitude as the angular momentum for the main flow in the vortex region. Substituting this constraint and the upper bound for k to the condition $\rho_1 \leq d$ one obtains Reynolds number type criterion

$$\frac{\beta d}{\nu} \geq R_{cr} \equiv \frac{\beta_{th} \xi}{\nu} , \quad (12.6.5)$$

when the vorticity K is maximal ($K \simeq \xi$ in units $c = 1$).

- (c) A kinetic theory estimate for the order of magnitude estimate of the gas viscosity gives a correct order of magnitude in case of the small viscosity liquids, too and is given by

$$\nu \simeq \frac{\beta_{th}}{N\sigma} , \quad (12.6.6)$$

where N is the density of nucleons in the liquid. Typically one has $N \simeq 10^{30}/Am^3$ (A is atomic mass number) and $\sigma \sim a^2$, $a = 10^{-10}$ m is atomic cross section: $\sigma \simeq 10^{-20} m^2$ holds true for liquids at room temperature.

- (d) Using the order of magnitude estimate for the kinematic viscosity ν one obtains

$$R_{cr} = \frac{\beta_{th} \xi}{\nu} \simeq N\sigma\xi \simeq Na^3\xi \sim \frac{10^4}{A} \times \frac{\xi}{a} . \quad (12.6.7)$$

For $\xi \sim a$ the value of R_{cr} is of the correct order of magnitude since the fully developed turbulence sets in at Reynolds numbers of this order of magnitude. In case of water more careful estimate using the actual value of the kinematic viscosity and thermal velocity in room temperature gives $R_{cr} \simeq 1200 - 12000$.

According to this criterion turbulence can develop also for smaller Reynolds numbers by vortices with $K \leq d \leq \xi\beta_{th}/\beta$ (as it does) but not all vorticities allowed by the velocity condition are possible. For the critical Reynolds number means that all possible vorticities allowed by $\beta(\xi) \leq \beta_{th}$ are allowed and for larger Reynolds numbers the upper limit for the size of vortices: $\rho_{cr} \leq \xi\beta_{th}/\beta \leq d$ is strictly smaller than the width of the channel.

The critical Reynolds number follows from the geometric condition $\rho_{cr} \leq d$ in the case of a channel flow. It will be later found that the same condition follows also from the requirement that the generation of the vortex increases the Kähler action so that same kind of condition is expected also in case of, say, the flow between two rotating disks.

12.6.4 Kähler fields associated with the cascade process

In the following a simple model for the Kähler electric and magnetic fields associated with the main flow and vortices will be constructed. The following simplifying assumptions about the flow are made:

- i) The flow takes place in a channel of height h , width d and length L .
- ii) The flow velocity β is constant throughout the channel.
- iii) The main flow has a constant density $\rho_m \equiv Nm_p$, possesses kinematic viscosity ν and thermal velocity β_{th} .

Consider first the Kähler electric and magnetic fields associated with the main flow and a vortex assumed to have its axis in the z -direction.

- (a) When the fluid is at rest, it creates Kähler electric field, which near the symmetry axis of the flow is cylindrically symmetric for long and wide channel is in the z -direction and given by

$$\begin{aligned} E_\rho^K &= K_Z N_n \frac{\rho}{2} , \\ K_Z &= \epsilon_1 10^{-19} . \end{aligned} \quad (12.6.8)$$

Near the walls $x = d$ and $x = 0$ and far from the corners, the Kähler electric field is to a good approximation orthogonal to the wall and given by the expression

$$E_x^K = K_Z N_n \left(x - \frac{d}{2}\right) . \quad (12.6.9)$$

Same applies on the walls $z = 0$ and $z = h$. The small effects caused by the density gradients on the Kähler electric field, are neglected.

- (b) The Kähler magnetic field near the axis of the symmetry has circles as its flow lines and the magnitude of the field is given by

$$B_\phi^K = K_Z N_n \beta \frac{\rho^2}{2} . \quad (12.6.10)$$

Near the walls $x = d$ and $x = 0$ and sufficiently far from the corners the Kähler magnetic field is given by the expression

$$B_z^K = K_Z N_n \beta \left(x - \frac{d}{2}\right) . \quad (12.6.11)$$

- (c) The Kähler magnetic field created by the locally irrotational vortex vortex is given by the expression

$$B_z^K = K_Z N_n K \ln\left(\frac{\rho}{\rho_0}\right) . \quad (12.6.12)$$

- (d) The Kähler electric field created by the vortex can be estimated by assuming the simplest possible imbedding with vanishing electromagnetic fields ($\Psi = \omega_2 m^0 + n_2 \phi$ and $\Phi = \omega_1 m^0 + n_1 \phi$). The relationship between Kähler electric field and Kähler magnetic field is given by

$$\begin{aligned} E_\rho^K &= \frac{\omega_1}{n_1} B_z^K \rho \\ &= \frac{\omega_1}{n_1} K_Z N_n K \ln\left(\frac{\rho}{\rho_0}\right) \simeq K_Z N_n \ln\left(\frac{\rho}{\rho_0}\right) \rho , \end{aligned} \quad (12.6.13)$$

and apart from the logarithmic factor behaves like the field created by a constant charge density. The last estimate is obtained using the previous order of magnitude estimate for the size of the integer n_1 : $n_1 \simeq K/\sqrt{G}$. From this relationship one obtains an estimate for S_B^2/S_E^2 :
 $S_B^2/S_E^2 \simeq K^2/\rho_{cr}^2 \ll 1$.

12.6.5 Order of magnitude estimate for the change of the Kähler action and Reynolds criterion

In the following a rough order of magnitude estimate for the various contributions to Kähler action and numerical criteria for the transition to the turbulence are derived. The estimates are based on the following assumptions.

- (a) The Kähler fields associated with the moving vortices are obtained by Lorentz boosts leaving the Kähler action of the vortex invariant.
- (b) Kähler magnetic contributions to the Kähler action are neglected so that the increase of the Kähler action must result from the decrease of the magnitude of the Kähler electric part of the action. This is indeed expected to take place since the Kähler electric field of the vortex is small near the vortex core.
- (c) The Kähler action resulting from the interaction of the main flow and vortex is neglected. For the Kähler electric part of the action this assumption is well founded by the symmetry considerations. The Kähler electric field of the vortex is radially symmetric and in the region, where this field has a considerable magnitude, the Kähler field of the main flow is constant to a good approximation so that the integral $\int E_{vortex} \cdot E_{flow} d^4x$ vanishes to a good approximation. The corresponding magnetic interaction term can be neglected by its smallness.

As a consequence the change in the Kähler action is simply the change in the Kähler electric contribution to Kähler action, when the Kähler electric field of the main flow is replaced with the Kähler electric field of the vortex inside the space-time volume occupied by the vortex and the condition for the generation of turbulence reads as

$$\delta S_E^K = S_E^K(vortex) - S_E^K(flow) \geq 0 . \quad (12.6.14)$$

For the vortex of n :th generation $S_E^K(n)$ has order of magnitude given by

$$\begin{aligned} S_E^K(n) &= \frac{1}{16\pi\alpha_K} \int E_n \cdot E_n d^4x \\ &\propto K_Z^2 N_n^2 (\rho_{cr}^4(n)) h \frac{\pi}{4} \tau(n) , \end{aligned} \quad (12.6.15)$$

where $\tau(n)$ is the average lifetime of the n :th generation vortex. The value of $S_E^K(flow)$ near the wall has order of magnitude given by the expression

$$\begin{aligned} S_E^K(flow) &= \frac{1}{16\pi\alpha_K} \int E_{flow} \cdot E_{flow} d^4x \\ &\propto K_Z^2 N_n^2 d^2 (\rho_{cr}^2(n)) h \frac{\pi}{4} \tau(n) \end{aligned} \quad (12.6.16)$$

to a logarithmic accuracy. From the condition $S^K(vortex) \geq S^K(flow)$ one obtains to the same logarithmic accuracy

$$\rho_{cr}(n) \leq d , \quad (12.6.17)$$

which is identical to the condition obtained by a purely geometric argument. The condition is satisfied for all vortices in the cascade if it is satisfied for the initiating vortex.

Some comments on the condition is in order.

- (a) The condition poses an upper bound for the vorticities of the mother vortices: $K \leq \beta d$ in addition to the bound $K\xi \leq \beta_{th}$ and implies for the vortices with the maximal vorticity the condition $\beta d/\nu \geq 2/\beta_s$ as found already earlier. This means that full turbulence becomes possible at critical Reynolds number. Partially developed turbulence is possible for smaller Reynolds numbers, too. The vortices with the largest vorticity increase Kähler action most effectively and this suggests that the ordinary dissipation for a non-turbulent flow corresponds to the formation of small mother vortices.
- (b) Also flows without turbulence are possible since the condition states only that the most probable flows are turbulent. This is indeed what has been observed in the case of real flows: by appropriate experimental arrangements one can hinder the development of the turbulence up to rather high Reynolds numbers.
- (c) The critical Reynolds number derived from the requirement of large Kähler function has a correct order of magnitude for laboratory scale flows: $R_{cr} \sim \frac{10^4}{A} \times \frac{\xi}{a}$ ($R_{cr} \sim 10^4/A$ at room temperature).
- (d) The result is insensitive to the details of the cascade model since the first vortex serves as the bottle neck of the cascade.

12.6.6 Phase slippage as a mechanism for the decay of vortices

Phase slippage in TGD context

Vortices must somehow dissipate their energy and angular momentum. Since angular momentum is proportional to the integer n_1 this means that some mechanism for reducing the value of n_1 must exist. This kind of mechanism is indeed known in the context of super fluidity and known as phase slippage [D3]. In case of the channel flow phase slippage means that the order parameter χ , which is completely analogous to the angle variables Ψ and Φ , develops in the following manner.

The original linear behavior $\chi = kx$, where x is the coordinate in the direction of flow is gradually deformed to a behavior for which χ changes by a multiple of 2π at single point $x = x_0$ and behaves otherwise linearly (see Fig. 12.6.6). Since χ and $\chi + n2\pi$ correspond to the same physical situation the result means that one replace the graph of χ with graph without the jump. This process implies dissipation: the value of the momentum like quantum number k has decreased by a discrete amount. Physically the phase slippage corresponds to the propagation of a vortex across the channel although this is not quite obvious: the quantized vorticity of the vortex is n/M so that vorticity is conserved in the process.

In the present context the phase slippage process has a nice geometric interpretation. A pair of $r = \infty$ and $r = 0$ surfaces is generated in the process. Ψ (Φ) can change discontinuously on the these surfaces and Ψ (Φ) indeed changes by a multiple of 4π (2π) and a phase slippage is generated. In present case it is quite obvious that this process corresponds to a propagation of a vortex across the channel.

The process can be generalized to provide a dissipation mechanism for the vortices. Daughter vortex is generated on the core of the decaying vortex and moves under the action of Magnus and friction forces in radial direction and finally leaves mother vortex. The quantum numbers n_1 and n_2 associated with the process are conserved.

$$n_k(\text{mother}, i) = n_k(\text{mother}, f) + n_k(\text{daughter}) , \quad k = 1, 2 . \quad (12.6.18)$$

If one assumes that K and n_1 are proportional to each other as they should be by the semiclassical argument, the critical radius of the mother vortex doesn't change in the process. If this process repeats itself sufficiently many times n_2 and n_1 become zero gradually resulting in a complete dissipation for the energy and angular momentum of the original vortex.

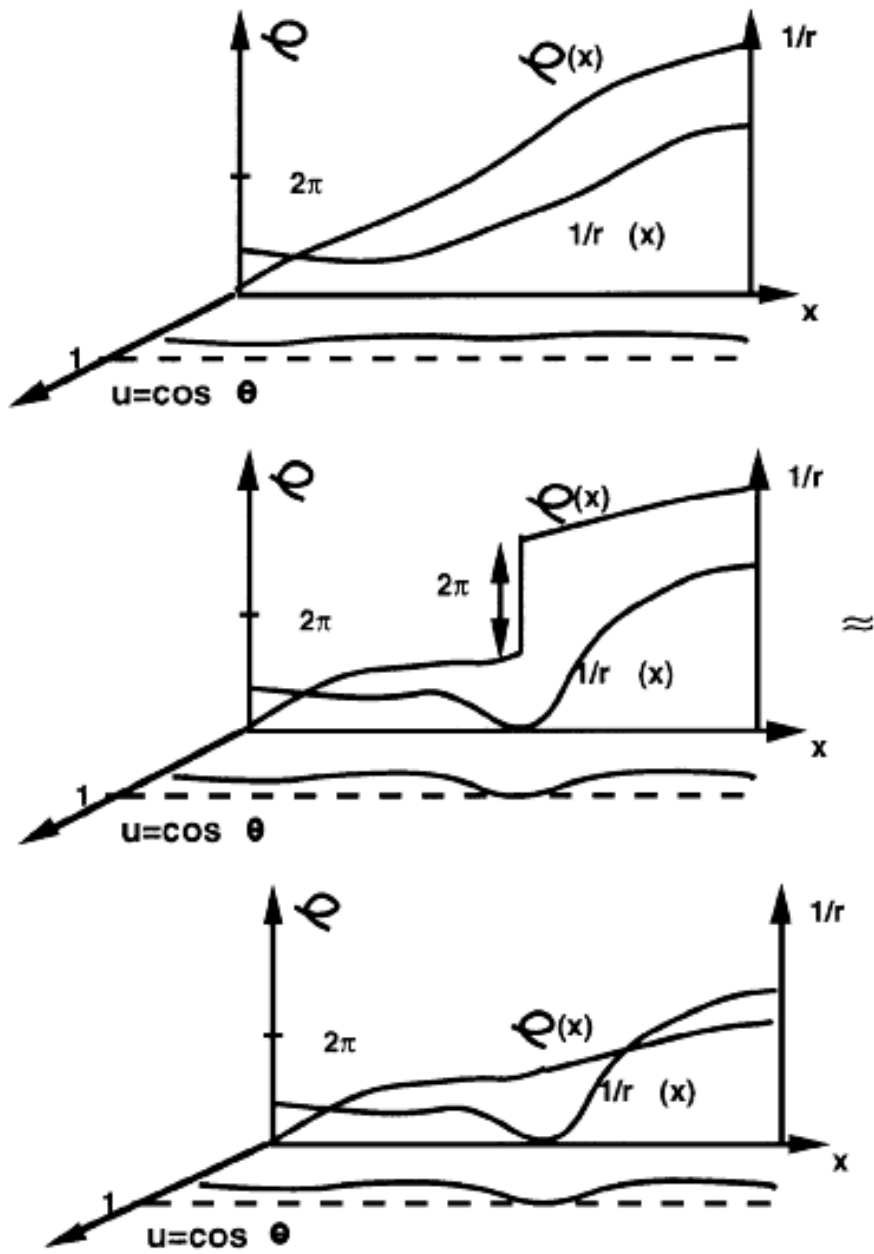

Figure 12.2: Phase slippage process and CP_2 geometry

A model for the emission of the daughter vortices

A natural manner to model the emission of daughter vortices is as a stochastic process. Vortices are characterized by the quantum label $\Lambda = (n_1, n_2, \omega_1, \omega_2, m)$ and phase slippage corresponds to the emission process

$$\Lambda_1 \rightarrow \Lambda_2 + \Lambda_3 , \quad (12.6.19)$$

characterized by the decay rates

$$\Gamma(\Lambda_1 \rightarrow \Lambda_2 + \Lambda_3) . \quad (12.6.20)$$

Also the reverse process is possible but there are good reasons to assume that the fusion of the two vortices is a rather rare process.

It is straightforward to write general kinetic equations for the distribution of vortices as a function of Λ and in particular, as a function of the critical radius: this in turn leads to the distribution of the kinetic energy of the vortex as function of the the size of the vortex predicted also in the Heisenberg model for turbulence [B61, B62] . In order to get grasp of the situation it is however useful to make some simplifying assumptions about the decay of the vortices.

- (a) Vortex growth is a rapid process as compared to the motion of vortex between the core and the boundary of the mother vortex. This implies that the integer m associated with the daughter vortex must be smaller than the integer associated with the mother vortex. For simplicity it is assumed

$$m(\text{daughter}) = m(\text{mother}) - 1 . \quad (12.6.21)$$

- (b) The ratio $n_1/n_2 = \omega_1/\omega_2$ remains constant in the decay process if possible: this implies that the change in the functional relationship between CP_2 coordinates u and r is minimized. Since the ratio n_1/k is constant by a semiclassical argument implying that angular momentum is proportional to n_1 , the conservation law

$$\frac{n_i}{k} = \text{constant} , \quad (12.6.22)$$

holding true for all vortices of the cascade is suggestive.

- (c) The conservation law implies that the critical radius, vorticity and and n_i of the daughter vortex are given by

$$\begin{aligned} \rho_{crit}(\text{daughter}) &= \lambda \rho_{crit}(\text{mother}) , \\ k(\text{daughter}) &= \lambda k(\text{mother}) , \\ n_i(\text{daughter}) &\simeq \lambda n_i(\text{mother}) , \\ \lambda &= 2^{-x} . \end{aligned} \quad (12.6.23)$$

The value of x is expected to be integer and will be fixed by the comparison with experiment.

The assumption

$$k(\text{daughter}) = \lambda k(\text{mother}) ,$$

makes sense if one gives up the the assumption that magnetic flux is quantized irrespective of the value of n_1 as is clear by looking at the expression Eq. (12.5.18) for the critical radius for the

vortex flow. One can however allow the increase of n (n_1 is multiple of n rather than arbitrary integer):

$$n(\text{daughter}) = \frac{n(\text{mother})}{\lambda^2} ,$$

as is clear from the formula for the critical radius to achieve the quantization of magnetic flux. If magnetic flux quantization is assumed with the parameter $n = 1$ (n_1 integer) one must have

$$k(\text{daughter}) = \frac{k(\text{mother})}{\lambda} ,$$

in order to get the critical radius correctly. The increase of k might be forced by the angular momentum conservation: if daughter vortices are created on the boundary of the mother vortex (as implied by the geometric picture) in the layer of a thickness $\rho_{crit}(\text{daughter})$, the requirement that the angular momentum of the daughter vortices is of same order of magnitude as that of mother vortex, implies the desired formula. One must however remember that this argument need not make sense since flow equilibrium rather than decay of single vortex is in question. Also the increase of the average rotation velocity in small length scales looks un-physical feature. In any case, there are two possible scenarios:

$$\begin{aligned} \text{a) Quantized magnetic flux and } n_i/k = \text{constant} : , \\ k(\text{daughter}) = \lambda k(\text{mother}) , \\ n(\text{daughter}) = \frac{n(\text{mother})}{\lambda^2} , \end{aligned} \quad (12.6.24)$$

$$\begin{aligned} \text{Quantized magnetic flux and } n = 1 : \\ k(\text{daughter}) = \frac{k(\text{mother})}{\lambda} , \end{aligned}$$

and the scenario 1) looks more attractive.

For the mother vortex the corresponding quantities are after the decay given by

$$\begin{aligned} \rho_{crit}(\text{mother}, f) &= \rho_{crit}(\text{mother}, i) , \\ k(\text{mother}, f) &= k(\text{mother}, i)(1 - \lambda) , \\ n_i(\text{mother}, f) &\simeq n_i(\text{mother}, i)(1 - \lambda) . \end{aligned} \quad (12.6.25)$$

The process stops, when the condition $n_2(\text{mother}, f) = n_2(1 - \lambda)^{N_f} \leq \lambda$ (n_2 refers to the mother vortex created at the wall) is satisfied, which gives the the estimate

$$N_f(n_2) \simeq \frac{(\ln(n_2) + \ln(\lambda))}{|\ln(1 - \lambda)|} , \quad (12.6.26)$$

for the total number of the daughter generations with $m(\text{daughter}) = m(\text{mother}) - 1$ born in the dissipation of the mother vortex by the emission of the daughter vortices.

The distribution of the vortices as a function of the critical radius

Consider now the evaluation of the distribution for the number $N(\rho)$ of the vortices as function of the critical radius ρ .

(a) The number of the daughters in the k :th generation having is given by

$$\begin{aligned} N_d(k) &\simeq \prod_{i=0}^{i=k} N_f(i) , \\ N_f(i) &= \frac{(\ln(n_2) + (i + 1)\ln(\lambda))}{|\ln(1 - \lambda)|} . \end{aligned} \quad (12.6.27)$$

- (b) The size distribution is obtained by expressing the number k of generations in terms of the critical radius

$$k = -\frac{\ln(\rho_m/\rho)}{\ln(\lambda)} . \quad (12.6.28)$$

Here ρ_m denotes the initial value of the vortex radius created at the wall of the channel. Assuming that the size distribution $N(\rho_m)$ for the mother vortices emitted at the wall is known, one obtains the following expression for the size distribution of vortices

$$\begin{aligned} N(\rho) &= \int N(\rho|\rho_m)N(\rho_m)d\rho_m , \\ N(\rho|\rho_m) &= \prod_{i=0}^k N_f(i) , \\ N_f(i) &= \frac{(\ln(n_2) + (i+1)\ln(\lambda))}{|\ln(1-\lambda)|} . \end{aligned} \quad (12.6.29)$$

An approximate expression of $N(\rho/\rho_m)$ holding true for small values of ρ is given by

$$\begin{aligned} N(\rho|\rho_m) &\simeq D\left(\frac{\rho_m}{\rho}\right)^{\alpha+1/\ln(\lambda)} , \\ D &= B^{-\frac{B}{\ln(\lambda)}} A^{\frac{A}{\ln(\lambda)}} , \\ A &= \ln(n_2) + \ln(\lambda) , \\ B &= A + \ln\left(\frac{\rho}{\rho_m}\right) , \\ \alpha &= -\frac{\ln\left(-\frac{1}{\ln(1-\lambda)}\right)}{\ln(\lambda)} \simeq 1 . \end{aligned} \quad (12.6.30)$$

D is a slowly varying logarithmic factor so that $N(\rho_m|\rho)$ behaves as the power $\rho^{1+\frac{1}{\ln(\lambda)}}$ for all values of ρ_m . This implies that for small radii the general form of the size distribution is universal

$$N(\rho) \simeq C\left(\frac{\rho_m}{\rho}\right)^{\alpha+\frac{1}{\ln(\lambda)}} , \quad (12.6.31)$$

where C is some constant, which is determined once the rate of the energy dissipation is known.

The distribution of the kinetic energy of vortex per mass density ρ_m as a function of the vortex radius ρ can be evaluated using the formula

$$\frac{T(\rho)}{\rho_m} = \pi \int_0^\rho \beta^2(\rho)\rho d\rho . \quad (12.6.32)$$

- (a) For $\beta = K/\rho$ one obtains at the limit of the small radii

$$T(\rho) = C\pi K^2 \ln\left(\frac{\rho}{\rho_0}\right)\left(\frac{\rho}{\rho_0}\right)^{\alpha+\frac{1}{\ln(\lambda)}} . \quad (12.6.33)$$

The leading order behavior of the Fourier transform of the energy function defined as $\hat{T}(p) \equiv \int \exp(ip\rho)T(\rho)d\rho$ is for small values of the wave vector given by

$$\begin{aligned}\hat{T}(p) &\simeq p^\Delta, \\ \Delta &= -1 - \alpha - \frac{1}{\ln(\lambda)}.\end{aligned}\tag{12.6.34}$$

(b) For $\beta = \Omega\rho$ one obtains

$$\begin{aligned}T(\rho) &= C\pi\Omega^2\left(\frac{\rho}{\rho_0}\right)^{4+\alpha+\frac{1}{\ln(\lambda)}}, \\ \Delta &= -4 - \alpha - \frac{1}{\ln(\lambda)}.\end{aligned}\tag{12.6.35}$$

In the Heisenberg model for the turbulence [B61, B62] a similar form is obtained and the exponent is in that case equal to $\Delta = -5/3$ and experimentally verified in some cases. It should also be noticed that according to [B61] the assumptions implying $\Delta = -5/3$ in the Heisenberg model are not strictly true for the small values of the vortex radii. On basis of this result it seems that the values of $\Delta(TGD) = -4 - \alpha + \frac{1}{\ln(\lambda)}$ are un-physical in the case of the rigid body flow.

Only the flow $\beta = K/\rho$ predicting constant Z^0 magnetic field apart from logarithmic corrections predicts physically acceptable values of Δ . For $\lambda = 2^5$ one would have $\Delta(TGD) = -1 - \alpha - \frac{1}{\ln(\lambda)} \simeq -1.709$ to be compared with $-5/3 = -1.667$ of the Heisenberg model. The deviation from the prediction of Heisenber model is 2.5 per cent. The prediction does not depend strongly on the value of of the $\lambda = 2^{-x}$ and at the limit $x = \infty$ one has $\Delta = -2$. Hence a statistical distribution for the p-adic scalings involved with the decay does not affect dramatically the prediction.

The general vision about dark matter hierarchy characterized by the values of Planck constant given by $\hbar(n) = \lambda^{-n}\hbar(1)$, $\lambda = v_0/n \simeq 2^{-11}/n$, n integer, encourages to consider the possibility that the scaling is associated with a transition $\hbar(n) \rightarrow \hbar(n-1)$ to a lower level in the dark matter hierarchy accompanied by the reduction of Compton lengths and Compton times by factor λ . The decay to smaller vortices would correspond to a reduction of quantum coherence via a decay of dark weak bosons to lower level dark weak bosons. For $n = 1$ one has $\Delta = -1.869$. For $n = 3$ one would have $\Delta = -1.885$.

Chapter 13

Macroscopic Quantum Phenomena and CP_2 Geometry

13.1 Introduction

Super conductivity, super fluidity and quantum Hall effect are examples of macroscopic quantum phenomena and it is instructive to apply the TGD inspired topological ideas about the formation of the macroscopic quantum systems to these phenomena. This chapter is written for about 15 years ago and I hope that the reader does not forget that much has occurred in TGD since then.

For instance, Z^0 magnetic fields are suggested to be important for understanding super fluidity without precise characterization of their origin. About 15 years after writing the first version of this chapter, it became clear that the source of the long ranged Z^0 fields, as well as other weak fields and color gauge fields predicted by the classical theory could be dark matter at various space-time sheets. Also a precise number theoretic characterization of dark matter, or actually infinite hierarchy of dark matters, emerged. Already earlier it had become clear that the theory predicts a fractal hierarchy of scaled down copies of electro-weak and color physics. I have not added any discussion of the origin of Z^0 classical gauge fields here. This kind of discussion can be found in [K35, K77, K27] .

In the first section the general ideas of the TGD inspired description of supra phases are described. The aim is to make clear the close similarity between super conductivity and super fluidity by treating these phenomena in parallel. What makes possible the unified description is the hypothesis that the role of the ordinary magnetic field in the super conductivity is taken by the Z^0 magnetic field in the super fluid phase.

In the second, more technical section, certain simple imbeddings of Kähler electric and magnetic fields created by matter and relevant to the applications of the theory, are studied.

In the third section a TGD inspired phenomenological description of Quantum Hall effect is proposed. A more refined view about Quantum Hall effect developed about 15 years later can be found in [K88] . In the last section the TGD inspired description of less exotic condensed matter phenomena (conductors, di-electrics and magnetism) using TGD based concepts will be discussed briefly.

13.2 General theory

RGE invariance predicts that that 3-space should have fractal like structure consisting of topological field quanta of all possible sizes glued on each other by the topological sum operation. The join along boundaries bond provides a tool for constructing larger quantum systems from the smaller ones. Since dissipation corresponds to a loss of the quantum coherence, join along

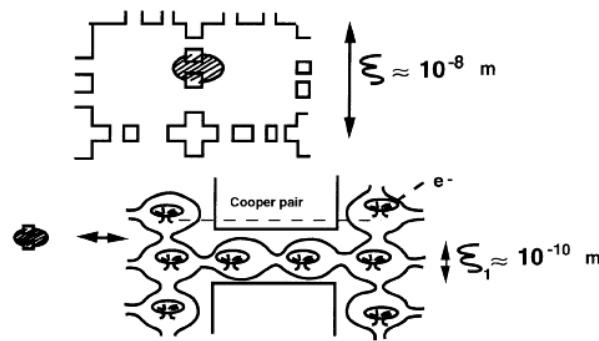

Figure 13.1: Schematic representation for super conductor

boundaries bond should provide a key to a topological description of the dissipation. The generation of the long range classical Z^0 fields is a phenomenon characteristic for TGD, and is expected to be important in the small vacuum quantum number limit of TGD at the condensate levels $n \geq n_Z$ $L(n) \geq \xi \sim 10^{-6}$ m. For supra phases the correlation lengths are such that classical Z^0 force should not have any role in their description.

The mathematical similarities between super conductors and super liquids however suggest that Z^0 magnetic field might play same role in the description of dissipation of super fluids as ordinary magnetic field in the description of the super conductors. The many sheeted structure of the topological condensate and length scale hierarchy remains rather implicit in the following considerations and the most relevant condensation levels are 'atomic condensation level' at which electrons and nuclei are condensed and the level n_Z at which nuclei feed their Z^0 charges.

13.2.1 Identification of the topological field quanta

Both super conductors and Super fluids are characterized by the coherence length ξ . This length tells the size of the largest possible coherent quantum subsystem in the ordinary phase and becomes infinite, when the transition to the supra phase takes place. Below the critical point the value of ξ is finite, but there is macroscopic quantum coherence since the order parameter develops vacuum expectation value. Since topological field quanta correspond in TGD framework to coherent quantum systems a natural assumption is that the relevant topological field quanta have size of the order of ξ . ξ is typically of the order of $\xi \simeq 10^{-8} - 10^{-7}$ meters for super conductors, for super fluid He^4 ξ is of the order of atomic length scale and for He^3 ξ is of the order of 10^{-8} meters. This suggests that also ordinary matter behaves like supra phase in the length scales shorter than ξ . Of course, the corresponding time scale is rather short for the typical velocities of the supra flows.

In accordance with RGE hypothesis, it is assumed that topological field quanta of size ξ have suffered topological condensation in the background 3-space and topological field quanta in turn contain matter as topologically condensed 3-surfaces having size of atomic length scale (see Fig. 13.2.1 and 13.2.2 for a schematic description of what the supra phases look like). For super conductors the topological field quanta of atomic size have also joined along their boundaries to form a lattice.

The size of the topological field quantum is determined by the vacuum quantum numbers associated with it. Since the size of the topological field quantum is rather small, the values of the vacuum quantum ω_1, ω_2 must be small. A first principle explanation for the finite size of the topological field quantum is the maximization of Kähler function. The contribution of the Kähler electric field to the Kähler action is smaller in magnitude if topological field quantization takes

place: the reason is that Kähler electric field necessarily vanishes at some point(s) inside the topological field quantum.

In the simplest model for a topological field quantum matter serves as a source of Kähler field, which in present case is purely electromagnetic field and possible due to the incomplete screening of the nuclear electromagnetic charge by electrons. The critical radius associated with the imbedding of the Kähler electric field gives the size of the topological field quantum, which should be of the order of ξ . The simplest model for the field quantum is as a spherical region. The join along boundaries condensate of the topological field quanta serves as a model for the ordinary phase.

The sizes of the field quanta are exponentially sensitive to the value of the fractal quantum number m , which is small in present case. The order of magnitude for ω_1 is not much larger than proton mass: the estimates give $\omega_1 = (10^{2.5} - 10^3)m_p$ (m_p is proton mass). In the astrophysical length scales and possibly also in the background 3-space surrounding topological field quanta in question the value of ω_1 is of the order of $m_0 \sim 1/R \sim 10^{-4}m_{Pl}$, where R is CP_2 radius.

Inside each topological field quantum one must perform a choice of the quantization axis and in the ordinary phase these choices are not correlated in accordance with the idea that quantum coherence is lost. In supra phase the presence of the join along boundaries bonds implies that same choice of the quantization axis must be performed in the whole phase and the global choice of the quantization axis is analogous to that taking place in the quantum measurement.

13.2.2 Formation of the supra phase

Supra phase corresponds to lattice like structure of the topological field quanta of size ξ joined together by the join along boundaries bonds. In the lowest order approximation one can regard this lattice as a network formed by straight cylinders glued together by bonds. (see Fig. 13.2.1 and 13.2.2). In supraphase the quantum numbers n_1 associated with the composite field quanta must vanish identically since otherwise the coordinate Φ is discontinuous somewhere on the bond joining the neighbouring field quanta and the field quantum in question separates from the supra phase. Exception is formed by the direction of the quantization axis, where bonds survive.

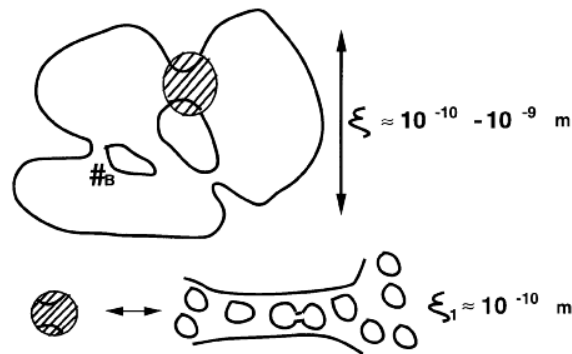

Figure 13.2: Schematic representation for Super Fluid

Two-fluid picture topologically

Supra flow is made possible by the bonds between the neighbouring topological field quanta and there is no essential difference between super conductors and super fluids in this respect. In case of the super conductors the topological field quanta form a rigid lattice but in case of super

fluids topological field quanta are able to move. This freedom implies the two-fluid picture of the super fluidity (see Fig. 13.2.2) as the following argument shows.

- (a) Normal liquid corresponds to the topological field quanta (of size ξ), which flow in the background 3-space. Since the bonds are absent in the ordinary phase, the matter condensed on the topological field quanta follows the flow of the topological field quanta so that topological field quanta can be regarded as effective fluid particles and their mass density is that of the liquid: $\rho_n = \rho$.
- (b) In supra phase the presence of the bonds make possible the flow of the topologically condensed matter and if the bonds are stable the condensed matter flows completely freely: $\rho_s = \rho$. This means that topological field quanta itself lose totally their inertia so that $\rho_n = 0$. Although the flow of the topological field quanta is possible it does not correspond to the flow of an inertial mass. This is certainly the situation at sufficiently low temperatures.
- (c) For temperatures slightly below T_c the situation is known to be intermediate between these two situations and two-fluid hydrodynamics [D14] is a good phenomenological description of the situation. One can consider two alternative explanations for this state of affairs. The first explanation is that the fluid is a mixture of the normal and super fluid components not only in critical temperature but also little below it so that one can speak about two fluids with average densities satisfying the condition $\rho_n + \rho_s = \rho$. The second alternative is that for the temperatures close to T_c the bonds are not completely stable and condensed matter doesn't flow completely freely so that topological field quanta do not lose their inertia totally.
- (d) One can understand also the frictionless supra flow in this picture. For example, in the frictionless supra flow in a channel, the topological field quanta are at rest with respect to the walls of the channel and only the matter condensed on the field quanta flows.

It should be emphasized that in TGD framework it is not possible to apply two-fluid picture to the description of the electrons in Super conductors since the particles of the "normal fluid" correspond to topological field quanta rather than electrons or atoms.

Ground states for the supra phases

In the ground state of the super conductor, the order parameter is covariantly constant with respect to the covariant derivative defined by the electromagnetic gauge potential. Covariant constancy indeed makes sense since, in the absence of the magnetic fields, the gauge potential is pure gauge in the spatial degrees of freedom. In the standard physics context the first homotopy group of the 3-space is trivial and gauge potential can always be gauge transformed away so that the order parameter is just constant in the ground state. In TGD context, the first homotopy of 3-surface is nontrivial and very complicated for a join along boundaries condensate formed from the topological field quanta glued by the join along boundaries bonds. This implies that there is rich structure of different covariantly constant ground states, which look macroscopically identical since the splitting of single join along boundaries bond is not expected to affect the macroscopic properties of the system.

The induced gauge potential is in the case of the super conductors just the electromagnetic gauge potential. Assuming that Z^0 gauge fields are absent, one obtains the proportionality of the electromagnetic and Kähler gauge potentials:

$$A_{em} = 3A_K = 3P^k dQ_k . \quad (13.2.1)$$

Here P_k and Q_k are canonical coordinates for CP_2 . An especially natural choice for the canonical coordinates is the one for which Q_k , $k = 1, 2$ correspond to the phase angles Ψ and Φ associated with the complex CP_2 coordinates for which the action of $U(2)$ rotations is linear.

In case of the supra fluids Z^0 gauge potential if electromagnetic neutrality holds true and again the gauge potential is proportional to Kähler potential

$$\begin{aligned} A_Z &= \frac{6}{p} A_K = \frac{6}{p} P^k dQ_k , \\ p &\equiv \sin^2(\theta_W) . \end{aligned} \quad (13.2.2)$$

If the ground state has vanishing gauge field the induced Kähler field must vanish and one has vacuum extremal of the Kähler action satisfying

$$P_k = \partial_k f(Q_i) , \quad (13.2.3)$$

where f is arbitrary function of the coordinates Q_i . In case that Q_i correspond to the angle coordinates Ψ and Φ of CP_2 one can write $f(Q_i)$ as a sum of a zero mode part and Fourier expansion

$$f = m\Psi + n\Phi + \sum_{kl} c_{kl} \exp(ik\Psi + il\Phi) . \quad (13.2.4)$$

The covariant constancy condition for an order parameter possessing em (Z^0) charge Q_{em} (Q_Z) reads as

$$\begin{aligned} (\partial_\mu + ia\partial_\mu f)\psi &= 0 , \\ a_{em} &= 3Q_{em} , \\ a_Z &= \frac{6Q_Z}{p} . \end{aligned} \quad (13.2.5)$$

The solution of the condition is

$$\begin{aligned} \psi &= \exp(iS)\psi_0 , \\ S_{em} &= -3Q_{em}f , \\ S_Z &= -\frac{6Q_Z}{p}f . \end{aligned} \quad (13.2.6)$$

in the two cases respectively.

The phase increments around the closed homotopically nontrivial loops clearly characterize the ground state of the supra phase. In the electromagnetic case the change of the phase of ψ around a closed loop equals to

$$\Delta S_{em} = 3Q_{em}(m\Delta\Psi + n\Delta\Phi) , \quad (13.2.7)$$

and is clearly a multiple of 2π (also for quarks!) since m and n appearing in the expansion of f are in general integers. For supra fluids one has

$$\Delta S_Z = \frac{6Q_Z}{p}(m\Delta\Psi + n\Delta\Phi) , \quad (13.2.8)$$

The values of Q_Z for proton and neutron are $Q_Z(\text{neutron}) = -1/4$ and $Q_Z(\text{proton}) = 1/4 - p$ so that one has for an order parameter describing the supra flow of nuclei (A, Z)

$$\Delta S_Z = 6\left(\frac{(2Z - A)}{4p} - Z\right)(m\Delta\Psi + n\Delta\Phi) , \quad (13.2.9)$$

The increment is *not* integer multiple of 2π without additional conditions on the value of the Weinberg angle. If p is rational number of form $p = r/s$, s must divide m and n . For instance, for $\sin^2(\theta_W) = 1/4$ the vectorial couplings of the electron and proton to Z^0 field vanish and the average Z^0 charge of neutron is $Q_Z(n) = -1/4 = p$ so that one has in general $Q_Z(\text{nucleus}) = -(A - Z)/4$ and the increment of S_Z is automatically multiple of 2π for all choices of m and n :

$$\Delta S_Z = -6(A - Z)(m\Delta\Psi + n\Delta\Phi) . \quad (13.2.10)$$

Also for $p = 3/8$ the condition is identically satisfied.

For more complicated supra phases (Super liquid He^3) the order parameter possesses several components but also now a similar situation results. It is tempting to assume that for more general states the phase factor of ψ is power of S . If this is the case then supra phases are exceptional in the sense that CP_2 angle coordinates appear as physical observables rather than only the gauge fields (proportional to the gradients of CP_2 coordinates) as in the ordinary ordinary phase. What is clear is that the information about the homotopy of the state is coded into the phase of the order parameter. This state of affairs is especially interesting as far the applications to the BE condensate of the charged $\#$ throats possibly having an important role in bio-systems, are considered.

Binding energies and critical temperatures

What makes the supra flow possible are the bonds. Cooper pair also stabilize the bonds in case of the super conductors and 3He super fluid. This becomes clear from the fact that the electrons of the Cooper pair have an average distance, which is considerably larger than ξ (about 10^{-6} meters in super conductors [D14]) so that the splitting of the bonds destroys Cooper pairs. Energy is however needed to destroy Cooper pairs and this implies stability. If the energy associated with the bonds were negligible with the binding energy associated with the Cooper pairs the phase transition leading to super conducting phase would be a first order transition involving non-vanishing latent heat. This is however not the case [D14] . This means that the binding energy of the Cooper pairs doesn't leave super conductor and probably goes to the energy associated with the bonds. Therefore the stabilization mechanism relies on the difficulty of transferring the bond energy to the Cooper pairs.

A rough estimate for the binding energy for the Cooper pair provides a test for the proposed ideas. In the ordinary phase conduction electrons tend to be confined inside the topological field quanta so that by Uncertainty Principle they possess kinetic energy of the order of

$$T \simeq \frac{1}{2m_e\xi^2} . \quad (13.2.11)$$

In the super conducting phase conduction electrons are not localized inside single field quantum so that the average kinetic energy is smaller and the order of magnitude estimate

$$\Delta E \simeq \frac{1}{4m_e\xi^2} , \quad (13.2.12)$$

for the binding energy of the Cooper pair is obtained. For $\xi \simeq 10^{-7}$ meters one obtains $\Delta E \simeq 10^{-4}eV$, which corresponds to the temperature of $T_c \simeq 0.25$ K. The order of magnitude is correct.

For a high temperature super conductors with $T_c \simeq 100$ K, the estimate gives $\xi \simeq 10^{-9}$ meters. High temperature super conductors have layered structure. In case of $YBa_2Cu_2O_7$ the coherence length is $\xi_c = 1.5 - 3$ Angströms in the direction orthogonal to the layers and $\xi_{ab} = 14 \pm 2$ Angströms in the direction of the layers [D9] . The supra current is known to be confined inside the layers so that ξ_{ab} should determine the critical temperature: the orders of magnitude are consistent with the formula correlating Δ and ξ in the example considered and also more generally, since the transversal coherence lengths are known to be by an order of magnitude smaller than for the ordinary super conductors.

For the binding energy of the super fluid particles one obtains a completely analogous estimate (m_e is replaced with the mass of He^3 or He^4 nucleus) and correct order of magnitude estimates are obtained for both He^3 and He^4 having widely different values of ξ (ξ is about 10^{-8} meters and few Angströms for 4He and 3He respectively). From the binding energies one can estimate the critical temperatures ($T_c \simeq \Delta E$) and correct order of magnitude estimates are obtained.

The presence of super fluid phase in neutron stars has been suggested [D14] : Cooper pairs correspond to paired neutrons. The size of the field quantum is of the order of $\xi = 10^{-15} - 10^{-14}$ meters (this estimate is derived in the second section). For the critical temperature one obtains: $T_c \simeq 1/4m_n\xi^2 = 10^{11} - 10^{13}$ K.

In BCS theory ΔE is expressed in the following form [D14]

$$\begin{aligned} \Delta &= 2\omega_D \exp\left(-\frac{2}{N(0)V}\right) , \\ \omega_D &= \frac{c_s 6^{1/3} \pi}{N^{1/3}} . \end{aligned} \quad (13.2.13)$$

Here ω_D is Debye frequency, $N(0)$ is the density of states on the surface of the Fermi sphere and $V(0)$ characterizes the strength of the attractive force between the electrons of the Cooper pair. N is the number density of atoms and c_s is the velocity sound. The proportionality to ω_D implies isotope effect: $\Delta \propto 1/A^\alpha$, where α is typically of the order of $\alpha \simeq 1/2$, which has been verified experimentally [D14] . Assuming that both formulas are correct one gets a relationship between the vacuum quantum numbers ω_1 and ω_2 since ξ corresponds to the radius of the topological field quantum and is expressible in terms of the vacuum quantum numbers.

13.2.3 Generalized quantization conditions

In the standard formulation of the quantum description of Super conductivity one starts from Schrödinger amplitude ψ_s for supra phase. The expression for the matrix element of the electric current is given by

$$\begin{aligned} \bar{j}_e &= -i\frac{e}{2m}(\bar{\psi}_s \bar{D}\psi_s - c.c.) , \\ \bar{D} &= \nabla + iqe\bar{A} . \end{aligned} \quad (13.2.14)$$

Here q denotes the charge of the superconducting charge carrier in units of e . $q = -2$ for the super conductors encountered in laboratory. One can write ψ_s in the form $\psi_s = \sqrt{n_s} \exp(iS)$.

Since n_s is in a good approximation constant in supra phase the expressions for the electric current and velocity operator can be written as

$$\begin{aligned}\bar{j}_e &= -\frac{e}{m} n_s (\nabla + qe\bar{A}) , \\ \bar{v}_s &= \frac{1}{m} (\nabla S + qe\bar{A}) .\end{aligned}\tag{13.2.15}$$

Since S is single valued, one obtains by integrating over a closed curve a formula relating the magnetic flux and velocity circulation for the carriers of the super current to each other.

$$\oint \bar{v} \cdot d\bar{l} - \frac{qe}{m} \oint \bar{A} \cdot d\bar{l} = \frac{n2\pi}{m} .\tag{13.2.16}$$

If the velocity field vanishes in the curve in question, one obtains the standard quantization of the magnetic flux.

By taking a curl of the formula for \bar{v}_s and using Maxwell's equations one gets the standard formula

$$\begin{aligned}\nabla^2 \bar{B} &= \frac{\bar{B}}{\lambda^2} , \\ \lambda^2 &= \frac{2m}{n_s q^2 e^2} .\end{aligned}\tag{13.2.17}$$

Here λ is the penetration length for the magnetic field in the super conductor.

TGD predicts that vacuum Z^0 field can become long ranged at small vacuum quantum number limit of TGD and super fluidity might correspond to this kind of situation. If this is indeed the case then the previous formulas for the super conductors generalize in an obvious manner to the case of Super fluids

$$\oint \bar{v} \cdot d\bar{l} - \frac{Q_Z g_Z}{M} \oint \bar{A}_Z \cdot d\bar{l} = \frac{n2\pi}{M} .\tag{13.2.18}$$

Here M is the mass of the super fluid particle (He^4 or the Cooper pair formed by two He^3 atoms), g_Z is the gauge coupling of the Z^0 gauge interaction ($g_Z^2 = e^2 / \sin\theta_W \cos\theta_W$) and Q_Z is Z^0 charge of the super fluid particle. Q_Z is defined as the expectation value over the spin degrees of freedom

$$\begin{aligned}Q_Z &= \langle I_L^3 - pQ_{em} \rangle , \\ p &= \sin^2(\theta_W) .\end{aligned}\tag{13.2.19}$$

The values of Q_Z for quarks and electron at rest are

$$Q_Z(u) = \frac{1}{4} - \frac{2p}{3}, \quad Q_Z(d) = -\frac{1}{4} + \frac{p}{3}, \quad Q_Z(e) = -\frac{1}{4} + p. \quad (13.2.20)$$

From these one obtains the values of Q_Z for proton and neutron: $Q_Z(p) = 1/4 - p$ and $Q_Z(n) = -1/4$ respectively. The values of Q_Z for He^4 and He^3 are

$$Q_Z(^4He) = -\frac{1}{2}, \quad Q_Z(^3He) = -\frac{1}{4}. \quad (13.2.21)$$

If the magnetic flux associated with Z^0 magnetic field vanishes one obtains the standard formula for the quantization of the velocity circulation of the super fluid. The expression for the penetration depth of the Z^0 magnetic field reads as

$$\lambda^2 = \frac{2M}{N_s Q_Z^2 g_Z^2}. \quad (13.2.22)$$

The order of magnitude of λ is of the order of $10^{-5} - 10^{-6}$ meters in accordance with the basic assumption $\xi \sim 10^{-6}$ meters for the scale at which classical Z^0 force becomes important. In this formula N_s is the entire super fluid density (essentially Z^0 charge density) and the formula makes sense at the condensation level at which the nuclei feed their Z^0 charges. At the higher condensate levels n , one must replace the density with the actual density of Z^0 charge $N_s \rightarrow N_s / \sqrt{\epsilon_Z(n)}$ (due to the neutrino screening $\epsilon_Z(n)$ is rather large number).

It will found that this generalization implies considerable differences between TGD based and standard descriptions of the super fluidity. For example, the counter part of the magnetic flux quantum is predicted and is a good candidate for the elementary excitation leading to the dissipative super fluid flow at critical velocity considerably smaller than that associated with the known elementary excitations.

13.2.4 Dissipation in super fluids: critical velocities

Dissipation, or equivalently the loss of the quantum coherence results, when the lifetimes of the bonds connecting neighbouring field quanta are short and the joining and the splitting of the bonds provides the needed dissipation mechanism. One mechanism leading to a loss of the quantum coherence is thermal noise: the critical temperature has been already evaluated. In case of super conductors (super fluids) also external magnetic (Z^0 magnetic) fields lead to a loss of the quantum coherence: the values of the critical magnetic fields can be evaluated for the super conductors of type II and super fluids from the quantization condition. At a high enough flow velocity, the generation of the elementary excitations of the supra phase leads to dissipation. The estimates for the orders of magnitude for the critical velocities for the setup of the dissipation will be derived and are correct in both cases.

Critical velocity for super fluids

The so called Principle of Super Fluidity provides an explanation for the critical velocity of the Super fluid [D14]. The application of the energy and momentum conservation to the emission of elementary excitation of energy ϵ and momentum p by flow implies the condition $v \geq \epsilon/p$ and therefore the critical velocity is given by the formula

$$v_L = \text{Min}\left\{\frac{\epsilon}{p}\right\} . \quad (13.2.23)$$

In case of the super conductors the formula gives $v_L = \Delta(T)/k_F$ (Δ is the energy gap associated with the Cooper pair and k_F is Fermi momentum): the order of magnitude is correct. In case of Super fluids the critical velocities deduced from the roton and phonon spectrum (239 m/s and 58 m/s respectively) are several orders of magnitude larger than the velocities $v_{cr} \simeq 6 \cdot 10^{-3}$ meters), where the dissipation is known to set up. Velocity vortex predicts a critical velocity, which is too large by an order of magnitude. The hitherto unsolved problem is to identify the excitations giving rise to the dissipation in the supra flow.

The TGD based candidate for the excitation is Z^0 magnetic flux quantum. Z^0 magnetic flux quantum can appear at the condensate level with $L(n) \geq 10^{-6}$ meters to which nuclei feed their Z^0 charges so that the super fluid flow (typically rotating vessel) must have size scale much larger than this length scale. Both hydrodynamic and magnetic excitations are vortex like structures and in order to estimate orders of magnitude they can be idealized as straight vortices with a cylindrical symmetry, possessing Z^0 magnetic field in the direction of the vortex and rotational velocity field (to be studied in detail in the next section).

A general order of magnitude estimate for the critical velocity is obtained by assuming that at velocities higher than the critical velocity the kinetic energy of the supra phase goes to the energy of the excitation in question. The criticality criterion states that $dE_K(R)/dl$, the kinetic energy of the supra flow per unit length of the vortex of radius R and $dE_{ex}(R)/dl$, the energy of the excitation per unit length of the vortex, are identical:

$$\frac{dE_K(R)}{dl} = \frac{dE_{ex}(R)}{dl} .$$

This implies for the critical velocity the expression

$$v_{cr} = \sqrt{\frac{2}{NM\pi R^2}} \sqrt{\frac{dE_{ex}(R)}{dl}} . \quad (13.2.24)$$

Let us consider now in more detail the magnetic and hydrodynamic vortices.

a) Z^0 magnetic flux quantum

For the Z^0 magnetic flux quantum it is natural to assume that the core of the vortex corresponds to $n_1 \neq 0$ excitation since the requirement that no magnetic field is present implies $n_2/n_1 = \omega_2/\omega_1$ so that both n_2 and n_1 must be non-vanishing. A reasonable idealization for the vortex core is as a cylinder of radius ξ . Inside the vortex core the order parameter of the supra phase is constant so that the condition

$$\oint \bar{v} \cdot d\bar{l} - \frac{Q_Z g_Z}{M_4} \oint \bar{A}_Z \cdot d\bar{l} = 0 , \quad (13.2.25)$$

holding true for the ground states described by covariantly constant order parameter, is appropriate. The general quantization condition allows $n \neq 0$ but this implies singular velocity in the core of the vortex so that it will be dropped from consideration.

Since $B_Z = B_Z^0$ is constant, one can solve \bar{v}

$$v = \frac{g_Z Q_Z B_Z^0}{2M_4} \rho . \quad (13.2.26)$$

The core rotates like a rigid body and the rotation frequency is just the rotation frequency of Z^0 charged particle in Z^0 magnetic field. $\nabla^2 B_Z = 0 \neq B_Z/\lambda^2$ so that the matter inside the vortex core is not in supra phase.

Outside the vortex core the conditions

$$\begin{aligned} \oint \bar{v} \cdot d\bar{l} - \frac{Q_Z g_Z}{M_4} \int B_Z da &= \frac{n2\pi}{M_4} , \\ \nabla^2 B_Z &= \frac{B_Z}{\lambda^2} . \end{aligned} \quad (13.2.27)$$

are satisfied.

Both Z^0 magnetic and velocity fields decay exponentially. At large distances one obtains flux quantization and the constant value of B_Z inside the vortex core is fixed by the flux quantization condition:

$$B_Z^0 = \left[-2 \int_{\xi}^{\infty} B_Z \rho d\rho + \frac{2n}{g_Z Q_Z} \right] \frac{1}{\xi^2} . \quad (13.2.28)$$

For order of magnitude purposes one can use the approximation

$$B_Z^0 \simeq \frac{2n}{q_Z Q_Z \lambda^2} . \quad (13.2.29)$$

Since the magnitude of B_Z^0 is quantized in integer multiples, all values of n are possible.

There are two contributions to the energy density of the flux quantum. The energy E_B of the Z^0 magnetic field and the kinetic energy T_{rot} of the rotating super fluid particles. The latter contribution is negligible ($T_{rot}/E_B \simeq (\xi/\lambda)^2$) so that it is enough to consider the magnetic energy density. Since B_Z is largest in the core of the vortex the most conservative form for the criterion is obtained by requiring that the kinetic energy density $T_K = N_s M_4 v^2/2$ of the super fluid flow equals to the Z^0 magnetic energy density $E_B = B_Z^2/2$ inside the core. This condition gives the following expression for the critical velocity

$$v_{cr}(magn) = \frac{B_Z^0}{\sqrt{N M_4}} \simeq g_Z Q_Z \sqrt{\frac{N_s}{M_4^3}} . \quad (13.2.30)$$

Substituting the typical value of N_s : $N_s \simeq 10^{28.5}/m^3$ one finds $v_{cr} \simeq 10^{-3}$ m/s. The value of the critical velocity is indeed known to be few millimeters in second [B37] , [D14] !

b) Hydrodynamic vortices

The velocity field of the vortex behaves as k/ρ , where $k = n2\pi/M$ is the quantized vorticity. The kinetic energy of the vortex is of the order of $M_4 k^2 \ln(\lambda/\xi)/2$ so that that one obtains for the critical velocity the expression

$$v_{cr}(hydro) \simeq \sqrt{2} \ln(\lambda/\xi) v_{cr}(magn) . \quad (13.2.31)$$

Substituting the numerical values of the parameters, one finds that the numerical factor is of the order of ten so that hydrodynamic critical velocity is too large by an order of magnitude [B37] , [D14] .

Critical velocities for the super conductors

To derive the critical velocities for the super conductors of type II one can apply considerations formally identical with the previous ones. The structure of the magnetized vortices is similar to that of Z^0 magnetized vortices and at the critical velocity the kinetic energy density of the super conducting phase must be identical to the magnetic energy density of $n_1 = 1$ excitation:

$$\frac{n_s m_e \beta_c^2}{2} = \frac{B_c^2}{2} . \quad (13.2.32)$$

Using the expression for the number density of the super conducting electrons $n_s = \frac{m_e}{e^2 \lambda^2}$ one gets

$$\beta_c = \frac{B_c \lambda e}{m_e} . \quad (13.2.33)$$

Using the estimate for B_c one obtains $\beta_c \simeq \frac{\sqrt{4\pi}}{m_e \lambda}$ for the super conductors of type II. The order of magnitude obtained, typically 10^2 m/s, is correct [D14] . For super conducting elements of type I β_c is considerably smaller since both the critical field and λ are smaller: the order of magnitude is few meters per second and considerably smaller than the critical velocity v_L obtained from the Landau criterion.

13.2.5 Meissner effect

Meissner effect is one of the basic effects of super conductivity and it is of interest to find the TGD based description of the effect and how Meissner effect generalizes to the super fluid phase.

Meissner effect in superconductors

Meissner effect differs for the super conductors of type I and II. For super conductors of type I, the external field penetrates the whole super conductor if it has strength larger than the critical strength B_c . For super conductors of type II the external magnetic field begins to penetrate after having reached certain critical value B_{c_1} and total penetration takes place at considerably larger value of B_{c_2} . The penetration takes place as flux quanta

$$\int B \cdot da = \frac{m\pi}{e} , \quad (13.2.34)$$

where m is integer. This condition follows from the general quantization conditions provided the velocity of the super conducting charge carriers vanishes for large distances from the core of the magnetic flux quantum.

The TGD inspired model for the Meissner effect is based on the following observations.

- (a) The study of the simple models for the topological field quanta to be carried out later shows that in the supra phase topological field quanta have vanishing magnetic vacuum quantum numbers (n_1, n_2) and that there is a nontrivial magnetic field associated with $(n_1, n_2) \neq (0, 0)$ excitations of the topological field quanta. Magnetic field is in the direction of the quantization axis and is approximately constant for a cylindrically symmetric field quantum. The flux of this magnetic field is also quantized by purely topological reasons. For $(n_1 = 0, n_2 \neq 0)$ magnetic field is also non-vanishing and this field doesn't cut the bonds between the field quanta so that one could in principle construct a magnetic field in super conductor using these excitations. If, however, the condition

$$k \equiv \frac{\omega_2}{\omega_1} \ll 1, \quad (13.2.35)$$

holds true, then the flux associated with $(n_1 \neq 0, n_2 = 0)$ is much smaller than for $n_1 = 0$ excitations and it is energetically more favorable to excite $n_1 \neq 0$ excitations so that super conductivity is lost. The study of the simple models for field quanta shows that the assumption that ω_1 has same value for all supra phases, implies this condition.

- (b) The flux of the critical magnetic field is typically of the order of 10^{-2} Tesla and the flux of B_{c2} over the field quantum of radius $\xi \simeq 10^{-7}$ m is considerably smaller than the quantized value of the magnetic flux for the super conducting elements (mostly of type I).
- (c) Since λ is much smaller than ξ for super conductors of type I, the magnetic flux associated with the magnetic vortex is smaller than the quantized magnetic flux, which together with the quantization condition implies that the velocity associated with the vortex cannot approach zero in large distances so that the kinetic energy of the vortex is large and this kind of excitation is not energetically favorable in case of the super conductors of type I. Rather, the magnetic field penetrates as $n_1 \neq 0$ excitation into each topological field quantum separately and as a result the bonds between field quanta are destroyed in the directions transversal to the magnetic field and supra phase is destroyed. For the super conductors of type II λ is large as compared to the radius of the vortex core and magnetic field can penetrate in the form of the flux quanta.

These observations suggest the following description of the Meissner effect.

a) Meissner effect for the super conductor of type I

Magnetic field penetrates into super conductors of type I as topologically nontrivial $(n_1 = 1 \neq 0)$ excitations of the individual field quanta (see Fig. 13.2.5). The critical magnetic field is just that associated with $n_1 = 1$ excitation and the penetration of the magnetic field tends to destroy the bonds between the neighbouring field quanta since Φ becomes necessarily discontinuous on the bond. The bonds in the direction of \vec{B} form an exception and might well survive. A structure consisting of topologically condensed cylinder like structures (see Fig. 13.2.5) results. That super conductivity disappears totally is suggested by the observation that $\Lambda = 0$ inside these structures and by the fact electrons rotate in the magnetic field.

The quantization of the magnetic flux takes place in case of Super conductors of type I, too, but the unit is now defined by B_c and smaller than the standard unit. The requirement that the magnetic field associated with the $n_1 = 1$ field quantum equals to B_c gives condition on the vacuum parameters of type I super conductor.

It would be nice if one could estimate the value of the critical magnetic field or equivalently, the value of the magnetic field associated with the $n_1 = 1$ excitation. The prediction is possible provided one can estimate the values of the vacuum quantum numbers associated with the imbedding of Kähler electric field of matter: in the next section this kind of estimate is carried out.

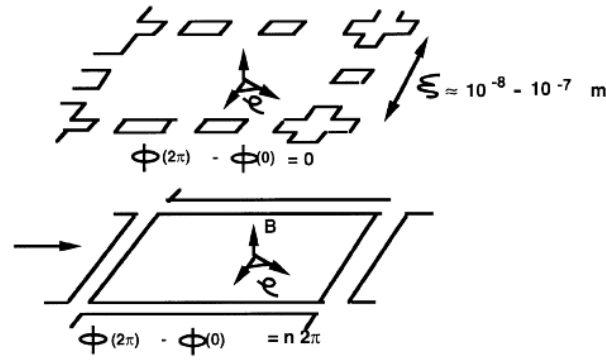

Figure 13.3: The penetration of magnetic field into a super conductor of type I

b) Meissner effect for the super conductor of type II

Magnetic field penetrates into super conductors of type II as approximately cylindrical field quanta. The core of the cylinder corresponds to a topological field quantum of radius of order ξ , which has suffered topologically nontrivial ($n_1 \neq 0$) excitation. Since the flux associated with $n = 1$ quantum is considerably smaller than that required by the quantization of magnetic flux, an exponentially damped magnetic field is created in the surrounding field quanta. This field corresponds to a topologically trivial deformation ($n_1 = 0!$) in the dependence of Φ on the M^4 coordinates and therefore the bonds connecting nearby neighbours are not destroyed and this region corresponds to a supra phase. The quantized magnetic flux is essentially given by the region surrounding the core.

The value of the critical magnetic field B_{c_1} can be estimated by noticing that the external magnetic field decomposes into field quanta with the property that the total flux of field quanta is same as that associated with the external field. This gives

$$B = n_v \frac{\pi}{e} , \tag{13.2.36}$$

where n_v is the number of flux quanta per unit area. As an estimate for n_v one can take $n_v \simeq 1/\pi\lambda^2$, so that one obtains the estimate

$$B_{c_1} \simeq \frac{1}{e\lambda^2} . \tag{13.2.37}$$

The order of magnitude is about 10^{-1} Tesla for $\lambda \simeq 10^{-7}$ m: for Nb , which is the only superconducting element of type II the order of magnitude for critical magnetic field is indeed this [D14] . The value of the magnetic field associated with $n = 1$ excitation cannot be very much larger than this field. It is natural to identify B_{c_2} as the magnetic field associated with $n_1 = 1$ excitation and so that the previous estimate combined with the estimate for B_1 gives $B_{c_2} \simeq 2B_{c_1}$.

Notice that the proposed model explains why ferromagnetic materials cannot be super conducting provided one can assume that the condition $k \ll 1$ holds true generally (ω_1 depends only weakly on material).

Meissner effect for super fluids

TGD predicts that Meissner effect is possible for super fluids, too and that super fluids are completely analogous to super conductors of type II. The magnetic vortices in the super fluid correspond to the quanta of the Z^0 magnetic flux.

The critical value of B_Z cannot be obtained directly from the experiment. The critical value of B_Z can be estimated by generalizing the formula of B_c for super conductors of type II and the formula for the penetration length λ

$$\begin{aligned} B_c^Z &\simeq \frac{1}{Q_Z g_Z \lambda^2} , \\ \lambda^2 &= \frac{2M}{Q_Z^2 g_Z^2 N_s} , \end{aligned} \quad (13.2.38)$$

where M is the mass of the super fluid particle and g_Z is Z^0 coupling constant and N_s the number density of the super fluid particles.

Superfluid should prohibit the penetration of Z^0 magnetic field created by some external source by creating surface flow. The obvious question is whether one can imagine any experimental tests for the prediction. To get grasp of the situation one can consider the following simple experimental arrangement.

A cylinder containing super fluid is surrounded by a rotating cylinder (see Fig. 13.2.5). The rotation of the outer cylinder creates Kähler magnetic and therefore also Z^0 magnetic field. Meissner effect implies that a surface flow is generated on the boundary of the super fluid vessel possessing direction opposite to that of rotation. A related effect would be the penetration of the Z^0 magnetic field in the form of vortices creating visible hydrodynamic vortices in the liquid. Unfortunately, the Z^0 field in question is extremely weak (for ordinary vacuum quantum numbers) so that the surface flow needed to cancel the Z^0 magnetic field is very small and might imply that the effect is not observable. Also the penetration of the field in the form of vortices is very unprobable since penetration takes place only above some critical field strength, which is quite large.

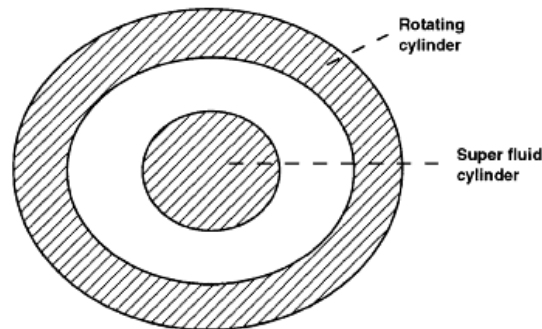

Figure 13.4: Experimental arrangement demonstrating Meissner effect for Super fluids

Consider next a simple quantitative model for the situation. The constant axial Kähler magnetic field created by the rotating outer cylinder is given by the expression

$$\begin{aligned} B_{out}^K &= \epsilon_1(out) N_{out} \Omega_{out} S_{out} , \\ S_{out} &= \pi(R_1^2 - R_0^2) , \end{aligned} \quad (13.2.39)$$

where S_{out} denotes the cross-sectional area of the outer cylinder with the inner radius R_0 and outer radius R_1 and rotating with the angular velocity Ω_{out} .

The constant axial magnetic field created by a surface current of thickness λ rotating around the superfluid cylinder of radius R is given by

$$\begin{aligned} B_{in}^K &= \epsilon_1(in) N_s \Omega_{in} S_{in} , \\ S_{in} &= \pi(R^2 - (R - \lambda)^2) , \end{aligned} \quad (13.2.40)$$

where N_s denotes the density of the super fluid particles and Ω_{in} is the rotation velocity of the super fluid flow.

These fields must cancel each other inside the super fluid so that a condition for the ratio of rotation frequencies results

$$\begin{aligned} \frac{\Omega_{in}}{\Omega_{out}} &= \frac{\epsilon_1(out) N_{out} S_{out}}{\epsilon_1(in) N_s S_{in}} \\ &\simeq \frac{\epsilon_1(out) N_{out} R_1^2}{\epsilon_1(in) N_s 2R\lambda} , \end{aligned} \quad (13.2.41)$$

where the assumption $R_1 \gg R_0$ is made. An order of magnitude estimate for Ω_{in} is obtained using magnitudes $R_1 = 1 \text{ m}$, $R = 10^{-3} \text{ m}$, $\lambda \simeq 10^{-5} \text{ m}$ and $\Omega_{out} \simeq 10^3/s$. The Z^0 current fed from the ‘‘previous’’ condensate level serves as source of Z^0 magnetic field at level n since neutrinos do not participate in the flow. The estimate for the the ratio of parameters $\epsilon_1(n_Z)$ is obtained as follows: at nuclear condensate level one has $\epsilon_1 \sim 10^{19} g_Z$ (no screening) and at the condensate level n_Z one has $\sqrt{\epsilon_Z(n_Z)} \sim 10^{10} - 10^{11}$ from the estimate to be carried out in next subsection, which gives $\epsilon_1(out) \in 10^8 g_Z - 10^9 g_Z$. This gives

$$\Omega_{in} \sim 10^{-10} \frac{N_0}{N_s} \Omega_{out} \geq \frac{1}{200 \text{ minutes}} , \quad (13.2.42)$$

for $\epsilon_Z = 10^{11}$. Whether the existence or nonexistence of this kind of effect could be determined experimentally remains an open question.

Rotating super fluid

In the two fluid theory the condition that super fluid flow is irrotational ($\nabla \times \bar{v} = 0$) seems to exclude the rigid body rotation of the super fluid. On the average super fluid phase is however known to rotate like rigid body [B37], [D14] and the problem is to explain this result.

a) Hydrodynamic vortices

The generally accepted resolution of the difficulty [D14] is that super fluid flow decomposes into hydrodynamic vortices, with the property that the flow is irrotational inside the vortices except in the core of the vortex where super fluid density vanishes: this is achieved if the velocity is given by $v = k/\rho$. The requirement that super fluid wave function is single valued, implies the quantization of the circulation for the vortex

$$\oint \bar{v} \cdot d\bar{r} = \frac{n2\pi}{M} ,$$

implying the condition $k = n/M$. Vortices in turn form a regular array, which rotates like a rigid body. The average vorticity per surface area is given by $n_v k$, where k must be same as the vorticity of the rigid body rotation: this gives for the density of vortices the expression

$$n_v(\text{hydro}) = \frac{2\Omega}{2\pi k} = \frac{\Omega M_4}{\pi} . \quad (13.2.43)$$

The vortex core, where super fluid density vanishes according to the conventional theory, should have radius $\rho_0 \simeq 10^{-10} m$. Although the vortices as such are not visible there is indirect experimental evidence for the existence of the vortex like structures, in particular for the existence of vortex cores [B37] , [D14] possessing inner core radius of order $10^{-10} m$.

The generation of the vortices should begin at some critical angular velocity Ω (the circulation of the rigid body flow being of the order of the quantum of circulation at this value of Ω : this kind of effect has indeed been observed: the critical velocity is however smaller than the predicted one [D14] .

One can wonder what happens at the rotation velocities smaller than the critical one. Does super fluid flow like a rigid body or does it rotate at all? There is some experimental evidence supporting the view that super fluid does not rotate for sufficiently low rotation velocities so that the behavior is analogous to Meissner effect with Ω playing the role of the magnetic field.

b) Z^0 magnetic vortices

Consider now an alternative TGD inspired description of the situation. The problem is clearly created by the velocity circulation condition, which implies that supra flow is irrotational almost everywhere. In TGD approach the quantization condition however contains also the contribution of the Z^0 magnetic flux besides the velocity circulation so that there is no reason to require that velocity field has vanishing curl anymore! Assuming that super fluid flows as rigid body one can adjust B_Z so that the quantization condition is satisfied.

$$B_Z = \frac{2\Omega M_4}{g_Z Q_Z} . \quad (13.2.44)$$

The resulting field is rather weak as compared to the critical B_Z . Ω must be of the order of $10^7/s$ (ten orders of magnitude larger than the critical rotation velocity for the formation of vortices!) to guarantee that B_Z is equal to the critical B_Z . This suggests that B_Z vortices cannot appear at rotation velocities studied and that the generation of the velocity vortices is the correct solution of the problem.

There are also other counter arguments. First, since the required field is much smaller than the critical field it seems impossible to imbed this magnetic field into super phase (one should excite some topological field quanta to $n_1 \neq 0$ state). Secondly, the generation of the subcritical magnetic field is excluded by the Meissner effect. Thirdly, $\nabla^2 B_Z = 0 \neq B_Z/\lambda^2$ so that super phase would be destroyed if constant B_Z is generated. On the other hand, the solution has the nice feature that the rigid body rotation of the super fluid could be regarded as a direct experimental evidence for the existence of macroscopic Z^0 field.

One manner to escape these problems is to argue that B_Z is constant in average sense only and that the actual field is consists of a network of Z^0 magnetic flux quanta in rigid body motion. The requirement that the total flux over the cross section of the container is same as the flux of constant field gives for the density of magnetic flux quanta per unit area the expression

$$n_v(\text{magn}) = \frac{\Omega M_4}{\pi} . \quad (13.2.45)$$

The density is identical with that obtained for hydrodynamical vortices! This observation suggests the solution to the discrepancy and a more detailed mechanism for the destruction of superfluidity. Super fluidity is destroyed, when Z^0 magnetic field (created by rotating Z^0 charge density) at condensation level $n_1 > n_Z$ ($L(n_Z) \sim 10^{-6} m$) penetrates to the level n_Z in form of flux quanta with strength B_c^Z . The conservation of magnetic flux explains why the average field strength at the level n_Z is identical with the penetrating field strength at the level n_1 . Since Z^0 charge current of the previous level serves as source of Z^0 magnetic at level n one obtains as a byproduct an estimate for the value of $\epsilon_Z(n_Z)$ from the formula 13.2.38 for the critical Z^0 magnetic field strength giving $\sqrt{\epsilon_Z(n_Z)} \sim 10^{10}$ and $\epsilon_1 \sim 10^9 g_Z$ so that neutrino screening of Z^0 charge at level n_Z is rather effective.

Which of the mechanisms is correct or are both mechanisms at work? In order to answer this question one should verify experimentally whether the vortices observed in a rotating super fluid are really velocity vortices or Z^0 magnetic vortices or both. Since the critical velocity for the Z^0 magnetic vortices is smaller than for the hydrodynamical vortices, one might argue that at critical angular velocity Z^0 magnetic vortices appear and hydrodynamic vortices appear for larger angular velocities. Some indirect support for the TGD based scenario indeed exists. The study of the rotating 3He has demonstrated that the angular velocity Ω and ordinary magnetic field B play very similar physical role in the texture of the rotating 3He and that the texture of 3He is rather sensitive to both these parameters. In TGD picture one can replace Ω and B by B_Z and B and a rich structure of the quantized excitations is predicted.

13.2.6 Phase slippage

The so called phase slippage [D3] provides a mechanism for the dissipation in the case of superfluids. Also this phenomenon has natural interpretation in terms of the flux quantization. The conventional description of the phase slippage is in terms of angle like order parameter χ . For linear flow the order parameter behaves linearly as a function of the coordinate x in the direction of the flow

$$\chi(x) = kx, \quad (13.2.46)$$

where k can be interpreted as the momentum of the super fluid particle.

In the phase slippage the graph of $\chi(x)$ as a function of x is deformed so that χ jumps by an integer multiple of 2π at some point x_0 and stays linear for $x \leq x_0$ and for $x \geq x_0$. The value of k must however decrease for $x \geq x_0$ and this means that the momentum of the super fluid particle decreases and dissipation occurs. Since the discontinuity is multiple of 2π the graph can be replaced with a new one without any discontinuity and smoothed out so that the graph of χ is linear with new value of the momentum k . The change in the momentum k is quantized:

$$\Delta k = n \frac{2\pi}{L}, \quad (13.2.47)$$

where L is the length of the channel. The process corresponds physically to the propagation of the vortex generated at the wall of the channel across the channel under the action of Magnus and friction forces and the integer n associated with the vortex ($\chi = n\phi$) equals to the integer associated with the Δk .

The process has obvious geometric interpretation in TGD approach. The angles Ψ and Φ are the counterparts of the angle like order parameter χ and phase slippage corresponds to the propagation of a vortex ($r = 0$ at the axis of the vortex and $r = \infty$ at the surface of the vortex) through the channel. In general the vortex is characterized by two integers n_1 and n_2 . It has been already shown that the ordinary hydrodynamical dissipation and generation of turbulence might be understood in terms of the phase slippage process: the only difference

with respect to the super fluidity is that the integers n_i and frequencies ω_i are much larger now: ordinary hydrodynamical system is obtained from the super fluid in the limit of the large quantum numbers.

13.3 Models for the topological field quanta

In the sequel simple models for the electromagnetic and Z^0 gauge fields created by condensed matter are studied. The aim is to get some grasp on the physically reasonable values of the vacuum parameters appearing in the imbedding by using as experimental input the values of coherence length ξ and critical magnetic fields. Two kinds of imbeddings are studied.

- (a) Spherically symmetric, electrovac imbedding of Z^0 condensate levels $n \geq n_Z$) or ordinary electric field (condensate levels $n < n_Z$) created by matter serves as a simple model for the topological field quanta in the ordinary condensed phase.
- (b) Cylindrically symmetric field quantum serves as an idealization for the linear structures obtained by glueing spherically symmetric topological field quanta together using joining along boundaries operation and is interesting as a model for the core of various vortex like structures. Several imbeddings of this kind are constructed.
 - i) An imbedding of cylindrically symmetric em/Z_0 electric field for matter at rest is constructed assuming that matter density serves as the source of em/Z_0 electric field.
 - ii) By applying a boost in the direction of cylinder axis an imbedding of the em/Z_0 magnetic field associated with say super fluid flow is obtained.
 - iii) Allowing non-vanishing quantum numbers n_i an imbedding of a constant Z^0/m magnetic field in the direction of the cylinder axis is obtained. The requirement that the magnetic flux of this field is quantized in the standard manner, poses an additional condition on the vacuum parameters. One can construct ordinary magnetic fields in the length scales $n \geq n_Z$ as deformations of Z^0 electric field configuration. As a consequence of the construction procedure, the critical radius of all these imbeddings depends on the properties of the matter only.

The dependence of the critical radii on the vacuum quantum numbers is studied and estimates for the vacuum numbers of topological field quanta are deduced. Ordinary phase with $\omega_1 \sim m_0 \sim 10^{-4}m_{Pl}$ is shown to correspond to the large quantum number limit in the sense that the critical radii are macroscopic and therefore also magnetic flux m as well as the quantum numbers ω_i and n_i are very large. The imbedding of the magnetic field is obtained nonperturbatively in the sense that the change Δn_i needed to generate the magnetic field satisfies the condition $\Delta n_i/n_i \gg 1$.

Supra phases correspond to the small quantum number limit and to Z^0 neutral space-times: using ξ and B_c as inputs, it is found that the parameter ω_1 is of the order of $10^{2.5} - 10^3$ proton masses. The assumption that ω_1 is same for all super conductors implies $\omega_2/\omega_1 \ll 1$, which condition in turn is necessary condition for Meissner effect to take place. The value of the fractal quantum number m is assumed to be zero for 4He and -2 for the other supra phases. the non-vanishing value of m affects radically the value of ϵ_1 so that estimates have considerable uncertainties.

13.3.1 The Kähler field created by a constant mass density

In the following the em/Z^0 electric field created by an Z^0/em neutral, constant mass distribution assuming that mass distribution serves as a source of pure em/Z^0 field proportional to Kähler field, are studied. Although the mass distribution itself is homogeneous, Kähler electric field necessarily breaks translational symmetry. Concerning the applications in mind, the breaking of the translational symmetry to the spherical or cylindrical symmetry is the most natural one and will therefore be considered in the sequel. Also the imbedding of a spherically (cylindrically) symmetric Kähler electric field can break spherical (cylindrical symmetry) since several gauge potentials are possible by gauge invariance and different gauges are related by the canonical transformations of CP_2 and correspond to different four-surfaces: it is assumed however that

imbedding is spherically (cylindrically) symmetric, too. What makes the cylindrically symmetric field configuration so interesting is that one can construct several physically interesting field configurations from it by modifying the values of the vacuum quantum numbers so that electrovac conditions cease to hold true.

To begin with, recall the conditions guaranteing the vanishing of either Z^0 or electromagnetic gauge fields

$$\begin{aligned} r &= \tan(X) \ , \quad \Psi = k\Phi \ , \\ X &= \frac{\ln(|(u+k)/C|)\epsilon}{2} \ . \end{aligned} \tag{13.3.1}$$

One must chose the branch of arcus tangent in the expression of X in terms of r and this implies the condition $m\pi \leq X \leq (2m+1)\pi/2$, where m is an integer fixing the branch of the arcustangent and will be referred to as euantum number. The following remarks are useful for what follows:

- (a) The vanishing of the Z^0 field is achieved for

$$\epsilon = \epsilon(em) = \frac{1}{2} \ ,$$

and the vanishing of the electromagnetic field is achieved for

$$\epsilon = \epsilon(Z) = \frac{(3+p)}{(3+2p)} \ ,$$

($p = \sin^2(\theta_W) \simeq 0.234$).

- (b) The CP_2 projection of the imbedding is two-dimensional, which implies the orthogonality of the magnetic and electric fields belonging to same condensate level. Z^0/em field is proportional to induced Kähler form for the imbeddings in question

$$\begin{aligned} \gamma &= k_{em}J = a_{em}\sin^2 X du \wedge d\Phi \ , \\ k_{em} &= 3 \ , \quad a_{em} = -\frac{3}{4} \ , \\ Z^0 &= k_Z J = a_Z \sin^2 X du \wedge d\Phi \ , \\ k_Z &= \frac{6}{p} \ , \quad a_Z = -\frac{3}{3+p} \ . \end{aligned} \tag{13.3.2}$$

One consequence of $F_{em} = 3J$ is that the $\#$ throats feeding magnetic flux to/from a purely electromagnetic condensate level behave on given space-time sheet as magnetic monopoles with magnetic charge quantized in multiples of the magnetic charge associated with the ordinary Dirac monopole: what is peculiar is that the magnetic charge is divisible by 3. As quantum effects are considered the $\#$ throats behave as extremely tiny magnetic dipoles.

- (c) Electromagnetic/ Z^0 charge density of matter is assumed to serve as source of em/Z^0 fields and in the idealization that matter consists of identical nuclei (A, Z) one can write the charge density as

$$\begin{aligned} \rho_{em} &= \frac{e^2}{\sqrt{\epsilon_{em}}} \frac{Z}{A} N = K_{em} N \ , \\ \rho_Z &= -\frac{g_Z^2}{4\sqrt{\epsilon_Z}} \frac{A-Z}{A} N = K_Z N \ , \end{aligned} \tag{13.3.3}$$

where N is the density of the nucleons. It has been assumed that only neutrons contribute to the nuclear Z^0 charge.

The formulas associated with the spherically and cylindrically symmetric imbeddings differ from each other by numerical factors only and the cylindrically symmetric case will be considered first. Assuming cylindrical symmetry em/Z^0 electric field is radial and its magnitude is given by

$$\begin{aligned} |E_\rho^{em}| &= \delta K_{em} \frac{N\rho}{2} , \\ |E_\rho^Z| &= \delta K_Z \frac{N\rho}{2} , \\ \delta &= 1 , \end{aligned} \tag{13.3.4}$$

The numerical factor δ is introduced in order to generalize the results to spherically symmetric case easily.

Cylindrically symmetric imbedding of the em/Z^0 electric field is obtained through the ansatz

$$\begin{aligned} \Phi &= \omega_1 t , \quad \Psi = \omega_2 t , \quad u = u(\rho) , \\ k &= \frac{\omega_2}{\omega_1} . \end{aligned} \tag{13.3.5}$$

One can define $\omega_1 = m_p \sqrt{(\epsilon_i)x}$, where x is numerical factor not very far from unity in astrophysical scales. The dependence of u on ρ is fixed from the imbeddability condition for the appropriate electric field

$$\begin{aligned} \frac{a_i}{k_i} \sin^2 X \partial_\rho u \omega_1 &= \delta K_i N \frac{\rho}{2} , \\ i &= em, Z^0 . \end{aligned} \tag{13.3.6}$$

From this expression one can integrate u as a function of ρ

$$\int_{u_0}^u \sin^2(X(u)) du = \delta \frac{K_i k_i}{a_i \omega_1} N \rho^2 . \tag{13.3.7}$$

This equation determines the value of the critical radius of the imbedding as a function of u_0 , the value of u at $r = \infty$ surface provided $u = 0$ at $r = 0$ surface. Performing the integral, one obtains the condition

$$\begin{aligned} \rho_{cr} &= \sqrt{\frac{2a_i \omega_1}{\delta K_i k_i N}} \sqrt{2(u_0 + k) \exp(-m\pi/\epsilon(i)) X(\epsilon(i))} , \\ X(\epsilon) &= \sqrt{\frac{(2 + \epsilon^2) \exp(\pi/\epsilon) + \epsilon^2}{(1 + \epsilon^2)}} , \\ i &= em, Z^0 . \end{aligned} \tag{13.3.8}$$

Here u_0 is the value of $u = \cos(\Theta)$ at the axis of the vortex ($k = \omega_2/\omega_1$) and various parameters with index i are defined in the previous formulas.

The general orders of magnitude become clear, when one writes the formula in a numerical form by using the density $N_0 = 10^{30}/m^3$ is a reference density of atomic nuclei.

(a) In electromagnetic case one obtains

$$\begin{aligned}\rho_{cr} &\simeq X \cdot 3.7 \cdot 10^{-6} \text{ meters} , \\ X &= \sqrt{(u_0 + k)} \sqrt{\epsilon_{em} x} \sqrt{\frac{A N_0}{Z N} \frac{1}{\sqrt{\delta}}} 10^{-2.7288m} , \\ \omega_1 &= \sqrt{\epsilon_{em} x m} (\text{proton}) .\end{aligned}\tag{13.3.9}$$

The critical radius for spherically symmetric imbedding is obtained by replacing $\delta = 1$ with $\delta = 2/3$.

(b) In Z^0 case one obtains

$$\begin{aligned}\rho_{cr} &\simeq X \cdot 7.75 \cdot 10^{-7} \text{ meters} , \\ X &= \sqrt{(u_0 + k)} \sqrt{\epsilon_{Zx}} \sqrt{\frac{A N_0}{(A - Z) N} \frac{1}{\sqrt{\delta}}} 10^{-1.46m} , \\ \omega_1 &= \sqrt{\epsilon_{em} x m} (\text{proton}) .\end{aligned}\tag{13.3.10}$$

$$\text{for } p = \sin^2(\theta_W) = 1/4.$$

The previous formulas contain still unknown parameters $(u_0 + k, x)$ but order of magnitude estimates are possible for the critical radius since the value of $u_0 \leq 1$ is not expected to be anomalously small.

For the em neutral space-time there are two especially interesting special cases.

- (a) For $\sqrt{\epsilon_Z} \sim 10^{18}$ (so that Z^0 force is of the same order of magnitude as gravitational force) and for $m = 0$ critical radius is about $10^{11} m$, which is roughly the size of the solar system.
- (b) For $\sqrt{\epsilon_Z} \sim 10^{10}$ (level n_Z) and for $m = 0$ one has $\rho_{cr} \sim 10^3 m$ in typical condensed matter densities.

For Z^0 neutral space-time expected to be important in subcellular length scales $m = 0, x = 1$ and $\epsilon_{em} = 1$ (no charge screening by electrons) the critical radius is about 10^{-6} meters. If one assumes $\omega_1 = \epsilon_{em} m_e x$ (replacing $m(\text{proton})$ by m_e) with $x \sim 1$ one obtains critical radius of order $10^{-8} - 10^{-7}$ meters, which is of same order of magnitude as characteristic length parameters for super conductors. Same is achieved by assuming $m = -1$ instead of $m = 0$.

Critical radius depends exponentially on the value of the integer m and the imbeddings with different values of m are related by a discrete scale transformation $\rho_{cr} \rightarrow \exp(-m\pi/\epsilon)\rho_{cr}$: the "fundamental" change of scale is given $\exp(\pi/\epsilon) \simeq 28.9$ in the electromagnetically neutral case (note the dependence on $\sin^2(\theta_W)$) and by 535.5 in the Z^0 neutral case. Of course, it is not at all obvious whether the scaled up surfaces are structurally stable.

Using the BCS expression and TGD based estimate for the binding energy of the Cooper pairs, one obtains the formula

$$\rho_{cr} \simeq \frac{1}{\sqrt{m_e \Delta}} \exp\left(\frac{1}{N(0)V}\right) ,\tag{13.3.11}$$

which gives relationship between vacuum parameters and parameters of BCS model [D14] .

13.3.2 The imbedding of a constant magnetic field

The imbedding of constant em/Z^0 magnetic field is obtained from the corresponding electric field associated with the constant mass density assuming that Ψ and Φ depend also on the angle ϕ

$$\begin{aligned} \Phi &= \omega_1 t + n_1 \phi, & \Psi &= \omega_2 t + n_2 \phi, & u &= u(\rho), \\ k &= \frac{\omega_2}{\omega_1} = \frac{n_2}{n_1}. \end{aligned} \tag{13.3.12}$$

The condition $n_2/n_1 = k$ guarantees electromagnetic neutrality. Magnetic fields are in the direction of the z-axis and their magnitudes are given by the expression

$$\begin{aligned} |B_i| &= \left| \frac{n_1 E_i}{\omega_1 \rho} \right| = \frac{n_1 N}{\omega_1} \delta \frac{K_i}{2}, \\ i &= em, Z^0. \end{aligned} \tag{13.3.13}$$

and are indeed constant.

The magnetic flux associated with the topological field quantum is in the electromagnetic case given by

$$\Phi = \int B_{em} da = -n_1 \frac{3}{4} (u_0 + k) \exp(-4m\pi) \frac{(9\exp(2\pi) + 1)}{5} \pi. \tag{13.3.14}$$

The quantization of the magnetic flux gives a condition for the parameters u_0 and k . The requirement that the flux is quantized in multiples of the elementary flux quantum irrespective of the value of n_1 implies the condition

$$\begin{aligned} \frac{3}{4} (u_0 + k) \exp(-4m\pi) \frac{(9\exp(2\pi) + 1)}{5} &= \frac{1}{n}, \\ n &= 1. \end{aligned} \tag{13.3.15}$$

The more general condition $n > 1$ corresponds to the assumption that n_1 is multiple of n . Applying this condition to the expression for the critical radius, one has

$$\begin{aligned} \rho_{cr} &= \sqrt{\frac{A}{Z}} \sqrt{\epsilon_{em} x} \sqrt{\frac{2 m(\text{proton})}{e^2} \frac{1}{N} \frac{1}{\sqrt{n}}} \\ &\sim \sqrt{\frac{A}{Z}} \sqrt{\epsilon_{em} x} \frac{1}{\sqrt{n}} \cdot 1.6 \cdot 10^{-7} \text{ meters}, \\ B^{em} &= \frac{2n_1}{\rho_{cr}^2} = 2n_1 n \frac{Z}{A} \frac{e^2}{2\epsilon_{em} x} \frac{N}{m(\text{proton})}. \end{aligned} \tag{13.3.16}$$

The requirement that the radius of the flux quantum is of order $10^{-8} - 10^{-7}$ meters (magnetic penetration length for the super conductor) gives in $n = 1$ case the estimate $\sqrt{\epsilon_{em} x} \sim 1$ at

the condensation level in question. Since $\epsilon_{em} \geq 1$ holds true this means that $x < 1$ must hold true. An alternative possibility is that $n > 1$ holds true instead of $n = 1$. The third possibility is that the imbeddability condition gives only an upper bound for the critical radius and that stability conditions give additional constraints. An additional restriction for the values of the free parameters comes from the requirement that the critical magnetic field ought to be of the order of $B_{cr} \simeq 10^{-2}$ Tesla for the super conductors of type I and larger for the super conductors of type II. The critical magnetic field obviously corresponds to the smallest possible magnetic field allowed by the flux quantization and this estimate does not give anything new at order of magnitude level.

The quantization of the Z^0 magnetic flux gives

$$\begin{aligned} a_Z(u_0 + k) \exp(-2m\pi/\epsilon(Z)) C(\epsilon(Z)) &= \frac{1}{n} , \\ n &= 1 , \end{aligned} \quad (13.3.17)$$

and reduces the expression for the critical radius and magnetic field to the form

$$\begin{aligned} \rho_{cr} &= \sqrt{\frac{A}{(A-Z)}} \sqrt{\epsilon_Z x} \sqrt{\frac{8}{g_Z^2} \frac{m(\text{proton})}{N}} , \\ B^Z &= \frac{2n_1}{\rho_{cr}^2} \\ &= n_1 n \frac{(A-Z)}{A} \frac{g_Z^2}{4\epsilon_Z x} \frac{N}{m(\text{proton})} , \end{aligned} \quad (13.3.18)$$

completely analogous to the expressions deduced in the electromagnetic case.

In $n > n_Z$ case Z^0 magnetic fields are expected to dominate over the Z^0 electric fields: the reason is that the screening neutrinos probably do not contribute to the Z^0 gauge current density acting as the source of Z^0 magnetic field but contribute to Z^0 charge density causing a very effective screening. This means that the the source of Z^0 magnetic field at level n corresponds to the Z^0 charge density (and ϵ_Z) associated with level $n - 1$. In particular, at level n_Z there is no screening for Z^0 magnetic field. For $n > n_Z$ one can generate approximately constant ordinary magnetic fields by giving up the condition $n_2/n_1 = \omega_2/\omega_1$. The expression for the magnetic field strength is given by

$$\begin{aligned} |B^{em}| &= \frac{(3+p)(3+2p)}{6} B^Z \\ &= 2n_1 \frac{(3+p)(3+2p)}{6} \frac{(A-Z)}{A} \frac{g_Z^2}{8\epsilon_Z x} \frac{N}{m(\text{proton})} , \\ p &= \sin^2(\theta_W) , \end{aligned} \quad (13.3.19)$$

where the quantization condition for Z^0 flux is used (the least one can hope is that one might fix the orders of magnitudes correctly for free parameters). At the level $n = n_Z$ one can generate fields of order one Tesla (Tesla corresponds roughly to $N/m(\text{proton})$) at small quantum number limit ($\epsilon_Z(n_Z - 1) = 1$). At the next level the field of one Tesla requires $n_1 \sim 10^{20}$ for $\epsilon_Z x \sim 10^{20}$ so that large quantum number limit is in question.

13.3.3 Magnetic fields associated with constant velocity flows

One can construct a simple candidate for the Kähler magnetic field associated with a fluid flow with a constant velocity by boosting the cylindrically symmetric Kähler electric field in the direction of the cylinder axis:

$$\begin{aligned}\Phi &= \omega_1 t + k_1 z , & \Psi &= \omega_2 t + k_2 z , & u &= u(\rho) , \\ k_i &= \omega_i \beta .\end{aligned}\tag{13.3.20}$$

The field lines are circles around the z-axis and the strength of the Kähler magnetic and Z^0 magnetic fields are given by

$$\begin{aligned}|B_K| &= \left| \frac{k_1}{\omega_1} E_K \right| , \\ B_Z &= \frac{3}{\sin^2(\theta_W)} B^K .\end{aligned}\tag{13.3.21}$$

Super fluid flow is a natural application for this mechanism for generating magnetic field. In this case the cylindrical symmetry of the Kähler electric field is indeed very natural. Note that although the flux tubes are in the direction of the flow the critical radius doesn't depend on the flow velocity.

In order to obtain non-vanishing magnetic field (associated, say, with super conducting current) one must give up the condition that the field is obtained by a boost. For example, one can assume that $k_1 \neq \omega_1 \beta$. An interesting possibility is that the magnetic field associated with the super conducting current is obtained in this manner. It should be noticed that one can obtain also helical magnetic fields by performing boost to a configuration with non-vanishing magnetic field.

13.4 Quantum Hall effect from topological field quantization

The concept of the topological field quantum and the ideas about the formation of macroscopic quantum systems and about the topological description of the dissipation provide a classical TGD based description of Quantum Hall effect very similar to that found for supra phases.

13.4.1 The effect

Consider first briefly the effect. The effect is observed two-dimensional systems consisting of a conducting slab in a strong magnetic field perpendicular to the slab. When potential difference V is applied in the y-direction of the slab (see Fig. 13.4.1), the Lorentz force induces a transversal current. The current is proportional to the electric field associated with the potential:

$$j_x = \sigma_{xy} E_y ,\tag{13.4.1}$$

where σ_{xy} is the transversal conductivity.

Two kinds of effects have been observed at low temperatures ($T \simeq 1$ K) and using strong magnetic fields $B \simeq 10$ T.

(a) In integer quantum Hall effect σ_{xy} is quantized in units of the fine structure constant

$$\sigma_{xy} = n \times 2\alpha , \quad (13.4.2)$$

where n is integer.

(b) In the fractional quantum Hall effect σ_{xy} is quantized in fractional units

$$\sigma_{xy} = \frac{n}{m} \times 2\alpha , \quad (13.4.3)$$

where the integer m is fixed. Several values of m have been found to be possible.

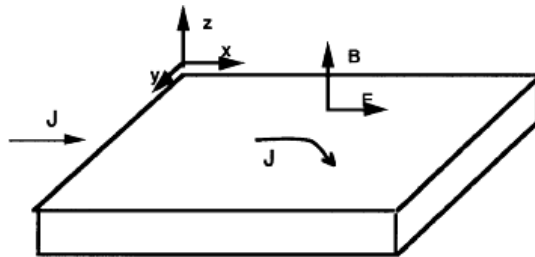

Figure 13.5: Quantum Hall effect

13.4.2 The model

One can understand Quantum Hall effect in TGD framework using the following arguments.

Conduction electrons as a mesoscopic quantum system

Assume that in the Quantum Hall phase conduction electrons form a mesoscopic quantum system, which means that topological field quanta with size of the order of $\xi \simeq 10^{-8} - 10^{-7}$ meters are glued together by join along boundaries bond to form a lattice like structure. The bonds must be stable since otherwise their splitting and rejoining causes an additional dissipation contributing to the transversal conductivity and Quantum Hall effect is lost. The estimate for the critical temperature $T_c \simeq 1/2m_e\xi^2$ used for the supra phases applies also now and correctly gives $T_c \simeq 1$ K.

How to avoid the splitting of the joining along boundaries bonds in a strong magnetic field

Since a strong magnetic field (of the order of few Tesla) is present, individual topological field quanta are excited to $(n_1, n_2) \neq 0$ states. There are *two* possible manners to avoid the breaking of the bonds between the neighbouring topological field quanta:

(a) The condition $n_1 = 0$ is satisfied for all topological field quanta. $n_1 = 0$ field quanta are favored if the condition

$$k \equiv \omega_2/\omega_1 \gg 1 , \quad (13.4.4)$$

is satisfied so that $n_2 = 0$ quanta have much larger magnetic flux than $n_1 = 0$ field quanta. If $k \gg 1$ condition is satisfied, the magnetic field inside the flux quantum can change in

discrete, but sufficiently small, steps, when external magnetic field is varied. For the values of the vacuum quantum numbers encountered for the supra phases, the value of n_2 ought to be rather large, of the order of 10 – 100 in Quantum Hall phase. A possible problem of this scenario is that the flux associated with the $n_1 = 1$ quantum is of same order as the flux of the external magnetic field: why this excitation is not generated?

The $k \ll 1$ condition encountered in the case of supra phases leads to difficulties. The magnetic field associated with $n_1 = 0$ excitations is large and of the order of the external magnetic field if same values for vacuum quantum numbers are assumed as for the supra phases so that external could excite these excitations. The problem is that the magnetic field associated with $n_1 \neq 0$ excitations is much smaller and its is difficult to understand why the variation of the external magnetic field does not not excite them (with the consequence that Quantum Hall phase disappears).

- (b) The condition $u = \cos(\Theta) = \pm 1$ is satisfied on the $r = \infty$ boundaries of the field quanta. In this case both n_1 and n_2 can vary freely. For the magnetic fields used and for the values of parameters found for supra phases n_1 should be of the order of $n_1 = 1$ and n_2 can have much larger values. This makes possible the variation of the magnetic flux inside the field quantum in discrete steps, the step being however reasonably small. Thus it seems that this alternative is the physical one.

Quantization conditions

Assume that the quantization conditions

$$\int \bar{B}_{em} \cdot d\bar{a} - m \oint \bar{v} \cdot d\bar{l} = \frac{m \times 2\pi}{qe} , \tag{13.4.5}$$

encountered in the case of the supra phases are satisfied in Quantum Hall phase, too. Since the magnetic flux inside the topological field quanta is quantized in multiples of certain basic unit associated with n_1 , which is much smaller than the standard flux quantum, the velocity field must adjust itself inside each flux quantum so that the quantization condition is satisfied. This is achieved if the velocity field is a super position of two terms

$$\bar{v} = \bar{v}_0 + \bar{v}_{rot} , \tag{13.4.6}$$

where \bar{v}_0 is essentially constant velocity field associated to the Hall current and \bar{v}_{rot} is a local velocity field inside the topological field quantum, whose function is to cancel the failure of the magnetic field to satisfy the standard flux quantization condition

$$m_e \oint \bar{v}_{rot} \cdot d\bar{l} = -\frac{m2\pi}{qe} + \int \bar{B}_{em} \cdot d\bar{a} \equiv - \int \Delta\bar{B} \cdot d\bar{a} . \tag{13.4.7}$$

Here \bar{v}_{rot} corresponds to a rigid body rotation in the constant magnetic field $\Delta\bar{B}$, which is the difference between the actual field and the field for which magnetic flux is quantized in standard units. Obviously, the external magnetic field must be so strong that the flux through a topological field quantum is of the order of the field quantum: otherwise unrealistically large local velocities are needed to guarantee quantization condition (or m would be equal to zero).

Carriers of the Hall current as an incompressible 2-dimensional liquid

Assume that the carriers of the Hall current behave like an incompressible, two-dimensional liquid (this assumption is made in the competing models, too [D5]). Assume also that the Euler equations are satisfied and write them into the following form

$$n_e m_e \frac{\partial \bar{v}}{\partial t} = -\nabla p - n_e m_e \nabla \left(\frac{v^2}{2} \right) + n_e m_e \bar{v} \times (\nabla \times \bar{v}) + n_e q e (\bar{E} + \bar{v} \times \bar{B}) . \quad (13.4.8)$$

Here n_e is the number of Hall current carriers per unit area orthogonal to the direction of magnetic field and m_e is the mass of the current carrier (electron).

Stationary state

The stationary situation for which the velocity can be decomposed in the manner already described is characterized by the conditions

$$\begin{aligned} \bar{v} &= \bar{v}_0 + \bar{v}_{rot} , \\ \frac{\partial \bar{v}}{\partial t} &= 0 , \\ \nabla [p + n_e m_e (\frac{v^2}{2} - \frac{v_{rot}^2}{2})] + X &= 0 , \\ X &\equiv n_e q e \bar{v}_{rot} \times \bar{B} . \end{aligned} \quad (13.4.9)$$

The remaining equation leads to the formula for transversal conductivity

$$n_e m_e \bar{v}_0 \times (\nabla \times \bar{v}_{rot}) + q e n_e \bar{E} + q e n_e \bar{v}_0 \times \bar{B} = 0 . \quad (13.4.10)$$

Before deriving the expression for the transversal conductivity it is useful to verify that the solution ansatz works. One can substitute to the quantity $X \equiv \bar{v}_{rot} \times \bar{B}$ the expression of \bar{v}_{rot} obtained from quantization condition (rigid body rotation) and one finds that this term is also expressible as a gradient: $X = a \nabla (B^2 \rho^2)$, where a is some numerical constant. This implies that second condition reduces to a condition of form

$$p + n_e m_e (\frac{v^2}{2} - \frac{v_{rot}^2}{2}) + n_e q e a B^2 \rho^2 = p_0 = \text{constant} . \quad (13.4.11)$$

This condition is a local condition referring to the properties of the flow inside the topological field quanta and is not essential for Quantum Hall effect.

Hall current

In order to obtain expression for the Hall current one can integrate the third condition involving Lorentz force over a transversal (orthogonal to B) surface area associated with one or more topological field quanta. One obtains the following expression for the Hall current $\bar{j}_H = qen_e\bar{v}_0$

$$\begin{aligned} j_H &= \sigma_{xy}E, \\ \sigma_{xy} &= -e \frac{\int n_e da}{\left(\int \bar{B} \cdot d\bar{a} - m_e \oint \bar{v} \cdot d\bar{l}\right)}. \end{aligned} \quad (13.4.12)$$

Same expression can be obtained also directly from the Euler equations under much milder assumptions by integrating the x - component of the equations over the surface area. All the terms in Euler equation and not appearing in the formula for the Hall current (∇v^2 , ∇v_{rot}^2 , ∇p , $\bar{v}_{rot} \times \bar{B}$) give vanishing contribution to the integral over the field quantum provided they correspond to the variations of the physical quantities, whose average vanishes in length scales larger than the size of the topological field quantum.

One can write this formula in a form exhibiting fractional Quantum Hall effect by noticing that the integral $\oint n_e da$ is just n_{free} , the number of the carriers of Hall current inside the topological field quantum (or the several of them) and is quantized! The general quantization condition in turn implies that the denominator is integer multiple of $2\pi/qe$. What one obtains is the following formula for the transversal conductivity

$$\sigma_{xy} = -\frac{n_{free}e^2}{m2\pi}. \quad (13.4.13)$$

One obtains integer quantum Hall effect for $m = 1$ and fractional quantum Hall effect for $m \geq 1$.

Comments

Some comments concerning the proposed scenario are in order.

- (a) For a macroscopic quantum system consisting of a very large number of the topological field quanta n_{free} and m are so large that the value of the conductivity is practically continuous without any further assumptions. If one however assumes that the values of m and the number of the free charge carriers are same for all topological field quanta then it is possible to realize the situation, where n_{free}/m can be written as a ratio of small integers.
- (b) All integer values for m (in accordance with the experimental facts!) are possible (not only odd integers as in case of the anyon super conductivity in its simplest version [D12]). m corresponds to the angular momentum of an electron rotating around the flux tube in accordance with the Laughlin's proposal for the state functions of charge carriers [D12]. Since $m = 1$ angular momentum is expected to be most probable in low temperatures and for low magnetic fields, fractional quantum Hall effect is expected to be more rare phenomenon than integer Hall effect.
- (c) When magnetic field is kept as constant and potential V is varied the number of the free charge carriers inside the flux quantum changes in discrete steps at some critical values of the potential so that plateaus of σ_{xy} result. When magnetic field is varied compensating, velocity fields inside the field quanta are generated in order to preserve the quantization condition. When magnetic field is suitable, a change in the vacuum quantum number n_2 and possibly n_1 takes place and the rotational velocity field \bar{v}_{rot} goes to zero. This doesn't lead to a change of the transversal conductivity in general. When total magnetic flux becomes sufficiently near to its quantized value also the integer m characterizing the flux quantum can change so that the fractional number characterizing quantum Hall effect changes. This kind of a transition can be regarded as a phase transition taking place in the whole specimen.

- (d) The proposed explanation differs from the more standard explanations in some respects.
- i) The concept of fractional filling fractions follows from the quantization conditions and from the concept of the topological field quantum.
 - ii) No reference is made to fractional statistics or to fractional electric charges.
 - iii) The situation $m = 0$ is particularly interesting physically. In this case the transversal Hall conductivity is formally infinite. The only reasonable solution of the Euler equation in this case seems to be that for which the velocity in the transversal direction vanishes so that Hall effect and magnetic field is effectively absent (!) and classically (probably not quantum mechanically) there is a continuous acceleration in the direction of the electric field. Clearly the slab behaves as a super conductor apart from the presence of \bar{v}_{rot} term in velocity.
 - iv) The standard models for the fractional Quantum Hall effect predict also super conductivity together with the breaking of CP invariance. In present case the presence of the classical Z^0 electric vacuum fields suggests small parity breaking. This effect takes however place in ordinary supra phases, too and possibly in all condensed matter systems.

13.5 TGD and condensed matter

In previous sections we have applied TGD to a rather exotic condensed matter phenomena. Quite contrary to the original expectations it has turned out that TGD might have applications to less exotic condensed matter phenomena, too. In fact, it seems that TGD might be applied to reformulate the description of conductors, di-electrics, and magnetism using topological concepts.

13.5.1 Electronic conductivity and topological field quantization

The standard Drude model for conductors [B38] starts from the equilibrium condition $dv/dt = v/\tau - eE/m_e = 0$ to derive the expression for the conductivity of a metal as $\sigma = Ne^2\tau/m_e$. τ is interpreted as the average time between two collisions and is obtained from the estimate $\tau \simeq a/v_{th}$, where a is the distance between atoms and v_{th} is thermal velocity. The estimate is by a factor $10^2 - 10^3$ too small at low temperatures and approaches the observed conductivity at high temperatures only. A correct order of magnitude estimate is obtained if a is replaced with the size $\xi \simeq 10^{-8} - 10^{-7}$ meters of topological field quantum in accordance with the idea that ordinary metal behaves as a super conductor at length scales smaller than ξ . The decrease of the conductivity at higher temperatures can be understood, too: the joining along boundaries bonds between atoms become more and more unstable as the temperature is increased.

13.5.2 Dielectrics and topological field quantization

Why do electrons then move freely in length scales smaller than ξ ? This can be understood by introducing a TGD based description of a dielectric to be discussed in more detail later. The point is that there are two condensation levels present. This means that the electric flux D (electric displacement) associated with a test charge divides into two parts. First part P (polarization) flows at the first level of the condensate (in particular along the bonds joining topological field quanta of atomic size). Second part E (electric field) flows at the background space-time, which corresponds to a larger space-time sheet. Since total electric flux is conserved, the fractions of electric flux sum up to one: $1/\varepsilon_1 + 1/\varepsilon_2 = 1$ ($D = E + P$), where the fractions are defined in terms of the dielectric constants ε_1 and ε_2 associated with the two levels of condensation. For an ideal conductor all electric flux runs to the larger space-time sheet and there are no electric fields at the first level of the condensate: electrons move freely! For an ideal di-electric all electric flux flows at the first level of condensation and strong electric fields are associated with the join along boundaries bonds.

13.5.3 Magnetism and topological field quantization

Same kind of argumentation should work in case of magnetism, too. The magnetic flux H created by a test current can be decomposed to two parts. The first part M (magnetization) flows through the first level of the condensate and second part B (magnetic field) flows through the larger space-time sheet. Again one can associate susceptibilities μ_1 and μ_2 ($\mu_1 + \mu_2 = 1$) to both levels of the condensate to describe the properties of a simple magnetic substance.

The mechanism underlying spontaneous magnetization is not very well understood [B37, B38], [D4] and an interesting question is whether the magnetic domains in the spontaneous magnetization could be understood using TGD based concepts. The quantization of the field strength for a flux quantum implies that macroscopic magnetization results if the magnetic fields of $n_1 \geq 0$ excitations associated with these flux quanta are oriented in parallel. From the known values of the magnetic fields in ferromagnets and from the sizes of the magnetized domains it is possible to estimate the values of ω_1 and the fractal quantum number m . The typical values of the magnetic fields are of the order of 10^{-2} Tesla and stable domains of magnetization are known to have size of the order of 10^{-8} meters. The fact that the orders of magnitude are same as for superconductors suggests that the sizes of the topological field quanta do not depend strongly on the properties of the condensed matter system.

In the phenomenological theory of the ferromagnetism the so called Weiss molecular field appears [B38]. If this field is present then the magnetic moments of individual electrons are oriented parallel and magnetization is essentially the density of the magnetic moments per volume: $M \propto N_e \mu_e$. The problem is that this field is very large, having magnitude of the order of 10^3 Tesla, which is about 10^5 times large than the actual magnetic field!

Standard explanation is that this field is only an effective field giving a short hand description of essentially quantum level phenomena (so called exchange interaction between electrons, which favors parallel spins for the electrons of the neighboring atoms). A possible TGD based classical explanation is that there is indeed magnetic field of this strength present. This field is present at the "zeroth" level of condensation that is inside the field quanta having atomic size (which are glued together by the join along boundaries bonds). Again the field strength is quantized and flux quantum is related by the scaling factor $(\xi_1/\xi_0)^2 \simeq 10^4 - 10^6$ to the magnetic field quantum at the first condensation level. The order of magnitude is indeed correct!

Chapter 1

Appendix

A-1 Basic properties of CP_2 and elementary facts about p-adic numbers

A-1.1 CP_2 as a manifold

CP_2 , the complex projective space of two complex dimensions, is obtained by identifying the points of complex 3-space C^3 under the projective equivalence

$$(z^1, z^2, z^3) \equiv \lambda(z^1, z^2, z^3) . \quad (\text{A-1.1})$$

Here λ is any non-zero complex number. Note that CP_2 can be also regarded as the coset space $SU(3)/U(2)$. The pair z^i/z^j for fixed j and $z^i \neq 0$ defines a complex coordinate chart for CP_2 . As j runs from 1 to 3 one obtains an atlas of three coordinate charts covering CP_2 , the charts being holomorphically related to each other (e.g. CP_2 is a complex manifold). The points $z^3 \neq 0$ form a subset of CP_2 homeomorphic to R^4 and the points with $z^3 = 0$ a set homeomorphic to S^2 . Therefore CP_2 is obtained by "adding the 2-sphere at infinity to R^4 ".

Besides the standard complex coordinates $\xi^i = z^i/z^3$, $i = 1, 2$ the coordinates of Eguchi and Freund [A62] will be used and their relation to the complex coordinates is given by

$$\begin{aligned} \xi^1 &= z + it , \\ \xi^2 &= x + iy . \end{aligned} \quad (\text{A-1.2})$$

These are related to the "spherical coordinates" via the equations

$$\begin{aligned} \xi^1 &= r \exp(i \frac{(\Psi + \Phi)}{2}) \cos(\frac{\Theta}{2}) , \\ \xi^2 &= r \exp(i \frac{(\Psi - \Phi)}{2}) \sin(\frac{\Theta}{2}) . \end{aligned} \quad (\text{A-1.3})$$

The ranges of the variables r, Θ, Φ, Ψ are $[0, \infty]$, $[0, \pi]$, $[0, 4\pi]$, $[0, 2\pi]$ respectively.

Considered as a real four-manifold CP_2 is compact and simply connected, with Euler number Euler number 3, Pontryagin number 3 and second $b = 1$.

A-1.2 Metric and Kähler structure of CP_2

In order to obtain a natural metric for CP_2 , observe that CP_2 can be thought of as a set of the orbits of the isometries $z^i \rightarrow \exp(i\alpha)z^i$ on the sphere S^5 : $\sum z^i \bar{z}^i = R^2$. The metric of CP_2 is obtained by projecting the metric of S^5 orthogonally to the orbits of the isometries. Therefore the distance between the points of CP_2 is that between the representative orbits on S^5 .

The line element has the following form in the complex coordinates

$$ds^2 = g_{a\bar{b}} d\xi^a d\bar{\xi}^b , \quad (\text{A-1.4})$$

where the Hermitian, in fact Kähler metric $g_{a\bar{b}}$ is defined by

$$g_{a\bar{b}} = R^2 \partial_a \partial_{\bar{b}} K , \quad (\text{A-1.5})$$

where the function K , Kähler function, is defined as

$$\begin{aligned} K &= \log(F) , \\ F &= 1 + r^2 . \end{aligned} \quad (\text{A-1.6})$$

The Kähler function for S^2 has the same form. It gives the S^2 metric $dzd\bar{z}/(1+r^2)^2$ related to its standard form in spherical coordinates by the coordinate transformation $(r, \phi) = (\tan(\theta/2), \phi)$.

The representation of the CP_2 metric is deducible from S^5 metric is obtained by putting the angle coordinate of a geodesic sphere constant in it and is given

$$\frac{ds^2}{R^2} = \frac{(dr^2 + r^2 \sigma_3^2)}{F^2} + \frac{r^2(\sigma_1^2 + \sigma_2^2)}{F} , \quad (\text{A-1.7})$$

where the quantities σ_i are defined as

$$\begin{aligned} r^2 \sigma_1 &= \text{Im}(\xi^1 d\xi^2 - \xi^2 d\xi^1) , \\ r^2 \sigma_2 &= -\text{Re}(\xi^1 d\xi^2 - \xi^2 d\xi^1) , \\ r^2 \sigma_3 &= -\text{Im}(\xi^1 d\bar{\xi}^1 + \xi^2 d\bar{\xi}^2) . \end{aligned} \quad (\text{A-1.8})$$

R denotes the radius of the geodesic circle of CP_2 . The vierbein forms, which satisfy the defining relation

$$s_{kl} = R^2 \sum_A e_k^A e_l^A , \quad (\text{A-1.9})$$

are given by

$$\begin{aligned} e^0 &= \frac{dr}{F} , & e^1 &= \frac{r\sigma_1}{\sqrt{F}} , \\ e^2 &= \frac{r\sigma_2}{\sqrt{F}} , & e^3 &= \frac{r\sigma_3}{F} . \end{aligned} \quad (\text{A-1.10})$$

The explicit representations of vierbein vectors are given by

$$\begin{aligned} e^0 &= \frac{dr}{F} , & e^1 &= \frac{r(\sin\Theta\cos\Psi d\Phi + \sin\Psi d\Theta)}{2\sqrt{F}} , \\ e^2 &= \frac{r(\sin\Theta\sin\Psi d\Phi - \cos\Psi d\Theta)}{2\sqrt{F}} , & e^3 &= \frac{r(d\Psi + \cos\Theta d\Phi)}{2F} . \end{aligned} \quad (\text{A-1.11})$$

The explicit representation of the line element is given by the expression

$$ds^2/R^2 = \frac{dr^2}{F^2} + \frac{r^2}{4F^2}(d\Psi + \cos\Theta d\Phi)^2 + \frac{r^2}{4F}(d\Theta^2 + \sin^2\Theta d\Phi^2) . \quad (\text{A-1.12})$$

The vierbein connection satisfying the defining relation

$$de^A = -V_B^A \wedge e^B , \quad (\text{A-1.13})$$

is given by

$$\begin{aligned} V_{01} &= -\frac{e^1}{r} , & V_{23} &= \frac{e^1}{r} , \\ V_{02} &= -\frac{e^2}{r} , & V_{31} &= \frac{e^2}{r} , \\ V_{03} &= (r - \frac{1}{r})e^3 , & V_{12} &= (2r + \frac{1}{r})e^3 . \end{aligned} \quad (\text{A-1.14})$$

The representation of the covariantly constant curvature tensor is given by

$$\begin{aligned} R_{01} &= e^0 \wedge e^1 - e^2 \wedge e^3 , & R_{23} &= e^0 \wedge e^1 - e^2 \wedge e^3 , \\ R_{02} &= e^0 \wedge e^2 - e^3 \wedge e^1 , & R_{31} &= -e^0 \wedge e^2 + e^3 \wedge e^1 , \\ R_{03} &= 4e^0 \wedge e^3 + 2e^1 \wedge e^2 , & R_{12} &= 2e^0 \wedge e^3 + 4e^1 \wedge e^2 . \end{aligned} \quad (\text{A-1.15})$$

Metric defines a real, covariantly constant, and therefore closed 2-form J

$$J = -ig_{a\bar{b}} d\xi^a d\bar{\xi}^b , \quad (\text{A-1.16})$$

the so called Kähler form. Kähler form J defines in CP_2 a symplectic structure because it satisfies the condition

$$J^k_r J^{rl} = -s^{kl} . \quad (\text{A-1.17})$$

The form J is integer valued and by its covariant constancy satisfies free Maxwell equations. Hence it can be regarded as a curvature form of a $U(1)$ gauge potential B carrying a magnetic charge of unit $1/2g$ (g denotes the gauge coupling). Locally one has therefore

$$J = dB , \quad (\text{A-1.18})$$

where B is the so called Kähler potential, which is not defined globally since J describes homological magnetic monopole.

It should be noticed that the magnetic flux of J through a 2-surface in CP_2 is proportional to its homology equivalence class, which is integer valued. The explicit representations of J and B are given by

$$\begin{aligned} B &= 2re^3 , \\ J &= 2(e^0 \wedge e^3 + e^1 \wedge e^2) = \frac{r}{F^2} dr \wedge (d\Psi + \cos\Theta d\Phi) + \frac{r^2}{2F} \sin\Theta d\Theta d\Phi . \end{aligned} \quad (\text{A-1.19})$$

The vierbein curvature form and Kähler form are covariantly constant and have in the complex coordinates only components of type (1,1).

Useful coordinates for CP_2 are the so called canonical coordinates in which Kähler potential and Kähler form have very simple expressions

$$\begin{aligned} B &= \sum_{k=1,2} P_k dQ_k , \\ J &= \sum_{k=1,2} dP_k \wedge dQ_k . \end{aligned} \quad (\text{A-1.20})$$

The relationship of the canonical coordinates to the "spherical" coordinates is given by the equations

$$\begin{aligned} P_1 &= -\frac{1}{1+r^2} , \\ P_2 &= \frac{r^2 \cos\Theta}{2(1+r^2)} , \\ Q_1 &= \Psi , \\ Q_2 &= \Phi . \end{aligned} \quad (\text{A-1.21})$$

A-1.3 Spinors in CP_2

CP_2 doesn't allow spinor structure in the conventional sense [A59]. However, the coupling of the spinors to a half odd multiple of the Kähler potential leads to a respectable spinor structure. Because the delicacies associated with the spinor structure of CP_2 play a fundamental role in TGD, the arguments of Hawking are repeated here.

To see how the space can fail to have an ordinary spinor structure consider the parallel transport of the vierbein in a simply connected space M . The parallel propagation around a closed curve with a base point x leads to a rotated vierbein at x : $e^A = R_B^A e^B$ and one can associate to each closed path an element of $SO(4)$.

Consider now a one-parameter family of closed curves $\gamma(v) : v \in (0, 1)$ with the same base point x and $\gamma(0)$ and $\gamma(1)$ trivial paths. Clearly these paths define a sphere S^2 in M and the element $R_B^A(v)$ defines a closed path in $SO(4)$. When the sphere S^2 is contractible to a point e.g., homologically trivial, the path in $SO(4)$ is also contractible to a point and therefore represents a trivial element of the homotopy group $\Pi_1(SO(4)) = Z_2$.

For a homologically nontrivial 2-surface S^2 the associated path in $SO(4)$ can be homotopically nontrivial and therefore corresponds to a nonclosed path in the covering group $\text{Spin}(4)$ (leading from the matrix 1 to -1 in the matrix representation). Assume this is the case.

Assume now that the space allows spinor structure. Then one can parallel propagate also spinors and by the above construction associate a closed path of $\text{Spin}(4)$ to the surface S^2 . Now, however this path corresponds to a lift of the corresponding $SO(4)$ path and cannot be closed. Thus one ends up with a contradiction.

From the preceding argument it is clear that one could compensate the non-allowed -1 -factor associated with the parallel transport of the spinor around the sphere S^2 by coupling it to a gauge potential in such a way that in the parallel transport the gauge potential introduces a compensating -1 -factor. For a $U(1)$ gauge potential this factor is given by the exponential $\exp(i2\Phi)$, where Φ is the magnetic flux through the surface. This factor has the value -1 provided the $U(1)$ potential carries half odd multiple of Dirac charge $1/2g$. In case of CP_2 the required gauge potential is half odd multiple of the Kähler potential B defined previously. In the case of $M^4 \times CP_2$ one can in addition couple the spinor components with different chiralities independently to an odd multiple of $B/2$.

A-1.4 Geodesic sub-manifolds of CP_2

Geodesic sub-manifolds are defined as sub-manifolds having common geodesic lines with the imbedding space. As a consequence the second fundamental form of the geodesic manifold vanishes, which means that the tangent vectors h_α^k (understood as vectors of H) are covariantly constant quantities with respect to the covariant derivative taking into account that the tangent vectors are vectors both with respect to H and X^4 .

In [A53] a general characterization of the geodesic sub-manifolds for an arbitrary symmetric space G/H is given. Geodesic sub-manifolds are in 1-1-correspondence with the so called Lie triple systems of the Lie-algebra g of the group G . The Lie triple system t is defined as a subspace of g characterized by the closedness property with respect to double commutation

$$[X, [Y, Z]] \in t \text{ for } X, Y, Z \in t . \tag{A-1.22}$$

$SU(3)$ allows, besides geodesic lines, two nonequivalent (not isometry related) geodesic spheres. This is understood by observing that $SU(3)$ allows two nonequivalent $SU(2)$ algebras corresponding to subgroups $SO(3)$ (orthogonal 3×3 matrices) and the usual isospin group $SU(2)$. By taking any subset of two generators from these algebras, one obtains a Lie triple system and by exponentiating this system, one obtains a 2-dimensional geodesic sub-manifold of CP_2 .

Standard representatives for the geodesic spheres of CP_2 are given by the equations

$$S_I^2 : \xi^1 = \bar{\xi}^2 \text{ or equivalently } (\Theta = \pi/2, \Psi = 0) ,$$

$$S_{II}^2 : \xi^1 = \xi^2 \text{ or equivalently } (\Theta = \pi/2, \Phi = 0) .$$

The non-equivalence of these sub-manifolds is clear from the fact that isometries act as holomorphic transformations in CP_2 . The vanishing of the second fundamental form is also easy to verify. The first geodesic manifold is homologically trivial: in fact, the induced Kähler form vanishes identically for S_I^2 . S_{II}^2 is homologically nontrivial and the flux of the Kähler form gives its homology equivalence class.

A-2 CP_2 geometry and standard model symmetries

A-2.1 Identification of the electro-weak couplings

The delicacies of the spinor structure of CP_2 make it a unique candidate for space S . First, the coupling of the spinors to the $U(1)$ gauge potential defined by the Kähler structure provides the

missing $U(1)$ factor in the gauge group. Secondly, it is possible to couple different H -chiralities independently to a half odd multiple of the Kähler potential. Thus the hopes of obtaining a correct spectrum for the electromagnetic charge are considerable. In the following it will be demonstrated that the couplings of the induced spinor connection are indeed those of the GWS model [B42] and in particular that the right handed neutrinos decouple completely from the electro-weak interactions.

To begin with, recall that the space H allows to define three different chiralities for spinors. Spinors with fixed H -chirality $e = \pm 1$, CP_2 -chirality l, r and M^4 -chirality L, R are defined by the condition

$$\begin{aligned}\Gamma\Psi &= e\Psi, \\ e &= \pm 1,\end{aligned}\tag{A-2.1}$$

where Γ denotes the matrix $\Gamma_9 = \gamma_5 \times \gamma_5$, $1 \times \gamma_5$ and $\gamma_5 \times 1$ respectively. Clearly, for a fixed H -chirality CP_2 - and M^4 -chiralities are correlated.

The spinors with H -chirality $e = \pm 1$ can be identified as quark and lepton like spinors respectively. The separate conservation of baryon and lepton numbers can be understood as a consequence of generalized chiral invariance if this identification is accepted. For the spinors with a definite H -chirality one can identify the vielbein group of CP_2 as the electro-weak group: $SO(4) = SU(2)_L \times SU(2)_R$.

The covariant derivatives are defined by the spinorial connection

$$A = V + \frac{B}{2}(n_+1_+ + n_-1_-).\tag{A-2.2}$$

Here V and B denote the projections of the vielbein and Kähler gauge potentials respectively and $1_{+(-)}$ projects to the spinor H -chirality $+(-)$. The integers n_{\pm} are odd from the requirement of a respectable spinor structure.

The explicit representation of the vielbein connection V and of B are given by the equations

$$\begin{aligned}V_{01} &= -\frac{e^1}{r}, & V_{23} &= \frac{e^1}{r}, \\ V_{02} &= -\frac{e^2}{r}, & V_{31} &= \frac{e^2}{r}, \\ V_{03} &= (r - \frac{1}{r})e^3, & V_{12} &= (2r + \frac{1}{r})e^3,\end{aligned}\tag{A-2.3}$$

and

$$B = 2re^3,\tag{A-2.4}$$

respectively. The explicit representation of the vielbein is not needed here.

Let us first show that the charged part of the spinor connection couples purely left handedly. Identifying Σ_3^0 and Σ_2^1 as the diagonal (neutral) Lie-algebra generators of $SO(4)$, one finds that the charged part of the spinor connection is given by

$$A_{ch} = 2V_{23}I_L^1 + 2V_{13}I_L^2,\tag{A-2.5}$$

where one have defined

$$\begin{aligned} I_L^1 &= \frac{(\Sigma_{01} - \Sigma_{23})}{2} , \\ I_L^2 &= \frac{(\Sigma_{02} - \Sigma_{13})}{2} . \end{aligned} \tag{A-2.6}$$

A_{ch} is clearly left handed so that one can perform the identification

$$W^\pm = \frac{2(e^1 \pm ie^2)}{r} , \tag{A-2.7}$$

where W^\pm denotes the charged intermediate vector boson.

Consider next the identification of the neutral gauge bosons γ and Z^0 as appropriate linear combinations of the two functionally independent quantities

$$\begin{aligned} X &= re^3 , \\ Y &= \frac{e^3}{r} , \end{aligned} \tag{A-2.8}$$

appearing in the neutral part of the spinor connection. We show first that the mere requirement that photon couples vectorially implies the basic coupling structure of the GWS model leaving only the value of Weinberg angle undetermined.

To begin with let us define

$$\begin{aligned} \bar{\gamma} &= aX + bY , \\ \bar{Z}^0 &= cX + dY , \end{aligned} \tag{A-2.9}$$

where the normalization condition

$$ad - bc = 1 ,$$

is satisfied. The physical fields γ and Z^0 are related to $\bar{\gamma}$ and \bar{Z}^0 by simple normalization factors.

Expressing the neutral part of the spinor connection in term of these fields one obtains

$$\begin{aligned} A_{nc} &= [(c + d)2\Sigma_{03} + (2d - c)2\Sigma_{12} + d(n_+1_+ + n_-1_-)]\bar{\gamma} \\ &+ [(a - b)2\Sigma_{03} + (a - 2b)2\Sigma_{12} - b(n_+1_+ + n_-1_-)]\bar{Z}^0 . \end{aligned} \tag{A-2.10}$$

Identifying Σ_{12} and $\Sigma_{03} = 1 \times \gamma_5 \Sigma_{12}$ as vectorial and axial Lie-algebra generators, respectively, the requirement that γ couples vectorially leads to the condition

$$c = -d . \tag{A-2.11}$$

Using this result plus previous equations, one obtains for the neutral part of the connection the expression

$$A_{nc} = \gamma Q_{em} + Z^0(I_L^3 - \sin^2\theta_W Q_{em}) . \quad (\text{A-2.12})$$

Here the electromagnetic charge Q_{em} and the weak isospin are defined by

$$\begin{aligned} Q_{em} &= \Sigma^{12} + \frac{(n_+1_+ + n_-1_-)}{6} , \\ I_L^3 &= \frac{(\Sigma^{12} - \Sigma^{03})}{2} . \end{aligned} \quad (\text{A-2.13})$$

The fields γ and Z^0 are defined via the relations

$$\begin{aligned} \gamma &= 6d\bar{\gamma} = \frac{6}{(a+b)}(aX + bY) , \\ Z^0 &= 4(a+b)\bar{Z}^0 = 4(X - Y) . \end{aligned} \quad (\text{A-2.14})$$

The value of the Weinberg angle is given by

$$\sin^2\theta_W = \frac{3b}{2(a+b)} , \quad (\text{A-2.15})$$

and is not fixed completely. Observe that right handed neutrinos decouple completely from the electro-weak interactions.

The determination of the value of Weinberg angle is a dynamical problem. The angle is completely fixed once the YM action is fixed by requiring that action contains no cross term of type γZ^0 . Pure symmetry non-broken electro-weak YM action leads to a definite value for the Weinberg angle. One can however add a symmetry breaking term proportional to Kähler action and this changes the value of the Weinberg angle.

To evaluate the value of the Weinberg angle one can express the neutral part F_{nc} of the induced gauge field as

$$F_{nc} = 2R_{03}\Sigma^{03} + 2R_{12}\Sigma^{12} + J(n_+1_+ + n_-1_-) , \quad (\text{A-2.16})$$

where one has

$$\begin{aligned} R_{03} &= 2(2e^0 \wedge e^3 + e^1 \wedge e^2) , \\ R_{12} &= 2(e^0 \wedge e^3 + 2e^1 \wedge e^2) , \\ J &= 2(e^0 \wedge e^3 + e^1 \wedge e^2) , \end{aligned} \quad (\text{A-2.17})$$

in terms of the fields γ and Z^0 (photon and Z - boson)

$$F_{nc} = \gamma Q_{em} + Z^0(I_L^3 - \sin^2\theta_W Q_{em}) . \quad (\text{A-2.18})$$

Evaluating the expressions above one obtains for γ and Z^0 the expressions

$$\begin{aligned}\gamma &= 3J - \sin^2\theta_W R_{03} , \\ Z^0 &= 2R_{03} .\end{aligned}\tag{A-2.19}$$

For the Kähler field one obtains

$$J = \frac{1}{3}(\gamma + \sin^2\theta_W Z^0) .\tag{A-2.20}$$

Expressing the neutral part of the symmetry broken YM action

$$\begin{aligned}L_{ew} &= L_{sym} + f J^{\alpha\beta} J_{\alpha\beta} , \\ L_{sym} &= \frac{1}{4g^2} \text{Tr}(F^{\alpha\beta} F_{\alpha\beta}) ,\end{aligned}\tag{A-2.21}$$

where the trace is taken in spinor representation, in terms of γ and Z^0 one obtains for the coefficient X of the γZ^0 cross term (this coefficient must vanish) the expression

$$\begin{aligned}X &= -\frac{K}{2g^2} + \frac{fp}{18} , \\ K &= \text{Tr} [Q_{em}(I_L^3 - \sin^2\theta_W Q_{em})] ,\end{aligned}\tag{A-2.22}$$

In the general case the value of the coefficient K is given by

$$K = \sum_i \left[-\frac{(18 + 2n_i^2)\sin^2\theta_W}{9} \right] ,\tag{A-2.23}$$

where the sum is over the spinor chiralities, which appear as elementary fermions and n_i is the integer describing the coupling of the spinor field to the Kähler potential. The cross term vanishes provided the value of the Weinberg angle is given by

$$\sin^2\theta_W = \frac{9 \sum_i 1}{(fg^2 + 2 \sum_i (18 + n_i^2))} .\tag{A-2.24}$$

In the scenario where both leptons and quarks are elementary fermions the value of the Weinberg angle is given by

$$\sin^2\theta_W = \frac{9}{\left(\frac{fg^2}{2} + 28\right)} .\tag{A-2.25}$$

The bare value of the Weinberg angle is $9/28$ in this scenario, which is quite close to the typical value $9/24$ of GUTs [B64] .

A-2.2 Discrete symmetries

The treatment of discrete symmetries C, P, and T is based on the following requirements:

- a) Symmetries must be realized as purely geometric transformations.
- b) Transformation properties of the field variables should be essentially the same as in the conventional quantum field theories [B20] .

The action of the reflection P on spinors of is given by

$$\Psi \rightarrow P\Psi = \gamma^0 \otimes \gamma^0 \Psi . \quad (\text{A-2.26})$$

in the representation of the gamma matrices for which γ^0 is diagonal. It should be noticed that W and Z^0 bosons break parity symmetry as they should since their charge matrices do not commute with the matrix of P .

The guess that a complex conjugation in CP_2 is associated with T transformation of the physicist turns out to be correct. One can verify by a direct calculation that pure Dirac action is invariant under T realized according to

$$\begin{aligned} m^k &\rightarrow T(M^k) , \\ \xi^k &\rightarrow \bar{\xi}^k , \\ \Psi &\rightarrow \gamma^1 \gamma^3 \otimes 1 \Psi . \end{aligned} \quad (\text{A-2.27})$$

The operation bearing closest resemblance to the ordinary charge conjugation corresponds geometrically to complex conjugation in CP_2 :

$$\begin{aligned} \xi^k &\rightarrow \bar{\xi}^k , \\ \Psi &\rightarrow \Psi^\dagger \gamma^2 \gamma^0 \otimes 1 . \end{aligned} \quad (\text{A-2.28})$$

As one might have expected symmetries CP and T are exact symmetries of the pure Dirac action.

A-3 Basic facts about induced gauge fields

Since the classical gauge fields are closely related in TGD framework, it is not possible to have space-time sheets carrying only single kind of gauge field. For instance, em fields are accompanied by Z^0 fields for extremals of Kähler action. Weak forces is however absent unless the space-time sheets contains topologically condensed exotic weakly charged particles responding to this force. Same applies to classical color forces. The fact that these long range fields are present forces to assume that there exists a hierarchy of scaled up variants of standard model physics identifiable in terms of dark matter.

Classical em fields are always accompanied by Z^0 field and some components of color gauge field. For extremals having homologically non-trivial sphere as a CP_2 projection em and Z^0 fields are the only non-vanishing electroweak gauge fields. For homologically trivial sphere only W fields are non-vanishing. Color rotations does not affect the situation.

For vacuum extremals all electro-weak gauge fields are in general non-vanishing although the net gauge field has $U(1)$ holonomy by 2-dimensionality of the CP_2 projection. Color gauge field has $U(1)$ holonomy for all space-time surfaces and quantum classical correspondence suggest a weak form of color confinement meaning that physical states correspond to color neutral members of color multiplets.

A-3.1 Induced gauge fields for space-times for which CP_2 projection is a geodesic sphere

If one requires that space-time surface is an extremal of Kähler action and has a 2-dimensional CP_2 projection, only vacuum extremals and space-time surfaces for which CP_2 projection is a geodesic sphere, are allowed. Homologically non-trivial geodesic sphere correspond to vanishing W fields and homologically non-trivial sphere to non-vanishing W fields but vanishing γ and Z^0 . This can be verified by explicit examples.

$r = \infty$ surface gives rise to a homologically non-trivial geodesic sphere for which e_0 and e_3 vanish imply the vanishing of W field. For space-time sheets for which CP_2 projection is $r = \infty$ homologically non-trivial geodesic sphere of CP_2 one has

$$\gamma = \left(\frac{3}{4} - \frac{\sin^2(\theta_W)}{2} \right) Z^0 \simeq \frac{5Z^0}{8} .$$

The induced W fields vanish in this case and they vanish also for all geodesic sphere obtained by $SU(3)$ rotation.

$Im(\xi^1) = Im(\xi^2) = 0$ corresponds to homologically trivial geodesic sphere. A more general representative is obtained by using for the phase angles of standard complex CP_2 coordinates constant values. In this case e^1 and e^3 vanish so that the induced em, Z^0 , and Kähler fields vanish but induced W fields are non-vanishing. This holds also for surfaces obtained by color rotation. Hence one can say that for non-vacuum extremals with 2-D CP_2 projection color rotations and weak symmetries commute.

A-3.2 Space-time surfaces with vanishing em, Z^0 , or Kähler fields

In the following the induced gauge fields are studied for general space-time surface without assuming the extremal property. In fact, extremal property reduces the study to the study of vacuum extremals and surfaces having geodesic sphere as a CP_2 projection and in this sense the following arguments are somewhat obsolete in their generality.

Space-times with vanishing em, Z^0 , or Kähler fields

The following considerations apply to a more general situation in which the homologically trivial geodesic sphere and extremal property are not assumed. It must be emphasized that this case is possible in TGD framework only for a vanishing Kähler field.

Using spherical coordinates (r, Θ, Ψ, Φ) for CP_2 , the expression of Kähler form reads as

$$\begin{aligned} J &= \frac{r}{F^2} dr \wedge (d\Psi + \cos(\Theta)d\Phi) + \frac{r^2}{2F} \sin(\Theta)d\Theta \wedge d\Phi , \\ F &= 1 + r^2 . \end{aligned} \tag{A-3.1}$$

The general expression of electromagnetic field reads as

$$\begin{aligned} F_{em} &= (3 + 2p) \frac{r}{F^2} dr \wedge (d\Psi + \cos(\Theta)d\Phi) + (3 + p) \frac{r^2}{2F} \sin(\Theta)d\Theta \wedge d\Phi , \\ p &= \sin^2(\Theta_W) , \end{aligned} \tag{A-3.2}$$

where Θ_W denotes Weinberg angle.

a) The vanishing of the electromagnetic fields is guaranteed, when the conditions

$$\begin{aligned} \Psi &= k\Phi , \\ (3+2p)\frac{1}{r^2 F}(d(r^2)/d\Theta)(k+\cos(\Theta)) + (3+p)\sin(\Theta) &= 0 , \end{aligned} \quad (\text{A-3.3})$$

hold true. The conditions imply that CP_2 projection of the electromagnetically neutral space-time is 2-dimensional. Solving the differential equation one obtains

$$\begin{aligned} r &= \sqrt{\frac{X}{1-X}} , \\ X &= D \left[\left| \frac{k+u}{C} \right| \right]^\epsilon , \\ u &\equiv \cos(\Theta) , \quad C = k + \cos(\Theta_0) , \quad D = \frac{r_0^2}{1+r_0^2} , \quad \epsilon = \frac{3+p}{3+2p} , \end{aligned} \quad (\text{A-3.4})$$

where C and D are integration constants. $0 \leq X \leq 1$ is required by the reality of r . $r = 0$ would correspond to $X = 0$ giving $u = -k$ achieved only for $|k| \leq 1$ and $r = \infty$ to $X = 1$ giving $|u+k| = [(1+r_0^2)/r_0^2]^{(3+2p)/(3+p)}$ achieved only for

$$\text{sign}(u+k) \times \left[\frac{1+r_0^2}{r_0^2} \right]^{\frac{3+2p}{3+p}} \leq k+1 ,$$

where $\text{sign}(x)$ denotes the sign of x .

The expressions for Kähler form and Z^0 field are given by

$$\begin{aligned} J &= -\frac{p}{3+2p} X du \wedge d\Phi , \\ Z^0 &= -\frac{6}{p} J . \end{aligned} \quad (\text{A-3.5})$$

The components of the electromagnetic field generated by varying vacuum parameters are proportional to the components of the Kähler field: in particular, the magnetic field is parallel to the Kähler magnetic field. The generation of a long range Z^0 vacuum field is a purely TGD based feature not encountered in the standard gauge theories.

b) The vanishing of Z^0 fields is achieved by the replacement of the parameter ϵ with $\epsilon = 1/2$ as becomes clear by considering the condition stating that Z^0 field vanishes identically. Also the relationship $F_{em} = 3J = -\frac{3}{4} \frac{r^2}{F} du \wedge d\Phi$ is useful.

c) The vanishing Kähler field corresponds to $\epsilon = 1, p = 0$ in the formula for em neutral space-times. In this case classical em and Z^0 fields are proportional to each other:

$$\begin{aligned} Z^0 &= 2e^0 \wedge e^3 = \frac{r}{F^2} (k+u) \frac{\partial r}{\partial u} du \wedge d\Phi = (k+u) du \wedge d\Phi , \\ r &= \sqrt{\frac{X}{1-X}} , \quad X = D|k+u| , \\ \gamma &= -\frac{p}{2} Z^0 . \end{aligned} \quad (\text{A-3.6})$$

For a vanishing value of Weinberg angle ($p = 0$) em field vanishes and only Z^0 field remains as a long range gauge field. Vacuum extremals for which long range Z^0 field vanishes but em field is non-vanishing are not possible.

The effective form of CP_2 metric for surfaces with 2-dimensional CP_2 projection

The effective form of the CP_2 metric for a space-time having vanishing em, Z^0 , or Kähler field is of practical value in the case of vacuum extremals and is given by

$$\begin{aligned} ds_{eff}^2 &= (s_{rr}(\frac{dr}{d\Theta})^2 + s_{\Theta\Theta})d\Theta^2 + (s_{\Phi\Phi} + 2ks_{\Phi\Psi})d\Phi^2 = \frac{R^2}{4}[s_{\Theta\Theta}^{eff}d\Theta^2 + s_{\Phi\Phi}^{eff}d\Phi^2] , \\ s_{\Theta\Theta}^{eff} &= X \times \left[\frac{\epsilon^2(1-u^2)}{(k+u)^2} \times \frac{1}{1-X} + 1 - X \right] , \\ s_{\Phi\Phi}^{eff} &= X \times [(1-X)(k+u)^2 + 1 - u^2] , \end{aligned} \quad (A-3.7)$$

and is useful in the construction of vacuum imbedding of, say Schwarchild metric.

Topological quantum numbers

Space-times for which either em, Z^0 , or Kähler field vanishes decompose into regions characterized by six vacuum parameters: two of these quantum numbers (ω_1 and ω_2) are frequency type parameters, two (k_1 and k_2) are wave vector like quantum numbers, two of the quantum numbers (n_1 and n_2) are integers. The parameters ω_i and n_i will be referred as electric and magnetic quantum numbers. The existence of these quantum numbers is not a feature of these solutions alone but represents a much more general phenomenon differentiating in a clear cut manner between TGD and Maxwell's electrodynamics.

The simplest manner to avoid surface Kähler charges and discontinuities or infinities in the derivatives of CP_2 coordinates on the common boundary of two neighboring regions with different vacuum quantum numbers is topological field quantization, 3-space decomposes into disjoint topological field quanta, 3-surfaces having outer boundaries with possibly macroscopic size.

Under rather general conditions the coordinates Ψ and Φ can be written in the form

$$\begin{aligned} \Psi &= \omega_2 m^0 + k_2 m^3 + n_2 \phi + \text{Fourier expansion} , \\ \Phi &= \omega_1 m^0 + k_1 m^3 + n_1 \phi + \text{Fourier expansion} . \end{aligned} \quad (A-3.8)$$

m^0, m^3 and ϕ denote the coordinate variables of the cylindrical M^4 coordinates) so that one has $k = \omega_2/\omega_1 = n_2/n_1 = k_2/k_1$. The regions of the space-time surface with given values of the vacuum parameters ω_i, k_i and n_i and m and C are bounded by the surfaces at which space-time surface becomes ill-defined, say by $r > 0$ or $r < \infty$ surfaces.

The space-time surface decomposes into regions characterized by different values of the vacuum parameters r_0 and Θ_0 . At $r = \infty$ surfaces n_2, ω_2 and m can change since all values of Ψ correspond to the same point of CP_2 : at $r = 0$ surfaces also n_1 and ω_1 can change since all values of Φ correspond to same point of CP_2 , too. If $r = 0$ or $r = \infty$ is not in the allowed range space-time surface develops a boundary.

This implies what might be called topological quantization since in general it is not possible to find a smooth global imbedding for, say a constant magnetic field. Although global imbedding exists it decomposes into regions with different values of the vacuum parameters and the coordinate u in general possesses discontinuous derivative at $r = 0$ and $r = \infty$ surfaces. A possible manner to avoid edges of space-time is to allow field quantization so that 3-space (and field) decomposes into disjoint quanta, which can be regarded as structurally stable units a 3-space (and of the gauge field). This doesn't exclude partial join along boundaries for neighboring field quanta provided some additional conditions guaranteeing the absence of edges are satisfied.

For instance, the vanishing of the electromagnetic fields implies that the condition

$$\Omega \equiv \frac{\omega_2}{n_2} - \frac{\omega_1}{n_1} = 0 \quad , \quad (\text{A-3.9})$$

is satisfied. In particular, the ratio ω_2/ω_1 is rational number for the electromagnetically neutral regions of space-time surface. The change of the parameter n_1 and n_2 (ω_1 and ω_2) in general generates magnetic field and therefore these integers will be referred to as magnetic (electric) quantum numbers.

A-4 p-Adic numbers and TGD

A-4.1 p-Adic number fields

p-Adic numbers (p is prime: 2,3,5,...) can be regarded as a completion of the rational numbers using a norm, which is different from the ordinary norm of real numbers [A41] . p-Adic numbers are representable as power expansion of the prime number p of form:

$$x = \sum_{k \geq k_0} x(k)p^k, \quad x(k) = 0, \dots, p-1 \quad . \quad (\text{A-4.1})$$

The norm of a p-adic number is given by

$$|x| = p^{-k_0(x)} \quad . \quad (\text{A-4.2})$$

Here $k_0(x)$ is the lowest power in the expansion of the p-adic number. The norm differs drastically from the norm of the ordinary real numbers since it depends on the lowest binary digit of the p-adic number only. Arbitrarily high powers in the expansion are possible since the norm of the p-adic number is finite also for numbers, which are infinite with respect to the ordinary norm. A convenient representation for p-adic numbers is in the form

$$x = p^{k_0} \varepsilon(x) \quad , \quad (\text{A-4.3})$$

where $\varepsilon(x) = k + \dots$ with $0 < k < p$, is p-adic number with unit norm and analogous to the phase factor $\exp(i\phi)$ of a complex number.

The distance function $d(x, y) = |x - y|_p$ defined by the p-adic norm possesses a very general property called ultra-metricity:

$$d(x, z) \leq \max\{d(x, y), d(y, z)\} \quad . \quad (\text{A-4.4})$$

The properties of the distance function make it possible to decompose R_p into a union of disjoint sets using the criterion that x and y belong to same class if the distance between x and y satisfies the condition

$$d(x, y) \leq D \quad . \quad (\text{A-4.5})$$

This division of the metric space into classes has following properties:

- a) Distances between the members of two different classes X and Y do not depend on the choice of points x and y inside classes. One can therefore speak about distance function between classes.
- b) Distances of points x and y inside single class are smaller than distances between different classes.
- c) Classes form a hierarchical tree.

Notice that the concept of the ultra-metricity emerged in physics from the models for spin glasses and is believed to have also applications in biology [B55] . The emergence of p-adic topology as the topology of the effective space-time would make ultra-metricity property basic feature of physics.

A-4.2 Canonical correspondence between p-adic and real numbers

The basic challenge encountered by p-adic physicist is how to map the predictions of the p-adic physics to real numbers. p-Adic probabilities provide a basic example in this respect. Identification via common rationals and canonical identification and its variants have turned out to play a key role in this respect.

Basic form of canonical identification

There exists a natural continuous map $I : R_p \rightarrow R_+$ from p-adic numbers to non-negative real numbers given by the "pinary" expansion of the real number for $x \in R$ and $y \in R_p$ this correspondence reads

$$\begin{aligned}
 y &= \sum_{k > N} y_k p^k \rightarrow x = \sum_{k < N} y_k p^{-k} , \\
 y_k &\in \{0, 1, \dots, p-1\} .
 \end{aligned}
 \tag{A-4.6}$$

This map is continuous as one easily finds out. There is however a little difficulty associated with the definition of the inverse map since the pinary expansion like also decimal expansion is not unique ($1 = 0.999\dots$) for the real numbers x , which allow pinary expansion with finite number of pinary digits

$$\begin{aligned}
 x &= \sum_{k=N_0}^N x_k p^{-k} , \\
 x &= \sum_{k=N_0}^{N-1} x_k p^{-k} + (x_N - 1)p^{-N} + (p-1)p^{-N-1} \sum_{k=0,\dots} p^{-k} .
 \end{aligned}
 \tag{A-4.7}$$

The p-adic images associated with these expansions are different

$$\begin{aligned}
 y_1 &= \sum_{k=N_0}^N x_k p^k , \\
 y_2 &= \sum_{k=N_0}^{N-1} x_k p^k + (x_N - 1)p^N + (p-1)p^{N+1} \sum_{k=0,\dots} p^k \\
 &= y_1 + (x_N - 1)p^N - p^{N+1} ,
 \end{aligned}
 \tag{A-4.8}$$

so that the inverse map is either two-valued for p-adic numbers having expansion with finite pinary digits or single valued and discontinuous and non-surjective if one makes pinary expansion unique by choosing the one with finite pinary digits. The finite pinary digit expansion is a natural choice since in the numerical work one always must use a pinary cutoff on the real axis.

The topology induced by canonical identification

The topology induced by the canonical identification in the set of positive real numbers differs from the ordinary topology. The difference is easily understood by interpreting the p-adic norm as a norm in the set of the real numbers. The norm is constant in each interval $[p^k, p^{k+1})$ (see Fig. A-4.2) and is equal to the usual real norm at the points $x = p^k$: the usual linear norm is replaced with a piecewise constant norm. This means that p-adic topology is coarser than the usual real topology and the higher the value of p is, the coarser the resulting topology is above a given length scale. This hierarchical ordering of the p-adic topologies will be a central feature as far as the proposed applications of the p-adic numbers are considered.

Ordinary continuity implies p-adic continuity since the norm induced from the p-adic topology is rougher than the ordinary norm. p-Adic continuity implies ordinary continuity from right as is clear already from the properties of the p-adic norm (the graph of the norm is indeed continuous from right). This feature is one clear signature of the p-adic topology.

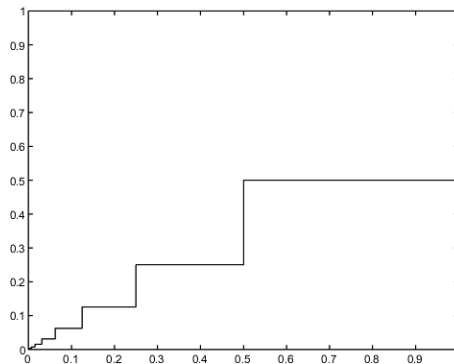

Figure 1: The real norm induced by canonical identification from 2-adic norm.

The linear structure of the p-adic numbers induces a corresponding structure in the set of the non-negative real numbers and p-adic linearity in general differs from the ordinary concept of linearity. For example, p-adic sum is equal to real sum only provided the summands have no common pinary digits. Furthermore, the condition $x +_p y < \max\{x, y\}$ holds in general for the p-adic sum of the real numbers. p-Adic multiplication is equivalent with the ordinary multiplication only provided that either of the members of the product is power of p . Moreover one has $x \times_p y < x \times y$ in general. The p-Adic negative -1_p associated with p-adic unit 1 is given by $(-1)_p = \sum_k (p - 1)p^k$ and defines p-adic negative for each real number x . An interesting possibility is that p-adic linearity might replace the ordinary linearity in some strongly nonlinear systems so these systems would look simple in the p-adic topology.

These results suggest that canonical identification is involved with some deeper mathematical structure. The following inequalities hold true:

$$\begin{aligned} (x + y)_R &\leq x_R + y_R \ , \\ |x|_p |y|_R &\leq (xy)_R \leq x_R y_R \ , \end{aligned} \tag{A-4.9}$$

where $|x|_p$ denotes p-adic norm. These inequalities can be generalized to the case of $(R_p)^n$ (a linear vector space over the p-adic numbers).

$$\begin{aligned} (x+y)_R &\leq x_R + y_R , \\ |\lambda|_p |y|_R \leq (\lambda y)_R &\leq \lambda_R y_R , \end{aligned} \tag{A-4.10}$$

where the norm of the vector $x \in T_p^n$ is defined in some manner. The case of Euclidian space suggests the definition

$$(x_R)^2 = \left(\sum_n x_n^2 \right)_R . \tag{A-4.11}$$

These inequalities resemble those satisfied by the vector norm. The only difference is the failure of linearity in the sense that the norm of a scaled vector is not obtained by scaling the norm of the original vector. Ordinary situation prevails only if the scaling corresponds to a power of p .

These observations suggests that the concept of a normed space or Banach space might have a generalization and physically the generalization might apply to the description of some non-linear systems. The nonlinearity would be concentrated in the nonlinear behavior of the norm under scaling.

Modified form of the canonical identification

The original form of the canonical identification is continuous but does not respect symmetries even approximately. This led to a search of variants which would do better in this respect. The modification of the canonical identification applying to rationals only and given by

$$I_Q(q = p^k \times \frac{r}{s}) = p^k \times \frac{I(r)}{I(s)} \tag{A-4.12}$$

is uniquely defined for rationals, maps rationals to rationals, has also a symmetry under exchange of target and domain. This map reduces to a direct identification of rationals for $0 \leq r < p$ and $0 \leq s < p$. It has turned out that it is this map which most naturally appears in the applications. The map is obviously continuous locally since p-adically small modifications of r and s mean small modifications of the real counterparts.

Canonical identification is in a key role in the successful predictions of the elementary particle masses. The predictions for the light elementary particle masses are within extreme accuracy same for I and I_Q but I_Q is theoretically preferred since the real probabilities obtained from p-adic ones by I_Q sum up to one in p-adic thermodynamics.

Generalization of number concept and notion of imbedding space

TGD forces an extension of number concept: roughly a fusion of reals and various p-adic number fields along common rationals is in question. This induces a similar fusion of real and p-adic imbedding spaces. Since finite p-adic numbers correspond always to non-negative reals n -dimensional space R^n must be covered by 2^n copies of the p-adic variant R_p^n of R^n each of which projects to a copy of R_+^n (four quadrants in the case of plane). The common points of p-adic and real imbedding spaces are rational points and most p-adic points are at real infinity.

For a given p-adic space-time sheet most points are literally infinite as real points and the projection to the real imbedding space consists of a discrete set of rational points: the interpretation in terms of the unavoidable discreteness of the physical representations of cognition is natural.

Purely local p-adic physics implies real p-adic fractality and thus long range correlations for the real space-time surfaces having enough common points with this projection.

p-Adic fractality means that M^4 projections for the rational points of space-time surface X^4 are related by a direct identification whereas CP_2 coordinates of X^4 at these points are related by I, I_Q or some of its variants implying long range correlates for CP_2 coordinates. Since only a discrete set of points are related in this manner, both real and p-adic field equations can be satisfied and there are no problems with symmetries. p-Adic effective topology is expected to be a good approximation only within some length scale range which means infrared and UV cutoffs. Also multi-p-fractality is possible.

REFERENCES

Mathematics

- [A1] Analytization trick. http://en.wikipedia.org/wiki/Analytization_trick.
- [A2] Atiyah-Singer index-theorem. http://en.wikipedia.org/wiki/Atiyah-Singer_index_theorem.
- [A3] Crystal structure. http://en.wikipedia.org/wiki/Crystal_structure.
- [A4] Einstein manifold. http://en.wikipedia.org/wiki/Einstein_manifold.
- [A5] Elliptic integral. <http://mathworld.wolfram.com/EllipticIntegral.html>.
- [A6] Elliptic integrals. http://en.wikipedia.org/wiki/http://en.wikipedia.org/wiki/Elliptic_integrals.
- [A7] Frobenius theorem (differential topology). [http://en.wikipedia.org/wiki/Frobenius_theorem_\(differential_topology\)](http://en.wikipedia.org/wiki/Frobenius_theorem_(differential_topology)).
- [A8] Fuschian group. http://en.wikipedia.org/wiki/Fuchsian_group.
- [A9] Gieseking manifold. http://en.wikipedia.org/wiki/Gieseking_manifold.
- [A10] Groupoid. <http://en.wikipedia.org/wiki/Groupoid>.
- [A11] Hyperbolic manifold. http://en.wikipedia.org/wiki/Hyperbolic_manifold.
- [A12] Hyperbolic manifold. http://en.wikipedia.org/wiki/hyperbolic_manifold.
- [A13] Infinite skew polyhedron. http://en.wikipedia.org/wiki/Infinite_skew_polyhedron.
- [A14] Kleinian group. http://en.wikipedia.org/wiki/Kleinian_group.
- [A15] Legendre form. http://en.wikipedia.org/wiki/http://en.wikipedia.org/wiki/Legendre_form.
- [A16] List of regular polytopes. http://en.wikipedia.org/wiki/List_of_regular_polytopes.
- [A17] Malcev algebra. http://en.wikipedia.org/wiki/Malcev_algebra.
- [A18] Möbius transformation. http://en.wikipedia.org/wiki/M%C3%B6bius_transformation.
- [A19] Modular group. http://en.wikipedia.org/wiki/Modular_group.

- [A20] Mostow Rigidity Theorem. http://en.wikipedia.org/wiki/Mostow_rigidity_theorem.
- [A21] Octonions. <http://en.wikipedia.org/wiki/Octonions>.
- [A22] Penrose tilings. http://en.wikipedia.org/wiki/Penrose_tilings.
- [A23] Pfaffian system. http://en.wikipedia.org/wiki/Pfaffian_system.
- [A24] Point group. http://en.wikipedia.org/wiki/Point_group.
- [A25] Quaternions. <http://en.wikipedia.org/wiki/Quaternion>.
- [A26] Ricci flow. http://en.wikipedia.org/wiki/Ricci_flow.
- [A27] Riemann-Hilbert problem. http://en.wikipedia.org/wiki/Riemann-Hilbert_problem.
- [A28] Schlfli symbol. http://en.wikipedia.org/wiki/Schlfli_symbol.
- [A29] SeifertWeber space. http://en.wikipedia.org/wiki/SeifertWeber_space.
- [A30] Seven-dimensional cross product. http://en.wikipedia.org/wiki/Seven-dimensional_cross_product.
- [A31] Space group. http://en.wikipedia.org/wiki/Space_group.
- [A32] Surface bundle over the circle. http://en.wikipedia.org/wiki/Surface_bundle_over_thecircle.
- [A33] The Riemann zeta function interpreted as partition function. <http://www.secamlocal.ex.ac.uk/people/staff/mrwatkin//zeta/physics2.htm>.
- [A34] Thurston's theorem. http://en.wikipedia.org/wiki/Thurston's_theorem.
- [A35] Thurston's theorem. http://en.wikipedia.org/wiki/Thurston's_geometrization_conjecture.
- [A36] Weeks manifold. http://en.wikipedia.org/wiki/Weeks_manifold.
- [A37] Weierstrass elliptic function. <http://mathworld.wolfram.com/WeierstrassEllipticFunction.html>.
- [A38] Weierstrass elliptic function. http://en.wikipedia.org/wiki/Weierstrass_elliptic_function.
- [A39] Yangian symmetry. <http://en.wikipedia.org/wiki/Yangian>.
- [A40] A. L. Besse. *Einstein Manifolds*. Springer Verlag, 1987.
- [A41] Z. I. Borevich and I. R. Shafarevich. *Number Theory*. Academic Press, 1966.
- [A42] A. Connes. Heart bit #1. <http://noncommutativegeometry.blogspot.com/2007/10/heart-bit-1.html>, 2007.
- [A43] A. Connes and D. Kreimer. *Hopf algebras, renormalization, and non-commutative geometry*, volume 1999. Kluwer, 1998.
- [A44] N. G. de Bruijn. Algebraic theory of Penrose's nonperiodic tilings of the plane. I, II. *Nederl. Akad. Wetensch. Indag. Math.*, 43(1):39,52,53–66, 1981.
- [A45] R. M. K. Dietl and J.-H. Eschenburg. Three-dimensional Penrose tilings and self-similarity.
- [A46] J. Dixmier. *Von Neumann Algebras*. North-Holland, Amsterdam, 1981.
- [A47] L. Effinger-Dean. Empire problem for Penrose tilings. <http://homes.cs.washington.edu/~effinger/files/empire.pdf>, 2006.
- [A48] Eisenhart. *Riemannian Geometry*. Princeton University Press, 1964.
- [A49] D. S. Freed. *The Geometry of Loop Groups*, 1985.
- [A50] C. N. Pope G. W. Gibbons. CP_2 as gravitational instanton. *Comm. Math. Phys.*, 55, 1977.
- [A51] M. Gunaydin. $N = 4$ superconformal algebras and gauges Wess-Zumino-Witten models. *Phys. Rev. D*, 47(8), 1993.

- [A52] W. Hawking, S. and N. Pope, C. Generalized Spin Structures in Quantum Gravity. *Phys. Lett.*, (1), 1978.
- [A53] S. Helgason. *Differential Geometry and Symmetric Spaces*. Academic Press, New York, 1962.
- [A54] F. R. Jones. *Braid groups, Hecke algebras and type II_1 factors*. 1983.
- [A55] V. Jones. In and around the origin of quantum groups. <http://arxiv.org/abs/math/0309199>, 2003.
- [A56] M. L. Lapidus. *In Search of the Riemann Zeros: Strings, Fractal Membrans and Non-commutative Spacetimes*. American Mathematical Society, 2008.
- [A57] B. Mandelbrot. *The Fractal Geometry of Nature*. Freeman, New York, 1977.
- [A58] J. Milnor. *Topology form Differential Point of View*. The University Press of Virginia, Virginia, 1965.
- [A59] N. Pope, C. Eigenfunctions and $Spin^c$ Structures on CP_2 , 1980.
- [A60] S. Sawin. Links, Quantum Groups, and TQFT's. <http://arxiv.org/abs/q-alg/9506002>, 1995.
- [A61] M. Spivak. *Differential Geometry I,II,III,IV*. Publish or Perish, Boston, 1970.
- [A62] J. Hanson T. Eguchi, B. Gilkey. *Phys. Rep.*, 66:1980, 1980.
- [A63] Terence Tao. 2006 ICM: Etienne Ghys, Knots and dynamics. <http://terrytao.wordpress.com/2007/08/03/2006-icm-etienne-ghys-knots-and-dynamics/>, 2007.
- [A64] N. H. V. Temperley and E. H. Lieb. Relations between the percolation and colouring problem and other graph-theoretical problems associated with regular planar lattices:some exact results for the percolation problem. *Proc. Roy. Soc. London*, 322(1971), 1971.
- [A65] R. Thom. *Commentarii Math. Helvet.*, 28, 1954.
- [A66] Wallace. *Differential Topology*. W. A. Benjamin, New York, 1968.
- [A67] E. Witten. Quantum field theory and the Jones polynomial. *Comm. Math. Phys.*, 121:351–399, 1989.
- [A68] E. C. Zeeman. *Catastrophe Theory*. Addison-Wessley Publishing Company, 1977.

Theoretical Physics

- [B1] Anti De Sitter space. http://en.wikipedia.org/wiki/Anti_de_Sitter_space.
- [B2] Baryogenesis. <http://en.wikipedia.org/wiki/Baryogenesis>.
- [B3] Black hole thermodynamics. http://en.wikipedia.org/wiki/Black_hole_thermodynamics.
- [B4] Blackhole information paradox. http://en.wikipedia.org/wiki/Black_hole_information_paradox.
- [B5] Chern-Simons theory. http://en.wikipedia.org/wiki/ChernSimons_theory.
- [B6] Chiral anomaly. http://en.wikipedia.org/wiki/Chiral_anomaly.
- [B7] De Sitter space. http://en.wikipedia.org/wiki/De_Sitter_space.
- [B8] Instanton. <http://en.wikipedia.org/wiki/Instanton>.
- [B9] Korteweg-de Vries equation. http://en.wikipedia.org/wiki/Kortewegde_Vries_equation.

- [B10] Lax pair. http://en.wikipedia.org/wiki/Lax_pair.
- [B11] Montonen Olive Duality. http://en.wikipedia.org/wiki/Montonen-Olive_duality.
- [B12] Non-linear Schrödinger equation. http://en.wikipedia.org/wiki/Non-linear_Schrödinger_equation.
- [B13] Rayleigh-Taylor instability. http://en.wikipedia.org/wiki/RayleighTaylor_instability.
- [B14] Rindler coordinates. http://en.wikipedia.org/wiki/Rindler_coordinates.
- [B15] Sine-Gordon equation. <http://en.wikipedia.org/wiki/Sine-Gordon>.
- [B16] Sphaleron. <http://en.wikipedia.org/wiki/Sphaleron>.
- [B17] Summary about spinors in different dimensions. <http://www.fis.puc.cl/~jalfaro/supergravity/III-Supergravity48-77.pdf>.
- [B18] Unruh effect. http://en.wikipedia.org/wiki/Unruh_effect.
- [B19] Israel Gelfand. <http://terrytao.wordpress.com/2009/10/07/israel-gelfand/#more-2860>, 2009.
- [B20] J. Björken and S. Drell. *Relativistic Quantum Fields*. Mc Graw-Hill, New York, 1965.
- [B21] O. I Bogoyavlenskij. Exact unsteady solutions to the Navier-Stokes equations and viscous MHD equations. *Phys. Lett. A*, pages 281–286, 2003.
- [B22] R. Bouzzo. Complementarity is not enough. <http://arxiv.org/abs/arXiv:1207.5192v2>.
- [B23] R. Bouzzo. Observer Complementarity Upholds the Equivalence Principle. <http://arxiv.org/abs/arXiv:1207.5192v1>.
- [B24] W. Broniowski. Two Hagedorn temperatures. <http://arxiv.org/abs/hep-ph/0006020>, 2002.
- [B25] R. T. Cahill. Gravity as Quantum Foam In-Flow. <http://arXiv.org/abs/physics/0307003>, 2003.
- [B26] R. E. Cutkosky. *J. Math. Phys.*, (1):429–433, 1960.
- [B27] P. Dorey. Exact S-matrices. <http://arxiv.org/abs/hep-th/9810026>, 1998.
- [B28] T. Ericson and J. Rafelski. The tale of the Hagedorn temperature. *Cern Courier*. <http://www.cerncourier.com/main/toc/43/7>, 43(7), 2002.
- [B29] L. C. B. Crispino et al. The Unruh effect and its applications. <http://arxiv.org/abs/0710.5373>.
- [B30] M. D’onofrio et al. The sphaleron rate at the electroweak crossover with 125 GeV Higgs mass. <http://arxiv.org/pdf/1212.3206v1.pdf>.
- [B31] Polchinsky et al. Black Holes: Complementarity or Firewalls? <http://arxiv.org/abs/1207.3123>.
- [B32] S. Davidson et al. Leptogenesis. <http://arxiv.org/pdf/0802.2962v3.pdf>.
- [B33] J. Etnyre and G. Ghrist. Generic hydrodynamic instability of curl eigen fields. <http://arxiv.org/abs/math/0306310>, 2003.
- [B34] M. H. Freedman. P/NP, and the quantum field computer. *Proc. Natl. Acad. Sci. USA*, 95(1), 1998.
- [B35] Prigogine I. Glandsdorff, P. *Thermodynamic Theory of Structure, Stability and Fluctuations*, volume 1991. Wiley, New York, 1991.
- [B36] H. Goldstein. *Classical Mechanics*. Addison Wesley, 1971.
- [B37] L. Goodstein, D. *States of Matter*. Prentice-Hall Inc., 1975.
- [B38] A. Guinier and R. Julien. *The Solid State: From Superconductors to Superalloys*. Oxford University Press, Oxford, 1987.
- [B39] M. Gurzwiller. Quantum Chaos. <http://www.secamlocal.ex.ac.uk/people/staff/mrwatkin/zeta/quantumchaos.html>, 1992.

- [B40] H. Haken. *Information and Self-Organization*. Springer Verlag, Berlin, 1988.
- [B41] S. Hossenfelder. Comments on and comments on comments on verlindes paper on the origin of gravity and the laws of newton. <http://www.scribd.com/doc/34724732/Verlinde-Gravity-From-Entropy-Explained-by-Sabine-Hossenfelder>, 2011.
- [B42] K. Huang. *Quarks, Leptons & Gauge Fields*. World Scientific, 1982.
- [B43] T. Jacobson. Thermodynamics of Spacetime: The Einstein Equation of State. <http://arxiv.org/abs/gr-qc/9504004>, 1995.
- [B44] H. S. Kenia. Introduction to sphalerons. http://hep.uchicago.edu/~mattlow/qft_papers/Kedia_Sphalerons.pdf.
- [B45] R. Kiehn. Hydrodynamics wakes and minimal surfaces with fractal boundaries. <http://www22.pair.com/csdc/pdf/barcelon.pdf>.
- [B46] R. Kiehn. Instability patterns, wakes and topological limit sets. <http://arxiv.org/pdf/physics/0102005.pdf>.
- [B47] R. Kiehn. Topological Torsion and Thermodynamic Irreversibility. <http://www22.pair.com/csdc/pdf/irevtors.pdf>, 2001.
- [B48] A. Kobakhidze. Gravity is not an entropic force. <http://arxiv.org/abs/1009.5414>, 2010.
- [B49] A. Lakthakia. *Beltrami Fields in Chiral Media*, volume 2. World Scientific, Singapore, 1994.
- [B50] E. M. Lifshitz and L. P. Pitaevski. *Relativistic Quantum Theory: Part 2*. Pergamon Press, 1974.
- [B51] G. E. Marsh. *Helicity and Electromagnetic Field Topology*. World Scientific, 1995.
- [B52] G. E. Marsh. *Helicity and Electromagnetic Field Topology*. World Scientific, 1995.
- [B53] D. Martin. Comments on Cahills quantum foam inflow theory of gravity. <http://arxiv.org/pdf/gr-qc/0407059v4>, 2004.
- [B54] P. Olesen. *Phys. Lett. B*, 160, 1985.
- [B55] G. Parisi. *Field Theory, Disorder and Simulations*. World Scientific, 1992.
- [B56] M. Pitkänen. On Verlinde's entropic gravity. *Prespacetime Journal*. <http://www.scribd.com/doc/45928480/PSTJ-V1-10-More-Possible-Games-in-Town-Continued>, 1(10):1582–1585, 2010.
- [B57] M. Polyakov, A. *Gauge Fields and Strings*. Harwood Academic Publishers, 1987.
- [B58] D. O'Connell R. Monteiro. The Kinematic Algebra From the Self-Dual Sector. <http://arxiv.org/abs/1105.2565>, 2011.
- [B59] A. Ringwald. Instantons/Sphalerons: Searching for New Physics with the Standard Model. <http://www.desy.de/~ringwald/talks/fridgerfest.pdf>.
- [B60] A. Riotto. Theories of baryogenesis. <http://arxiv.org/abs/hep-ph/9807454>.
- [B61] G. Shaffman, P. *Topics in Nonlinear Physics*. Springer Verlag, 1968.
- [B62] M. Stanisic, M. *The Mathematical Theory of Turbulence*. Springer Verlag, 1985.
- [B63] A. Verlinde. On the Origin of Gravity and the Laws of Newton. <http://arxiv.org/abs/1001.0785>, 2010.
- [B64] A. Zee. *The Unity of Forces in the Universe*. World Science Press, Singapore, 1982.

Particle and Nuclear Physics

- [C1] CMS observes a potentially new and interesting effect. <http://user.web.cern.ch/user/news/2010/100921.html>.
- [C2] ICARUS Proves Neutrinos More Than 10 Times Faster Than Light. http://www.science20.com/alpha_meme/icarus_proves_neutrinos_more_10_times_faster_light-83704.
- [C3] ICARUS Refutes Opera's Superluminal Neutrinos. http://www.science20.com/quantum_diaries_survivor/icarus_refutes_operas_superluminal_neutrinos-83684.
- [C4] LHC probably sees new shocking physics. <http://motls.blogspot.com/2010/09/lhc-probably-sees-new-shocking-physics.html>, 2010.
- [C5] MINOS. <http://en.wikipedia.org/wiki/MINOS>, 2011.
- [C6] OPERA fail to find error in Faster Than Light Measurement. <http://blog.vixra.org/2011/11/18/opera-fail-to-find-error-in-faster-than-light-measurement/>, 2011.
- [C7] S. L. Glashow A. G. Cohen. New Constraints on Neutrino Velocities. <http://arxiv.org/abs/1109.6562>, 2011.
- [C8] Alice Collaboration. Charged-particle multiplicity density at mid-rapidity in central Pb-Pb collisions at $\sqrt{s_{NN}} = 2.76$ TeV. <http://arxiv.org/abs/1011.3916>, 2010.
- [C9] CMS Collaboration. Observation of Long-Range, Near-Side Angular Correlations in Proton-Proton Collisions at the LHC. <http://cms.web.cern.ch/cms/News/2010/QCD-10-002/QCD-10-002.pdf>, 2010.
- [C10] ICARUS collaboration. A search for the analogue to Cherenkov radiation by high energy neutrinos at superluminal speeds in ICARUS. <http://arxiv.org/abs/1110.3763>, 2011.
- [C11] Icarus Collaboration. Measurement of the neutrino velocity with the ICARUS detector at the CNGS beam. <http://arxiv.org/pdf/1203.3433.pdf>, 2012.
- [C12] OPERA collaboration. Measurement of the neutrino velocity with the OPERA detector in the CNGS beam. <http://arxiv.org/abs/1109.4897>, 2011.
- [C13] A. Brandt et al. *Phys. Lett. B*, 297:417, 1992.
- [C14] A. M. Smith et al. *Phys. Lett. B*, 163:267, 1985.
- [C15] B. B. Back et al. *Phys. Rev. Lett.* <http://arxiv.org/abs/hep-ex/0208004>, 89(22), November 2002.
- [C16] B. B. Back et al. *Nucl. Phys. A*, 698:416, 2002.
- [C17] B. H. Behrens et al. *Phys. Rev.*, 80(1998):81, 1998.
- [C18] B. R. Barber et al. *Phys. Rev.*, 72(9):1380, 1994.
- [C19] D. T. H. Davies et al. Precise Charm to Strange Mass Ratio and Light Quark Masses from Full Lattice QCD. *Phys. Rev.* <http://prl.aps.org/abstract/PRL/v104/i13/e132003>, 104, 2010.
- [C20] F. M. Marquez et al. Ghost in the Atom. *New Scientist*, (2366):30], October 2003.
- [C21] J. Schweppe et al. *Phys. Rev.*, 51, 1983.
- [C22] M. Derrick et al. *Phys. Lett B*, 315:481, 1993.

- [C23] V. V. Nesvizhevsky et al. Measurement of quantum states of neutrons in the Earth's gravitational field. <http://arxiv.org/abs/hep-ph/0306198>, 2003.
- [C24] T. Ludham and L. McLerran. What Have We Learned From the Relativistic Heavy Ion Collider? *Physics Today*. <http://www.physicstoday.org/vol-56/iss-10/p48.html>, October 2003.
- [C25] K. McAlpine. Incredible shrinking proton raises eyebrows. <http://www.newscientist.com/article/dn19141-incredible-shrinking-proton-raises-eyebrows.html>, 2010.
- [C26] G. Violini N. M. Queen. *Dispersion Theory in High Energy Physics*. The Macmillan Press Limited, 1974.
- [C27] H. Nastase. The RHIC fireball as a dual black hole. <http://arxiv.org/abs/hep-th/0501068>, 2005.
- [C28] E. S. Reich. Black hole like phenomenon created by collider. *New Scientist*, 19(2491), 2005.
- [C29] E. Samuel. Ghost in the Atom. *New Scientist*, (2366):30, October 2002.
- [C30] F. Nesti Z. Bereziani. Magnetic anomaly in UCN trapping: signal for neutron oscillations to parallel world? *Eur. Phys. J. C*, 72(1974), 2012.

Condensed Matter Physics

- [D1] Linear elasticity. http://en.wikipedia.org/wiki/Linear_elasticity.
- [D2] Viscosity. <http://en.wikipedia.org/wiki/Viscosity>.
- [D3] W. Anderson, P. *Rev. Mod. Phys.*, 38, 1966.
- [D4] F. Brown, W. *Micromagnetics*. John Wiley, 1963.
- [D5] T. Chakrabarty and T. Pietiläinen. *The Fractional Quantum Hall Effect*. Springer Verlag, 1988.
- [D6] B. R. Barber et al. *Phys. Rev.*, 72(9):1380, 1994.
- [D7] C. Cao et al. Universal Quantum Viscosity in a Unitary Fermi Gas. <http://www.sciencemag.org/content/early/2010/12/08/science.1195219>, 2010.
- [D8] D. J. P. Morris et al. Dirac Strings and Magnetic Monopoles in Spin Ice Dy₂Ti₂O₇. *Physics World*, 326(5951):411–414, 2009.
- [D9] M. (ed.) Ginsberg, D. *Physical Properties of High Temperature Super Conductors Vol I*, volume II. 1989.
- [D10] S. L. Glashow. Can Science Save the World? http://www.hypothesis.it/nobel/nobel199/eng/pro/pro_2.htm, 1999.
- [D11] Novoselov et al K. S. Two-dimensional gas of massless Dirac fermions in graphene. *Nature*, 438, November 2005.
- [D12] R. Mackenzie and F. Wilczek. *Rev. Mod. Phys. A*, 3:2827, 1988.
- [D13] R. Mosseri and J.-F. Sadoc. In J. Sadoc, editor, *Geometry in Condensed Matter Physics*, pages 233–. World Scientific, 1990.
- [D14] R. Tilley, D. and K. Tilley. *Super Fluidity and Super Conductivity*. Adam Hilger Ltd, 1986.

- [D15] M. Widom. Discussion of phasons in quasicrystals and their dynamics. *Philosophical Magazine*. http://euler.phys.cmu.edu/widom/pubs/PDF/PhilMag88_2008_p2339.pdf, 88(13-15):2339–2350, 2008.

Cosmology and Astro-Physics

- [E1] Extragalactic Radio Sources and the WMAP Cold Spot. <http://arxiv.org/abs/astro-ph/0704.0908>.
- [E2] 90377 Sedna. http://en.wikipedia.org/wiki/90377_Sedna.
- [E3] A brief video demonstrating the basic idea of Michelson-Morley experiment. <http://www.youtube.com/watch?v=7T0d7o8X2-E>. See also <http://www.youtube.com/watch?v=VyePASErr5Q&NR=1>.
- [E4] A closely packed system of low-mass, low-density planets transiting Kepler-11. *Nature*. <http://www.nature.com/nature/journal/v470/n7332/full/nature09760.html>, 470.
- [E5] Allais effect. http://en.wikipedia.org/wiki/Allais_effect.
- [E6] Bullet Cluster. http://en.wikipedia.org/wiki/Bullet_cluster.
- [E7] Cartwheel galaxy. http://en.wikipedia.org/wiki/Cartwheel_galaxy.
- [E8] Cavendish experiment. http://en.wikipedia.org/wiki/Cavendish_experiment.
- [E9] Cold dark matter. http://en.wikipedia.org/wiki/Cold_dark_matter.
- [E10] Cosmic Ether-Drift and Dynamic Energy in Space. Bibliography and Resources. <http://www.orgonelab.org/energyinspace.htm>.
- [E11] Cosmic inflation. http://en.wikipedia.org/wiki/Cosmic_inflation.
- [E12] Cosmic Microwave Background. http://en.wikipedia.org/wiki/Microwave_background.
- [E13] Dark flow. http://en.wikipedia.org/wiki/Dark_flow.
- [E14] Dark matter mystery deepens. <http://www.sciencedaily.com/releases/2011/10/111017124344.htm#.Tp2qDPmlNE.email>.
- [E15] Equinoxes. <http://en.wikipedia.org/wiki/Equinox>.
- [E16] First Dark Galaxy Found. *New Scientist*, (2488), February.
- [E17] French Nobel Laureate turns back clock: Marshall's global experiment, von Braun memories evoked during August 11 solar eclipse. http://science.nasa.gov/newhome/headlines/ast12oct99_1.htm.
- [E18] Gamma ray burst. http://en.wikipedia.org/wiki/Gamma-ray_burst.
- [E19] Gravitational Waves. http://en.wikipedia.org/wiki/Gravitational_waves.
- [E20] Hulse-Taylor binary. http://en.wikipedia.org/wiki/Hulse-Taylor_binary.
- [E21] Kerr metric. http://en.wikipedia.org/wiki/Kerr_metric.
- [E22] Kilogram. <http://en.wikipedia.org/wiki/Kilogram>.
- [E23] Kuiper belt. http://en.wikipedia.org/wiki/Kuiper_belt.
- [E24] Λ -CDM model. http://en.wikipedia.org/wiki/Lambda-CDM_model.
- [E25] Mars. <http://en.wikipedia.org/wiki/Mars>.

- [E26] Masses and Orbital Characteristics of Extrasolar Planets using stellar masses derived from Hipparcos, metallicity, and stellar evolution. <http://exoplanets.org/almanacframe.html>.
- [E27] Michelson-Morley experiment. <http://en.wikipedia.org/wiki/Michelson-Morley>.
- [E28] Mysterious band of particles holds clues to Solar System's future. <http://www.cosmosmagazine.com/news/3251/mysterious-band-particles-holds-clues-solar-systems-future>.
- [E29] Nemesis. [http://en.wikipedia.org/wiki/Nemesis_\(hypothetical_star\)](http://en.wikipedia.org/wiki/Nemesis_(hypothetical_star)).
- [E30] Nutation. <http://en.wikipedia.org/wiki/Nutation>.
- [E31] Oort cloud. http://en.wikipedia.org/wiki/Oort_cloud.
- [E32] Polar-ring galaxies. http://en.wikipedia.org/wiki/Polar-ring_galaxies.
- [E33] Precession. <http://en.wikipedia.org/wiki/Precession>.
- [E34] Precession of equinoxes. http://en.wikipedia.org/wiki/Precession_of_equinoxes.
- [E35] Proxima Centauri. http://en.wikipedia.org/wiki/Proxima_Centauri.
- [E36] Quintessence. <http://en.wikipedia.org/wiki/Quintessence>.
- [E37] Relativistic jet. http://en.wikipedia.org/wiki/http://en.wikipedia.org/wiki/Relativistic_jet.
- [E38] Ring galaxy. http://en.wikipedia.org/wiki/Ring_galaxy.
- [E39] Rings of Jupiter. http://en.wikipedia.org/wiki/Jupiter's_rings.
- [E40] Rings of Saturn. http://en.wikipedia.org/wiki/Saturn's_rings.
- [E41] Sachs-Wolfe effect. http://en.wikipedia.org/wiki/Sachs-Wolfe_effect.
- [E42] Sagittarius flyaround movie. <http://www.astro.virginia.edu/~srm4n/Sgr/movie.html>.
- [E43] Saturn rings found clumpier, heavier than thought. http://www.world-science.net/othernews/070523_saturn.htm.
- [E44] Scalar-vector-tensor decomposition. http://en.wikipedia.org/wiki/Scalar-vector-tensor_decomposition.
- [E45] Search for gravitational waves from binary black hole inspiral, merger and ringdown. <http://arxiv.org/abs/1102.3781>.
- [E46] Solar data. <http://hyperphysics.phy-astr.gsu.edu/hbase/solar/soldata2.html>.
- [E47] Stellar kinematics. http://en.wikipedia.org/wiki/Moving_group.
- [E48] STEREO. <http://en.wikipedia.org/wiki/STEREO>.
- [E49] Sun's halo linked to dark matter particles. *New Scientist*, (2443):8, April.
- [E50] The bubble of our solar system. <http://saturn.jpl.nasa.gov/photos/imagetails/index.cfm?imageId=3700>.
- [E51] The Controversy over Newton's Gravitational Constant. <http://www.npl.washington.edu/eotwash/experiments/bigG/bigG.html>.
- [E52] The Solar Chemical Decomposition. <http://arxiv.org/abs/astro-ph/0410214>.
- [E53] Titius-Bode Law. http://en.wikipedia.org/wiki/Titius-Bode_Law.
- [E54] Video about. http://www.science20.com/news_releases/heliosphere_versus_heliopause_hot_solar_wind_meets_cold_interstellar_space.
- [E55] Voids. [http://en.wikipedia.org/wiki/Void_\(astronomy\)](http://en.wikipedia.org/wiki/Void_(astronomy)).
- [E56] Weak gravitational lensing. http://en.wikipedia.org/wiki/Weak_gravitational_lensing.
- [E57] *Science*, 279(5351):651, January 1998.
- [E58] Dark energy. *Physics World*. <http://physicsworld.com/cws/article/print/19419>, May 2004.

- [E59] $GM = tc^3$ Space-time as Possible Solution to Supernova and Other Problems. <http://riofriospacetime.blogspot.com/2006/09/recent-gmtc3-paper.html>, 2006.
- [E60] A new challenge to Einstein. <http://blogs.discovermagazine.com/cosmicvariance/2009/10/12/a-new-challenge-to-einstein>, 2009.
- [E61] Astrophysicists puzzle over planet that's too close to its sun. <http://www.latimes.com/news/nationworld/nation/la-sci-planet27-2009aug27,0,5882308.story>, 2009.
- [E62] Rachel Bean: GR is probably (98%) wrong. <http://motls.blogspot.com/2009/10/rachel-bean-gr-is-probably-98-wrong.html>, 2009.
- [E63] Dark Matter Theories Challenged By Satellite Galaxy Discovery. <http://www.space.com/15499-dark-matter-theory-galaxy-structures.html>, 2012.
- [E64] Fermi Observations of Dwarf Galaxies Provide New Insights on Dark Matter. http://www.nasa.gov/mission_pages/GLAST/news/dark-matter-insights.html, 2012.
- [E65] Serious Blow to Dark Matter Theories? New Study Finds Mysterious Lack of Dark Matter in Sun's Neighborhood. <http://www.sciencedaily.com/releases/2012/04/120418111923.htm#.T480kKMJmA.email>, 2012.
- [E66] F. Abbot, L. and So-Young Pi. *Inflationary Cosmology*. World Scientific, 1986.
- [E67] S. Akiyama and J. G. Wheeler. Magnetic Fields in Supernovae. <http://arxiv.org/abs/astro-ph/0211458>, 2002.
- [E68] M. Allais. Should the Laws of Gravitation Be Reconsidered: Part I,II,III? <http://home.t01.itscom.net/allais/blackprior/allais/lawgravit/lawgrav-one.pdf>, 1959.
- [E69] R. Anderson. Milky Way Has a "Squashed Beachball"-Shaped Dark Matter Halo. <http://www.universetoday.com/49619/milky-way-has-a-squashed-beachball-shaped-dark-matter-halo/>, 2009.
- [E70] J. Bahcall. Chemical Controversy at the Solar Surface. *Physics in Action*, 18(2), February 2005.
- [E71] S. Battersby. Big Bang glow hints at funnel-shaped Universe. *New Scientist*, April 2004.
- [E72] R. Bean. A weak lensing detection of a deviation from General Relativity on cosmic scales. <http://arxiv.org/abs/astro-ph/9506072>, 2009.
- [E73] C. Beck and M. C. Mackey. Has Dark Energy been Measured in Lab? <http://arxiv.org/abs/astro-ph/0406504>, 2004.
- [E74] J. Bekenstein. *Phys. Rev. D*, 25, 1982.
- [E75] W. J. G. De Blok. The core-cusp problem. <http://arxiv.org/pdf/0910.3538>, 2009.
- [E76] R. Bouchet, F. and P. Bennet, D. Preprint PUPT-89-1128, 1989.
- [E77] H. Brandenberger, R. and S. Shellard E., P. Angular momentum and mass function of galaxies seeded by cosmic strings. Preprint BROWN-HET -663, 1988.
- [E78] J. Silk M. Casse C. Boehm, D. Hooper. MeV Dark Matter: Has It Been Detected? *New Scientist*. <http://arxiv.org/abs/astro-ph/0309686>, October 2003.
- [E79] R. T. Cahill. Absolute Motion and Gravitational Effects. *Apeiron*. <http://redshift.vif.com/JournalFiles/V11N01PDF/V11N1CA2.pdf>, 11:53-111, 2004.
- [E80] R. T. Cahill. A New Light-Speed Anisotropy Experiment: Absolute Motion and Gravitational Waves Detected. *Progress in Physics*. <http://arxiv.org/abs/physics/0610076>, 25:73-92, 2006.
- [E81] R. T. Cahill. The Roland De Witte 1991 Experiment (to the Memory of Roland De Witte). *Progress in Physics*. <http://www.orgonelab.org/EtherDrift/CahillDeWitte2006.pdf>, 3:60-65, 2006.
- [E82] D. Chandler. MIT instrument finds surprises at solar system's edge. <http://web.mit.edu/newsoffice/2007/voyager-1210.html>.
- [E83] S. Chandrasekhar. *Hydrodynamic and Hydromagnetic Stability*. Oxford University Press, Oxford, 1961.

- [E84] T. Chiva and K. Kohri. Quintessence Cosmology and Varying α . <http://arxiv.org/abs/hep-ph/0111086>, 2001.
- [E85] M. Chown. Mystery of the disappearing minigalaxies. *New Scientist*. <http://space.newscientist.com/article/mg19826534.800-mystery-of-the-disappearing-minigalaxies.html>, (2653), April 2009.
- [E86] M. Chown. Our world may be a giant hologram. *New Scientist*. <http://www.newscientist.com/article/mg20126911.300-our-world-may-be-a-giant-hologram.html>, 2009, January 2009.
- [E87] Q. Chu, Y. and F. Zhu, X. *Astrophys. J.*, 271, 1983.
- [E88] S. Clark. Galaxy study hints at cracks in dark matter theories. *New Scientist*. <http://www.newscientist.com/article/dn17892-galaxy-study-hints-at-cracks-in-dark-matter-theories.html>, 2009.
- [E89] W. Coburn and S. E. Boggs. Polarization of Prompt gamma-ray emission from the gamma-ray burst of 6 December 2002. *Nature*. <http://arxiv.org/abs/astro-ph/0305377>, May 2003.
- [E90] N. Cohen. *Gravity's Lens. Views of the New Cosmology*. John Wiley, 1988.
- [E91] MAGIC collaboration. Probing Quantum Gravity using Photons from a Mkn 501 Flare observed in MAGIC. <http://arxiv.org/abs/0708.2889>, 2007.
- [E92] R. Courtland. Missing matter mystery in small galaxies. *New Scientist*. <http://www.newscientist.com/article/dn18362-missing-matter-mystery-in-small-galaxies.html>, January 2010.
- [E93] W. Cruttenden. Asymmetrical Shape of Heliosphere Raises Questions. <http://www.binaryresearchinstitute.org/bri/research/papers/voyager2.shtml>.
- [E94] W. Cruttenden. Earth orientation: does solar system motion matter? <http://www.binaryresearchinstitute.org/bri/images/solarsystemmotion/solarsystemmotion-large.jpg>.
- [E95] A. Gonzales D. Clowe and M. Markevitch. Weak lensing mass reconstruction of the interacting cluster 1E0657-558: Direct evidence for the existence of dark matter. <http://arxiv.org/astro-ph/0312273>, 2003.
- [E96] A. de Oliveira Costa et al. The significance of the largest scale CMB fluctuations in WMAP. <http://arxiv.org/abs/astro-ph/0307282>, 2003.
- [E97] N. Dume. New Exoplanet Defies Theory. *Physics Web*. <http://physicsweb.org/articles/news/9/7/6/1>, 2005.
- [E98] J. Durrant, C. *The Atmosphere of the Sun*. IOP Publishing Ltd., 1988.
- [E99] S. P. Maran (Editor). *The Astronomy and Astrophysics Encyclopedia*. van Nostrand Reinhold, New York, 1992.
- [E100] A. G. Riess et al. Type Ia Supernova Discoveries at $z > 1$ from the Hubble Space Telescope: Evidence for Past Deceleration and Constraints on Dark Energy Evolution. <http://arxiv.org/abs/astro-ph/0402512>, 2004.
- [E101] A. Hajian et al. On the apparent lack of power in the CMB anisotropy at large scales. <http://arxiv.org/abs/astro-ph/0702723>, 2003.
- [E102] Ackerman et al. A Cocoon of Freshly Accelerated Cosmic Rays Detected by Fermi in the Cygnus Superbubble. *Science*. <http://www.sciencemag.org/content/334/6059/1103.abstract>, 25:2203–2207, 2011.
- [E103] C. J. Copi et al. Multiple Vectors- a new representation of the CBM sky and evidence for statistical anisotropy or non-Gaussianity at $2 \leq l \leq 8$. <http://arxiv.org/abs/astro-ph/0310511>, 2004.
- [E104] C. J. Copi et al. The Uncorrelated Universe: Statistical Anisotropy and the Vanishing Angular Correlation Function in WMAP YEarS 1-3. <http://arxiv.org/abs/astro-ph/0605135>, 2004.

- [E105] C. L. Bennett et al. *Astrophys. J.* <http://arxiv.org/abs/astro-ph/0302207>, 148, 2003.
- [E106] C. L. Bennett et al. First Year Wilkinson Microwave Anisotropy Probe (WMAP1) Observations: Preliminary Maps and Basic Results. *Astrophys. J. Suppl.*, 148, 2003.
- [E107] D. Baskaran et al. Limits on the speed of gravitational waves from pulsar timing. <http://arxiv.org/pdf/0805.3103>, 2008.
- [E108] D. Carollo et al. Two stellar components in the halo of Milky Way. <http://www.nature.com/nature/journal/v450/n7172/index.html>, 2007.
- [E109] D. Clove et al. A direct empirical proof of the existence of dark matter. <http://arxiv.org/abs/astro-ph/0608407>, 2006.
- [E110] Einasto et al. *Nature*, 1997.
- [E111] H. Chand et al. *Astron. Astrophys.*, 417, 2004.
- [E112] H. K. Eriksen et al. Asymmetries in the CMB anisotropy field. <http://arxiv.org/abs/astro-ph/0307507>, 2003.
- [E113] I. Mihaila et al. A new confirmation of the Allais effect during the solar eclipse of 31 2003 May. <http://home.t01.itscom.net/allais/blackprior/mihaila/2003/mihaila2003.pdf>, 2003.
- [E114] J. Anderson et al. Anomalous Orbital-Energy Changes Observed during Spacecraft Flybys of Earth. *Phys. Rev.*, 100, 2008.
- [E115] J. D. Anderson et al. The energy Transfer Process in Planetary Flybys. <http://arxiv.org/abs/astro-ph/0608087>, 2006.
- [E116] J. Hjorth et al. A very energetic supernova associated with the gamma-ray burst of 29 March 2003. *Nature*, 423, 2003.
- [E117] J. K. Webb et al. Further Evidence for Cosmological Evolution of the Fine Structure Constant. <http://arxiv.org/abs/astro-ph/0012539>, 2001.
- [E118] J. K. Webb et al. Further Evidence for Cosmological Evolution of the Fine Structure Constant. *Phys. Rev.* arxiv.org/abs/astro-ph/0012539, 87(9), 2001.
- [E119] J. M. Pierce et al. *Nature*, 371, 1994.
- [E120] J.-P. Luminet et al. Dodecahedral Space Topology as an Explanation for Weak Wide Angle Correlations in the Cosmic Microwave Background. <http://arxiv.org/abs/astro-ph/0310253>, 2003.
- [E121] J. Tate et al. *Phys. Rev.*, 62(8), 1989.
- [E122] K. Zioutas et al. Quiet Sun X-rays as a Signature for New Particles. <http://arxiv.org/abs/astro-ph/0403176>, 2004.
- [E123] L. Wang et al. The Axially Symmetric Ejecta of Supernova 1987A. *Astrophys.* <http://arxiv.org/abs/astro-ph/0205337>, 579, 2002.
- [E124] M. J. Jee et al. Discovery of a ringlike dark matter structure in the core of the galaxy cluster C1 0024+17. <http://arxiv.org/abs/0705.2171>, 2007.
- [E125] M. Tajmar et al. Experimental Detection of Gravimagnetic London Moment. <http://arxiv.org/abs/gr-gc/0603033>, 2006.
- [E126] M. Tegmark et al. Cosmological Parameters from SDSS and WMAP. <http://arxiv.org/abs/astro-ph/0310723>, 2003.
- [E127] P. E. Freeman et al. Examining the Effect of the Map-making Algorithm on Observed Power Asymmetry in WMAP Data. *Astrophysical Journal*. <http://arxiv.org/abs/astro-ph/0510406>, 638, February 2006.
- [E128] P. Jacobsen et al. *Astrophysics Journal*, 369, 1993.
- [E129] Qian-Shen Wang et al. Precise measurement of gravity variations during a total solar eclipse. *Phys. Rev. D*. <http://home.t01.itscom.net/allais/blackprior/wang/wangetal.pdf>, 62, 2000.

- [E130] S. Perlmutter et al. Scheduled discoveries of 7+ high-redshift supernovae: First cosmology results and bounds on q_0 . <http://arxiv.org/abs/astro-ph/9602122>, 1996.
- [E131] S. Perlmutter et al. *Ap. J.*, 483, 1997.
- [E132] V. G. Gurzadyan et al. WMAP conforming the ellipticity in BOOMERanG and COBE CMB maps. <http://arxiv.org/abs/astro-ph/0402399>, 2004.
- [E133] W. Meikle et al. *Nature*, 329, 1987.
- [E134] C. W. F. Everitt. In *Results from Gravity Probe B*, 2007.
- [E135] M. Fall, S. and D. Lynden-Bell. *The Structure and Evolution of Normal Galaxies*. Cambridge University Press, Cambridge, 1981.
- [E136] Z. Fang, L. and H. Sato. Is the Periodicity in the Distribution of Quasar Red Shifts an Evidence of Multiple Connectedness of the Universe? *Gen. Rel. and Grav.*, (11), 1985.
- [E137] D. P. Finkbeiner. Microwave Interstellar Medium Emission Observed by the Wilkinson Microwave Anisotropy Probe. *Astrophysical Journal*. <http://www.journals.uchicago.edu/doi/abs/10.1086/423482>, 614:186–193, October 2004.
- [E138] D. A. Frail. Gamma-Ray Bursts: Jets and Energetics. <http://arxiv.org/abs/astro-ph/0311301>, 2003.
- [E139] W. L. et al Freedman. *Nature*, 371, 1994.
- [E140] H. Zhao G. Gentile, B. Famaey and P. Salucci. Universality of galactic surface densities within one dark halo scale-length. *Nature*. <http://www.nature.com/nature/journal/v461/n7264/>, 461:627, 2009.
- [E141] G. I. Rusu G. T. Jeverdan and V. Antonescu. Experiments using the Foucault pendulum during the solar eclipse of 15 February, 1961. *Biblical Astronomer*, 1(55), 1981.
- [E142] E. Gallagher, J. and M. Faber, S. *Astrophys.*, 17, 1979.
- [E143] A. S. Goldhaber and M. M. Nieto. Photon and Graviton Mass Limits. <http://arxiv.org/abs/0809.1003>, 2010.
- [E144] L. Grossmann. Cosmic ray factory observed in stellar superbubble. <http://www.newscientist.com/article/dn21210-cosmic-ray-factory-observed-in-stellar-superbubble.html>, 2011.
- [E145] M. Grusenick. Extended Michelson-Morley interferometer experiment. <http://www.youtube.com/watch?v=7T0d7o8X2-E>, 2009.
- [E146] V. G. Gurzadyan. Kolmogorov Complexity, Cosmic Background Radiation, and Irreversibility. <http://arxiv.org/abs/astro-ph/0312523>, 2003.
- [E147] V. G. Gurzadyan and A. A. Kocharyan. *Astronomy and Astrophysics*, B:19, 1992.
- [E148] H. Guth, A. *Phys. Rev. D*, 23, 1981.
- [E149] M. R. S Hawkins. On time dilation in quasar light curves. *Monthly Notices of the Royal Astronomical Society*. <http://www3.interscience.wiley.com/journal/123345710/abstract>, 405(3):1940–1946, 2010.
- [E150] C. J. Hogan. Measurement of Quantum Fluctuations in Geometry. <http://arxiv.org/abs/gr-gc/0712.3419>, 2008.
- [E151] P. O. Mazur I. Antoniadis and E. Mottola. Conformal Invariance and Cosmic Background Radiation. <http://arxiv.org/abs/astro-ph/9611208>, 1996.
- [E152] J. I. Katz. *High Energy Astrophysics*. Addison Wesley Publishing Company, 1987.
- [E153] T. W. B. Kibble. Cosmic strings reborn? <http://arxiv.org/abs/astro-ph/0410073>, 2004.
- [E154] W. B. Kibble, T. *Nucl. Phys. B*, 252, 1985.
- [E155] Y. B. Kolesnik. Applied Historical Astronomy, 24th meeting of the IAU. 2000.
- [E156] G. A. Krasinsky and V. A. Brumberg. Secular increase of astronomical unit from analysis of the major planets motions, and its interpretation. *Celest. Mech. & Dyn. Astron.*, 90, 2004.

- [E157] J.-P. Luminet. *Black Holes*. Cambridge University Press, Cambridge, 1992.
- [E158] J.-P. Luminet. A cosmic hall of mirrors. *Physics World*, September 2005.
- [E159] C.-P. Ma and E. Bertschinger. Cosmological Perturbation Theory in the Synchronous and Conformal Newtonian Gauges. <http://arxiv.org/abs/astro-ph/9506072>, 1995.
- [E160] C. J. Masreliez. Do the planets accelerate. <http://www.estfound.org>, 2001.
- [E161] C. J. Masreliez. Expanding Space-Time Theory. <http://www.estfound.org>, 2001.
- [E162] J. P. Mbelek. Special relativity may account for the space-craft flyby anomalies. <http://arxiv.org/ftp/arxiv/papers/0809/0809.1888.pdf>, 2008.
- [E163] Zeeya Merali. Dark Matter gets its own dark force. *New Scientist*, (2587), 2007.
- [E164] A. Middleditch. A White Dwarf Merger Paradigm for Supernovae and Gamma-Ray Bursts. <http://arxiv.org/abs/astro-ph/0311484>, 2003.
- [E165] D. Mihalas and J. Binney. *Galactic Astronomy: Structure and Kinematics*. Freeman & Company, 1981.
- [E166] M. Milgrom. A modification of the Newtonian dynamics as a possible alternative to the hidden mass hypothesis. <http://www.astro.umd.edu/~ssm/mond/astronow.html>, 1983.
- [E167] I. G Mitrofanov. <http://arxiv.org/abs/astro-ph/9707342>, 1997.
- [E168] M. Moshina. The surface ferrite layer of Sun. <http://www.thesurfaceofthesun.com/TheSurfaceOfTheSun.pdf>, 2005.
- [E169] G. D. Starkman N. J. Cornish, D. N. Spergel and E. Komatsu. Constraining the Topology of the Universe. <http://arxiv.org/abs/astro-ph/0310233>, 2003.
- [E170] C. Oesterwinter and C. J. Cohen. *Cel. Mech.*, 5, 1972.
- [E171] F. Steiner R. Aurich, S. Lustig and H. Then. Hyperbolic Universes with a Horned Topology and the CMB Anisotropy. *Class. Quant. Grav.*, 21, 2004.
- [E172] D. van Harlingen R. H. Koch and J. Clarke. *Phys. Rev. B*, 26, 1982.
- [E173] M. J. Reboucas and G. I. Gomero. Cosmic Topology: A Brief Overview. <http://arxiv.org/abs/astro-ph/04102324>, 2004.
- [E174] A. G. Riess. *PASP*, 112, 2000.
- [E175] D. Da Roacha and L. Nottale. Gravitational Structure Formation in Scale Relativity. <http://arxiv.org/abs/astro-ph/0310036>, 2003.
- [E176] A. Rubric and J. Rubric. The Quantization of the Solar-like Gravitational Systems. *Fizika B*, 7:1–13, 1998.
- [E177] A. De Rujula S. Dado, A. Dar. The Supernova associated with GRB030329. <http://arxiv.org/abs/astro-ph/0304106>, 2003.
- [E178] H.-H. Sanejouand. Empirical evidences in favor of a varying-speed-of-light. <http://arxiv.org/abs/0908.0249S>, 2009.
- [E179] C. Saslaw, W. *Gravitational Physics of Stellar and Galactic Systems*. Cambridge University Press, Cambridge, 1985.
- [E180] B. Schaefer. The hubble diagram to $z = 6.3$ with swift gamma ray bursts. <http://www.phys.lsu.edu/GRBHD/>, January 2006.
- [E181] B. Schwarzschild. The most recent balloon measurements on fluctuations in microwave background. *Physics Today*, July 2000.
- [E182] L. Teukolsky S. A. Shapiro, S. *Black Holes, White Dwarfs and Neutron Stars*. John Wiley, 1986.
- [E183] D. Shiga. Mysterious source of cosmic rays detected. <http://www.newscientist.com/article/dn10338-mysterious-source-of-cosmic-rays-detected.html>, 2006.
- [E184] V. Springel and G. Farrar. The speed of the 'bullet' in the merging galaxy cluster 1E0657-56. <http://arxiv.org/abs/astro-ph/0703232>, 2007.

- [E185] Sloan Digital Sky Survey. The Milky Way has Double Halo. <http://www.sdss.org/news/releases/20071212.dblhalo.html>, 2007.
- [E186] M. Tajmar and C. J. de Matos. Local Photon and Graviton Mass and Its Consequences. <http://arxiv.org/abs/gr-gc0603032>, 2006.
- [E187] William G. Tift. Discrete States Of Redshift And Galaxy Dynamics I. *Astrophysical Journal*, 206:38–56, May 1976.
- [E188] P. O. Ulianov. The Witte Effect: The Neutrino Speed and The Anisotropy of the Light Speed, as Defined in the General Theory of Relativity. <http://www.atomlig.com.br/poli/WitteEffect-IG.pdf>, 2011.
- [E189] D. Olenici V. A. Popescu. A confirmation of the Allais and Jeverdan-Rusu-Antonescu effects during the solar eclipse from 22 September 2006, and the quantization behavior of pendulum. <http://www.hessdalen.org/sse/program/Articol.pdf>, 2007.
- [E190] A. Vilenkin. *Cosmic Strings and Domain Walls*, volume 121. North-Holland, Amsterdam, 1985.
- [E191] L. Wang. Supernova Explosions: Lessons from Spectro-Polarimetry. <http://arxiv.org/abs/astro-ph/0311299>, 2003.
- [E192] Y. Wang and M. Tegmark. New Light on Dark Energy. *Physics Web*. <http://physicsweb.org/articles/news/8/6/14>, 2005.
- [E193] S. Weinberg. *Gravitation and Cosmology*. Wiley, New York, 1967.
- [E194] C. M. Will. Confrontation between General Relativity and Experiment. http://arxiv.org/PS_cache/gr-qc/pdf/0510/0510072v2.pdf, 2006.
- [E195] C. Allen X. Hernandez, M. A. Jimenez. The Breakdown of Classical Gravity? <http://arxiv.org/abs/1105.1873>, 2011.
- [E196] A. P. S. Yadav and B. D. Wandelt. Detection of primordial non-Gaussianity (f_{NL}) in the WMAP 3-years data at above 99.5 % confidence. <http://arxiv.org/abs/astro-ph/0712.1148>, 2008.
- [E197] B. Einasto J. Zeldovich, Ya. and F. Shandarin, S. Giant Voids in the Universe. *Nature*, 300, 1982.
- [E198] H. Zirin. *Astrophysics of the Sun*. Cambridge University Press, Cambridge, 1988.
- [E199] L. Zyga. Discovery that quasars don't show time dilation mystifies astronomers. <http://www.physorg.com/news190027752.html>, 2010.

Physics of Earth

- [F1] A challenge to all geologists of Earth. <http://www.nealadams.com/challenge.html>.
- [F2] Continental drift. http://en.wikipedia.org/wiki/Continental_drift.
- [F3] Cryogenian. <http://en.wikipedia.org/wiki/Cryogenian>.
- [F4] Ediacaran. <http://en.wikipedia.org/wiki/Ediacaran>.
- [F5] Expanding Earth Theory. http://en.wikipedia.org/wiki/Expanding_earth_theory.
- [F6] Geomagnetic reversal. http://en.wikipedia.org/wiki/Geomagnetic_reversal.
- [F7] Glacial. <http://en.wikipedia.org/wiki/Glacial>.
- [F8] Glaciation. <http://en.wikipedia.org/wiki/Glaciation>.

- [F9] Ice age. http://en.wikipedia.org/wiki/Ice_age.
- [F10] Late precambrian supercontinent and ice house world. <http://scotese.com/precamb.htm>.
- [F11] Magnetic field intensity. http://www.geo.physics.helsinki.fi/english/eng_magnetic.html.
- [F12] Magnetostratigraphy. <http://en.wikipedia.org/wiki/Magnetostratigraphy>.
- [F13] Mesozoic. <http://en.wikipedia.org/wiki/Mesozoic>.
- [F14] Mirovia. <http://en.wikipedia.org/wiki/Mirovia>.
- [F15] Neoproterozoic. <http://en.wikipedia.org/wiki/Neoproterozoic>.
- [F16] Oceanic trench. http://en.wikipedia.org/wiki/Oceanic_trench.
- [F17] Orogenies. <http://en.wikipedia.org/wiki/Orogenies>.
- [F18] Orogeny. <http://en.wikipedia.org/wiki/Orogeny>.
- [F19] Paleomagnetism. <http://en.wikipedia.org/wiki/Paleomagnetism>.
- [F20] Pangea. <http://en.wikipedia.org/wiki/Pangea>.
- [F21] Pannotia. <http://en.wikipedia.org/wiki/Pannotia>.
- [F22] Panthalassic. http://en.wikipedia.org/wiki/Panthalassic_Ocean.
- [F23] Plate tectonics. http://en.wikipedia.org/wiki/Plate_tectonics.
- [F24] Rift. <http://en.wikipedia.org/wiki/Rift>.
- [F25] Roberto Mantovani. http://en.wikipedia.org/wiki/Roberto_Mantovani.
- [F26] Rodinia. <http://en.wikipedia.org/wiki/Rodinia>.
- [F27] Snowball Earth. http://en.wikipedia.org/wiki/Snowball_earth.
- [F28] Supercontinent cycle. http://en.wikipedia.org/wiki/Supercontinent_cycle.
- [F29] The Cryogenian Period. <http://www.palaeos.com/Proterozoic/Neoproterozoic/Cryogenian/Cryogenian.html>.
- [F30] Tides. <http://en.wikipedia.org/wiki/Tides>.
- [F31] Tillite. <http://en.wikipedia.org/wiki/Tillite>.
- [F32] Tonian. <http://en.wikipedia.org/wiki/Tonian>.
- [F33] Volcano. <http://en.wikipedia.org/wiki/Volcano>.
- [F34] Quakes reveal 'core within a core'. *Nature*. <http://news.bbc.co.uk/1/hi/sci/tech/2290551.stm>, October 2002.
- [F35] Neil Adams. Conspiracy of Science, Earth is in fact growing. <http://www.youtube.com/watch?v=VjgidAICoQI>, 2006.
- [F36] T. Eerola. "A tropical paradise"? Neoproterozoic glaciations from the southern Brazilian perspective. 2002.
- [F37] M. J. Fairchild, I. J.; Kennedy. Neoproterozoic glaciations in the Earth System. *Journal of the Geological Society*, 164:895–921, 2007.
- [F38] A.J. Halverson G.P. Schrag D.P. Hoffman, P.F.; Kaufman. A Neoproterozoic Snowball Earth. *Science*. http://www.snowballearth.org/pdf/Hoffman_Science1998.pdf, 281:1342, 1998.
- [F39] J.L. Kirschvink. When All of the Oceans Were Frozen. *Recherche*, 355:26–30, 2002.
- [F40] N. Januszczak N. Eyles. "Zipper-rift": A tectonic model for Neoproterozoic glaciations during the breakup of Rodinia after 750 Ma. *Earth-Science Reviews*. http://www.sciencedirect.com/science?_ob=ArticleURL&_udi=B6V62-4B723V6-1&_user=10&_rdoc=1&_fmt=&_orig=search&_sort=d&view=c&_acct=C000050221&_version=1&_urlVersion=0&_userid=10&md5=757070dcaa8d8b501170dfde579d792f, 65:1–73, 2004.

- [F41] J. Salminen. Paleomagnetic and rock magnetic study with emphasis on the Precambrian intrusions and impact structures in Fennoscandia and South Africa. <https://oa.doria.fi/handle/10024/44628>, 2009.

Fringe Physics

- [H1] Closer Toward High-yield Fusion Reactor: Revolutionary Circuit Fires Thousands Of Times Without Flaw. *Science Daily*.
- [H2] P. T. Pappas A. Obolensky. Thirty six seconds faster than light. *Electronics and Wireless World*. <http://wbabin.net/historical/pappas.pdf>, 1988.
- [H3] J. A. Burke. The physics of crop formations. *MUFON Journal*. <http://www.blresearch.com/published.html>, pages 3–7, October 1998.
- [H4] OPERA Collaboration. Measurement of the neutrino velocity with the OPERA detector in the CNOS beam. <http://arxiv.org/abs/1109.4897>, 2011.
- [H5] S. Giani. On velocities beyond the speed of light c . <http://arxiv.org/abs/hep-ph/9712265>, 1998.
- [H6] D. Hudson. Mono-atomic elements. <http://www.halexandria.org/dward479.htm>, 2003.
- [H7] E. Podkletnov and G. Modanese. Investigation of high voltage discharges in low pressure gases through large ceramic super-conducting electrodes. <http://xxx.lanl.gov/abs/physics/0209051>, 2002.
- [H8] E. Podkletnov and R. Nieminen. Weak gravitational shielding properties of composite bulk YBa₂Cu₃O_{7-x} super-conductor below 70 K under electro-magnetic field. <http://arxiv.org/abs/cond-mat/9701074>, 1992.
- [H9] V. V Roshchin and S.M. Godin. An Experimental Investigation of the Physical Effects in a Dynamic Magnetic System. *New Energy Technologies*, 1, 2001.
- [H10] A. M. Selvam. Quantum-like Chaos in Prime Number Distribution and in Turbulent Fluid Flows. <http://arxiv.org/abs/physics/0005067>, 2000.

Biology

- [I1] Cambrian explosion. http://en.wikipedia.org/wiki/Cambrian_explosion.
- [I2] Dinosaurs. <http://en.wikipedia.org/wiki/Dinosaur>.
- [I3] Marine biology. http://en.wikipedia.org/wiki/Marine_biology#Deep_sea_and_trenches.
- [I4] Permian-Triassic extinction event. http://en.wikipedia.org/wiki/Permian-Triassic_extinction_event.

- [I5] S. Barley. Antarctica was climate refuge during great extinction. *New Scientist*. <http://www.newscientist.com/article/dn18231-antarctica-was-climate-refuge-during-great-extinction.html>, 2009.
- [I6] S. Comorosan. On a possible biological spectroscopy. *Bull. of Math. Biol.*, page 419, 1975.
- [I7] L. Montagnier et al. DNA waves and water. <http://arxiv.org/abs/1012.5166>, 2010.
- [I8] P. Gariaev et al. *The DNA-wave biocomputer*, volume 10. CHAOS, 2001.
- [I9] P. P. Gariaev et al. The spectroscopy of bio-photons in non-local genetic regulation. *Journal of Non-Locality and Remote Mental Interactions*. <http://www.emergentmind.org/gariaevI3.htm>, (3), 2002.
- [I10] S. J. Gould. *Wonderful Life*. Penguin Books, 1991.
- [I11] S. Ferris J.-L. Montagnier L. Montagnier, J. Aissa and C. Lavall'e. Electromagnetic Signals Are Produced by Aqueous Nanostructures Derived from Bacterial DNA Sequences. *Interdiscip. Sci. Comput. Life Sci.* <http://www.springerlink.com/content/0557v31188m3766x/>, 2009.
- [I12] J. O'Donoghue. How trees changed the world? *New Scientist*. <http://www.newscientist.com/channel/life/mg19626311.500-how-trees-changed-the-world.html>, 2631, November 2007.
- [I13] A.V. Tovmash P. P. Gariaev, G. G. Tertishni. Experimental investigation in vitro of holographic mapping and holographic transposition of DNA in conjunction with the information pool encircling DNA. *New Medical Tehcnologies*, 9:42–53, 2007.
- [I14] P. Murogoki S. Comorosan, M. Hristea. On a new symmetry in biological systems. *Bull. of Math. Biol.*, page 107, 1980.
- [I15] O. E. Tetlie S. J. Braddy, M. Poschmann. Giant claw reveals the largest ever arthropod. *Biology Letters*. <http://www.journals.royalsoc.ac.uk/content/t15r2588mm27n0w1>, November 2007.

Neuroscience and Consciousness

- [J1] V. Chernobrov. Experiments on the Change of Direction and Rate of Time Motion. In *Proc. of III Int. Conf. On Problems of Space, Time, and Gravitation. Russian Academy of Sciences, St. Petersburg, Russia*, 1996.
- [J2] B. Libet et al. Subjective referral of the timing for a conscious sensory experience. *Brain*, 102, 1979.
- [J3] M. Pitkänen et al H. Abdelmeik. Changes in electrical properties of frog sciatic nerves at low temperature: superconductor-like behaviour. http://tgdtheory.com/public_html/articles/hafpaper.pdf, 2003.
- [J4] S. Hameroff. Quantum Coherence in Microtubules: a Neural Basis for Emergent Consciousness? *Journal of Consciousness Studies*. <http://en.wikipedia.org/wiki/Orch-OR>, 1(1), 1994.
- [J5] S. Klein. Libet's Research on Timing of Conscious Intention to Act: A Commentary. *Consciousness and Cognition*. http://cornea.berkeley.edu/pubs/ccog_2002_0580-Klein-Commentary.pdf, 11, 2002.
- [J6] R. Penrose. *Shadows of the Mind*. Vintage, 1994.
- [J7] D. Reed. Conceptual Hurdles to New Millennium Physics. *Explore!*, (1), 2003.

Books related to TGD

- [K1] Construction of S-matrix. In *Towards S-matrix*. Onlinebook. http://tgdtheory.com/public_html/tgdquant/tgdquant.html#smatrix, 2000.
- [K2] P. Gariaev and M. Pitkänen. Model for the Findings about Hologram Generating Properties of DNA. In *Genes and Memes*. Onlinebook. http://tgdtheory.com/public_html/genememe/genememe.html#dnahologram, 2011.
- [K3] M. Pitkänen. 1983.
- [K4] M. Pitkänen. Basic Properties of CP_2 and Elementary Facts about p-Adic Numbers. In *Towards M-matrix*. Onlinebook. http://tgdtheory.com/public_html/pdfpool/append.pdf, 2006.
- [K5] M. Pitkänen. Is it Possible to Understand Coupling Constant Evolution at Space-Time Level? In *Towards M-Matrix*. Onlinebook. http://tgdtheory.com/public_html/tgdquant/tgdquant.html#rgflow, 2006.
- [K6] M. Pitkänen. About Nature of Time. In *TGD Inspired Theory of Consciousness*. Onlinebook. http://tgdtheory.com/public_html/tgdconsc/tgdconsc.html#timenature, 2006.
- [K7] M. Pitkänen. About the New Physics Behind Qualia. In *Quantum Hardware of Living Matter*. Onlinebook. http://tgdtheory.com/public_html/bioware/bioware.html#newphys, 2006.
- [K8] M. Pitkänen. An Overview about Quantum TGD: Part I. In *Topological Geometro-dynamics: Overview*. Onlinebook. http://tgdtheory.com/public_html/tgdview/tgdview.html#evoII, 2006.
- [K9] M. Pitkänen. An Overview about the Evolution of Quantum TGD. In *Topological Ge-ometrodynamics: Overview*. Onlinebook. http://tgdtheory.com/public_html/tgdview/tgdview.html#evoI, 2006.
- [K10] M. Pitkänen. Anomalies Related to the Classical Z^0 Force and Gravitation. In *TGD and Fringe Physics*. Onlinebook. http://tgdtheory.com/public_html/freenergy/freenergy.html#Zanom, 2006.
- [K11] M. Pitkänen. Basic Extremals of Kähler Action. In *Physics in Many-Sheeted Space-Time*. Onlinebook. http://tgdtheory.com/public_html/tgdclass/tgdclass.html#class, 2006.
- [K12] M. Pitkänen. *Bio-Systems as Conscious Holograms*. Onlinebook. http://tgdtheory.com/public_html/hologram/hologram.html, 2006.
- [K13] M. Pitkänen. Bio-Systems as Conscious Holograms. In *Bio-Systems as Conscious Holo-grams*. Onlinebook. http://tgdtheory.com/public_html/hologram/hologram.html#hologram, 2006.
- [K14] M. Pitkänen. *Bio-Systems as Self-Organizing Quantum Systems*. Onlinebook. http://tgdtheory.com/public_html/bioselforg/bioselforg.html, 2006.
- [K15] M. Pitkänen. Bio-Systems as Super-Conductors: part I. In *Quantum Hardware of Liv-ing Matter*. Onlinebook. http://tgdtheory.com/public_html/bioware/bioware.html#superc1, 2006.

- [K16] M. Pitkänen. Bio-Systems as Super-Conductors: part II. In *Quantum Hardware of Living Matter*. Onlinebook. http://tgdtheory.com/public_html/bioware/bioware.html#superc2, 2006.
- [K17] M. Pitkänen. Biological Realization of Self Hierarchy. In *Bio-Systems as Self-Organizing Quantum Systems*. Onlinebook. http://tgdtheory.com/public_html/bioselforg/bioselforg.html#bioselfc, 2006.
- [K18] M. Pitkänen. Category Theory and Quantum TGD. In *Towards M-Matrix*. Onlinebook. http://tgdtheory.com/public_html/tgdquant/tgdquant.html#categorynew, 2006.
- [K19] M. Pitkänen. Configuration Space Spinor Structure. In *Quantum Physics as Infinite-Dimensional Geometry*. Onlinebook. http://tgdtheory.com/public_html/tgdgeom/tgdgeom.html#cspin, 2006.
- [K20] M. Pitkänen. Construction of Configuration Space Kähler Geometry from Symmetry Principles. In *Quantum Physics as Infinite-Dimensional Geometry*. Onlinebook. http://tgdtheory.com/public_html/tgdgeom/tgdgeom.html#compl1, 2006.
- [K21] M. Pitkänen. Construction of elementary particle vacuum functionals. In *p-Adic length Scale Hypothesis and Dark Matter Hierarchy*. Onlinebook. http://tgdtheory.com/public_html/paddark/paddark.html#elvafu, 2006.
- [K22] M. Pitkänen. Construction of Quantum Theory: M-matrix. In *Towards M-Matrix*. Onlinebook. http://tgdtheory.com/public_html/tgdquant/tgdquant.html#towards, 2006.
- [K23] M. Pitkänen. Construction of Quantum Theory: Symmetries. In *Towards M-Matrix*. Onlinebook. http://tgdtheory.com/public_html/tgdquant/tgdquant.html#quthe, 2006.
- [K24] M. Pitkänen. Cosmic Strings. In *Physics in Many-Sheeted Space-Time*. Onlinebook. http://tgdtheory.com/public_html/tgdclass/tgdclass.html#cstrings, 2006.
- [K25] M. Pitkänen. Dark Forces and Living Matter. In *p-Adic Length Scale Hypothesis and Dark Matter Hierarchy*. Onlinebook. http://tgdtheory.com/public_html/paddark/paddark.html#darkforces, 2006.
- [K26] M. Pitkänen. Dark Matter Hierarchy and Hierarchy of EEGs. In *TGD and EEG*. Onlinebook. http://tgdtheory.com/public_html/tgdeeg/tgdeeg.html#eegdark, 2006.
- [K27] M. Pitkänen. Dark Nuclear Physics and Condensed Matter. In *p-Adic Length Scale Hypothesis and Dark Matter Hierarchy*. Onlinebook. http://tgdtheory.com/public_html/paddark/paddark.html#exonuclear, 2006.
- [K28] M. Pitkänen. Did Tesla Discover the Mechanism Changing the Arrow of Time? In *TGD and Fringe Physics*. Onlinebook. http://tgdtheory.com/public_html/freenergy/freenergy.html#tesla, 2006.
- [K29] M. Pitkänen. DNA as Topological Quantum Computer. In *Genes and Memes*. Onlinebook. http://tgdtheory.com/public_html/genememe/genememe.html#dnatqc, 2006.
- [K30] M. Pitkänen. Does TGD Predict the Spectrum of Planck Constants? In *Towards M-Matrix*. Onlinebook. http://tgdtheory.com/public_html/tgdquant/tgdquant.html#Planck, 2006.
- [K31] M. Pitkänen. Does the Modified Dirac Equation Define the Fundamental Action Principle? In *Quantum Physics as Infinite-Dimensional Geometry*. Onlinebook. http://tgdtheory.com/public_html/tgdgeom/tgdgeom.html#Dirac, 2006.
- [K32] M. Pitkänen. Does the QFT Limit of TGD Have Space-Time Super-Symmetry? In *Towards M-Matrix*. Onlinebook. http://tgdtheory.com/public_html/tgdquant/tgdquant.html#susy, 2006.
- [K33] M. Pitkänen. Evolution in Many-Sheeted Space-Time. In *Genes and Memes*. Onlinebook. http://tgdtheory.com/public_html/genememe/genememe.html#prebio, 2006.
- [K34] M. Pitkänen. Fusion of p-Adic and Real Variants of Quantum TGD to a More General Theory. In *TGD as a Generalized Number Theory*. Onlinebook. http://tgdtheory.com/public_html/tgdnumber/tgdnumber.html#mblocks, 2006.

- [K35] M. Pitkänen. General Ideas about Many-Sheeted Space-Time: Part I. In *Physics in Many-Sheeted Space-Time*. Onlinebook. http://tgdtheory.com/public_html/tgdclass/tgdclass.html#topcond, 2006.
- [K36] M. Pitkänen. General Ideas about Many-Sheeted Space-Time: Part II. In *Physics in Many-Sheeted Space-Time*. Onlinebook. http://tgdtheory.com/public_html/tgdclass/tgdclass.html#newviews, 2006.
- [K37] M. Pitkänen. General Theory of Qualia. In *Bio-Systems as Conscious Holograms*. Onlinebook. http://tgdtheory.com/public_html/hologram/hologram.html#qualia, 2006.
- [K38] M. Pitkänen. Generalized Feynman Diagrams as Generalized Braids. In *Towards M-Matrix*. Onlinebook. http://tgdtheory.com/public_html/tgdquant/tgdquant.html#braidfeynman, 2006.
- [K39] M. Pitkänen. *Genes and Memes*. Onlinebook. http://tgdtheory.com/public_html/genememe/genememe.html, 2006.
- [K40] M. Pitkänen. Identification of the Configuration Space Kähler Function. In *Quantum Physics as Infinite-Dimensional Geometry*. Onlinebook. http://tgdtheory.com/public_html/tgdgeom/tgdgeom.html#kahler, 2006.
- [K41] M. Pitkänen. Knots and TGD. In *Quantum Physics as Infinite-Dimensional Geometry*. Onlinebook. http://tgdtheory.com/public_html/tgdgeom/tgdgeom.html#knotstgd, 2006.
- [K42] M. Pitkänen. Langlands Program and TGD. In *TGD as a Generalized Number Theory*. Onlinebook. http://tgdtheory.com/public_html/tgdnumber/tgdeeg/tgdnumber.html#Langlandia, 2006.
- [K43] M. Pitkänen. Macro-Temporal Quantum Coherence and Spin Glass Degeneracy. In *Bio-Systems as Conscious Holograms*. Onlinebook. http://tgdtheory.com/public_html/hologram/hologram.html#macro, 2006.
- [K44] M. Pitkänen. Macroscopic Quantum Coherence and Quantum Metabolism as Different Sides of the Same Coin. In *Bio-Systems as Conscious Holograms*. Onlinebook. http://tgdtheory.com/public_html/hologram/hologram.html#metab, 2006.
- [K45] M. Pitkänen. Macroscopic Quantum Phenomena and CP_2 Geometry. In *Physics in Many-Sheeted Space-Time*. Onlinebook. http://tgdtheory.com/public_html/tgdclass/tgdclass.html#super, 2006.
- [K46] M. Pitkänen. *Magnetospheric Consciousness*. Onlinebook. http://tgdtheory.com/public_html/magnconsc/magnconsc.html, 2006.
- [K47] M. Pitkänen. Many-Sheeted DNA. In *Genes and Memes*. Onlinebook. http://tgdtheory.com/public_html/genememe/genememe.html#genecodec, 2006.
- [K48] M. Pitkänen. Massless states and particle massivation. In *p-Adic Length Scale Hypothesis and Dark Matter Hierarchy*. Onlinebook. http://tgdtheory.com/public_html/paddark/paddark.html#mless, 2006.
- [K49] M. Pitkänen. *Mathematical Aspects of Consciousness Theory*. Onlinebook. http://tgdtheory.com/public_html/mathconsc/mathconsc.html, 2006.
- [K50] M. Pitkänen. Matter, Mind, Quantum. In *TGD Inspired Theory of Consciousness*. Onlinebook. http://tgdtheory.com/public_html/tgdconsc/tgdconsc.html#conscic, 2006.
- [K51] M. Pitkänen. Negentropy Maximization Principle. In *TGD Inspired Theory of Consciousness*. Onlinebook. http://tgdtheory.com/public_html/tgdconsc/tgdconsc.html#nmpc, 2006.
- [K52] M. Pitkänen. New Particle Physics Predicted by TGD: Part I. In *p-Adic Length Scale Hypothesis and Dark Matter Hierarchy*. Onlinebook. http://tgdtheory.com/public_html/paddark/paddark.html#mass4, 2006.
- [K53] M. Pitkänen. Nuclear String Hypothesis. In *p-Adic Length Scale Hypothesis and Dark Matter Hierarchy*. Onlinebook. http://tgdtheory.com/public_html/paddark/paddark.html#nuclstring, 2006.

- [K54] M. Pitkänen. *p-Adic length Scale Hypothesis and Dark Matter Hierarchy*. Onlinebook. http://tgdtheory.com/public_html/paddark/paddark.html, 2006.
- [K55] M. Pitkänen. p-Adic Particle Massivation: Elementary Particle Masses. In *p-Adic Length Scale Hypothesis and Dark Matter Hierarchy*. Onlinebook. http://tgdtheory.com/public_html/paddark/paddark.html#mass2, 2006.
- [K56] M. Pitkänen. p-Adic Particle Massivation: Hadron Masses. In *p-Adic Length Scale Hypothesis and Dark Matter Hierarchy*. Onlinebook. http://tgdtheory.com/public_html/paddark/paddark.html#mass3, 2006.
- [K57] M. Pitkänen. p-Adic Physics as Physics of Cognition and Intention. In *TGD Inspired Theory of Consciousness*. Onlinebook. http://tgdtheory.com/public_html/tgdconsc/tgdconsc.html#cognic, 2006.
- [K58] M. Pitkänen. p-Adic Physics: Physical Ideas. In *TGD as a Generalized Number Theory*. Onlinebook. http://tgdtheory.com/public_html/tgdnumber/tgdnumber.html#pblocks, 2006.
- [K59] M. Pitkänen. *Physics in Many-Sheeted Space-Time*. Onlinebook. http://tgdtheory.com/public_html/tgdclass/tgdclass.html, 2006.
- [K60] M. Pitkänen. Quantum Antenna Hypothesis. In *Quantum Hardware of Living Matter*. Onlinebook. http://tgdtheory.com/public_html/bioware/bioware.html#tubuc, 2006.
- [K61] M. Pitkänen. Quantum Astrophysics. In *Physics in Many-Sheeted Space-Time*. Onlinebook. http://tgdtheory.com/public_html/tgdclass/tgdclass.html#qastro, 2006.
- [K62] M. Pitkänen. Quantum Field Theory Limit of TGD from Bosonic Emergence. In *Towards M-Matrix*. Onlinebook. http://tgdtheory.com/public_html/tgdquant/tgdquant.html#emergence, 2006.
- [K63] M. Pitkänen. Quantum Hall effect and Hierarchy of Planck Constants. In *p-Adic Length Scale Hypothesis and Dark Matter Hierarchy*. Onlinebook. http://tgdtheory.com/public_html/tpaddark/paddark.html#anyontgd, 2006.
- [K64] M. Pitkänen. *Quantum Hardware of Living Matter*. Onlinebook. http://tgdtheory.com/public_html/bioware/bioware.html, 2006.
- [K65] M. Pitkänen. Quantum Model for Hearing. In *TGD and EEG*. Onlinebook. http://tgdtheory.com/public_html//tgdeeg/tgdeeg/tgdeeg.html#hearing, 2006.
- [K66] M. Pitkänen. Quantum Model for Nerve Pulse. In *TGD and EEG*. Onlinebook. http://tgdtheory.com/public_html//tgdeeg/tgdeeg/tgdeeg.html#pulse, 2006.
- [K67] M. Pitkänen. Quantum Model of EEG. In *TGD and EEG*. Onlinebook. http://tgdtheory.com/public_html/tgdeeg/tgdeeg.html#eegII, 2006.
- [K68] M. Pitkänen. *Quantum Physics as Infinite-Dimensional Geometry*. Onlinebook. http://tgdtheory.com/public_html/tgdgeom/tgdgeom.html, 2006.
- [K69] M. Pitkänen. *Quantum TGD*. Onlinebook. http://tgdtheory.com/public_html/tgdquant/tgdquant.html, 2006.
- [K70] M. Pitkänen. Quantum Theory of Self-Organization. In *Bio-Systems as Self-Organizing Quantum Systems*. Onlinebook. http://tgdtheory.com/public_html/bioselforg/bioselforg.html#selforgac, 2006.
- [K71] M. Pitkänen. Riemann Hypothesis and Physics. In *TGD as a Generalized Number Theory*. Onlinebook. http://tgdtheory.com/public_html/tgdnumber/tgdnumber.html#riema, 2006.
- [K72] M. Pitkänen. TGD and Astrophysics. In *Physics in Many-Sheeted Space-Time*. Onlinebook. http://tgdtheory.com/public_html/tgdclass/tgdclass.html#astro, 2006.
- [K73] M. Pitkänen. TGD and Cosmology. In *Physics in Many-Sheeted Space-Time*. Onlinebook. http://tgdtheory.com/public_html/tgdclass/tgdclass.html#cosmo, 2006.
- [K74] M. Pitkänen. *TGD and EEG*. Onlinebook. http://tgdtheory.com/public_html/tgdeeg/tgdeeg.html, 2006.

- [K75] M. Pitkänen. *TGD and Fringe Physics*. Onlinebook. http://tgdtheory.com/public_html/freenergy/freenergy.html, 2006.
- [K76] M. Pitkänen. TGD and M-Theory. In *Topological Geometrodynamics: Overview*. Onlinebook. http://tgdtheory.com/public_html/tgdview/tgdview.html#MTGD, 2006.
- [K77] M. Pitkänen. TGD and Nuclear Physics. In *p-Adic Length Scale Hypothesis and Dark Matter Hierarchy*. Onlinebook. http://tgdtheory.com/public_html/paddark/paddark.html#padnucl, 2006.
- [K78] M. Pitkänen. *TGD as a Generalized Number Theory*. Onlinebook. http://tgdtheory.com/public_html/tgdnumber/tgdnumber.html, 2006.
- [K79] M. Pitkänen. TGD as a Generalized Number Theory: Infinite Primes. In *TGD as a Generalized Number Theory*. Onlinebook. http://tgdtheory.com/public_html/tgdnumber/tgdnumber.html#visionc, 2006.
- [K80] M. Pitkänen. TGD as a Generalized Number Theory: p-Adicization Program. In *TGD as a Generalized Number Theory*. Onlinebook. http://tgdtheory.com/public_html/tgdnumber/tgdnumber.html#visiona, 2006.
- [K81] M. Pitkänen. TGD as a Generalized Number Theory: Quaternions, Octonions, and their Hyper Counterparts. In *TGD as a Generalized Number Theory*. Onlinebook. http://tgdtheory.com/public_html/tgdnumber/tgdnumber.html#visionb, 2006.
- [K82] M. Pitkänen. *TGD Inspired Theory of Consciousness*. Onlinebook. http://tgdtheory.com/public_html/tgdconsc/tgdconsc.html, 2006.
- [K83] M. Pitkänen. The Notion of Free Energy and Many-Sheeted Space-Time Concept. In *TGD and Fringe Physics*. Onlinebook. http://tgdtheory.com/public_html/freenergy/freenergy.html#freenergy, 2006.
- [K84] M. Pitkänen. The Recent Status of Lepto-hadron Hypothesis. In *p-Adic Length Scale Hypothesis and Dark Matter Hierarchy*. Onlinebook. http://tgdtheory.com/public_html/paddark/paddark.html#leptc, 2006.
- [K85] M. Pitkänen. The Relationship Between TGD and GRT. In *Physics in Many-Sheeted Space-Time*. Onlinebook. http://tgdtheory.com/public_html/tgdclass/tgdclass.html#tgdgrt, 2006.
- [K86] M. Pitkänen. Time, Spacetime and Consciousness. In *Bio-Systems as Conscious Holograms*. Onlinebook. http://tgdtheory.com/public_html/hologram/hologram.html#time, 2006.
- [K87] M. Pitkänen. *Topological Geometrodynamics: an Overview*. Onlinebook. http://tgdtheory.com/public_html/tgdview/tgdview.html, 2006.
- [K88] M. Pitkänen. Topological Quantum Computation in TGD Universe. In *Genes and Memes*. Onlinebook. http://tgdtheory.com/public_html/genememe/genememe.html#tqc, 2006.
- [K89] M. Pitkänen. Twistors, N=4 Super-Conformal Symmetry, and Quantum TGD. In *Towards M-Matrix*. Onlinebook. http://tgdtheory.com/public_html/tgdquant/tgdquant.html#twistor, 2006.
- [K90] M. Pitkänen. Was von Neumann Right After All. In *Towards M-Matrix*. Onlinebook. http://tgdtheory.com/public_html/tgdquant/tgdquant.html#vNeumann, 2006.
- [K91] M. Pitkänen. Wormhole Magnetic Fields. In *Quantum Hardware of Living Matter*. Onlinebook. http://tgdtheory.com/public_html/bioware/bioware.html#wormc, 2006.
- [K92] M. Pitkänen. Yangian Symmetry, Twistors, and TGD. In *Towards M-Matrix*. Onlinebook. http://tgdtheory.com/public_html/tgdquant/tgdquant.html#Yangian, 2006.
- [K93] M. Pitkänen. Motives and Infinite Primes. In *TGD as a Generalized Number Theory*. Onlinebook. http://tgdtheory.com/public_html/tgdnumber/tgdnumber.html#infmotives, 2011.
- [K94] M. Pitkänen. The Recent Vision About Preferred Extremals and Solutions of the Modified Dirac Equation. In *Quantum Physics as Infinite-Dimensional Geometry*. Onlinebook. http://tgdtheory.com/public_html/tgdgeom/tgdgeom.html#dirasvira, 2012.

- [K95] M. Pitkänen. What are the counterparts of Einstein's equations in TGD? In *Physics in Many-Sheeted Space-Time*. Onlinebook. http://tgdtheory.com/public_html/tgdclass/tgdclass.html#EinsteinTGD, 2013.
- [K96] M. Pitkänen. What p-Adic Icosahedron Could Mean? And What about p-Adic Manifold? In *TGD as a Generalized Number Theory*. Onlinebook. http://tgdtheory.com/public_html/tgdnumber/tgdnumber.html#picosahedron, 2013.
- [K97] M. Pitkänen and P. Gariaev. Quantum Model for Remote Replication. In *Genes and Memes*. Onlinebook. http://tgdtheory.com/public_html/genememe/genememe.html#remotereplication, 2011.

Articles about TGD

- [L1] M. Pitkänen. Basic Properties of CP_2 and Elementary Facts about p-Adic Numbers. <http://tgdtheory.com/pdfpool/append.pdf>, 2006.
- [L2] M. Pitkänen. Further Progress in Nuclear String Hypothesis. <http://tgdtheory.com/articles/nuclstring.pdf>, 2007.
- [L3] M. Pitkänen. About the Nature of Time. <http://tgdtheory.com/articles/time.pdf>, 2008.
- [L4] M. Pitkänen. Physics as Generalized Number Theory III: Infinite Primes. <https://www.createspace.com/3569411>, July 2010.
- [L5] M. Pitkänen. The Geometry of CP_2 and its Relationship to Standard Model. <https://www.createspace.com/3569411>, July 2010.
- [L6] M. Pitkänen. Are neutrinos superluminal? <http://tgdtheory.com/articles/speedofneutrino.pdf>, 2011.
- [L7] M. Pitkänen. Do we really understand the solar system? <http://tgdtheory.com/articles/precession.pdf>, 2011.
- [L8] M. Pitkänen. TGD inspired vision about entropic gravitation. <http://tgdtheory.com/articles/egtgd.pdf>, 2011.
- [L9] M. Pitkänen. Some considerations relating to the dynamics of quasicrystals. http://tgdtheory.com/public_html/articles/QCTGD.pdf, 2012.
- [L10] M. Pitkänen. Updated view about the hierarchy of Planck constants. *Prespacetime Journal*, <http://prespacetime.com/index.php/pst/issue/view/34>, 3(11), 2012.

Index

- H*-chirality, 922
- $M^8 - H$ duality, 42
- , 917
- absolute minimization of Kähler action, 75, 191, 644
- accelerated cosmic expansion, 353, 482, 580, 582
- acceleration mechanism, 582
- Adams, 772
- ADE diagrams, 334
- AdS/CFT dualities, 771
- Aharonov Bohm effect, 522
- Aharonov-Bohm effect, 522
- Alfven wave, 63, 517
- algebraic hologram, 297
- anisotropy of cosmic microwave background, 768
- anomalies in cosmic microwave background, 668
- anomalies of cosmic microwave background, 788, 800
- anomalous time dilation, 425
- anomalously large time dilation effect, 425
- anticommutation relations, 623
- anyon state, 388
- association, 234
- associative, 234
- associativity, 233, 234
- asymptotic cosmology, 556
- ATP, 775
- axion, 520
- axions, 520, 521

- Beltrami conditions, 40
- Beltrami fields, 19
- Beraha numbers, 655
- Betti number, 917
- Big Bang, 593
- big crunch, 248, 389, 481
- big voids, 768
- Bohr quantization of planetary orbits, 669, 671
- Bohr-Sommerfeld quantization, 650
- Boltzmann statistics, 640
- Bose Einstein condensate, 189
- braiding, 203
- Brownian motion, 801
- Bullet cluster, 431

- c, 917
- Cambrian explosion, 775
- Cambrian period, 774
- central charge, 509
- central engine, 501, 509
- chaos in excitable media, 733
- chaotic scattering, 733
- charge entanglement, 189
- charge renormalization, 189, 205
- chemical bond, 189
- Chern-Simons term, 543
- Christoffel symbol, 57
- classical chaos, 743
- classical determinism, 328, 546
- classical TGD, 18
- CMB, 230, 799
- CMB background, 483
- co-hyper-quaternionic surface, 18
- co-hyper-quaternionicity, 42
- co-unit, 232, 234
- coherence lengths, 891
- coherent states of photons, 48
- color confinement, 188, 218
- color Coulombic energy, 219
- color electric flux tube, 219
- color electric flux tubes, 218, 219
- color force, 597, 598
- color glass condensate, 590
- color magnetic flux tube, 219, 596
- Comorosan effect, 213
- complexification, 298
- condensate level, 207
- cones, 228
- configuration space Hamiltonian, 66
- configuration space spinor, 297, 351, 523
- configuration space spinor structure, 50
- conformal confinement, 233, 594
- conformal field, 232
- conformal structure, 51
- Connes, 304
- contact form, 54
- contact structure, 54
- contents of consciousness, 493
- contravariant metric, 50
- coordinates of Eguchi and Freund, 917
- correlation between supernovae and gamma ray bursts,
- coset space, 353
- cosmic rays, 598
- cosmic string pairs, 492
- cosmic strings, 79, 350, 473
- covariantly constant, 919
- Crabwood, 482

- critical cosmologies, 589, 593
critical cosmology, 526
critical temperature, 893
curvature tensor, 470, 485, 635
- Da Rocha, 624, 625
Darboux coordinates, 524
dark graviton, 354, 403
dark matter halo, 404, 510
dark matter hierarchy, 189
dark neutrinos, 384
de-coherence time, 221
density matrix, 217
differentiation, 736, 739
divergence cancellation, 19
DNA as topological quantum computer, 235, 664
Doppler shift, 673
dynamical and quantized Planck constant, 333, 407, 415
dynamical quantized Planck constant, 189
dynamo model, 374, 378, 382, 514
- Eguchi-Hanson coordinates, 194
Einstein-Hilbert action, 536, 771
electro-weak couplings, 921
electro-weak interactions, 922
entanglement entropy, 297, 867
entrapment, 656
equality of gravitational and inertial masses, 318
Euler equations, 53
exoplanets, 468, 475, 642
Expanding Earth theory, 767
- factors of type I, 226, 525
factors of type II, 229, 352
factors of type II_1 , 296
failure of perturbation theory, 243, 336
Fermat primes, 599
fermionic propagator, 54
final state of the star, 374
finite fields, 374
flyby anomaly, 674
formation of structures, 501, 502, 555
four-dimensional spin glass, 191
Fractal cosmology, 526
fractal cosmology, 84, 527, 528, 552
fractional electric charge, 914
fractional quantum Hall effect, 729, 910
free cosmic strings, 389, 477, 480, 481, 526, 538
Fuschian groups, 551
- galaxies as pearls in necklace, 492
Galois, 298
gamma ray bursters, 511, 583
gamma ray bursts, 354, 382
gamma ray flares, 427
gauge charge, 189, 306
gauge flux, 189
- General Coordinate Invariance, 305, 354
generalization of the notion of number, 189, 296
generalized Beltrami conditions, 19
generalized Bohr orbit, 189, 190, 473
generation of structures, 188, 215
Geodesic sub-manifolds, 921
geometrization of classical fields, 672
graphene, 427
gravimagnetism, 354, 367, 405, 410
graviphoton, 410, 411
gravitational Bohr orbitology, 728, 731
gravitational collapse, 249, 383, 599
gravitational flux, 189
gravitational mass, 189
gravitational radiation, 495, 500, 517
- hadronic string tension, 221, 597
hadronization, 593, 596
Hagedorn temperature, 528, 544, 596, 597
Haken, 868
Hamilton Jacobi function, 82
Hamilton-Jacobi structure, 55
Hawking-Bekenstein law, 844, 861
hierarchy of infinite primes, 850
hierarchy of scaled up copies of standard model physics, 189
hierarchy of selves, 850
Higgs mechanism, 188
holograph, 202
holonomy, 926
homotopy group, 920
Hubble's constant, 768
Hulse-Taylor binary, 748–750
hydrodynamic turbulence, 188
hyper-finite factor of type II_1 , 622
hyper-octonicity, 298
hyper-octonions, 298
hyper-quaternionic surface, 18
- imbeddings of Robertson-Walker cosmologies, 531
imbeddability of cosmologies, 526
imbedding, 195, 406, 503
impact parameter, 592
implicit memories, 625
inclination, 625
inclinations of planetary orbits, 649
induced gamma matrices, 228
induced spinor connection, 922
infinite-dimensional symmetric space, 526, 547
inflationary cosmologies, 561, 568, 589
inflationary cosmology, 526, 560
initial value sensitivity, 741, 866, 901
inner core, 741
instanton current, 19
integrated Sachs-Wolf effect, 768
irreducible self, 757
isometry algebra, 535
isometry group, 296

- join along boundaries bond, 189
 Jones inclusion, 236
 Jones index, 848
 Josephson frequency, 848

 Kähler calibration, 79
 Kähler coupling strength as analog of critical temperature, 19
 Kähler current, 19
 Kähler form, 919
 Kähler function, 244, 918
 Kähler metric, 43, 918
 Kähler potential, 920
 Kac Moody group, 334
 KAM theorem, 743
 Kiehn, 797
 Killing vector fields, 296
 knotting and linking of cosmic strings, 492

 Lagrange manifold, 413, 427, 526
 Landau level, 640
 length scale cutoff, 297
 lense effect, 389, 390, 481
 lepto-hadrons, 519
 lepto-pion, 518, 596
 lepto-pions, 476
 leptohadron physics, 596
 Libet, 656
 Lie algebra, 225
 Lie triple system, 921
 light-like boundary, 551, 595
 light-like causal determinant, 204, 846
 limiting temperature, 548, 549
 line element, 918
 Lobatchevski space, 483, 550
 local light cone coordinates, 56, 81
 localization in zero modes, 192
 long range correlations, 297
 long range quantum correlations, 867
 long ranged Z^0 fields, 885
 loop space, 296
 Lorentz group, 551, 770

 M-matrix, 226
 Machian Principle, 353, 354, 470
 macro-temporal quantum coherence, 221
 macroscopic quantum coherence, 221
 magnetic fluxes, 206
 magnetic monopole, 209, 920
 magnetohydrodynamics, 53, 515, 629
 Mantovani, 774
 Masreliez, 476, 669, 670
 massless extremals, 79
 matter dominated cosmology, 374, 535, 555
 matter-antimatter asymmetry, 528
 Maxwell line, 865–867
 measurement apparatus, 867
 Meissner effect, 896

 meme, 656
 metric structure, 212, 226
 Michelson-Morley experiment, 463
 micro-jet structure, 511
 Milgrom, 646
 Mills, 529
 minimization of free energy, 863, 864
 modulation hierarchy, 792
 MOND, 646
 morphogenesis, 642
 multi-p-fractality, 189

 N-point function, 304
 Navier-Stokes equations, 841
 Neal Adams, 772
 Noether charge, 305
 non-pertubative phase, 338
 non-vacuum extremals, 79
 Nottale, 642
 number theoretic compactification, 40
 number theoretic momentum, 731
 number theoretical compactification, 304

 octonion automorphisms, 298
 octonions, 297
 olor glass condensate, 595

 p-adic fractality, 390, 483, 540, 583
 p-adic fractals, 628, 629
 p-adic length scale hypothesis, 189
 p-adic physics as physics of cognition, 233
 pairs of cosmic strings, 497, 514, 537
 parallel transport, 920
 path integral, 752, 793
 pattern recognition, 464
 perceptive field, 546
 periodic orbits, 743, 744
 phase conjugate laser beam, 851
 phase slippage, 875, 878, 879
 phase transitions changing the value of Planck constant, 49
 photosphere, 666
 Pioneer anomaly, 671, 672, 674
 Poincare energy, 85
 Poincare group, 770
 Poincare invariant theory of gravitation, 349
 Pontryagin number, 917
 preferred extremals as generalized Bohr orbits, 473
 preferred values of Planck constant, 739
 primary field, 363
 primordial cosmology, 546–548, 552
 psychological time, 221
 puzzle of several Hubble constants, 578

 quadrupole radiation, 749, 750
 quantization of cosmic recession velocity, 492
 quantization of cosmic red shifts, 490
 quantization of cosmic redshifts, 335, 589

- quantization of red shifts, 489
 quantum chaos, 732, 733
 quantum classical correspondence, 19
 quantum computation, 600
 quantum critical contra inflationary cosmology, 526
 quantum critical cosmology, 526, 559, 771
 quantum criticality, 190
 quantum gravitational holography, 43
 Quantum Hall Effect (QHE), 728
 quantum holography, 80
 quantum measurement theory with finite measurements, 229
 quantum spin glass, 222
 quantum-classical correspondence, 591
 quark-gluon plasma, 589
 quasars, 489
- radiation dominated cosmology, 514, 548, 554, 663
 rapidity, 591
 Regge slope, 597
 Reissner-Nordström, 85, 353
 Relativistic Heavy Ion Collider, 589
 Renormalization group invariance, 19, 188
 renormalization group invariance, 43, 190
 RHIC, 589
 RHIC events, 596, 600
 Ricci tensor, 471, 486
 Riemann structure, 54
 rigid structures in photosphere, 381
 Robertson-Walker cosmologies, 359, 592
 Robertson-Walker cosmology, 526
 ruler-and-compass hypothesis, 476, 745
 ruler-and-compass integers, 249, 387, 599
 Russian doll cosmology, 526
- scaling laws, 864
 Schrödinger equation, 334
 Schumann frequency, 656
 Schwarzschild metric, 92, 353, 465, 466
 Schwarzschild radius, 249, 599
 Schwartshild radius, 377
 second fundamental form, 49
 second law, 544
 second quantization, 234
 self measurement, 222
 Shannon entropy, 297
 Silent Whisper amplified to Bang, 526
 simulating big bang in laboratory, 529
 skills, 772
 solar corona, 638
 solar cycle, 629, 631
 space-time surface as generalized Bohr orbit, 18
 spectral density, 522, 800
 spectrum of Planck constants, 760
 spin fractionization, 732
 spin glass, 191
 spin glass analogy, 19, 41, 190
 spinor connection, 920
 spinor structure, 920
 spiral galaxies, 499, 500
 stars older than the universe, 528, 575
 state preparation, 222
 stationary asymptotic cosmology, 536
 stationary cosmologies, 527, 559, 567
 string dominated cosmology, 535, 543, 544
 string tension, 473
 strong gravi-magnetism, 410
 subduction, 773
 subfactor, 622
 sunspot cycle, 629, 638
 super conductivity, 188
 super continent, 772, 774
 super fluidity, 188
 Super Nova, 382
 super nova, 375, 514
 super nova explosion, 382
 super-conductivity, 213
 super-symplectic invariance, 225
 superfluidity, 637, 855, 885
 supra phases, 189, 655, 864
 surface gravity, 775, 776
 symplectic structure, 919
 symplectic tensor, 797
 synchrotron radiation, 383, 476
- target space, 93
 tectonic plates, 773, 774
 tectonics, 773, 774
 tetra-neutron, 384
 TGD as a Poincare invariant theory of gravitation, 187
 TGD as a generalization of the string model, 187
 theta band, 657
 Thirring-Lense effect, 405, 406
 Thomson magnetic field, 410, 413
 Thomson magnetic moment, 410
 tidal effects, 395
 Tifft, 658, 659
 time dependence of fine structure constant, 585
 time like entanglement, 790
 time-like entanglement, 232, 799
 time-like entanglement coefficients, 232
 topological condensate, 192, 201
 topological condensation, 187
 topological condensation of cosmic strings, 477, 481, 539
 topological condensed cosmic strings, 389, 480, 538
 topological field quantum, 188, 189, 193
 topological in-homogenities as particles, 187
 topological light rays, 79
 topological sum, 187
 trace of the second fundamental form, 49
 transcendental, 297
 transition to turbulence, 843, 854, 874
 tritium beta decay anomaly, 383
 turbulence, 630, 841

- twin primes, 586
- twistor program, 468

- U-matrix, 232
- unwinding, 55

- vacuum degeneracy of Kähler action, 319
- vacuum Einstein equations, 471, 472
- vacuum energy, 362
- vacuum extremals, 74
- vacuum functional as exponent of Kähler function, 19
- vacuum quantum numbers, 188, 193
- valence quark, 218
- vanishing of Lorentz-Kähler 4-force, 19
- vielbein group, 343, 922
- vierbein, 918
- vierbein connection, 919
- Virasoro conditions, 75
- vortex flow, 856, 857
- vorticity, 55

- warped embeddings, 425, 659
- warped imbeddings, 425
- weakened form of Equivalence Principle, 734
- Weinberg angle, 924

- zitterbewegung, 75, 85