

Redeployment Options for the International Space Station

A Thesis for the Masters Degree in Space Systems Engineering
Submitted to Stevens Institute of Technology
2010

Gary V. Stephenson

425-443-8651, gary.stephenson@gmail.com

Abstract. With the assumption that the current mission of the International Space Station (ISS) will draw to a close by 2020, redeployment options are explored and contrasted for ISS components in the post-2020 timeframe. Low Earth Orbit (LEO) redeployment options explored include a depot assembly facility and a refueling facility.

Beyond LEO redeployment options explored include an assembly and refueling facility at the Earth-Moon L1 Lagrange point, a solar observing and / or energy collection facility at the Earth-Sun L1 Lagrange point, an astronomical observation facility at the Earth-Sun L2 Lagrange point, a lunar orbiting facility, and a Martian orbiting facility. The cost of boosting ISS components to new orbits is considered as part of the study of these latter options, as is any retrofit or modification of components required by these new missions. Logistics requirements are also included in the cost of each option.

All architectural options are analyzed using Living Systems Theory [Miller, 1978] and the Hatley-Pirbhai context diagram template. Technical risk and maturity is analyzed, and a parametric cost model is developed. Cost benefit analyses are performed for each of the selected redeployment missions using Pugh matrix and quality functional deployment (QFD) methodologies for an overall recommendation based on the currently enunciated goals as described by the 2009 Augustine Commission on human space flight (HSF).

Keywords: International Space Station, ISS, Systems, Architecture, Design, Optimization, Living Systems Theory, Hatley Pirbhai, quality functional deployment, QFD, human space flight, HSF, depot assembly, refueling, L1, L2, Lagrange points, Earth-Moon, Earth-Sun, solar, astronomical, observations, solar energy, lunar, Martian, orbiting facility.

PACS: 01.78.+p, 07.05.Fb, 07.87.+v, 95.10.Ce, 95.40.+s, 95.45.+i

1 INTRODUCTION.....	3
1.1 CURRENT ISS CONFIGURATION	3
1.2 CURRENT ISS MISSIONS	5
2.0 A STUDY OF REDEPLOYMENT OPTIONS.....	6
2.1 HSF GUIDANCE FOR FUTURE MISSIONS.....	6
2.2 LEO REDEPLOYMENT MISSION OPTIONS	8
2.3 REDEPLOYMENT MISSION OPTIONS BEYOND LEO	9
3.0 THE APPLICATION OF LIVING SYSTEMS THEORY (LST) TO THE ISS.....	11
3.1 BASICS AND HISTORY OF LST	11
3.2 THE LST CATEGORIZATION OF HUMAN SPACEFLIGHT ACTIVITIES	13
3.3 THE APPLICATION OF LST TO CURRENT ISS	14
3.4 THE APPLICATION OF LST TO POSSIBLE FUTURE HSF MISSIONS	16
3.5 LST FUNCTIONAL REQUIREMENTS FOR LEO MISSIONS	17
3.6 LST FUNCTIONAL REQUIREMENTS FOR BEYOND-LEO MISSIONS.....	19
3.6 THE HATLEY-PIRBHAI FUNCTIONAL ARCHITECTURE TEMPLATE.....	20
4.0 ARCHITECTURAL COST VERSUS BENEFIT TRADEOFFS	23
4.1 TECHNICAL RISK AND MATURITY CONSIDERATIONS	24
4.2 COST MODELING.....	25
4.3 PUGH MATRIX METHODOLOGY.....	29
4.4 QUALITY FUNCTIONAL DEPLOYMENT (QFD) METHODOLOGY	30
5.0 CONCLUSIONS.....	32
5.1 RECOMMENDATIONS FOR ISS REDEPLOYMENT	33
5.2 GENERAL UTILITY OF APPLYING LST	33
5.3 GENERAL RECOMMENDATIONS FOR FURTHER STUDY.....	34
5.4 SPECIFIC RECOMMENDATIONS ARISING FROM THIS STUDY	34
ACKNOWLEDGEMENTS	34
REFERENCES.....	35
APPENDIX A.....	36
APPENDIX B, SOLAR WIND POWERED INFRASTRUCTURE	41
B.1 FUNDAMENTALS OF THE DYSON-HARROP SOLAR WIND POWER (SWP) GENERATION CONCEPT	41
B.2 FLEET ORIENTATIONS FOR THE DYSON-HARROP SOLAR WIND POWER (SWP) GENERATION CONCEPT	42
B.3 COUPLING POWER / INFORMATION FROM THE DYSON-HARROP SWP GENERATOR FLEET TO THE ISS FLEET.....	43
APPENDIX C, ASTROGATOR NAVIGATION STATUS DISPLAY FOR INTERPLANETARY TRAVEL	47
C.1 BACKGROUND, STATEMENT OF NEED, AND REQUIREMENTS DEVELOPMENT	47
C.2 PRESENTATION DESIGN DEVELOPMENT	49

1 Introduction

The International Space Station (ISS) is the name given to the only human populated research station currently in space. Presently it is the largest artificial satellite to ever orbit the Earth and is the most expensive object constructed in modern human history. [1,2] Despite this enormous investment, current plans call for deorbiting the space station at the end of life sometime after 2020. The purpose of this paper is to explore other possibilities for reuse of the space station's components to preserve some of the residual value of these on orbit assets, and to explore the costs versus the benefits of doing so.

We start first with an overview and analysis of the current ISS configuration, and the missions the ISS currently serves. Based on current Human Space Flight (HSF) direction future missions are delineated, including missions within and beyond Low Earth Orbit (LEO). The costs versus benefits of servicing each of these missions is explored and analyzed. Integral to this analysis is the notion that, as a populated space station, the ISS is in essence a living system. Therefore Miller's Living Systems Theory (LST) may be brought to bear in the functional decomposition and analysis of current missions and future missions, so that an optimum reuse solution may be achieved.

Without yet exploring Living Systems Theory in detail, one may readily conclude that it is a far preferable outcome, from a utilitarian standpoint alone, to see the ISS "reproduce" by fracturing into multiple populated living spaces, than it would be to see it "die" by deorbiting and burning up during reentry. While the latter case is the current baseline and program of record, a case is made here in support of the former outcome.

1.1 Current ISS Configuration

The International Space Station (ISS) is an aggregated assembly of pressurized modules, solar panels, exposed external labs, and external robotic arms, all supported by an extensive integrated truss structure. From the one end of the outer most module to the other end the ISS extends some 50 meters in length, and along the truss with the solar panels extended, over 100 meters in width. It has an on orbit mass of over 800,000 lbs, and provides roughly 30,000 cubic feet of pressurized volume. See figure 1.1-1 for an assembly view of the various modules, truss structures, and supporting systems.

From a staffing perspective, it is the pressurized volume that is the precious resource. In the functional sense, the rest of the ISS is there to feed that small volume with the power, data, air, water, and food needed to support a continuing human presence in space, a full time staff of 6 plus any visitors. This volume is divided by the pressurized modules that compose it, 14 of which are now on orbit, with another two planned for launch that will conclude the complete assembly of 16 pressurized modules constituting the original ISS. Of these 16 modules, 7 will have been supplied by the USA, 6 by Russia, 2 by Japan, and 1 by Italy on behalf of the European Space Agency.

The ISS has been under construction since 1998, and is scheduled for completion in 2011. The Russians supplied the first module, the *Zarya* (M1), which provided stationkeeping, solar power, and crew quarters during assembly, and is now used for storage. In this paper each module is designated with a module

number, “M#”, assigned in order of launch date. Other Russian modules include the *Zvezda* (M3), used as a crew residence, the *Pirs* (M6), a docking compartment used as a secondary airlock, the *Poisk* (M11) and *Rassvet* (M14), both of which are Mini Research Modules and are used as docking sites and cargo storage, and the last to be added will be the *Nauka* (M16), which will provide additional crew rest and work space.

The USA supplied the *Unity* (M2) module, a volumetric node connector, the *Destiny* (M4), the US Lab, the *Quest* (M5), the primary airlock for the ISS, the *Harmony*, (M7) a utility hub that provides for berthing, the *Tranquility* (M12) that provides advanced life support systems, the *Cupola* (M13) that provides observations windows, and the last US module to join will be the *Leonardo* (M15), which will provide for additional storage. The US also provided the entire Integrated Truss Structure, and unmanned but critically important structural component of the ISS that joins solar panels and cooling panels to the habitation modules.

Additional lab modules were supplied by Japan and ESA. Japan supplied the *Kibo-I* (M9) and *Kibo-II* (M10), and ESA provided the *Columbus* (M8).

Due to differing docking mechanisms, the Russian modules are all assembled together at one end, and the USA, Japanese, and ESA modules are all assembled together at the other end. The two sides are joined by PMA-1 pressurized module adapter. Figure 1.1-1 summarizes the current ISS configuration.

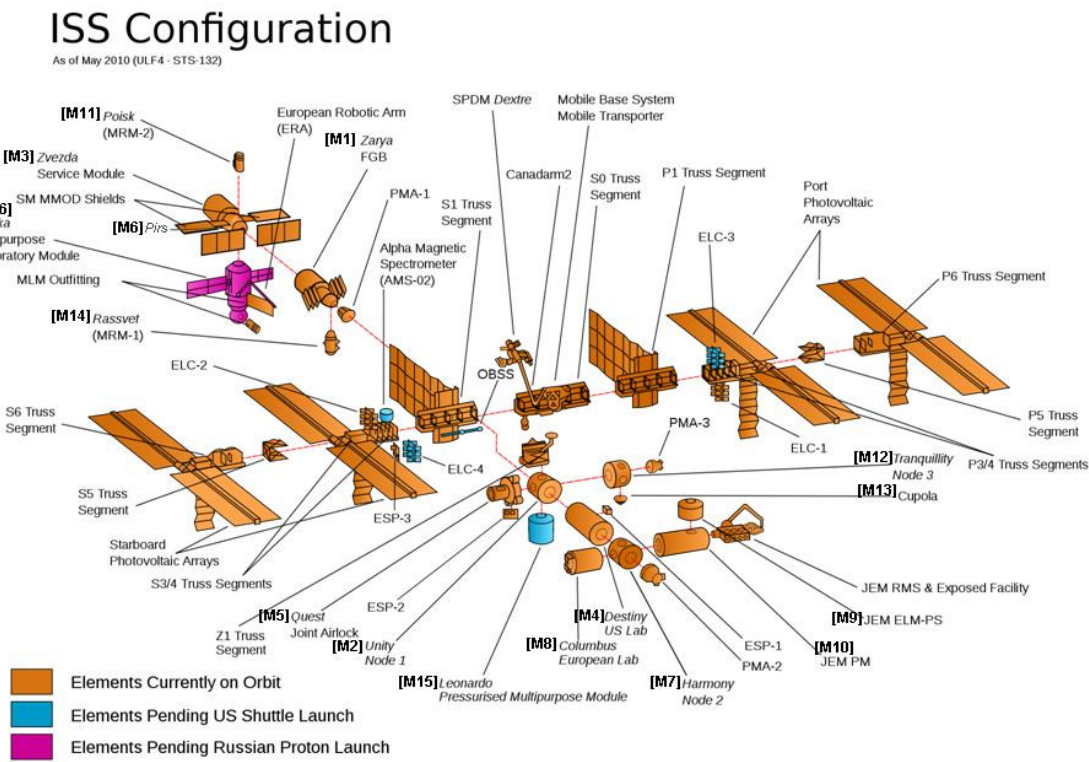

Figure 1.1-1, ISS Configuration [2], with Module numbers added by author

1.2 Current ISS Missions

For the purposes of this paper, it is taken as axiomatic that human space flight a worthy goal in and of itself – a transformative expansion of human perspective that can not occur any other way, and can not be provided by any other form of exploration. Human space flight alone is therefore a necessary and sufficient condition for the existence of staffed space stations in general, and the ISS in particular. To restate more succinctly:

Axiom 1: Human space flight is uniquely beneficial to the human race.

The development and testing of human spaceflight technology is therefore also a rationale for the continued operation of the ISS, as it is an ideal testbed for the exploration of incremental improvements in the reliability and autonomy of HSF equipment.

If we further assume that exploration of our universe is a step worth taking, in either a manned or unmanned sense, we will see later in this paper that opting for a manned approach allows for a more dynamic control of a mission than opting for an unmanned approach. In a control systems sense it is a response bandwidth problem: to close a control loop of a certain bandwidth, a certain response time is required. Because the response time to any input is limited by the time of flight of a signal to cover the round trip distance, where $2d = ct$, time t will always limit the response time of a control loop, and therefore limit how far away the controller can be from an event for a given bandwidth requirement. We will refer to this problem in this paper as the “CT Problem,” and it drives us to a requirement that for a given level of dynamic control, a given controller with the requisite dynamic flexibility must be within a certain distance of that which is being controlled. In some cases this can be handled robotically via autonomous systems; in some cases this may mean having a human in orbit near robotic operations. Philosophically, one may argue that given sufficient control bandwidth, there will always be cases under which human control and judgment provides superior decision making over autonomous operations alone, and therefore provides superior risk reduction capability, a hidden dimension needed for mission success. In other words exploration is something we are good at. This may also be restated axiomatically:

Axiom 2: Human judgment and control is uniquely beneficial to space exploration.

In addition to human exploration there is the pursuit of science and technology for its own sake. Current science related missions of the ISS include space science, space technology development, and the study of human physiology in space. The Destiny lab, the Columbus lab, and the Kibo labs are all fully devoted to these pursuits, and the Poisk, Rassvet, and soon the Nauka are or will be devoted in part to laboratory activities.

Space science activities include the atmosphere to space boundary studies, space environment studies, crystal growth studies, X-ray astronomy, stratospheric chromatography, and hyper-spectral remote sensing, to name but a few. Technology studies include combustion science, fluid science, space exposure testing, various biotechnology studies, and new life support systems checkout. The ISS supports all of these activities with a level of dynamic flexibility that would be impossible without a manned presence.

The current status of the ISS, per the Augustine Commission, may be summed up as follows: “In summary, it does not appear that either mothballing the ISS or ending U.S. participation is a viable option, and keeping the Station occupied is very expensive.” [3]

2.0 A Study of Redeployment Options

This section describes an approach and rationale for selecting possible future missions for a redeployed ISS. The HSF direction in this section draws heavily on the guidance suggested by the 2009 US Human Spaceflight Plans Committee, otherwise known as the Augustine Commission, in their final report entitled “Seeking a Human Spaceflight Program Worthy of a Great Nation.” [3]

This section is organized into three parts: 2.1 provides a summary of HSF guidance from the Augustine commission, 2.2 focuses on exploring new LEO missions not yet performed by the ISS, but which elements remaining in LEO could be drawn on to perform, and 2.3 focuses on the expansion of human spaceflight activity beyond LEO orbit, and how ISS components could possibly be adapted and transported to these new mission areas.

2.1 HSF Guidance for Future Missions

An overriding goal of the human race is survival of the race itself. So long as we are a race residing on a single planet there will always be some small probability of a cataclysmic event disrupting it’s ecosystem to such an extent that the support of human life is no longer possible. Should this misfortune ever befall us the survival of the race will depend on whether or not we have a sustainable and reproducing presence on other planets. Admittedly this prospect is a long term one, but it is taken here to be valid. It is restated as our third and final axiom of spaceflight:

Axiom 3: The ultimate goal of human spaceflight is the survival of the human race via expansion.

Here we use the term “human race” in the broader sense of all races that derive their lineage from us, the homo sapiens of the planet Earth. Genetic adaptation to off world environments could over time trigger racial variants of unimaginable diversity, dwarfing the relatively homogenous variations we have today.

What near term goals have already been developed that would support this ultimate goal? There are many astronomical goals, such as the search for inhabitable planets, that could be taken as supporting this ultimate goal, but the focus here is only on those goals that human spaceflight itself is tasked with achieving.

Near term goals for human spaceflight have only recently been subject to revision. Under the direction of a new administration, in 2009 the Augustine Commission was formed to redefine and delineate a number of go forward HSF guidance options from which the US Administration could draw.

In addition to the expansion of LEO missions in support of non-LEO operations, such as providing for a

depot assembly facility, and possibly a refueling facility, the Augustine Commission outlined HSF expansion options that would travel beyond LEO. The fifth option, the “flexible path” option was selected by NASA and the administration [4], and was summarized by the Augustine Commission as follows:

“A Flexible Path to inner solar system locations, such as lunar orbit, Lagrange points, near-Earth objects and the moons of Mars, followed by exploration of the lunar surface and/or Martian surface.” [3]

Because this now represents the official HSF guidance as directed by the US Administration [4], the details of this option will be used in this paper as criteria for judging the value of ISS redeployment options. The non-LEO mission destinations represented by the flexible path option are as follows [3]:

- 1) Lunar Orbit
- 2) Earth-Moon Lagrange point 1 (EM L1)
- 3) Earth – Sun L2 (ES L2)
- 4) Earth – Sun L1 (ES L1)
- 5) NEO Destination (such as an asteroid)
- 6) Mars Orbit

This HSF guidance can be used to judge how best to optimize the redeployment of the ISS in the context of how the ISS or components of the ISS could support missions in the above locations. Later in this paper we will investigate these questions through a study of cost vs. benefit for each of these future mission / redeployment options, and through a description of how ISS components might help each one.

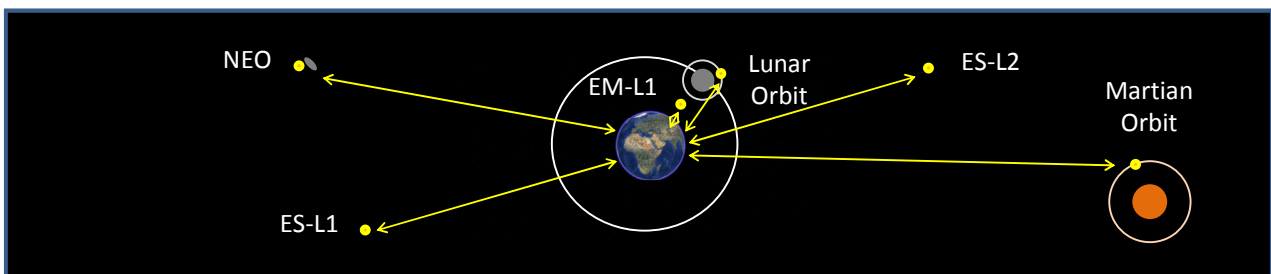

Figure 2.1-1, Flexible Path Future Missions, adapted from [3]

2.2 LEO Redeployment Mission Options

Given the vision for a future including beyond LEO manned missions, let us first consider what missions might remain in Low Earth Orbit that would enable such missions. If the ISS were to be split, with a portion of it to be redeployed to beyond LEO areas, to what purpose would the remaining portion of the ISS be applied? The first possible use is as a refueling and fuel transfer facility. Assuming the use of chemical rockets, the effort needed to reboost repurposed portions of the ISS to new operational venues will require significant rocket fuel, and it would be advantageous to use commercial lift vehicles to get it on orbit. Because no on commercial vehicle is currently capable of carrying the mass of fuel that will be required to reboost modules to lunar orbit, Martian orbit, or even to Lagrange points of interest, it would be highly advantageous to launch partial fuel loads, and aggregate them by refueling on orbit for trans-lunar, trans-Lagrangian, or trans-Martian injection burns for relocating repurposed components of the ISS. The ISS could host such activity, before and after any division of the modular living quarters.

Hand in hand with a refueling effort would be an equivalent on orbit assembly effort, where smaller spacecraft could be aggregated into larger assemblies for deeper space missions to extra terrestrial orbits or to other near Earth orbit (NEO) locations. Such an on orbit assembly depot has in essence been a major mission of the ISS for most of its operational life in any case, since it provided a home for the astronauts (and cosmonauts) as they expanded and assembled the station in which they resided. Conceptually this effort would be quite different from past assembly activities, as the assembly on which they were working would ultimately become a separate craft destined for a different mission location. But in practice it may not be that different: modules and other new orbited components could be temporarily attached to the ISS via airlocks. Through a process of aggregation, nucleation, and then separation, human space flight living quarters could duplicate single cell division, akin to mitosis, where the environmentally conditioned living quarters supports human life rather than protoplasm, and pressurized modules form the equivalent of a cell membrane. This suggests an analogy of the ISS as a living system, an analogy that will be more fully explored in section 3.

Although the subject and scope of the present paper is solely the repurposing and redeployment of the existing ISS, we would be remiss were we not to touch on several emerging concepts, including nationalized concepts from the Russians and Chinese, and a commercial offering from Bigelow Aerospace. The first such concept, named the Orbital Piloted Assembly and Experiment Complex (OPSEK) [5], was first conceived by the Russians as a way to reuse their ISS modules so as to avoid their destruction when the rest of the ISS was to be retired in 2015. The Russian concept was to convert their modules into a refueling and assembly depot, and possibly also reposition the OPSEK station into a higher inclination orbit so as to allow its use for remote sensing of the Russian territories. Now that plans are underway to extend the life of the ISS to 2020 and beyond, this concept bears revisiting, as their modules may be among those that make the most sense to redeploy.

In terms of commercial offerings, Bigelow Aerospace has been working on developing an innovative soft sided module design with integrated environmental control and life support systems that could easily backfill missing mission elements in LEO orbit that would be lost to beyond LEO redeployment. [6] Bigelow's latest product designs include the *Sundancer* (SD2), suitable for housing 6 astronauts short term or 3 astronauts long term, and the *BA330*, which would be capable of housing 6 astronauts for long

term missions. These modules could certainly be used to replace heritage modules sent elsewhere, while using the remaining heritage module for backup life support in the event of a failure of the newer less proven Bigelow system. This pairing of new technology docked to more proven technology will be a recurring theme in the recommendations springing from the use of living systems theory in the paper.

Finally, recent press coverage indicates that the Chinese have plans to deploy the first module of their own permanent space station, the name of which translates as “the heavenly palace.” [7] How palatial it will be remains to be seen, but there may be benefits to allowing these newly minted Chinese modules to dock with the LEO remainder of the ISS, in that they defer the cost of the additional backfill quarters while still providing redundancy and expanded living volume. The ISS, in turn, would provide risk reduction for these untested modules in that it could provide for evacuation of astronauts (or taikonauts) into the heritage portion of the ISS without the immediate need to return to Earth in the event of a life support systems failure. This could enable on-orbit repair opportunities.

2.3 Redeployment Mission Options Beyond LEO

While there is still some debate within the US Administration as to the proper path for HSF to follow, for the purposes of this paper we will assume unwavering support for “Option 5” as described in the Augustine Commission’s final report, namely that of a “Flexible Path,” [3] already outlined in section 2.1. Here we study the missions described in this option in further detail, and explore the requirements highlights for each, in particular the locations, occupancy requirements, and visit frequency for each mission.

Assumption 1: Our near term guidance for HSF activities is Option 5 of the Augustine Commission Final Report, the Flexible Path Option.

Let us further assume that regardless of whether we reuse pieces of the original ISS, or we fulfill the requirements of these missions with equipment designed from scratch, each effort beyond LEO will have some international involvement, so as to build international trust in our peaceful use of space and our approach to the heavenly bodies as shared resources..

Assumption 2: Human spaceflight missions beyond LEO in support of the Flexible Path Option will be of an international scope.

This being taken as an assumption, we are safe to proceed with the development of missions defined to be part of the flexible path approach. This is also important in that it allows us the option of reusing all ISS modules without regard to their source. Let us now suppose that a portion of the current ISS will remain in Low Earth Orbit, and relabel that new version of the LEO station as ISS1. We may then label other human staffed stations supporting the flexible path as “international space stations” as well, and in this paper we will also number them in accordance with the order of their creation and occupancy.

It is a matter of record [6,8,9] that the required living volume is a function of mission duration. The longer the duration of the mission, the larger the required living volume each astronaut will need. While the crew exploration vehicle (CEV) is, at least by design, a suitable transportation craft, it should be properly called a crew transportation vehicle, as it is suitable for space transportation of days, but not weeks, in

duration. Proper NEO or Martian exploration vehicles will need much larger per occupant volumes commensurate with their mission duration and crew size. Likewise, other “destinations” will necessarily require volumes in accordance with staffing levels and the time staff members will be spending in each location, a function of both visit periodicity and duration. One may therefore assume from this discussion that any flexible path mission location that requires long term human habitation will therefore require an ongoing living volume, or space station, even if it is actually occupied only a small percentage of the time. Restating as an additional assumption:

Assumption 3: Human spaceflight missions beyond LEO in support of the Flexible Path Option will require space stations.

For purposes of requirements development and design consideration we now propose a list of beyond LEO stations in support of the HSF flexible path, the first of which will be a station in lunar orbit:

ISS2: Lunar Orbital Station. Mission capabilities: lunar remote sensing, lunar communication relay, lunar navigation relay, refueling of robotic surface probes, resupply for robotic surface operations, extraction and testing of lunar samples, development testbed for low maturity technologies needed for Martian missions, periodic full time occupancy with an expected crew of 3.

Three Lagrange points were also highlighted by the Augustine Commission as being especially useful in support of the flexible path, and are listed here in the probable order of development:

ISS3: Earth–Moon Lagrange Point 1 (EM-L1) Station. Mission capabilities: gravitational potential “on ramp” to interplanetary highway, assembly and refueling point for manned and unmanned planetary probes, testbed for the use of quasi-periodic Lissajous orbits for station keeping [18], launch and return point for NEO missions, possible launch and return point for Martian missions. Expected occupancy is infrequent, during periods of refueling and final assembly for interplanetary and deep space missions. Crew could be 3 to 6 persons, depending on the mission being supported.

ISS4: Earth-Sun Lagrange Point 1 (ES-L1) Station. Mission capabilities: solar observation, solar energy collection and conversion, fuel generation and transfer, infrequent occupation during fuel transfer operations and service calls by a crew of 2.

ISS5: Earth–Sun Lagrange Point 2 (ES-L2) Station. Mission capabilities: deep space observatory assembly and operation, infrequent occupation during assembly, instrument changes, and service calls by a crew of 2.

ISS6: Martian Orbital Station. Mission capabilities: Martian remote sensing, comm., nav relay, refueling of robotic surface vehicles, resupply for surface ops, full time periodic occupation with a crew of 4 to 6.

This list of space stations would indicate a fully developed mission set as described in the flexible path option of the Augustine Committee. Success in the development and deployment of these missions, in conjunction with a successful manned lunar surface mission would, when taken together, be a necessary and sufficient prelude to any rationale attempt at a manned Martian surface landing mission.

How could we best apply our current ISS resources in support of these future missions? We study criteria for judging ISS assets in section 3, explore the trade space in section 4, and draw conclusions about how best to optimize our reuse and redeployment opportunities in section 5, our conclusion.

3.0 The Application of Living Systems Theory (LST) to the ISS

In the previous section the range of HSF mission that constitute possible targets for ISS component redeployment were explored. However, the issue of how to select particular modules for particular redeployment missions remains. Criteria are needed to sort and categorize the various ISS modules to best align them with new mission objectives and the functionality called for by these new mission objectives. The development of these mission assignment criteria is the goal of this section.

The first and primary tool used in this paper for ISS module characterization is Living Systems Theory, (LST.) [10,11] After a review of LST in 3.1, LST categories as they apply to HSF are discussed in 3.2, the application of LST categories for the current mission are described in 3.3, and the application of LST categories to future “flexible path” missions are covered in 3.4. The functionality of a hypothetically fractured ISS is studied on both sides of such a split, first for the initial portion of the ISS remaining in LEO, in 3.5, and for the initial portion first redeployed to beyond LEO missions, in section 3.6. Finally, the utility of an additional level of functional analysis is explored in 3.7 using Hatley-Pirbhai (HP) context diagrams to assist with a finer grain analysis of current and future HSF mission needs.

To summarize, the goal of this section is to apply LST categories to ISS modules and to future missions, and then match ISS components with those LST categories that address each mission.

3.1 Basics and History of LST

Living Systems Theory (LST) was first introduced by James Grier Miller in his seminal work, *Living Systems* (1978.) [10] LST was initially proposed to describe and help categorize the functionality of biological subsystems. However subsequent work with LST categories has discovered that the use of these functional categories has utility beyond what would classically be understood as “living” systems. For instance work with LST functional categories has already been applied to human spaceflight in general and the ISS in particular, by Miller himself in 1987. [12] That work formed the initial basis of and precedent for the present paper.

Table 3.1-1 presents the LST categories as they are currently understood. [10,11] Miller had initially conceived of and introduced a formal symbology set [12] that included a different symbol for each functional category, so that schematics of living systems might be created, but such schematics were too obscure to ever find widespread use. Therefore we introduce a set of 3 letter abbreviations, or trigraphs, also shown in table 3.1-1, which will be used throughout the remainder of this paper to represent these categories in block diagrams, schematics, and flowcharts. They are designated with capital letters in square brackets, as in the example [PRD].

LST subsystem categories are of these three types: subsystems that process matter and energy, subsystems that process information, and subsystems that process both matter-energy and information. One may readily observe the utility of such categories to the ISS, as they are useful for mapping the flows

of matter, energy, and information into the ISS, throughout the truss structure and modules of the ISS, and back out of the ISS. To some extent we see all of these processes in play with any manned system, but they are especially appropriate for highly isolated and well defined systems such as a space station or space exploration vehicle. Why use LST categories at all? The short answer is because a staffed facility is a living thing, an extended version of a life form, and in that very real sense there is utility in this form of functional analysis, as we will see in the remainder of section 3.

Table 3.1-1, LST categories [10,11]

SUBSYSTEMS WHICH PROCESS BOTH MATTER-ENERGY AND INFORMATION	
[REP]	<i>Reproducer</i> , the subsystem which carries out the instructions in the genetic information or charter of a system and mobilizes matter and energy to produce one or more similar systems.
[BND]	<i>Boundary</i> , the subsystem at the perimeter of a system that holds together the components which make up the system, protects them from environmental stresses, and excludes or permits entry to various sorts of matter-energy and information.
SUBSYSTEMS WHICH PROCESS MATTER-ENERGY	
[ING]	<i>Ingestor</i> , the subsystem which brings matter-energy across the system boundary from the environment.
[DST]	<i>Distributor</i> , the subsystem which carries inputs from outside the system, or outputs from its subsystems around the system to each component.
[CNV]	<i>Converter</i> , the subsystem which changes certain inputs to the system into forms more useful for the special processes of that particular system.
[PRD]	<i>Producer</i> , the subsystem which forms stable associations that endure for significant periods among matter-energy inputs to the system or outputs from its converter, the material synthesized being for growth, damage repair, or replacement of components of the system, or for providing energy for moving or constituting the system's outputs of products or information markers to its suprasystem.
[STR]	<i>Matter-energy storage</i> , the subsystem which places matter or energy at some location in the system, retains it over time, and retrieves it.
[EXT]	<i>Extruder</i> , the subsystem which transmits matter-energy out of the system in the forms of products or wastes.
[MOT]	<i>Motor</i> , The subsystem which moves the system or parts of it in relation to part or all of its environment or moves components of its environment in relation to each other.
[SUP]	<i>Supporter</i> , the subsystem which maintains the proper spatial relationships among components of the system, so that they can interact without weighting each other down or crowding each other.
SUBSYSTEMS WHICH PROCESS INFORMATION	
[INT]	<i>Input transducer</i> , the sensory subsystem which brings markers bearing information into the system, changing them to other matter-energy forms suitable for transmission within it.
[ITL]	<i>Internal transducer</i> , the sensory subsystem which receives, from subsystems or components within the system, markers bearing information about significant alterations in those subsystems or components, changing them to other matter-energy forms of a sort which can be transmitted within it.
[NET]	<i>Channel and net</i> , the subsystem composed of a single route in physical space or multiple interconnected routes over which markers bearing information are transmitted to all parts of the system.
[TIM]	<i>Timer</i> , the clock, set by information from the input transducer about states of the environment, which uses information about processes in the system to measure the passage of time, and transmits to the decider signals that facilitate coordination of the system's processes in time.
[DCD]	<i>Decoder</i> , the subsystem which alters the code of information input to it through the input transducer or internal transducer into a "private" code that can be used internally by the system.
[ASC]	<i>Associator</i> , the subsystem which carries out the first stage of the learning process, forming enduring associations among items of information in the system.
[MEM]	<i>Memory</i> , the subsystem which carries out the second stage of the learning process, storing information in the system for different periods of time, and then retrieving it.
[DEC]	<i>Decider</i> , the executive subsystem which receives information inputs from all other subsystems and transmits to them outputs for guidance, coordination, and control of the system.
[ECD]	<i>Encoder</i> , the subsystem which alters the code of information input to it from other information processing subsystems, from a "private" code used internally by the system into a "public" code which can be interpreted by other systems in its environment.
[OUT]	<i>Output transducer</i> , the subsystem which puts out markers bearing information from the system, changing markers within the system into other matter-energy forms which can be transmitted over channels in the system's environment.

3.2 The LST Categorization of Human Spaceflight Activities

In his work “Applications of Living Systems Theory to Life in Space” [12] James Miller discussed applying the five flows, or transmissions, in living systems to spaceflight. Those five flows are matter, energy, information, people, and money. From an engineering point of view, for the present purposes we will ignore two of these flows, the first of which is people flows, which are of more interest to operational planners. For present purposes “people flows” will be understood to at some point simply to occupy all airlocks and all pressurized modules. The second type of flow that will be ignored is the flow of capital, or what Miller simply calls “money flow.” While this is of enormous interest to NASA and other international agencies and treasuries from a financial planning point of view, it is beyond the scope of the present paper, except in the cost and benefit analysis of redeployments in the support of the flexible path missions.

Given that we are ruling out people and capital flows, the only remaining flows of engineering interest are the matter flows, the energy flows, and the information flows. Let us first study the matter flows. Matter will enter the ISS or any redeployment of fractional portions of the ISS via the category of ingestion [ING]. Ingestion may occur in two different ways: from an exterior point of view new assemblies that arrive on orbit are attached or aggregated via either robotic control from the interior of the ISS [MOT], or via human intervention [PRD] using spacewalks to connect new elements to the exterior support structure [SUP]. The second type of ingestion occurs from within an airlock, in the case where matter is intended to be deployed and distributed [DST] within the pressurized volume of the ISS module set.

Matter may also be expelled, or in the parlance of LST, extruded [EXT]. Extrusions may be of any phase, and range from returned experimental apparatus that is sent out on otherwise empty return trips of supply vessels, to the gaseous release of waste products from air treatment processes.

Energy flow may be treated similarly. In this case energy is ingested for instance in the solar panels, and is converted [CNV] to electricity, is distributed [DST] to energy users throughout the station, and the waste heat not converted to useful work is collected via circulating coolant and is expelled through radiative panels that transfer energy via thermal photon radiation directly into space [EXT]. Energy may also be stored, [STR] in batteries or in the form of propellant, and may be applied for motor related activities [MOT], for instance in attitude control and station keeping.

Let us now turn to an analysis of information flow through the ISS, which is treated by the second group of LST categories, information categories, of which the author suggests also simultaneously represents a categorization of communication functions. After all, how does information get in and out of the ISS other than communication? Communication represents the on board and off board flow of information. Therefore we understand the information categories to include telecommunications as well, where receivers are understood to represent special cases of input transducers [INT], and transmitters are understood to represent special cases of output transducers [OUT]. Within the ISS the on board information flows over a network [NET], regulated by a clock or timer [TIM]. Internal housekeeping data may be added into the data stream via internal transducers [ITL], and for instance analog data may be ingested into digital via decoders [DCD] or created from digital via encoders [ECD]. Association [ASC]

may be preprogrammed in advance via software code, or may be determined in realtime via a human presence [DEC].

It is worth pausing at this point to recognize the special role the human has in the activity of human spaceflight. The human is an extension of a productive presence [PRD] in the domain of matter and energy, and represents a local deciding presence [DEC] in the information domain. The human presence is tying together both the mass-energy dimensions and the information dimensions at the “cognitive peak” of mass-energy and information control loops by simultaneously fulfilling both the roles of producer [PRD] and decider [DEC]. Because of the data bandwidth communicated and then time criticality of that data, or control bandwidth, a local presence for the control loops of all of these dimensions (mass, energy, and data) is the main contribution of a human presence in space exploration, and is an additional rationale for the inclusion of the local in situ human element in spaceflight activities. This area could benefit from further study by quantifying the impact of [PRD] and [DEC] roles on needed control loops in HSF mission control areas with and without a local human presence. To some extent this is done at the high level of overall benefits in section 4.

Finally we discuss the two LST categories, those that process both matter-energy and information. The first of these is the boundary [BND], the dividing line that separates any system’s interior from its exterior. This is important from a matter-energy point of view in that it delineates and defines what constitutes system structures and energy content from external structures and energy sources. From an information point of view it divides the information that resides within the system from the information not contained by (or “known by”) the system in question. The second and final category that processes mass, energy, and information is reproduction. For a system to reproduce itself in must reproduce not only the mass and energy it contains, but also the information it contains.

From the point of view of the ISS it has never reproduced, because another ISS has never been manufactured, and if it were, it would not be manufactured solely by the ISS. However one could conceptualize a situation where, were enough components to form a new ISS delivered to and ingested on orbit, and all of the information on orbit was duplicated and put on a new copy of the ISS, the ISS could then be said to have duplicated itself. It is in this very real sense that other space stations could be understood to arise from the one ISS we now have, and this is essentially the topic of the present paper: an on orbit reproduction of the ISS, or a series of reproductions, at the hands of the ISS and offspring of the ISS such as the hypothetical EM-L1 station.

3.3 The Application of LST to Current ISS

In applying the LST categories as they apply to the current mission set underway within the ISS, the approach taken here is to extend LST categorization across all modules to analyze how they support each of the mission objectives. Because the primary mission of the ISS is to support human life on orbit, the LST categories will be our primary means of mission analysis. Let us first analyze the applicability of each LST category to each module. Table 3.3-1 below lists how Matter-Energy processing categories apply to each module, and table 3.3-2 lists how Information-Communication processing categories apply

to each module. Note that not every module supports every LST category. Note also that no one module by itself supports the reproduction category. For convenience we list [REP] and [BND] with matter – energy categories.

Table 3.3-1, ISS Modules versus Matter-Energy LST categories

Ref#	Module Name	Alt Description	Reproducer [REP]	Boundary [BND]	Ingestor [ING]	Distributor [DST]	Converter [CNV]	Producer [PRD]	ME Storage [STR]	Extruder [EXT]	Motor [MOT]
M1	Zarya	First Module, "FGB"		pressurized containment	solar power collection (during assembly)		electrical pwr conversion (during assembly)		Pressurized Storage Compartment, Fuel Storage Tanks		station keeping propulsion (during assy)
M2	Unity	"Node One"		pressurized containment		Volumetric Node Connector					
M3	Zvezda	Service Module		pressurized containment	docking locations	docking locations		Resident Crew	main living quarters		attitude control
M4	Destiny	US Lab		pressurized containment	20" window		environmental systems				
M5	Quest	Joint Airlock		pressurized containment	Primary Airlock for ISS				Spacesuit Storage (EMU & RO)	Primary Airlock for ISS	
M6	Pirs	Docking Compartment		pressurized containment	Secondary Airlock	additional docking ports			Spacesuit Storage (RO)	Secondary Airlock	
M7	Harmony	"Node Two"		pressurized containment	common berthing mechanisms	Utility Hub of the ISS; Common Berthing Mechanisms	electrical power conversion			common berthing mechanisms	
M8	Columbus	Euro Lab		pressurized containment			electrical power conversion				
M9	Kibo - I	JEM-ELM		pressurized containment		power and data distribution	electrical power conversion		laboratory storage		
M10	Kibo - II	JEM-PM		pressurized containment	access to exposed facility	power and data distribution to external facility	power conversion for external facility			exposed facility access	
M11	Poisk	Mini Research Module Two (MRM2)		pressurized containment	Docking Site and Airlock	experimental interface				Docking Site and Airlock	
M12	Tranquility	"Node Three"		pressurized containment		Advanced Life Support System	Advanced Life Support System				
M13	Cupola			pressurized containment	Observatory Module						robotic workstation
M14	Rassvet	Mini Research Module One (MRM1)		pressurized containment	docking site				Cargo Storage Spare Parts & Supplies Storage	docking site	
M15	Leonardo	Press Multi-Purp Mod		pressurized containment							
M16	Nauka	Multi-Purp Lab Mod		pressurized containment	docking site	cargo logistics		Crew Work & Rest Area		docking site	backup attitude and control
Z1	Truss	Integrated Truss Structure			collects solar power via solar panels	Distributes power, heat, comm	converts solar power to electricity			dissipates heat via radiator panels	

Table 3.3-2, ISS Modules versus Information LST categories

Ref#	Module	Alt Description	Input Transducer [INT]	Internal Transducer [ITL]	Network [NET]	Timer [TIM]	Decoder [DCD]	Associator [ASC]	Memory [MEM]
M1	Zarya	First Module, "FGB"			network pop?				
M2	Unity	Node 1							
M3	Zvezda	Service Module			network pop?				
M4	Destiny	US Lab	general experimental inputs		network pop?	lab clock?	general experimental measurements	Primary Research Facility	
M5	Quest	Joint Airlock							
M6	Pirs	Docking Compartment							
M7	Harmony	Node 2			Network Bus Controller	lab clock?			
M8	Columbus	Euro Lab	general experimental inputs		experimental data connectivity	atomic clock ensemble in space	general experimental measurements	Euro Research Facility	
M9	Kibo - I	JEM-ELM	general experimental inputs		network pop?	lab clock?	general experimental measurements	Japanese Research Facility	
M10	Kibo - II	JEM-PM	general experimental inputs		network pop?	lab clock?	general experimental measurements	Japanese Research Facility	
M11	Poisk	Mini Research Module2	experimental interface		network pop?	lab clock?			
M12	Tranquility	Node 3							
M13	Cupola								
M14	Rassvet	Mini Research Module1							
M15	Leonardo	Press Multi-Purp Mod			network pop?				
M16	Nauka	Multi-Purp Lab Mod	general experimental inputs		network pop?		general experimental measurements		
Z1	Truss	Integrated Truss Structure							

3.4 The Application of LST to Possible Future HSF Missions

Let us now look at what LST categories would be required to support new HSF missions. This tells us what modules can be redeployed in support of each future HSF mission, and how specifically we could use each module to meet mission needs. Table 3.4-1 below lists how Matter-Energy processing categories would apply to each new mission, and table 3.4-2 lists how Information-Communication processing categories would apply to each new mission.

Table 3.4-1, Future Missions versus Matter-Energy LST categories

Station#	Mission Name	Mission Description	Reproducer [REP]	Boundary [BND]	Ingestor [ING]	Distributor [DST]	Converter [CNV]	Producer [PRD]	ME Storage [STR]	Extruder [EXT]	Motor [MOT]
ISS1	Ongoing LEO	Depot Assy, Refueling, & Reboosting		X	X	X	X	X	X	X	X
ISS2	Lunar Orbit	Lunar Science, Surface Robotics		X	X	X	X	X	X	X	X
ISS3	EM L1	Interplanetary mission "on-ramp", Assy Hub	X	X	X	X	X	X	X	X	X
ISS4	ES L2	Deep Space Telescope		X	X	X	X	X	X	X	X
ISS5	ES L1	Solar Observatory, Solar Power		X	X	X	X	X	X	X	X
ISS6	Mars Orbit	Martian Science, Surface Robotics		X	X	X	X	X	X	X	X

Table 3.4-2, Future Missions versus Information LST categories

Station#	Mission Name	Mission Description	Input Transducer [INT]	Internal Transducer [ITL]	Network [NET]	Timer [TIM]	Decoder [DCD]	Associator [ASC]
ISS1	Ongoing LEO	Depot Assy, Refueling, & Reboosting	X	X	X	X	X	X
ISS2	Lunar Orbit	Lunar Science, Surface Robotics	X	X	X	X	X	X
ISS3	EM L1	Interplanetary mission "on-ramp", Assy Hub	X	X	X	X	X	X
ISS4	ES L2	Deep Space Telescope	X	X	X	X	X	X
ISS5	ES L1	Solar Observatory, Solar Power	X	X	X	X	X	X
ISS6	Mars Orbit	Martian Science, Surface Robotics	X	X	X	X	X	X

We see from this result that with the exception of the “reproduction” of space stations, every LST category is required by every mission. In retrospect, this should not have been a surprising result, as it is a mark of every life form that each of these functional categories must be satisfied for the life form to continue to exist. However the problem of applying specific modules to specific missions remains, as the LST categories by themselves do not provide sufficient detail to make finer grained determinations to guide module redeployment assignments.

Therefore in the following sections 3.5 and 3.6 we will make a hypothetical split between modules of the ISS that would remain in LEO, and those that would be redeployed in service of beyond LEO missions, and analyze whether the divided portions could serve some subset of these mission areas. Finally in 3.7 we analyze mapping traditional functions and LST functions to Hatley-Pirbhi context diagrams to investigate the utility of adding this level of detail to the functional analysis of the ISS.

3.5 LST Functional Requirements for LEO Missions

In defining what LST categories are needed for the LEO missions, an ideal approach would be to detail specifically what LSTs are needed mission by mission, and what modules are needed to supply given LSTs, to determine what module sets are appropriate for what missions. However as we have seen that merely to support life onboard, essentially all LST categories are required, be the final goal to provide on-orbit depot assembly services or refueling services, or acting as operators for on-going heritage science missions.

So in essence the requirement to supply all LST categories amounts to an inventory or checklist of capabilities that will be required to remain in LEO orbit to support updated LEO operations. One way to start the functional analysis of residual ISS components is to simply try a “what if” scenario of splitting the ISS and see if it works. We take this approach here in 3.5 for the LEO section, and continue the analysis for the beyond LEO section in 3.6.

For the first possible separation into a redeployed and remaining split to the ISS, let us consider the case where the Russian made components are separated from the balance of the ISS. This portion of the ISS is highlighted in figure 3.5. If it is removed will the rest of the space station still in LEO be able to support human occupation to the extent needed for supporting LEO missions?

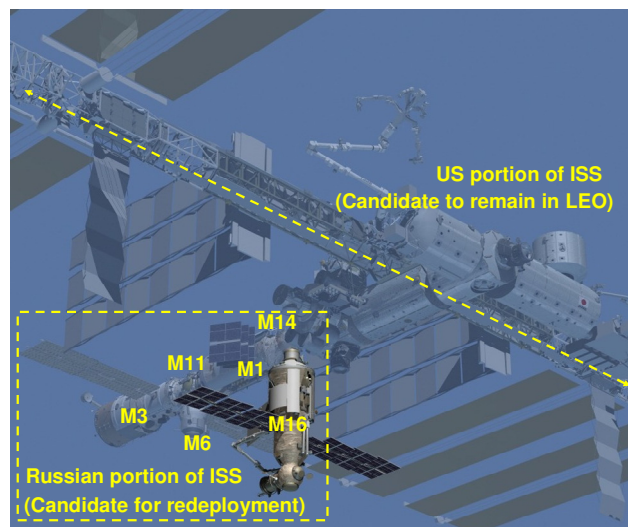

Figure 3.5-1a, Hypothetical First Separation of ISS [10]

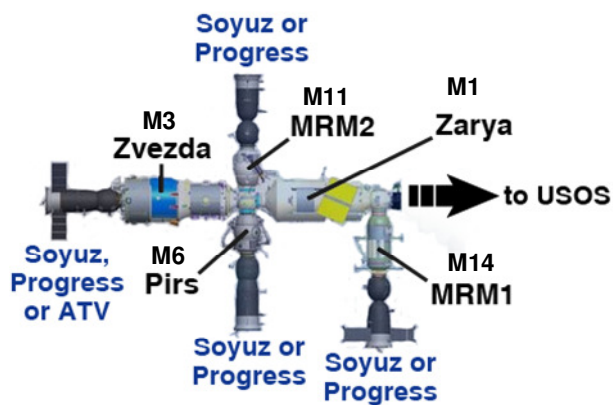

Figure 3.5-1b, Russian Portion of ISS, less M16 [10]

Tables 3.5-1 and 3.5-2 compile post-separation LST functionality for Matter-Energy and Information processing respectively. In the matter-energy category we observe that aside from the reproducer [REP] category, which is uniformly unrepresented in current space structures due to a lack of on orbit manufacturing, the other category that may be under served is the producer [PRD] category, which in this context represents the human element. Most of the permanent crew living quarters are inside the Russian

portion of the station. So if this section is redeployed living quarters are in short supply. Therefore it would be worth investigating backfilling the redeployed sections of the ISS in LEO with less durable less flight worthy commercial solutions to living quarters, such as the Bigelow's Sundancer [6]. Recently released docking interface standards for the ISS [13] would help ease the docking design difficulties suggested by such an approach, and the Sundancer would also benefit from the risk reduction available by docking to a proven space superstructure and living quarters. If problems with the commercial equipment were to develop, the crew could evacuate to the rest of the ISS, making a hybrid approach ideal for low cost commercial space equipment checkout, and providing the needed supplemental crew quarters.

Table 3.5-1, Post-separated LEO-portion of ISS Functionality versus Matter-Energy LST categories

Ref#	Module Name	Alt Description	Reproducer [REP]	Boundary [BND]	Ingestor [ING]	Distributor [DST]	Converter [CNV]	Producer [PRD]	ME Storage [STR]	Extruder [EXT]	Motor [MOT]	Supporter [SUP]
M2	Unity	"Node One"		pressurized containment		Volumetric Node Connector						provides berthing location
M4	Destiny	US Lab		pressurized containment	20" window		environmental systems					
M5	Quest	Joint Airlock		pressurized containment	Primary Airlock for ISS				Spacesuit Storage (EMU & RO)	Primary Airlock for ISS		
M7	Harmony	"Node Two"		pressurized containment	common berthing mechanisms	Utility Hub of the ISS; Common Berthing Mechanisms	electrical power conversion			common berthing mechanisms		provides berthing location
M8	Columbus	Euro Lab		pressurized containment			electrical power conversion					
M9	Kibo - I	JEM-ELM		pressurized containment		power and data distribution	electrical power conversion		laboratory storage			
M10	Kibo - II	JEM-PM		pressurized containment	access to exposed facility	power and data distribution to external facility	power conversion for external facility			exposed facility access		mounting location for external platform
M12	Tranquility	"Node Three"		pressurized containment		Advanced Life Support System	Advanced Life Support System					berthing locations
M13	Cupola			pressurized containment	Observatory Module						robotic workstation	
M15	Leonardo	Press Multi-Purp Mod		pressurized containment					Spare Parts & Supplies Storage			
Z1	Truss	Integrated Truss Structure			collects solar power via solar panels	Distributes power, heat, comm	converts solar power to electricity			dissipates heat via radiator panels		Station Backbone
	Cat Coverage	Check per LST Cat	Needs retrofit for depot assy	X	X	X	X	Needs retrofit for additional crew quarters	X	X	X	X

In the information categories, much of the attitude control systems and navigation & guidance backups of the ISS are in the Russian portion of the ISS, so these functions would be lost were the Russian segment to separate for beyond LEO redeployment. In LST category parlance, the missing ACS functions are missing decider functions [DEC] that are deciding on attitude control. Navigation & guidance functions are also represented in LST categories as an encoding function [ECD].

Table 3.5-2, Post-separated LEO-portion of ISS Functionality versus Information LST categories

Ref#	Module	Alt Description	Input Transducer [INT]	Internal Transducer [ITL]	Network [NET]	Timer [TIM]	Decoder [DCD]	Associator [ASC]	Memory [MEM]	Decider [DEC]	Encoder [ECD]	Output Transducer [OUT]
M2	Unity	Node 1										
M4	Destiny	US Lab	general experimental inputs		network pop?	lab clock?	general experimental measurements	Primary Research Facility				general experimental outputs
M5	Quest	Joint Airlock										
M7	Harmony	Node 2			Network Bus Controller	lab clock?						
M8	Columbus	Euro Lab	general experimental inputs		experimental data connectivity	atomic clock ensemble in space	general experimental measurements	Euro Research Facility				general experimental outputs
M9	Kibo - I	JEM-ELM	general experimental inputs		network pop?	lab clock?	general experimental measurements	Japanese Research Facility				general experimental outputs
M10	Kibo - II	JEM-PM	general experimental inputs		network pop?	lab clock?	general experimental measurements	Japanese Research Facility				general experimental outputs
M12	Tranquility	Node 3										
M13	Cupola											
M15	Leonardo	Press Multi-Purp Mod			network pop?							
Z1	Truss	Integrated Truss Structure										
	Cat Coverage	Check per LST Cat	Upgrade Com?	-N/A-	X	X	X	X	Add computing?	Add Nav, ACS	Add Nav / Guidance	Upgrade Com?

Both the [DEC] and [ECD] categories would need to be supplemented in the remainder of the ISS were the ISS to be divided in the manner proposed.

In summary the LST inventory of tables 3.5-1 and 3.5-2 define the minimum residual capability that remains in LEO through a study of the remaining modules. The requirements for repurposing and retrofitting of modules can also be defined in this manner and could be less expensive than building and launching something from scratch. The cost trades of reusing existing modules versus designing, building, and launching new ones will be studied in section 4.

3.6 LST Functional Requirements for Beyond-LEO Missions

Let us now turn our attention the redeployed portion of the ISS, the other side of the scenario outlined in 3.5. For present purposes we will assume here that of these first six modules separated, all six will make it as far as the EM-L1 Lagrange point, and three of those modules will then further separate to press on for Lunar orbit. This is a portion of a more detailed hypothetical redeployment sequence which will appear in figure 4.1-1 and Appendix A.

If we continue to assume that only the six Russian made modules represent the first wave of redeployed sections, as listed in tables 3.6-1 and 3.6-2, we can inventory the LST categories associated with each module for an overall category coverage picture as summarized on the bottom line of each table. For the matter-energy handling categories in table 3.6-1, it is not surprising to see that the areas of possible shortage in coverage are those that the truss structure would have fulfilled, in particular the areas of support [SUP] and solar power conversion [CNV].

There are some solar panels associated with the Zarya, (M1), Zvezda (M3), and Nauka (M16) when it is added, so it should be a matter of study to determine whether this amount of power would be sufficient to support future redeployment missions of these modules. Support structure should also be studied. While these modules are likely over-engineered for their present use, reboosting loads for climbing orbits should be analyzed against the design of these modules to see if supplemental structure should be added to stabilize the overall assembly during transfer orbit burns.

Table 3.6-1, Post-separated section of Beyond-LEO Redeployed ISS versus Matter-Energy LST categories

Ref#	Module Name	Alt Description	Reproducer [REP]	Boundary [BND]	Ingestor [ING]	Distributor [DST]	Converter [CNV]	Producer [PRD]	ME Storage (STR) [STP]	Extruder [EXT]	Motor [MOT]	Supporter [SUP]
M1	Zarya	First Module, "FGB"		pressurized containment	solar power collection (during assembly)		electrical pwr conversion (during assembly)		pressurized Storage Compartment, Fuel Storage Tanks		station keeping propulsion (during assy)	
M3	Zvezda	Service Module		pressurized containment	docking locations	docking locations		Resident Crew	main living quarters		attitude control	docking locations
M6	Pirs	Docking Compartment		pressurized containment	Secondary Airlock	additional docking ports			Spacesuit Storage (RO)	Secondary Airlock		
M11	Poisk	Mini Research Module Two (MRM2)		pressurized containment	Docking Site and Airlock	experimental interface				Docking Site and Airlock		
M14	Rassvet	Mini Research Module One (MRM1)		pressurized containment	docking site				Cargo Storage	docking site		
M16	Nauka	Multi-Purp Lab Mod		pressurized containment	docking site	cargo logistics		Crew Work & Rest Area		docking site	backup attitude and control	
	Cat Coverage	Check per LST Cat		X	X	X	Add more power?	X	X	X	X	Add more structure?

In the area of information categories, given the planned repurposing of these modules for at least one if not two new missions at the EM-L1 point and in lunar orbit, it is clear that there will have to be

significant hardware rework and software reprogramming of the information systems onboard these modules before such a drastic change in mission could be absorbed. While the allocation of communications equipment has not been clear in the publically available material to which the author has had access, it is inevitable that given the new ranges to Earth there will need to be significant updates to the communications [INT], [OUT] equipment before any redeployment is possible, especially in the area of antenna gain. The network controller [NET] and main on-orbit clock [TIM] will have been left behind in LEO, so provisions will need to be made to add in new networks internally to serve as separate autonomous systems post deployment. New clocks should also be added, and a scheme by which they can be synchronized should be devised so that all timing can be related back to Earth based standards.

The nav and guidance [ECD] will require significant reprogramming, as will the attitude control system [DEC]. Computer power and storage [STR] will need to be improved due to the potentially long time delays in data exchanges expected given the distances involved. Finally, it may be that a small allowance of lab space may be desirable in lunar orbit for in situ analysis, so this would need to be added prior to departure and separation as well. These details are reflected in table 3.6-2.

Table 3.6-2, Separated piece of Beyond-LEO Redeployed ISS versus Information LST categories

Ref#	Module	Alt Description	Input Transducer	Internal Transducer	Network	Timer	Decoder	Associator	Memory	Decoder	Encoder	Output Transducer
			[INT]	[ITL]	[NET]	[TIM]	[DCD]	[ASC]	[MEM]	[DEC]	[ECD]	[OUT]
M1	Zarya	First Module, "FGB"			network pop?					nav / guidance during assembly	Nav / Guidance	
M3	Zvezda	Service Module			network pop?					attitude and orbit control		
M6	Pirs	Docking Compartment										
M11	Poisk	Mini Research Module2	experimental interface		network pop?	lab clock?						experimental interface
M14	Rassvet	Mini Research Module1	general experimental inputs				general experimental measurements			backup attitude control system		general experimental outputs
M16	Nauka	Multi-Purp Lab Mod	general experimental inputs		network pop?							
Cat Coverage	Check per LST Cat	Upgrade Com?	-N/A-	Upgrade Net	Add Clock?	X	Add lab?	Add computing	Reprogram	Reprogram	Upgrade Com?	

This process could be duplicated for other ISS divisions and deployment scenarios.

3.6 The Hatley-Pirbhai Functional Architecture Template

The Hatley-Pirbhai diagram may be used to further organize functional concepts, including Living System Theory (LST) functions, for a more coherent utilitarian view of how functions interrelate, and for auditing the interfaces between LST functions. The general form of an H-P diagram is shown in figure 3.7-1.

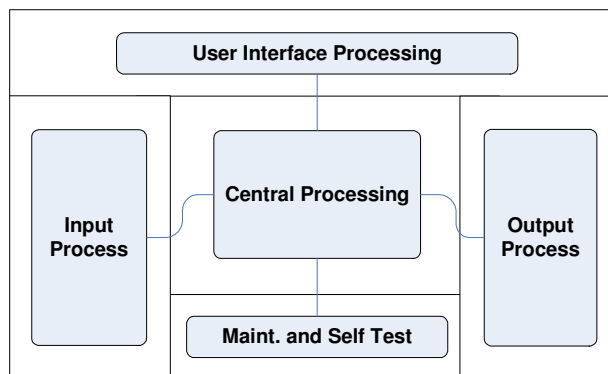

Figure 3.7-1, Hatley-Pirbhai Context Diagram, adapted from [14]

The Hatley-Pirbhai (H-P) context diagram divides functionality according to how it relates to system externals. It is a “context” diagram in the sense that it defines a system in the context of its external interfaces. Input and output processing have their own categories, as do user facing interfaces. Inward facing internal monitoring functions also have their own category, and all processing not engaged in either outward facing or inward facing data processing is considered to be part of “central” processing. If we use these guidelines to map LST categories to H-P diagrams, we achieve the results shown in figures 3.7-2 and 3.7-3.

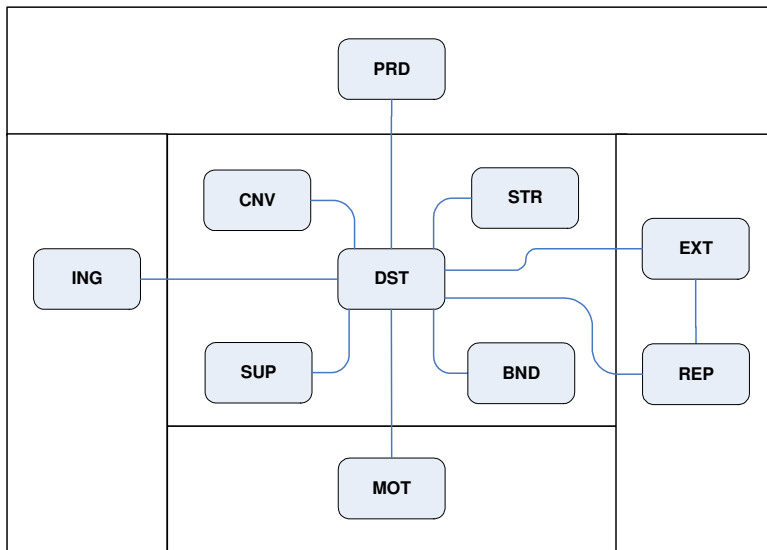

Figure 3.7-2, ME LST to HP Map

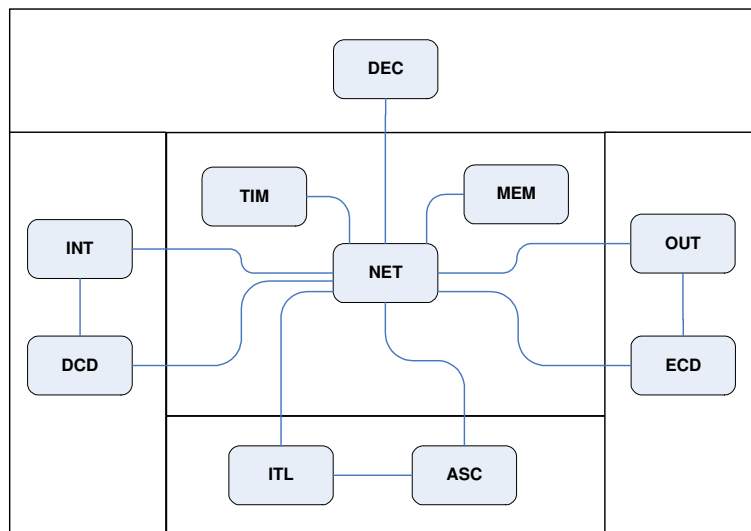

Figure 3.7-3, IC LST to HP Map

Following the convention that inputs are on the left, user interfaces are on top, outputs are to the right, maintenance and self test (overhead, or inward facing) functions are on the bottom, and central processing

functions are in the middle, figure 3.7-2 shows how matter-energy living system theory functional categories map to an H-P context diagram. As expected, [ING] appears on the left, and [EXT] and [REP] appear on the right. [PRD] generally represents the user, and is shown on top, but can also be a central processing function. Most motorized functions [MOT] are overhead in nature, and are therefore represented on the bottom, but can be an output as well, as in attitude control or propulsion functions. Support [SUP], boundary [BND] and matter energy distribution [DST] are all seen as central functions, as is matter-energy conversion [CNV] and storage [STR].

A similar picture emerges for the LST categories of the information domain in figure 3.7-3. Input [INT] and decoding [DCD] functions appear on the left, output [OUT] and encoding [ECD] functions appear on the right, the decider [DEC] functions here generally represent user interfaces shown on top, and overhead functions shown on the bottom include internal transducers [ITL] and autonomous association functions [ASC]. This leaves network [NET], timing [TIM], and memory [MEM] functions as central.

Mapping to an H-P diagram can also be done with a traditional functional block diagram, although the accuracy by category is not perfect, as can be seen in figure 3.7-4 for the case of a generic spacecraft. [15]

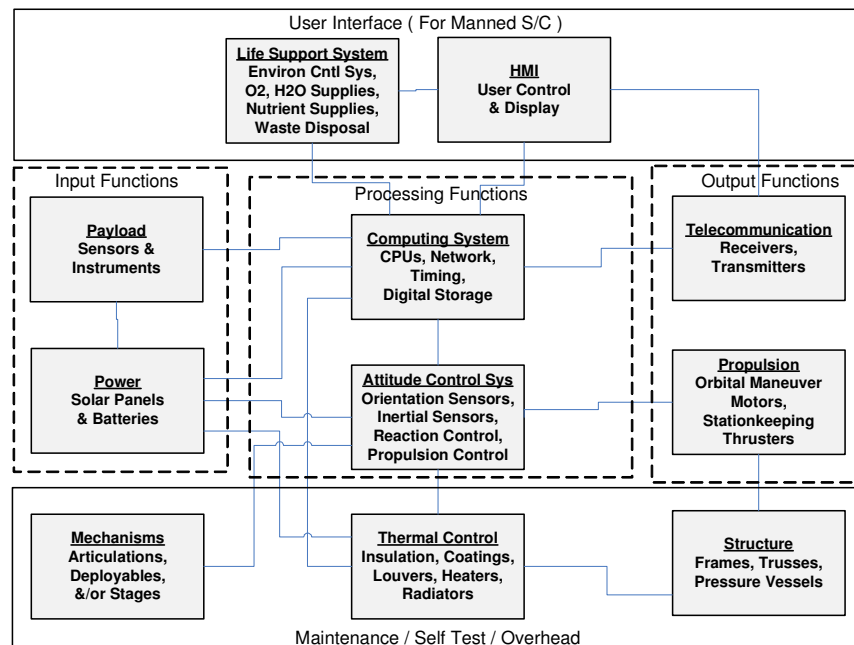

Figure 3.7-4, Functional Block Diagram mapped to HP Context Diagram, adapted from [15]

The problem with the mapping of 3.7-4 is that it obscures the details at work within each subsystem. For instance telecommunication has input and output functionality. The life support system has aspects of input, output, user interface, and central processing. It is therefore useful to go back to Living Systems Categories as mapped in 3.7-2 and 3.7-3 to expose further detail of how a particular subsystem relates to and contains pieces of LST functions, both in the matter-energy domain, and in the information processing domain.

Let us use the example of the Life Support System to further detail the utility of LST categories, now at the subsystem level, as shown in figure 3.7-5. LST functional categories can be explored at the next layer

of detail to help define functional requirements at the subsystem level. For instance, from a user interface perspective, stores [STR] of water, air, and nutrition are required. Looking at the matter energy inputs [ING] needed by a life support system, we see that recirculated air is one input, and recycled water from a variety of sources provide other inputs. These are processed for reuse [PRD], [CNV] and distributed [DST] by circulation motors [MOT]. On the output side, waste products such as H₂ and CO₂ are vented and solid waste is removed [EXT]. This is just one example, but serves to point out that the utility of LST categories lies more in exposing interfaces for subsystem level functionality than it does at the system design level.

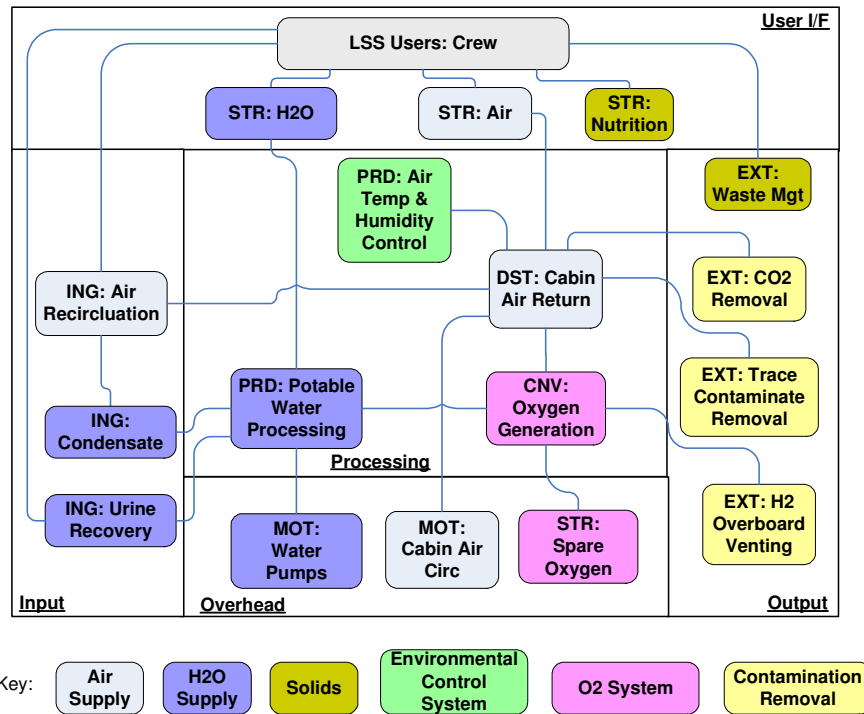

Figure 3.7-5 Life Support System as M-E LST functions mapped to H-P Context [2]

4.0 Architectural Cost versus Benefit Tradeoffs

How should a redeployment take place? Should single versus multiple missions be attempted at once? Are staged versus “all at once” redeployments favored? What is the most practical approach? From an Living Systems Theory point of view, fractional redeployment is akin to a cellular division event in that it is a form of reproduction: where there was once one, there are now two, and we see that what is being split goes through a process somewhat akin to mitosis: aggregation, nucleation, and separation. There is aggregation, in that more and more mass is added until there is the critical mass needed to support a split, nucleation in that the information domain resident in a single object goes through a process of duplication prior to the split, and separation in the moment of the final split between two pieces.

As happens with life at the cellular level, for the lowest possible risk, redeployment should happen one division at a time, because a division leaves both new sides weaker (more prone to risk) after separation than they were together as a whole. It is only when the whole has grown sufficiently to support both the

current and the new mission that reproduction is ready to occur, and in the case of the ISS the newly split off piece is ready for redeployment and relocation to support missions in new locations. Tradeoffs on how best to optimize the reuse of pieces of the ISS are studied in this section. Technical risk and maturity considerations are discussed in 4.1 where a redeployment sequence is suggested, cost modeling is studied in 4.2, and mission to mission comparisons are performed using the Pugh matrix of 4.3 and the QFD deployment matrices of section 4.4.

4.1 Technical Risk and Maturity Considerations

The most important consideration in any human space flight endeavor is safety and the mitigation of risk. While cost benefits will be studied in section 4.2, the major benefit of reusing proven components of ISS already on orbit would be the dramatic risk reduction that would accrue from this approach. Some of the risks of human spaceflight can be reduced, and some can not. Human spaceflight suffers from the inescapable factors of human frailty and illness; technology fragility, failures, and faults; space environment wear and tear; space environmental anomalies such as solar storms; accidents from any root cause; logistical constraints and shortcomings; and the constraints of “long ct,” that is, the impact of response time due to the vast distances involved in space flight and the commensurate signal time of flight.

For all of the above reasons it is desirable to take the approach that at least a portion of every newly staffed space station will be composed of modules already proven in spaceflight. A redeployment scenario based on this notion is depicted in figure 4.1-1. See Appendix A for more detail.

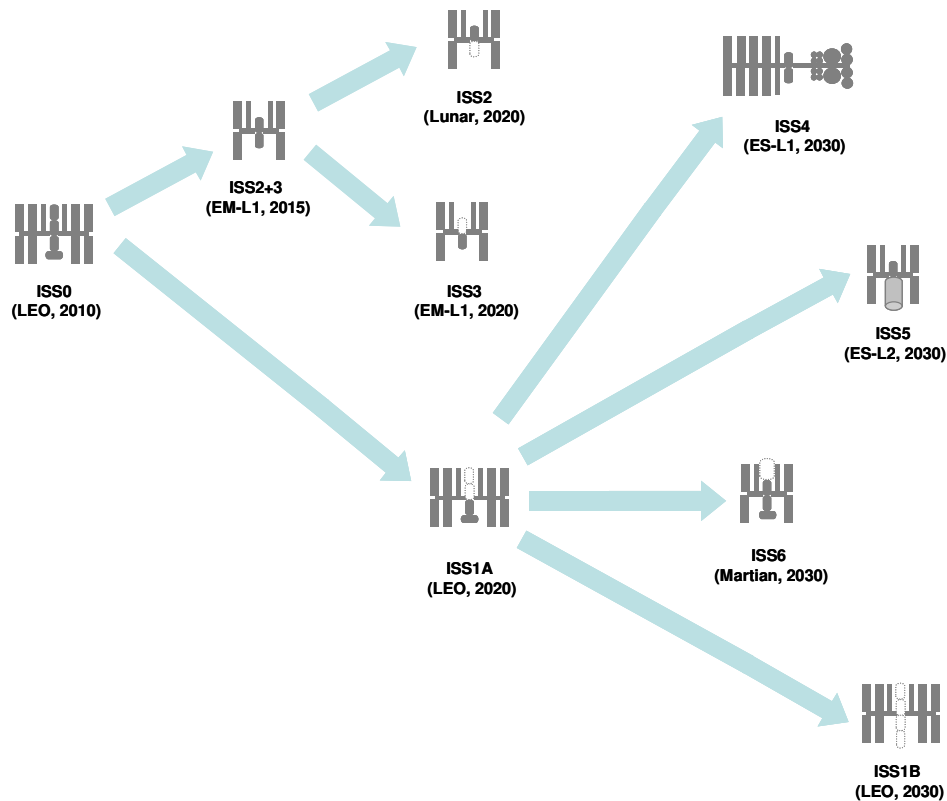

Figure 4.1-1, Proposed ISS Redeployment Division Sequence

Such a scenario is based on the principle that maximizing reuse will drive down risk. Since the superstructure, solar panels, and radiant cooling system are all based on proven technologies, they can be newly produced for every station without accruing undue risk. In the case of the pressurized modules, it would be desirable for at least a portion of those modules that support human life to have already been used on orbit. This has risk reduction consequences in that infant mortality and unforeseen failure modes of new equipment will be avoided in these cases, and when life support systems do fail it is more likely that flight and ground crews will have already had a body of experience in dealing with these types of systems and their common faults. In the next section we will see that there are also cost advantages to reusing flight elements already on orbit.

4.2 Cost Modeling

The cost versus benefit analysis approach taken here is to first layout a low risk redeployment plan, done in 4.1, look at modeling costs for each of the HSF missions here in 4.2 without regard to benefit, and then in 4.3 and 4.4 study the benefits of each mission to provide guidance and rationale for recommended HSF priorities.

Each mission is modeled separately as independent line items. While this is somewhat artificial because there are interdependencies, (for instance individual modules can not be used in two different places at once) it helps to clarify the benefit analysis later on, and it bounds the job of exploring the trade space to a manageable scope. All HSF mission costs are scaled from the same ISS cost data to ensure uniformity in the approach.

Four categories were selected as a simplification of the numbers that appeared in what amounts to our Basis of Estimate (BOE) the May 1998 GAO Report GAO/NSIAD-98-147. [1] The first cost category collects together in one number for each mission all of the development and production costs for the modules and associated structure, (truss framework, solar panels, and cooling panels.) If modules are reused this is assumed to be zero. This is admittedly crude, since significant redesigns of reused modules will have to take place, however normal logistical operations constantly provide replacement parts for ongoing obsolescence in any case, so this cost is captured in ongoing logistical operations.

The second category of cost studied is deployment and redeployment transportation costs, both launch costs from Earth to LEO, as well any costs associated with boosting out of Earth orbit and into their new mission locations. This latter cost is taken to be roughly equivalent to the former, regardless of the end-point destination. A look at the gravitational potential energy gradient contour map as seen in figure 4.2-1 shows us why this is. Most of the work expended in redeploying material in LEO to elsewhere is expended in just leaving LEO and getting to the saddle point in the gravitational contour map known as the L1 Earth-Moon Lagrange point, (EM-L1). Beyond this point very little additional energy is needed to place material in any other orbit or location. And so long as the new station locations are not very far down in the gravitational wells of their new hosts there will be very little energy expended to get material back. This is why the EM-L1 point was referred to in the Augustine report as an “interplanetary roadmap.” Of course the new destinations are limited by the time it would take to reach them, but because the reused modules and new accompanying structures could be pre-positioned unmanned, time is not as

critical a parameter. Staffing would then be added later by a CEV supplemented for long range trips with a Transhab style arrangement (such as the BA330 for Martian transport trips.)

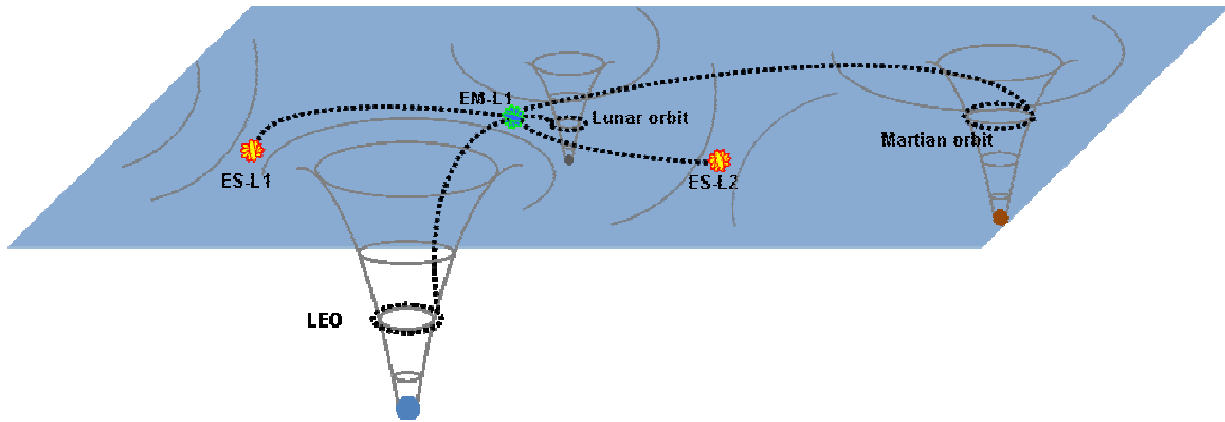

Figure 4.2-1, gravitational contour map with EM-L1 as “on-ramp”

The third cost category studied was that of logistics and operations. There is the cost of on-going NASA operations in support of HSF that must be provided for, there is the resupply of the on-orbit assets needed to sustain life and sustain operations, as seen in figure 4.2-2, and there is the specification and manufacture of these supplies transiting the supply stream that must be accounted for in the cost. [16] Because the launch and transportation costs of transporting this material are such an enormous cost center in and of itself, it is broken out separately as our fourth cost category. There is first the trip to LEO to consider, which is now being turned over to private contractors so as to drive down cost, and there is the LEO to mission destination portion of the trip that must be accounted for.

Table 4.2-1 includes columns for all cost components, including initial development and launch, as well as the associated long term logistical costs. Table 4.2-1a shows the costs assuming reuse, and table 4.2-1b assumes no reuse – it is the case where all station components are freshly designed, launched, and deployed.



Figure 4.2-2, Logistical costs as a necessary cost element [14]

Table 4.2-1a, cost model estimates assuming the reuse of ISS modules on-orbit

<u>Scenario</u>	<u>devl & prod (mod + strc)</u>	<u>initial launch + boost costs</u>	<u>Logistics and resupply ops</u>	<u>log / resup launch costs</u>	<u>TOTAL COST ESTIMATES</u>	<u>Cost rank</u>
Existing ISS 0 (BOE*)	33	20	17	26	96	N/A
ISS1A Update (LEO)	7	3	11	16	37	1
ISS2 (Lunar)	5	6	9	13	33	2
ISS3 (EM-L1)	5	6	9	13	33	2
ISS4 (ES-L1)	10	13	3	5	31	5
ISS5 (ES-L2)	5	6	3	5	19	6
ISS6 (Martian)	6	8	5	8	27	4
ISS1B Update (LEO)	2	3	4	7	16	7
Subtotals by category:	41	45	44	67		

Grand
Total: **196**

Notes:

- 1) *Basis of Estimate (BOE) is May 1998 GAO Report GAO/NSIAD-98-147 [1]
- 2) All values listed are in units of 1998 US \$B
- 3) Costs from 2011 to 2030

Table 4.2-1b, cost model estimates assuming an all new design (no reuse from ISS)

<u>Scenario</u>	<u>devl & prod (mod + strc)</u>	<u>initial launch + boost costs</u>	<u>logistics and resupply ops</u>	<u>log / resup launch costs</u>	<u>TOTAL COST ESTIMATES</u>	<u>Cost rank</u>
Existing ISS 0 (BOE*)	33	20	17	26	96	N/A
ISS0 ops (2011- 2020)			17	26	43	1
ISS2 (Lunar)	8	10	9	13	40	3
ISS3 (EM-L1)	8	10	9	13	40	3
ISS4 (ES-L1)	13	16	3	5	38	5
ISS5 (ES-L2)	8	10	3	5	26	7
ISS6 (Martian)	10	13	5	8	36	6
ISS0 ops (2021- 2030)			17	26	43	1
Subtotals by category:	48	59	63	96		

Grand
Total: **266**

Notes:

- 1) *Basis of Estimate (BOE) is May 1998 GAO Report GAO/NSIAD-98-147 [1]
- 2) All values listed are in units of 1998 US \$B
- 3) Costs from 2011 to 2030

These are crude but consistent cost models based on existing published cost estimates supplied by the GAO in their report on ISS costs in 1998. [1]

The results are obvious from a comparison of the grand total bottom line in each case. In addition to the safety and risk mitigation benefits of reusing ISS components, there is a cost benefit, predicted by the cost modeling above to be on the order of 70 Billion US dollars over 20 years. This is somewhere between 20% to 30% of overall program cost. Results are summarized in a side-by-side comparison of costs for each HSF mission from now until 2030 as depicted in the bar chart of figure 4.2-3, which contrasts the results of tables 4.2-1a and 4.2-1b.

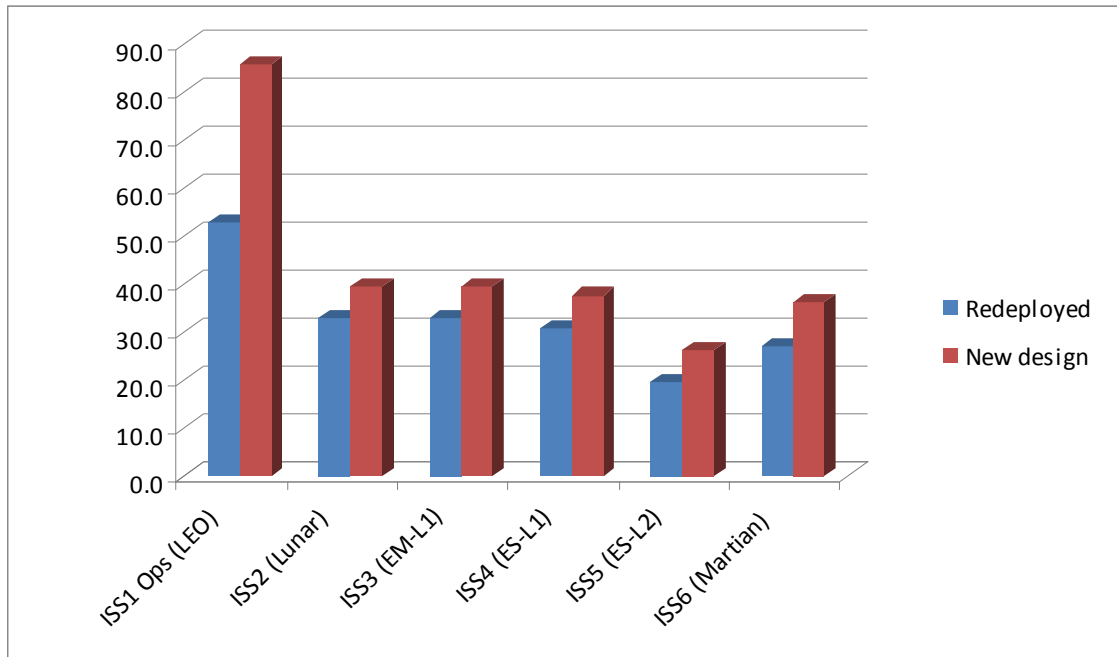

Figure 4.2-3, Cost benefits of ISS reuse

Not included here are any cost benefits that would accrue due to the on-orbit generation of rocket fuel. Cost of logistical services and resupply for on-going transportation operations shows a large in-situ advantage and is one of the reasons we are considering a mission at ES-L1 to collect solar power and use it to produce rocket fuel – this then becomes fuel we do not need to ship from Earth. Because all of our costs were scaled based on the ISS that did not have this capability, it is not reflected in the current cost model as a savings or credit.

Groundrules and assumptions are critical in a case like this, and should be fully disclosed so as to be fully and completely debated in an open forum. The groundrules and assumptions that went into the models of tables 4.2-1a and 4.2-1b are collected in table 4.2-2 below.

Table 4.2-2, cost model assumptions (reuse version set)

Ref No	Groundrules and Assumptions used in Cost Estimate	Applicability
1	Future costs of HSF missions can be scaled from the ISS-0 costs to date (no cost improvement assumed)	All
2	Cost of the ISS-0 is roughly half module cost, and half other structures (truss, solar panels, radiant coolers) cost	All
3	Overall costs (modules + structures) are assumed to scale with the number of living modules	All
4	Design and production costs of all modules are assumed to be the same (average cost is used for all)	All
5	Launch costs to LEO only accrue for new modules and structures (upgrades included in ongoing logistics)	All
6	The cost of boosting a module from LEO to its redeployment location is assumed to be the same as launch to LEO	All
7	Logistics operations, including resupply, are assumed to scale with the number of modules	All
8	Launch costs associated with logistics / resupply operations are assumed to scale with number of modules	All
9	ISS1A (2020 suggested LEO baseline) will lose M1, M3, M6, M11, M14, & M16	ISS1A
10	ISS1A (2020 suggested LEO baseline) will gain two SD2 (Sundancer) modules, a refueling node, and an assay node	ISS1A
11	ISS2 (lunar orbiter) will reuse M3, M11, & M16, and will add one SD2; structure will be 4/16 of ISS-0	ISS2
12	ISS3 (EM-L1 station) will reuse M1, M6, & M14, and will add one SD2; structure will be 4/16 of ISS-0	ISS3
13	ISS4 (ES-L1 station) will reuse M2, M5, & M15; solar collection / fuel generation structure will be 10/16 of ISS-0	ISS4
14	ISS5 (ES-L2 station) will reuse M4, M12, & M13; deep space telescope structure will be 5/16 of ISS-0	ISS5
15	ISS6 (Martian orbiter) will reuse M7, M8, M9, and M10, and will add a BA330; structure will be 5/16 of ISS-0	ISS6
16	ISS1B (2030 suggested LEO baseline) will lose M2, M4, M5, M7, M8, M9, M10, M12, M13, & M15	ISS1B
17	ISS1A (2030 suggested LEO baseline) will gain two more SD2 (Sundancer) modules (4 total)	ISS1B

It is clearly advantageous to further investigate the design options surrounding the reuse of the ISS. But what if not all of the missions explored here fall within budget guidance, or what if public funding cuts occur in out years, or international support falters? How do we decide which of these missions should be funded, and which of them we should cut? In the next two sections we investigate tools for making these difficult decisions. In 4.3 the Pugh matrix methodology is applied to each beyond LEO HSF mission to judge their relative merit, and in section 4.4 the quality functional deployment technique is used to better quantify the needs and payback of a manned presence for each of the missions listed.

4.3 Pugh Matrix Methodology

Having explored first the costs of each of the HSF missions proposed as part of the Augustine Commission’s Flexible Path approach, we now begin exploring benefits by populating a Pugh Matrix which is typically used in the context of decision analysis. From Augustine report guidance [3], we use the following criteria to judge how each of these mission areas:

- 1) Does it support a contribution to new science?
- 2) Does it advance the technology of exploration?
- 3) Does it assist in the research of spaceflight effects on humans?
- 4) Does it trigger public involvement?

The Pugh matrix that addresses each of these topics for each of the stated flexible path missions is presented as figure 4.3-1. Here the missions are delineated in the columns, and the criteria are in the rows. While judging each of these missions at this high level can be quite subjective, it is still possible to obtain the relative merit of each option so long as the criteria are applied uniformly. The result, perhaps not surprising, is that orbiting Mars would rank highest when taking these criteria together, and the necessary stepping stones of first establishing a presence at the Earth-Moon 1st Lagrange point and in lunar orbit are

tied for second place. Ranking on the lower end are the missions Earth-Sun Lagrange points, solar science and solar energy collection at L1, and deep space astronomy and finally the option of a manned NEO rendezvous.

Note that “NEO Rendezvous” is a mission that until the present has not been discussed, and was not costed in 4.2. This is because it is not a mission that requires a long term staffed facility of its own. Presumably such a mission could be supported by travelling first to the EM-L1 point, and then when suitable logistical support can be mustered, launching it from there. In this sense, aside the additional launch costs, the mission could almost be added “for free” as it would be leveraging the logistics already in place to support the rest of the flexible path approach. However it is the author’s judgment that the risks of such a difficult and dangerous low gravity rendezvous may out weigh the rewards, and this is reflected in the negative point assigned to human research in the matrix.

Taking for a moment the contrary view, if a manned NEO rendezvous is someday judged to be worthwhile, then the points allocated to NEO rendezvous could be re-allocated and added to the points assigned to EM-L1, giving it an overall score of 8, which would match in importance a Martian orbit.

Functional Criteria	Lunar Orbit	EM L1	ES L2	ES L1	NEO Rendezvous	Martian Orbit
New Science	human/robot ops (++)	S/C service ops (+)	telescope ops (+)	solar science (+)	geophysics & astrobiology (+)	human/robotic sample return (++)
Exploration Preparation	beyond LEO ops (+), martian practice (++)	assy & fuel depot (+)	temp quarters (+)	test deep-space flight habitation (+)	small body encounters (+)	joint human/robotic ops on another planet (++)
Human Research	1st extended period outer LEO ops (+)	(0)	(0)	deep-space flight hab impact (+)	high risk to life (-)	780 day round trip endurance record (++)
Public Engagement	return to past with return to moon (-)	"on ramp" to solar system (++)	First deep space Earth escape (+)	1st humans in solar wind (+)	long transit time (+) human landing (+)	1st human orbit of Mars (++)
Sum (+)	6	5	3	4	4	8
Sum (-)	1	0	0	0	1	0
Sum Total	5	5	3	4	3	8

Figure 4.3-1, Pugh Matrix Option Representation [3]

4.4 Quality Functional Deployment (QFD) Methodology

In now applying a Quality Functional Deployment (QFD) approach to the analysis of what system attributes best support the HSF missions of interest, we return to our theme that Living Systems Theory (LST) functional categories have merit when used for detailed systems analysis of space habitation environments. By analyzing LST categories against each mission we can discover which categories are the most important in an aggregated sense for all missions, and this can aid in assigning resources during systems design, planning key technology development, and for judging different systems designs or approaches amongst each other.

The QFD matrix for matter-energy categories appears in table 4.4-1a, and the QFD matrix for the information categories appears in table 4.4-1b. The “quality characteristics,” or functional categories in this case, appear in the columns, and the “demanded qualities” in this case the missions, appear in the rows. Note that the NEO rendezvous mission is shown on a separate line from the EM-L1 mission, consistent with our approach taken with the Pugh Matrix.

On the left hand side of the QFD matrix there is a work space for registering how strongly the LST categories correlate to or support each mission. The key to the symbology is to understand that the capital Theta (Θ) represents a strong correlation, the (O) represents a medium correlation, and the filled triangle (Δ) represents a weak correlation. Results of this section of the QFD analysis are compiled by the spreadsheet on the bottomline, in the area called “relative weight,” which compiles the correlation judgments made above regarding the utility of each functional category.

In the case of the matter-energy categories, the results from figure 4.4-1a indicate that of primary importance are the categories of ingesting [ING] and producing [PRD]. Ingesting represents the function of taking in matter and energy, including life support deliveries and solar power. Producing in this context is the deciding element of how matter and energy should be combined, especially when combined in new ways, and while some processes that perform this function are autonomous, this function is primarily controlled by the human presence in any manned facility. Of secondary importance are the extruder [EXT] and motor [MOT] categories, both of which are important for the build out, operations, and maintenance of any facility, be it manned or unmanned.

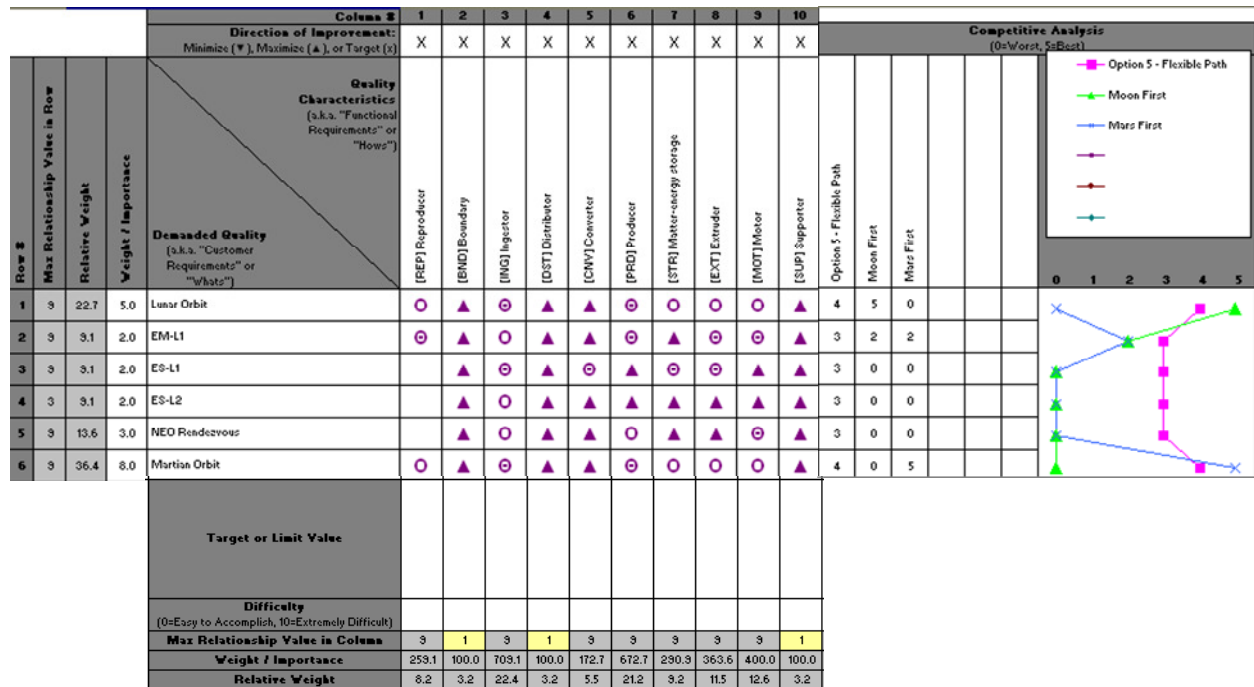

Figure 4.4-1a, QFD chart for qualities versus Matter-Energy domain LST categories

There is also a separate section on the right hand side of each QFD chart that can be used for a “competitive analysis,” which in this case has been used instead to judge among three of the possible approaches to human spaceflight, “Moon First,” “Mars First,” and “Flexible Path.” It is perhaps self evident, but still a good process check, to find that when judged by the criteria of the flexible path approach, the flexible path approach scores highest. Certainly was this not the case there would be an indication that the judgment criteria were not self consistent. In this case the consistency check passes for both types of LST categories.

In the case of the information categories, the results from figure 4.4-1b indicate that three categories are of tantamount importance to the information domain for these missions: input transducers [INT], deciders [DEC], and output transducers [OUT]. Input and output transducers of course represent communication services in this case, and the decider [DEC] category can be automated to some extent, but just as we noted with the [PRD] category, it is ultimately the human presence that is in control of this category, and due to the problems of speed of light communication, (the “CT problem”) it is the on-site human presence that will have the control bandwidth needed for realtime interactions with the space environment.

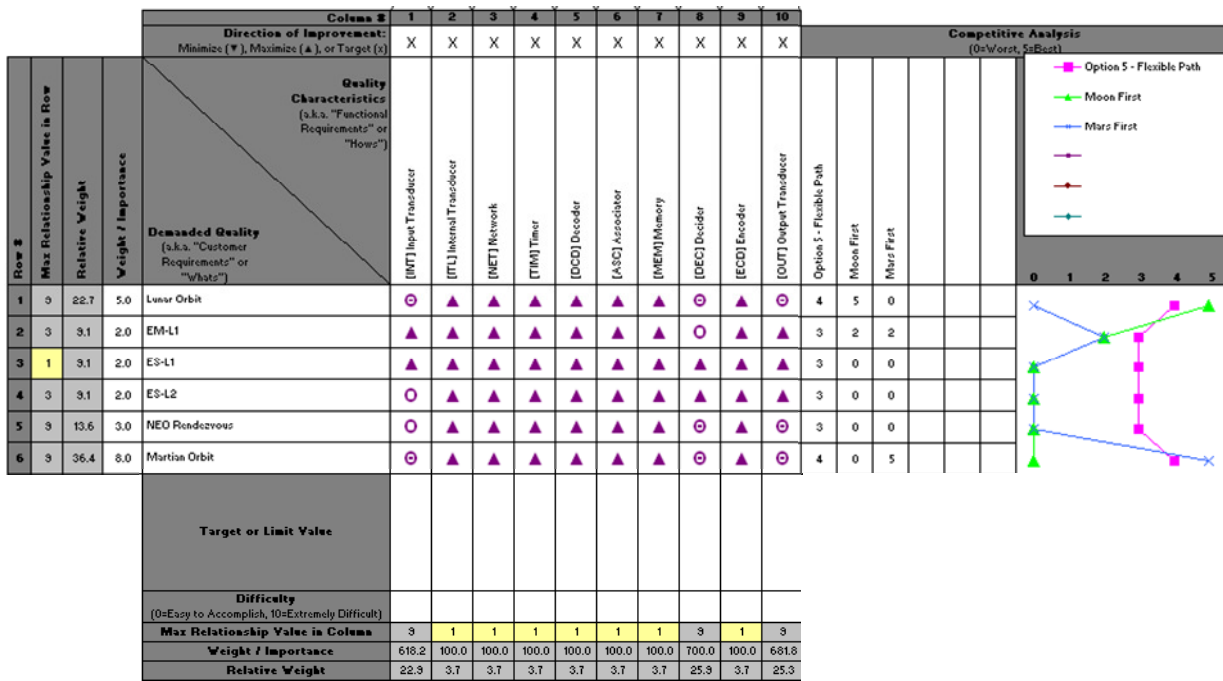

Figure 4.4-1b, QFD chart for qualities versus Information domain LST categories

To summarize, [PRD] and [DEC] both exhibit high correlations, stressing the importance of the human presence for these missions, although to a lesser extent for ES-L1 and ES-L2. On the approach analysis side, comparing the Flexible Path approach to either the Moon first or Mars first shows the overall advantage of this option for this mission set.

5.0 Conclusions

This section draws out conclusions that accrue from the forgoing paper, including recommendations for ISS redeployment options, the utility of using living systems theory, and suggested areas of future research. Recommendations for the redeployment of ISS assets are covered in section 5.1, and conclusions regarding the utility of the applying living systems theory are explored in 5.2. Recommendations for further study are covered in 5.3 for cases of very general study, and 5.4 for specific recommended study areas.

5.1 Recommendations for ISS Redeployment

There are two near term aspects to the redeployment recommendations of this paper:

- 1) Repurpose the living modules of the ISS for new beyond LEO missions
- 2) Continue to operate a LEO presence to support beyond LEO logistics

With the exception of a manned NEO rendezvous, the flexible path mission set was fully embraced in this paper as a coherent and consistent mission set. This has led to the following recommended set of missions for additional ISS components to be developed and launched for additional beyond LEO activities:

- 1) Redeploy a portion of the current ISS into lunar orbit for lunar observations and surface robotic missions
- 2) Deploy a station to EM-L1 to prove out Lagrange point stationkeeping, and to provide for an interplanetary assembly and refueling node.
- 3) Deploy a station to ES-L1 for a solar power collection node and top provide a solar observation facility
- 4) Deploy a station to ES-L2 for deep space astronomy
- 5) Deploy a station to Martian orbit for observations and surface robotic missions

It is estimated that for the above mission set the reuse of ISS assets would save roughly \$70B for a total 20 year funding of just under \$200B, for an average expenditure of \$10B per year. International participation is encouraged for cost sharing and resource sharing reasons. At a funding level of \$150B over 20 years deep space astronomy at the Earth-Sun L2 point would have to be removed from the program, as would any solar science or solar energy collection operations at the Earth-Sun L1 point. Below the funding level of \$150B over 20 years, or about \$7.5B per year, it is concluded that a robust program of human space flight would not be possible within the confines of current technology.

5.2 General Utility of Applying LST

One of the central goals of this paper was to demonstrate the utility of living systems theory (LST). This has been only partially successful. The original hypothesis of the author was that LST would help with definition of system level functional attributes, which was the motivation for introducing LST categories in section 3. However in 3.4 it was found that LST categories made a better checklist than as a source of discriminators, as every HSF mission was found to need the same LST functions. LST functions therefore had little utility in determining reuse optimization of station components at the scale they were studied in this paper.

A modified hypothesis was concluded to have more value: that LST can be used at a high level as a functional checklist, but is better for defining and detailing functionality at a subsystem level especially when conjoined with Hatley-Pirbair (H-P) context diagrams. The combination of both matter-energy and information domain LST functional categories in an H-P context showed much promise in helping to uncover the “fractal” nature of functionality in living systems. In other words the structure of living systems was seen to repeat itself over and over at the systems level, the subsystems level, and the unit level and below when analyzed in this manner.

5.3 General Recommendations for Further Study

From a reach forward point of view, LST could be beneficial for another orthogonal look into a “systems of systems” designs for highly distributed human space flight architectures spanning great distances.

From a reach back point of view, terrestrial applications should be revisited: how city planning is done given the tenets and categories of LST should be investigated. This technique may also apply to other confined or remote micro-environments, such as building design, oil platforms, submarines, etc. Traditional functions may also exhibit design patterns when revisited with LST categories, which could lend insight into how to recombine traditional functions in new, more efficient, ways.

5.4 Specific Recommendations Arising from This Study

The following specific recommendations arose in the course of this investigation:

- 1) It is recommended that NASA work with the international space exploration community to more fully develop redeployment planning using LST, including the beyond LEO missions described herein and in Appendix A.
- 2) Explore and more fully study the benefits and costs of the Dyson-Harrop Solar Wind Power Generation concept [19] as described in Appendix B.
- 3) Use the ASC to DCD human to machine user interfaces to more fully define and quantify the needs and benefits of user interfaces, such as the “Astrogator” interface more fully described in Appendix C. This is included as an example to stress the importance of a improved presentation layer that better meets the needs of astronauts in a beyond LEO environment.

Acknowledgements

The author wishes to thank John Palmer for the dialog, references, and review he provided. The author is indebted to Nancy and Hannah for the understanding and moral support they provided during the development of this manuscript. Thanks are also due to Rebecca of FlavorLA for the catering support during this effort.

Financial support for this work was provided in part by The Boeing Company, in part by Linquest Corporation, and in part by Seculine Consulting, and is gratefully acknowledged.

This work is dedicated to the memory of Looney, also known as Ronald Lamonte Barron, who advised his students and followers to “Pollute your mind with positive thoughts.” Thanks Looney; its working.

References

- [1] GAO Report, "ISS US Life-Cycle Funding Requirements," (May 1998) Washington DC: GAO/NSIAD-98-147.
- [2] The NASA ISS page http://www.nasa.gov/mission_pages/station/main/index.html, as reported by and updated on http://en.wikipedia.org/wiki/International_Space_Station, both accessed 10/28/10.
- [3] Augustine Commission Final Report, "Seeking a Human Spaceflight Program Worthy of a Great Nation," Review of U.S. Human Spaceflight Plans Committee, (2009) Washington, DC.
- [4] Flexible path support decision: <http://www.thespacereview.com/article/1702/1>, accessed 10/28/10.
- [5] Orbital Manned Assembly and Experiment Complex (OPSEK) web site, <http://www.russianspaceweb.com/opsek.html>, accessed 10/28/10.
- [6] Bigelow Aerospace web site, <http://www.bigelowaerospace.com/sundancer.php>, accessed 10/28/10.
- [7] New York Times on line article, <http://www.nytimes.com/2010/03/04/world/asia/04space.html>, accessed 11/02/10.
- [8] Roach, Mary, Packing for Mars. (2010). New York: W.W, Norton & Company, Inc. ISBN 978-0-393-06847-4.
- [9] Comins, Neil, The Hazards of Space Travel. (2007). New York: Random House, Inc. ISBN 978-1-4000-6597-4.
- [10] Miller, James Grier, Living systems. (1978). New York: McGraw-Hill. ISBN 0-87081-363-3.
- [11] Buede, Dennis M, The Engineering Design of Systems: Models and Methods. (2000). New York: John Wiley & Sons, Inc. pp. 188-189. ISBN 0-471-28225-1.
- [12] Miller, James Grier, "Applications of Living Systems Theory to Life in Space," Presented at the NASA-NSF conference Experience in Antarctica: Applications to Life in Space, (1987) Sunnyvale, CA: NTRS Ascension ID 93N16865.
- [13] International Docking System Standard (IDSS) Interface Definition Document (IDD), released by NASA on 9/21/10, as published online at <http://www.internationaldockingstandard.com>, accessed 12/2/10.
- [14] Hatley, Derek, et al., (2000). Process for System Architecture and Requirements Engineering. New York, NY: Dorset House Publishing. p. 434. ISBN 0-932633-41-2.
- [15] Delft University of Technology website: <http://www.lr.tudelft.nl/live/pagina.jsp?id=372fdbdb-17c9-476f-8a11-d5c95952cdda&lang=en>, accessed 11/2/10.
- [16] National Research Council, "Engineering Challenges to the Long-Term Operation of the International Space Station," (2000). Washington DC: National Academy Press. ISBN 0-309-06938-6.
- [17] Smith, Mike, Las Vegas Sun, 9/17/10 edition.
- [18] Kushvah, Badam Singh, "Trajectory and stability of Lagrangian point L2 in the Sun-Earth system," *Astrophys Space Sci*, DOI 10.1007/s10509-010-0493-9 (2010) New York: Springer Publishing Company.
- [19] Harrop, Brooks, and Schulze-Makuch, Dirk, "The Solar Wind Power Satellite as an alternative to a traditional Dyson Sphere and its implications for remote detection," *International Journal of Astrobiology* 9 (2): 89–99 (2010), Cambridge University Press.

Appendix A

This appendix depicts the proposed ISS redeployment division sequence in more detail than was shown in the summary of figure 4.1-1. The module numbering used is identical to that introduced in section 1.1, so that module M1 shown in this sequence is the same identical module everywhere it is depicted, just at a different moment in time.

Redeployment Schematic – ISS 0 2010 Baseline

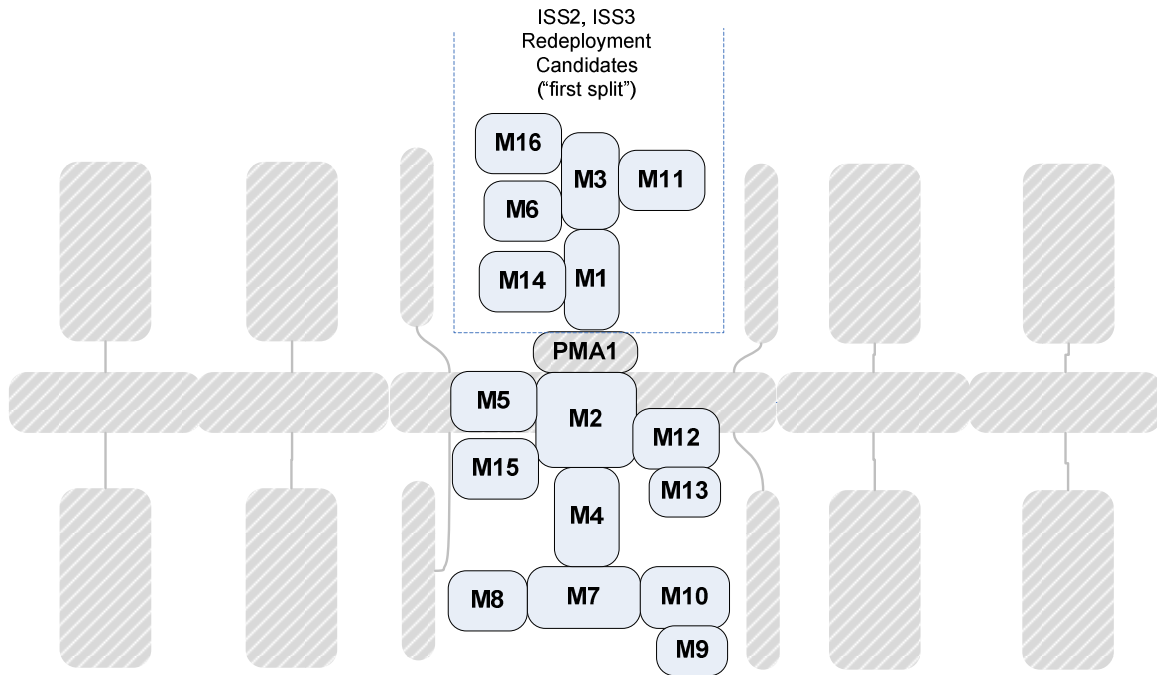

Figure A-1, The current ISS baseline

Redeployment Schematic – ISS2, Lunar Orbit, 2020

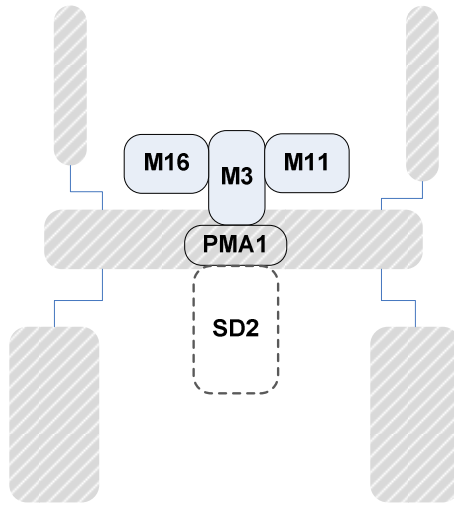

Figure A-2, ISS2, proposed for lunar orbit, circa 2020

Redeployment Schematic – ISS3, EM-L1, 2020

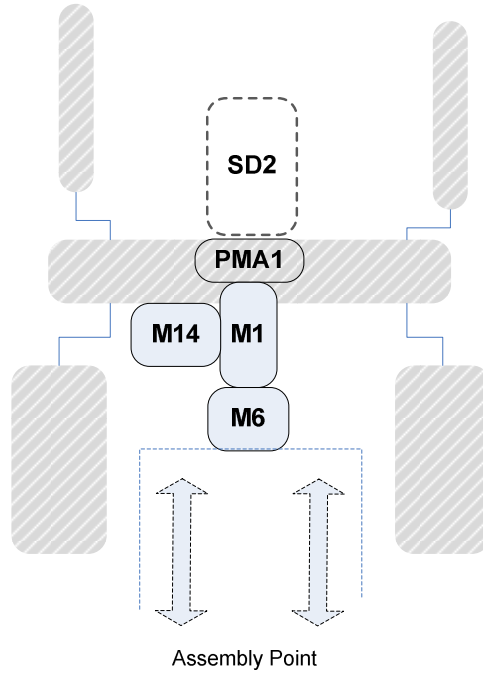

Figure A-3, ISS3, proposed for the Earth Moon Lagrange point L1, circa 2020

Redeployment Schematic – ISS1, RevA, 2020

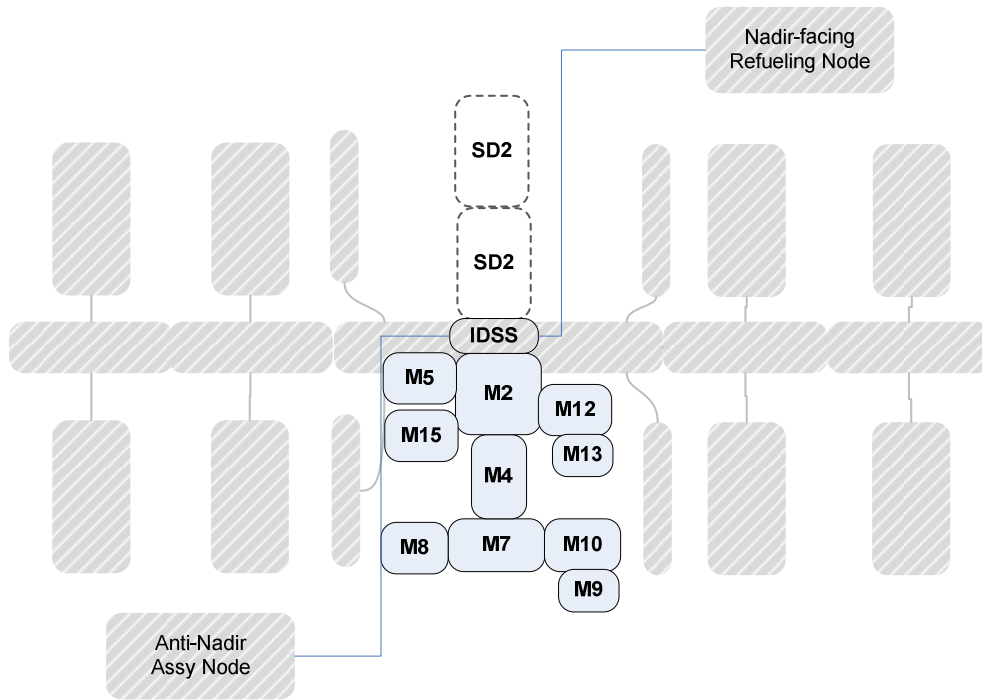

Figure A-4, The ISS configuration as proposed for 2020

Redeployment Schematic – ISS4, ES-L1, 2030

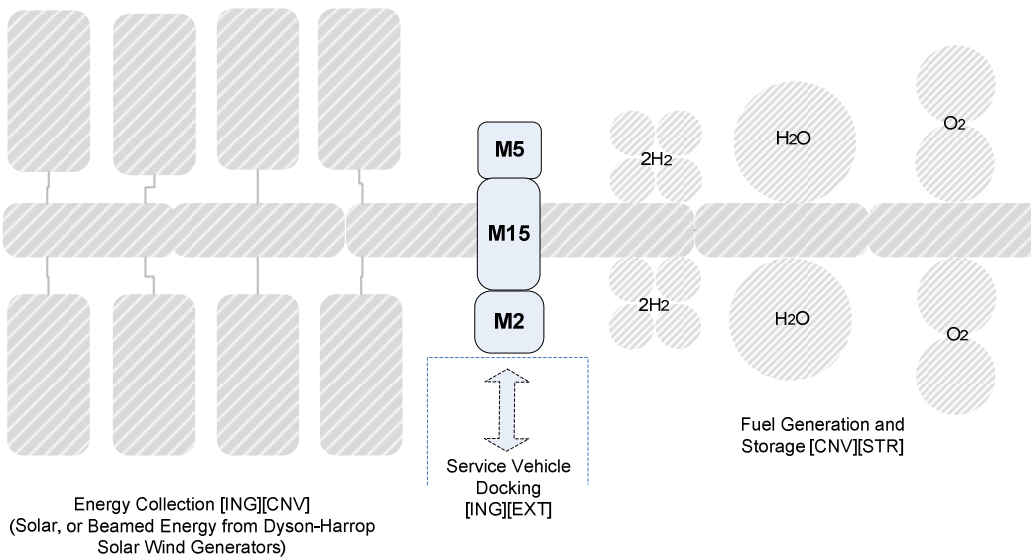

Figure A-5, ISS4, proposed for the Earth Sun Lagrange point L1, circa 2030

Redeployment Schematic – ISS5, ES-L2, 2030

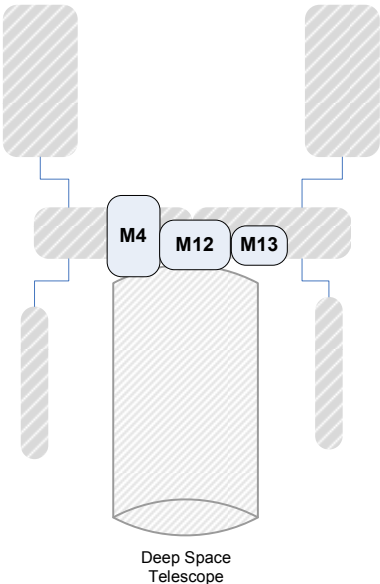

Figure A-6, ISS5, proposed for the Earth Moon Lagrange point L2, circa 2030

Redeployment Schematic – ISS6, Martian Orbit, 2030

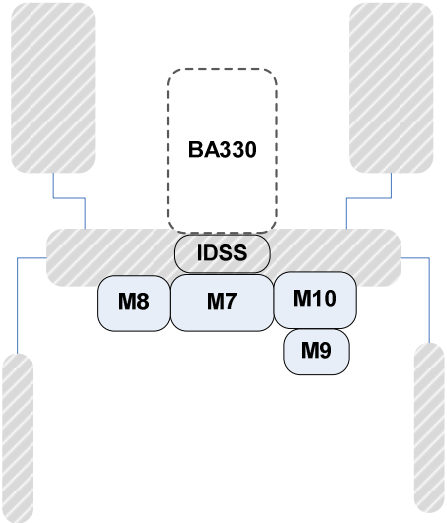

Figure A-7, ISS6, proposed for Martian orbit, circa 2030

Reployment Schematic – ISS1, Rev B, 2030

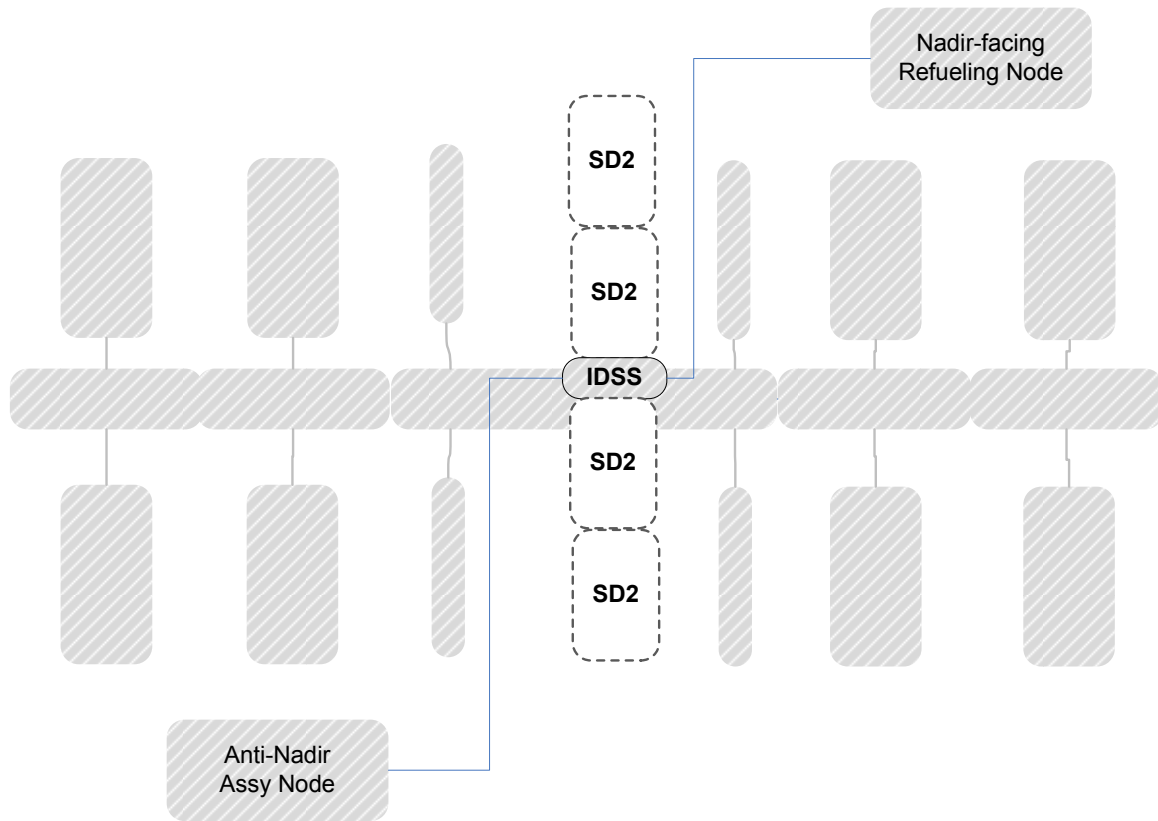

Figure A-8, The ISS configuration as proposed for 2030

Appendix B, Solar Wind Powered Infrastructure

A description of the Dyson-Harrop Solar Wind Power (SWP) Generation concept is included in this appendix as an optional resource for powering various aspects of infrastructure in support of the space stations proposed in the main paper.

B.1 Fundamentals of the Dyson-Harrop Solar Wind Power (SWP) Generation Concept

A description of the principle of operation for the Dyson-Harrop SWP Generator is included here, and is based on the concept published in reference [B1]. A conceptual design for a Dyson-Harrop SWP satellite is depicted in figure B-1-1. The satellite generates power from the fast solar wind flux available at high solar latitudes. Such a flux is composed of both positive ions and electrons. The Dyson-Harrop SWP satellite develops a useful voltage potential by capturing positive ions against a solar sail for a net positive voltage, while draining off electrons on a long wire, and guiding flux electrons along a short wire into a charge receiver for a net negative voltage. The voltage difference between the charge receiver and the solar sail is used to power a laser or microwave transmitter for power transfer off-board the satellite.

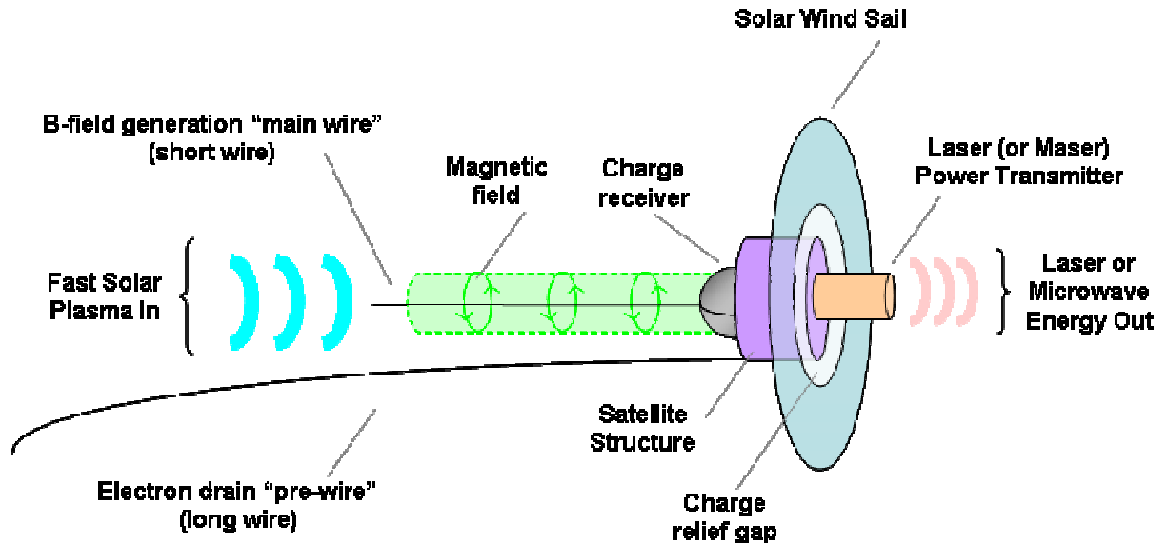

Figure B.1-1, Operating Principle of Solar Wind Power Generation

Typical satellite design parameters proposed for such a design are outlined in table B1-1 for a satellite design capable of producing 1.7 MW of continuous power from captured solar flux.

Table B1-1. Describing the construction characteristics of a 1.7 MW SWP Satellite [B1]

Dimensions (all solid copper) Pre- & Main-wires: 300 m long, radius=1 cm.
Sail: ring (inner radius 3 m, outer radius 10 m, 1 mm thick.
Receiver: spherical shell, 1 m radius, 2 mm thick.
Inductor : TBD, assume all dimensions <0.5 m.
Dimensions (not copper) Receiver Dielectric: TBD, assume less than $4\pi 3 \text{ m}^{-3}$ volume.
Laser system: assume all dimensions <1 m.
Compactability (for launch) $\sim 3 \text{ m}^3$, assuming adequate assembly mechanism in deployment vehicle.
Deployment Destination $\sim 1 \text{ AU}$ from the Sun, between 30deg and 80xdeg above/below the solar plane.
'TBD'=to be determined.

B.2 Fleet Orientations for the Dyson-Harrop Solar Wind Power (SWP) Generation Concept

There are a number of technical issues associated with the design of section B.1. The most serious are the expected beam divergence and to a lesser extent the expected pointing errors. Given the current state of the art in inter-satellite lasers, one may expect a divergence on of at least $4 \mu\text{rad}$ [B2], resulting in power significantly dispersed over the 1 AU distance needed to transmit power to missions in the Earth-Moon system, or 1.5 AU in Martian orbit. At 1 AU a spot beam composed of a single satellite power beam coverage area will have spread to at least an area of $\pi (600\text{km})^2 = 1.1 (10)^{12} \text{ m}^2$, and a value of $\pi (900\text{km})^2 = 2.5 (10)^{12} \text{ m}^2$ at 1.5 AU.

So even if we have 60% efficient coupling of power into the transmitter, we will have only 1MW spread over $2.5 (10)^{12} \text{ m}^2$ for spot beam coverage in Mars orbit, for an irradiance of $.4 \mu\text{W}/\text{m}^2$. This is not a useful amount of power transfer and would not be effective in terms of replacing in situ solar array power. However, for other missions, such as interplanetary precision navigation & timing (PNT), or interplanetary non-realtime (NRT) communication services (COM), this is a significant amount of power indeed.

For comparative purposes let us consider the Earth bound GPS L1 C/A PNT signal. A user element receiver set generally expects an L1 C/A signal strength at 1575 MHz at the surface of the Earth on the order of $-135 \text{ dBW}/\text{m}^2$ [B3], which is equivalent to $.0316 \text{ pW}/\text{m}^2$. This is a factor of 12,600 times less than the value expected from a single Dyson Harrop solar wind powered satellite. Hence there is sufficient power from a single satellite alone to provide not only PNT services, but also NRT COM services as well, such as text, voice, and video messaging, as well as UDP style file transfers.

It is therefore with PNT and COM services in mind that we propose the architecture depicted in figure B.2-1. Here we propose two different Dyson-Harrop SWP Generator fleets, one serving the Earth-Moon system, and orbiting in a solar polar orbit with a longitude of ascending node that is always oriented at the Earth-Moon system, and the other also in a solar polar orbit, of perhaps a greater semi-major axis, but with a longitude of ascending node that is always oriented at the Martian system. For illustrative purposes both fleets are depicted with 8 satellites each, but the exact number would obviously be a function of mission requirements and cost – benefit tradeoffs. Although only Earth and Mars planes are shown, one can easily imagine additional planes being added to extend to Jovian and Saturn systems coverage.

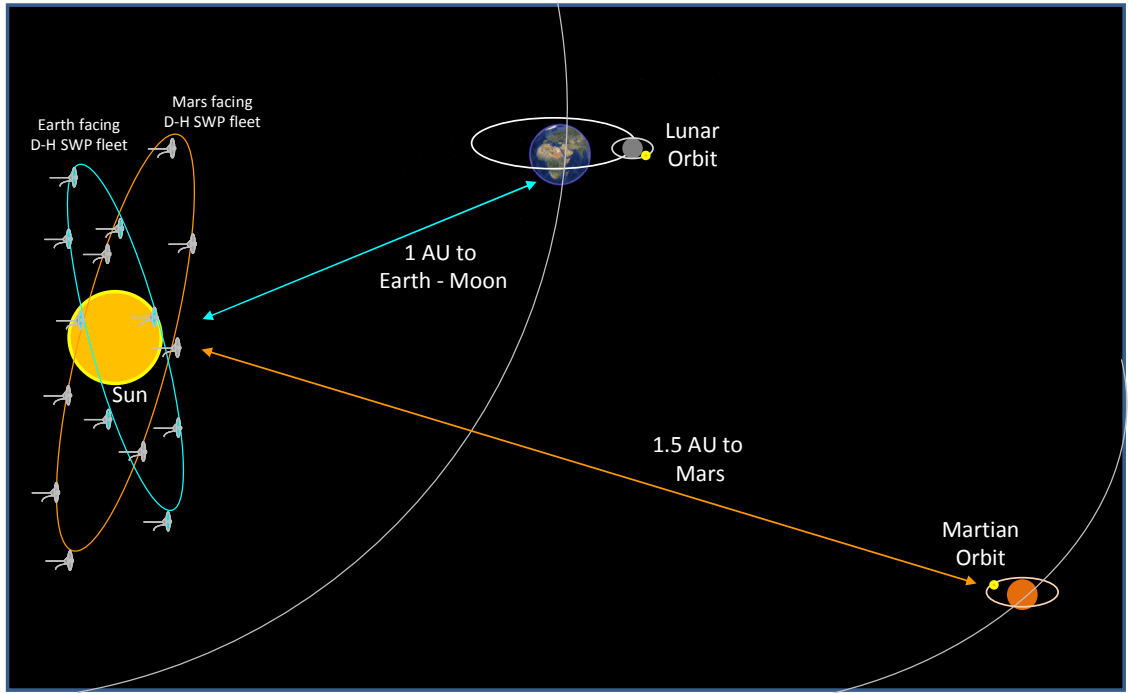

Figure B.2-1, Fleet Orientation for Dyson-Harrop SWP Generators

B.3 Coupling Power / Information from the Dyson-Harrop SWP Generator Fleet to the ISS Fleet

Let us now study how we might use the proposed fleets of Dyson-Harrop (D-H) SWP Generator satellite fleets to power interplanetary PNT and COM services. We will name the interplanetary precision, navigation, and timing service the “Solar Positioning System,” (SPS), and we will name the interplanetary communication service the “Solar Com Service,” (SCS). For SPS coverage we consider the case where the Earth-bound USNO continues to provide a UTC timing source, and it is transmitted and corrected for general relativity effects so that provides a corresponding solar centered inertial time (SCIT) reference.

The absolute time reference would trace as follows: The USNO time source is transmitted to the ES-L1 station, which would in this scenario be the fleet controller for the SWP fleets. The ES-L1 station provides the SPS time reference to both the E-M D-H fleet and the Martian D-H fleet. The ES-L1 provides the time reference to all other Earth-moon missions on a spot beam coverage basis as shown in figure 3.3.-1. If the ES-L1 station is in contact with each and every D-H satellite of both fleets then no sat-to-sat crosslinks are required. In this scenario the SPS signal is provided to the Martian system via the ES-L1 station as relayed by the Martian D-H fleet, as shown in figure B.3-2.

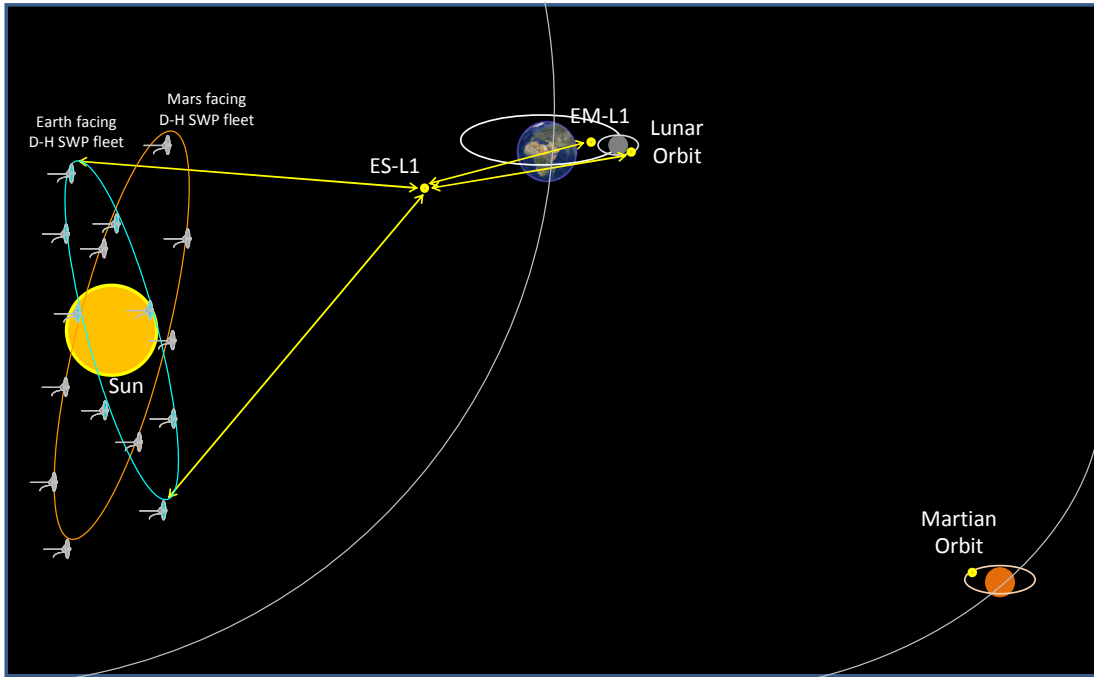

Figure B.3-1, Coupling Power from D-H SWP Earth Facing Fleet from/to ISS 2-5

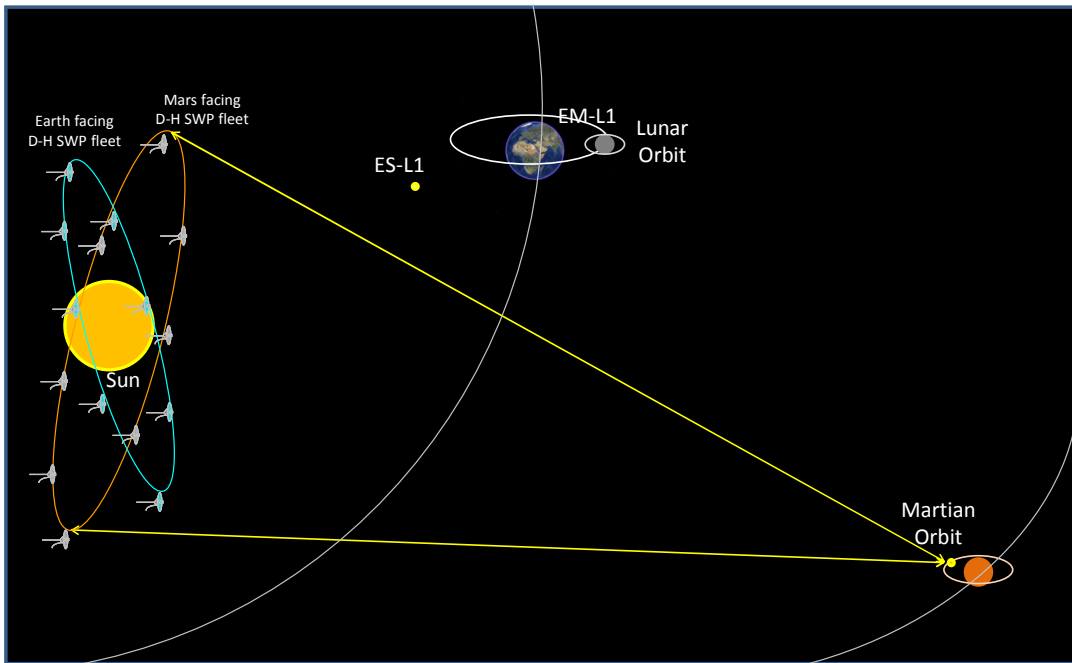

Figure B.3-2, Coupling Power from D-H SWP Mars Facing Fleet to/from ISS 6

For communications services, especially between the Earth-Moon system and the Martian system, it would be rather more complex. Let us suppose a message transmission was initiated at the Lunar orbiting station, and was intended for the Martian orbiting station. In this scenario there must be a receiving spot beam already on the lunar station, provided by at least one of the E-M D-H fleet of satellites, presumably under some form of central control. The message would then pass from the Lunar orbit to solar orbit. Now there would need to be some form of sat-to-sat cross-strapping or inter-satellite communication between the E-M fleet and the Martian fleet of satellites, in order to pass the message from one fleet to another, and then it would be transmitted again from the Martian fleet to Martian orbit, where it would be received and decoded.

This may sound a bit roundabout, since the message has had to travel 1 AU from the Earth-Moon system to a fleet in solar-centric orbit, to another fleet in solar centric orbit, and back out 1.5 AU to Martian orbit. But recall that when the Earth and Mars are in direct opposition, they are already 3.5 AU apart, so that the only difference in this case is that the distance is split by a signal amplifier roughly in the middle. Thus this system takes the worse case communication challenge between the two systems and splits it up into more manageable pieces, and powers this infrastructure with naturally occurring solar wind.

A conceptual picture of how the Dyson-Harrop SWP satellites would be configured to support the Nav (SPS) and Com (SCS) missions is depicted in figure B.3-3. This version has Com transmit using lasercom, and an RF receive dish that could be cross-strapped with other D-H SWP satellites in the same orbit for a larger effective aperture via interferometric means for better sensitivity to weak and poorly directed received signals. The navigation signal is also assumed to be in the RF. Cross strapping to the Mars facing fleet would also be via lasercom.

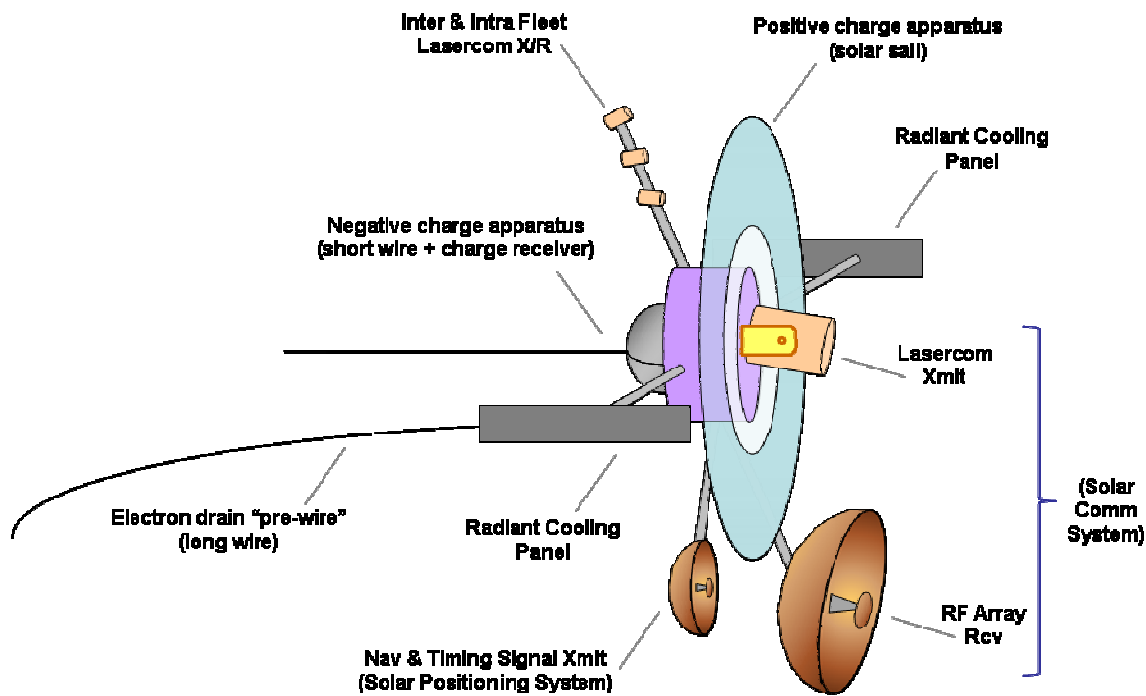

Figure B.3-3, Dyson-Harrop Solar Wind Powered Satellite with Nav, Com Payloads

A Solar Positioning System (SPS) and Solar Communications Service (SCS) of a planetary scale will require a significant level of command, control, and communication (C3) inputs to manage the satellite fleets and data traffic. As depicted in figure B.3-1, the ES-L1 station, or ISS4, would be in a natural position to supply this since it is geometrically visible to the sun at all times, and would therefore be visible to the Earth facing D-H SWP fleet at all times. Therefore C3 data and digital traffic could be routed from Earth and the other Earth-Moon system stations by connecting first through the ES-L1 station. This would require an alternate design from what was presented in Appendix A, where the focus was on solar energy collection. A repurposed version of the ES-L1 station is shown in figure B.3-4. Separate antennas are depicted to link with each D-H satellite in the Earth facing fleet, as well as redundant pairs of antennae for the Earth, EM-L1, and Lunar stations. Additional antennae could also be added to service ES-L2 as well, if need be.

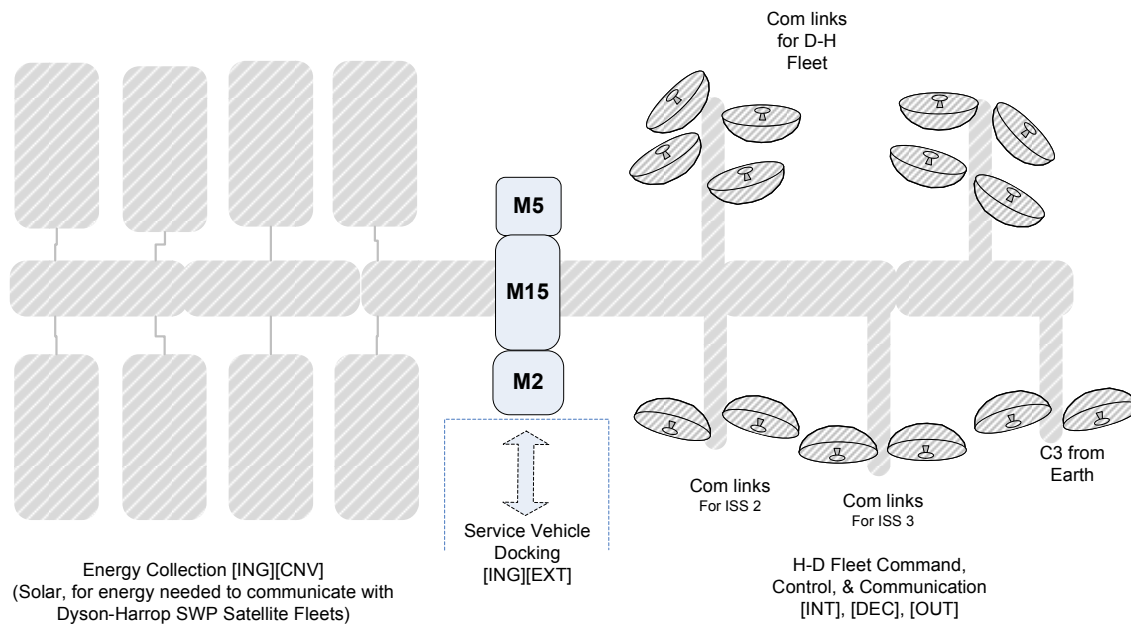

Figure B.3-, Dyson-Harrop Solar Wind Powered Satellite with Nav, Com Payloads

Presumably the solar energy to rocket fuel conversion could be moved to EM-L1 if ES-L1 is repurposed for interplanetary com (SCS) and nav (SPS) data link support. A full requirements set for [INT] and [OUT] living systems categories could be developed by aggregating the requirements for all six human staffed stations.

Appendix B References

[B1] Harrop, Brooks, and Schulze-Makuch, Dirk, "The Solar Wind Power Satellite as an alternative to a traditional Dyson Sphere and its implications for remote detection," *International Journal of Astrobiology* **9** (2): 89-99 (2010), Cambridge University Press.

[B2] Goto, Koji, Araki, Ken'ichi, and Yasukawa, Koji, "Effects of antenna pointing errors on the design of heterodyne optical intersatellite communications" Article first published online: 23 MAR 2007, DOI: 10.1002/ecja.4410740311

[B3] Lee, Shane, "GPS System Fundamentals," Presented to Northwestern Polytechnic University, 10/28/2006, http://www.npu.edu/seminars/files/Shane_Lee_10282006.pdf

Appendix C, Astrogator Navigation Status Display for Interplanetary Travel

A description of the associator [ASC] / network [NET] to decider [DCD] human machine interface (HMI) for interplanetary navigation status is developed here as an example of the realization of requirements that must depend on human factors for maximizing utility.

C.1 Background, Statement of Need, and Requirements Development

The “Astrogator” as a navigation aid first came to the author’s attention as part of the Science Fiction classic “Forbidden Planet.” [C1] While the application in the context of the fictional story was interstellar travel, the lesser problem of navigating interplanetary travel addresses a similar need: in a highly autonomous traveling environment, well away from any meaningful realtime interaction with Earth-bound ground control, what presentation format of navigation information would meet the needs of an on-board human presence? Couched in terms of Living Systems Theory, what presentation layer interface is required between the computer programs [ASC] and networks [NET] that hold navigation information, and the humans, or deciders [DCD] that must understand and be prepared to act on such navigation data in a realtime environment, especially if the context is in response to an unplanned emergency incident? This is the topic addressed by the present section, Appendix C.

Notwithstanding remarkable improvements in orbital dynamics design tools [C2,3,4] there is to the author’s knowledge no existing standard for astronavigation data presentation. This oversight will clearly need to be addressed before deep space ground control free navigation becomes possible. To develop the requirements for such a realtime navigation aid it is beneficial to return first to the most essential human needs to provide a basis for human factors requirements of the human machine interface. The physical needs of breathable air, food, clothing, and shelter have already been dealt with in the main body of the paper in terms of the needed logistics and necessary life support systems already incorporated in the current ISS, and expanded by extrapolation to the other space stations after deployment. The present problem of this appendix goes beyond these static physical needs in two important ways:

- 1) It needs to present data that is not static, but displays potentially highly dynamic data in a realtime manner with low latency.
- 2) It needs to address human needs not in the physical domain, but in the information domain, and thereby addresses the emotional needs rather than the physical needs.

The second difference is perhaps the more important one – the basis for our human factors requirements are not physical needs, they are emotional and psychological. Human factors therefore must be derived by those human needs that are absolute givens which must be met. [C5] These needs can be summed up by the following the ten main innate emotional needs [C6]:

- 1) *Security* — a safe territory and an environment which allows us to develop fully
- 2) *Attention* (to give and receive it) — a form of nutrition
- 3) Sense of autonomy and *Control* — having volition to make responsible choices
- 4) Being emotionally *Connected* to others
- 5) *Belonging* - Feeling part of a wider community
- 6) *Friendship*, intimacy — acceptance of others
- 7) *Privacy* — opportunity to reflect and consolidate experience
- 8) Sense of *Status* within social groupings
- 9) Sense of *Competence* and *Achievement*
- 10) Having *Meaning* and *Purpose* — being useful, and stretched in what we do and think

During space travel knowledge of the location and physical state of the craft in which we are travelling impacts and addresses many of these essential needs. Number one, knowing at a glance where you are and what the orientation is of the vehicle in which you are traveling is enormously beneficial in terms of providing a sense of security. It also proves a strong sense of autonomy and control, especially when the navigation data presented can be used to provide control over guidance decisions, course corrections, and emergency induced orientation errors such as anomalous spin states. To be able to correct for a spin one must first understand what spin you are undergoing. Human readable navigation aids, when coupled with human control over navigation & guidance, also greatly enhance the sense of competence, achievement, meaning, and purpose, which all spring from knowing ones duties, the training to perform them well, and then actually performing them in a real world setting, even under adverse circumstances. Being provided with timely and easily understood navigation data would help with all of these goals, which are 40 % of the original 10 needs listed, and one could argue nearly all of those under control of a design engineer.

Let us next turn to the translation of these goals into design requirements. Knowing where we are, in what orientation we are in, and how far along we are in our journey, will all provide for a sense of security. Knowing where we are in space is a relative requirement – where are with respect to what? In interplanetary travel, at least three guideposts are important with respect to position: where are we with respect to the Earth, the source of intellectual guidance, where are we with respect to the Sun, the source of power and inertial reference, and where are we with respect to our goal, the source of mission objectives and completion? This is the knowledge that gives us a sense of security during the course of an interplanetary journey. It is therefore important to have a sliding linear scale that is easily adjusted between scales so as to meaningfully display all three of these linear positions.

We should also know where we are along our journey, that is what our track is in linear space, including what our trajectory has been to date, and what our planned trajectory is going forward, including any planned burns and other maneuvers. This requires not only a knowledge of trajectory path in 3 dimensions, but also the expected time at which any given position will be achieved, the expected and

actual velocity as a function of time, and the acceleration, planned and actual, with durations, for all maneuvers. This should all be displayed in an easily digestible format.

In addressing autonomy and control, it is also important that the accuracy of the display be of a useful order, that is the accuracy should be at a level useful for the human to be able to affect valid and useful input and changes to the navigation and guidance of the vehicle. This is true not only in linear space, but also inertial or rotational space. Thus the dimensions of display should capture not just linear dimensions such as position, velocity, and acceleration, but also rotational orientation, rotational rates, and rotational accelerations, if any. Only with a full complement of positional and rotational states can the human operator be in a position to make informed decisions about if and how to intervene in the navigation and guidance of a planned sequence of maneuvers and update them as necessary. In the next section of this appendix we study how these requirements can be met with a very simple set of symbology that is easily interpreted.

C.2 Presentation Design Development

A notional picture of how a display of linear orientation might look is presented in figure C-1:

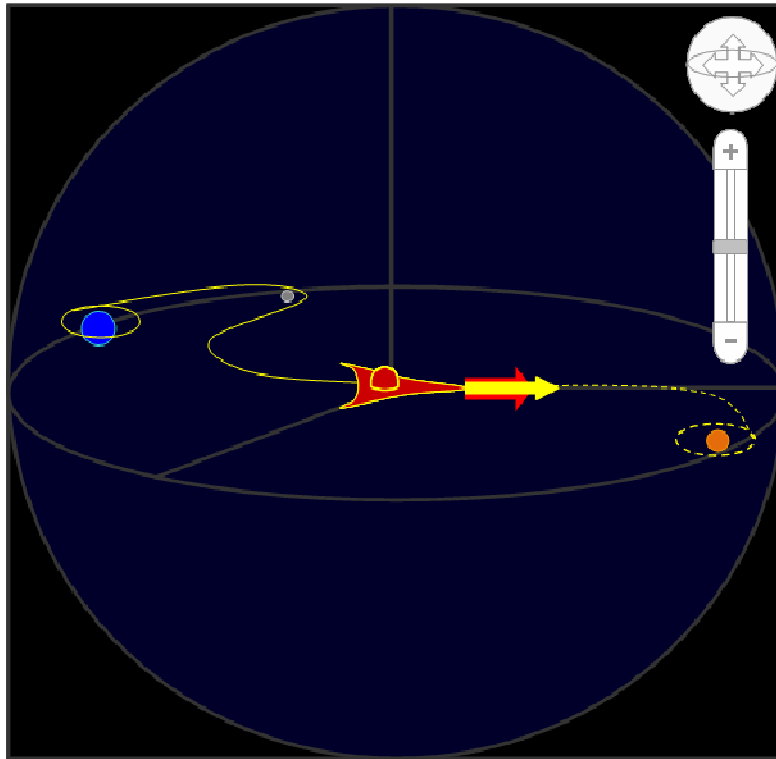

Figure C-1, Astrogator Display – Linear Orientation Indicator

Presumably this display could be supplemented with selectable linear dimensions to the Sun, to the Earth, or to other objects within the solar system, as interest dictates, possibly by hovering over the neighboring objects in question. The velocity vector is represented here in yellow, and the acceleration vector in red, and would in general not necessarily be in the same direction. By selecting with a cursor or hovering over

one should be able to display the current magnitudes and directions of each in engineering units. Hovering over the trajectory should also give a history of past positions, velocities, and accelerations for past locations, or planned positions, velocities, and accelerations for future extrapolated positions.

A picture of how a display of a rotational orientation might look is presented in figure C-2:

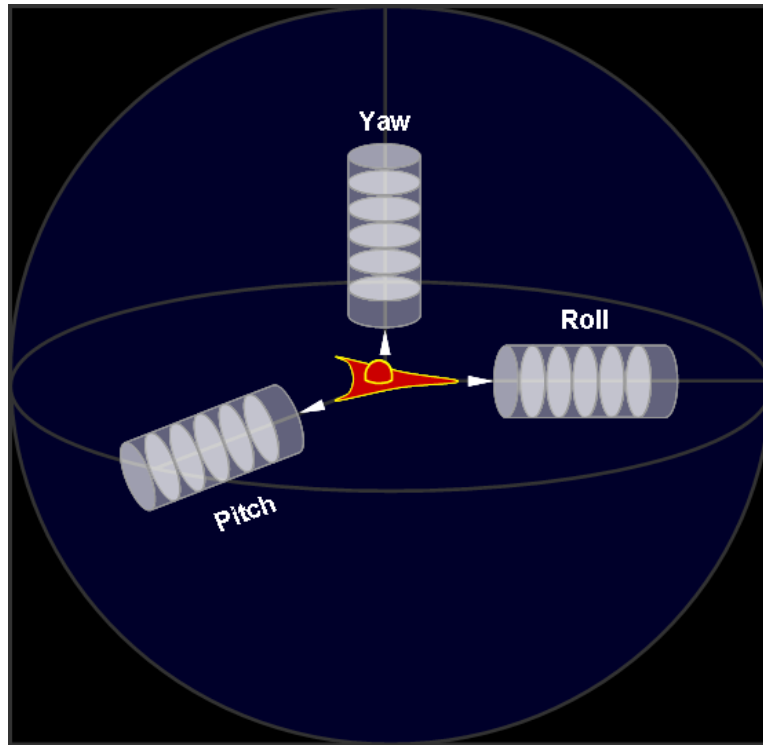

Figure C-2, Astrogator Display – Angular Orientation Indicator

Here only the rotational states are presented, without linear state information, and they are shown separately for each of three rotational axes: pitch, yaw, and roll. A barrel format is chosen along each axis for simplicity, to display at a glance what order of magnitude of rotation is occurring. If there is no rotational rate, and the vehicle is oriented in the plane of the ecliptic exactly along an intended trajectory, there will be no rotational parameters indicated. This is essentially what is shown in figure C-2.

Let us now study how we might use the proposed barrel format to indicate the order of magnitude of a given rotational state. Orders of rotational magnitude are presented in figure C-3. On the left, a blank set of rotating discs is shown, and on the right a full complement is populated. Discs are striped so as to indicate a unit size. Those discs indicating the smallest unit size, one microradian, are oriented closest to the vehicle, and those of the greatest magnitude are oriented the furthest away. As a rotation occurs, the corresponding disc turns. If for instance a rotation of 5 urads occurs in pitch, the one microradian pitch disc will rotate by 5 units as measured by the indicator. If a rotation of 5 degrees occurs, the one degree disc will rotate by 5 units, with the lesser discs spinning that much faster to tick off their relative rotations. When rotation is complete the discs stop their rotation.

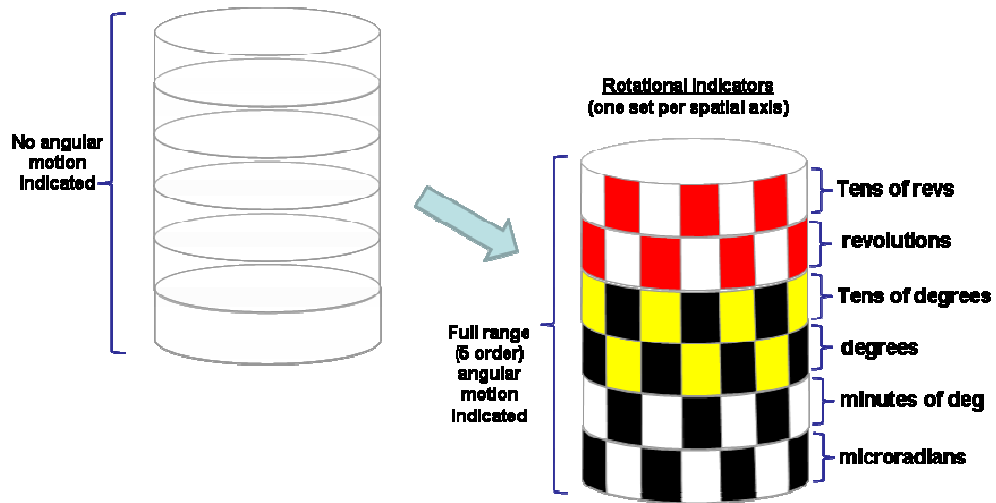

Figure C-3, Angular Orientation Indicator Detail

A nominal rotational display, shown in figure C-4, is contrasted with a fully engaged rotational display, shown in figure C-5.

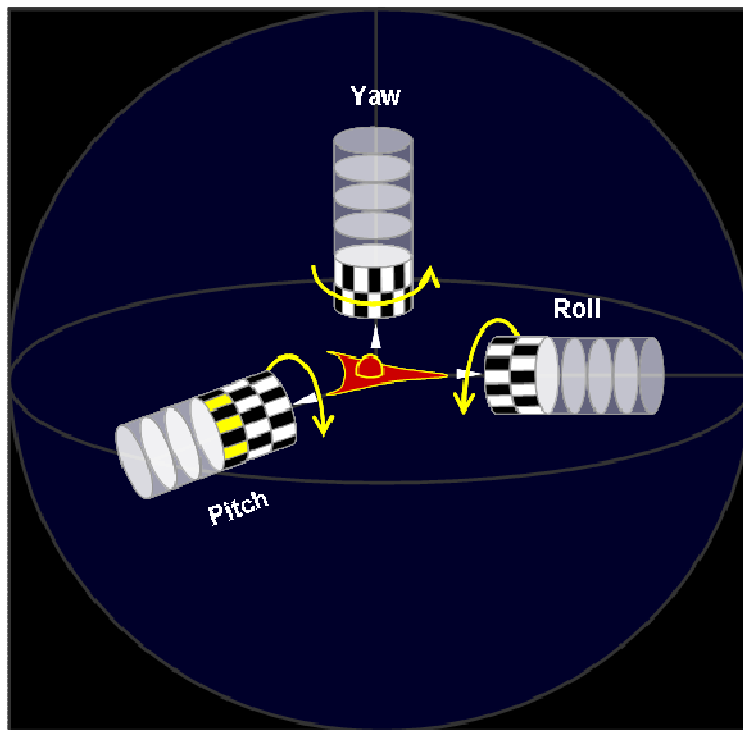

Figure C-4, Astrogator Angular Display – Nominal Angular Motion

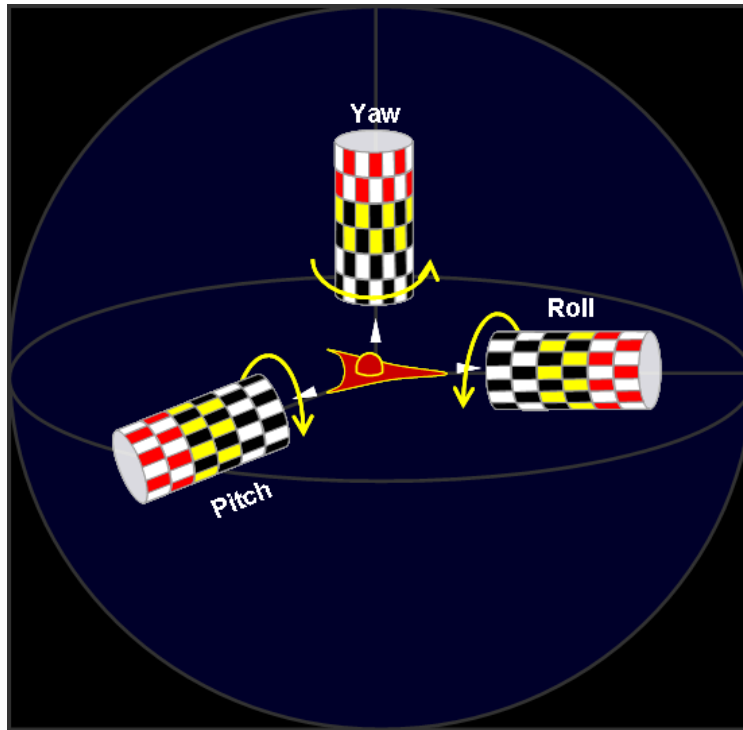

Figure C-5, Astrogator Angular Display – Maximum Angular Motion

One can readily perceive that only under anomalous, emergency circumstances would the outer most discs be caused to rotate. However should this occur, be it caused by an explosion, collision, or some other cause, it would be vitally important for pilots and other occupants of a vehicle to understand the spin state of the vehicle so as to determine immediate corrective action, and the magnitude and direction that such a course of action should take. In this context the Astrogator navigation display becomes an important tool for risk mitigation.

It is recommended that the linear view and rotational view always be presented side-by-side, as shown in figure C-6, to remind the pilots and operators of the importance of both types of states and their interactions.

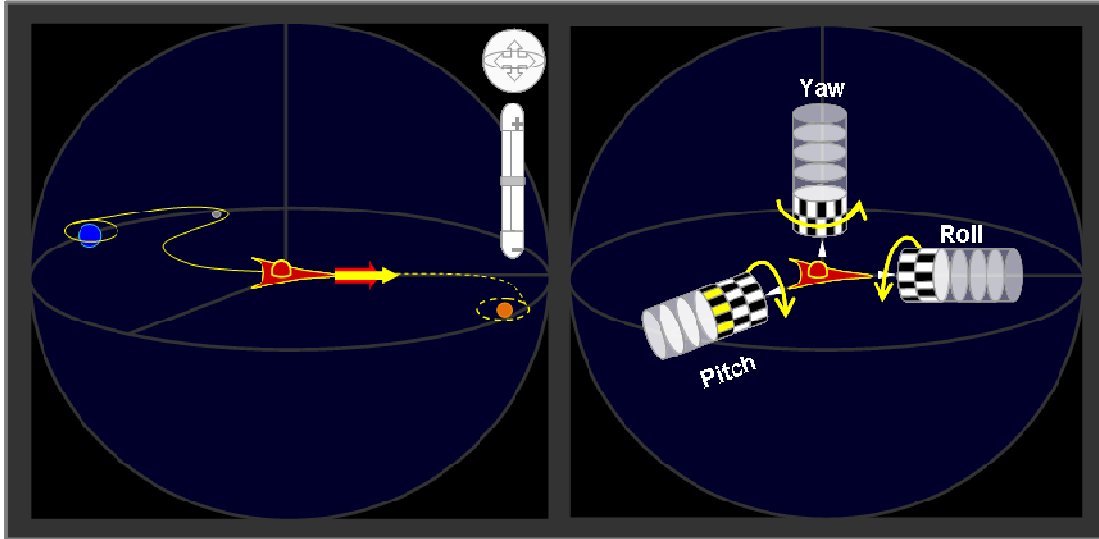

Figure C-6, Recommended Astrogator Display Configuration

Appendix C References

[C1] "Forbidden Planet" movie listing, <http://www.imdb.com/title/tt0049223/>, accessed 11/17/10.

[C2] STK/ Astrogator Product Literature, by AGI Analytical Graphics, Inc., <http://www.agi.com/products/by-product-type/applications/stk/add-on-modules/stk-astrogator/default.aspx>, accessed 11/17/10.

[C3] Guide to Navigating to the Earth Orbit, the Moon, and the Planets, <http://www.astrogatorsquid.com/>, accessed 11/17/10.

[C4] Trajectory Design with STK Astrogator, Mars Orbit Mission Tutorial, http://astrogatorsquid.com/wp-content/Astrogator_Training/Mars_Mission.pdf, accessed 11/17/10.

[C5] Tyrrell, Ivan; Joe Griffin (2004). Human Givens. HG Publishing. ISBN 1-899398-31-7.

[C6] The 10 Essential Emotional Needs: The Mindfields College Blog, <http://mindsalot.wordpress.com/10-emotional-needs-that-must-be-met-for-good-mental-health/>, a website of the Human Givens Institute, accessed 11/17/10.