

# The unification of the forces.

by **Ernesto López González, Eng**  
Col. Coop. San Saturio. Math Department, Madrid, Spain  
[ernesto\\_lopez@colegiosansaturio.com](mailto:ernesto_lopez@colegiosansaturio.com)  
April 2015 Revised May 2015

## Abstract

**Background** In previous papers it was set out that matter could be considered to be formed by gravitational pulsations in a six dimensional space with anisotropic curvature, since solutions to Einstein's field equations presented all of the characteristics of a particle then.

**Results** Four solutions to the gravitational wave equation have been found. These solutions can be assimilated to four neutrinos and complement to the previous solution identified with the electron. Since this set of solutions does not allow the existence of hadrons is postulated the existence of a central hole in the plane of the compacted dimensions. By assuming this postulate we can obtain complementary solutions formed by a surface wave plus any of the other five solutions. These solutions are called glutinos. Linear combinations of these solutions can explain the huge variety of known particles, allowing not only to identify their different charges, but also justify the existence of a multilinear system for hadron masses as advocated by Palazzi. The proposed system also predict the size of mesons and baryons, and the internal distribution of charges. Regarding interactions, they occur via three non-linear mechanisms: by changing the refractive index, deforming and dragging on propagation medium (space-time). No other interaction is possible. The first two are the source of the gravitational interaction, the residual nuclear force and the London interaction, while the latest is the origin of interactions similar to the electromagnetic interaction. These interactions have been called electrostrong, electromagnetic and electroweak interaction. We can obtain mathematically these interactions from the probability density of the wavefunction or from the wavefunction gradient.

**keywords:** *Quantum Mechanics , Force Unification*

# 1. Background.

In previous papers it was set out that matter could be considered to be formed by gravitational pulsations in a massless six dimensional space with anisotropic curvature, since solutions to Einstein's field equations presented all of the characteristics of a particle then.

Specifically a space formed by three extended spatial dimensions, two compacted spatial dimensions (which would form an ellipse of about  $3 \cdot 10^{-6}$  m with a relationship between major and minor semiaxes equal to  $1.10576 / 0.8883$ ) and one temporal dimension was explored. These dimensions can be described using an elliptic cylindrical coordinates system: the extended dimensions are described by Cartesian coordinates  $x, y, z$  and the plane of compacted dimensions is described by elliptical coordinates:

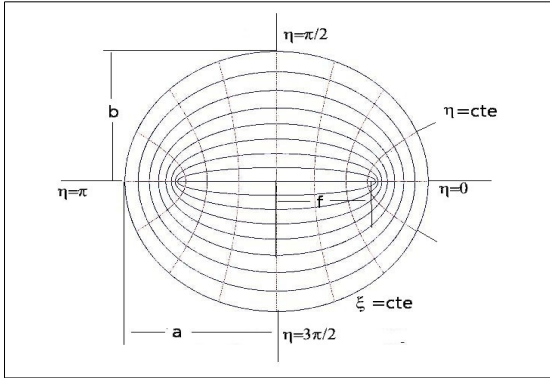

The curves with  $\xi = \text{constant}$  representing confocal ellipses, while the curves with  $\eta = \text{constant}$  are hyperbolas perpendicular to the ellipses. The dimension  $\xi$  is related to the inverse of the mass of elementary particles by the equation  $\xi_0 = \frac{\hbar}{2m_0c}$  and the dimension  $\eta$  is identified with the imaginary coordinate of the Minkowski's spacetime. It's remarkable that due to the above statement the concept of time, while still maintaining its dimensional nature, lose its geometric interpretation.

## 2. Gravitational wave equation.

Because of the difficulty to solve the Einstein field equations in these conditions the weak field approximation known as gravitomagnetism was used. The gravitomagnetic field is almost analogous to the electromagnetic field, except for two details, the first is that the gravitational field can not be negative and the second is that two parallel streams of mass repel each other rather than be attracted. In these conditions it is possible to obtain this wave equation:

$$\vec{\nabla}^2 \vec{E}_g + k^2 \vec{E}_g = 0$$

The first difference causes that if we observe two waves with the same frequency, the electromagnetic wave has a wavelength twice longer than the gravitomagnetic wave, therefore the wave number  $k$  should be defined as  $k = \frac{\pi}{\lambda}$

Due to the spacetime topology gravitational waves can not move freely, but must conform to very strict boundary conditions. The most similar physical phenomenon is found in the transmission of electromagnetic waves through an elliptical wave guide, although in this case the confinement is due to the curvature of space and not to a metallic wall.

The six dimensional wave equation would be  $(\nabla_{6D}^2 + k^2) \cdot H = 0$ . The Laplacian in elliptic-cylindrical coordinates is separable and is equal to  $H(\xi, \eta, x, y, z) = D(\xi, \eta) \cdot F(x, y, z)$  and as is usual in the waveguide calculations we can decompose the wave number on 2:  $k^2 = \beta^2 + k_c^2$  where  $\beta$  is the "propagation constant" and  $k_c$  is the "cutoff wavenumber" and it represents the wavenumber at which a mode ceases to propagate through the guide.

$$\frac{\nabla_{\xi, \eta}^2 D(\xi, \eta)}{D(\xi, \eta)} + k_c^2 = 0$$

$$\frac{\nabla_{3D}^2 F(x, y, z)}{F(x, y, z)} + \beta^2 = 0$$

The first equation represents the problem in the compacted dimensions, while the second represent the problem in the extended dimensions. In [1] a solution to the first equation was developed and identified with the electron.

### 3. Solutions to the wave equation in the compacted dimensions.

In order to solve the equation  $\frac{\nabla_{\xi, \eta}^2 D(\xi, \eta)}{D(\xi, \eta)} + k_c^2 = 0$  is postulated that  $k_c$  is imaginary and equal to  $k_c = \frac{m_0 c}{\hbar} i$ .

The solution for the plane of the compacted dimensions is a stationary wave which is expressed through  $\frac{1}{2}$  order Mathieu functions and parameter  $q = \frac{k_c^2 f^2}{4}$  where  $f$  is the focus of the ellipse formed by the compacted dimensions. Since the wavenumber is imaginary the parameter  $q$  is negative.

If we decompose  $D = D(\xi, \eta) = G(\xi) \cdot N(\eta)$  then solutions are known:

The angular solution  $N$  is expressed as the absolute value of the odd angular  $\frac{1}{2}$  order Mathieu function (also known as elliptical sine). The periodicity of this function is  $4\pi$ , but how we choose the absolute value its periodicity is reduced to  $2\pi$ .

$$N(\eta) = \left| se_{\frac{1}{2}}(\eta, -q) \right|$$

Since  $q$  is negative radial solutions must be composed of linear combinations of radial evanescent Mathieu functions. These functions can be odd or even, and of first or second type.

The computation of the Mathieu functions has been made numerically by a number of products of Bessel functions (McLachlan. Theory and applications of Mathieu functions). The algorithms have been implemented in Javascript and because of the high value of  $q$  a logarithmic number system is used in order to handle larger numbers than the 32-bit floating point system allows. Computer routines are available on request in the email of the first page.

On the next page are presented graphically the possible forms of these solutions.

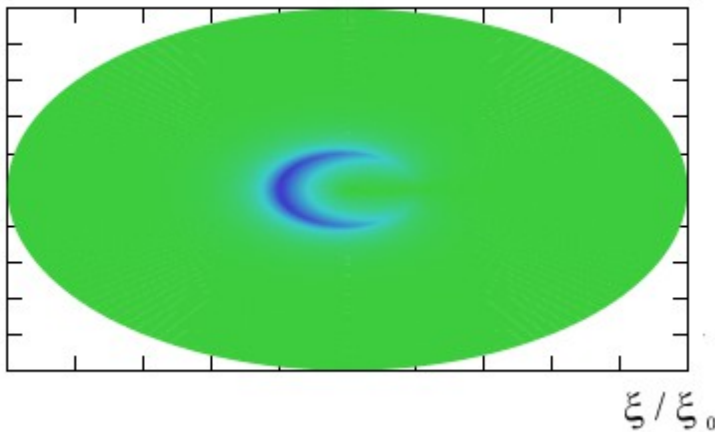

SOLUTIONS TYPE I

Odd function first type order 1/2  $I_{o1/2}(2k_c\xi, -q)$

Even function first type order 1/2  $I_{e1/2}(2k_c\xi, -q)$

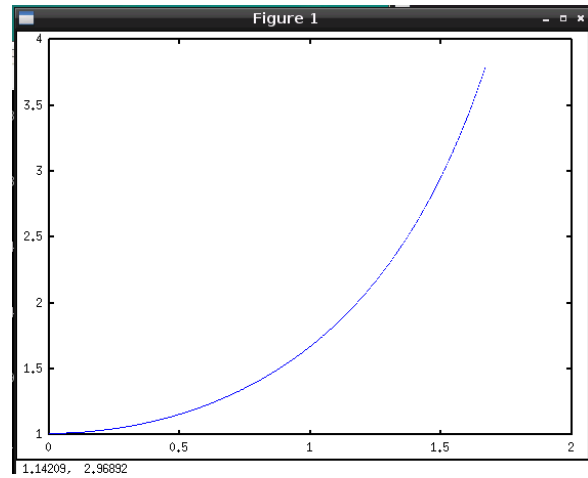
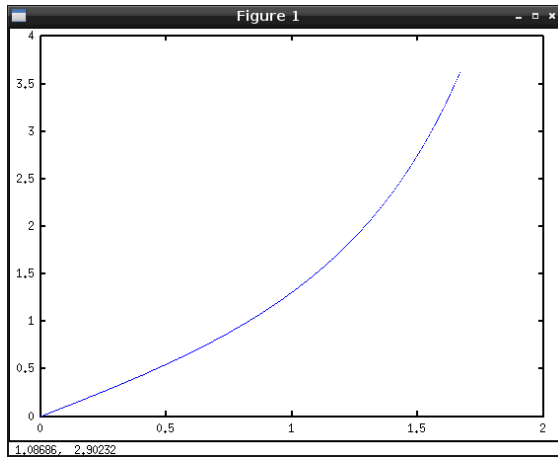

Notice that  $I_e(0, -q)$  is nonzero.

SOLUTIONS TYPE II

Odd function second type order 1/2  $K_{o1/2}(2k_c\xi, -q)$

Even function second type order 1/2  $K_{e1/2}(2k_c\xi, -q)$

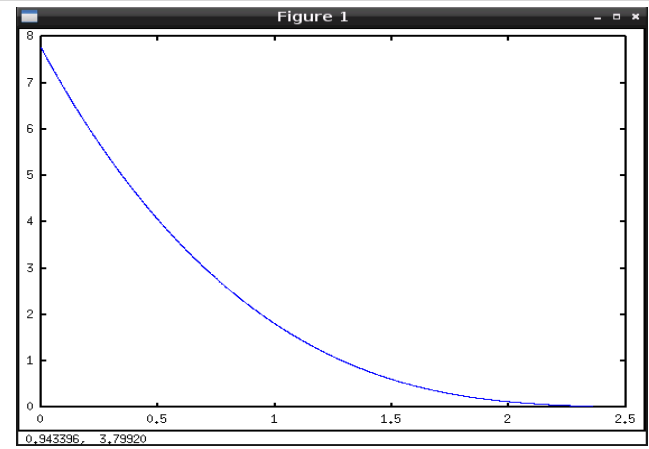
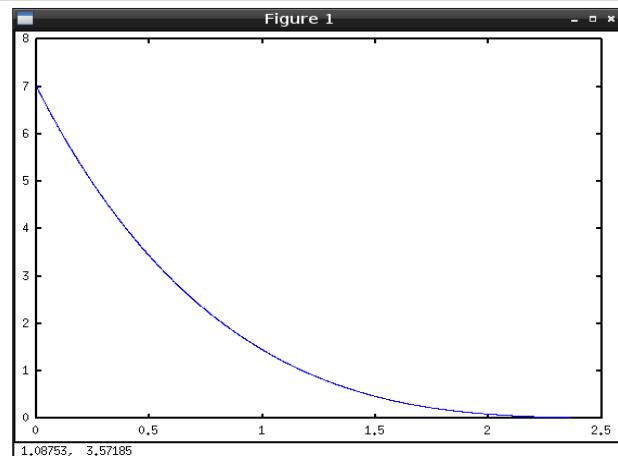

Apart from the above solutions it is possible to combine both in the coordinate  $\xi_0 = \frac{\hbar}{2m_0c}$  in order to obtain the

SOLUTIONS TYPE III

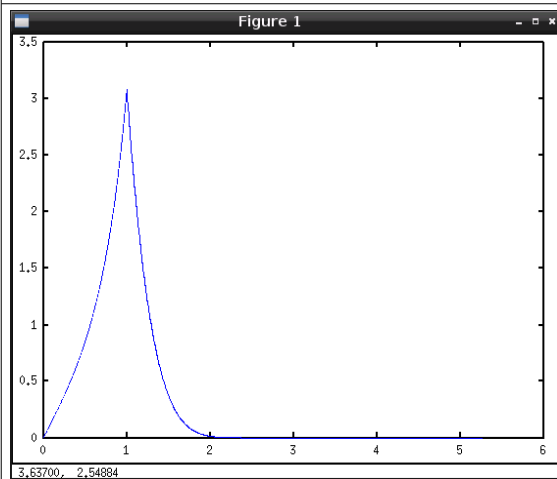

If  $0 < \xi < \xi_0$   $G(\xi) = I_{o1/2}(2k_c\xi, -q) = I_{o1/2}\left(\frac{\xi}{\xi_0}, -q\right)$

*order 1/2 first type radial evanescent Mathieu function*

If  $\xi > \xi_0$

$G(\xi) = K_{o1/2}(2k_c\xi, -q) = K_{o1/2}\left(\frac{\xi}{\xi_0}, -q\right)$

*order 1/2 second type radial evanescent Mathieu function*

ODD SOLUTION

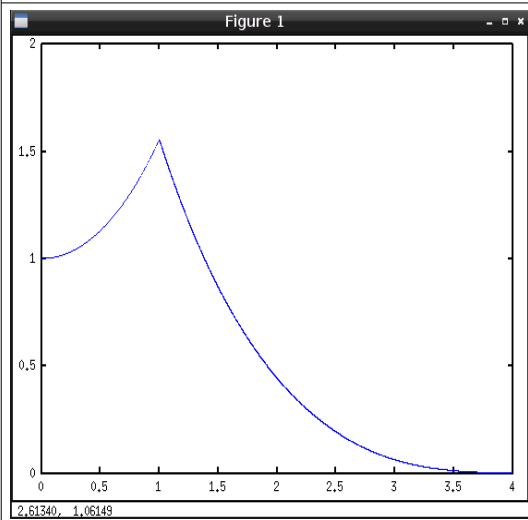

If  $0 < \xi < \xi_0$   $G(\xi) = I_{e1/2}(2k_c\xi, -q) = I_{e1/2}\left(\frac{\xi}{\xi_0}, -q\right)$

*order 1/2 first type radial evanescent Mathieu function*

If  $\xi > \xi_0$

$G(\xi) = K_{e1/2}(2k_c\xi, -q) = K_{e1/2}\left(\frac{\xi}{\xi_0}, -q\right)$

*order 1/2 second type radial evanescent Mathieu function*

EVEN SOLUTION

Since there are no walls but confinement of the wave is produced by the curvature of compacted dimensions the boundary condition is that the center of gravity of the square wave function must be in the coordinate  $\xi_0 = \frac{\hbar}{2m_0c}$  in order to meet one of the fundamental postulates of the hypothesis. This implies that the product  $2k_c\xi_0$  would be equal to unity. The values that satisfy this condition are:

Tipo	q
Io	-0,0586
Ie	-0,0785
IoKo	-252,5
IoKo	-435
IoKo	$-4,35 \cdot 10^9$

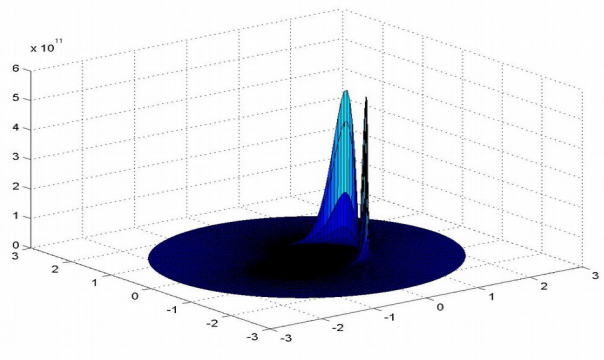

Illustration 1: Example of solution type IoKo for the compacted dimensions.

## 4. Stable Solutions. Neutrinos, electrons and glutinos.

The tentative value for q in the electron case can be achieved using a tentative universe radius of  $r_u = \sqrt{\frac{G}{2\pi}} = 3,25 \cdot 10^{-6}$ , a semiaxes ratio of 1,10576/0,8883 and a wavenumber equal to  $k_c = \frac{mc}{\hbar} = 2,5896 \cdot 10^{12}$  :

$q \approx \frac{k_c^2 f^2}{4} = \frac{(2,5892 \cdot 10^{12} i)^2 [\sqrt{1,10576^2 - 0,8883^2} \cdot 3 \cdot 10^{-6}]^2}{4} = -5,8335 \cdot 10^{12}$ . If we assign the largest solution to the electron we can determine the masses of the remaining particles:

Particle	Type	q	m/me	estimated m
$\nu_e$	Io	-0,0586	$3,67 \cdot 10^{-6}$	18,75 eV
$\nu_\mu$	Ie	-0,0785	$4,24 \cdot 10^{-6}$	21,66 eV
$\nu_\tau$	IoKo	-252,5	$2,41 \cdot 10^{-4}$	1231,50 eV
$\nu_x?$	IoKo	-435	$3,18 \cdot 10^{-4}$	1624,97 eV
$e^{+-}$	IoKo	$-4,35 \cdot 10^9$	1	0,5109989 MeV

You can easily verify that these solutions justify the existence of the three known neutrinos, one more failing to confirm and electrons, however the existence of hadrons can not be justified. Therefore lack a particle.

In order to allow the existence of hadrons is postulated that the universe has a central hole, so that the solutions of type II can exist as surface waves on the inner limit of the universe.

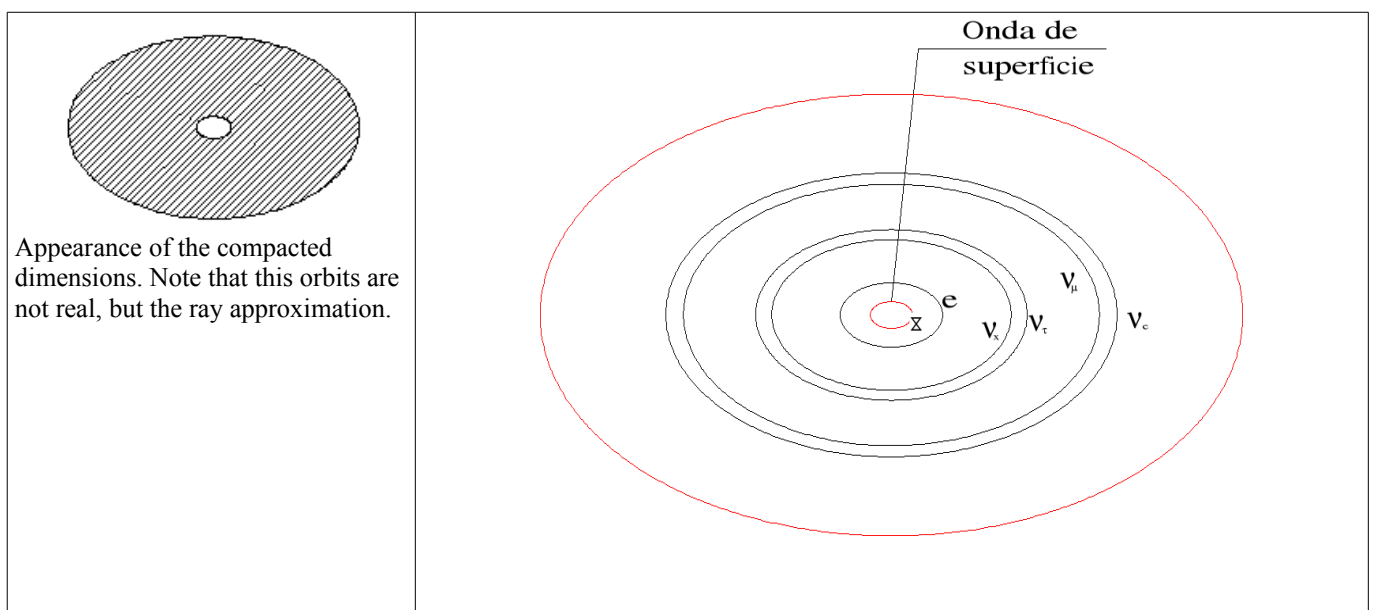

By themselves, type II solutions can not satisfy the boundary condition (the center of gravity of the square of the wave function must be in the coordinate  $\xi_0 = \frac{\hbar}{2m_0c}$ ) and so they must appear in linear combination with some of the stable solutions.

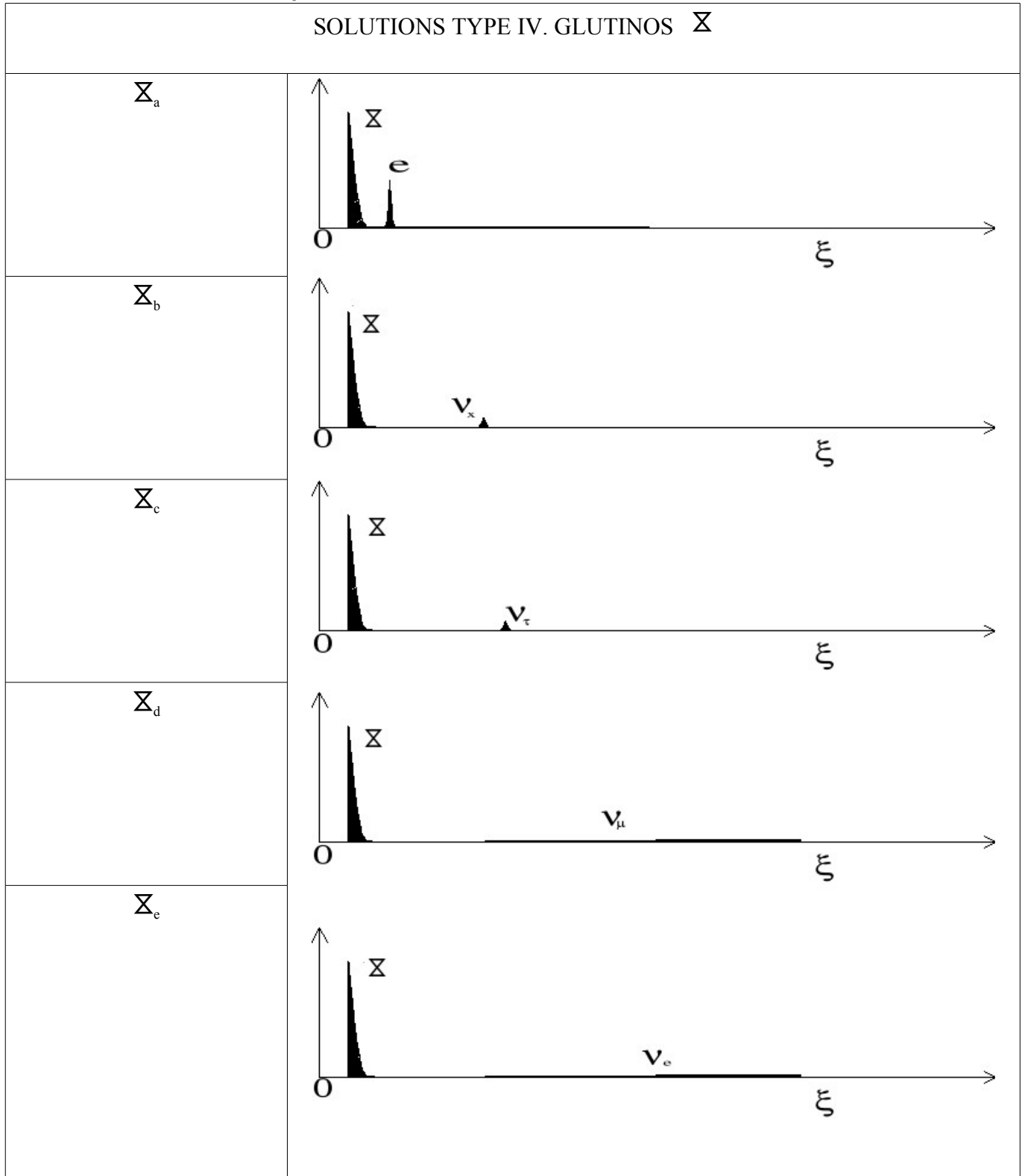

We have assigned Iberian alphabet letter  $\Sigma$  to surface waves type II, pronounced as ko, and the name glutino, because of its relationship with the strong interaction. Since the mass of a linear combination should be placed between the mass of the constituent waves and due to the large mass difference between electrons and neutrinos it seems evident that glutinos can be classified in heavy glutinos  $\Sigma_a$  and light glutinos ( $\Sigma_{b \rightarrow e}$ ). Therefore, all particles should be obtained by linear combination of any of these solutions.

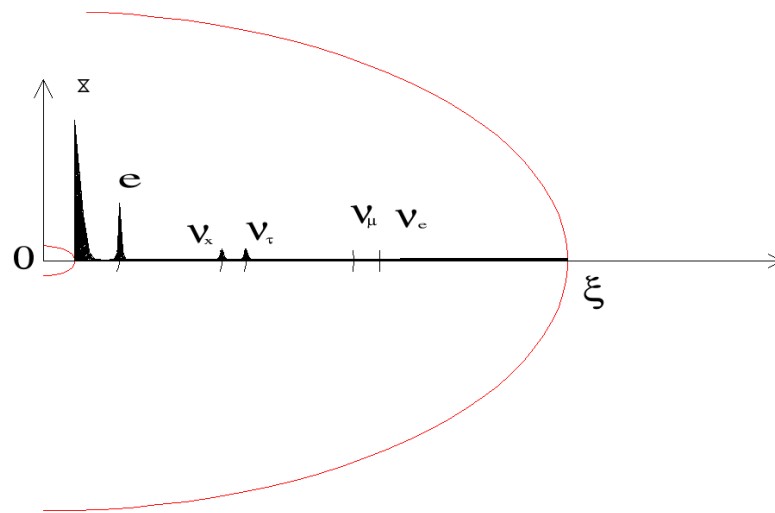

The wave coupling phenomenon helps explain the oscillation between neutrinos and even between different types of glutinos.

## 5. Interactions.

In a previous paper (Mechanisms of Interaction Between Gravitational Waves.) it was showed that standing waves that form the particles modify the propagation medium (spacetime) through three non-linear mechanisms: by changing the refractive index, deforming and dragging on propagation medium. No other interaction is possible. The first two mechanisms occur in the extended dimensions and would produce the force of gravity, while the latter mechanism occur in the compacted dimensions and would produce force between parallel streams of mass and therefore electrostrong, electromagnetic and electroweak forces.

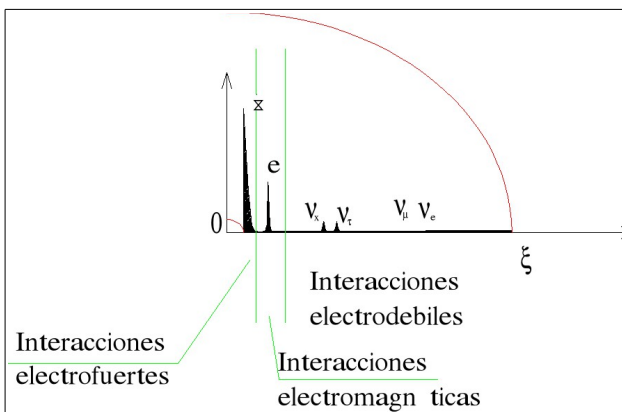

Due to the shape of the radial wave functions it is easy to see that electronic and muon neutrinos interact weakly with the other pulsations, while glutinos, the other neutrinos and electrons interact only with themselves or with any linear combination containing them.

The relative intensity of these interactions can also be clearly observed.

Is important to stress that as glutinos can not exist separately, their different combinations will have one or more of the possible interactions.

For example  $\sum_a$  glutino will be affected by gravity (changes the refractive index and deforms propagation medium) and by

electromagnetic and electrostrong forces. This glutino will interact weakly with electronic and muon neutrinos, since it drags the propagation medium not in the whole area of the compacted dimensions, but only in part of these. For the same reason this glutino will not interact with the other two remaining neutrinos, except by gravity.

Analogously  $\sum_c$  glutino will be affected by gravity (changes the refractive index and deforms propagation medium) and by electroweaks and electrostrong forces, but not by electromagnetic forces. This glutino will interact weakly with electronic, muon and tau neutrinos.

In [1] it was determined that the ratio between the charge and the square of mass is constant and therefore we can determine

the relative strength of interactions. 
$$\frac{q_{glutino}}{m_{glutino}^2} = \frac{e}{m_e^2} = \frac{q_{\nu_x}}{m_{\nu_x}^2} = \frac{q_{\nu_e}}{m_{\nu_e}^2} = \frac{q_{\nu_\mu}}{m_{\nu_\mu}^2} = \frac{q_{\nu_\tau}}{m_{\nu_\tau}^2}$$

We should speak of electroweak coulombs, electric coulombs or electrostrong coulombs.



Because of considerations that will be developed below in this paper is assigned a mass of 11.87 MeV/c<sup>2</sup> for light glutinos and 12.91 MeV/c<sup>2</sup> for heavy glutinos.

Particle-pulsation	mass	Type of de interaction	Charge( In equivalent coulombs)	Equivalent fine-structure constant . $\alpha'$
$\nu_e$	18,75 eV	ELECTROWEAK	$2,157 \cdot 10^{-28}$	$1,322 \cdot 10^{-20}$
$\nu_\mu$	21,66 eV	ELECTROWEAK	$2,878 \cdot 10^{-28}$	$2,354 \cdot 10^{-20}$
$\nu_\tau$	1231,50 eV	ELECTROWEAK	$9,304 \cdot 10^{-25}$	$2,46 \cdot 10^{-13}$
$\nu_{x?}$	1624,97 eV	ELECTROWEAK	$1,62 \cdot 10^{-24}$	$7,459 \cdot 10^{-13}$
$e^{+,-}$	0,511MeV	ELECTROMAGNETIC	$1,602 \cdot 10^{-19}$	1/137= 0,00729
$\Sigma_{light}^0$	11,87 MeV	ELECTROSTRONG	$8,644 \cdot 10^{-17}$	2123,89
$\Sigma_{heavy}^{+,-}$	12,91 MeV	ELECTROSTRONG	$1,022 \cdot 10^{-16}$	2971,909

## 6. Composite particles. Hadrons.

Since glutinos have very large electrostrong charges they may be able to form structures similar to the atoms, but united by electrostrong charges instead of electrical charges. The relativistic gravitational wave equation for a potential that decreases with the inverse of the radius gave us the following energy levels:

$$E = -mc^2 \left[ 1 \pm \sqrt{\frac{\alpha'^2}{n'^2 + \alpha'^2}} \right]$$

with  $\alpha' = \frac{q_1 q_2}{\hbar c 4 \pi \epsilon_0}$ ,  $m \rightarrow$  reduced mass,  $n' = n - \delta(l)$ ,  $\delta(l) = l - l'$ , and  $l =$  positive integer, and  $l'$  the solution to the following equation  $l'^2 + l' - \alpha'^2 - l(l+1) = 0$ .

If  $l=0$  (spheric orbitals) then  $l' = \frac{-1 \pm \sqrt{1 + 4\alpha'^2}}{2}$

As for glutinos  $\alpha' \gg \gg \gg 1$  we can make the following approximation:

$l' \approx \frac{-1 \pm 2\alpha'^2}{2} \approx \alpha'^2$ , which gives us the following possible values for energy :

$$E = -mc^2 \left[ 1 \pm \sqrt{\frac{\alpha'^2}{\alpha'^2 + \alpha'^2}} \right] = -mc^2 \left[ 1 \pm \sqrt{\frac{1}{2}} \right], \text{ thus being:}$$

$$E_{BINDING} = -0,2928 mc^2 \text{ or } E_{BINDING} = -1,7072 mc^2$$

The first solution corresponded to the electronic orbitals, but if we observe the neutron decay the first solution would provide us a mass increment equal to  $\Delta M = m(e)(1+0,2928)=0,66 \text{ MeV}$  and the second solution would provide us a mass increment equal to  $\Delta M = m(e)(1+1,7072)=1,38 \text{ MeV}$ , as experimental mass increment is 1.2933 MeV the second solution is chosen.

The above formula justifies a **linear masses system**. Already in 1952 Nambu had proposed that the masses of hadrons were quantized with a quantum of about 70 MeV, actually 35 MeV corresponding the even multiples with the baryons, while mesons are odd multiples.

POSITRONIUM type ( MESONS ) 2 equal waves Spin 0 (Notice that + and - are related to electrostrong charges.)

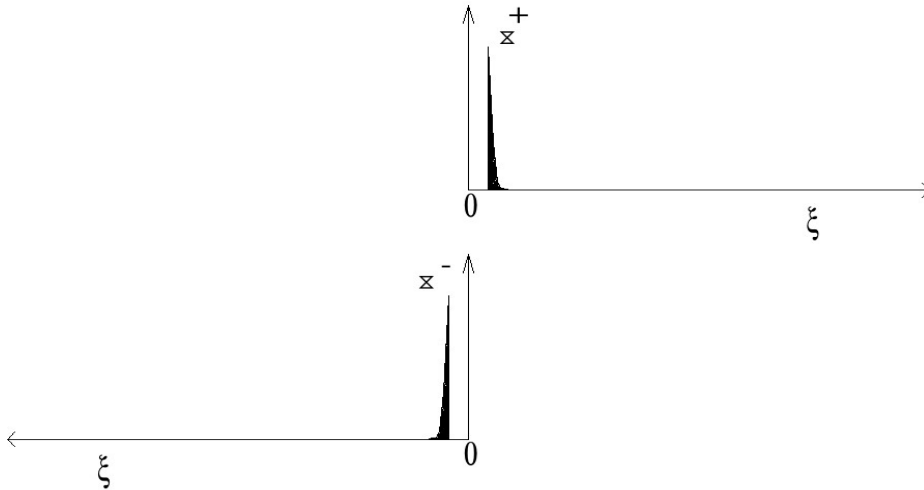

the reduced mass is equal to  $m' = \frac{m^2}{2m} = \frac{m}{2}$  and therefore the binding energy is equal to

$$E_{\text{BINDING}} = 1,7072 m' = 1,7072 \frac{m}{2} = 0,8536 m \quad \text{The total mass will be then } M = 2m + 0,8536 m = 2,8536 m$$

From which we can approximate the mass of glutino  $m_{\text{glutino}} \approx \frac{35}{2,8536} = 12,27 \text{ MeV}/c^2$

HELIUM Type. ( BARYONS ) 3 waves spin 1/2

A.1 Number of glutinos divisible by 4.

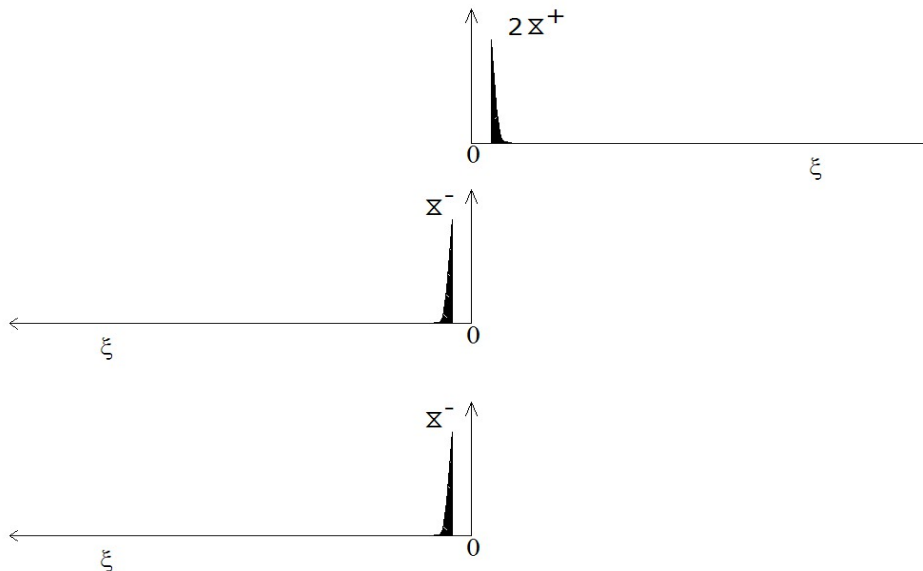

The reduced mass is equal to  $m' = \frac{2m \cdot m}{2m+m} = \frac{2}{3}m$  and therefore the attraction energy will be  $E_{Attraction} = 1,7073 \frac{2}{3}m$  .

However the binding energy is reduced due to the repulsion between glutinos having the same electrostrong charge. This repulsion can be estimated as the equivalent mass of the two lightest glutinos multiplied by 1.7072, but considering that they are also fixed to the highest mass glutino. That is, we will take as a basis the already reduced masses.

$$REPULSION = 1,7073 \cdot \left[ \frac{2/3 m \cdot 2/3 m}{(2/3 m + 2/3 m)} \right] = 1,7073 \frac{m}{3}$$

$$\text{Therefore the binding energy will be: } E_{binding} = 2 \cdot ATTRACTION - REPULSION = 1,7073 \left( \frac{4}{3}m - \frac{1}{3}m \right) = 1,7073 m$$

That is, as in the positron type. Since the positron type is more symmetrical and simple (two waves against three) helio type should be heavily penalized. **This explains why the odd multiples of 35 MeV are preferably mesons.**

A.2 Number of glutinos not divisible by 4, but odds.

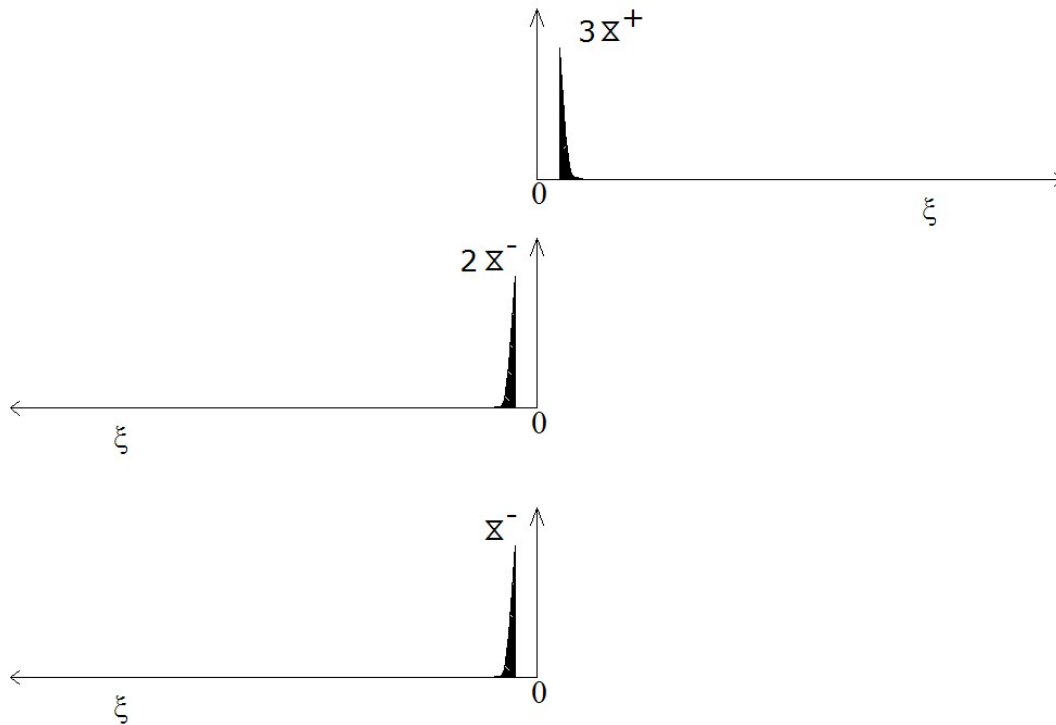

By following the same method of calculation:

$$m'_1 = \frac{3m \cdot 2m}{3m+2m} = \frac{6}{5}m \quad ; \quad m'_2 = \frac{3m \cdot m}{3m+m} = \frac{3}{4}m \quad ; \quad \text{Repulsión} \quad m'_3 = \frac{6/5m \cdot 3/4m}{6/5m+3/4m} = 0,46153m$$

$$\text{Therefore the total mass would be: } M = 3m + 2m + m + 1,7072 [6/5m + 3/4m - 0,46453m] = 8,5411m$$

$$\text{If a meson } M = 3m + 3m + 1,7072m/2 = 8,5608m$$

The baryonic solutions is now highest and thus prevails. **This explains why the even multiples of 35 MeV are preferably baryons.**

The lightest baryon would have a mass equal to  $m_{\mu} = 8,5411 \cdot 12,27 = 104,79 \text{ MeV}$

This estimation is a 0,82 % lightest than muon experimental mass  $m_{\mu} = 105,65 \text{ MeV}$

Previously we had postulated the existence of heavy and light glutinos, but there weren't any reference to the existence of a multilinear mass system for subatomic particles.

Due to the great job of Dr Palazzi it has been possible to overcome this difficulty. His articles have not received the deserved attention, but are fortunately available on its website [www.particlez.org](http://www.particlez.org). Palazzi by applying appropriate statistical techniques is able to systematize the masses of virtually all mesons and baryons by a linear system based on two particles, an uncharged light particle ( $33,88 \text{ MeV}/c^2$ ) that we can identify with light glutinos and another slightly heavier electrically charged ( $36,84 \text{ MeV}/c^2$ ) that we can assimilate to the heavy glutino.

Now we can know glutinos masses

$$m_{\text{light glutine}} \approx \frac{33,88}{2,8536} = 11,87 \text{ MeV}/c^2 \quad m_{\text{heavy glutine}} \approx \frac{36,84}{2,8536} = 12,91 \text{ MeV}/c^2$$

We try to apply the above-mentioned to some of the simplest particles. In baryons the lowest electrostrong repulsion energy is achieved when distance between them is maximized, therefore the two smaller waves have to be as most unequal as possible. Electric charge will accumulate in the 2 inner waves because of electromagnetic charges of different signs tend to be as close as possible.

#### PROPOSAL FOR MUÓN

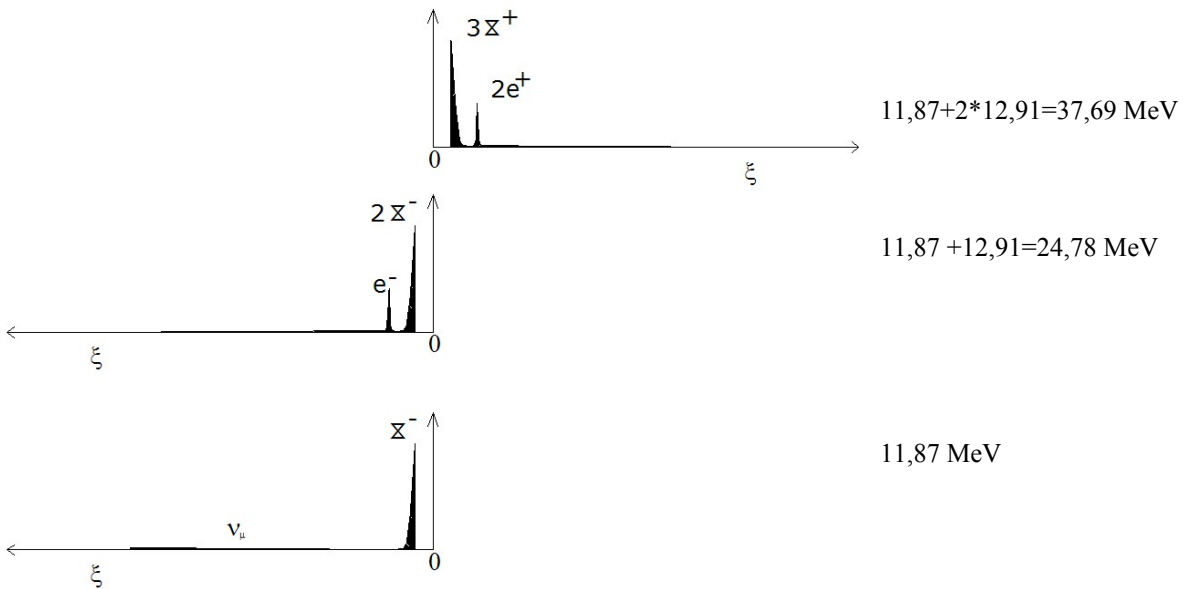

$$m'_1 = \frac{37,69 \cdot 24,78}{37,69 + 24,78} = 14,95 \text{ MeV} \quad m'_2 = \frac{37,69 \cdot 11,87}{37,69 + 11,87} = 9,027 \text{ MeV} \quad m'_{rep} = \frac{-14,95 \cdot 9,027}{14,95 + 9,027} = -5,6285 \text{ MeV}$$

Therefore:

$$m_{\mu} = 37,69 + 24,78 + 11,87 + 1,7072 \cdot (14,95 + 9,027 - 5,6285) = 105,6641 \text{ MeV}$$

As the experimental mass of the muon is  $m_{\mu}=105,6583 \text{ MeV}$  the error decreases to 0,006%.

PROPOSAL FOR  $\pi^0$

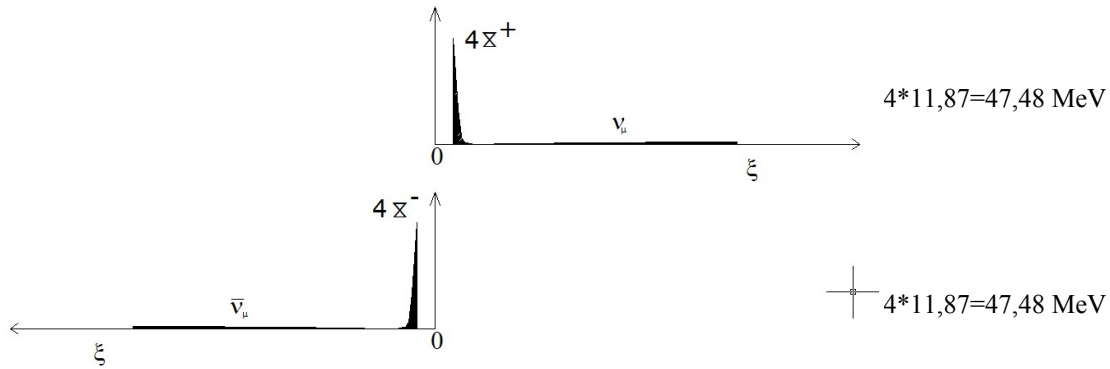

$$m'_1 = \frac{47,48 \cdot 47,48}{47,48 + 47,48} = 23,74 \text{ MeV}$$

$$m_{\pi^0} = 47,48 + 47,48 + 1,7078 \cdot 23,74 = 135,49 \text{ MeV}$$

As the experimental mass is:  $m_{\pi^0} = 135,0 \text{ MeV}$  the error is equal to 0,35%.

PROPOSAL FOR  $\pi^+$

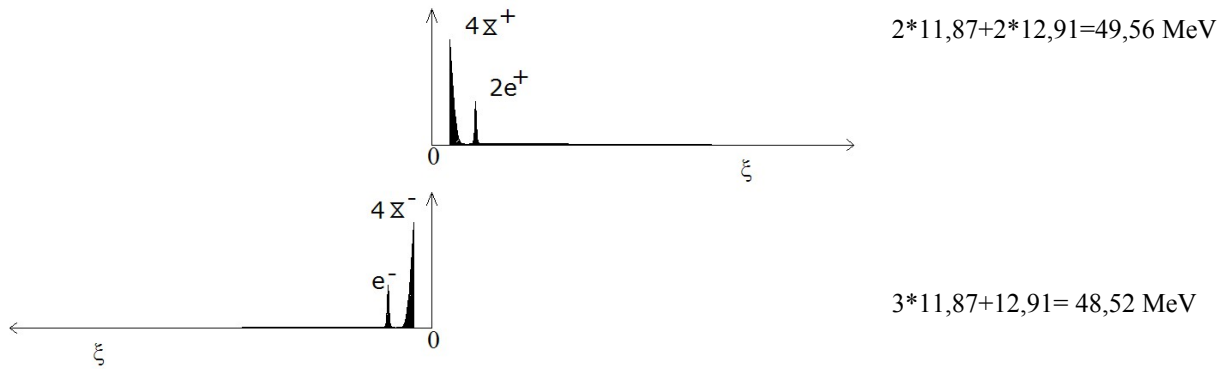

$$m'_1 = \frac{49,56 \cdot 48,52}{49,56 + 48,52} = 24,5172 \text{ MeV} \rightarrow m_{\pi^+} = 49,56 + 48,52 + 1,7078 \cdot 24,5172 = 139,93 \text{ MeV}$$

As the experimental mass is  $m_{\pi^+} = 139,57 \text{ MeV}$  the error is equal to 0,26%.

PROPOSAL FOR PROTON

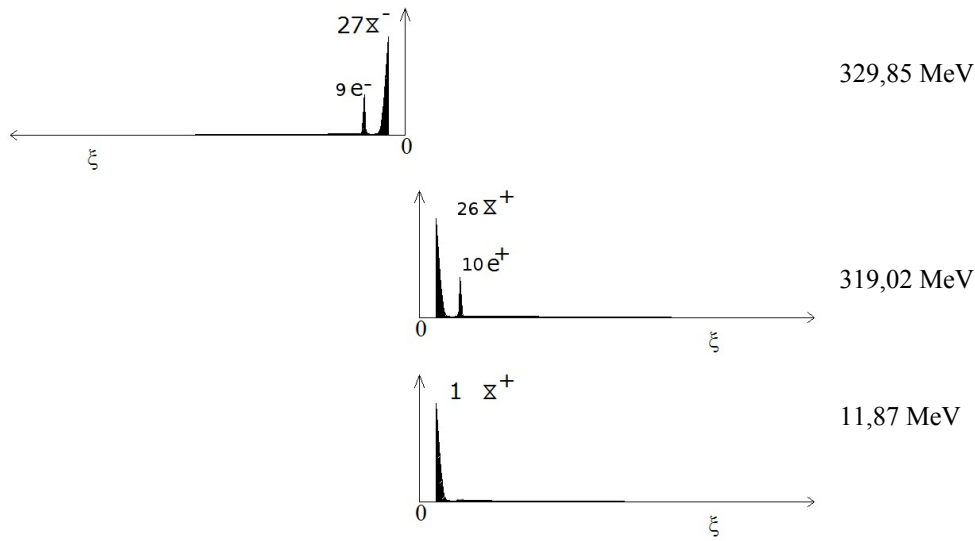

$$m'_1 = \frac{329,85 \cdot 319,02}{329,85 + 319,02} = 162,17 \text{ MeV} \quad m'_2 = \frac{329,85 \cdot 11,87}{329,85 + 11,87} = 11,46 \text{ MeV} \quad m'_{rep} = \frac{-162,17 \cdot 11,46}{162,17 + 11,46} = -10,70 \text{ MeV}$$

Therefore:

$$m_{PROTON} = 329,85 + 319,02 + 11,87 - 1,7072 \cdot (162,17 + 11,46 - 10,70) = 938,88 \text{ MeV}$$

As the experimental mass of the proton is:  $m_{PROTON} = 938,272 \text{ MeV}$  the error is equal to 0,07%.

PROPOSAL FOR NEUTRON

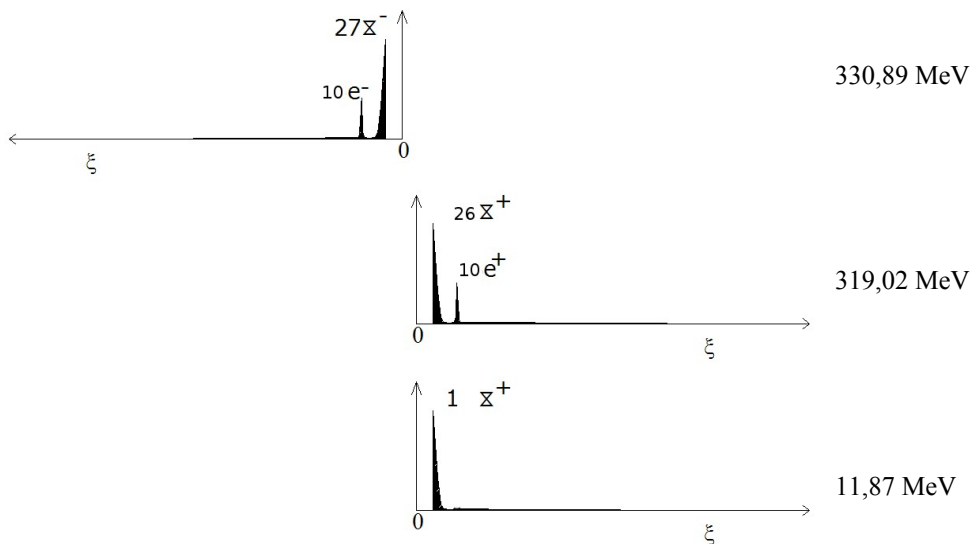

$$m'_1 = \frac{330,89 \cdot 319,02}{330,89 + 319,02} = 162,42 \text{ MeV} \quad m'_2 = \frac{330,89 \cdot 11,87}{330,89 + 11,87} = 11,46 \text{ MeV} \quad m'_{rep} = \frac{-162,42 \cdot 11,46}{162,42 + 11,46} = -10,70 \text{ MeV}$$

Therefore:  $m_{NEUTRÓN} = 330,89 + 319,02 + 11,87 + 1,7072 \cdot (162,42 + 11,46 - 10,70) = 940,35 \text{ MeV}$

As the experimental mass of the neutron is:  $m_{NEUTRÓN} = 939,56 \text{ MeV}$  the error is equal to 0,08%.

Note: there are another possibility for proton (27,+10 ; 26,-9 ; 1,0) instead of (27,-9; 26,+10 ; 1,0) with a mass of 938,84 MeV and for neutron (27,+10 ; 26,-10 ; 1,0) instead of (27,-10 ; 26,+10 ; 1,0) with equal mass

## 7. Hadrons structure. Orbitals and charge distribution.

As was shown in a previous paper (“Matter as gravitational waves. On the nature of electron”) the form of s orbital is unchanged in the relativistic case, since the angular equation remains unaltered. Therefore hadrons will be composed of three spherical shells. For the non-relativistic case the radius  $a_0$  (Bohr radius) is calculated by the following formula:

$$a_0 = \frac{\hbar}{mc\alpha} \quad \text{operating} \quad a_0 = \frac{\hbar}{mc\alpha} = \frac{\hbar}{mc\alpha} \frac{c}{c} \frac{\alpha}{\alpha} \frac{2}{2} \quad \text{and considering that the energy of the orbital is} \quad E_0 = \frac{mc^2\alpha^2}{2}$$

we can write  $a_0 = \frac{\hbar c \alpha}{2E_0} = \frac{\hbar c}{2E_0/\alpha}$

If we extrapolate this relationship to the relativistic case we can write:

$$\frac{E_0}{\alpha} = \frac{-mc^2}{\alpha} \left[ 1 \pm \sqrt{\frac{\alpha'^2}{n'^2 + \alpha'^2}} \right] = -mc^2 \left[ \frac{1}{\alpha} \pm \sqrt{\frac{1}{\frac{n'^2}{\alpha'^2} + 1}} \right]$$

As in the case of electrostrong forces  $\alpha' \gg 1$  and  $n' \rightarrow \alpha'$  we have:

$$\frac{E_0}{\alpha} = -mc^2 \sqrt{\frac{1}{2}} \quad \text{and therefore:}$$

$$a_0 = \frac{\hbar c}{2\sqrt{\frac{1}{2}}mc^2} = \frac{\hbar c}{\sqrt{2}mc^2}$$

However we have to consider two conditions:

- Must be used reduced mass.
- The particle mass has increased by the binding energy  $m = m_0 + 1,7072 m_0 = 2,7072 m_0$

Thus:

$$a_0 = \frac{\hbar c}{3,8285(m'c^2 \text{ MeV}) \cdot 1,602 \cdot 10^{-13} \text{ J/MeV}} \quad \text{For the case of the proton it would be:}$$

$a_0 = \frac{\hbar c}{3,8285(162.17 + 11.46 - 10.70) \cdot 1,602 \cdot 10^{-13}} = 3.1522 \cdot 10^{-16} = 0.31522 \text{ fm}$
$a_1 = \frac{\hbar c}{3,8285(162.17 - 10.7/2) \cdot 1,602 \cdot 10^{-13}} = 3.275 \cdot 10^{-16} = 0.3275 \text{ fm}$
$a_2 = \frac{\hbar c}{3,8285(11.46 - 10.7/2) \cdot 1,602 \cdot 10^{-13}} = 8.4099 \cdot 10^{-15} = 8.4099 \text{ fm}$

Now we have the wavefunction  $\Psi_{1s} = \frac{1}{\sqrt{\pi}} \left( \frac{1}{a_0} \right)^{3/2} e^{-r/a_0}$ , so we can plot probability density  $4\pi r^2 \Psi_{1s}^2 = \frac{4\pi r^2}{\sqrt{\pi}} \left( \frac{1}{a_0} \right)^3 e^{-2r/a_0}$

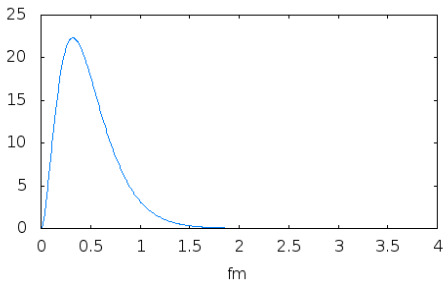

We are plotted the three waves sum weighted according to their masses. According to the hypothesis "matter as gravitational waves" this probability density is a **true density** (mass, charge,etc..) ,therefore we are able to study the internal structure of any hadron.

If we sum the 3 waves weighted according to their charges and superimpose it to the positive charge distribution graph obtained in reference [4] we can observe a high degree of coincidence .

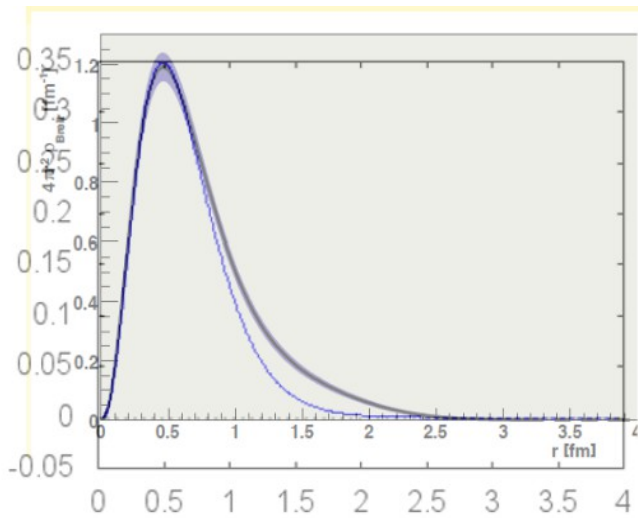

For the case of the neutron it would be:

$a_0 = \frac{\hbar c}{3,8285 (162.42 + 11.46 - 10.70) \cdot 1,602 \cdot 10^{-13}} = 3,1474 \cdot 10^{-16} = 0,3174 \text{ fm}$
$a_1 = \frac{\hbar c}{3,8285 (162.42 - 10.7/2) \cdot 1,602 \cdot 10^{-13}} = 3.2698 \cdot 10^{-16} = 0,327 \text{ fm}$
$a_2 = \frac{\hbar c}{3,8285 (11,46 - 10.70/2) \cdot 1,602 \cdot 10^{-13}} = 8.4097 \cdot 10^{-16} = 8.4097 \text{ fm}$

That is, substantially equal to proton.



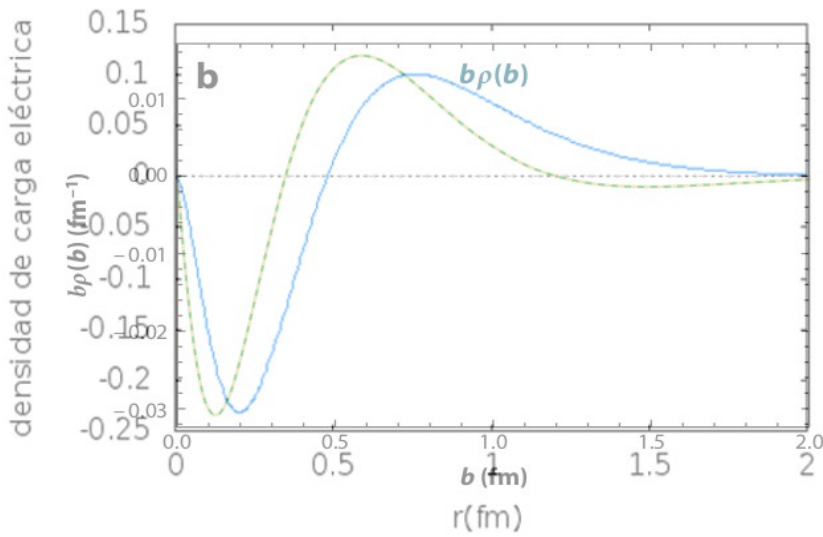

The curve (blue) predicts a negative charge area inside the neutron, Miller (dashed line) agree with this assumption [5].

We can do the same work with the other possibility for neutron and proton (first wave positive instead negative ) and the charge distribution graphs obtained in reference [4]

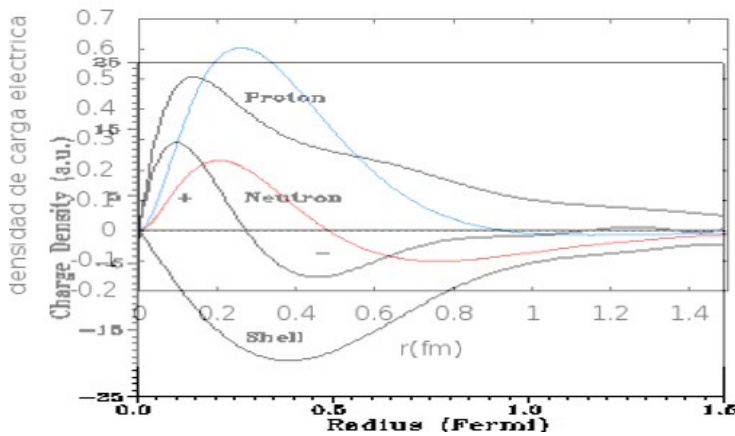
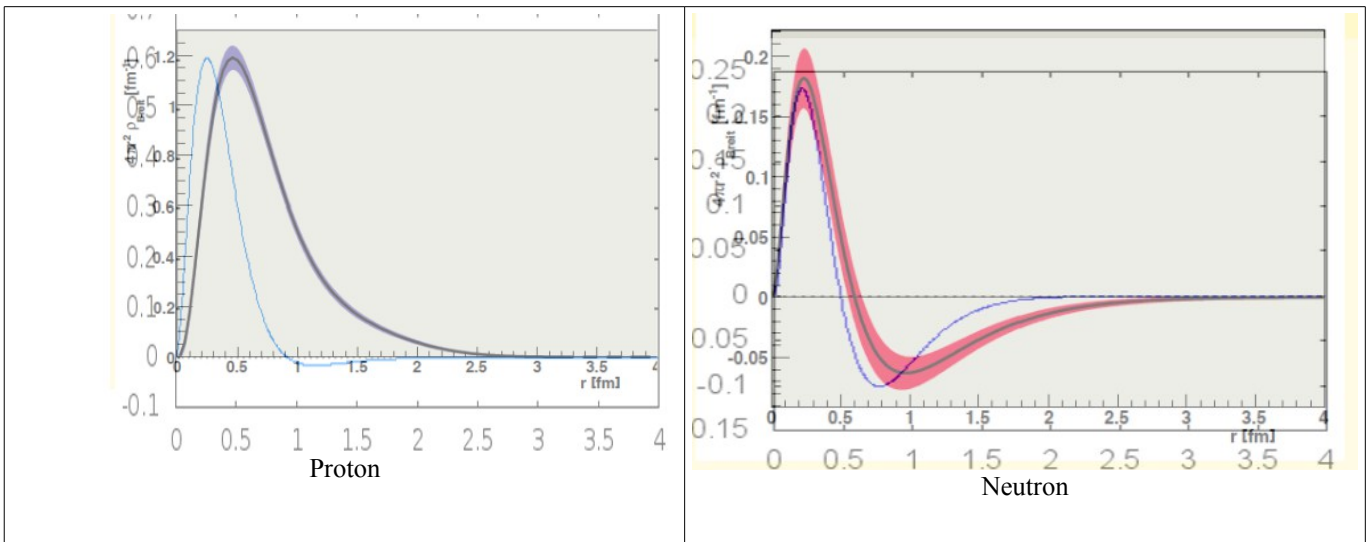

Again we can superimpose with the oldest data of [8]. We need further experiments in order to select between the two possibilities.

# 8. Van der Walls forces. Residual nuclear force. Qualitative study.

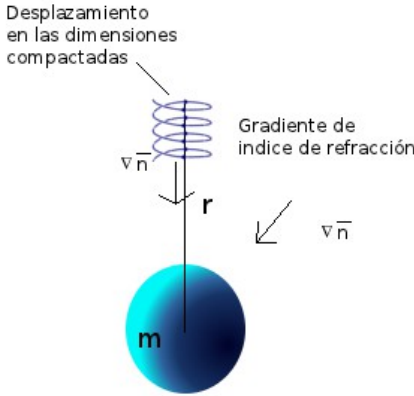

According to the hypothesis in [2] standing waves that conform the particles modified spacetime slowing the light that passes through them. Therefore, a probability density gradient should produce a refraction index gradient. As all particles keep closed trajectories in the plane of the compacted dimensions is deduced that apparent forces must occur in the direction of refraction index gradient and hence in the direction of mass gradient.

The acceleration caused by these gradient is given by the following relationship.

$$\frac{d^2 r}{dt^2} = c^2 \frac{\nabla n}{n} \quad \text{Where } n \text{ is the apparent refraction index.}$$

In the case of gravitational attraction and due to gravitational time dilation it was shown that the apparent refractive index was equal to  $n(r) = \left(1 - \frac{r_0}{r}\right)^{-1/2}$ , which easily allowed to obtain Newton's equation in the weak field approximation.

It is proposed that apparent refractive index is related to the wave function by the following expression:

$$n(r) = (1 - K \cdot r^2 \Psi)^{-1/2} \quad \text{where } K \text{ is a very small constant.}$$

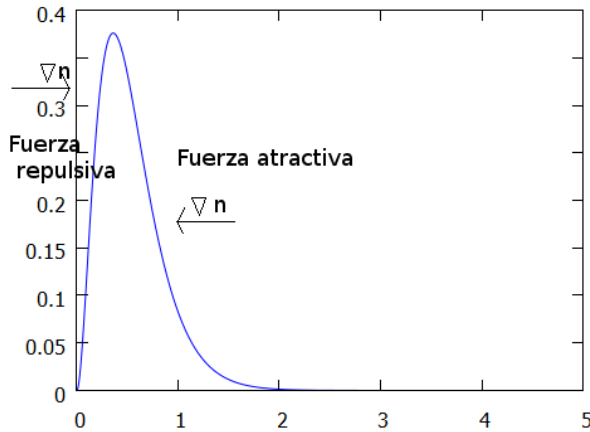

If we plot probability density function of an s orbital it is easy to see that it should cause a slight refractive index gradient (electrons are very lightweight), which will cause a repulsive force from the center of the atom to the Bohr radius of the orbital and another attractive force from this distance that will decay rapidly.

These forces may be responsible for the London forces between neutral helium atoms and that in the present theory are attributed to the emergence of instantaneous dipoles, but that in "matter gravitational as waves" are caused by refractive index gradients due to probability density function gradients.

The acceleration is given by the equation  $\frac{d^2 r}{dt^2} = c^2 \frac{\nabla n}{n}$  [2] and therefore field will be proportional to aparent refractive index gradient divided by aparent refractive index  $\frac{d^2 r}{dt^2} \propto \frac{\nabla n}{n}$ . We can write then:

$$\frac{d^2 r}{dt^2} \propto \frac{\nabla n}{n} = \nabla \left(1 - \frac{K}{r^2 \Psi}\right)^{-1/2} \cdot (1 - K \cdot r^2 \Psi)^{-1/2} \quad \text{and due to the spherical symmetry of the problem it becomes}$$

$$\frac{d^2 r}{dt^2} \propto \frac{d/dr (1 - K \cdot r^2 \Psi)^{-1/2}}{(1 - K \cdot r^2 \Psi)^{-1/2}} = \frac{d/dr (1 - K \cdot r^2 a_0^{-3} e^{-r/a_0})^{-1/2}}{(1 - K \cdot r^2 a_0^{-3} e^{-r/a_0})^{-1/2}} = \frac{-K r (r - 2a_0)}{2a_0 (a_0^3 e^{r/a_0} - K r^2)}$$

The  $a_0$  parameter of the Helium atom can be achieved from:

$$a_0 = \frac{\hbar c \alpha'}{2 E_0} \quad \text{and considering that experimental binding energy of Helium is approximately 79 eV then:}$$

$$a_0 = \frac{\hbar c \alpha'}{2 E_0} = \frac{\hbar c \frac{2e \cdot e}{\hbar c 4 \pi \epsilon_0}}{2 \frac{79}{2} 1,602 10^{-19}} = 3,63 10^{-11} m = 0,36 \text{ \AA} .$$

We can plot acceleration for a small K, for example  $K = 10^{-5}$ .

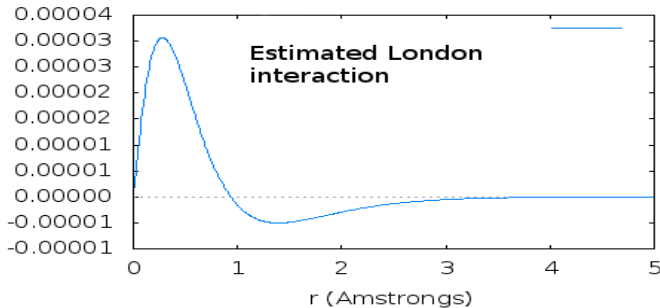

Therefore is qualitatively similar to Van der Waals forces, however function minimum does not agree with experimental data (about 1,41 Amstrongs). When K decreases function minimum is shifted to the right and when  $K \rightarrow 0$  function minimum

$$\frac{d^2 r}{dt^2} \propto \frac{-K r (r - 2 \cdot 0,36)}{2 \cdot 0,36 (0,36^3 e^{r/0,36} - K r^2)} \text{ tends to } r = 1,229 \text{ Amstrongs}$$

But total interaction also depends on electromagnetic repulsion so we can sum the electric potential and thus we can write:

$$\frac{d^2 r}{dt^2} \propto \frac{-K r (r - 2 \cdot 0,36)}{2 \cdot 0,36 (0,36^3 e^{r/0,36} - K r^2)} + K_2 \frac{1}{0,36^3} e^{-r/0,36}$$

By introducing electrostatic repulsion minimum is shifted to the right by an amount which is determined by K and K<sub>2</sub>, which can be interpreted as the relative strength of both interactions.

Now we are able to compare the obtained relationships with the experimental curves. London interaction is usually modelled

by Lennard-Jones potential: 
$$\varphi = 4 \epsilon_0 \left[ \left( \frac{\sigma_0}{r} \right)^{12} - \left( \frac{\sigma}{r} \right)^6 \right] .$$

He-He interaction parameter are  $\sigma=2,551$  and  $\epsilon_0=10,22$ . As Lennard-Jones potential use the distance between two atoms we have to modify it in order to compare it with the equation obtained above.

$$\varphi = 4 \epsilon_0 \left[ \left( \frac{\sigma_0}{r+r_0} \right)^{12} - \left( \frac{\sigma}{r+r_0} \right)^6 \right] \text{ where } r_0 \text{ is equal to Van der Wall radius of Helium.}$$

If conveniently we adjusted parameters K and K<sub>2</sub> we can achieve graphics like this:

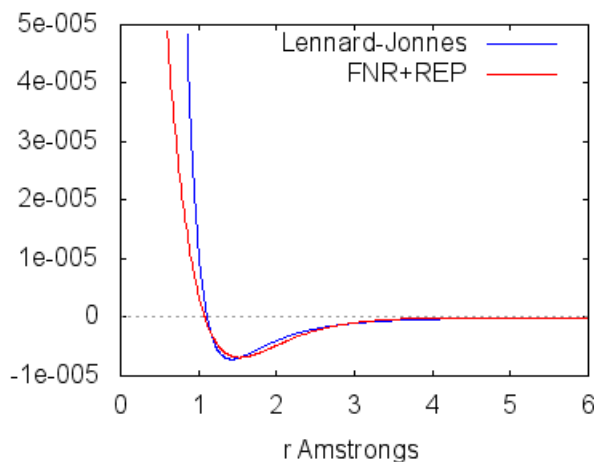

Note:  $K=10^{-5}$ ,  $K_2=5,26 10^{-6}$

The strong residual interaction can be estimated by just use the result of adding the 3 waves that form the proton or neutron instead electronics orbitals. Because of electrostrong charges distribution within the nucleon and because of electrostrong and electromagnetic charges mix this analysis is very complex and such an analysis is beyond the scope of this paper.

By way of example the function is represented using the same parameters K and K2 best adapted in the case of He-He interaction and assuming that entire electric and electrostrong charges are concentrated in intermediate wave of nucleon. We can overlapped this function (blue) conveniently scaled with the residual strong force (red) illustration that appears in [9]

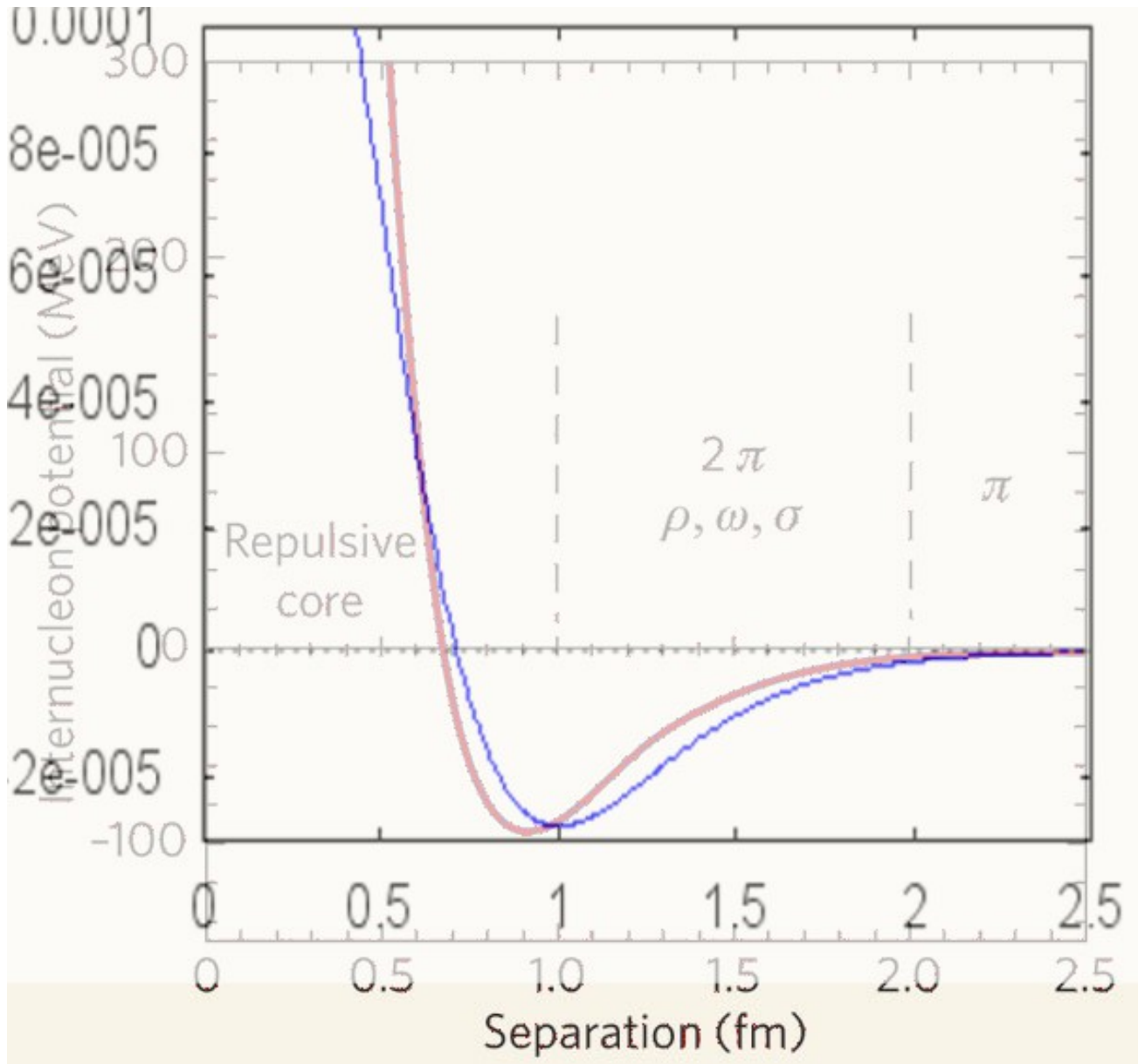

# 9. Summary and Conclusions .

Four solutions to gravitational wave equation have been found besides the already known and that was identified with the electron, these solutions have much lower mass than electron and can be identified with the three known neutrinos plus one supplementary. As it has not been found any greater mass solution that could explain hadrons it is forced to postulate the existence of a central hole in compacted dimensions. This postulate allow new solutions in the form of surface wave combined with any of the other five already found, never alone. These combinations have been called provisionally glutinos because of his relation with the strong force and the Iberian letter  $\Xi$  was chosen as its symbol.

It is therefore possible to postulate a new particle system consists of the following components and their linear combinations:

Particle-pulsation	mass	Principal interaction
$\nu_e$	18,75 eV	ELECTROWEAK
$\nu_\mu$	21,66 eV	ELECTROWEAK
$\nu_\tau$	1231,50 eV	ELECTROWEAK
$\nu_{\chi?}$	1624,97 eV	ELECTROWEAK
$e^{+,-}$	0,511MeV	ELECTROMAGNETIC
$\Xi_{light}^0$	11,87 MeV	ELECTROSTRONG
$\Xi_{heavy}^{+,-}$	12,91 MeV	ELECTROSTRONG

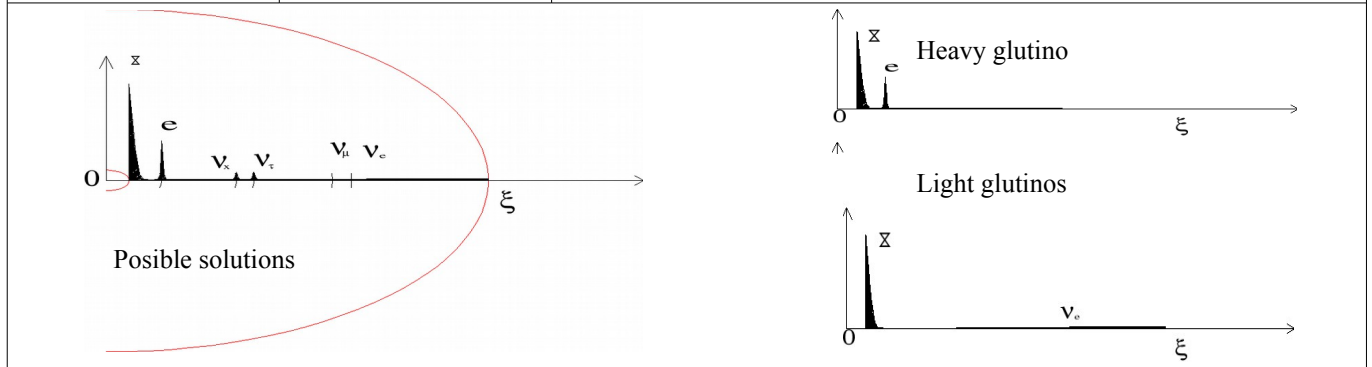

For "matter gravitational waves as" there are only three types of interactions:

1° By dragging space-time :

It produces forces between parallel mass flows and is the origin of electromagnetic like forces, but differing in the order of magnitude. These are electrostrong, electromagnetic and electroweak interactions. These interactions are independent of each other because the dragging occurs at different levels of the compacted coordinate. Only solutions  $\nu_e$  and  $\nu_\mu$  and can interact with all the others because its waves completely occupying the compacted dimensions.

2° y 3° By changing the refractive index and deforming propagation medium:

They produce gravity forces, residual nuclear forces and one kind of Van der Walls forces.

By the fact of having electrostrong charge glutinos can form structures similar to atoms, but with much more binding energy. It is postulated that mesons are formed by two waves solutions (spin 0), while baryons should be formed by three wave solutions (spin 1/2). By solving gravitational wave equation in these conditions we can justify a multi-linear system for particle masses as it was postulated by Palazzi in [6]. Specifically solutions for pions, muon, proton and neutron are proposed. In all cases it is possible to estimate their masses with a maximum error of 0.3%. The hypothesis is also able to determine the size of the baryons and the internal distribution of charges. These properties are compared successfully with existing experimental data on the proton and the neutron.

Finally is established a hypothesis about the residual nuclear force. This force may be caused by refractive index gradients caused by the mass distribution in hadrons (like a hollow sphere) and relating it to Van der Walls forces, specifically London interactions.

Hypothesis currently lacks a general mathematical framework to support it, in fact it is anything but mathematically elegant, but however it not appear infinities under any conditions and it has a great physical simplicity. Everything can be explained by a single substrate (space-time) with anisotropic curvature. The vibrations of spacetime generate matter and energy, while all interactions are reduced to three types of interactions with mechanical equivalents.

However the cost to be paid is tremendous: the concept of particle and by extension the concept of matter, the quarks, the primacy of matter versus space, the probabilistic interpretation of quantum mechanics, the force fields interpretation...

## References

- [1] "Matter as gravitational waves. On the nature of electron." E Lopez 2012
- [2] "Mechanism of interaction between gravitational waves". E Lopez 2012
- [3] "Theory and applications of Mathieu functions" McLachlan.
- [4] The Frontiers of Nuclear Science – A Long Range Plan (2007), p.26
- [5] "Charge Density of the Neutron" Miller
- [6] "Linear Mass Rules an hadronic shells: The Baryons". Palazzi
- [7] "The Hierarchy Problem and New Dimensions at a Millimeter". Nima Arkani-Hamed, Savas Dimopoulos, Gia Dvali
- [8] R. M. Littauer, H. F. Schopper, and R. R. Wilson, Phys. Rev. Letters, 7 (1961) 141
- [9] Particle physics: Hard-core revelations, Frank Wilczek , Nature 445