

Unusual fountain and gravitomagnetism

Contents

1. Introduction
 2. Main mathematical model
 3. Computational algorithm
 4. Energy flows in the unusual fountain
 5. Jet shape calculation
 6. Conclusion
- References

Abstract

This paper presents an unusual submarine fountain [1]. Its mathematical model is created and it is demonstrated that its shape may be attributed to the existence of gravitomagnetic forces (similar to Lorentz forces), significant in magnitude, and gravitomagnetic energy flow (similar to electromagnetic energy flow).

1. Introduction

An unusual fountain [1] is installed in England, which constitutes a vortex within a transparent cylinder – the Charybdis vortex fountain – see fig. 1. There is also an article [2] about another artificial vortex, less impressive, but structurally more transparent. The fig. 2 shows this vortex in a glass with presentation of its structure. We may also indicate a natural phenomenon resembling the unusual fountain [3] – see fig. 3.

To the author's knowledge such phenomena have no strict mathematical description. Previously, the author suggested a mathematical model of a water flow running into a funnel and out of a pipe [4]. At that, gravitomagnetism equations were used – the ones similar to Maxwell's equations for electrodynamics – the Maxwellian-like gravity equations (hereinafter, “MLG equations”). Interaction between the moving water masses was described by gravitomagnetic Lorentz forces (hereinafter, “GL forces”) similar to Lorentz forces in electrodynamics [5]. Further rationale is similar to that of [4]. However,

there is a fundamental difference between the jet flowing out of the pipe under pressure and the jet ascending in the unusual fountain. In the first case, the water jet spreads out and jet density changes. In the second case, the jet density equals to that of the surrounding water, as the latter is an incompressible liquid. Therefore, explanation of the jet shape in the fountain should differ from the same in [4]. Main attention is devoted to this subject below.

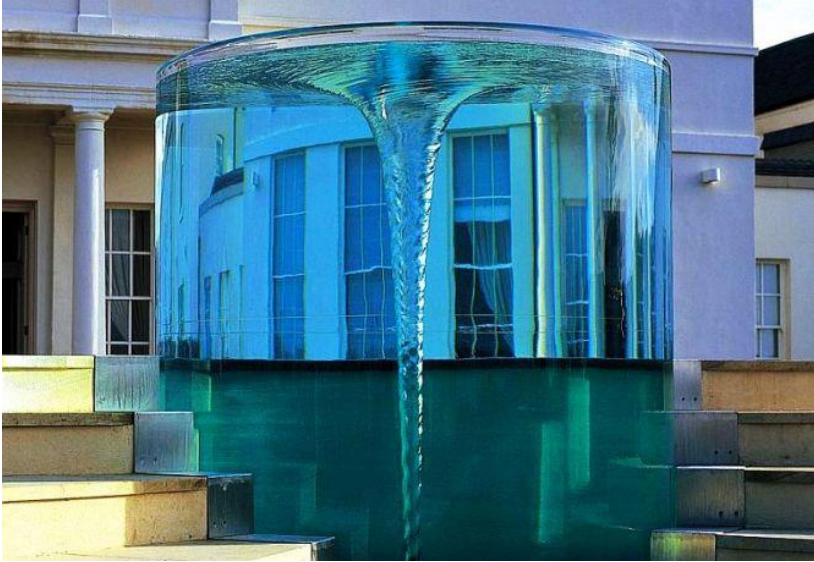

Fig. 1.

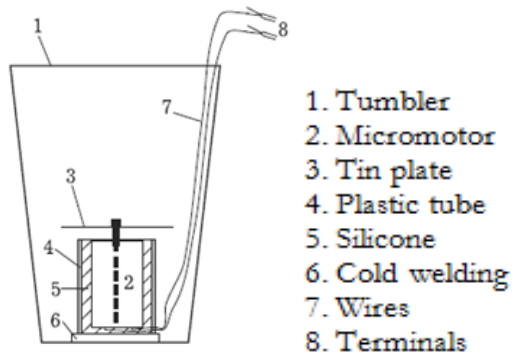

Fig. 2.



Fig. 3.

2. Main mathematical model

MLG equations for gravitomagnetic intensities H and mass current densities J in stationary gravitomagnetic field are written as:

$$\operatorname{div}(H) = 0, \quad (1)$$

$$\operatorname{rot}(H) = J, \quad (2)$$

For vortex modelling we will utilize cylindrical coordinates r , φ , z . So

MLG equations will be as follows:

$$\frac{H_r}{r} + \frac{\partial H_r}{\partial r} + \frac{1}{r} \cdot \frac{\partial H_\varphi}{\partial \varphi} + \frac{\partial H_z}{\partial z} = 0, \quad (3)$$

$$\frac{1}{r} \cdot \frac{\partial H_z}{\partial \varphi} - \frac{\partial H_\varphi}{\partial z} = J_r, \quad (4)$$

$$\frac{\partial H_r}{\partial z} - \frac{\partial H_z}{\partial r} = J_\varphi, \quad (5)$$

$$\frac{H_\varphi}{r} + \frac{\partial H_\varphi}{\partial r} - \frac{1}{r} \cdot \frac{\partial H_r}{\partial \varphi} = J_z. \quad (6)$$

Besides, the currents should meet the continuity condition

$$\operatorname{div}(J) = 0, \quad (7)$$

or, in cylindrical coordinates,

$$\frac{J_r}{r} + \frac{\partial J_r}{\partial r} + \frac{1}{r} \cdot \frac{\partial J_\varphi}{\partial \varphi} = 0. \quad (8)$$

These equations essentially describe interaction of currents, intensities and GL forces. The latter are defined as

$$F_L = G \cdot \xi \cdot S_o, \quad (9)$$

where G is a gravitation constant, and ξ is a gravitomagnetic permeability of the medium [5],

$$S_o = (J \times H). \quad (10)$$

In cylindrical coordinates, this cross product appears as follows:

$$S_o = \begin{bmatrix} S_{or} \\ S_{o\varphi} \\ S_{oz} \end{bmatrix} = \begin{bmatrix} J_\varphi H_z - J_z H_\varphi \\ J_z H_r - J_r H_z \\ J_r H_\varphi - J_\varphi H_r \end{bmatrix}. \quad (11)$$

3. Computational algorithm

In [4], it is demonstrated that the equations (2.3-2.6, 2.8) appear as follows:

$$H_{r\cdot} = \eta \cdot f_8(r) \cdot \exp(\eta \cdot z) \quad (1)$$

$$H_{\varphi\cdot} = \eta \cdot f_2(r) \cdot \exp(\eta \cdot z) \quad (2)$$

$$H_{z\cdot} = f_3(r) \cdot \exp(\eta \cdot z) \quad (3)$$

$$J_{r\cdot} = -\eta^2 f_2(r) \cdot \exp(\eta \cdot z), \quad (4)$$

$$J_{\varphi\cdot} = \eta^2 f_7(r) \cdot \exp(\eta \cdot z), \quad (5)$$

$$J_z = \eta \cdot f_{10}(r) \cdot \exp(\eta \cdot z), \quad (6)$$

where

$$f_8(r) = f_{80}(r) \cdot (1 - X), \quad (7)$$

$$f_2(r) = q \cdot r(1 - X), \quad (8)$$

$$f_{10}(r) = \frac{f_2(r)}{r}, \quad (9)$$

$$f_3(r) = -\left(\frac{f_8(r)}{r} + f_8'(r) \right) \quad (10)$$

$$f_7(r) = f_8(r) - \frac{1}{\eta^2} f_3'(r) \quad (11)$$

$$X(r, R) = 1 / (1 + \exp(-2g(r - R))), \quad (12)$$

h, q, η, g – some invariables.

Various functions $f_{80}(z)$ are possible, whereon depend $f_8(z), f_7(z), f_3(z)$ functions. Let us consider the simplest case, when the function $f_{80}(z)$ is constant, so

$$f_{80}(z) = h, \quad f_3(r) = -\frac{f_8(r)}{r}, \quad f_7(r) = -\frac{f_8(r)}{\eta^2 r^2} + f_8(r). \quad (13)$$

Here, X is a Heaviside function approximation, g value characterizes approximation “leap width”, R is a jet radius, the r coordinate value, wherein the function changes its value from 0 to 1. Function $R(z)$ is to be determined.

Fig. 3f shows functions (1-6) at $h = 0.01$, $q = -0.05$, $\eta = -0.8$, $g = 1.6$, $z = -1$.

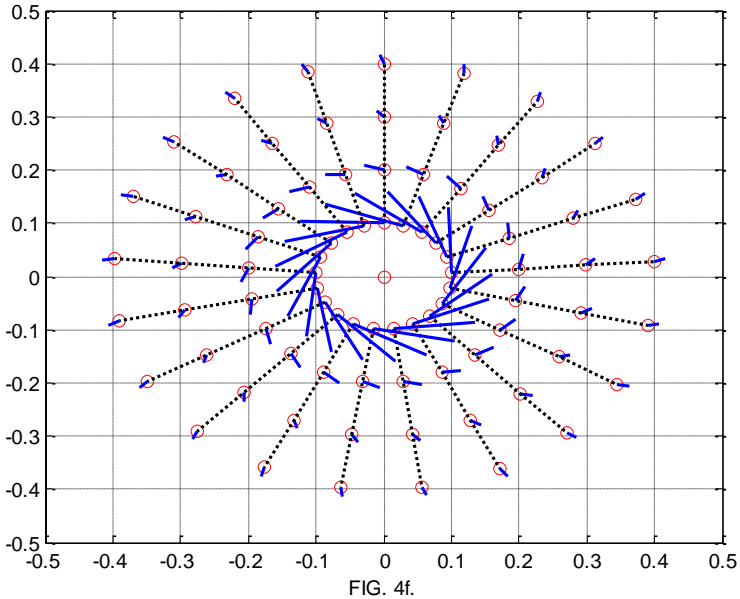
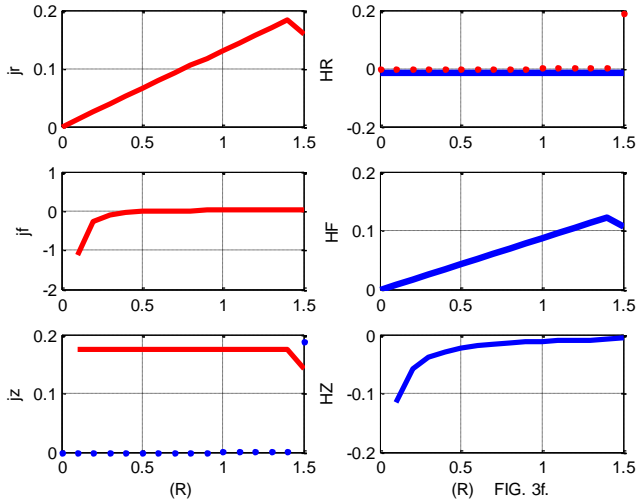

Let us consider now a vector field of currents on circle in the fountain horizontal plane – see fig. 4f with the same parameter values. Analyzed points located on "dotted" radii are denoted here with circlets. Continuous intervals indicate current vectors.

4. Energy flows in the unusual fountain

A structure of constant current electromagnetic energy flow in a cylindrical wire with constant current was described in [6]. It was demonstrated that the density of electromagnetic energy flow is

$$S = \rho(J \times H). \quad (1)$$

where σ is a specific electrical resistivity. Similarly, let us determine the density of gravitomagnetic energy flow in water jet

$$S = \sigma \cdot (J \times H), \quad (2)$$

where σ is a specific resistivity to mass current. Therefore,

$$S = \sigma \cdot S_o, \quad (3)$$

where S_o is determined in accordance with (2.11).

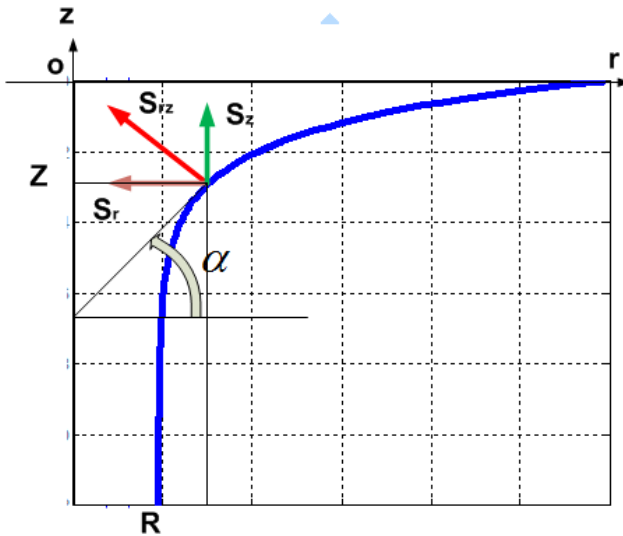

Fig. 4.

Fig. 4 shows vertical section of the fountain in the plane (r, z) and jet edge. Gravitomagnetic energy flow

$$S = \begin{bmatrix} S_r \\ S_\varphi \\ S_z \end{bmatrix} \quad (4)$$

circulates within the jet. Fig. 4 shows projections S_r , S_z of this stream and the sum of these projections S_{rz} . Projection S_ϕ is tangential to the jet circumference, and is not shown in fig. 4. It may be also that the aggregate projection S_{rz} is perpendicular to the edge in its vicinity and equal to zero at the very jet edge. If this condition is fulfilled in all edge points, the gravitomagnetic energy flow always remains inside the jet.

Arguing as in [7], it should be noticed that density integral of this stream S by volume V of the jet is proportional to the electromagnetic field momentum P in this volume, since in the SI system, as is known,

$$\frac{dP}{dV} = \frac{1}{c^2} S = \frac{1}{c^2} [\overline{E} \times \overline{H}]. \quad (5)$$

By virtue of the momentum conservation law, jet retains its continuity, since the integral of the gravitomagnetic energy flow density is changing with the jet shape.

5. Jet shape calculation

The condition formulated above enables jet shape calculation. Let us find based on (2.11, 2.1-2.6):

$$\begin{aligned} S_{or} &= J_\phi H_z - J_z H_\phi = \\ &= \eta^2 f_7(r) \cdot \exp(\eta \cdot z) f_3(r) \cdot \exp(\eta \cdot z) - \\ &\quad - \eta \cdot f_{10}(r) \cdot \exp(\eta \cdot z) \eta \cdot f_2(r) \cdot \exp(\eta \cdot z) \end{aligned} \quad (1)$$

$$\begin{aligned} S_{oz} &= J_r H_\phi - J_\phi H_r = \\ &= -\eta^2 f_2(r) \cdot \exp(\eta \cdot z) \eta \cdot f_2(r) \cdot \exp(\eta \cdot z) - \\ &\quad - \eta^2 f_7(r) \cdot \exp(\eta \cdot z) \eta \cdot f_8(r) \cdot \exp(\eta \cdot z) \end{aligned} \quad (2)$$

or

$$S_{or} = \eta^2 \exp(2\eta \cdot z) (f_7(r) \cdot f_3(r) - f_{10}(r) \cdot f_2(r)), \quad (3)$$

$$S_{oz} = -\eta^3 \exp(2\eta \cdot z) (f_2(r) \cdot f_2(r) + f_7(r) f_8(r)). \quad (4)$$

Providing for (2.7-2.10, 2.13) we obtain:

$$S_{or} = -\eta^2 \exp(2\eta \cdot z) (1 - X)^2 \left(-\frac{h^2}{r} + q^2 r \right), \quad (5)$$

$$S_{oz} = -\eta^3 \exp(2\eta \cdot z) (1 - X)^2 (q^2 r^2 + h^2). \quad (6)$$

Now, let us find the angle α shown in fig. 4:

$$\operatorname{tg}(\alpha) = \frac{S_{oz}}{-S_{or}} = -\eta (q^2 R^2 + h^2) / \left(-\frac{h^2}{R} + q^2 R \right), \quad (7)$$

or

$$\operatorname{tg}(\alpha) = \eta R (q^2 R^2 + h^2) / (h^2 - q^2 R^2), \quad (8)$$

where R is a jet radius. Let us designate the jet generator function as $z = Q(R)$. If the angle α is a slope angle with this function of the tangent line, then

$$\operatorname{tg}(\alpha) = \frac{d}{dR} Q(R). \quad (9)$$

Therefore,

$$Q(R) = \int \eta R (h^2 + q^2 R^2) / (h^2 - q^2 R^2) dR, \quad (10)$$

On integrating (10) we obtain:

$$Q(R) = -\eta \left(\frac{h^2}{q^2} \ln \left(\frac{h^2}{q^2} - R^2 \right) + \frac{R^2}{2} \right) + Q_o. \quad (11)$$

Fig. 5, in the upper window, the function $z = Q(R)$ is shown, whereas the function $z = -\eta \log(R-1)$ is shown by dots for reference. In the lower window, $\exp(\eta \cdot z)$ function is shown, incorporated in the formulas (3.1-3.6). And yet, it is assumed that

$$\frac{h^2}{q^2} = 1, \quad \eta = -0.8, \quad Q_o = -3.$$

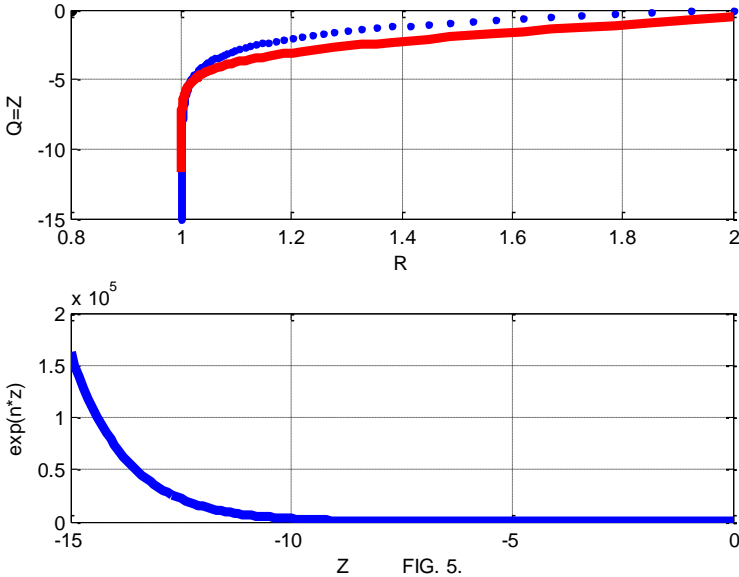

FIG. 5.

Fig. 6 shows projections of the energy density vector $S_{or}, S_{o\phi}, S_{oz}$ and full energy vector S_o , determined using (2.11). These values are shown on the plane of jet vertical section $z = 0 \div -1, r = 0 \div 2$ at $h = 0.01, q = 0.05, \eta = -1.5, g = 1.6$. The figure shows jet edges. It is seen that the energy flow decreases from jet center up- and sideways. An energy source is located below to create the fountain and this gravitomagnetic energy direction is natural. This energy is spent to viscous frictional drop in mass water flows.

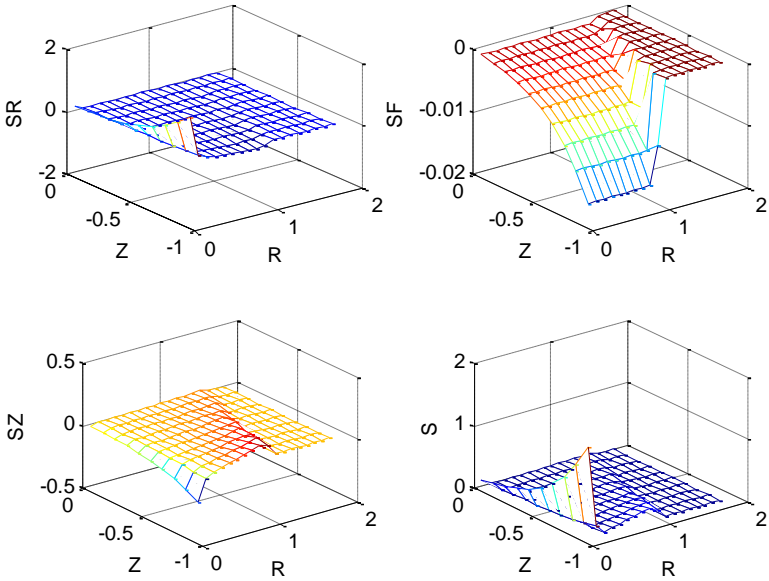

Fig. 6.

6. Conclusion

If fig. 1 and fig. 5 are compared, we may notice similarity of real and simulated shapes of the unusual fountain. Thus, it is fair to say that gravitomagnetism equations are confirmed experimentally. At that, existence of gravitomagnetic forces, significant in magnitude, and gravitomagnetic energy flow is confirmed.

References

1. <http://www.mirkrasiv.ru/articles/fontan-vodovorot-haribdacharybdis-sanderlend-velikobritanija.html>
2. Bondarov M.N., Savitchev V.I. Artificial maelstrom and its application,
http://bond1958.narod.ru/publikacii/pot_11_2010.pdf
3. <https://www.youtube.com/watch?v=fmMVGil0sXg>
4. Khmelnik S.I. About Flow of Water Into the Funnel and from Pipe, <http://vixra.org/pdf/1506.0201v3.pdf> (in Russian)
5. Khmelnik S.I. More on Experimental Clarification of Maxwell-similar Gravitation Equations, "The Papers of independent Authors", publ. «DNA», ISSN 2225-6717, Israel-Russia, 2014, issue 28, ISBN 978-1-312-23676-9, printed in USA, Lulu Inc., ID 14794393 (in Russian),
<http://lib.izdatelstwo.com/Papers/28.104.pdf>, see also
<http://vixra.org/abs/1311.0023>
6. Khmelnik S.I. The Flow Structure of the Electromagnetic Energy in the Wire with Constant Current,
<http://vixra.org/pdf/1504.0061v1.pdf>
7. Khmelnik S.I. To the Question of Intranuclear Forces. "The Papers of independent Authors", publ. «DNA», ISSN 2225-6717, Israel-Russia, 2014, issue 28, ISBN 978-1-312-23676-9, printed in USA, Lulu Inc., ID 14794393 (in Russian)
<http://lib.izdatelstwo.com/Papers/28.125.pdf>, see also
<http://vixra.org/abs/1405.0347>