

# A PROOF OF THE FOUR COLOR THEOREM BY INDUCTION

01-2016

By Nguyen Van Quang  
Vietnam

**Abstract.** We choose *one of four colors as a temporary color* for all regions that have not been colored, and made *the initial conditions* corresponding to The Four Color Theorem. If these conditions hold for any  $n$  regions figure, then they will hold for  $n + 1$  regions figure- formed  $n$  regions figure by adding next region. By induction, step by step we have proved The Four Color Theorem successfully on paper.

**Introduce.** The Four Color Theorem has been known since 1852<sup>[1,2]</sup>, and has just proved with the help of computer. The format proof<sup>[3]</sup> was achieved by Kenneth Appel and Wolfgang Haken and was published in 1976. It was the first major theorem to be proved using a computer.

**The Four Color Theorem.** *The regions of any simple planar map can be colored with only four colors, in such away that any two adjacent regions have different colors.*

Two regions are called adjacent regions if they share a common boundary that is not a corner, where corners are the points shared by three or more regions.

**Proof.** Let A, B, C, D be the four colors to color a simple planar map in such a way that any adjacent regions have different colors.

Generally, for any simple planar map, we can take one point and its shared regions or take one region and its adjacent closed regions. The first figures are follows or similar. (f.1 a, f.1 b).

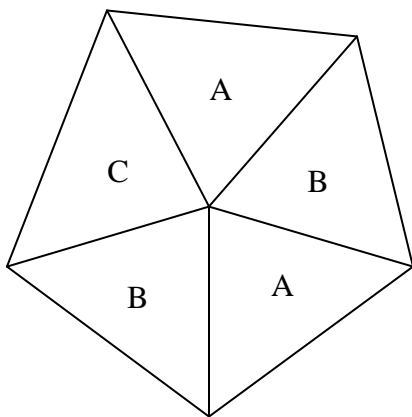

f.1a

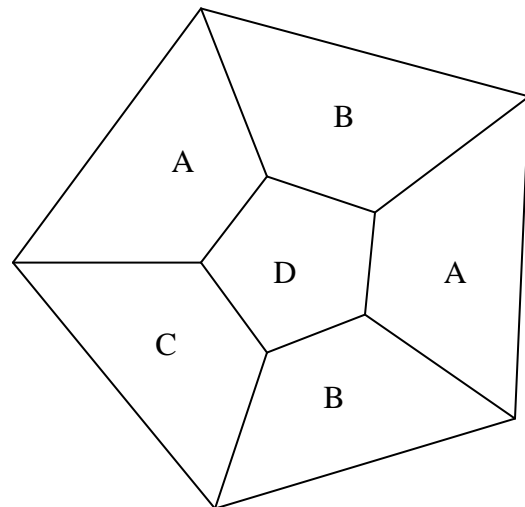

f.1b

Note that the first figures with any ring –size can be used 3 colors for f.1a or similar, 4 colors for f.1b or similar maximum. Both of them can only be used 3 colors for ring – regions.

For coloring a simple planar map, we have to divide the map into two areas. The first contains n colored regions, the second is the remaining. We choose D color as a temporary color for the remaining area. The next region ( $n+1^{\text{th}}$  region), which we will color in order, has a common boundary with both areas, and the common boundary with the colored area must be uninterrupted as following figure (f.2).

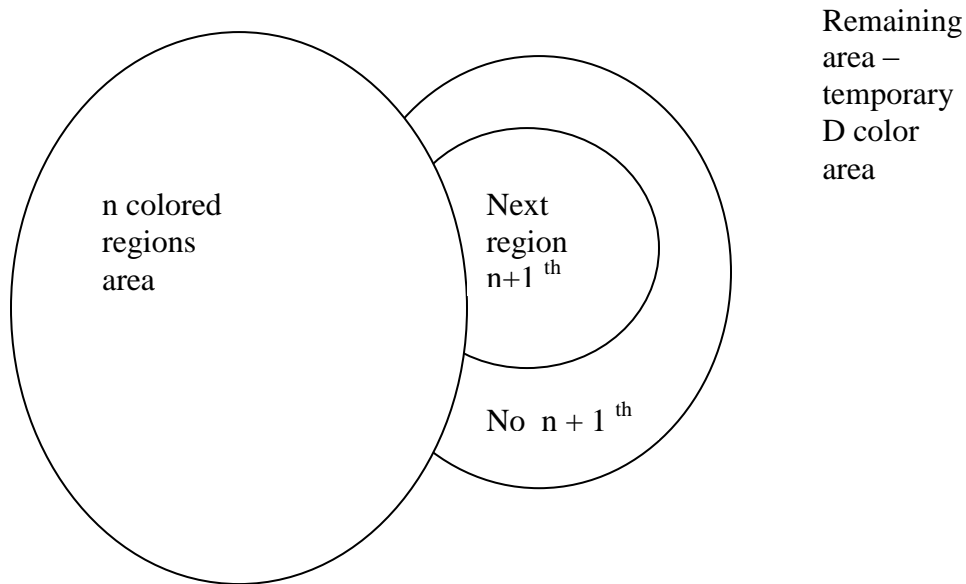

f.2

**A. By following algorithm:**

Clearly, the first figures as f.1 a, f.1 b or similar are true. Assume it is true for any n regions-figure, we prove that, it must be true for  $n + 1$  regions figure. That means for any next region ( $n+1^{\text{th}}$  region),  $n+1$  regions figure- formed n colored regions by adding  $n+1^{\text{th}}$  region can be used four colors A, B, C, and D maximum, in which three colors A, B, and C for ring-regions including the  $n+1^{\text{th}}$  region (assign the label N. r).

Let  $X_1, X_2, X_3, X_i, X_k$  be the regions of colored area, taken from k regions adjacent to N. r

Since three colors A, B, C are the same role, assume that  $X_1 = A$  or B color, use C color for N. r, so we must change color so that C color will not exist in the regions from  $X_1$  to  $X_k$ .

The initial conditions can be written as follows:

- Any adjacent regions have different colors.
- There is no C color in the regions from  $X_1$  to  $X_k$ , and colors of  $X_1$  and  $X_k$  are different from both C, D (for  $X_1$  and  $X_k$  can be adjacent to D area).
- There is no D color from the regions ( remaining ring regions) that adjacent to D area.

Begin by considering regions from  $X_1$  to  $X_k$ .

If k regions are alternately colored A and B colors, there is no problem, use C color for N. r. (f.3)

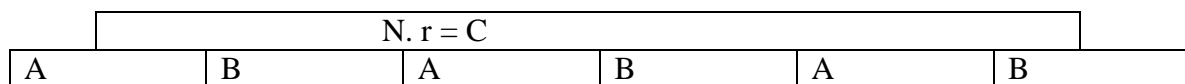

f.3

If there are three A, B, C colors in the regions from  $X_1$  to  $X_k$ , then do the following steps.

Step1:

Begin from  $X_1$ , take the first C color region ( $X_{c_1} = C$ ), and consider the regions from  $X_1$  to  $X_{c_1}$ .

1 a. If there is no chain  $X_i - X_{c_1} = A - C$  (f.4a), change  $X_{c_1} = C$  to A, and then interchange the color of the C/A regions in the chain joining  $X_{c_1}$  (f.4b). Since  $X_i = A$  is not in the chain, it remains A color, and there is now no C color region adjacent to  $N_r$  from  $X_1$  to  $X_{c_1}$ . If there is no chain  $X_i - X_{c_1} = B - C$ , change  $X_{c_1} = C$  to B, and then interchange the color of the C/B regions in the chain joining  $X_{c_1}$ . Since  $X_i = B$  is not in the chain, it remains B color, and there is now no C color region adjacent to  $N_r$  from  $X_1$  to  $X_{c_1}$ . *Leave blank for the regions after  $X_{c_1}$ , they will be proceeded naturally.*

*Chain  $X_i - X_{c_i} = A - C$ , adjacent regions from  $X_i$  to  $X_{c_i}$  are alternately colored A and C colors, two adjacent regions are also considered as a chain.*

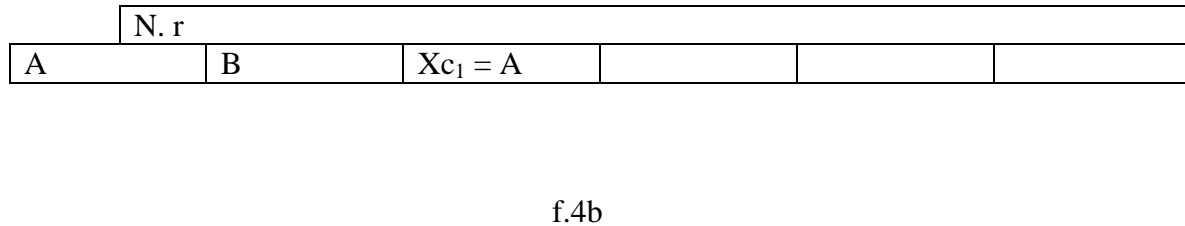
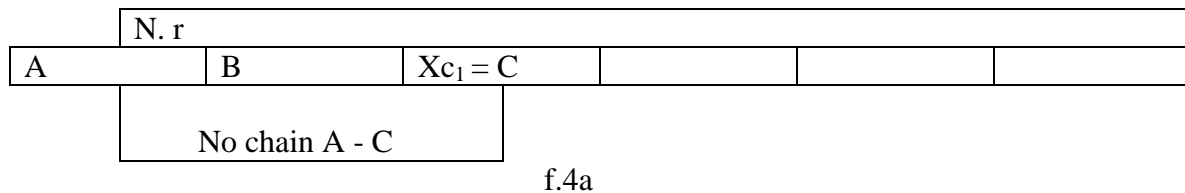

1 b. If there are the chains  $X_i - X_{c_1} = A - C$ , the chains  $X_i - X_{c_1} = B - C$  before  $X_{c_1}$ , assume that the first chain of chains  $X_i - X_{c_1} = A - C$  is before the first chain of chains  $X_i - X_{c_1} = B - C$  (f.5a),(f6.a), take the chain  $A - C$  on the basic, change  $X_i = B$  to D, and then interchange the color of the B/D regions in the chain joining  $X_i = B$  (f.5b), (f6.b). Since there is the chain  $X_i - X_{c_1} = A - C$ , interchange B/ D colors inside chain  $X_i - X_{c_1} = A - C$  has no affect to outside chain A-C, outside that it was (By planarity, chains cannot cross). Change  $X_{c_1} = C$  to B, and then interchange the color of the C/B regions in the chain joining  $X_{c_1}$ , and there is now no C color region adjacent to  $N_r$  from  $X_1$  to  $X_{c_1}$  (f.5c), (f6.c).

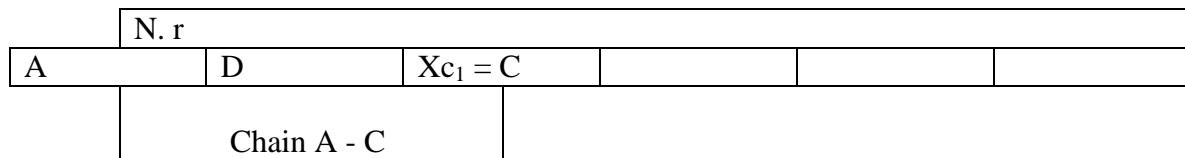
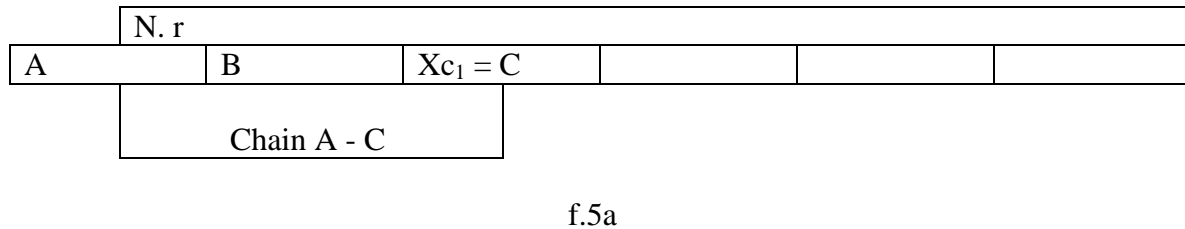

f.5b

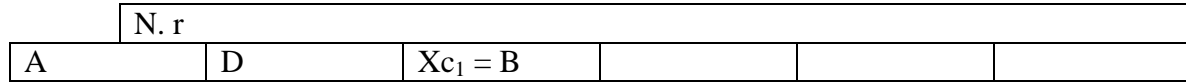

f.5c

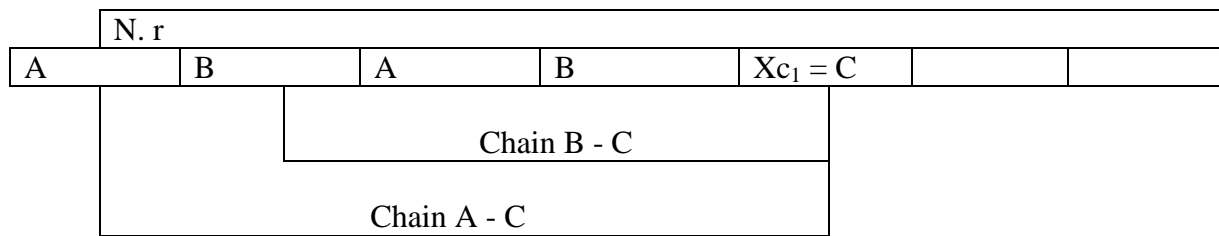

f.6a

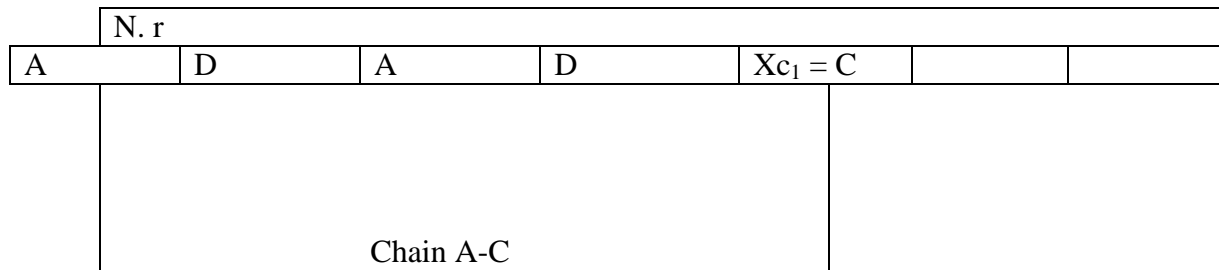

f.6b

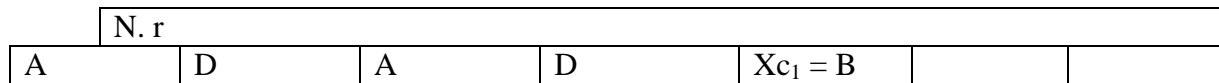

f.6c

After step1, if there is no more C color region from  $X_{c_1}$  to  $X_k$ , then finish by coloring C color for

N. r.

Step 2:

After step1, if there is a C color region left ( $X_{c_2}$ ) from  $X_{c_1}$  to  $X_k$ , then consider the regions from  $X_1$  to  $X_{c_2}$

2a. Repeat step 1 for the following cases:

- There is no D color region before  $X_{c_2}$ .

- There are the D color regions, but no chain  $X_i - X_{c_2} = D - C$  and no chain  $X_i - X_j = B - D$  before  $X_{c_2}$  (f.7a; f.7b; f.7c).

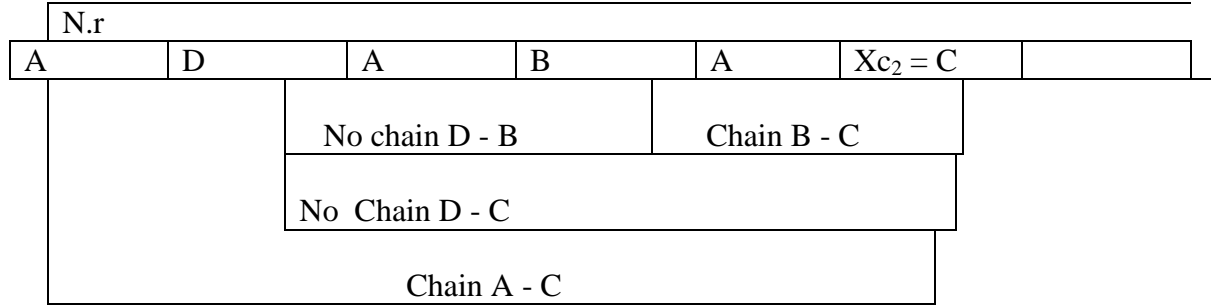

f.7a

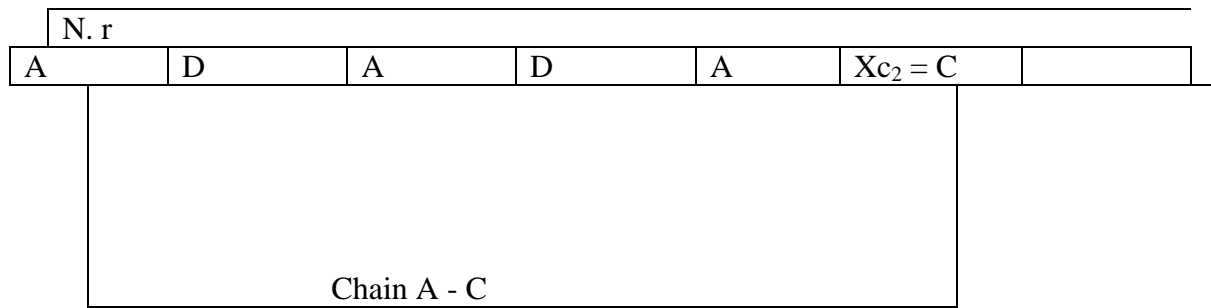

f.7b

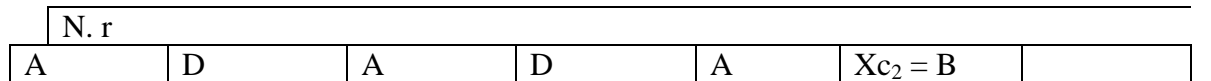

f.7c

2b. If there are the chains A - C, B - C, no chain  $X_i - X_{c_2} = D - C$ , and there is a chain  $X_i - X_j = B - D$ , (f.8a), a chain A - C is before, take the chain A - C on the basic, then interchange all B/D colors inside chain A-C, the chain  $X_i(X_4) - X_{c_2} = B - C$  become chain  $X_i(X_4) - X_{c_2} = D - C$ , since there was no chain  $X_i(X_2) - X_{c_2} = D - C$ , so after interchange all D/B colors, there will be also no chain  $X_i(X_2) - X_{c_2} = B - C$  (f.8b). Change  $X_{c_2} = C$  to B, and then interchange the color of

the C/B regions in the chain joining  $X_{c_2}$ . Since  $X_2 = B$  is not in the chain, it remains B color, and there is now no C color region adjacent to N. r from  $X_1$  to  $X_{c_2}$  (f.8c).

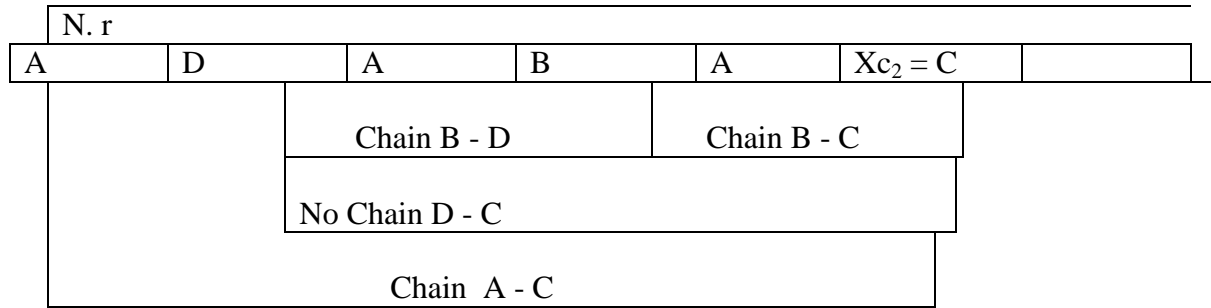

f.8a

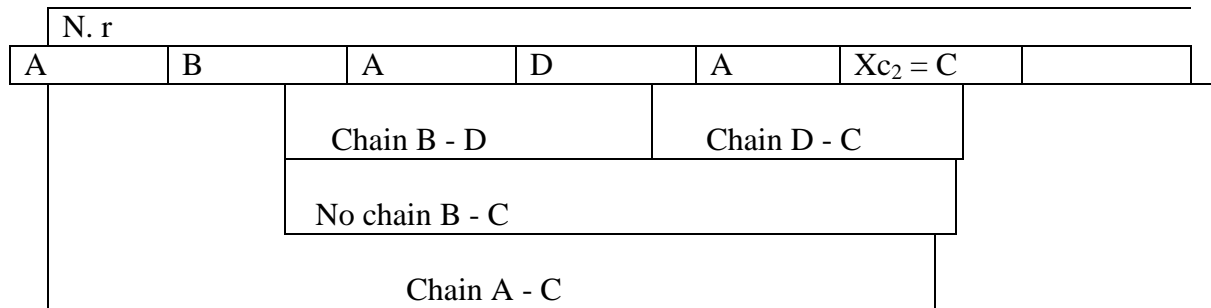

f.8b

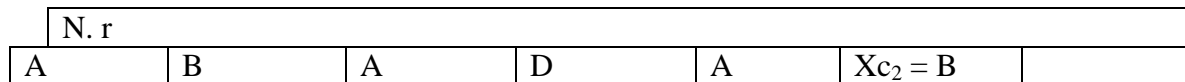

f.8c

2c. If there are the chains  $X_i - X_{c_2} = A - C, B - C, D - C$  before  $X_{c_2}$ , we apply the following rules:

Assume that the first chain of chains A - C is before the first chain of chains B-C, the first chain of chains B - C is before the first chain of chain D - C (f.9a), take the chain A-C on the basic, then interchange all B/D colors inside chain A-C ( for the regions between two chains A - C if after chain D - C is a chain A-C left), after interchange, the chains  $X_i - X_{c_2} = B - C$  become the chains  $X_i - X_{c_2} = D - C$ , and the chains  $X_i - X_{c_2} = D - C$  become the chains  $X_i - X_{c_2} = B - C$  (f.9b). Then take the chain  $X_i - X_{c_2} = D^* - C$  (it was B - C before ) which is nearest to the chain  $B^* - C$  (It was D - C before) on the basic, interchange all B/A colors inside chain  $D^* - C$  ( for

the regions between two chains  $D - C$  if after chains  $A - C$  is a chain  $D - C$  left), the chains  $X_i - X_{c_2} = B^* - C$  become chains  $X_i - X_{c_2} = A^* - C$  (f.9c), then continue considering the regions from this chain  $A^* - C$  to  $X_{c_2}$ , if there is no more chain  $X_i - X_{c_2} = B - C$ , change  $X_{c_2} = C$  to  $B$ , and then interchange the color of the  $C/B$  regions in the chain joining  $X_{c_2}$ , and there is now no  $C$  color region adjacent to  $N. r$  from  $X_1$  to  $X_{c_2}$  (f9d). If there is a chain  $X_i - X_{c_2} = B - C$  left, take the nearest chain before this chain  $B - C$  on the basic, and continue as above until there is no more chain  $X_i - X_{c_2} = B - C$  before  $X_{c_2}$ , change  $X_{c_2} = C$  to  $B$ , and then interchange the color of the  $C/B$  regions in the chain joining  $X_{c_2}$ .

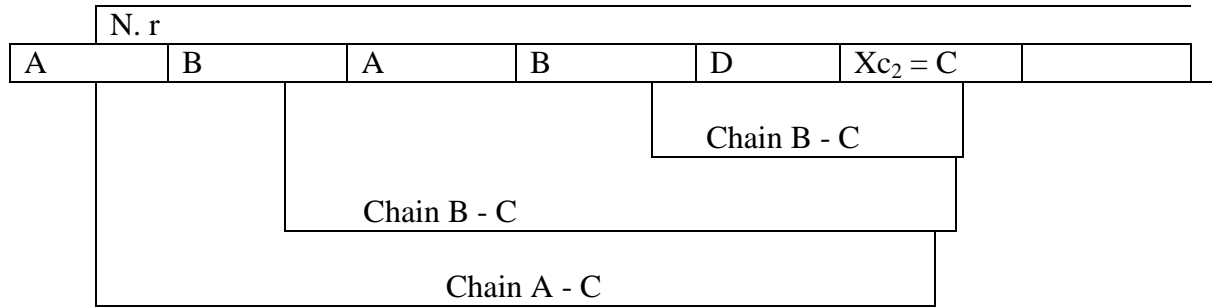

f.9a

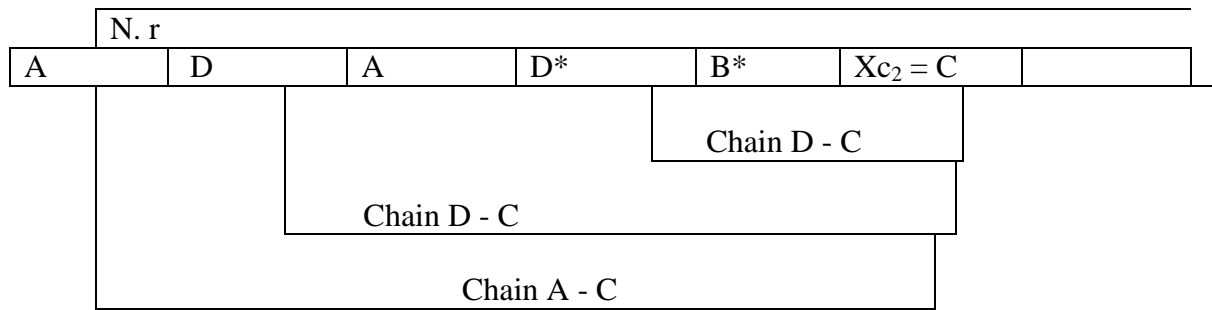

f.9b

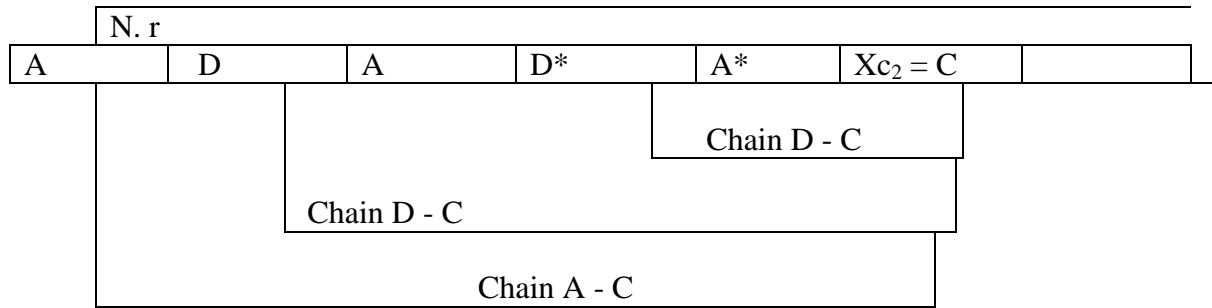

f.9c

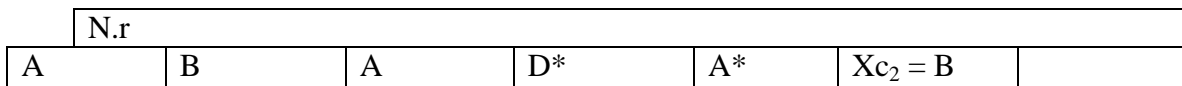

f.9d

If the first chain of chains A - C is before the first chain of chains D - C, and the first chain D - C is before the first chain of chains B - C (f.10a), then pass over chain A - C, take the chain D - C which is nearest to the first chain of chains B - C on the basic and repeat as above (f.10b,f.10c, f.10d).

If the first chain of chains D - C is before the first chain of chains A - C, and the first chain A - C is before the first chain of chains B - C, then pass over chain D - C, take the chain A - C which is nearest to the chain B - C on the basic and repeat as above.

If the chains are in order B - C, D - C, A - C or D - C, B - C, A - C, do by the same way, since A and B are the same role (only change roles A and B each other).

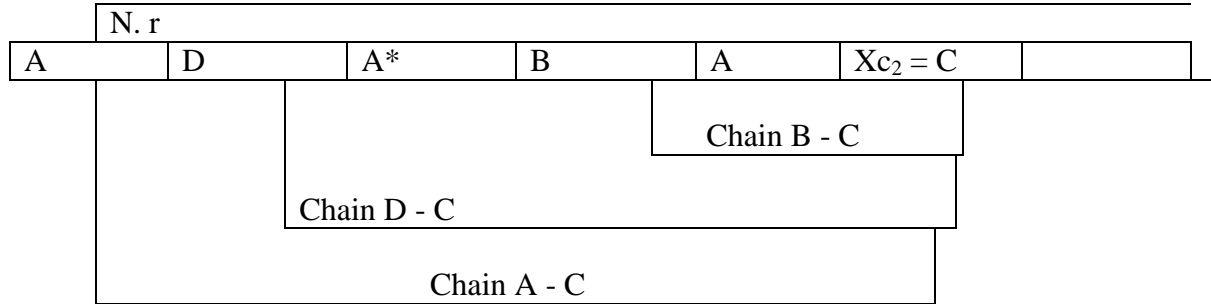

f.10a

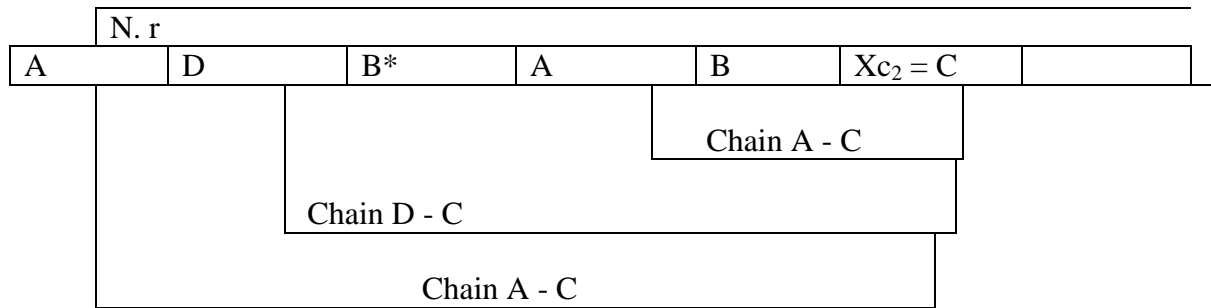

f.10b

*Since there was no chain A\* - C, so there is no chain B\* - C after interchange all A/B colors inside chain D - C. (if there is a chain A\* - C, pass over chain D - C, begin by taking chain A\* - C on the basic).*

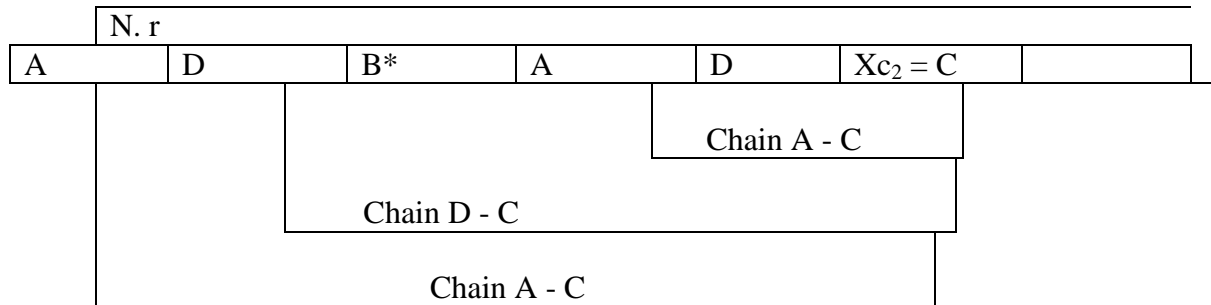

f.10c



N. r						
A	D	B*	A	D	$X_{C_2} = B$	

f.10d

After steps 2, if there is no more C color region from  $X_1$  to  $X_k$ , finish by coloring C color for N.r,

Step3:

If there is a C color region ( $X_{C_3}$ ) left from  $X_{C_2}$  to  $X_k$ , then consider the regions from  $X_1$  to  $X_{C_3}$ , repeat as step 2 until there is no C color region before  $X_k$ , and finish by coloring C color for N. r.

So, it is true for n+1 regions figure, problem was proved

*Note that, when we change the C color of  $X_{C_i}$  to  $B(A)$ , since there is no chain  $X_i - X_{C_i} = B(A) - C$  respectively before  $X_{C_i}$ , the regions  $X_i = B(A)$  color before  $X_{C_i}$  remain their color, so there is no C color region adjacent to Nr from  $X_1$  to  $X_{C_i}$ . they hold from  $X_1$  to  $X_{C_i}$ , a color of other regions can be scramble, but there will be no D color region adjacent to D area because we changed  $X_i = A(B)$  to D if only there was its surrounded chain B - C (A - C) respectively, and changed  $X_{C_i}$  only to  $B(A)$ , not to D. All conditions held.*

The cases considered above is general, some specific cases are below, however no problem for all.

- $X_1, X_k$  or both of them no adjacent to D area (f.11), then  $X_1, X_k$  can be D color.

N. r				
$X_1$	$X_2$			

f.11

- There are the regions from k regions no adjacent each other ( $X_3$  and  $X_4$  adjacent to N. r but no adjacent each other(f.12)), then there can be no chain  $X_3 - X_4$ .

N. r					
$X_1$	$X_2$	$X_3$	$X_4$		

f.12

- N regions figure enclosed by N. r. then use D color for N. r, let n+1 regions figure be as one region (D color region), then continue by using another color as a temporary color for the remaining area.
- There are at most two colors in the regions that adjacent to D area, we can continue as above. Beside, we can use D color for N. r, and take the remaining color as a temporary color for remaining area.

**B. Another way of proof:**

The initial conditions can be written as follows:

- Any adjacent regions have different colors.
- There is at least one of three A, B, C colors is not in the regions that adjacent to N. r, (this color will be used for N. r) and colors of  $X_1$  and  $X_k$  different from D (for  $X_1, X_k$  can be adjacent to D area).
- There is no D color from the regions (remaining ring regions) that adjacent to D area.

Let  $X_1, X_2, X_3, X_i, \dots, X_k$  regions taken from k regions which adjacent to N. r.

First, consider k=1 to 4:

Since three colors A, B and C are the same role:

k = 1:  $X_1 = A$  color then B or C color for N. r

k = 2:  $X_1 = A$  color,  $X_2 = B$  then C color for N. r

k = 3:

a.  $X_1 = A$  color,  $X_2 = B$ ,  $X_3 = A$  then C color for N. r

There is no problem for the above cases.

b.  $X_1 = A$ ,  $X_2 = B$ ,  $X_3 = C$ .

- If there is no chain  $X_1 - X_3 = A - C$  (f.13a), change  $X_3 = C$  to A, and then interchange the color of the C/A regions in the chain joining  $X_3 = C$ . Since  $X_1 = A$  is not in the chain, it remains A color, and there is now no C color region, N.r = C (f.13b).

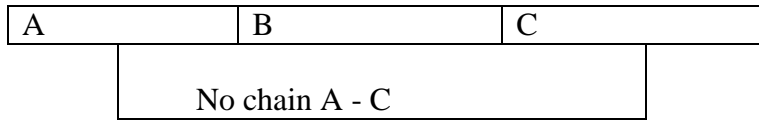

f.13a

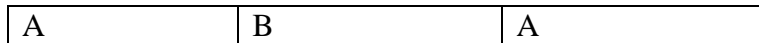

f.13b

- If there is a chain  $X_1 - X_3 = A - C$ , a chain  $X_2 - X_3 = B - C$  (f.14a), change  $X_2 = B$  to D, and then interchange the color of the B/D regions in the chain joining  $X_2 = B$ . Since there is the chain  $X_1 - X_3 = A - C$ , interchange B and D color inside chain  $X_1 - X_3 = A - C$  has no effect to change outside, outside that it was, and there is now no B color region, (f14.b), N.r = B.

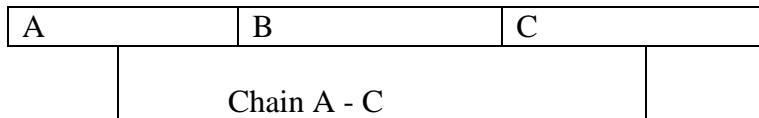

f.14a

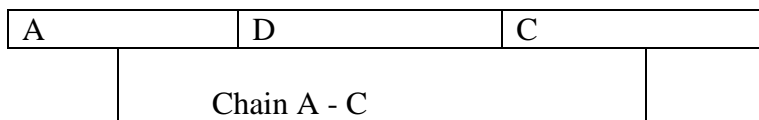

f.14b

k=4:

a.  $X_1 = A, X_2 = B, X_3 = A, X_4 = B$  then C color for N. r.

b.  $X_1 = A, X_2 = B, X_3 = A, X_4 = C$ :

If there is no chain  $X_2 - X_4 = B - C$  (f.15a), change  $X_4 = C$  to B, and then interchange the color of the C/B regions in the chain joining  $X_4 = C$ . Since  $X_2 = B$  is not in the chain, it remains B color, and there is now no C color region, (f.15b), N.r = C.

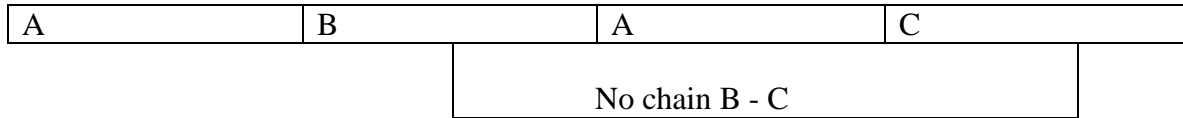

f.15a

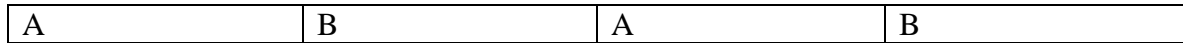

f.15b

If there is a chain  $X_1 - X_4 = A - C$ , a chain  $X_2 - X_4 = B - C$  (f.16a). Since there is the chain  $X_1 - X_4 = A - C$ , change  $X_2 = B$  to D, and then interchange the color of the B/D regions in the chain joining  $X_2 = B$ , and there is now no B color region (f.16b) N.r = B,.

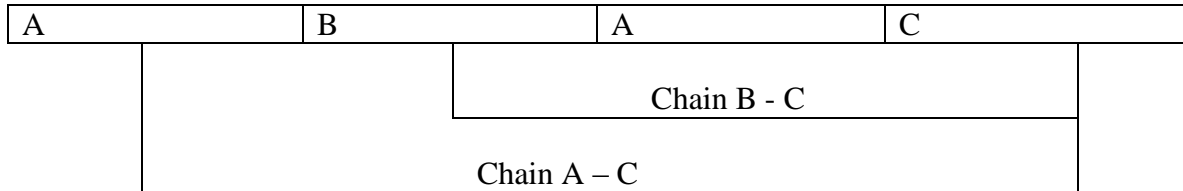

f.16a

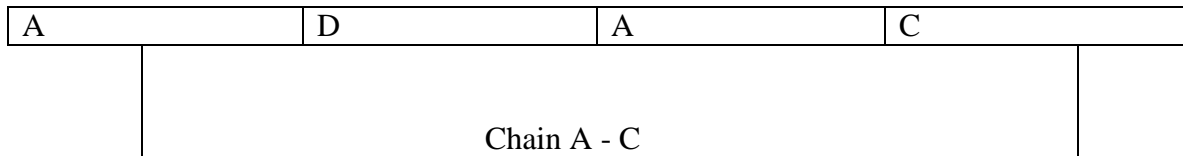

f.16b

If there is a chain  $X_2 - X_4 = B - C$ , no chain  $X_1 - X_4 = A - C$  (f.17a). Since there is the chain  $X_2 - X_4 = B - C$ , change  $X_3 = A$  to D, and then interchange the color of the A/D regions in the chain joining  $X_3 = A$  (f.17b), change  $X_4 = C$  to A, and then interchange the color of the C/A regions in the chain joining  $X_4 = C$ . Since  $X_1 = A$  is not in the chain, it remains A color, and there is now no C color region (f.17c), N.r = C.

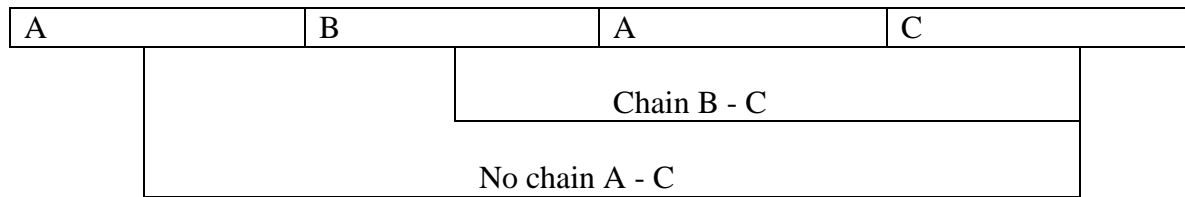

f.17a

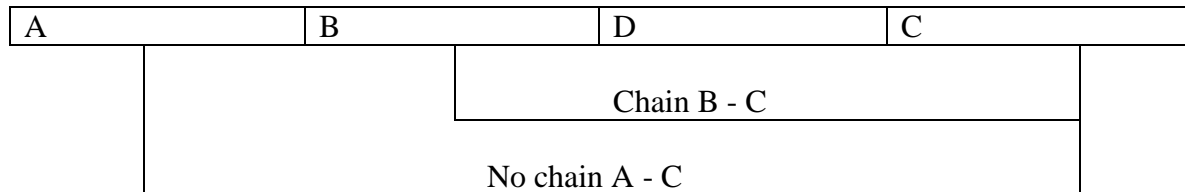

f.17b

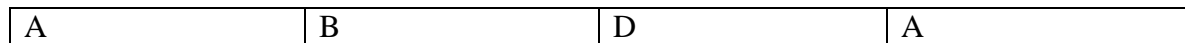

f.17c

c.  $X_1 = A, X_2 = D, X_3 = C, X_4 = A$  then **B** color for N. r.

d.  $X_1 = A, X_2 = D, X_3 = C, X_4 = B$ :

If there is no chain  $X_1 - X_4 = A - B$  (f.18a), change  $X_4 = B$  to  $A$ , and then interchange the color of the **B/A** regions in the chain joining  $X_4 = B$ . Since  $X_1 = A$  is not in the chain, it remains **A** color, and there is now no **B** color region (f.18b),  $N.r = B$ .

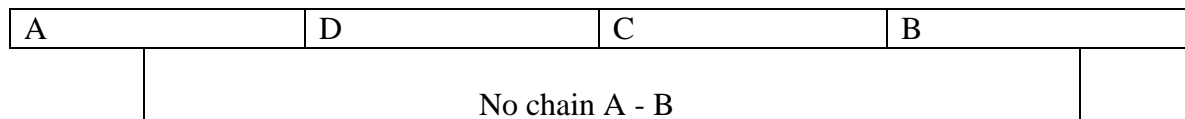

f.18a

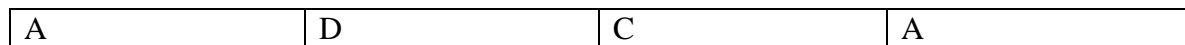

f.18b

If there is a chain  $X_2 - X_4 = D - B$  (f.19a), since there is the chain  $X_2 - X_4 = D - B$ , change  $X_3 = C$  to  $A$ , and then interchange the color of the **C/A** regions in the chain joining  $X_3 = C$ , and there is now no **C** color region (f.19b),  $N.r = C$ .

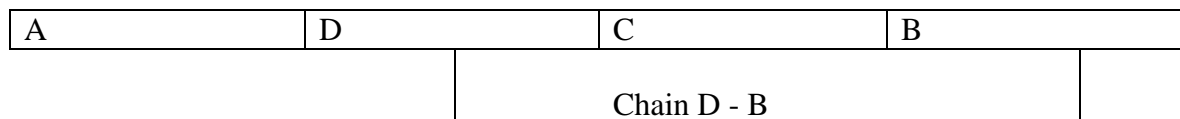

f.19a

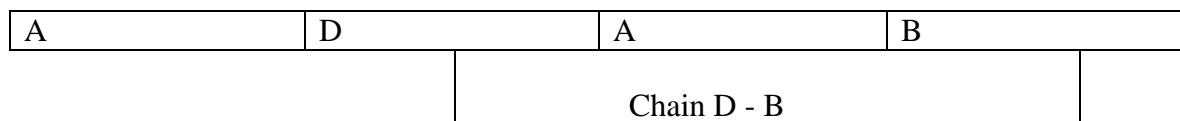

f.19b

If there is a chain  $X_1 - X_4 = A - B$ , no chain  $X_2 - X_4 = D - B$  (f.20a), since there is the chain  $X_1 - X_4 = A - B$ , interchange all C/D colors inside chain A-B, so  $X_2 = D$  become C color, since there is no chain  $X_2 - X_4 = D - B$ , interchange all D/C colors does not lead to form new chain  $X_2 - X_4 = C - B$ (f.20b), change  $X_4 = B$  to C, and then interchange the color of the B/C regions in the chain joining  $X_4 = B$ . Since  $X_2=C$  is not in the chain, it remains C color, and there is now no **B** color region (f.20c), N.r = B.

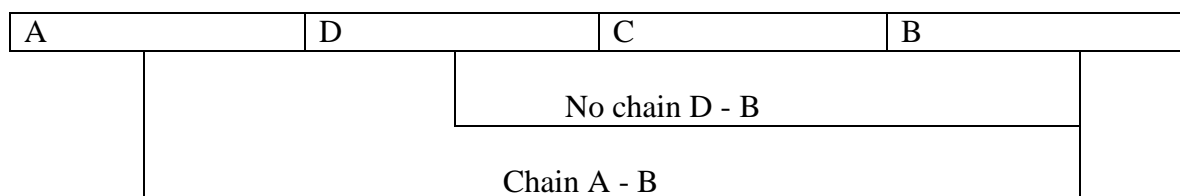

f.20a

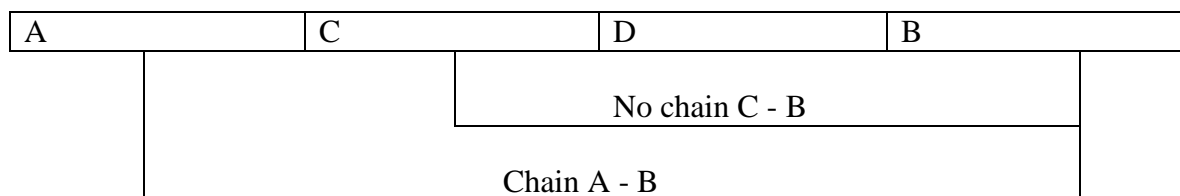

f.20b

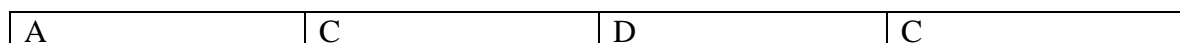

f.20c

So it is true for  $k=1, k=2, k=3, k=4$ , assume that if it is true for  $k$  regions, we prove that it must be true for  $k + 1$  regions.

Since it is true for  $k$  regions, so there is at least one of three colors A, B, and C is not in the  $k$  regions. Assume that, this color is C color, then  $X_k = A$  or B colors.

If  $X_{k+1} = B$  or A colors, there is no problem, N.r = C.

If  $X_{k+1} = C$  color, then consider regions from  $X_1$  to  $X_{k+1}$ , let  $X_{k+1}$  be as  $X_c$  and do by the same way as step 2 ( first proof), given result is also true for  $k+1$  regions, so it holds for any  $k$ .

Different points between two proofs above are:

The first: we choose only C color for N.r ( $X_1 = A$ )

The second: depending on the cases, we can use B or C color for N.r ( $X_1 = A$ )

*So, we can conclude that there are many ways to color a simple planar map in such a way that any adjacent regions have different colors.*

### **References:**

[1]. Thomas, Robin (1995), The Four - Color Theorem.

[2]. 'O Conner; Robertson (1996), The Four- Color Theorem, Mac Tutor archive.

[3]. Gonthier, Georges (2008), "Formal proof- The Four Color Theorem", (Notices of the American Mathematical Society).

E mail: [quangnhu67@yahoo.com.vn](mailto:quangnhu67@yahoo.com.vn)

[nguyenvquang67@gmail.com](mailto:nguyenvquang67@gmail.com)

Address: 232 Nguyen Sinh Cung st, Hue city- Vietnam