

SOLOMON I. KHMELNIK

**INCONSISTENCY SOLUTION
OF MAXWELL'S EQUATIONS**

First Editing – 22.07.2016
Second Editing – 02.09.2016
Third Editing – 22.07.2016
Fourth Editing – 08.11.2016

ISRAEL 2016

Copyright © 2016 by Solomon I. Khmelnik

All right reserved. No portion of this book may be reproduced or transmitted in any form or by any means, electronic or mechanical, without written permission of the author.

**Published by "MiC" - Mathematics in Computer Comp.
BOX 15302, Bene-Ayish, Israel, 60860
Fax: ++972-3-9471301**

**Printed in United States of America, Lulu Inc.,
ID 19043222
ISBN 978-1-365-23941-0**

Annotation

A new solution of Maxwell equations for a vacuum, for wire with constant and alternating current, for the capacitor, for the sphere, etc. is presented. First it must be noted that the proof of the solution's uniqueness is based on the Law of energy conservation which is not observed (for instantaneous values) in the known solution.

The solution offered:

- Complies with the energy conservation law in each moment of time, i.e. sets constant density of electromagnetic energy flux;
- Reveals phase shifting between electrical and magnetic intensities;
- Explains existence of energy flux along the wire that is equal to the power consumed.

A detailed proof is given for interested readers.

Experimental proofs of the theory are considered.

Explanation is proposed for the experiments, which have not yet been explained.

The work offers some technical applications of the solution obtained.

Please, send your comments and offers to e-mail:

solik@netvision.net.il

Contents

Preface \	4
Chapter 1. The Second Solution of Maxwell's Equations for vacuum \	12
Chapter 2. Solution of Maxwell's Equations for Electromagnetic Wave in the Dielectric Circuit of Alternating Current \	30
Chapter 3. Solution of Maxwell's Equations for Electromagnetic Wave in the Magnetic Circuit of Alternating Current \	40
Chapter 4. The solution of Maxwell's equations for the low-resistance Wire with Alternating Current \	48
Chapter 5. Solution of Maxwell's Equations for Wire with Constant \	67
Chapter 5a. Solution of Maxwell's Equations for Wire with Direct Ring Current \	90
Chapter 6. Single Wire Energy Emission and Transmission \	94
Chapter 7. The solution of Maxwell's equations for the capacitor in the constant circuit. The nature of the potential energy of the capacitor. \	101
Chapter 7a. Solution of Maxwell's equations around the end of a magnet \	110
Chapter 8. Solution of Maxwell's Equations for Spherical Capacitor \	117
Chapter 9. The Nature of Earth's Magnetism \	139
Chapter 10. Solution of Maxwell's Equations for Ball Lightning \	143
Chapter 11. General conclusions \	156
References \	160-164

Preface

Contents

1. Introduction \ 4
2. On Energy Flux in Wire \ 6
3. Requirements for Consistent Solution of Maxwell's Equations \ 6
4. Variants of Maxwell's Equations \ 7
- Appendix 1. Cylindrical Coordinates \ 9
- Appendix 2. Spherical Coordinates \ 10
- Appendix 3. Some Correlations Between GHS and SI Systems \ 11

1. Introduction

“To date, whatsoever effect that would request a modification of Maxwell's equations escaped detection” [36]. Nevertheless, recently criticism of validity of Maxwell equations is heard from all sides. Have a look at the Fig.1 that shows a wave being a known solution of Maxwell's equations. The confidence of critics is created first of all by the violation of the Law of energy conservation. And certainly *"the density of electromagnetic energy flow (the module of Umov-Pointing vector) pulsates harmonically. Doesn't it violate the Law of energy conservation?"* [1]. Certainly, it is violated, **if** the electromagnetic wave satisfies the **known solution** of Maxwell equations. But there is no other solution: *"The proof of solution's uniqueness in general is as follows. If there are two different solutions, then their difference due to the system's linearity, will also be a solution, but for zero charges and currents and for zero initial conditions. Hence, using the expression for electromagnetic field energy we must conclude that the difference between solutions is equal to zero, which means that the solutions are identical. Thus the uniqueness of Maxwell equations solution is proved"* [2]. So, the uniqueness of solution is being proved on the base of using the law which is violated in this solution.

Another result following from the existing solution of Maxwell equations is phase synchronism of electrical and magnetic components of intensities in an electromagnetic wave. This is contrary to the idea of constant transformation of electrical and magnetic components of energy in an electromagnetic wave. In [1], for example, this fact is called "one of the vices of the classical electrodynamics".



Рис. 1.

Such results following from the known solution of Maxwell equations allow doubting the authenticity of Maxwell equations. However, we must stress that these results follow **only from the found solution**. But this solution, as has been stated above, can be different (in their partial derivatives, equations generally have several solutions).

Further we shall deduct **another solution** of Maxwell equation, in which the density of electromagnetic energy flow remains constant in time, and electrical and magnetic components of intensities in the electromagnetic wave are shifted in in phase.

In addition, consider an electromagnetic wave in wire. With an assumed negligibly low voltage, Maxwell's equations for this wave literally coincide with those for the wave in vacuum. Yet, electrical engineering eludes any known solution and employs the one that connects an intensity of the circular magnetic field with the current in the wire (for brevity, it will be referred to as “electrical engineering solution”). This solution, too, satisfies the Maxwell's equations. However, firstly, it is one more solution of those equations (which invalidates the theorem of the only solution known). Secondly, and the most important, electrical engineering solution does not explain the famous experimental fact.

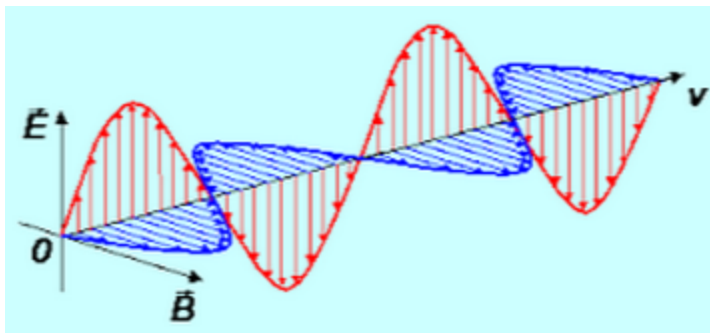
The case in point is skin-effect. Solution to explain skin-effect should contain a non-linear radius-to-displacement current (flowing along the wire) dependence. According to Maxwell's equations, such dependence should fit with radial and circular electrical and magnetic intensities that have non-linear dependence from the radius. Electrical engineering solution offers none of these. Explanation of skin-effect bases on the Maxwell's equations, yet it does not follow from electrical engineering solution. It allows the statement that electrical engineering solution does not explain the famous experimental fact.

At last, the existing solution denies the existence of so called twisted light [65].

2. On Energy Flux in Wire

Now, refer to energy flux in wire. The existing idea of energy transfer through the wires is that the energy in a certain way is spreading outside the wire [13]: *"... so our "crazy" theory says that the electrons are getting their energy to generate heat because of the energy flowing into the wire from the field outside. Intuition would seem to tell us that the electrons get their energy from being pushed along the wire, so the energy should be flowing down (or up) along the wire. But the theory says that the electrons are really being pushed by an electric field, which has come from some charges very far away, and that the electrons get their energy for generating heat from these fields. The energy somehow flows from the distant charges into a wide area of space and then inward to the wire."*

Such theory contradicts the Law of energy conservation. Indeed, the energy flow, travelling in the space must lose some part of the energy. But this fact was found neither experimentally, nor theoretically. But, most important, this theory contradicts the following experiment. Let us assume that through the central wire of coaxial cable runs constant current. This wire is isolated from the external energy flow. Then whence the energy flow compensating the heat losses in the wire comes? With the exception of loss in wire, the flux should penetrate into a load, e.g. winding of electrical motors covered with steel shrouds of the stator. This matter is omitted in the discussions of the existing theory.

So, the existing theory claims that the incoming (perpendicularly to the wire) electromagnetic flow permits the current to overcome the resistance to movement and performs work that turns into heat. This known conclusion veils the natural question: how can the current attract the flow, if the current appears due to the flow? It is natural to assume that the flow creates a certain emf which "moves the current". Meanwhile, energy flux of the electromagnetic wave exists in the wave itself and does not use space exterior towards the wave.

Solution of Maxwell's equations should model a structure of the electromagnetic wave with electromagnetic flux energy presenting in it.

The intuition Feynman speaks of has been well founded. The author proves it further while restricted himself to Maxwell's equations.

3. Requirements for Consistent Solution of Maxwell's Equations

Thus, the solution of Maxwell's equations must:

- describe wave in vacuum and wave in wire;
- comply with the energy conservation law in each moment of time, i.e. set constant density of electromagnetic energy flux;
- reveal phase shifting between electrical and magnetic intensities;
- explain existence of energy flux along the wire that is equal to power consumed.

What follows is an appropriate derivation of Maxwell's equations.

4. Variants of Maxwell's Equations

Further, we separate different special cases (alternatives) of Maxwell's equations system numbered for convenience of presentation.

Variant 1.

Maxwell's equations in the general case in the GHS system are of the form [3]:

$$\operatorname{rot}(E) + \frac{\mu}{c} \frac{\partial H}{\partial t} = 0, \quad (1)$$

$$\operatorname{rot}(H) - \frac{\varepsilon}{c} \frac{\partial E}{\partial t} - \frac{4\pi}{c} I = 0, \quad (2)$$

$$\operatorname{div}(E) = 0, \quad (3)$$

$$\operatorname{div}(H) = 0, \quad (4)$$

$$I = \sigma E, \quad (5)$$

where

I , H , E - conduction current, magnetic and electric intensities respectively,

ε , μ , σ - dielectric constant, magnetic permeability, conductivity wire material.

Variant 2.

For the vacuum must be taken $\varepsilon = 1$, $\mu = 1$, $\sigma = 0$. When the system of equations (1-5) takes the form:

$$\operatorname{rot}(E) + \frac{1}{c} \frac{\partial H}{\partial t} = 0, \quad (6)$$

$$\operatorname{rot}(H) - \frac{1}{c} \frac{\partial E}{\partial t} = 0, \quad (7)$$

$$\operatorname{div}(E) = 0, \quad (8)$$

$$\operatorname{div}(H) = 0. \quad (9)$$

The solution to this system is offered in the **Chapter 1**.

Variant 3.

Consider the case 1 in the complex presentation:

$$\text{rot}(E) + i\omega \frac{\mu}{c} H = 0, \quad (10)$$

$$\text{rot}(H) - i\omega \frac{\varepsilon}{c} E - \frac{4\pi}{c} (\text{real}(I) + i \cdot \text{imag}(I)) = 0, \quad (11)$$

$$\text{div}(E) = 0, \quad (12)$$

$$\text{div}(H) = 0, \quad (13)$$

$$\text{real}(I) = \sigma \cdot \text{abs}(E). \quad (14)$$

It should be noted that instead of showing the whole current, (14) shows only its real component, i.e. conductivity current. Imaginary component formed by a displacement current does not depend on electrical charges.

The solution to this system is offered in the **Chapter 4**.

Variant 4.

For the wire with *sinusoidal current* I flowing out of an external source, $\text{real}(I)$ may at times be excluded from equations (11-14). It is possible for a low-resistance wire and for a dielectric wire (for more details, refer to Chapter 2). As this takes place, the system (11-14) takes the form of

$$\text{rot}(E) + \frac{\mu}{c} \frac{\partial H}{\partial t} = 0, \quad (15)$$

$$\text{rot}(H) - \frac{\varepsilon}{c} \frac{\partial E}{\partial t} - \frac{4\pi}{c} I = 0, \quad (16)$$

$$\text{div}(E) = 0, \quad (17)$$

$$\text{div}(H) = 0. \quad (18)$$

It is significant that current I is not a conductivity current even when it flows along the conductor.

The solution for this system will be considered in the **Chapter 2**.

Variant 5.

For a constant current wire, system in alternative 1 simplifies due to lack of time derivative and takes the form of:

$$\text{rot}(E) = 0, \quad (21)$$

$$\text{rot}(H) - \frac{4\pi}{c} I = 0, \quad (22)$$

$$\text{div}(E) = 0, \quad (24)$$

$$\operatorname{div}(H)=0, \quad (25)$$

$$I = \sigma E \quad (26)$$

or

Variant 6.

$$\operatorname{rot}(I)=0, \quad (27)$$

$$\operatorname{rot}(H) - \frac{4\pi}{c} I = 0, \quad (28)$$

$$\operatorname{div}(I)=0, \quad (29)$$

$$\operatorname{div}(H)=0. \quad (30)$$

The solution for this system will be considered in the **Chapter 3**.

We will be searching a monochromatic solution of the systems mentioned. A transition to polychromatic solution can be accomplished via Fourier transformation.

We will employ cylindrical system of coordinates r, φ, z - see Appendix 1. Obviously, if solution exists in the cylindrical system of coordinates, it exists in any other system of coordinates, too.

Appendix 1. Cylindrical Coordinates

As it is known to [4], in cylindrical coordinates scalar divergence of H vector, vector gradient of scalar function $a(x, y, z)$, vector rotor of H vector, accordingly, take the form of

$$\operatorname{div}(H) = \left(\frac{H_r}{r} + \frac{\partial H_r}{\partial r} + \frac{1}{r} \cdot \frac{\partial H_\varphi}{\partial \varphi} + \frac{\partial H_z}{\partial z} \right), \quad (a)$$

$$\operatorname{grad}_r(a) = \frac{\partial a}{\partial r}, \quad \operatorname{grad}_\varphi(a) = \frac{1}{r} \cdot \frac{\partial a}{\partial \varphi}, \quad \operatorname{grad}_z(a) = \frac{\partial a}{\partial z}, \quad (b)$$

$$\operatorname{rot}_r(H) = \left(\frac{1}{r} \cdot \frac{\partial H_z}{\partial \varphi} - \frac{\partial H_\varphi}{\partial z} \right), \quad (c)$$

$$\operatorname{rot}_\varphi(H) = \left(\frac{\partial H_r}{\partial z} - \frac{\partial H_z}{\partial r} \right), \quad (d)$$

$$\operatorname{rot}_z(H) = \left(\frac{H_\varphi}{r} + \frac{\partial H_\varphi}{\partial r} - \frac{1}{r} \cdot \frac{\partial H_r}{\partial \varphi} \right). \quad (e)$$

Appendix 2. Spherical Coordinates

Fig. 1 shows a system of spherical coordinates ρ, θ, φ , and Table 1 contains expressions for rotor and divergence of vector \mathbf{E} in these coordinates [4].

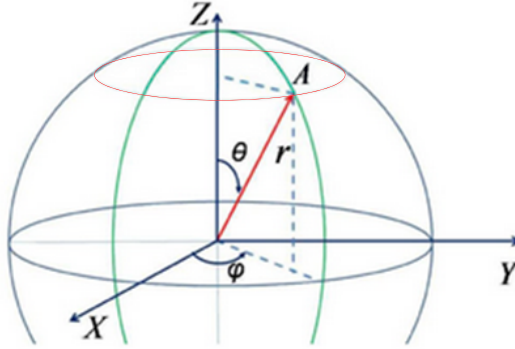

Fig. 1.

Table 1.

1	2	3
1	$\text{rot}_\rho(E)$	$\frac{E_\varphi}{\rho \text{tg}(\theta)} + \frac{\partial E_\varphi}{\rho \partial \theta} - \frac{\partial E_\theta}{\rho \sin(\theta) \partial \varphi}$
2	$\text{rot}_\theta(E)$	$\frac{\partial E_\rho}{\rho \sin(\theta) \partial \varphi} - \frac{E_\varphi}{\rho} - \frac{\partial E_\varphi}{\partial \rho}$
3	$\text{rot}_\varphi(E)$	$\frac{E_\theta}{\rho} + \frac{\partial E_\theta}{\partial \rho} - \frac{\partial E_\rho}{\rho \partial \varphi}$
4	$\text{div}(E)$	$\frac{E_\rho}{\rho} + \frac{\partial E_\rho}{\partial \rho} + \frac{E_\theta}{\rho \text{tg}(\theta)} + \frac{\partial E_\theta}{\rho \partial \theta} + \frac{\partial E_\varphi}{\rho \sin(\theta) \partial \varphi}$

Appendix 3. Some Correlations Between GHS and SI Systems

Further, formulas appear in GHS system, yet, for illustration, some examples are shown in SI system. This is why, for reader's convenience, Table 1 contains correlations between some measurement units of these systems.

Table 1.

Name	GHS	SI
electric current	1 GHS	$3,33 \cdot 10^{-10}$ A
voltage	1 GHS	$3 \cdot 10^2$ V
power, energy flux density	1 GHS	10^{-7} Wt
energy flux density per unit length of wire	1 GHS	10^{-5} Wt/m
electric current density	1 GHS	$3.33 \cdot 10^{-6}$ A/m ² $3.33 \cdot 10^{-12}$ A/mm ²
electric field intensity	1 GHS	$3 \cdot 10^4$ V/m
magnetic field intensity	1 GHS	80 A/m
magnetic induction	1 GHS	10^{-4} T
absolute dielectric permittivity	1 GHS	$8.85 \cdot 10^{-12}$ F/m
absolute magnetic permeability	1 GHS	$1.26 \cdot 10^{-8}$ H/m
capacitance	1 GHS	$1.1 \cdot 10^{-12}$ F
inductance	1 GHS	10^{-9} H
electrical resistance	1 GHS	$9 \cdot 10^{11}$ Om
electrical conductivity	1 GHS	$1.1 \cdot 10^{-12}$ sm
specific electrical resistance	1 GHS	$9 \cdot 10^9$ Om·m
specific electrical conductivity	1 GHS	$1.1 \cdot 10^{-10}$ sm/m

Chapter 1. The Second Solution of Maxwell's Equations for vacuum

Contents

1. Introduction
2. Solution of Maxwell's Equations
3. Intensities
4. Energy Flows
5. Impulse and momentum
6. Discussion
- Appendix 1
- Appendix 2

1. Introduction

In Chapter "Introduction" inconsistency of well-known solution of Maxwell's equations was demonstrated. A new solution Maxwell's equations for vacuum is proposed below [5].

2. Solution of Maxwell's Equations

First we shall consider the solution of Maxwell equation for vacuum, which is shown in Chapter "Introduction" as variant 1, and takes the following form

$$\text{rot}(E) + \frac{1}{c} \frac{\partial H}{\partial t} = 0,$$

$$\text{rot}(H) - \frac{1}{c} \frac{\partial E}{\partial t} = 0,$$

$$\text{div}(E) = 0,$$

$$\text{div}(H) = 0.$$

In cylindrical coordinates system r, φ, z these equations look as follows:

$$\frac{E_r}{r} + \frac{\partial E_r}{\partial r} + \frac{1}{r} \cdot \frac{\partial E_\varphi}{\partial \varphi} + \frac{\partial E_z}{\partial z} = 0, \quad (1)$$

$$\frac{1}{r} \cdot \frac{\partial E_z}{\partial \varphi} - \frac{\partial E_\varphi}{\partial z} = M_r, \quad (2)$$

$$\frac{\partial E_r}{\partial z} - \frac{\partial E_z}{\partial r} = M_\varphi, \quad (3)$$

$$\frac{E_\varphi}{r} + \frac{\partial E_\varphi}{\partial r} - \frac{1}{r} \cdot \frac{\partial E_r}{\partial \varphi} = M_z, \quad (4)$$

$$\frac{H_r}{r} + \frac{\partial H_r}{\partial r} + \frac{1}{r} \cdot \frac{\partial H_\varphi}{\partial \varphi} + \frac{\partial H_z}{\partial z} = 0, \quad (5)$$

$$\frac{1}{r} \cdot \frac{\partial H_z}{\partial \varphi} - \frac{\partial H_\varphi}{\partial z} = J_r, \quad (6)$$

$$\frac{\partial H_r}{\partial z} - \frac{\partial H_z}{\partial r} = J_\varphi, \quad (7)$$

$$\frac{H_\varphi}{r} + \frac{\partial H_\varphi}{\partial r} - \frac{1}{r} \cdot \frac{\partial H_r}{\partial \varphi} = J_z, \quad (8)$$

$$J = \frac{1}{c} \frac{\partial E}{\partial t}, \quad (9)$$

$$M = -\frac{1}{c} \frac{\partial H}{\partial t}. \quad (10)$$

For the sake of brevity further we shall use the following notations:

$$co = \cos(\alpha\varphi + \chi z + \omega t), \quad (11)$$

$$si = \sin(\alpha\varphi + \chi z + \omega t), \quad (12)$$

where α , χ , ω – are certain constants. Let us present the unknown functions in the following form:

$$J_r = j_r(r)co, \quad (13)$$

$$J_\varphi = j_\varphi(r)si, \quad (14)$$

$$J_z = j_z(r)si, \quad (15)$$

$$H_r = h_r(r)co, \quad (16)$$

$$H_\varphi = h_\varphi(r)si, \quad (17)$$

$$H_z = h_z(r)si, \quad (18)$$

$$E_r = e_r(r)si, \quad (19)$$

$$E_\varphi = e_\varphi(r)co, \quad (20)$$

$$E_z = e_z(r)co, \quad (21)$$

$$M_r = m_r(r)co, \quad (21)$$

$$M_\varphi = m_\varphi(r)si, \quad (22)$$

$$M_z = m_z(r)si, \quad (23)$$

where $j(r)$, $h(r)$, $e(r)$, $m(r)$ – certain function of the coordinate r .

By direct substitution we can verify that the functions (13-23) transform the equations system (1-10) with three arguments r, φ, z into equations system with one argument r and unknown functions $j(r), h(r), e(r), m(r)$.

In Appendix 1 it is shown that for such a system there **exists** a solution of the following form (in Appendix 1 see (24, 27, 18, 31, 33, 34, 32) respectively):

$$h_z(r) = 0, e_z(r) = 0. \quad (24)$$

$$e_r = e_\varphi = \frac{A}{2} r^{-(1-\alpha)}, \quad (25)$$

$$h_\varphi(r) = e_r(r). \quad (26)$$

$$h_r(r) = -e_\varphi(r), \quad (27)$$

$$\chi = \omega/c. \quad (28)$$

where $A, c, \alpha, \chi, \omega$ – constants.

Thus we have got a monochromatic solution of the equation system (1-10). A transition to polychromatic solution can be achieved with the aid of Fourier transform.

If it exists in cylindrical coordinate system, then it exists in any other coordinate system. It means that we have got a common solution of Maxwell equations in vacuum.

3. Intensities

We consider (2.25):

$$e_r = e_\varphi = 0.5A \cdot r^{\alpha-1}, \quad (1)$$

where $A \setminus 2$ - the amplitude of the intensities. From (1) it follows that

$$(e_r^2 + e_\varphi^2) = A \cdot r^{2(\alpha-1)}. \quad (2)$$

Fig. 1 shows, for example, the graphics functions (1, 2) for $A = -1, \alpha = 0.8$.

Fig. 2 shows the vectors of intensities originating from the point $A(r, \varphi)$. Let us remind that $h_\varphi(r) = e_r(r)$ and $h_r(r) = -e_\varphi(r)$ - see (2.26, 2.27). The directions of vectors $e_r(r)$ and $e_\varphi(r)$ are chosen as: $e_r(r) > 0, e_\varphi(r) < 0$. Note that the **vectors** E, H **are always orthogonal**. The sum of the modules of these vectors is determined from (2.17, 2.18, 2.20, 2.21, 2.26, 2.27) and is equal to

$$W = E^2 + H^2 = (e_r(r) \sin i)^2 + (e_\varphi(r) \sin i)^2 + (h_r(r) \cos o)^2 + (h_\varphi(r) \cos o)^2$$

or

$$W = (e_r(r))^2 + (e_\varphi(r))^2 \tag{3}$$

- see also (10) and Fig. 1. Thus, electromagnetic wave energy density is constant in time and equal in all points of the cylinder of given radius.

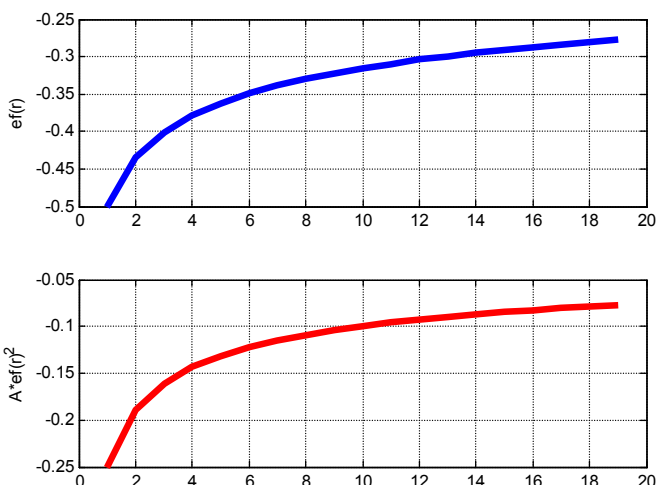

Fig.1. SecondSolMax.m

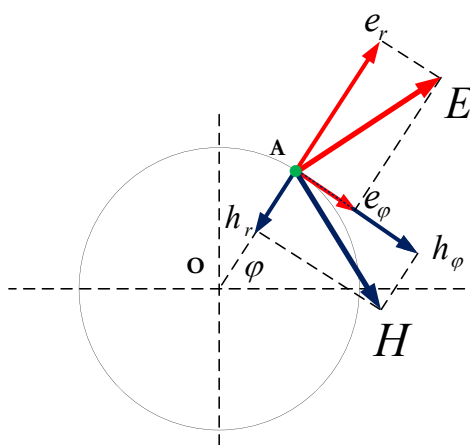

Fig. 2.

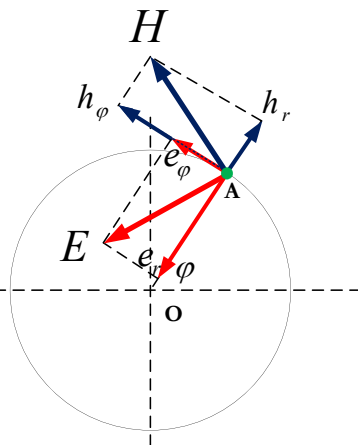

Fig. 3.

The solution exists also for changed signs of the functions (2.11, 2.21). This case is shown on Fig 3. Fig. 2 and Fig. 3 illustrate the fact that there are two possible type of electromagnetic wave circular polarization.

In order to demonstrate phase shift between the wave components let's consider the functions (2.11, 2.12) and (2.16-2.21). It can be seen,

that at each point with coordinates r, φ, z intensities H, E are shifted in phase by a quarter-period.

Let's consider the functions (2.11, 2.12) and (2.28). Then, we can find

$$co = \cos(\alpha\varphi + \frac{\omega}{c}z + \omega t), \quad si = \sin(\alpha\varphi + \frac{\omega}{c}z + \omega t). \quad (4)$$

Let's consider a point moving along a cylinder of constant radius r , where the value of intensity depends on time as follows:

Let's consider a point moving along a cylinder of constant radius r , at which the value of intensity depends on time as follows:

$$H_{r.} = h_r(r)\cos(\omega t) \quad (5)$$

Comparing this equation with (2.16) and taking (4) into account, we can notice that equation (5) is the same as (2.16), if at any moment of time

$$\alpha\varphi + \frac{\omega}{c}z = 0 \quad (6)$$

or

$$\varphi = -\frac{\omega}{\alpha \cdot c}z. \quad (7)$$

Thus, at the cylinder of constant radius r a path of this point exists, which is described by equations (4, 7, 2.28), where all the intensities vary harmonically. On the other hand, this path is a helix. Thus, the line, along which the point moves in such a way, that its intensity $H_{r.}$ varies in a sinusoidal manner, is a helix. The same conclusion can be repeated for other intensities (2.17-2.21). Thus,

the path of the point, which moves along a cylinder of given radius in such a manner, that each intensity varies harmonically with time, is described by a helix.

(A)

For example, Fig. 4 shows a helix, for which $r = 1, c = 300000, \omega = 3000, \alpha = -3, \varphi = [0 \div 2\pi]$. Fig. 4a shows helices in the same conditions, but for different radii, where $r = [0.5, 0.6, \dots 1.0, 1.1]$. Straight lines indicate the geometric loci of points with equal φ .

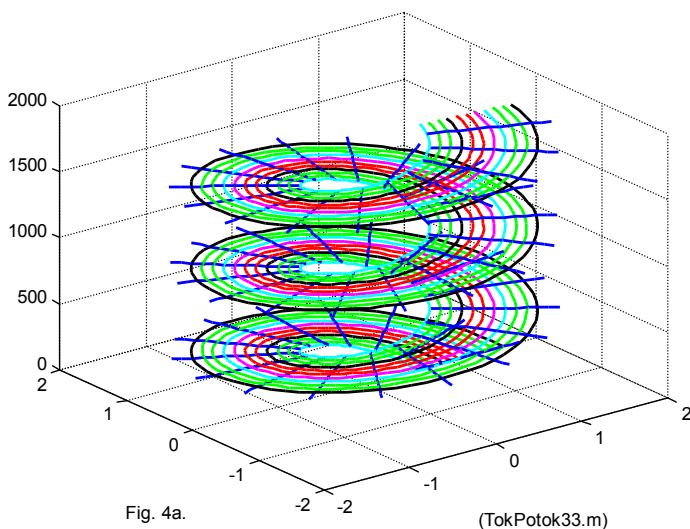
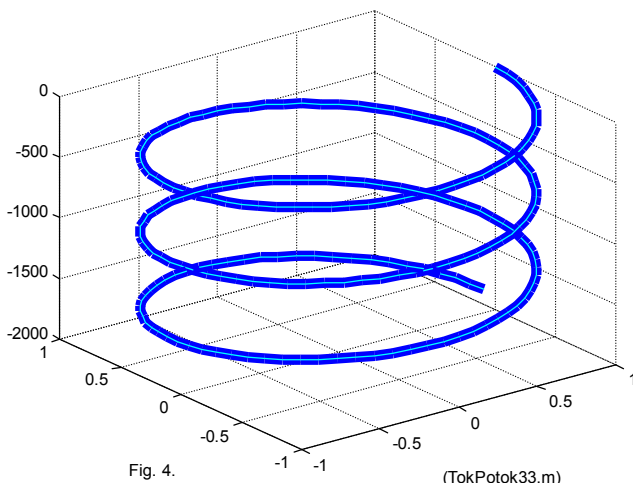

The last means **(A)** that at point T , moving along this helix the vectors of intensities (2.16-2.21) can be written as follows:

$$H_r = h_r(r) \cos(\omega t), \quad H_\varphi = h_\varphi(r) \sin(\omega t), \quad H_z = h_z(r) \sin(\omega t),$$

$$E_r = e_r(r) \sin(\omega t), \quad E_\varphi = e_\varphi(r) \cos(\omega t), \quad E_z = e_z(r) \cos(\omega t).$$

It was shown above (see 2.24-2.27), that

$$h_z(r) = 0, \quad e_z(r) = 0, \quad e_r(r) = e_\varphi(r) = e_{r\varphi}(r), \quad h_\varphi(r) = e_{r\varphi}(r), \quad h_r(r) = -e_{r\varphi}(r).$$

Therefore, at each point there are only vectors

$$H_{r\cdot} = -e_{r\varphi}(r)\cos(\omega t), \quad H_{\varphi\cdot} = e_{r\varphi}(r)\sin(\omega t),$$

$$E_{r\cdot} = e_{r\varphi}(r)\sin(\omega t), \quad E_{\varphi\cdot} = e_{r\varphi}(r)\cos(\omega t).$$

In this case resultant vectors $H_{r\varphi} = H_r + H_\varphi$ and $E_{r\varphi} = E_r + E_\varphi$ lay in plane r, φ , and their moduli are $|H_{r\varphi}| = e_{r\varphi}(r)$ and $|E_{r\varphi}| = e_{r\varphi}(r)$. Fig. 4b shows all these vectors. It can be seen, that when the point T moves along the helix, resultant vectors $H_{r\varphi}$ and $E_{r\varphi}$ rotate in plane r, φ . Their moduli are constant and equal one to the other. These vectors $H_{r\varphi}$ and $E_{r\varphi}$ are always orthogonal.

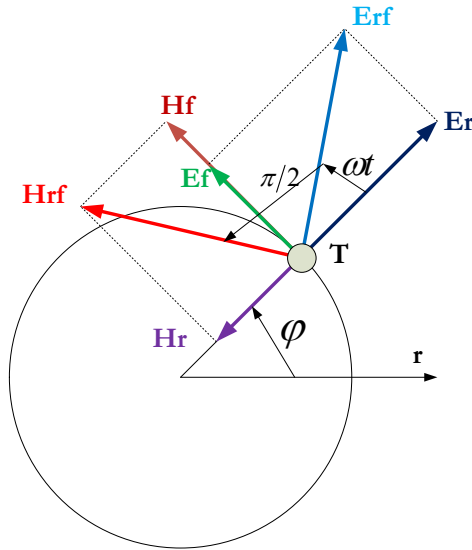

Fig. 4b.

So, **harmonic wave is propagating along the helix**, and in this case at each point T , which moves along this helix, vectors of magnetic and electric intensities:

- exist only in the plane which is perpendicular to the helix axis, i.e. there only two projections of these vectors exist,
- vary in a sinusoidal manner,
- are shifted in phase by a quarter-period.

Resultant vectors:

- rotate in these plane,
- have constant moduli,
- are orthogonal to each other.

4. Energy Flows

The density of electromagnetic flow is Poynting vector

$$\mathbf{S} = \eta \mathbf{E} \times \mathbf{H}, \quad (1)$$

where

$$\eta = c/4\pi. \quad (2)$$

In the SI system $\eta = 1$ and the last formula (1) takes the form:

$$\mathbf{S} = \mathbf{E} \times \mathbf{H}, \quad (3)$$

In cylindrical coordinates r, φ, z the density flow of electromagnetic energy has three components S_r, S_φ, S_z , directed along the axis accordingly. They are determined by the formula

$$\mathbf{S} = \begin{bmatrix} S_r \\ S_\varphi \\ S_z \end{bmatrix} = \eta(\mathbf{E} \times \mathbf{H}) = \eta \begin{bmatrix} E_\varphi H_z - E_z H_\varphi \\ E_z H_r - E_r H_z \\ E_r H_\varphi - E_\varphi H_r \end{bmatrix}. \quad (4)$$

From (2.12-2.17, 3.4) follows that the flow passing through a given section of the wave in a given moment, is:

$$\bar{\mathbf{S}} = \begin{bmatrix} \bar{S}_r \\ \bar{S}_\varphi \\ \bar{S}_z \end{bmatrix} = \eta \iiint_{r,\varphi} \begin{bmatrix} s_r \cdot si^2 \\ s_\varphi \cdot si \cdot co \\ s_z \cdot si \cdot co \end{bmatrix} dr \cdot d\varphi. \quad (5)$$

where

$$\begin{aligned} s_r &= (\mathbf{e}_\varphi h_z - \mathbf{e}_z h_\varphi) \\ s_\varphi &= (\mathbf{e}_z h_r - \mathbf{e}_r h_z). \\ s_z &= (\mathbf{e}_r h_\varphi - \mathbf{e}_\varphi h_r) \end{aligned} \quad (6)$$

In Appendix 1 it is shown that $h_z(r) = 0, e_z(r) = 0$. Consequently, $s_r = 0, s_\varphi = 0$, i.e. the energy flow extends only along the axis oz and is equal to

$$\bar{\mathbf{S}} = \bar{S}_z = \eta \iiint_{r,\varphi} [s_z \cdot si \cdot co] dr \cdot d\varphi. \quad (7)$$

Lack of radial energy flux indicates that area of wave existence is **NOT** growing. Existence of laser provides evidence of this fact.

We'll find s_z . From (2.26, 2.27), we obtain:

$$\mathbf{e}_r h_\varphi = \mathbf{e}_r^2, \quad (8)$$

$$\mathbf{e}_\varphi h_r = -\mathbf{e}_\varphi^2. \quad (9)$$

From (7, 8, 9), we obtain:

$$s_z = (e_r^2 + e_\varphi^2). \tag{10}$$

In this way,

$$\bar{S} = \eta \iint_{r,\varphi} [(e_r^2 + e_\varphi^2) \cdot si \cdot co] dr \cdot d\varphi. \tag{11}$$

Hence, as shown in Appendix 2, it follows that

$$\bar{S} = \frac{c}{16\alpha\pi} (1 - \cos(4\alpha\pi)) \int_r ((e_r^2 + e_\varphi^2) dr). \tag{12}$$

From (10, 3.12), we obtain:

$$\bar{S} = \frac{cA}{16\alpha\pi} (1 - \cos(4\alpha\pi)) \int_r (r^{2(\alpha-1)}) dr. \tag{12a}$$

Let R be the radius of the circular front of the wave. Then

$$S_{int} = \int_{r=0}^R (r^{2(\alpha-1)}) dr = \frac{R^{(2\alpha-1)}}{(2\alpha-1)}, \tag{13}$$

$$S_{alfa} = \frac{1}{\alpha} (1 - \cos(4\alpha\pi)), \tag{14}$$

$$\bar{S} = \frac{cA}{16\pi} S_{alfa} S_{int}. \tag{15}$$

Fig. 5 shows the function $S_{alfa}(\alpha)$ (13) and Fig. 6 shows the function $S_{int}(\alpha)$. On Fig. 6 the upper and lower curves refer accordingly to $R = 200$ and $R = 100$. From the formula (15), Fig. 5 and Fig. 6 that the power flow is positive, for example, at $A = -1$, $\alpha = 0.8$. $A = -1$, $\alpha = 0.8$.

Since the energy flow and the energy are related by the expression $S = W \cdot c$, then from (15) we can find the energy of a wavelength unit:

$$\bar{W} = \frac{A}{16\pi} S_{alfa} S_{int}. \tag{17}$$

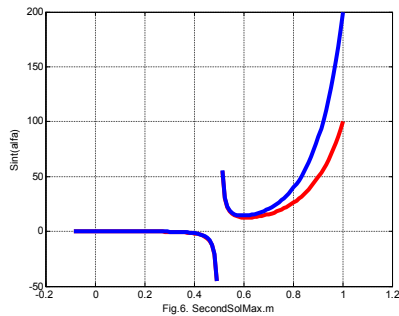
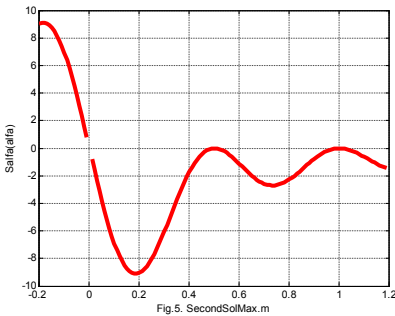

In Appendix 2 also shows that the energy flux density on the circle is determined by function of the form

$$\bar{S}_{rz} = (e_r^2 + e_\varphi^2) \sin(2\alpha\varphi + 4\omega z/c). \quad (18)$$

From this and from (3.10) we obtain:

$$\bar{S}_{rz} = A \cdot r^{2(\alpha-1)} \sin(2\alpha\varphi + 4\omega z/c). \quad (19)$$

In Fig. 7 shows these functions, when $A = 1$, $\alpha = 0.8$, $r = 1$, and the second term has two values: 0; 0.5 - see the solid and dashed lines, respectively.

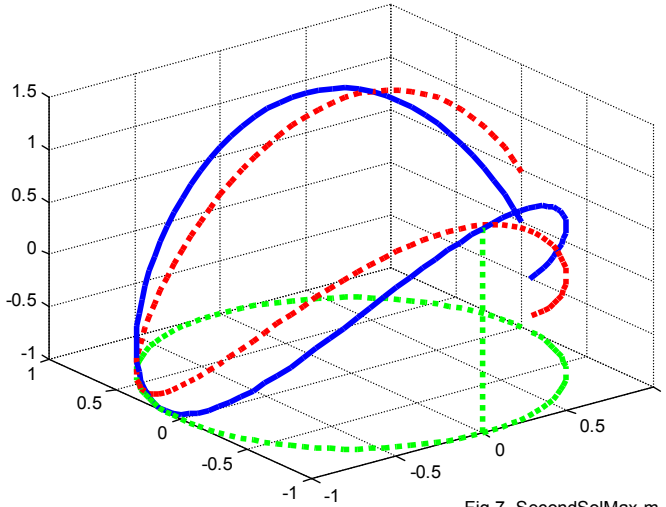

It follows that

- flux density is unevenly distributed over the flow cross section – there is a picture of the distribution of flow density by the cross section of the wave
- this picture is rotated while moving on the axis OZ ;
- the flow of energy (15), passing through the cross-sectional area, not depend on t , φ , z ; the main thing is that the value does not change with time, and this complies with the Law of energy conservation.

5. Impulse and momentum

It is known that the flow of energy is associated with other characteristics of the wave dependency of the following form [21, 25, 63] (in the SI system):

$$|f| = W. \quad (1)$$

$$S = W \cdot c, \quad (2)$$

$$p = W/c, \quad p = S/c^2, \quad (3)$$

$$f = p \cdot c, \quad f = S/c, \quad (4)$$

$$m = p \cdot r, \quad (5)$$

where

W - energy density (scalar), $\text{kg m}^{-1} \cdot \text{s}^{-2}$,

S - energy flux density (vector), $\text{kg} \cdot \text{s}^{-3}$,

p - pulse density (vector), $\text{kg} \cdot \text{m}^{-2} \cdot \text{s}^{-1}$,

f - pulse flux density (vector), $\text{kg} \cdot \text{m}^{-1} \cdot \text{s}^{-2}$,

m - density momentum at this point about an axis spaced from the given point by a distance r (vector), $\text{kg} \cdot \text{s}^{-2}$,

V - объем электромагнитного поля (scalar), m^3 .

It follows from the above that in the electromagnetic wave there exist energy flows, which directed along a radius, along a circle, along a axis. Consequently, in the electromagnetic wave there exist pulses, which directed along a radius, along a circle, along a axis. Also there exist momentum, which directed along a radius, along a circle, along a axis.

Let's consider the angular momentum about the axis z . According to (3) we can find this momentum as follows:

$$L_z = p_z r = S_z r / c. \quad (6)$$

This is orbital angular momentum, which can be detected in so called twisted light. Further on, we bring you a reduced quotation from [64]. *The fact that the light wave carries not only energy and momentum, but also angular momentum was known a century ago. At first, of course, angular momentum was associated only with polarization of light. ... But time went by. Lasers were created, scientists had learnt to control the light emitted by lasers, and a theory describing its electromagnetic field was developing. And at a certain time it was realized that these two properties — direction of the light beam and its twisted characteristic — do not contradict to each other. ... Certain methods of generation and detection of the twisted light were proposed. Three years after ... practical researchers confirmed that a specially prepared mode of the laser beam, which have also been known before, is actually occurred to be the twisted light. ... After that, like an avalanche, researches rushed to investigate the phenomenon of the twisted light. ... Along with fundamental researching, various practical applications of the twisted light started to be developed...*"

However, it should be noted that existence of the twisted light does not follow from the existing solution of Maxwell's equations. But it naturally follows from the proposed solution — see (6). In Fig. 7a (taken from [64]) *"the picture with the twisted light doesn't show the electric field, but the*

wavefront (the middle picture shows non-twisted light, and the upper and lower ones — the light twisted to one or another side). *It is not flat; in this case the wave phase changes not only along the beam, but also with shifting in cross-sectional plane... As the energy flow of the light wave is usually directed perpendicular to the wavefront, it occurs, that in the twisted light energy and momentum not only fly ahead, but also spin around the axis of movement.*" This particular fact was confirmed above — see Fig. 3.4a for comparison.

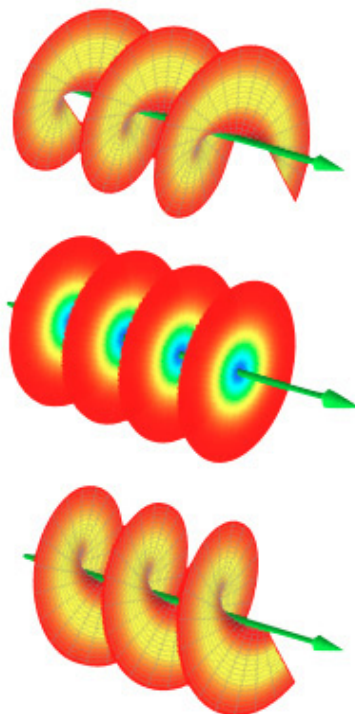

Fig. 7a.

6. Discussion

The Fig. 8 shows the intensities in Cartesian coordinates. The resulting solution describes a wave. The main distinctions from the known solution are as follows:

1. Instantaneous (and not average by certain period) energy flow **does not** change with time, which complies with the Law of energy conservation.
2. The energy flow has a positive value
3. The energy flow extends along the wave.
4. Magnetic and electrical intensities on one of the coordinate axes r , φ , z phase-shifted by a quarter of period.

5. The solution for magnetic and electrical intensities is a real value.
6. The solution exists at constant speed of wave propagation.
7. The existence region of the wave does not expand, as evidenced by the existence of laser.
8. The vectors of electrical and magnetic intensities are orthogonal.
9. There are two possible types of electromagnetic wave circular polarization.
10. The wave and its energy are determined if the parameters A , ω , R , α are specified. For given R , \bar{S} the parameter α can be found.
11. The path of the point, which moves along a cylinder of given radius in such a manner, that each intensity value varies harmonically with time, is a helix.

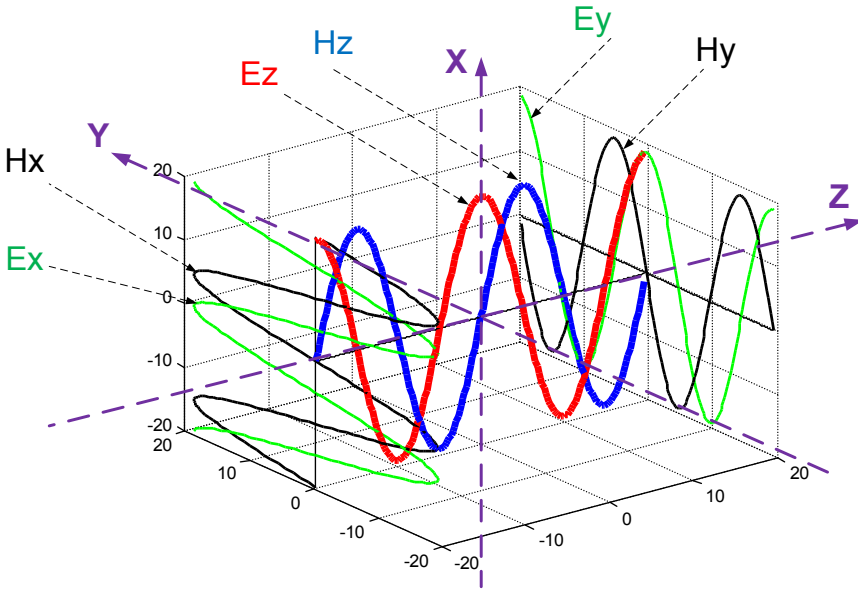

Fig. 8.

Appendix 1

Let us consider the solution of equations (2.1-2.10) in the form of (2.13-2.23). Further the derivatives of r will be designated by strokes. We write the equations (2.1-2.10) in view of (2.11, 2.12) in the form

$$\frac{e_r(r)}{r} + e'_r(r) - \frac{e_\phi(r)}{r} \alpha - \chi \cdot e_z(r) = 0, \quad (1)$$

$$-\frac{1}{r} \cdot e_z(r)\alpha + e_\varphi(r)\chi = m_r(r), \quad (2)$$

$$e_r(r)\chi - e'_z(r) = m_\varphi(r), \quad (3)$$

$$\frac{e_\varphi(r)}{r} + e'_\varphi(r) - \frac{e_r(r)}{r} \cdot \alpha = m_z(r), \quad (4)$$

$$\frac{h_r(r)}{r} + h'_r(r) + \frac{h_\varphi(r)}{r} \alpha + \chi \cdot h_z(r) = 0, \quad (5)$$

$$\frac{1}{r} \cdot h_z(r)\alpha - h_\varphi(r)\chi = j_r(r), \quad (6)$$

$$-h_r(r)\chi - h'_z(r) = j_\varphi(r), \quad (7)$$

$$\frac{h_\varphi(r)}{r} + h'_\varphi(r) + \frac{h_r(r)}{r} \cdot \alpha - j_z(r) = 0, \quad (8)$$

$$j_r = \frac{\omega}{c} e_r, \quad j_\varphi = -\frac{\omega}{c} e_\varphi, \quad j_z = -\frac{\omega}{c} e_z, \quad (9)$$

$$m_r = \frac{\omega}{c} h_r, \quad m_\varphi = -\frac{\omega}{c} h_\varphi, \quad m_z = -\frac{\omega}{c} h_z, \quad (10)$$

We consider travelling wave in vacuum. In this case $e_z(r) = 0$, as there is no external energy source.

Along with that, according to (9) we obtain $j_z(r) = 0$. Then, the initial system (1, 5-8) will be as follows:

$$\frac{e_r(r)}{r} + e'_r(r) - \frac{e_\varphi(r)}{r} \alpha = 0, \quad (17)$$

$$\frac{h_r(r)}{r} + h'_r(r) + \frac{h_\varphi(r)}{r} \alpha + \chi \cdot h_z(r) = 0, \quad (18)$$

$$\frac{1}{r} \cdot h_z(r)\alpha - h_\varphi(r)\chi = j_r(r), \quad (19)$$

$$-h_r(r)\chi - h'_z(r) = j_\varphi(r), \quad (20)$$

$$\frac{h_\varphi(r)}{r} + h'_\varphi(r) + \frac{h_r(r)}{r} \cdot \alpha = 0, \quad (21)$$

Substituting (9) in (17), we get:

$$\frac{j_r(r)}{r} + j'_r(r) + \frac{j_\varphi(r)}{r} \alpha = 0, \quad (22)$$

Substituting (19, 20) in (22), we get:

$$\frac{1}{r^2} \cdot h_z(r)\alpha - \frac{1}{r} \cdot h_\varphi(r)\chi + \frac{1}{r} \cdot h'_z(r)\alpha - h'_\varphi(r)\chi + (-h_r(r)\chi - h'_z(r))\frac{\alpha}{r} = 0$$

or

$$\frac{1}{r^2} \cdot h_z(r)\alpha - \frac{1}{r} \cdot h_\varphi(r)\chi - h'_\varphi(r)\chi - h_r(r) \frac{\chi\alpha}{r} = 0 \quad (23)$$

In this case, for calculation of three intensities we obtain three equations (19, 21, 23). Then, we exclude $h'_\varphi(r)$ from (21, 23):

$$\frac{1}{r^2} \cdot h_z(r)\alpha - \frac{1}{r} \cdot h_\varphi(r)\chi + \left(\frac{1}{r} \cdot h_\varphi(r) + h_r(r) \frac{\alpha}{r} \right) \chi - h_r(r) \frac{\chi\alpha}{r} = 0$$

or $\frac{-1}{r^2} \cdot h_z(r)\alpha = 0$ or $h_z(r) = 0$. Thus, in a $e_z(r) = 0$ condition $h_z(r) = 0$ to be respected. This implies

Lemma 1. The equation system (1, 5-9) for $e_z(r) \neq 0$ is compatible only if $h_z(r) = 0$.

If $e_z(r) = 0$ and $h_z(r) = 0$, then equations (1, 5-9) will be as follows – equations (1, 5, 8) can be simplified, and equations (6, 7) taking (9) into account, can be substituted for the following equations (1.3, 1.4):

$$\frac{e_r(r)}{r} + e'_r(r) - \frac{e_\varphi(r)}{r} \alpha = 0, \quad (1.1)$$

$$\frac{h_r(r)}{r} + h'_r(r) + \frac{h_\varphi(r)}{r} \alpha = 0, \quad (1.2)$$

$$\frac{c\chi}{\omega} h_\varphi(r) = e_r(r), \quad (1.3)$$

$$-\frac{c\chi}{\omega} h_r(r) = e_\varphi(r), \quad (1.4)$$

$$\frac{h_\varphi(r)}{r} + h'_\varphi(r) + \frac{h_r(r)}{r} \cdot \alpha = 0. \quad (1.5)$$

In a similar way we can prove

Lemma 2. If $e_z(r) = 0$, system of equations (1-5, 10) has a solution only in that case, when $h_z(r) = 0$.

In this case, similar to equations (24, 28), we can obtain equations

$$\frac{e_r(r)}{r} + e'_r(r) - \frac{e_\varphi(r)}{r} \alpha = 0, \quad (2.1)$$

$$e_\varphi(r)\chi = -\frac{\omega}{c} h_r(r), \quad (2.2)$$

$$e_r(r)\chi = \frac{\omega}{c} h_\varphi(r), \quad (2.3)$$

$$\frac{e_\varphi(r)}{r} + e'_\varphi(r) - \frac{e_r(r)}{r} \cdot \alpha = 0, \quad (2.4)$$

$$\frac{h_r(r)}{r} + h'_r(r) + \frac{h_\varphi(r)}{r} \alpha = 0. \quad (2.5)$$

From Lemmas 1 and 2 follows

Lemma 3. System of equations (1-10) has a solution only if

$$h_z(r) = 0, \quad e_z(r) = 0. \quad (3.1)$$

Therefore, initial system of equations (1-10) can be written in the form of equations shown in lemmas 1 and 2. We combined them for readers' convenience.

$$\frac{e_r(r)}{r} + e'_r(r) - \frac{e_\varphi(r)}{r} \alpha = 0, \quad (24)$$

$$e_\varphi(r) \chi = -\frac{\omega}{c} h_r(r), \quad (25)$$

$$e_r(r) \chi = \frac{\omega}{c} h_\varphi(r), \quad (26)$$

$$\frac{e_\varphi(r)}{r} + e'_\varphi(r) - \frac{e_r(r)}{r} \alpha = 0, \quad (27)$$

$$\frac{h_r(r)}{r} + h'_r(r) + \frac{h_\varphi(r)}{r} \alpha = 0, \quad (28)$$

$$h_\varphi(r) \chi = \frac{\omega}{c} e_r(r), \quad (29)$$

$$-h_r(r) \chi = \frac{\omega}{c} e_\varphi(r), \quad (30)$$

$$\frac{h_\varphi(r)}{r} + h'_\varphi(r) + \frac{h_r(r)}{r} \alpha = 0. \quad (31)$$

We multiply equations (26, 29). Then we get:

$$-e_r(r) h_\varphi(r) \chi^2 = -\left(\frac{\omega}{c}\right)^2 e_r(r) h_\varphi(r)$$

or

$$\chi = \omega/c. \quad (32)$$

Substituting (32) in (26, 29), we get:

$$h_\varphi(r) = e_r(r). \quad (33)$$

Thus, with condition (32) equation (26, 29) are equivalent to a single equation (33). A similar equation follows from (25, 30):

$$h_r(r) = -e_\varphi(r), \quad (34)$$

Thus, system (24-31) is equivalent to system (24, 27, 28, 31-34).

Below we find a solution for equations (24, 27).

First we shall consider the equation

$$\frac{ay}{x} + y' = 0, \quad (\text{a})$$

The solutions of this equations is as:

$$y = x^{-a} \text{ or } y = 0. \quad (\text{b})$$

$$(e_r + e_\varphi)' + \frac{(e_r + e_\varphi)}{r}(1 - \alpha) = 0, \quad (35)$$

We subtract the equation (27) from (24):

$$(e_r - e_\varphi)' + \frac{(e_r - e_\varphi)}{r}(1 + \alpha) = 0, \quad (36)$$

In accordance with (a, b) from (35) we find:

$$(e_r + e_\varphi) = Ar^{-(1-\alpha)} \text{ ИЛИ } (e_r + e_\varphi) = 0. \quad (37)$$

In accordance with (a, b) from (36) we find:

$$(e_r - e_\varphi) = Cr^{-(1+\alpha)} \text{ ИЛИ } (e_r - e_\varphi) = 0. \quad (38)$$

Adding or subtracting the equation (38) from (37) we find the 4 solutions:

$$e_r = e_\varphi = \frac{A}{2}r^{-(1-\alpha)}, \quad (39)$$

$$e_r = -e_\varphi = \frac{C}{2}r^{-(1+\alpha)}, \quad (40)$$

$$\begin{cases} e_r(r) = \frac{1}{2}(Ar^{-(1-\alpha)} + Cr^{-(1+\alpha)}) \\ e_\varphi(r) = \frac{1}{2}(Ar^{-(1-\alpha)} - Cr^{-(1+\alpha)}) \end{cases} \quad (41)$$

$$e_r = e_\varphi = 0. \quad (42)$$

Hereinafter we will consider solution (39). Thus, initial system of equations (1-10) has a solution in the following form:

$$h_z(r) = 0, \quad e_z(r) = 0, \quad (3.1)$$

$$\chi = \omega/c, \quad (32)$$

$$e_r = e_\varphi = \frac{A}{2}r^{-(1-\alpha)}, \quad (39)$$

$$h_\varphi(r) = e_r(r), \quad (33)$$

$$h_r(r) = -e_\varphi(r). \quad (34)$$

Appendix 2

In (3.11) it is shown that the energy flow passing through the wave cross-section, is

$$\bar{S} = \eta \iint_{r,\varphi} [(e_r^2 + e_\varphi^2) si \cdot co] dr \cdot d\varphi. \quad (1)$$

Let the speed of wave propagation is constant and equal to C . Then,

$$z = ct. \quad (2)$$

Then from (2, 2.11, 2.12, 2.30), we obtain:

$$co = \cos(\alpha\varphi + \chi z + \omega t) = \cos(\alpha\varphi + (2\omega/c)z) \quad (3)$$

and similarly,

$$si = \sin(\alpha\varphi + (2\omega/c)z). \quad (4)$$

Due to (3, 4), we can rewrite (1) as:

$$\bar{S} = \frac{1}{2} \eta \iint_{r,\varphi} [(e_r^2 + e_\varphi^2) \sin(2(\alpha\varphi + (2\omega/c)z))] dr d\varphi. \quad (5)$$

Thus, the energy flux density on the circle defined by function of the form

$$\bar{S}_{rz} = (e_r^2 + e_\varphi^2) \sin(2\alpha\varphi + 4\omega z/c). \quad (5a)$$

When $z=0$ on the axis OZ have:

$$\bar{S} = \frac{1}{2} \eta \iint_{r,\varphi} [(e_r^2 + e_\varphi^2) \sin(2\alpha\varphi)] dr d\varphi. \quad (6)$$

Further, from (6) we find:

$$\bar{S} = \frac{\eta}{2} \int_r \left((e_r^2 + e_\varphi^2) \left(\int_\varphi \sin(2\alpha\varphi) d\varphi \right) dr \right). \quad (7)$$

We have:

$$\int_\varphi \sin(2\alpha\varphi) d\varphi = \int_0^{2\pi} \sin(2\alpha\varphi) d\varphi = \frac{1}{2\alpha} (1 - \cos(4\pi\alpha)). \quad (8)$$

From (7, 8), we obtain:

$$\bar{S} = \frac{\eta}{4\alpha} (1 - \cos(4\alpha\pi)) \int_r ((e_r^2 + e_\varphi^2) dr). \quad (9)$$

Substituting here (3.2), we finally obtain:

$$\bar{S} = \frac{c}{16\alpha\pi} (1 - \cos(4\alpha\pi)) \int_r ((e_r^2 + e_\varphi^2) dr). \quad (10)$$

Obviously, for any choice of the point $z = 0$ on the axis OZ last relation is maintained.

Chapter 2. Solution of Maxwell's Equations for Electromagnetic Wave in the Dielectric Circuit of Alternating Current

Contents

1. Introduction
 2. Solution of Maxwell's Equations
 3. Intensities and Energy Flows
 4. Discussion
- Appendix 1
Appendix 2
Appendix 3

1. Introduction

An electromagnetic field in vacuum is considered in chapter 1. The evident solution obtained there is extended to a non-conducting dielectric medium with certain dielectric and magnetic permeability ϵ and μ , respectively. Therefore, the electromagnetic field does also exist in a capacitor as well. However, a considerable difference of the capacitor is that its field has a non-zero electrical intensity along on of the coordinates induced by an external source. The electromagnetic field in vacuum was examined on the basis of an assumption that an external source was absent.

The same can be said about an alternating current dielectric circuit. The system of Maxwell equations is applied to such a circuit. It is shown that an electromagnetic wave is also formed in this circuit. An important difference between this wave and the wave in vacuum is that the former has a longitudinal electrical intensity induced by an external power source.

Below are considered the Maxwell equations of the following form written in the GHS system (as in chapter 1, but with ϵ and μ which are not equal to 1):

$$\text{rot}(E) + \frac{\mu}{c} \frac{\partial H}{\partial t} = 0, \quad (1)$$

$$\text{rot}(H) - \frac{\epsilon}{c} \frac{\partial E}{\partial t} = 0, \quad (2)$$

$$\operatorname{div}(E)=0, \quad (3)$$

$$\operatorname{div}(H)=0, \quad (4)$$

where H , E are the magnetic intensity and the electrical intensity, respectively.

2. Maxwell Equations Solution

Let us consider solution to the Maxwell equations (1.1-1.4) [37]. In the cylindrical coordinate system r , φ , z , these equations take the form:

$$\frac{E_r}{r} + \frac{\partial E_r}{\partial r} + \frac{1}{r} \cdot \frac{\partial E_\varphi}{\partial \varphi} + \frac{\partial E_z}{\partial z} = 0, \quad (1)$$

$$\frac{1}{r} \cdot \frac{\partial E_z}{\partial \varphi} - \frac{\partial E_\varphi}{\partial z} = v \frac{dH_r}{dt}, \quad (2)$$

$$\frac{\partial E_r}{\partial z} - \frac{\partial E_z}{\partial r} = v \frac{dH_\varphi}{dt}, \quad (3)$$

$$\frac{E_\varphi}{r} + \frac{\partial E_\varphi}{\partial r} - \frac{1}{r} \cdot \frac{\partial E_r}{\partial \varphi} = v \frac{dH_z}{dt}, \quad (4)$$

$$\frac{H_r}{r} + \frac{\partial H_r}{\partial r} + \frac{1}{r} \cdot \frac{\partial H_\varphi}{\partial \varphi} + \frac{\partial H_z}{\partial z} = 0, \quad (5)$$

$$\frac{1}{r} \cdot \frac{\partial H_z}{\partial \varphi} - \frac{\partial H_\varphi}{\partial z} = q \frac{dE_r}{dt} \quad (6)$$

$$\frac{\partial H_r}{\partial z} - \frac{\partial H_z}{\partial r} = q \frac{dE_\varphi}{dt}, \quad (7)$$

$$\frac{H_\varphi}{r} + \frac{\partial H_\varphi}{\partial r} - \frac{1}{r} \cdot \frac{\partial H_r}{\partial \varphi} = q \frac{dE_z}{dt} \quad (8)$$

where

$$v = -\mu/c, \quad (9)$$

$$q = \varepsilon/c, \quad (10)$$

E_r , E_φ , E_z are the electrical intensity components,

H_r , H_φ , H_z are the magnetic intensity components.

A solution should be found for non-zero intensity component E_z .

To write the equations in a concise form, the following designations are used below:

$$co = \cos(\alpha\varphi + \chi z + \omega t), \quad (11)$$

$$si = \sin(\alpha\varphi + \chi z + \omega t), \quad (12)$$

where α , χ , ω are constants. Let us write the unknown functions in the following form:

$$H_{r.} = h_r(r) \cos t, \quad (13)$$

$$H_{\varphi.} = h_{\varphi}(r) \sin t, \quad (14)$$

$$H_{z.} = h_z(r) \sin t, \quad (15)$$

$$E_{r.} = e_r(r) \sin t, \quad (16)$$

$$E_{\varphi.} = e_{\varphi}(r) \cos t, \quad (17)$$

$$E_{z.} = e_z(r) \cos t, \quad (18)$$

where $h(r)$, $e(r)$ are function of the coordinate r .

Direct substitution enables us to ascertain that functions (13-18) convert the system of equations (1-8) with four arguments r , φ , z , t in a system of equations with one argument r and unknown functions $h(r)$, $e(r)$.

Table 1.

	Chapter 1	Chapter 2
e_{φ}	$Ar^{\alpha-1}$	$A \cdot \text{kh}(\alpha, \chi, r)$
e_r	$Ar^{\alpha-1}$	$\frac{1}{\alpha} (e_{\varphi}(r) + r \cdot e'_{\varphi}(r))$
e_z	0	$A \cdot r \cdot e_{\varphi}(r) \frac{q}{\alpha}$
h_r	$-e_{\varphi}(r)$	$A \frac{\varepsilon\omega}{c\chi} e_{\varphi}(r)$
h_{φ}	$-h_r(r)$	$-A \frac{\varepsilon\omega}{c\chi} e_r(r)$
h_z	0	0

Appendix 1 proves that such a solution **does exist**. It takes the following form:

$$e_{\varphi}(r) = \text{kh}(\alpha, \chi, r), \quad (20)$$

$$e_r(r) = \frac{1}{\alpha} (e_{\varphi}(r) + r \cdot e'_{\varphi}(r)), \quad (21)$$

$$e_z(r) = r \cdot e_{\varphi}(r) \frac{q}{\alpha}, \quad (22)$$

$$h_{\varphi}(r) = -\frac{\varepsilon\omega}{c} e_r(r) \frac{1}{\chi}, \quad (23)$$

$$h_r(r) = \frac{\varepsilon\omega}{c} e_{\varphi}(r) \frac{1}{\chi}, \quad (24)$$

$$h_z(r) \equiv 0. \quad (25)$$

where $kh()$ – is the function determined in Appendix 2,

$$q = \left(\chi - \frac{\mu\varepsilon\omega^2}{c^2\chi} \right). \quad (26)$$

Let us compare this solution with the solution for vacuum, obtained in Chapter 1- see Table 1. A considerable difference between these solutions is evident.

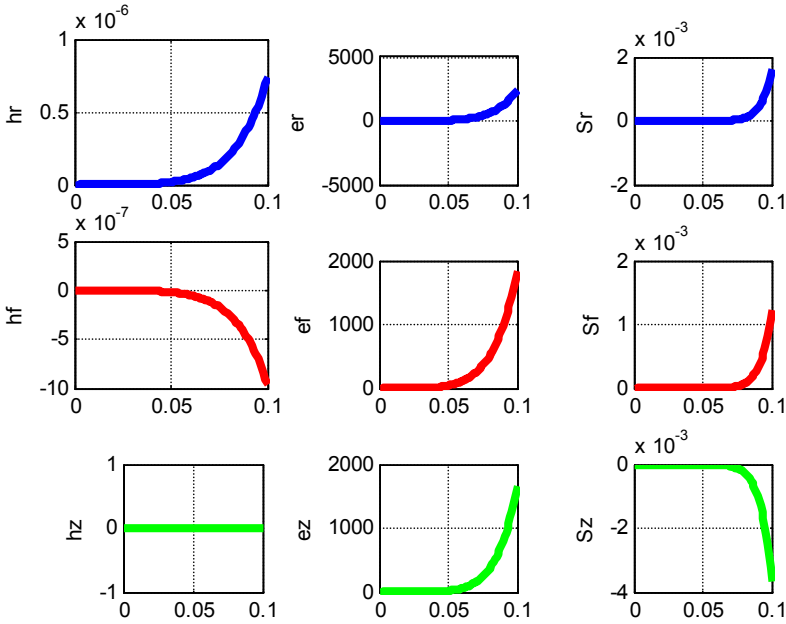

Fig.1. (SSB6(3).m)

3. Intensity and Energy Flows

Also, as in Chapter 1, the energy flow density along the coordinates is calculated by the formula

$$\bar{S} = \begin{bmatrix} \overline{S_r} \\ \overline{S_{\varphi}} \\ \overline{S_z} \end{bmatrix} = \eta \iint_{r,\varphi} \begin{bmatrix} s_r \cdot si^2 \\ s_{\varphi} \cdot si \cdot co \\ s_z \cdot si \cdot co \end{bmatrix} dr \cdot d\varphi. \quad (1)$$

where

$$\begin{aligned} s_r &= (e_\phi h_z - e_z h_\phi) \\ s_\phi &= (e_z h_r - e_r h_z), \end{aligned} \quad (2)$$

$$\begin{aligned} s_z &= (e_r h_\phi - e_\phi h_r) \\ \eta &= c/4\pi. \end{aligned} \quad (3)$$

Let us consider functions (2) and $e_r(r)$, $e_\phi(r)$, $e_z(r)$, $h_r(r)$, $h_\phi(r)$, $h_z(r)$. Fig. 1 shows, for example, these functions plotted for $A=1$, $\alpha=5.5$, $\mu=1$, $\varepsilon=2$, $\chi=50$, $\omega=300$.

4. Discussion

Further conclusions are similar to those of chapter 1. Thus, an electromagnetic wave propagates via a dielectric circuit and, in particular, through a capacitor connected to an AC circuit, and the mathematical description of this wave is the solution of the Maxwell equations. In this case, the field intensity, the displacement current, and the energy Flow propagate in the dielectric along a helical path.

Appendix 1.

A solution to equations (2.1-2.8) is considered to be in the form of functions (2.13-2.18). Derivatives with respect to r will be denoted with primes. Let us re-write equations (2.1-2.8) considering (2.11, 2.12) in the form

$$\frac{e_r(r)}{r} + e'_r(r) - \frac{e_\phi(r)}{r} \alpha - \chi \cdot e_z(r) = 0, \quad (1)$$

$$-\frac{1}{r} \cdot e_z(r) \alpha + e_\phi(r) \chi - \frac{\mu\omega}{c} h_r = 0, \quad (2)$$

$$e_r(r) \chi - e'_z(r) + \frac{\mu\omega}{c} h_\phi = 0, \quad (3)$$

$$\frac{e_\phi(r)}{r} + e'_\phi(r) - \frac{e_r(r)}{r} \cdot \alpha + \frac{\mu\omega}{c} h_z = 0, \quad (4)$$

$$\frac{h_r(r)}{r} + h'_r(r) + \frac{h_\phi(r)}{r} \alpha + \chi \cdot h_z(r) = 0, \quad (5)$$

$$\frac{1}{r} \cdot h_z(r) \alpha - h_\phi(r) \chi - \frac{\varepsilon\omega}{c} e_r = 0, \quad (6)$$

$$-h_r(r) \chi - h'_z(r) + \frac{\varepsilon\omega}{c} e_\phi = 0, \quad (7)$$

$$\frac{h_\varphi(r)}{r} + h'_\varphi(r) + \frac{h_r(r)}{r} \cdot \alpha + \frac{\varepsilon\omega}{c} e_z(r) = 0. \quad (8)$$

The correspondence between the formula numbers in Part 2 and in this Appendix is as follows:

Part 2	2.1	2.2	2.3	2.4	2.5	2.6	2.7	2.8
App. 1	1	5	6	7	8	6	7	8

Formulae (1 – 8) will be transformed below. In doing so, the formula numbering will be retained after transformation (to make easier to follow the sequence of transformations), and only new formulae will take the next number.

Assume that

$$h_z(r) = 0. \quad (9)$$

From (6, 7) it follows that:

$$h_\varphi(r) = -\frac{\varepsilon\omega}{c} e_r(r) \frac{1}{\chi} \quad (6)$$

$$h_r(r) = \frac{\varepsilon\omega}{c} e_\varphi(r) \frac{1}{\chi} \quad (7)$$

Let us compare (1, 8):

$$\frac{e_r(r)}{r} + e'_r(r) - \frac{e_\varphi(r)}{r} \alpha - \chi \cdot e_z(r) = 0, \quad (1)$$

$$\frac{h_\varphi(r)}{r} + h'_\varphi(r) + \frac{h_r(r)}{r} \cdot \alpha + \frac{\varepsilon\omega}{c} e_z(r) = 0. \quad (8)$$

From (6, 7) it follows that (1, 8) are identical. Then (8) can be deleted. Then compare (4) with (5):

$$\frac{e_\varphi(r)}{r} + e'_\varphi(r) - \frac{e_r(r)}{r} \cdot \alpha = 0, \quad (4)$$

$$\frac{h_r(r)}{r} + h'_r(r) + \frac{h_\varphi(r)}{r} \alpha = 0. \quad (5)$$

From (6, 7) it follows (4, 5) are identical. Hence, equation (5) can be deleted. The remaining equations are as follows:

$$\frac{e_r(r)}{r} + e'_r(r) - \frac{e_\varphi(r)}{r} \alpha - \chi \cdot e_z(r) = 0, \quad (1)$$

$$-\frac{1}{r} \cdot e_z(r) \alpha + e_\varphi(r) \chi - \frac{\mu\omega}{c} h_r = 0, \quad (2)$$

$$e_r(r) \chi - e'_z(r) + \frac{\mu\omega}{c} h_\varphi = 0, \quad (3)$$

$$\frac{e_\varphi(r)}{r} + e'_\varphi(r) - \frac{e_r(r)}{r} \cdot \alpha = 0, \quad (4)$$

$$h_\varphi(r) = -\frac{\varepsilon\omega}{c} e_r(r) \frac{1}{\chi}, \quad (6)$$

$$h_r(r) = \frac{\varepsilon\omega}{c} e_\varphi(r) \frac{1}{\chi}. \quad (7)$$

Substitute (6, 7) in (2, 3):

$$-\frac{1}{r} \cdot e_z(r)\alpha + e_\varphi(r)\chi - \frac{\mu\omega}{c} \frac{\varepsilon\omega}{c} e_\varphi(r) \frac{1}{\chi} = 0, \quad (2)$$

$$e_r(r)\chi - e'_z(r) - \frac{\mu\omega}{c} \frac{\varepsilon\omega}{c} e_r(r) \frac{1}{\chi} = 0, \quad (3)$$

or

$$\frac{\alpha}{r} \cdot e_z(r) = e_\varphi(r) \left(\chi - \frac{\mu\omega}{c} \frac{\varepsilon\omega}{c} \frac{1}{\chi} \right) \quad (2)$$

$$e'_z(r) = e_r(r) \left(\chi - \frac{\mu\omega}{c} \frac{\varepsilon\omega}{c} \frac{1}{\chi} \right) \quad (3)$$

The remaining equations are as follows:

$$\frac{e_r(r)}{r} + e'_r(r) - \frac{e_\varphi(r)}{r} \alpha - \chi \cdot e_z(r) = 0, \quad (1)$$

$$\frac{\alpha}{r} \cdot e_z(r) = e_\varphi(r) \left(\chi - \frac{\mu\omega}{c} \frac{\varepsilon\omega}{c} \frac{1}{\chi} \right) \quad (2)$$

$$e'_z(r) = e_r(r) \left(\chi - \frac{\mu\omega}{c} \frac{\varepsilon\omega}{c} \frac{1}{\chi} \right) \quad (3)$$

$$\frac{e_\varphi(r)}{r} + e'_\varphi(r) - \frac{e_r(r)}{r} \cdot \alpha = 0, \quad (4)$$

$$h_\varphi(r) = -\frac{\varepsilon\omega}{c} e_r(r) \frac{1}{\chi}, \quad (6)$$

$$h_r(r) = \frac{\varepsilon\omega}{c} e_\varphi(r) \frac{1}{\chi}. \quad (7)$$

Let us denote:

$$q = \left(\chi - \frac{\mu\omega}{c} \frac{\varepsilon\omega}{c} \frac{1}{\chi} \right) \quad (11)$$

From (1, 2, 11) it can be found that:

$$\frac{e_r(r)}{r} + e'_r(r) - \frac{e_\varphi(r)}{r} \alpha - \chi r \cdot e_\varphi(r) q / \alpha = 0, \quad (12)$$

From (4) it can be found that:

$$e_r(r) = \frac{1}{\alpha} (e_\varphi(r) + r \cdot e'_\varphi(r)) \quad (13)$$

$$e'_r(r) = \frac{1}{\alpha} (2e'_\varphi(r) + r \cdot e''_\varphi(r)) \quad (14)$$

From (12-14) it can be found that:

$$\frac{1}{\alpha} \left(\frac{e_\varphi(r)}{r} + e'_\varphi(r) \right) + \frac{1}{\alpha} (2e'_\varphi(r) + r \cdot e''_\varphi(r)) - \frac{e_\varphi(r)}{r} \alpha - \frac{q\chi}{\alpha} r \cdot e_\varphi(r) = 0 \quad (15)$$

For the solution and analysis of this equation, see Appendix 2. This solution cannot be presented as an analytical expression. Let us call this solution as a function

$$e_\varphi(r) = \text{kh}(\alpha, \chi, r), \quad (16)$$

and its derivative as a function

$$e'_\varphi(r) = \text{kh1}(\alpha, \chi, r). \quad (17)$$

With the known functions (16, 17), the remaining functions can also be found. Thus, all the functions can be determined from the following equations:

$$h_z(r) \equiv 0, \quad (9)$$

$$e_\varphi(r) = \text{kh}(\alpha, \chi, r), \quad (16)$$

$$e'_\varphi(r) = \text{kh1}(\alpha, \chi, r), \quad (17)$$

$$e_r(r) = \frac{1}{\alpha} (e_\varphi(r) + r \cdot e'_\varphi(r)), \quad (13)$$

$$e'_r(r) = \frac{1}{\alpha} (2e'_\varphi(r) + r \cdot e''_\varphi(r)), \quad (14)$$

$$e_z(r) = r \cdot e_\varphi(r) \frac{q}{\alpha}, \quad (2)$$

$$e'_z(r) = e_r(r) q, \quad (3)$$

$$h_\varphi(r) = -\frac{\varepsilon\omega}{c} e_r(r) \frac{1}{\chi}, \quad (6)$$

$$h_r(r) = \frac{\varepsilon\omega}{c} e_\varphi(r) \frac{1}{\chi}. \quad (7)$$

For the accuracy of the obtained solution, see Appendix 3.

Appendix 2.

Let us consider equation (15) from Appendix 1:

$$\frac{1}{\alpha} \left(\frac{e_{\varphi}(r)}{r} + e'_{\varphi}(r) \right) + \frac{1}{\alpha} \left(2e'_{\varphi}(r) + r \cdot e''_{\varphi}(r) \right) - \frac{e_{\varphi}(r)}{r} \alpha - \frac{q\chi}{\alpha} r \cdot e_{\varphi}(r) = 0. \quad (1)$$

Its simplification gives:

$$\left(\frac{e_{\varphi}(r)}{r} + e'_{\varphi}(r) \right) + \left(2e'_{\varphi}(r) + r \cdot e''_{\varphi}(r) \right) - \frac{e_{\varphi}(r)}{r} \alpha^2 - q\chi r \cdot e_{\varphi}(r) = 0$$

$$e_{\varphi}(r) \left(\frac{-\alpha^2 + 1}{r} - q\chi r \right) + 3e'_{\varphi}(r) + r \cdot e''_{\varphi}(r) = 0,$$

$$e''_{\varphi}(r) = e_{\varphi}(r) \left(\frac{\alpha^2 - 1}{r^2} + q\chi \right) - \frac{3}{r} e'_{\varphi}(r). \quad (2)$$

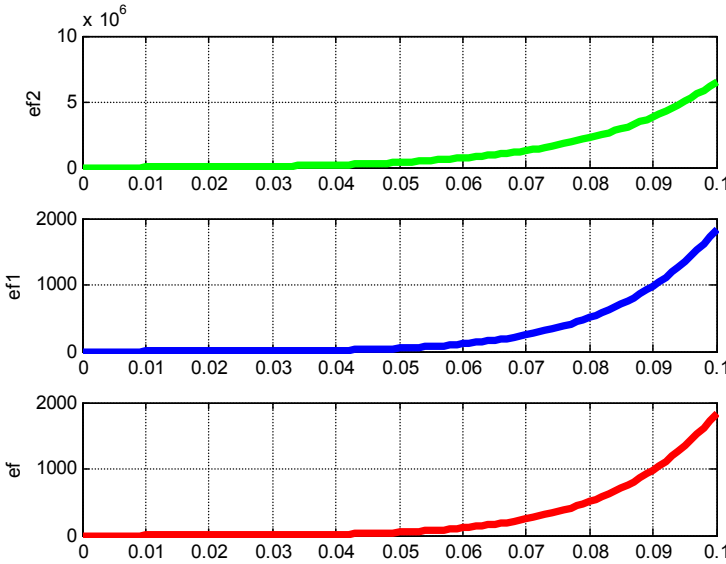

Fig.2. (SSMB6.13)

Equation (2) has not an analytical solution. But the following functions can be calculated numerically

$$e_{\varphi}(r) = kh(\alpha, \chi, r) \quad (3)$$

$$e'_{\varphi}(r) = kh1(\alpha, \chi, r) \quad (4)$$

$$e''_{\varphi}(r) = kh2(\alpha, \chi, r) \quad (5)$$

For an example, Fig. 2 shows these functions for $(\alpha = 5.5, \chi = 50)$ at a radius of $R = 0.1$.

Appendix 3.

Substitution of the functions found in Appendix 1 in equations (1-8) enables us to determine a RMS residual error of these equations. Fig. 3 shows this residual error for $(\alpha = 5.5, \chi = 50)$ at a radius of $R = 0.1$.

A RMS residual error of these equations can be found as a function of one or other variable. Fig. 4 shows the residual error as a function of α for $\chi = 50$ at a radius of $R = 0.1$. Here, the upper window presents the residual error value, and lower window the residual error logarithm.

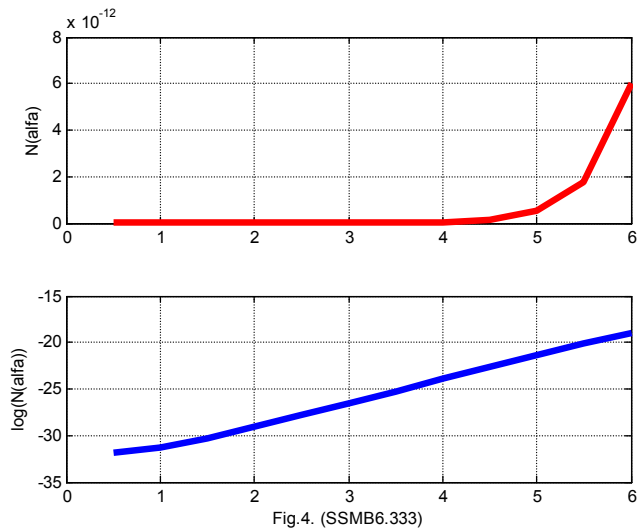
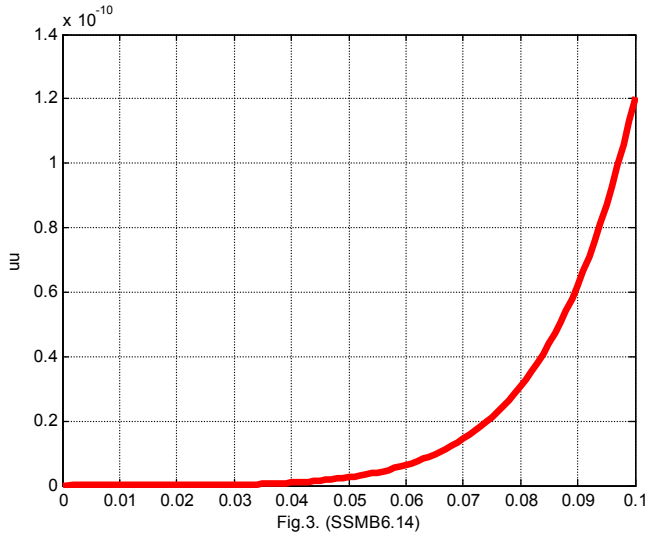

Chapter 3. Solution of Maxwell's Equations for Electromagnetic Wave in the Magnetic Circuit of Alternating Current

Contents

1. Introduction
 2. Solution of Maxwell's Equations
 3. Intensities and Energy Flows
 5. Discussion
- Appendix 1

1. Introduction

Chapter 2 deals with the electromagnetic field in an AC dielectric circuit. The electromagnetic field in an AC magnetic circuit can be examined using the same approach. The simplest example of such a circuit is an AC solenoid. However, if the dielectric circuit has a longitudinal electrical field intensity component induced by an external power source, the magnetic circuit features a longitudinal magnetic field component induced by an external power source and transmitted to circuit with the solenoid coil.

In this case, the Maxwell equations outlined in chapter 2, are also used - see (2.1.1-2.1.4).

2. Maxwell Equations Solution

Let us consider solution to the Maxwell equations (2.1.1-2.1.4) [37]. In the cylindrical coordinate system r, φ, z , these equations take the form:

$$\frac{E_r}{r} + \frac{\partial E_r}{\partial r} + \frac{1}{r} \cdot \frac{\partial E_\varphi}{\partial \varphi} + \frac{\partial E_z}{\partial z} = 0, \quad (1)$$

$$\frac{1}{r} \cdot \frac{\partial E_z}{\partial \varphi} - \frac{\partial E_\varphi}{\partial z} = v \frac{dH_r}{dt}, \quad (2)$$

$$\frac{\partial E_r}{\partial z} - \frac{\partial E_z}{\partial r} = v \frac{dH_\varphi}{dt}, \quad (3)$$

$$\frac{E_\varphi}{r} + \frac{\partial E_\varphi}{\partial r} - \frac{1}{r} \cdot \frac{\partial E_r}{\partial \varphi} = v \frac{dH_z}{dt}, \quad (4)$$

$$\frac{H_r}{r} + \frac{\partial H_r}{\partial r} + \frac{1}{r} \cdot \frac{\partial H_\varphi}{\partial \varphi} + \frac{\partial H_z}{\partial z} = 0, \quad (5)$$

$$\frac{1}{r} \cdot \frac{\partial H_z}{\partial \varphi} - \frac{\partial H_\varphi}{\partial z} = q \frac{dE_r}{dt} \quad (6)$$

$$\frac{\partial H_r}{\partial z} - \frac{\partial H_z}{\partial r} = q \frac{dE_\varphi}{dt}, \quad (7)$$

$$\frac{H_\varphi}{r} + \frac{\partial H_\varphi}{\partial r} - \frac{1}{r} \cdot \frac{\partial H_r}{\partial \varphi} = q \frac{dE_z}{dt} \quad (8)$$

where

$$v = -\mu/c, \quad (9)$$

$$q = \varepsilon/c, \quad (10)$$

E_r, E_φ, E_z are the electrical intensity components,

H_r, H_φ, H_z are the magnetic intensity components.

A solution should be found for non-zero intensity component H_z (in Chapter 2 this should be found at non-zero intensity E_z).

To write the equations in a concise form, the following designations are used below:

$$co = \cos(\alpha\varphi + \chi z + \omega t), \quad (11)$$

$$si = \sin(\alpha\varphi + \chi z + \omega t), \quad (12)$$

where α, χ, ω are constants. Let us write the unknown functions in the following form:

$$H_r = h_r(r)co, \quad (13)$$

$$H_\varphi = h_\varphi(r)si, \quad (14)$$

$$H_z = h_z(r)si, \quad (15)$$

$$E_r = e_r(r)si, \quad (16)$$

$$E_\varphi = e_\varphi(r)co, \quad (17)$$

$$E_z = e_z(r)co, \quad (18)$$

where $h(r), e(r)$ are function of the coordinate r .

Direct substitution enables us to ascertain that functions (13-18) convert the system of equations (1-8) with four arguments r, φ, z, t in

a system of equations with one argument r and unknown functions $h(r)$, $e(r)$.

Table 1.

	Chapter 1	Chapter 2	Chapter 3
e_r	$Ar^{\alpha-1}$	$A \cdot \text{kh}(\alpha, \chi, r)$	$-\frac{\mu\omega}{\chi c} h_\varphi(r)$
e_φ	$Ar^{\alpha-1}$	$\frac{1}{\alpha} (e_\varphi(r) + r \cdot e'_\varphi(r))$	$\frac{\mu\omega}{\chi c} h_r(r)$
e_z	$\mathbf{0}$	$A \cdot r \cdot e_\varphi(r) \frac{q}{\alpha}$	$\mathbf{0}$
h_r	$-e_\varphi(r)$	$A \frac{\varepsilon\omega}{c\chi} e_\varphi(r)$	$-\frac{1}{\alpha} (h_\varphi(r) + r \cdot h'_\varphi(r))$
h_φ	$-h_r(r)$	$-A \frac{\varepsilon\omega}{c\chi} e_r(r)$	$\text{kh}(\alpha, \chi, r)$
h_z	$\mathbf{0}$	$\mathbf{0}$	$r \cdot h_\varphi(r) q / \alpha$

Appendix 1 proves that such a solution **does exist**. It takes the following form:

$$e_z(r) \equiv 0, \quad (20)$$

$$h_\varphi(r) = \text{kh}(\alpha, \chi, r), \quad (21)$$

$$h_r(r) = -\frac{1}{\alpha} (h_\varphi(r) + r \cdot h'_\varphi(r)), \quad (22)$$

$$h_z(r) = r \cdot h_\varphi(r) q / \alpha, \quad (23)$$

$$e_\varphi(r) = \frac{\mu\omega}{\chi c} h_r(r), \quad (24)$$

$$e_r(r) = -\frac{\mu\omega}{\chi c} h_\varphi(r), \quad (25)$$

where $\text{kh}()$ – is the function determined in Appendix 2 of Chapter 2,

$$q = \left(\chi - \frac{\mu\varepsilon\omega^2}{c^2\chi} \right). \quad (26)$$

Let us compare this solution with the solutions, obtained in chapters 1 and 2 - see Table 1. Similarity of these equations is illustrated in Chapters 2 and 3.

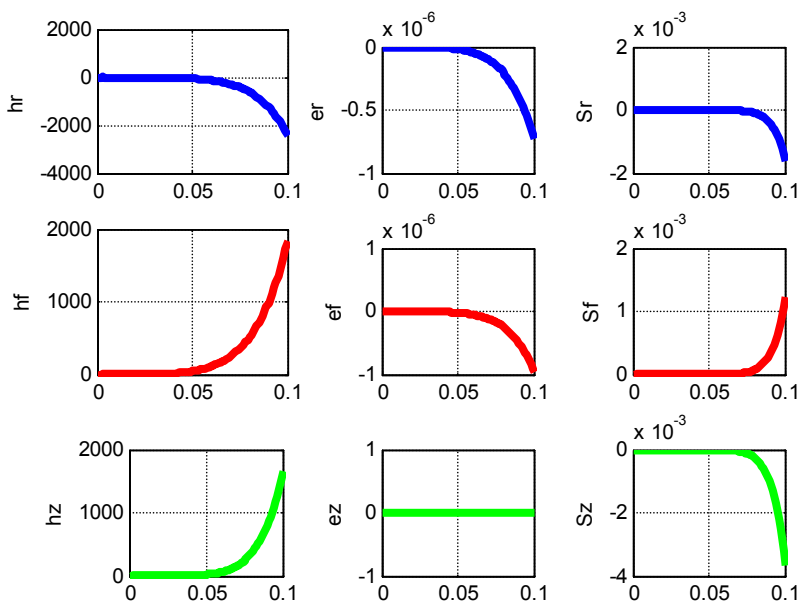

Fig.1. (SSB6.703)

3. Intensity and Energy Flows

Also, as in Chapter 1, the energy flow density along the coordinates is calculated by the formula

$$\bar{S} = \begin{bmatrix} \overline{S_r} \\ \overline{S_\varphi} \\ \overline{S_z} \end{bmatrix} = \eta \iint_{r,\varphi} \begin{bmatrix} s_r \cdot si^2 \\ s_\varphi \cdot si \cdot co \\ s_z \cdot si \cdot co \end{bmatrix} dr \cdot d\varphi. \quad (1)$$

ГAE

$$s_r = (e_\varphi h_z - e_z h_\varphi)$$

$$s_\varphi = (e_z h_r - e_r h_z), \quad (2)$$

$$s_z = (e_r h_\varphi - e_\varphi h_r)$$

$$\eta = c/4\pi. \quad (3)$$

Let us consider functions (2) and $e_r(r)$, $e_\varphi(r)$, $e_z(r)$, $h_r(r)$, $h_\varphi(r)$, $h_z(r)$. Fig. 1 shows, for example, these functions plotted for $A=1$, $\alpha=5.5$, $\mu=1$, $\varepsilon=2$, $\chi=50$, $\omega=300$. These parameters are chosen the same as in Chapter 2 - for comparison of the obtained results.

4. Discussion

Further conclusions are similar to the conclusions of chapter 1 and 2. Thus, an electromagnetic wave propagates in an AC magnetic circuit, and the mathematical description of this wave is a solution to the Maxwell equations. In this case, the field intensity and the energy Flow follow a helical trajectory in the considered circuit.

Appendix 1.

A solution to equations (2.1-2.8) is considered to be in the form of functions (2.13-2.18). Derivatives with respect to r will be denoted with primes. Let us re-write equations (2.1-2.8) considering (2.11, 2.12) in the form

$$\frac{e_r(r)}{r} + e'_r(r) - \frac{e_\varphi(r)}{r} \alpha - \chi \cdot e_z(r) = 0, \quad (1)$$

$$-\frac{1}{r} \cdot e_z(r) \alpha + e_\varphi(r) \chi - \frac{\mu\omega}{c} h_r = 0, \quad (2)$$

$$e_r(r) \chi - e'_z(r) + \frac{\mu\omega}{c} h_\varphi = 0, \quad (3)$$

$$\frac{e_\varphi(r)}{r} + e'_\varphi(r) - \frac{e_r(r)}{r} \cdot \alpha + \frac{\mu\omega}{c} h_z = 0, \quad (4)$$

$$\frac{h_r(r)}{r} + h'_r(r) + \frac{h_\varphi(r)}{r} \alpha + \chi \cdot h_z(r) = 0, \quad (5)$$

$$\frac{1}{r} \cdot h_z(r) \alpha - h_\varphi(r) \chi - \frac{\varepsilon\omega}{c} e_r = 0, \quad (6)$$

$$-h_r(r) \chi - h'_z(r) + \frac{\varepsilon\omega}{c} e_\varphi = 0, \quad (7)$$

$$\frac{h_\varphi(r)}{r} + h'_\varphi(r) + \frac{h_r(r)}{r} \cdot \alpha + \frac{\varepsilon\omega}{c} e_z(r) = 0, \quad (8)$$

The correspondence between the formula numbers in Part 2 and in this Appendix is as follows:

Part 2	2.1	2.2	2.3	2.4	2.5	2.6	2.7	2.8
App. 1	1	5	6	7	8	6	7	8

Formulae (1 – 8) will be transformed below. In doing so, the formula numbering will be retained after transformation (to make easier to follow the sequence of transformations), and only new formulae will take the next number.

Assume that

$$e_z(r) = 0. \quad (9)$$

From (2, 3) it follows that:

$$e_{\varphi}(r)\chi = \frac{\mu\omega}{c}h_r(r) \quad (2)$$

$$e_r(r)\chi = -\frac{\mu\omega}{c}h_{\varphi}(r) \quad (3)$$

Let us compare (4, 5):

$$\frac{e_{\varphi}(r)}{r} + e'_{\varphi}(r) - \frac{e_r(r)}{r} \cdot \alpha + \frac{\mu\omega}{c}h_z = 0, \quad (4)$$

$$\frac{h_r(r)}{r} + h'_r(r) + \frac{h_{\varphi}(r)}{r} \alpha + \chi \cdot h_z(r) = 0, \quad (5)$$

From (2, 3) it follows that (4, 5) are identical. Then (4) can be deleted. Then compare (1) with (8):

$$\frac{e_r(r)}{r} + e'_r(r) - \frac{e_{\varphi}(r)}{r} \alpha = 0, \quad (1)$$

$$\frac{h_{\varphi}(r)}{r} + h'_{\varphi}(r) + \frac{h_r(r)}{r} \cdot \alpha = 0, \quad (8)$$

From (2, 3) it follows (1, 8) are identical. Hence, equation (1) can be deleted. The remaining equations are as follows:

$$e_{\varphi}(r) = \frac{\mu\omega}{\chi c}h_r(r), \quad (2)$$

$$e_r(r) = -\frac{\mu\omega}{\chi c}h_{\varphi}(r), \quad (3)$$

$$\frac{h_r(r)}{r} + h'_r(r) + \frac{h_{\varphi}(r)}{r} \alpha + \chi \cdot h_z(r) = 0, \quad (5)$$

$$\frac{1}{r} \cdot h_z(r)\alpha - h_{\varphi}(r)\chi - \frac{\varepsilon\omega}{c}e_r = 0, \quad (6)$$

$$-h_r(r)\chi - h'_z(r) + \frac{\varepsilon\omega}{c}e_{\varphi} = 0, \quad (7)$$

$$\frac{h_{\varphi}(r)}{r} + h'_{\varphi}(r) + \frac{h_r(r)}{r} \cdot \alpha + \frac{\varepsilon\omega}{c}e_z(r) = 0, \quad (8)$$

Substitute (2, 3) in (6, 7):

$$\frac{1}{r} \cdot h_z(r)\alpha - h_{\varphi}(r)\chi + \frac{\varepsilon\omega}{c} \frac{\mu\omega}{\chi c}h_{\varphi}(r) = 0 \quad (6)$$

$$-h_r(r)\chi - h'_z(r) + \frac{\varepsilon\omega}{c} \frac{\mu\omega}{\chi c}h_r(r) = 0, \quad (7)$$

or

$$\frac{\alpha}{r} \cdot h_z(r) = h_\phi(r) \left(\chi - \frac{\mu\omega}{c} \frac{\varepsilon\omega}{c} \frac{1}{\chi} \right) \quad (6)$$

$$h'_z(r) = -h_r(r) \left(\chi - \frac{\mu\omega}{c} \frac{\varepsilon\omega}{c} \frac{1}{\chi} \right) \quad (7)$$

The remaining equations are as follows:

$$e_\phi(r) = \frac{\mu\omega}{\chi c} h_r(r), \quad (2)$$

$$e_r(r) = -\frac{\mu\omega}{\chi c} h_\phi(r), \quad (3)$$

$$\frac{h_r(r)}{r} + h'_r(r) + \frac{h_\phi(r)}{r} \alpha + \chi \cdot h_z(r) = 0, \quad (5)$$

$$\frac{\alpha}{r} \cdot h_z(r) = h_\phi(r) \left(\chi - \frac{\mu\omega}{c} \frac{\varepsilon\omega}{c} \frac{1}{\chi} \right) \quad (6)$$

$$h'_z(r) = -h_r(r) \left(\chi - \frac{\mu\omega}{c} \frac{\varepsilon\omega}{c} \frac{1}{\chi} \right) \quad (7)$$

$$\frac{h_\phi(r)}{r} + h'_\phi(r) + \frac{h_r(r)}{r} \cdot \alpha = 0, \quad (8)$$

Let us denote:

$$q = \left(\chi - \frac{\mu\omega}{c} \frac{\varepsilon\omega}{c} \frac{1}{\chi} \right) \quad (11)$$

From (5, 6, 11) it can be found that:

$$\frac{h_r(r)}{r} + h'_r(r) + \frac{h_\phi(r)}{r} \alpha + \chi r \cdot h_\phi(r) q / \alpha = 0, \quad (12)$$

From (8) it can be found that:

$$h_r(r) = -\frac{1}{\alpha} (h_\phi(r) + r \cdot h'_\phi(r)) \quad (13)$$

$$h'_r(r) = -\frac{1}{\alpha} (2h'_\phi(r) + r \cdot h''_\phi(r)) \quad (14)$$

From (12-14) it can be found that:

$$-\frac{1}{\alpha} \left(\frac{h_\phi(r)}{r} + h'_\phi(r) \right) - \frac{1}{\alpha} (2h'_\phi(r) + r \cdot h''_\phi(r)) + \frac{h_\phi(r)}{r} \alpha + \chi r \cdot h_\phi(r) q / \alpha = 0, \quad (15)$$

$$\frac{1}{\alpha} \left(\frac{e_\phi(r)}{r} + e'_\phi(r) \right) + \frac{1}{\alpha} (2e'_\phi(r) + r \cdot e''_\phi(r)) - \frac{e_\phi(r)}{r} \alpha - \frac{q\chi}{\alpha} r \cdot e_\phi(r) = 0 \quad (15)$$

It can be observed that this equation is the same as equation (15) in Appendix 1 of Chapter 2, if variable $h_\varphi(r)$ is substituted for variable $e_\varphi(r)$. Therefore, the solution of the equation is a function of

$$h_\varphi(r) = kh(\alpha, \chi, r), \quad (16)$$

and its derivative as a function

$$h'_\varphi(r) = kh1(\alpha, \chi, r). \quad (17)$$

With the known functions (16, 17), the remaining functions can also be found. Thus, all the functions can be determined from the following equations:

$$e_z(r) \equiv 0, \quad (9)$$

$$h_\varphi(r) = kh(\alpha, \chi, r), \quad (16)$$

$$h'_\varphi(r) = kh1(\alpha, \chi, r), \quad (17)$$

$$h_r(r) = -\frac{1}{\alpha} (h_\varphi(r) + r \cdot h'_\varphi(r)), \quad (13)$$

$$h'_r(r) = -\frac{1}{\alpha} (2h'_\varphi(r) + r \cdot h''_\varphi(r)), \quad (14)$$

$$h_z(r) = r \cdot h_\varphi(r)q / \alpha, \quad (6)$$

$$h'_z(r) = -h_r(r)q, \quad (7)$$

$$e_\varphi(r) = \frac{\mu\omega}{\chi c} h_r(r), \quad (2)$$

$$e_r(r) = -\frac{\mu\omega}{\chi c} h_\varphi(r). \quad (3)$$

Chapter 4. The solution of Maxwell's equations for the low-resistance Wire with Alternating Current

Contents

1. Introduction
 2. Solution of Maxwell's Equations
 3. Intensities and currents in the wire
 4. Energy Flows
 5. Current and energy flow in the wire
 6. Discussion
- Appendix 1

1. Introduction

The Maxwell equations in general in GHS system have the following form (see option 1 in the "Preface"):

$$\operatorname{rot}(E) + \frac{\mu}{c} \frac{\partial H}{\partial t} = 0, \quad (1)$$

$$\operatorname{rot}(H) - \frac{\varepsilon}{c} \frac{\partial E}{\partial t} - \frac{4\pi}{c} J = 0, \quad (2)$$

$$\operatorname{div}(E) = 0, \quad (3)$$

$$\operatorname{div}(H) = 0, \quad (4)$$

$$J = \frac{1}{\rho} E, \quad (5)$$

where

J , H , E - conduction current, magnetic and electric intensity accordingly,

ε , μ , ρ - dielectric permittivity, permeability, specific resistance of the wire's material

Further these equations are used for analyzing the structure of Alternating Current in a wire [15]. For sinusoidal current in a wire with specific inductance L and specific resistance ρ intensity and current are related in the following way:

$$J = \frac{1}{\rho + i\omega L} E = \frac{\rho - i\omega L}{\rho^2 + (\omega L)^2} E.$$

Hence for $\rho \ll \omega L$ we find:

$$J \approx \frac{-i}{\omega L} E.$$

Therefore for analyzing the structure of sinusoidal current in the wire for a sufficiently high frequency the condition (5) can be neglected. При этом is necessary to solve the equation system (1-4), where the known value is the current J_z flowing among the wire, i.e. the projection of vector J on axis oz (see option 4 in the "Preface"):

2. Solution of Maxwell's equations

Let us consider the solution of Maxwell equations system (1.1-1.4) for the wire. In cylindrical coordinates system r, φ, z these equations look as follows [4]:

$$\frac{E_r}{r} + \frac{\partial E_r}{\partial r} + \frac{1}{r} \cdot \frac{\partial E_\varphi}{\partial \varphi} + \frac{\partial E_z}{\partial z} = 0, \quad (1)$$

$$\frac{1}{r} \cdot \frac{\partial E_z}{\partial \varphi} - \frac{\partial E_\varphi}{\partial z} = v \frac{dH_r}{dt}, \quad (2)$$

$$\frac{\partial E_r}{\partial z} - \frac{\partial E_z}{\partial r} = v \frac{dH_\varphi}{dt}, \quad (3)$$

$$\frac{E_\varphi}{r} + \frac{\partial E_\varphi}{\partial r} - \frac{1}{r} \cdot \frac{\partial E_r}{\partial \varphi} = v \frac{dH_z}{dt}, \quad (4)$$

$$\frac{H_r}{r} + \frac{\partial H_r}{\partial r} + \frac{1}{r} \cdot \frac{\partial H_\varphi}{\partial \varphi} + \frac{\partial H_z}{\partial z} = 0, \quad (5)$$

$$\frac{1}{r} \cdot \frac{\partial H_z}{\partial \varphi} - \frac{\partial H_\varphi}{\partial z} = q \frac{dE_r}{dt} \quad (6)$$

$$\frac{\partial H_r}{\partial z} - \frac{\partial H_z}{\partial r} = q \frac{dE_\varphi}{dt}, \quad (7)$$

$$\frac{H_\varphi}{r} + \frac{\partial H_\varphi}{\partial r} - \frac{1}{r} \cdot \frac{\partial H_r}{\partial \varphi} = q \frac{dE_z}{dt} + \frac{4\pi}{c} J_z. \quad (8)$$

where

$$v = -\mu/c, \quad (9)$$

$$q = \varepsilon/c, \quad (10)$$

Further we shall consider only monochromatic solution. For the sake of brevity further we shall use the following notations:

$$co = \cos(\alpha\varphi + \chi z + \omega t), \quad (11)$$

$$si = \sin(\alpha\varphi + \chi z + \omega t), \quad (12)$$

where α , χ , ω – are certain constants. Let us present the unknown functions in the following form:

$$H_{r.} = h_r(r)co, \quad (13)$$

$$H_{\varphi.} = h_{\varphi}(r)si, \quad (14)$$

$$H_{z.} = h_z(r)si, \quad (15)$$

$$E_{r.} = e_r(r)si, \quad (16)$$

$$E_{\varphi.} = e_{\varphi}(r)co, \quad (17)$$

$$E_{z.} = e_z(r)co, \quad (18)$$

$$J_{r.} = j_r(r)co, \quad (19)$$

$$J_{\varphi.} = j_{\varphi}(r)si, \quad (20)$$

$$J_{z.} = j_z(r)si, \quad (21)$$

where $h(r)$, $e(r)$, $j(r)$ - certain function of the coordinate r .

By direct substitution we can verify that the functions (13-21) transform the equations system (1-8) with four arguments r , φ , z , t into equations system with one argument r and unknown functions $h(r)$, $e(r)$, $j(r)$.

Further it will be assumed that there exists only the current (21), directed along the axis Z . This current is created by an external source. It is shown that the presence of this current is the cause for the existence of electromagnetic wave in the wire.

In Appendix 1 it is shown that for system (1.1-1.4) at the conditions (13-21) there **exists** a solution of the following form:

$$e_{\varphi}(r) = Ar^{\alpha-1}, \quad (22)$$

$$e_r(r) = e_{\varphi}(r), \quad (23)$$

$$e_z(r) = \hat{\chi} \frac{(M-1)}{\sqrt{M}} \frac{\omega\sqrt{\varepsilon\mu}}{\alpha} r e_{\varphi}(r), \quad (24)$$

$$h_r(r) = \hat{\chi} \sqrt{\frac{\varepsilon}{M\mu}} e_{\varphi}(r), \quad (25)$$

$$h_{\varphi}(r) = -h_r(r), \quad (26)$$

$$h_z(r) = 0, \quad (27)$$

$$j_z(r) = \frac{\varepsilon\omega}{4\pi} e_z(r) = \frac{\chi\varepsilon\omega}{2\pi\alpha} Ar^{\alpha}, \quad (28)$$

where A, c, α, ω – constants.

Let us compare this solution to the solution obtained in chapter 1 for vacuum – see Table 1. Evidently (despite the identity of equations) these solutions differ greatly. These differences are caused by the presence of external electromotive force with $e_z(r) \neq 0$. It causes a longitudinal displacement current which changes drastically the structure of electromagnetic wave.

Table 1.

	Vacuum	Wire
χ	$\hat{\chi} \frac{\omega}{c} \sqrt{\varepsilon\mu}$	$\hat{\chi} \frac{\omega}{c} \sqrt{M\varepsilon\mu}, \hat{\chi} = \pm 1$
j_z	0	$\frac{\varepsilon\omega}{4\pi} e_z(r)$
e_r	$Ar^{\alpha-1}$	$Ar^{\alpha-1}$
e_φ		
e_z	0	$\hat{\chi} \frac{(M-1)}{\sqrt{M}} \frac{\omega\sqrt{\varepsilon\mu}}{\alpha c} r e_\varphi(r)$
h_r	$-e_\varphi(r)$	$\hat{\chi} \sqrt{\frac{\varepsilon}{M\mu}} e_\varphi(r)$
h_φ	$-h_r(r)$	$-h_r(r)$
h_z	0	0

3. Intensities and currents in the wire

Further we shall consider only the functions $j_z(r)$, $e_r(r)$, $e_\varphi(r)$, $e_z(r)$, $h_r(r)$, $h_\varphi(r)$, $h_z(r)$. Fig. 1 shows, for example, the graphs of these functions for $A=1$, $\alpha=3$, $\mu=1$, $\varepsilon=1$, $\omega=300$. The value $j_z(r)$ is shown in units of (A/mm²) - in contrast to all the other values shown in system SI. The increase of function $j_z(r)$ at the radius increase explains the skin-effect.

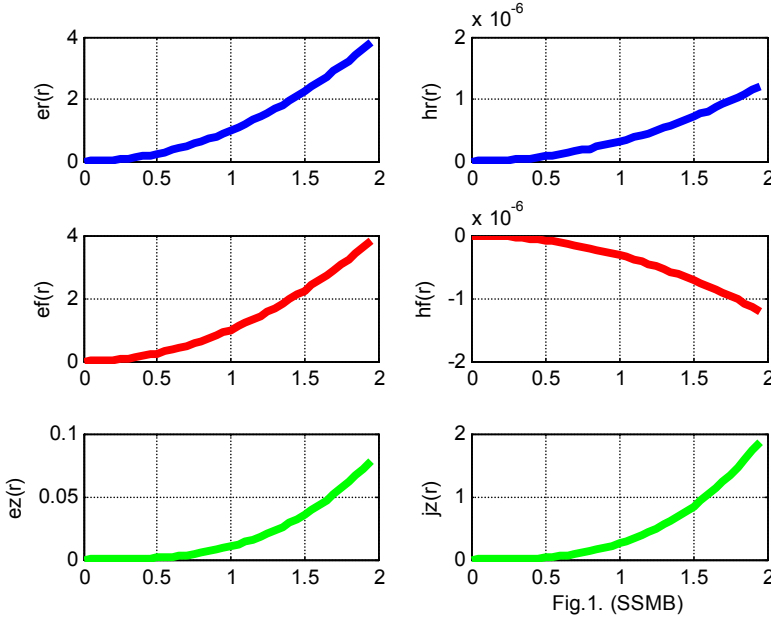

Fig.1. (SSMB)

The energy density of electromagnetic wave is determines as the sum of modules of vectors E , H from (2.13, 2.14, 2.16, 2.17, 2.23, 2.24) and is equal to

$$W = E^2 + H^2 = (e_r(r)si)^2 + (e_\varphi(r)si)^2 + (h_r(r)co)^2 + (h_\varphi(r)co)^2$$

or

$$W = (e_r(r))^2 + (e_\varphi(r))^2 \tag{1}$$

- see also Fig. 1. Thus, the density of electromagnetic wave energy is constant in all points of a circle of this radius.

In order to demonstrate phase shift between the wave components let's consider the functions (2.11-2.19). It can be seen, that at each point with coordinates r, φ, z intensities H, E are shifted in phase by a quarter-period.

Let us find the average value of current amplitude density in a wire of radius R :

$$\overline{J_z} = \frac{1}{\pi R^2} \iint_{r,\varphi} [J_z] dr \cdot d\varphi. \tag{5}$$

Taking into account (2.21), we find:

$$\overline{J_z} = \frac{1}{\pi R^2} \iint_{r,\varphi} [j_z(r)si] dr \cdot d\varphi \tag{5a}$$

Next, we find:

$$\overline{J}_z = \frac{1}{\pi R^2} \int_0^R j_z(r) \left(\int_0^{2\pi} (si \cdot d\varphi) \right) dr.$$

Taking into account (2), we find:

$$\overline{J}_z = \frac{1}{\alpha \pi R^2} \int_0^R j_z(r) \left(\cos(2\alpha\pi + \frac{2\omega}{c} z) - \cos(\frac{2\omega}{c} z) \right) dr$$

or

$$\overline{J}_z = \frac{1}{\alpha \pi R^2} (\cos(2\alpha\pi) - 1) \cdot J_{zr}, \quad (6)$$

where

$$J_{zr} = \int_0^R j_z(r) dr. \quad (7)$$

Taking into account (2.28), we find:

$$J_{zr} = \frac{A\chi\varepsilon\omega}{2\pi\alpha} \int_0^R (r^\alpha) dr \quad (9)$$

or

$$J_{zr} = \frac{A\chi\varepsilon\omega}{2\pi\alpha(\alpha+1)} R^{\alpha+1}. \quad (10)$$

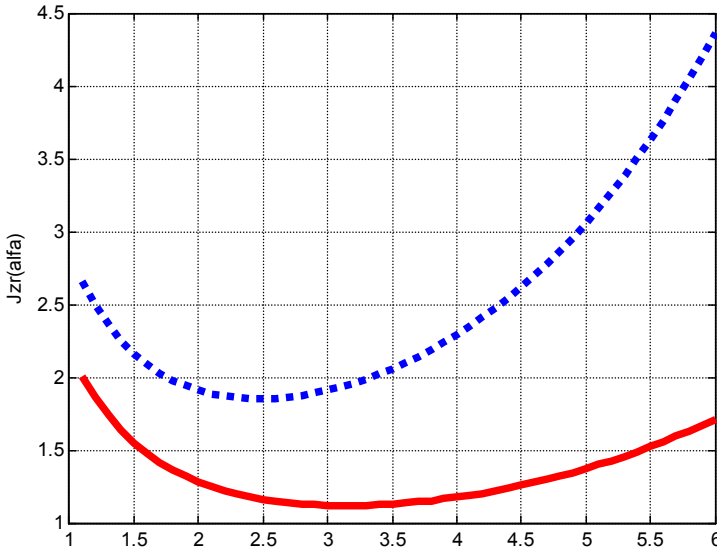

Fig.3. (SSMB)

Fig. 3 shows the function $\overline{J}_z(\alpha)$ (6, 10) for $A=1$. On this Figure the dotted and solid lines are related accordingly to $R=2$ and $R=1.75$.

Chapter 4. The solution for the low-resistance Wire with Alternating Current

From (6, 8) and Fig. 3 it follows that for a certain distribution of the value $j_z(r)$ the average value of the amplitude of current density $\overline{J_z}$ depends significantly of α .

The current is determined as

$$J = \frac{\varepsilon}{c} \frac{\partial E}{\partial t}, \tag{11}$$

or, taking into account (2.13-2.21):

$$\begin{aligned} J_r &= \frac{\varepsilon\omega}{c} e_r(r) \cos \varphi, \\ J_\varphi &= \frac{\varepsilon\omega}{c} e_\varphi(r) \sin \varphi, \\ J_z &= \left(\frac{\varepsilon\omega}{c} e_z(r) + j_z \right) \sin \varphi. \end{aligned} \tag{12}$$

You can talk about the lines of these currents. Thus, for instance, the current J_z flows along the straight lines parallel to the wire axis. We shall look now on the line of summary current.

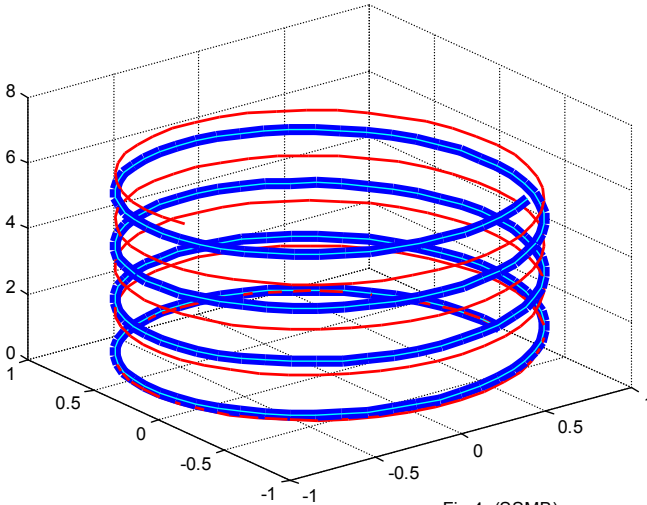

Fig.4. (SSMB)

It can be assumed that the speed of displacement current propagation does not depend on the current direction. In particular, for a fixed radius the path traversed by the current along a circle, and the path traversed by it along a vertical, would be equal. Consequently, for a fixed radius we can assume that

$$z = \gamma \cdot \varphi \tag{13}$$

where γ is a constant. Based on this assumption we can convert the functions (4b) into

$$co = \cos(\alpha\varphi + 2\chi\gamma\varphi), \quad si = \sin(\alpha\varphi + 2\chi\gamma\varphi) \quad (14)$$

and build an appropriate trajectory for the current. Fig. 4 shows two spiral lines of summary current described by the functions of the form

$$co = \cos((\alpha + 2)\varphi), \quad si = \sin((\alpha + 2)\varphi).$$

On Fig. 4 the thick line is built for $\alpha = 1.8$ and a thin line for $\alpha = 2.5$.

From (2.19-2.21, 14) follows that the currents will keep their values for given r, φ (independently of z) if only the following value is constant

$$\beta = (\alpha + 2\chi\gamma). \quad (15)$$

Further, based on (14, 15) we shall be using the formula

$$co = \cos(\beta\varphi), \quad si = \sin(\beta\varphi). \quad (16)$$

4. Energy Flows

Electromagnetic flux density - Poynting vector in this case is determined in the same way as in Chapter 1, Section 4. Although here we repeat the first 6 equations from that Section for readers' convenience. So,

$$S = \eta E \times H, \quad (1)$$

where

$$\eta = c/4\pi. \quad (2)$$

In cylindrical coordinates r, φ, z the density flow of electromagnetic energy has three components S_r, S_φ, S_z , directed along вдоль the axis accordingly. They are determined by the formula

$$S = \begin{bmatrix} S_r \\ S_\varphi \\ S_z \end{bmatrix} = \eta(E \times H) = \eta \begin{bmatrix} E_\varphi H_z - E_z H_\varphi \\ E_z H_r - E_r H_z \\ E_r H_\varphi - E_\varphi H_r \end{bmatrix}. \quad (4)$$

From (2.13-2.18) follows that the flow passing through a given section of the wave in a given moment, is:

$$\bar{S} = \begin{bmatrix} \bar{S}_r \\ \bar{S}_\varphi \\ \bar{S}_z \end{bmatrix} = \eta \iint_{r,\varphi} \begin{bmatrix} s_r \cdot si^2 \\ s_\varphi \cdot si \cdot co \\ s_z \cdot si \cdot co \end{bmatrix} dr \cdot d\varphi. \quad (5)$$

where

$$\begin{aligned}
 s_r &= (e_\varphi h_z - e_z h_\varphi) \\
 s_\varphi &= (e_z h_r - e_r h_z). \\
 s_z &= (e_r h_\varphi - e_\varphi h_r)
 \end{aligned}
 \tag{6}$$

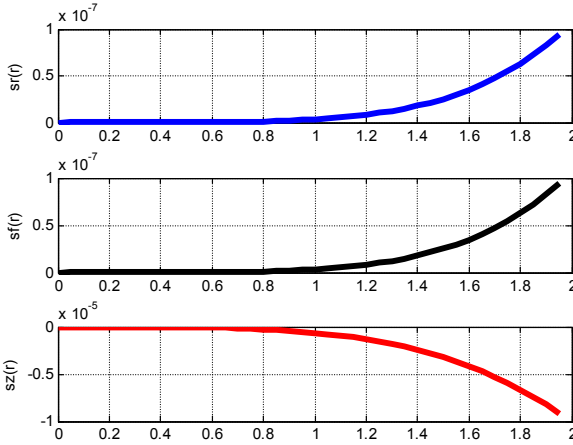

Fig.5. (SSMB)

It is values density of the energy flux at a predetermined radius which extends radially, circumferentially along, the axis OZ respectively. Fig. 5 shows the graphs of these functions depending on the radius at $A=1, \alpha=3, \mu=1, \varepsilon=1, \omega=300$.

The flow of energy along the axis OZ is

$$\overline{S}_z = \eta \iint_{r,\varphi} [s_z \cdot si \cdot co] dr \cdot d\varphi.
 \tag{7}$$

We shall find s_z . From (6, 2.22, 2.23, 2.26), we obtain:

$$s_z = -2e_\varphi h_r = -\hat{\chi} \sqrt{\frac{\varepsilon}{M\mu}} e_\varphi^2(r)
 \tag{9}$$

or

$$s_z = Q r^{2\alpha-2},
 \tag{10}$$

while

$$Q = A^2 \hat{\chi} \sqrt{\frac{\varepsilon}{M\mu}}
 \tag{11}$$

In Chapter 1, Appendix 2 shows that from (7) implies that

$$\overline{S} = \frac{c}{16\alpha\pi} (1 - \cos(4\alpha\pi)) \int_r (s_z(r) dr).
 \tag{12}$$

Let R be the radius of the circular front of the wave. Then from (12) we obtain, as in chapter 1,

$$S_{\text{int}} = \int_{r=0}^R (s_z(r) dr) = \frac{Q}{2\alpha - 1} R^{2\alpha - 1}, \quad (13)$$

$$S_{\text{alfa}} = \frac{1}{\alpha} (1 - \cos(4\alpha\pi)), \quad (14)$$

$$\bar{S} = \frac{c}{16\pi} S_{\text{alfa}} S_{\text{int}}. \quad (15)$$

Combining formulas (11-15), we get:

$$\bar{S}_z = \frac{c}{16\pi} \frac{1}{\alpha} (1 - \cos(4\alpha\pi)) A^2 \sqrt{\frac{\varepsilon}{M\mu}} \frac{\hat{\chi}}{2\alpha - 1} R^{2\alpha - 1}$$

or

$$\bar{S}_z = \frac{\hat{\chi} A^2 c (1 - \cos(4\alpha\pi))}{8\pi\alpha(2\alpha - 1)} \sqrt{\frac{\varepsilon}{M\mu}} R^{2\alpha - 1}. \quad (16)$$

This energy flow does not depend on the coordinates, and so it keeps its value along all the length of wire.

Fig. 7 shows the function $\bar{S}(\alpha)$ (16) for $A=1$, $M=10^{13}$, $\mu=1$, $\varepsilon=1$. On Fig. 7 the dotted and the solid lines refer respectively to $R=2$ and $R=1.8$.

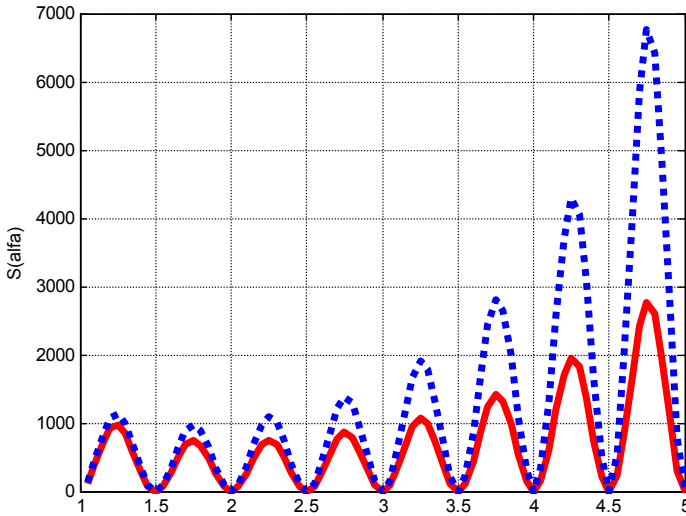

Fig.7. (SSMB)

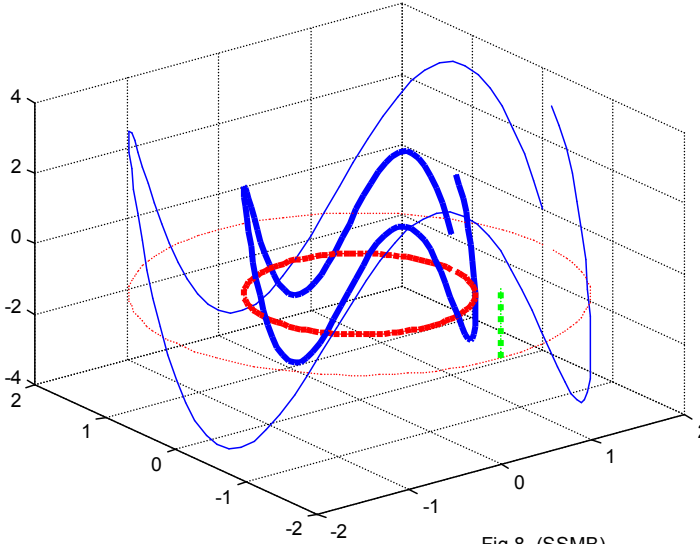

Fig.8. (SSMB)

Since the energy flow and the energy are related by the expression $S = W \cdot c$, then from (15) we can find the energy of a wavelength unit:

$$\overline{W} = \frac{A}{16\pi} S_{alfa} S_{int}. \quad (17)$$

It follows from (7, 3.16), the energy flux density on the circumference of the radius defined function of the form

$$\overline{S}_{rz} = s_z \sin(2\beta\varphi). \quad (18)$$

Fig. 8 shows this function (18) for $s_z = r^{2\alpha-2}$ - see (10). Shows two curves for two values at $\alpha = 1.4$ and at two values of radius $r = 1$ (thick line) and $r = 2$ (thin line).

Fig. 9 shows the function S (18) on the whole plane of wire section for $s_z = r^{2\alpha-2}$ and $\alpha = 1.4$. The upper window shows the part of function S graph for which $S > 0$ - called S_{plus} , and the lower window shows the part S graph for which $S < 0$ - called S_{minus} , and this part for clarity is shown with the opposite sign. This figure shows that

$$S = S_{plus} + S_{minus} > 0,$$

i.e. the summary vector of flow density is directed toward the increase of z - toward the load. However there are two components of this vector: the S_{plus} component, directed toward the load, and S_{minus} component, directed toward the source of current. These components of the flow transfer the active and reactive energies accordingly.

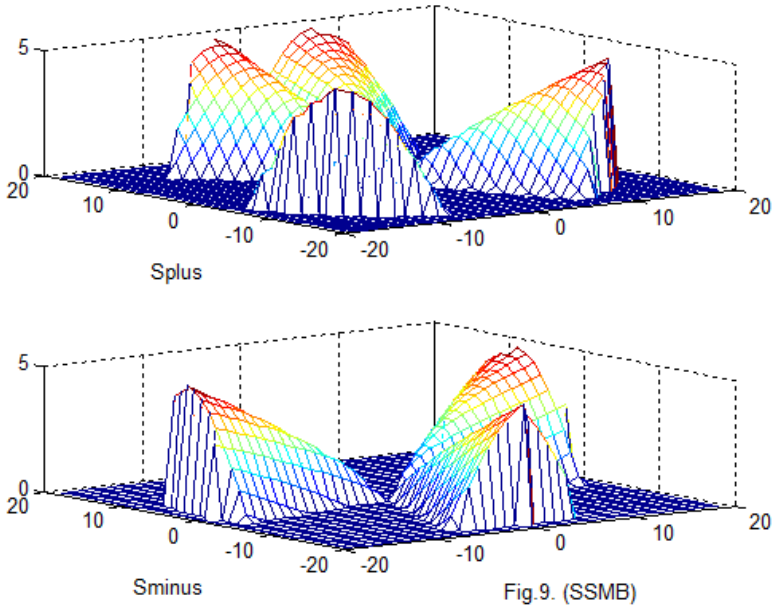

It follows that

- flux density is unevenly distributed over the flow cross section – there is a picture of the distribution of flow density by the cross section of the wave
- this picture is rotated while moving on the axis OZ ;
- the flow of energy (15), passing through the cross-sectional area, not depend on t, z ; the main thing is that the value does not change with time, and this complies with the Law of energy conservation.
- the energy flow has two opposite directed components, which transfer the active and reactive energies; thus, there is no need in the presentation of an imaginary Pointing vector.

5. Current and energy flow in the wire

One can say that the flow of mass particles (mass current) "*bears*" a flow of kinetic energy that is released in a collision with an obstacle. Just so the electric current "*bears*" a flow of electromagnetic energy released in the load. This assertion is discussed and substantiated in [4-9]. The difference between these two cases is in the fact that value of mass current fully determines the value of kinetic energy. But in the second case value of electrical current DOES NOT determine the value of

electromagnetic energy released in the load. Therefore the transferred quantity of electromagnetic energy – the energy flow, - is being determined by the current structure. Let us show this fact.

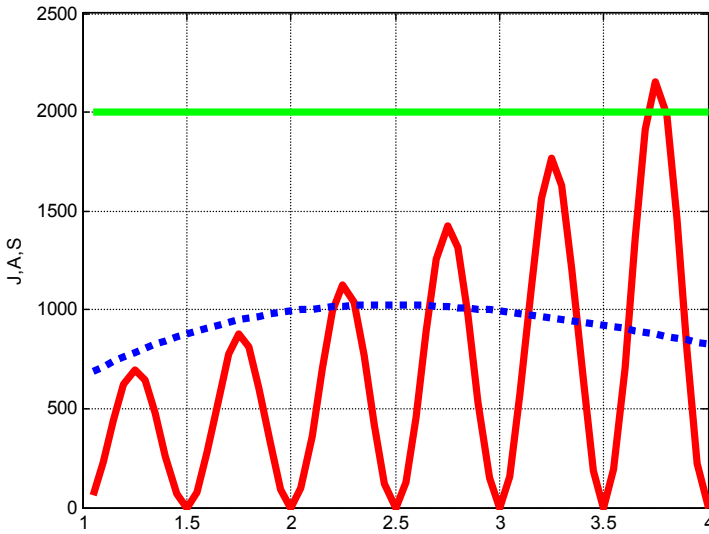

Fig.10. (SSMB)

As follows from (3.10), the average value of amplitude density of current $\overline{J_z}$ in a wire of radius R depends on two parameters: α and A . For a given density one can find the dependence between these parameters, as it follows from (3.10):

$$A = \frac{2\pi\alpha(\alpha + 1)}{\chi\epsilon\omega} R^{-\alpha-1} J_{zr}. \tag{1}$$

As follow from (4.16), the energy flow density along the wire also depends on two parameters: α and A . Fig. 10 shows the dependencies (1) and (4.16) for given $\overline{J_z} = 2$, $R = 2$. Here the straight line depicts the constant current density (in scale 1000), solid line – the flow density, dotted line – parameter A in scale (in scale 1000). Here A calculated according to (1), the energy flux density - to (4.16) for a given A . One can see that for the same current density the flow density can take absolutely different values.

From equations (4.7, 3.16) above we found energy flux density on a circumference of given radius as a function (see. (4.18)):

$$\overline{S_{rz}} = s_z \sin(2\beta\varphi). \tag{2}$$

In a similar way from equations (3.5a, 3.16) we can find current density on a circumference of given radius as a function of

$$\bar{J}_{rz} = j_z \sin(\beta\varphi). \tag{3}$$

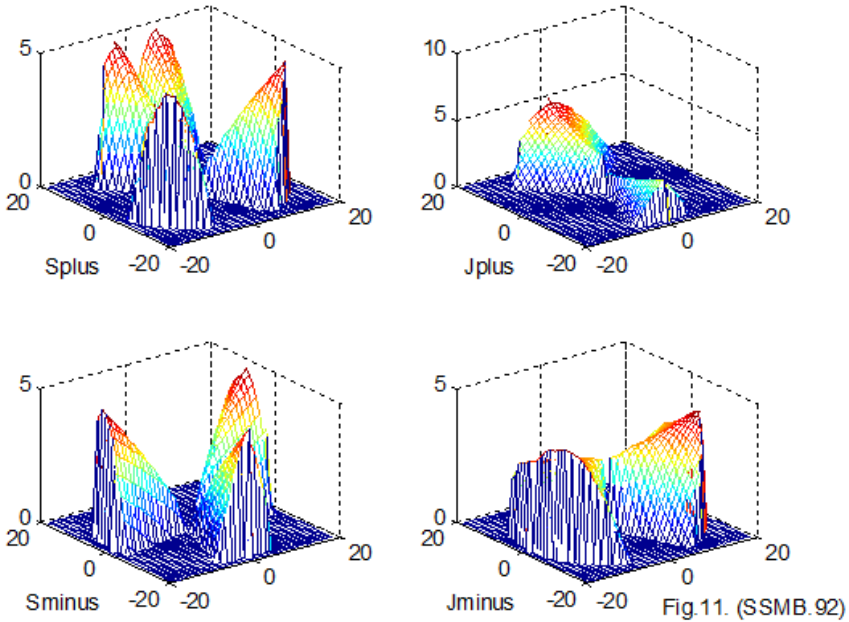

Function (2) was illustrated on Fig. 9. Left windows on Fig. 11 illustrate the graph of this function \bar{S}_{rz} (2), and the right windows, for comparison purpose, show graph of function \bar{J}_{rz} (3) drawn in the same way for $A=1$, $\alpha=1.4$, $\beta=1.6$, $R=19$.

From Fig. 11 it can be seen that currents and energy fluxes can exist in the wire, which are divided into contra-directional "streams".

Combinations of parameters can be selected such that total currents of contra-directional "streams" are equal in modulus, and at the same time, total energy fluxes of contra-directional "streams" are also equal in modulus. Fig. 13 illustrates this case: If $A=1$, $\alpha=1.8$, $\beta=2$, $R=19$, then the following integrals over wire cross-section area Q are equal (it's important that β is divisible by 2):

$$\int_Q S_{plus} \cdot dQ = -\int_Q S_{minus} \cdot dQ, \quad \int_Q J_{plus} \cdot dQ = -\int_Q J_{minus} \cdot dQ.$$

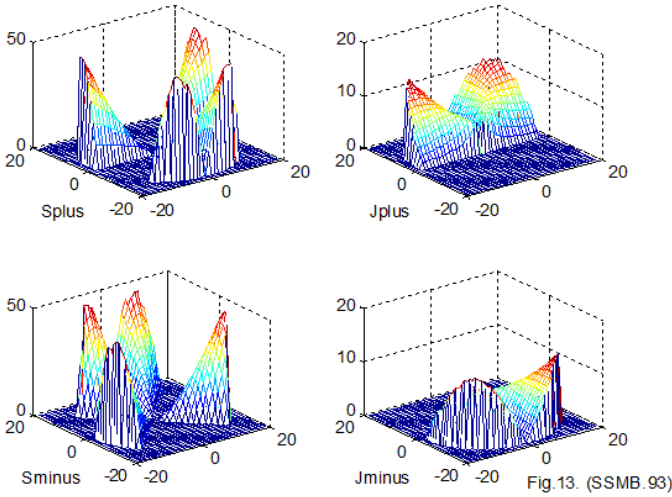

6. Discussion

It was shown that an electromagnetic wave is propagating in an alternating current wire, and the mathematic description of this wave is given by the solution of Maxwell equations.

This solution largely coincides with the solution found before for an electromagnetic wave propagating in vacuum – see Chapter 1. It was found that the current in the wire extends along a helical path, and pitch of the helical path depends on the density

It appears that the current propagates in the wire along a spiral trajectory, and the density of the spiral depends on the flow density of electromagnetic energy transferred along the wire to the load, i.e. on the transferred power. And the main flow of energy is propagated along and inside the wire.

Appendix 1

Let us consider the solution of equations (2.1-2.8) in the form of (2.13-2.18). Further the derivatives of r will be designated by strokes. We write the equations (2.1-2.8) in view of (2.11, 2.12) in the form

$$\frac{e_r(r)}{r} + e'_r(r) - \frac{e_\varphi(r)}{r} \alpha - \chi \cdot e_z(r) = 0, \quad (1)$$

$$-\frac{1}{r} \cdot e_z(r) \alpha + e_\varphi(r) \chi - \frac{\mu\omega}{c} h_r = 0, \quad (2)$$

$$e_r(r) \chi - e'_z(r) + \frac{\mu\omega}{c} h_\varphi = 0, \quad (3)$$

$$\frac{e_\varphi(r)}{r} + e'_\varphi(r) - \frac{e_r(r)}{r} \cdot \alpha + \frac{\mu\omega}{c} h_z = 0, \quad (4)$$

$$\frac{h_r(r)}{r} + h'_r(r) + \frac{h_\varphi(r)}{r} \alpha + \chi \cdot h_z(r) = 0, \quad (5)$$

$$\frac{1}{r} \cdot h_z(r) \alpha - h_\varphi(r) \chi - \frac{\varepsilon\omega}{c} e_r = 0, \quad (6)$$

$$-h_r(r) \chi - h'_z(r) + \frac{\varepsilon\omega}{c} e_\varphi = 0, \quad (7)$$

$$\frac{h_\varphi(r)}{r} + h'_\varphi(r) + \frac{h_r(r)}{r} \cdot \alpha + \frac{\varepsilon\omega}{c} e_z(r) = \frac{4\pi}{c} j_z(r), \quad (8)$$

We multiply (5) on $\left(-\frac{\mu\omega}{c\chi}\right)$. Then we get:

$$-\frac{\mu\omega}{c\chi} \frac{h_r(r)}{r} - \frac{\mu\omega}{c\chi} h'_r(r) - \frac{\mu\omega}{c\chi} \frac{h_\varphi(r)}{r} \alpha - \frac{\mu\omega}{c} h_z(r) = 0. \quad (9)$$

Comparing (4) and (9), we see that they are the same, if

$$\left\{ \begin{array}{l} h_z \neq 0 \\ -\frac{\mu \cdot \omega}{c\chi} h_\varphi(r) = e_r(r), \\ \frac{\mu \cdot \omega}{c\chi} h_r(r) = e_\varphi(r), \end{array} \right\} \quad (9a)$$

or, if

$$\left\{ \begin{array}{l} h_z = 0, \\ -M \frac{\mu \cdot \omega}{c\chi} h_\varphi(r) = e_r(r), \\ M \frac{\mu \cdot \omega}{c\chi} h_r(r) = e_\varphi(r), \end{array} \right\} \quad (9b)$$

where M - constant. Next, we use formulas

$$-M \frac{\mu \cdot \omega}{c\chi} h_\varphi(r) = e_r(r), \quad (10)$$

$$M \frac{\mu \cdot \omega}{c\chi} h_r(r) = e_\varphi(r), \quad (11)$$

where $M = 1$ in the case of (9a). Rewrite (2, 3, 6, 7) in the form:

$$e_z(r) = \frac{\chi r}{\alpha} e_\varphi(r) - \frac{r}{\alpha} \frac{\mu \omega}{c} h_r(r), \quad (12)$$

$$e'_z(r) = e_r(r) \chi + \frac{\mu \omega}{c} h_\varphi(r), \quad (13)$$

$$h_z(r) = \frac{\chi r}{\alpha} h_\varphi(r) + \frac{r}{\alpha} \frac{\varepsilon \cdot \omega}{c} e_r(r), \quad (14)$$

$$h'_z(r) = -h_r(r) \chi + \frac{\varepsilon \cdot \omega}{c} e_\varphi(r), \quad (15)$$

Substituting (10, 11) in these equations (12, 13), we get:

$$e_z(r) = \left(\chi - \frac{\chi}{M} \right) \frac{r}{\alpha} e_\varphi(r) = \frac{(M-1)}{M} \frac{\chi r}{\alpha} e_\varphi(r), \quad (16)$$

$$e'_z(r) = \left(\chi - \frac{\chi}{M} \right) e_r(r) \chi = \frac{(M-1)}{M} \chi e_r(r). \quad (17)$$

Substituting (10, 11) in these equations (14, 15), we get:

$$h_z(r) = \left(\chi - M \frac{\varepsilon \cdot \omega}{c} \frac{\mu \cdot \omega}{c \chi} \right) \frac{r}{\alpha} h_\varphi(r) = \frac{r}{\alpha c^2 \chi} (\mathbf{c}^2 \chi^2 - M \varepsilon \mu \omega^2) h_\varphi(r), \quad (18)$$

$$h'_z(r) = \left(-\chi + M \frac{\varepsilon \cdot \omega}{c} \frac{\mu \cdot \omega}{c \chi} \right) h_r(r) = \frac{-1}{c^2 \chi} (\mathbf{c}^2 \chi^2 - M \varepsilon \mu \omega^2) h_r(r). \quad (19)$$

Differentiating (16) and comparing with (17), we find:

$$\frac{(M-1)}{M} \frac{\chi}{\alpha} (r e_\varphi(r))' = \frac{(M-1)}{M} \chi e_r(r)$$

or

$$(r e_\varphi(r))' = \alpha e_r(r)$$

or

$$(e_\varphi(r) + r \cdot e'_\varphi(r)) = \alpha e_r(r). \quad (20)$$

From (1, 16), we find:

$$\frac{e_r(r)}{r} + e'_r(r) - \frac{e_\varphi(r)}{r} \alpha - \frac{(M-1)}{M} \chi^2 \frac{r}{\alpha} e_\varphi(r) = 0 \quad (23)$$

From physical considerations we must assume that

$$h_z(r) = 0. \quad (24)$$

Then from (18) we find

$$(\mathbf{c}^2 \chi^2 - M \varepsilon \mu \omega^2) = 0$$

or

$$\chi = \hat{\chi} \frac{\omega}{c} \sqrt{M \varepsilon \mu}, \quad \hat{\chi} = \pm 1. \quad (25)$$

From (16, 25), we find:

$$e_z(r) = (M-1) \frac{\chi r}{\alpha} e_\varphi(r) = \frac{(M-1)}{M} \hat{\chi} \frac{\omega}{c} \sqrt{M\varepsilon\mu} \frac{r}{\alpha} e_\varphi(r)$$

or

$$e_z(r) = \hat{\chi} \frac{(M-1)}{\sqrt{M}} \frac{\omega\sqrt{\varepsilon\mu}}{\alpha c} r e_\varphi(r) \quad (25a)$$

For $\omega \ll c$ from (25) we find that

$$|\chi| \ll 1. \quad (26)$$

Then in the equation (23) we can neglect the value χ^2 and obtain an equation of the form

$$\alpha \cdot e_\varphi(r) = e_r(r) + r \cdot e'_r(r). \quad (27)$$

From (27, 20) due to the symmetry we find:

$$e_r(r) = e_\varphi(r), \quad (28)$$

$$\alpha \cdot e_\varphi(r) = e_\varphi(r) + r \cdot e'_\varphi(r). \quad (29)$$

The solution of this equation is as follows:

$$e_\varphi(r) = Ar^{\alpha-1}, \quad (30)$$

which can be checked by substitution of (30) into (29). From (11, 25), we find

$$h_r(r) = \hat{\chi} \sqrt{\frac{\varepsilon}{M\mu}} e_\varphi(r), \quad (31)$$

and from (10, 28), we find

$$h_\varphi(r) = -h_r(r). \quad (32)$$

Finally, from (8, 32), we find

$$j_z(r) = \frac{c}{4\pi} \left(-\frac{h_r(r)}{r} - h'_r(r) + \frac{h_r(r)}{r} \cdot \alpha + \frac{\varepsilon\omega}{c} e_z(r) \right) \quad (33)$$

Taking into account (30,31), we note that the sum of the first three terms is equal to zero, and then

$$j_z(r) = \frac{\varepsilon\omega}{4\pi} e_z(r). \quad (34)$$

So, we finally obtain:

$$e_\varphi(r) = Ar^{\alpha-1}, \quad (30)$$

$$e_r(r) = e_\varphi(r), \quad (28)$$

$$e_z(r) = \hat{\chi} \frac{(M-1)}{\sqrt{M}} \frac{\omega\sqrt{\varepsilon\mu}}{\alpha c} r e_\varphi(r) \quad (25a)$$

$$h_r(r) = \hat{\chi} \sqrt{\frac{\varepsilon}{M\mu}} e_\varphi(r), \quad (31)$$

$$h_\varphi(r) = -h_r(r), \tag{32}$$

$$h_z(r) = 0, \tag{24}$$

$$j_z(r) = \frac{\varepsilon\omega}{4\pi} e_z(r). \tag{34}$$

The accuracy of the solution

To analyze the accuracy of the solution may be for given values of all constants to find the residual equation (1-7). Fig. 0 shows the logarithm of the mean square residual of the parameter α - $\ln N = f(\alpha)$, when $A = 1$, $\omega = 300$, $\mu = 1$, $\varepsilon = 1$.



Fig.0. (SSMB)

Chapter 5. Solution of Maxwell's Equations for Wire with Constant Current

Contents

1. Introduction
 2. Mathematical Model
 3. Energy Flows
 5. Discussion
- Appendix 1
Appendix 2
Appendix 3
Appendix 4

1. Introduction

In [7, 9-11] was shown that constant current in the wire has a complex structure, and the flow of electromagnetic energy is spreading inside the wire. Also the electromagnetic flow

- directed along the wire axis,
- spreads along the wire axis,
- spreads inside the wire,
- compensates the heat losses of the axis component of the current.

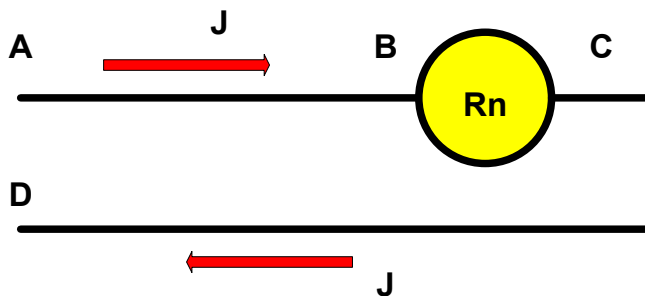

Fig. 1.

In [9-11] a mathematical model of the current and the flow has been. The model was built exclusively on base of Maxwell equations. Only one question remained unclear. The electric current $\mathbf{J}_{\text{ток}}$ and the flow of electromagnetic energy \mathbf{S} are spreading inside the wire **ABCD** and it is passing through the load **Rn**. In this load a certain amount of

strength P is spent. Therefore the energy flow on the segment **AB** should be larger than the energy flow on the segment **CD**. More accurate, **S_{ab}=S_{cd}+P**. But the current strength after passing the load did not change. How must the current structure change so that the electromagnetic energy decreased correspondingly? This issue was considered in [7].

Below we shall consider a mathematical model more general than the model (compared to [7, 9-11]) and allowing to clear also this question. This mathematical model is also built solely on the base of Maxwell equations. In [12] describes an experiment which was carried out in 2008. In [17] it is shown that this experiment can be explained on the basis of non-linear structure of constant current in the wire and can serve as an experimental proof of the existence of such a structure.

2. Mathematical Model

Maxwell's equations for direct current wire are shown Chapter "Introduction" - see variant 6:

$$\text{rot}(J) = 0, \tag{a}$$

$$\text{rot}(H) - J - J_o = 0, \tag{b}$$

$$\text{div}(J) = 0, \tag{c}$$

$$\text{div}(H) = 0. \tag{d}$$

Here, in these equations we included a given value of density J_o of the current passing through the wire as a load. We know, that $H_\varphi = J_z r$. As the definition of curl includes derivatives $\partial H / \partial r$ and $\partial H_\varphi / \partial r = J_o$, then equation (b) can be simplified as follows

$$\text{rot}(H) - J = 0. \tag{b1}$$

The solution of equations (a, b1, c, d) is assumed to be zero. However, below we will demonstrate that in the presence of current J_o there shall be non-zero solution of these equations.

In building this model we shall be using the cylindrical coordinates r, φ, z considering

- the main current J_o and intensity H_φ produced by it,
- the additional currents J_r, J_φ, J_z ,
- magnetic intensities H_r, H_φ, H_z ,
- electrical intensities E ,
- electrical resistivity ρ .

The solution requires to find density functions for all intensities and currents. The current in the wire is usually considered as average electrons flow. The mechanical interactions of electrons with the atoms are considered equivalent to electrical resistivity.

The equations (a-d) for cylindrical coordinates have the following form:

$$\frac{H_r}{r} + \frac{\partial H_r}{\partial r} + \frac{1}{r} \cdot \frac{\partial H_\varphi}{\partial \varphi} + \frac{\partial H_z}{\partial z} = 0, \quad (1)$$

$$\frac{1}{r} \cdot \frac{\partial H_z}{\partial \varphi} - \frac{\partial H_\varphi}{\partial z} = J_r, \quad (2)$$

$$\frac{\partial H_r}{\partial z} - \frac{\partial H_z}{\partial r} = J_\varphi, \quad (3)$$

$$\frac{H_\varphi}{r} + \frac{\partial H_\varphi}{\partial r} - \frac{1}{r} \cdot \frac{\partial H_r}{\partial \varphi} = J_z + J_o, \quad (4)$$

$$\frac{J_r}{r} + \frac{\partial J_r}{\partial r} + \frac{1}{r} \cdot \frac{\partial J_\varphi}{\partial \varphi} + \frac{\partial J_z}{\partial z} = 0, \quad (5)$$

$$\frac{1}{r} \cdot \frac{\partial J_z}{\partial \varphi} - \frac{\partial J_\varphi}{\partial z} = 0, \quad (6)$$

$$\frac{\partial J_r}{\partial z} - \frac{\partial J_z}{\partial r} = 0, \quad (7)$$

$$\frac{J_\varphi}{r} + \frac{\partial J_\varphi}{\partial r} - \frac{1}{r} \cdot \frac{\partial J_r}{\partial \varphi} = 0. \quad (8)$$

The model is based on the following facts:

1. the main electric intensities E_o is directed along the wire axis ,
2. it creates the main electric current J_o – the vertical flow of charges,
3. vertical current J_o forms an annular magnetic field with intensity H_φ and radial magnetic field H_r - see (4),
4. magnetic field H_φ deflects by the Lorentz forces charges vertical flow in the radial direction, creating a radial flow of charges - radial current J_r ,
5. magnetic field H_o deflects by the Lorentz forces the charges of radial flow perpendicularly to the radii, thus creating an vertical current J_z (in addition to current J_o),

6. magnetic field H_r by the aid of the Lorentz forces deflects the charges of vertical flow perpendicularly to the radii, thus creating an annular current J_φ ,
7. magnetic field H_r by the aid of the Lorentz forces deflects the charges of annular flow along radii, thus creating vertical current J_z (in addition to current J_o),
8. current J_r forms a vertical magnetic field H_z and annular magnetic field H_φ - see (2),
9. current J_φ form a vertical magnetic field H_z and radial magnetic field H_r - see (3),
10. current J_z form a annular magnetic field H_φ and radial magnetic field H_r - see (6),

Thus, the main electric current J_o creates additional currents J_r , J_φ , J_z and magnetic fields H_r , H_φ , H_z . They should satisfy the Maxwell equations.

In addition, electromagnetic fluxes shall be such that

- A. Energy flux in vertical direction was equal to transmitted power,
- B. The sum of energy fluxes is to equal to transmitted power plus the power of thermal losses in the wire.

Thus, currents and intensities shall confirm Maxwell's equations and conditions A and B. In order to find a solution we part this problem into three following tasks (that is true, because Maxwell's equations are linear):

- a) to find solution of equations (1-8) without current J_o ; this solution occurs to be multi-valued;
- b) to find additional limitations on initial solution posed by conditions A and B; here we take into account current J_o and intensity $H_{o\varphi}$ produced by it.

First of all, we shall prove that a solution of system (1-8) is exist with non-zero currents J_r , J_φ , J_z .

For the sake of brevity further we shall use the following notations:

$$co = -\cos(\alpha\varphi + \chi z), \quad (10)$$

$$si = \sin(\alpha\varphi + \chi z), \quad (11)$$

where α, χ – are certain constants. In the Appendix 1 it is shown that there exists a solution of the following form:

$$J_r = j_r(r) \rho, \quad (12)$$

$$J_\varphi = j_\varphi(r) \rho, \quad (13)$$

$$J_z = j_z(r) \rho, \quad (14)$$

$$H_r = h_r(r) \rho, \quad (15)$$

$$H_\varphi = h_\varphi(r) \rho, \quad (16)$$

$$H_z = h_z(r) \rho, \quad (17)$$

where $j(r), h(r)$ - certain function of the coordinate r .

It can be assumed that the average speed of electrical charges doesn't depend on the current direction. In particular, for a fixed radius the way passed by the charge around a circle and the way passed by it along a vertical will be equal. Consequently, for a fixed radius it can be assumed that

$$\Delta\varphi \equiv \Delta z. \quad (18)$$

Thus, there on cylinder of constant radius is trajectory of point, which described by the formulas (10, 11, 18). This trajectory is a helix. On the other hand, in accordance with (12-17) on this trajectory all intensities and current densities varies harmonically as a function of φ . Consequently,

line on a cylinder of constant radius r , at which point moves so that all the intensities and current densities therein varies harmonically depending of φ , is helical line.

Based on this assumption we can build the trajectory of the charge motion according to the functions (10, 11).

The Fig. 2 shows three spiral lines for $\Delta\varphi = \Delta z$, described by functions (10, 11) of the current: the thick line for $\alpha = 2, \chi = 0.8$, the average line for $\alpha = 0.5, \chi = 2$ and a thin line for линия $\alpha = 2, \chi = 1.6$.

In Appendix 1 it is shown that the functions satisfy the following equations:

$$j_\varphi(r) = kh(\alpha, \chi, r), \quad (25)$$

$$j_r(r) = -\frac{1}{\alpha} (j_\varphi(r) + r \cdot j'_\varphi(r)), \quad (26)$$

$$j_z(r)\alpha = r \cdot j_\varphi(r) \frac{\chi}{\alpha}, \tag{27}$$

$$h_z(r) \equiv 0, \tag{28}$$

$$h_\varphi(r) = -j_r(r) / \chi, \tag{29}$$

$$h_r(r) = -j_\varphi(r) / \chi. \tag{30}$$

This solution is analyzed below.

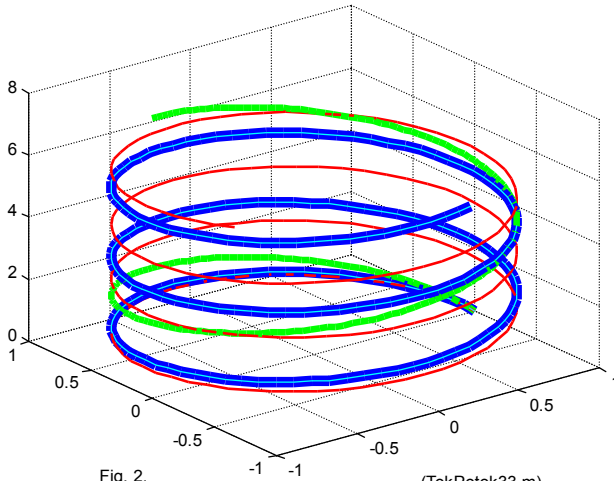

Fig. 2. (TokPotok33.m)

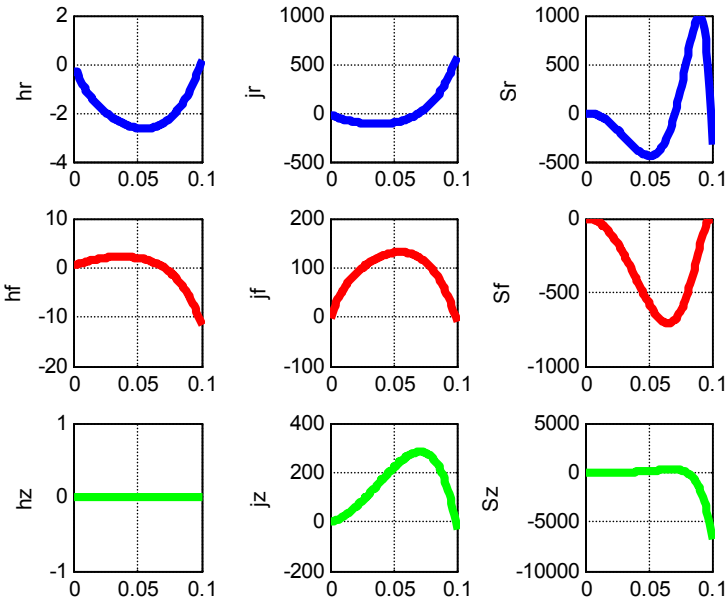

Fig.3.1. (fig-5-3-1.m)

Example 1. On Fig. 3.1 the graphs of functions $j_r(r)$, $j_\varphi(r)$, $j_z(r)$, $h_r(r)$, $h_\varphi(r)$, $h_z(r)$ are shown. These functions are calculated with given $\alpha = 1.5$, $\chi = 50$, $z_o = -30$, $b = 850$ and wire radius $R = 0.1$ (parameters z_o , b are required for calculation of function (25) – see Appendix 2). The first column shows functions $j_r(r)$, $j_\varphi(r)$, $j_z(r)$, the second - functions $h_r(r)$, $h_\varphi(r)$, $h_z(r)$, and the functions shown in the third column will be discussed later.

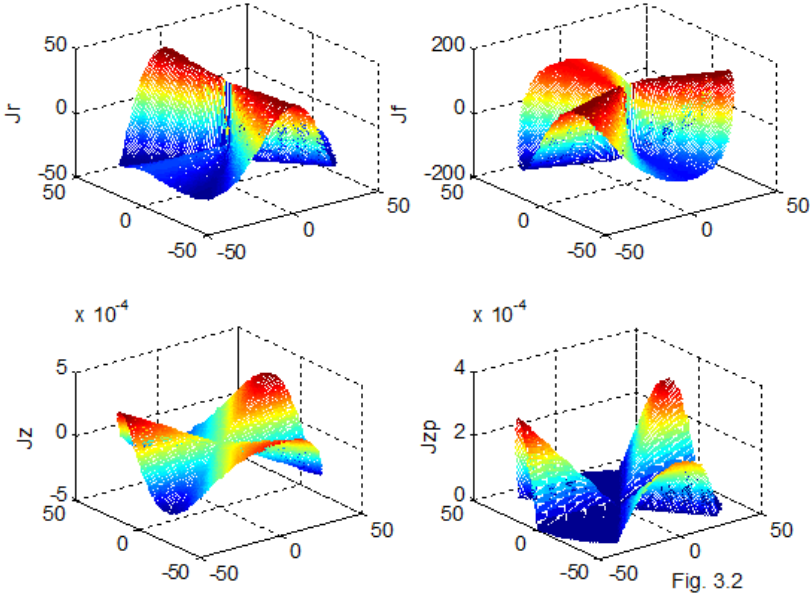

Fig. 3.2 illustrates functions (12-14), when $z = const$. The fourth window shows function

$$J_{p_z}(r, \varphi) = \begin{cases} J_z(r, \varphi), & \text{if } J_z(r, \varphi) > 0, \\ 0, & \text{if } J_z(r, \varphi) \leq 0. \end{cases}$$

Let's determine current density in the wire of radius R :

$$\overline{J_z} = \frac{1}{\pi R^2} \iint_{r, \varphi} [J_z] dr \cdot d\varphi. \tag{31}$$

Taking into account (14), we find

$$\overline{J_z} = \frac{1}{\pi R^2} \iint_{r, \varphi} [j_z(r) si] dr \cdot d\varphi = \frac{1}{\pi R^2} \int_0^R j_z(r) \left(\int_0^{2\pi} (si \cdot d\varphi) \right) dr. \tag{32}$$

Taking into account (11), we find

$$\overline{J}_z = \frac{1}{\alpha\pi R^2} \int_0^R j_z(r) \left(\cos(2\alpha\pi + \frac{2\omega}{c}z) - \cos(\frac{2\omega}{c}z) \right) dr. \quad (33)$$

From here it follows that total current \overline{J}_z is changed depending on z coordinate. However, total given current with density J_o remains constant.

3. Energy Flows

The density of electromagnetic flow is Poynting vector

$$S = E \times H. \quad (1)$$

The currents are being corresponded by eponymous electrical intensities, i.e.

$$E = \rho \cdot J, \quad (2)$$

where ρ is electrical resistivity. Combining (1, 2), we get:

$$S = \rho J \times H = \frac{\rho}{\mu} J \times B. \quad (3)$$

Magnetic Lorentz force, acting on all the charges of the conductor per unit volume - the bulk density of magnetic Lorentz forces is equal to

$$F = J \times B. \quad (4)$$

From (3, 4), we find:

$$F = \mu S / \rho. \quad (5)$$

Therefore, in wire with constant current magnetic Lorentz force density is proportional to Poynting vector.

Example 1 To examine the dimension checking of the quantities in the above formulas - see Table 1 in system SI.

Table 1

Parameter		Dimension
Energy flux density	S	$\text{kg} \cdot \text{s}^{-3}$
Current density	J	$\text{A} \cdot \text{m}^{-2}$
Induction	B	$\text{kg} \cdot \text{s}^{-2} \cdot \text{A}$
Bulk density of magnetic Lorentz forces	F	$\text{N} \cdot \text{m}^{-3} = \text{kg} \cdot \text{s}^{-3} \cdot \text{m}^{-2}$
Permeability	μ	$\text{kg} \cdot \text{s}^{-2} \cdot \text{m} \cdot \text{A}^{-2}$
Resistivity	ρ	$\text{kg} \cdot \text{s}^{-3} \cdot \text{m}^3 \cdot \text{A}^{-2}$
μ/ρ	μ/ρ	$\text{s} \cdot \text{m}^{-2}$

So, current with density J and magnetic field is generated energy flux with density S , which is identical with the magnetic Lorentz force density F - see (5). This Lorentz force acts on the charges moving in a current J , in a direction perpendicular to this current. So, it's fair to say that the Poynting vector produces an emf in the conductor. Another aspects of this problem are considered in work [19], where this emf is called the fourth type of electromagnetic induction.

In cylindrical coordinates r, φ, z the density flow of electromagnetic energy has three components S_r, S_φ, S_z , directed along the axis accordingly.

3.1. In each point of a cylinder surface there are two electromagnetic fluxes directed radially to the center with densities

$$S_{r1} = \rho J_\varphi H_z, \quad S_{r2} = -\rho J_z H_\varphi \quad (6)$$

- see Fig. 5. Total radially-directed flux density in each point of the cylinder surface,

$$S_r = S_{r1} + S_{r2} = \rho(J_\varphi H_z - J_z H_\varphi) \quad (7)$$

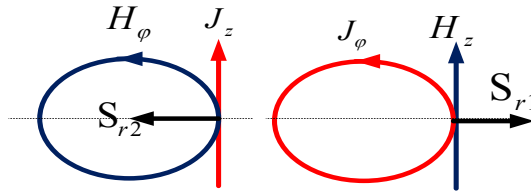

Fig. 5.

3.2. In each point of a cylinder surface there are two electromagnetic fluxes directed vertically with densities

$$S_{z1} = -\rho J_\varphi H_r, \quad S_{z2} = \rho J_r H_\varphi \quad (8)$$

- see Fig. 6. Total vertically-directed flux density in each point of the cylinder surface,

$$S_z = S_{z1} + S_{z2} = \rho(J_r H_\varphi - J_\varphi H_r) \quad (9)$$

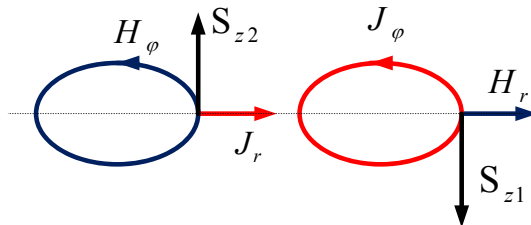

Fig. 6.

3.3. In each point of a cylinder surface there are two electromagnetic fluxes circumferentially directed with densities

$$S_{\varphi 1} = \rho J_z H_r, \quad S_{\varphi 2} = -\rho J_r H_z, \quad (10)$$

- see Fig. 7. Total circumferentially directed flux density in each point of the cylinder surface,

$$S_{\varphi} = S_{\varphi 1} + S_{\varphi 2} = \rho(J_z H_r - J_r H_z) \quad (11)$$

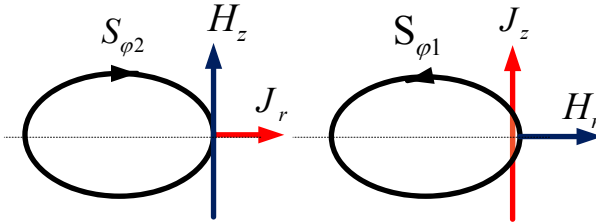

Fig. 7.

In view of the above, we can write the equation for electromagnetic flux density in a direct current wire:

$$S = \begin{bmatrix} S_r \\ S_{\varphi} \\ S_z \end{bmatrix} = \rho(J \times H) = \rho \begin{bmatrix} J_{\varphi} H_z - J_z H_{\varphi} - J_o H_{o\varphi} \\ J_z H_r - J_r H_z + J_o H_r \\ J_r H_{\varphi} - J_{\varphi} H_r + J_r H_{o\varphi} \end{bmatrix}. \quad (12)$$

The third components in (12) appears due to the fact that energy fluxes are influenced by current density J_o and intensity

$$H_{o\varphi} = J_o r \quad (13)$$

- see (2.4). From (2.12-2.17, 12, 13) it follows that

$$S = \begin{bmatrix} S_r \\ S_{\varphi} \\ S_z \end{bmatrix} = \rho \iiint_{r,\varphi,z} \begin{bmatrix} (j_{\varphi} h_z - j_z h_{\varphi}) \cdot si^2 - J_o^2 r \\ (j_z h_r - j_r h_z) \cdot si \cdot co + J_o h_z si \\ (j_r h_{\varphi} - j_{\varphi} h_r) \cdot si \cdot co + j_r co \cdot J_o r \end{bmatrix} dr \cdot d\varphi \cdot dz. \quad (14)$$

Fig. 3.1 the right-hand column shows the functions

$$\begin{bmatrix} \overline{S_r}(r) \\ \overline{S_{\varphi}}(r) \\ \overline{S_z}(r) \end{bmatrix} = \begin{bmatrix} (j_{\varphi} h_z - j_z h_{\varphi}) \\ (j_z h_r - j_r h_z) \\ (j_r h_{\varphi} - j_{\varphi} h_r) \end{bmatrix}. \quad (15)$$

Fig. 3.3 shows the functions

$$\begin{bmatrix} \overline{S_r}(r, \varphi) \\ \overline{S_{\varphi}}(r, \varphi) \\ \overline{S_z}(r, \varphi) \end{bmatrix} = \begin{bmatrix} (j_{\varphi} h_z - j_z h_{\varphi}) \cdot si^2 \\ (j_z h_r - j_r h_z) \cdot si \cdot co \\ (j_r h_{\varphi} - j_{\varphi} h_r) \cdot si \cdot co \end{bmatrix}, \quad (15a)$$

when $z = const$. In the fourth window shows the function

$$Sp_z(r, \varphi) = \begin{cases} S_z(r, \varphi), & \text{if } S_z(r, \varphi) > 0, \\ 0, & \text{if } S_z(r, \varphi) \leq 0. \end{cases}$$

Taking into account designations (15) and equations (2.28), from (14) we obtain:

$$S = \begin{bmatrix} S_r \\ S_\varphi \\ S_z \end{bmatrix} = \rho \iiint_{r, \varphi, z} \begin{bmatrix} \overline{S_r(r)} \cdot si^2 - J_o^2 r \\ \overline{S_\varphi(r)} \cdot si \cdot co \\ \overline{S_z(r)} \cdot si \cdot co + j_r co \cdot J_o r \end{bmatrix} dr \cdot d\varphi \cdot dz. \quad (16)$$

or

$$S = \rho \left(\int_r \begin{bmatrix} \overline{S_r(r)} \\ \overline{S_\varphi(r)} \\ \overline{S_z(r)} \end{bmatrix} dr \right) \cdot \left(\iint_{\varphi, z} \begin{bmatrix} si^2 \\ si \cdot co \\ si \cdot co \end{bmatrix} d\varphi dz \right) + \rho \left(\int_r \begin{bmatrix} J_o^2 r \\ 0 \\ j_r J_o r \end{bmatrix} dr \right) \cdot \left(\iint_{\varphi, z} \begin{bmatrix} -1 \\ 0 \\ co \end{bmatrix} d\varphi dz \right). \quad (17)$$

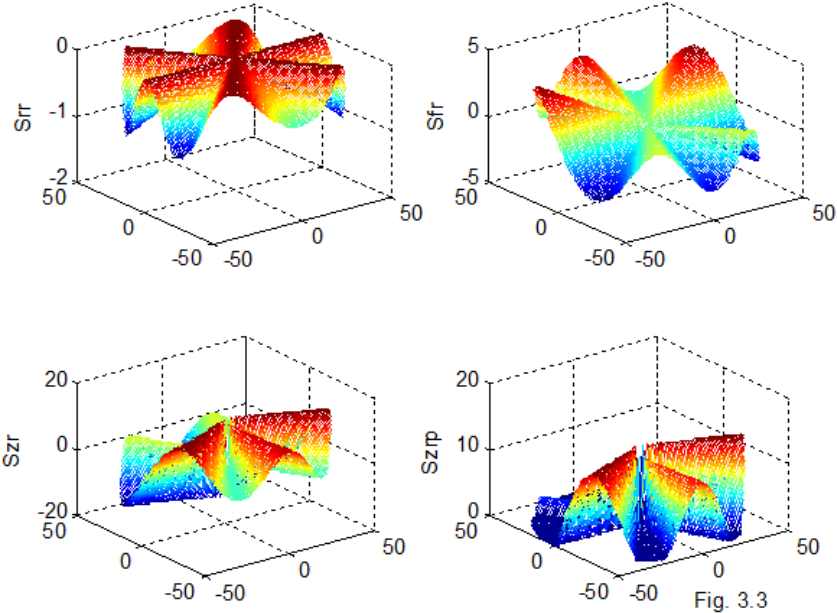

Fig. 3.3

Appendix 4 contains evaluations of the double integrals from equation (17). If we apply them for unit wire length $z_o = 1$, we obtain the following:

$$S = \rho \left(\int_r \begin{bmatrix} \overline{S_r(r)} \\ \overline{S_\varphi(r)} \\ \overline{S_z(r)} \end{bmatrix} dr \right) \cdot \begin{bmatrix} D_3 \\ D_2 \\ D_2 \end{bmatrix} + \rho \left(\int_r \begin{bmatrix} J_o^2 r \\ 0 \\ j_r J_o r \end{bmatrix} dr \right) \cdot \begin{bmatrix} -V \\ 0 \\ D_1 \end{bmatrix}, \quad (18)$$

where

$$V = \iint_{\varphi, z} d\varphi dz = 2\pi \cdot z_o = 2\pi, \quad (19)$$

$$\tilde{D}_2 \approx \frac{1}{\alpha\chi}, \quad (20)$$

$$\tilde{D}_1 \approx \frac{2}{\alpha\chi} = 2\tilde{D}_2, \quad (21)$$

$$\tilde{D}_3 \approx \pi b - \frac{1}{2\alpha\chi} = \pi b - 0.5\tilde{D}_2, \quad (22)$$

b – number of helical trajectory per unit length.

Through combining (18-22) we finally obtain:

$$S = \rho \left(\left(\int_r \begin{bmatrix} \tilde{D}_3 \overline{S}_r(r) \\ \tilde{D}_2 \overline{S}_\varphi(r) \\ \tilde{D}_2 \overline{S}_z(r) \end{bmatrix} dr \right) + \left(\int_r \begin{bmatrix} -2\pi J_o^2 r \\ 0 \\ 2\tilde{D}_2 J_o J_r r \end{bmatrix} dr \right) \right) \quad (23)$$

or

$$S = \rho \begin{bmatrix} \tilde{D}_3 \int_r \overline{S}_r(r) dr - \pi R^2 J_o^2 \\ \tilde{D}_2 \int_r \overline{S}_\varphi(r) dr \\ \tilde{D}_2 \int_r (\overline{S}_z(r) + 2J_o J_r r) dr \end{bmatrix}. \quad (24)$$

Second components in the first term of equation (24) is determined as

$$S_w = -\rho\pi R^2 J_o^2, \quad (25)$$

which is exactly equal to thermal losses power per wire unit length. However, according to existing assumptions the wire unit length accommodates an external energy flux directed radially to the wire axis and determined by (25). Here we see that this flux is internal.

Obviously, these correlations remain the same for any $z = 0$ position on oz axis.

So, fluxes (23) circulate in the wire. They are internal fluxes. They are produced by currents and magnetic intensities created by these currents. In turn, these fluxes generate currents such as Lorentz forces. In this case total energy of these fluxes is partially spent on thermal losses, but mainly goes to load.

Example 3. Let's consider the following example. Table 1 shows initial data and calculation results. Fig. 8 shows densities of energy fluxes from (23) as functions of radius. More specifically, the left windows show functions $Sr = \overline{S}_r(r)$, $Sf = \overline{S}_\varphi(r)$, $Sz = \overline{S}_z(r)$, and the right windows - functions

$$\begin{bmatrix} Sr2 \\ Sf2 \\ Sz1 \\ Sz2 \end{bmatrix} = \rho \begin{bmatrix} \tilde{D}_3 \int_r \overline{S}_r(r) dr \\ \tilde{D}_2 \int_r \overline{S}_\varphi(r) dr \\ \tilde{D}_2 \int_r \overline{S}_z(r) dr \\ \tilde{D}_2 \int_r 2J_o j_r r dr \end{bmatrix} \quad (26)$$

Based on these functions we can calculate total energy fluxes (powers) Sr2full, Sf2full, Sz1full, Sz2full.

At the present time, the author of these paper has no regular calculation method. With certain design parameters (see column "Given") for modeling it's required to vary values of the parameters (see column "Determined"). Certainly, for this case it is necessary only to show that an admissible decision exists.

From Table 1 it follows that transmitted power to thermal losses power ratio Sz2full/Sw=10⁻⁴. So, with given current density J_o transmitted power can take up almost any value depending on parameters χ , α , i.e. current helical trajectory density. Therefore, consumed power does not depend on current, and is determined by current helical trajectory density.

Table 1

Given		Found		Calculated		
R	1 mm	$(\alpha\chi)$	100	Power loss in the wire	Sw	0.22 Wt
b	100	α	-1.6		Sr2full	$5 \cdot 10^{-9}$ Wt
J_o	2 A\mm ²	χ	-63		Sf2full	$6 \cdot 10^{-10}$ Wt
		$j'_\varphi(0)$	2		Sz1full	$4 \cdot 10^{-9}$ Wt
				Power transmitted to the load	Sz2full	2000 Wt

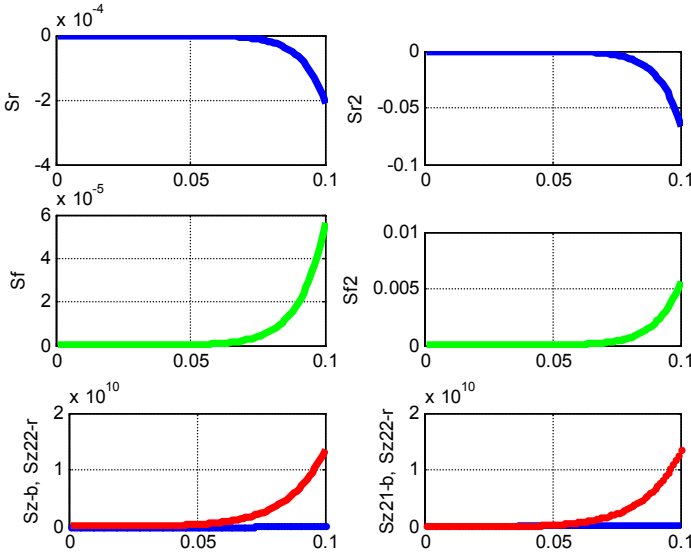

Fig.8 (TokPotok33.m)

4. Discussion

So, the complete solution of Maxwell's Equations for a wire with direct current consists of two parts:

- 1) known equation (3.13) in the following form: $H_{o\phi} = J_o r$, and
- 2) equations (2.10-2.17, 2.25-2.30) obtained above.

The energy flow along the wire's axis S_z is created by the currents and intensities directed along the radius and the circles. This energy flow is equal to the power released in the load R_H and in the wire resistance. The currents flowing along the radius and the circle are also creating heat losses. Their powers are equal to the energy flows S_r , S_ϕ , directed along radius and circle.

The question of the way by in which the electromagnetic energy creates current is considered in [19]. There it is shown that there exists a fourth electromagnetic induction created by a change in electromagnetic energy flow. Further we must find the dependence of emf of this induction from the electromagnetic flow density and from the wire parameters. There is a well-known experiment which can provide evidence for existence of this type of induction [17].

It is shown that direct current has a complex structure and extends inside the wire along a helical trajectory. In the case of constant current the density of helical trajectory decreases with the decrease of the remaining load resistance. There are two components of the current. The

density of the first component J_o is permanent of the whole wire section. The density of the second component is changing along the wire section so that the current is spreading in a spiral. In cylindrical coordinates r, φ, z this second component has coordinates J_r, J_φ, J_z . They can be found as the solution of Maxwell equations.

With invariable density of the main current in a wire the power transmitted by it depends on the structure parameters (α, χ) which influence the density of the turns of helical trajectory. Thus, the same current in a wire can transmit various values of power (depending on the load).

Let us again look at the Fig 1. On segment **AB** the wire transmits the load energy **P**. It is corresponded by a certain values of (α, χ) and the density of coils of the current's helical path. On the segment **CD** the wire transmits only small amount of energy. It corresponds to small value of χ and small density of the coils of current's helical path.

Naturally, the resistivity of the wire itself is also a load. Thus, as the current flows within the wire, the helix of the current's path straightens.

The dependence of current density and intensity density was considered in detail in [10]. Generally, the mathematical model presented in [10] may be considered as a consequence of the described model for $\chi \rightarrow 0$.

Thus, it is shown that there exists such a solution of Maxwell equations for a wire with constant current which corresponds to the idea of

- law of energy preservation
- helical path of constant current in the wire,
- energy transmission along and inside the wire,
- the dependence of helical path density on the transmitted strength.

Appendix 1

Let us consider the solution of equations (2.5-2.9) in the form of (2.12-2.17). Further the derivatives of r will be designated by strokes. We rewrite the equations (2.5-2.9) in the form

$$\frac{j_r(r)}{r} + j'_r(r) + \frac{j_\varphi(r)}{r} \alpha + \chi \cdot j_z(r) = 0, \quad (1)$$

$$\frac{h_r(r)}{r} + h'_r(r) + \frac{h_\varphi(r)}{r} \alpha + \chi \cdot h_z(r) = 0, \quad (2)$$

$$\frac{1}{r} \cdot h_z(r)\alpha - h_\varphi(r)\chi = j_r(r), \quad (3)$$

$$-h_r(r)\chi - h'_z(r) = j_\varphi(r), \quad (4)$$

$$\frac{h_\varphi(r)}{r} + h'_\varphi(r) + \frac{h_r(r)}{r} \cdot \alpha - j_z(r) = 0, \quad (5)$$

$$\frac{1}{r} \cdot j_z(r)\alpha - j_\varphi(r)\chi = 0, \quad (6)$$

$$-j_r(r)\chi - j'_z(r) = 0, \quad (7)$$

$$\frac{j_\varphi(r)}{r} + j'_\varphi(r) + \frac{j_r(r)}{r} \cdot \alpha = 0. \quad (8)$$

We multiply (5) to $(-\chi)$. Then we get:

$$-\frac{\chi \cdot h_\varphi(r)}{r} - \chi \cdot h'_\varphi(r) - \frac{\chi \cdot h_r(r)}{r} \cdot \alpha + \chi \cdot j_z(r) = 0, \quad (9)$$

Comparing (1) and (9), we see that they are the same, if

$$-h_\varphi(r)\chi = j_r(r), \quad (10)$$

$$-h_r(r)\chi = j_\varphi(r). \quad (11)$$

It is important to note that this comparison is valid only for $j_z(r) \neq 0$. Equations (10, 11) coincide with (3, 4) for $h_z(r) = 0$. Consequently, if $j_z(r) \neq 0$ and $h_z(r) = 0$ equation (1) can be eliminated and the system (1-5) is simplified and takes the form

$$\frac{h_r(r)}{r} + h'_r(r) + \frac{h_\varphi(r)}{r} \alpha = 0, \quad (\text{see (2)}) \quad (12)$$

$$-h_\varphi(r)\chi = j_r(r), \quad (\text{see (10)}) \quad (13)$$

$$-h_r(r)\chi = j_\varphi(r), \quad (\text{see (11)}) \quad (14)$$

$$\frac{h_\varphi(r)}{r} + h'_\varphi(r) + \frac{1}{r} \cdot h_r(r)\alpha = j_z(r). \quad (\text{see (5)}) \quad (15)$$

Now consider the case when $j_z(r) = 0$. Then equations (1-5) in the initial system will take the form:

$$\frac{j_r(r)}{r} + j'_r(r) + \frac{j_\varphi(r)}{r} \alpha = 0, \quad (16)$$

$$\frac{h_r(r)}{r} + h'_r(r) + \frac{h_\varphi(r)}{r} \alpha + \chi \cdot h_z(r) = 0, \quad (17)$$

$$\frac{1}{r} \cdot h_z(r)\alpha - h_\varphi(r)\chi = j_r(r), \quad (18)$$

$$-h_r(r)\chi - h'_z(r) = j_\varphi(r), \quad (19)$$

$$\frac{h_\varphi(r)}{r} + h'_\varphi(r) + \frac{1}{r} \cdot h_r(r) \alpha = 0. \quad (20)$$

Substituting (18, 19) in (16). Then we get:

$$\frac{1}{r^2} \cdot h_z(r) \alpha - \frac{1}{r} \cdot h_\varphi(r) \chi + \frac{1}{r} \cdot h'_z(r) \alpha - h'_\varphi(r) \chi - (h_r(r) \chi + h'_z(r)) \frac{\alpha}{r} = 0$$

or

$$\frac{1}{r^2} \cdot h_z(r) \alpha - \frac{1}{r} \cdot h_\varphi(r) \chi - h'_\varphi(r) \chi - h_r(r) \frac{\chi \alpha}{r} = 0 \quad (21)$$

Thus to calculate the three intensities obtain three equations (17, 20, 21).

We exclude $h'_\varphi(r)$ from the (20, 21):

$$\frac{1}{r^2} \cdot h_z(r) \alpha - \frac{1}{r} \cdot h_\varphi(r) \chi + \left(\frac{1}{r} \cdot h_\varphi(r) + h_r(r) \frac{\alpha}{r} \right) \chi - h_r(r) \frac{\chi \alpha}{r} = 0$$

or

$$\frac{1}{r^2} \cdot h_z(r) \alpha = 0.$$

Thus, and when $j_z(r) = 0$ must comply with conditions $h_z(r) = 0$.

Thus, the system of equations (12-15) is executed for any $j_z(r)$ and wherein

$$h_z(r) \equiv 0. \quad (22)$$

So, equations (1-8) can be substituted for equations (22, 12-15, 6-8). We rewrite them for readers' convenience:

$$h_z(r) \equiv 0, \quad (22)$$

$$\frac{h_r(r)}{r} + h'_r(r) + \frac{h_\varphi(r)}{r} \alpha = 0, \quad (23)$$

$$-h_\varphi(r) \chi = j_r(r), \quad (24)$$

$$-h_r(r) \chi = j_\varphi(r), \quad (25)$$

$$\frac{h_\varphi(r)}{r} + h'_\varphi(r) + \frac{1}{r} \cdot h_r(r) \alpha = j_z(r). \quad (26)$$

$$\frac{1}{r} \cdot j_z(r) \alpha - j_\varphi(r) \chi = 0 \quad (27)$$

$$-j_r(r) \chi - j'_z(r) = 0 \quad (28)$$

$$\frac{j_\varphi(r)}{r} + j'_\varphi(r) + \frac{j_r(r)}{r} \cdot \alpha = 0 \quad (29)$$

When substituting (24, 25) into (29) we can notice that the equation obtained is the same as (23), and that's why equation (23) can be excluded from this system.

From (1, 6), we find:

$$\frac{j_r(r)}{r} + j'_r(r) + \alpha \frac{j_\varphi(r)}{r} = -\frac{\chi^2}{\alpha} r \cdot j_\varphi(r). \quad (35)$$

From (8), we find:

$$j_r(r) = -\frac{1}{\alpha} (j_\varphi(r) + r \cdot j'_\varphi(r)), \quad (36)$$

$$j'_r(r) = -\frac{1}{\alpha} (2j'_\varphi(r) + r \cdot j''_\varphi(r)). \quad (37)$$

From (35, 36, 37), we find:

$$-\frac{1}{\alpha} \left(\frac{j_\varphi(r)}{r} + j'_\varphi(r) \right) - \frac{1}{\alpha} (2j'_\varphi(r) + r \cdot j''_\varphi(r)) + \alpha \frac{j_\varphi(r)}{r} = -\frac{\chi^2}{\alpha} r \cdot j_\varphi(r). \quad (38)$$

The solution and analysis of it are described in Appendix 2. The solution therein has no analytical form. Let's designate this solution as function

$$j_\varphi(r) = \text{kh}(\alpha, \chi, r) \quad (39)$$

and derivative of this function - as function

$$j'_\varphi(r) = \text{kh1}(\alpha, \chi, r). \quad (40)$$

From (40) it follows

$$j_z(r) = r \cdot j_\varphi(r) \frac{\chi}{\alpha}. \quad (44)$$

From (8) it follows

$$j_r(r) = -\frac{1}{\alpha} (j_\varphi(r) + r \cdot j'_\varphi(r)). \quad (45)$$

From (44, 45) it follows

$$j'_z(r) \alpha = \frac{\chi}{\alpha} (j_\varphi(r) + r \cdot j'_\varphi(r)) = -\chi \cdot j_r(r), \quad (46)$$

which is the same as (7).

From (45) it follows

$$j'_r(r) = -\frac{1}{\alpha} (2j'_\varphi(r) + r \cdot j''_\varphi(r)). \quad (47)$$

At last, from (24, 25) it follows

$$h_\varphi(r) = -j_r(r) / \chi, \quad (48)$$

$$h_r(r) = -j_\varphi(r) / \chi. \quad (49)$$

So, with the obtained solution all 8 equations become identities. Accuracy of these identities is analyzed in Appendix 3.

Appendix 2.

Consider the equation (38) of Appendix 1:

$$-\frac{1}{\alpha} \left(\frac{j_\varphi(r)}{r} + j'_\varphi(r) \right) - \frac{1}{\alpha} (2j'_\varphi(r) + r \cdot j''_\varphi(r)) + \alpha \frac{j_\varphi(r)}{r} = -\frac{\chi^2}{\alpha} r \cdot j_\varphi(r). \quad (1)$$

To simplify it, we get:

$$\begin{aligned} & - \left(\frac{j_\varphi(r)}{r} + j'_\varphi(r) \right) - (2j'_\varphi(r) + r \cdot j''_\varphi(r)) + \alpha^2 \frac{j_\varphi(r)}{r} = -\chi^2 r \cdot j_\varphi(r), \\ & j_\varphi(r) \left(\frac{\alpha^2 - 1}{r} + \chi^2 r \right) - 3j'_\varphi(r) - r \cdot j''_\varphi(r) = 0. \end{aligned} \quad (2)$$

or

$$j_\varphi(r) (\alpha^2 - 1 + \chi^2 r^2) - 3r \cdot j'_\varphi(r) - r^2 j''_\varphi(r) = 0. \quad (3)$$

Equation (4) has two solutions in the following form

$$(\alpha^2 - 1)y(r) - 3r \cdot y'(r) - r^2 y''(r) = 0. \quad (4)$$

$$\chi^2 r^2 z(r) - 3r \cdot z'(r) - r^2 z''(r) = 0. \quad (5)$$

where

$$j_\varphi(r) = y(r) + z(r). \quad (6)$$

Уравнение (4) имеет решение вида

$$y(r) = b \cdot r^{\alpha-1}, \quad (7)$$

где b – некоторая константа. Действительно, после подстановки (7) в (4) получаем:

$$(\alpha^2 - 1)b \cdot r^{\alpha-1} - 3r \cdot b(\alpha - 1)r^{\alpha-2} - r^2 b(\alpha - 1)(\alpha - 2)r^{\alpha-3} = 0$$

or

$$(\alpha^2 - 1) - 3(\alpha - 1) - (\alpha - 1)(\alpha - 2) = 0$$

or

$$(\alpha + 1) - 3 - (\alpha - 2) = 0$$

or $0=0$, which is what had to be proved.

Equation (5) does not have an analytical solution. Let's consider a numerical solution of this equation having transformed it to the following form

$$z''(r) = \chi^2 z(r) - \frac{3}{r} z'(r). \quad (8)$$

The solution of equation (6) we will write as the following function

$$j_\varphi(r) = kh(\alpha, \chi, r) \quad (9)$$

$$j'_\varphi(r) = kh1(\alpha, \chi, r) \quad (10)$$

$$j''_\varphi(r) = kh2(\alpha, \chi, r) \quad (11)$$

Example 1. Let's find $z(r)$ as a solution of equation (8) with $\chi = 50$ on radius $R = 0.1$ and with initial value $z_0 = z(0) = -30$, and then calculate function (7) at $\alpha = 1.5$, $b = 500$. Fig. 1 shows functions z , z' , z'' , y and resultant function $(z + y)$ - see (6).

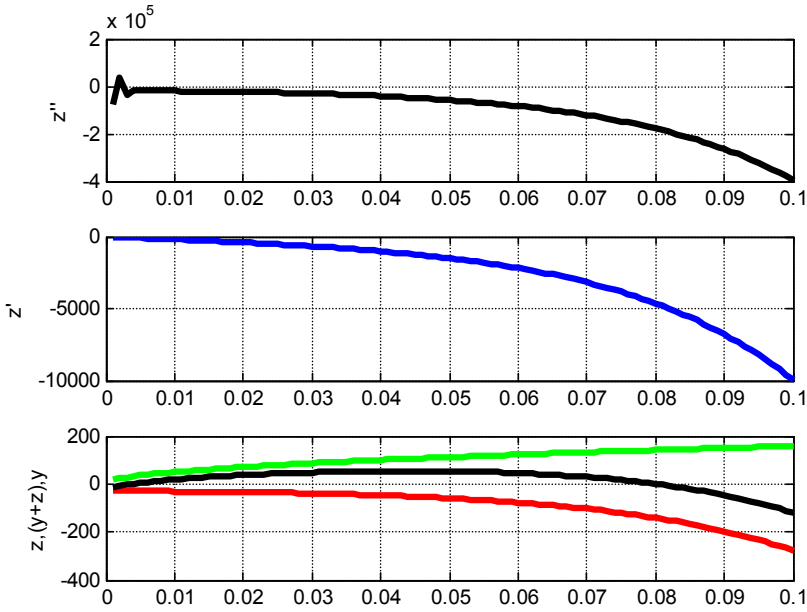
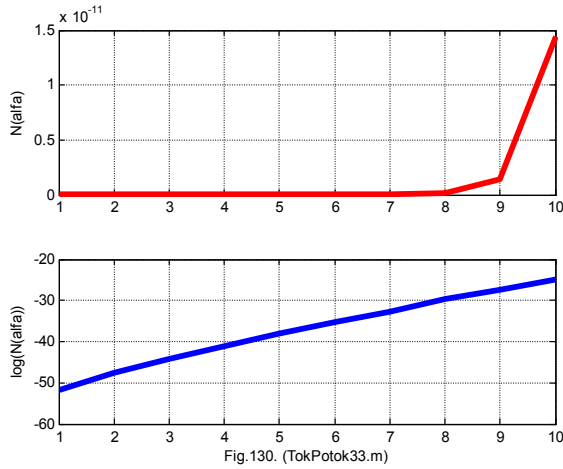
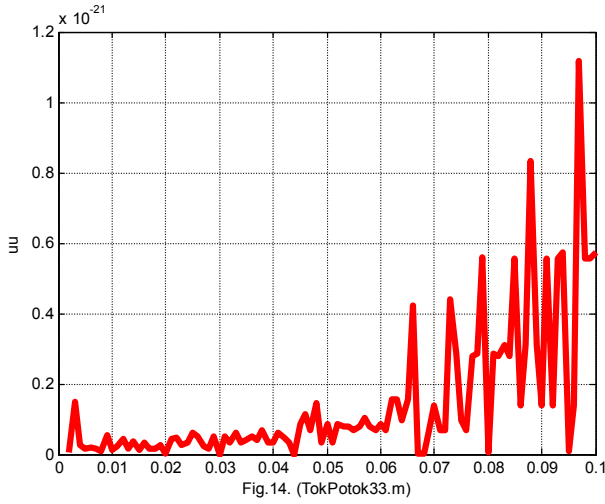

Fig.13 (FforFig13.m)

Appendix 3.

Hereinafter, the equations are numbered according to Appendix 1. Let's consider accuracy of the solution of system (1-8). Substituting functions (41-49) in equations (1-8) we can calculate standard residual error of these equations. Fig. 14 illustrates a graph of these residual error when $(\alpha = 1.5, \chi = 50)$ on radius $R = 0.1$.

The standard residual error of these equations can be found as a function of a certain parameter. Fig. 130 illustrates a graph of the residual error as a function of α when $\chi = 50$ on radius $R = 0.1$. Here, the upper window shows the value of residual error, and the lower window - logarithmic value of residual error.



Appendix 4.

First, we find the following values:

$$\begin{aligned}
 A_1 &= \int_{z=0}^{z_0} \cos\left(\frac{\alpha\varphi_0}{2} + \chi z\right) dz = \frac{1}{\chi} \Big|_{z=0}^{z_0} \sin\left(\frac{\alpha\varphi_0}{2} + \chi z\right) = \\
 &= \frac{1}{\chi} \left(\sin\left(\frac{\alpha\varphi_0}{2} + \chi z_0\right) - \sin\left(\frac{\alpha\varphi_0}{2}\right) \right) = \frac{1}{\chi} \cos\left(\frac{\alpha\varphi_0}{2} + \chi z_0\right) \sin(\chi z_0)
 \end{aligned} \tag{1}$$

$$A_2 = \int_{z=0}^{z_0} \sin(\alpha\varphi_0 + 2\chi z) dz = -\frac{1}{2\chi} \Big|_{z=0}^{z_0} \cos(\alpha\varphi_0 + 2\chi z) =$$

$$= -\frac{1}{2\chi} (\cos(\alpha\varphi_0 + 2\chi z_0) - \cos(\alpha\varphi_0)) = -\frac{1}{\chi} \sin(\alpha\varphi_0 + \chi z_0) \sin(\chi z_0) \quad (2)$$

$$A_3 = \int_{z=0}^{z_0} \cos(\alpha\varphi_0 + 2\chi z) dz = \frac{1}{2\chi} \Big|_{z=0}^{z_0} \sin(\alpha\varphi_0 + 2\chi z) =$$

$$= \frac{1}{2\chi} (\sin(\alpha\varphi_0 + 2\chi z_0) - \sin(\alpha\varphi_0)) = \frac{1}{\chi} \cos(\alpha\varphi_0 + \chi z_0) \sin(\chi z_0) \quad (3)$$

We shall find double integrals:

$$D_1 = \int_{z=0}^{z_0} \left(\int_{\varphi=0}^{\varphi_0} \cos(\alpha\varphi + \chi z) d\varphi \right) dz = \int_{z=0}^{z_0} \left(\frac{1}{2\alpha} \sin(\alpha\varphi + \chi z) \Big|_{\varphi=0}^{\varphi_0} \right) dz =$$

$$= \int_{z=0}^{z_0} \left(\frac{1}{2\alpha} (\sin(\alpha\varphi_0 + \chi z) - \sin(\chi z)) \right) dz = \frac{2}{\alpha} \int_{z=0}^{z_0} \left(\cos\left(\frac{\alpha\varphi_0}{2} + \chi z\right) \sin\left(\frac{\alpha\varphi_0}{2}\right) \right) dz = (4)$$

$$= \frac{2 \sin(\alpha\varphi_0/2)}{\alpha} \int_{z=0}^{z_0} \left(\cos\left(\frac{\alpha\varphi_0}{2} + \chi z\right) \right) dz = \frac{2A_1}{\alpha} \sin\left(\frac{\alpha\varphi_0}{2}\right)$$

$$D_2 = \int_{z=0}^{z_0} \left(\int_{\varphi=0}^{\varphi_0} \sin(2\alpha\varphi + 2\chi z) d\varphi \right) dz = \int_{z=0}^{z_0} \left(\frac{-1}{2\alpha} \cos(2\alpha\varphi + 2\chi z) \Big|_{\varphi=0}^{\varphi_0} \right) dz =$$

$$= \int_{z=0}^{z_0} \left(\frac{-1}{2\alpha} (\cos(2\alpha\varphi_0 + 2\chi z) - \cos(2\chi z)) \right) dz = \frac{-1}{\alpha} \int_{z=0}^{z_0} ((\sin(\alpha\varphi_0 + 2\chi z) \sin(\alpha\varphi_0)) dz = (5)$$

$$= -\frac{\sin(\alpha\varphi_0)}{\alpha} \int_{z=0}^{z_0} (\sin(\alpha\varphi_0 + 2\chi z)) dz = -\frac{A_2 \sin(\alpha\varphi_0)}{\alpha}$$

$$D_3 = \int_{z=0}^{z_0} \left(\int_{\varphi=0}^{\varphi_0} \sin^2(\alpha\varphi + \chi z) d\varphi \right) dz = \int_{z=0}^{z_0} \left(\frac{\varphi}{2} - \frac{1}{4\alpha} \sin(2\alpha\varphi + 2\chi z) \right) dz =$$

$$= \frac{\varphi_0}{2} - \frac{1}{4\alpha} \int_{z=0}^{z_0} ((\sin(2\alpha\varphi_0 + 2\chi z) - \sin(2\chi z))) dz =$$

$$= \frac{\varphi_0}{2} - \frac{1}{2\alpha} \int_{z=0}^{z_0} (\cos(\alpha\varphi_0 + 2\chi z) \sin(\alpha\varphi_0)) dz =$$

$$= \frac{\varphi_0}{2} - \frac{\sin(\alpha\varphi_0)}{2\alpha} \int_{z=0}^{z_0} (\cos(\alpha\varphi_0 + 2\chi z)) dz = \frac{\varphi_0}{2} - \frac{A_3 \sin(\alpha\varphi_0)}{2\alpha} \quad (6)$$

When φ_o , z_o are given, we can evaluate parameters C, D. From (1-3) it follows that mean modulus values of parameters A are as follows:

$$\tilde{A} \approx \frac{1}{\chi}. \quad (7)$$

From (4-7) we can evaluate parameter D:

$$\tilde{D}_1 \approx \frac{2\tilde{A}_1 \sin(\alpha\varphi_o/2)}{\alpha} \approx \frac{2}{\alpha\chi}. \quad (8)$$

$$\tilde{D}_2 \approx \frac{\tilde{A}_2 \sin(\alpha\varphi_o)}{\alpha} \approx \frac{1}{\alpha\chi}. \quad (9)$$

$$\tilde{D}_3 \approx \frac{\varphi_o}{2} - \frac{\tilde{A}_3 \sin(\alpha\varphi_o)}{2\alpha} \approx \frac{\varphi_o}{2} - \frac{1}{2\alpha\chi}. \quad (10)$$

Suppose

$$\varphi_o = 2\pi b, \quad (11)$$

where b - the number of turns of the helical trajectory. Then

$$\tilde{D}_3 \approx \pi b - \frac{1}{2\alpha\chi}. \quad (12)$$

Chapter 5a. Solution of Maxwell's Equations for Wire with Direct Ring Current

Contents

1. Introduction
2. Mathematical model
3. Energy fluxes

1. Introduction

In Chapter 5 we considered the solution of Maxwell's Equations for a wire with direct current, which is produced by the external source and directed along the wire axis. Below we will consider the case with another direct current in the same wire, which is also produced by the external source, but circumferentially directed, so called ring current. For example, solenoid winding can be represented as solid ring cylinder with circumferential current in it. Further on, the conclusions of this Chapter will be used for explanation of operating principle of Milroy motor.

2. Mathematical model

In Chapter 5 we considered the solution of Maxwell's equations for a wire with direct current of density J_{oz} . Density of this current is equal throughout the entire cross-section of the wire. In this case Maxwell's equations can be written as follows:

$$\text{rot}(J) = 0, \tag{a}$$

$$\text{rot}(H) - J = 0, \tag{b}$$

$$\text{div}(J) = 0, \tag{c}$$

$$\text{div}(H) = 0, \tag{d}$$

and current density J_{oz} is not included into equations (a, c), because all the derivatives of this current equal zero.

It was shown that complete solution of Maxwell's equations in this case was consisted of two parts:

- 1) known equation in the following form:

$$H_{o\varphi} = J_{oz} r, \tag{1}$$

2) the following equations obtained in Chapter 5:

$$co = -\cos(\alpha\varphi + \chi z), \quad (2)$$

$$si = \sin(\alpha\varphi + \chi z), \quad (3)$$

$$J_r = j_r(r)co, \quad (4)$$

$$J_\varphi = j_\varphi(r)si, \quad (5)$$

$$J_z = j_z(r)si, \quad (6)$$

$$H_r = h_r(r)co, \quad (7)$$

$$H_\varphi = h_\varphi(r)si, \quad (8)$$

$$H_z = h_z(r)si, \quad (9)$$

$$j_\varphi(r) = kh(\alpha, \chi, r), \quad (10)$$

$$j_r(r) = -\frac{1}{\alpha}(j_\varphi(r) + r \cdot j_\varphi'(r)), \quad (11)$$

$$j_z(r)\alpha = r \cdot j_\varphi(r) \frac{\chi}{\alpha}, \quad (12)$$

$$h_z(r) \equiv 0, \quad (13)$$

$$h_\varphi(r) = -j_r(r) / \chi, \quad (14)$$

$$h_r(r) = -j_\varphi(r) / \chi. \quad (15)$$

Currents and intensities determined by these equations do not formally depend on given current J_{oz} , but they determine energy flux transmitted through the wire, i.e. that power, which is produced by the current in the load.

Below we will consider the case with another direct current in the same wire, which is directed circumferentially - a ring current. For example, solenoid winding can be represented as solid ring cylinder with circumferential current in it. Let's designate density of this given current as $J_{o\varphi}(r)$. Similar to the case of a given current J_{oz} , the complete solution of Maxwell's Equations (a, d) in this case will consist of two parts:

1) known equation in the following form:

$$\frac{\partial H_r}{\partial z} - \frac{\partial H_z}{\partial r} = J_\varphi, \quad (16)$$

2) equations (2-15).

From (16), as $J_{o\varphi}(r)$ does not depend on z , it follows that

$$H_{z0}(r) = J_\varphi(r)dr \quad (17)$$

or

$$H_{zo}(r) = \frac{1}{L} \int_r^R J_{\varphi\varphi}(r) dr, \quad (18)$$

where L , R - length and radius of the wire, respectively.

In Appendix 1 of Chapter 5 it's shown that a solution of system (2-15) **exists**. It can be written in the following form:

$$j_{\varphi}(r) = kh(\alpha, \chi, r), \quad (25)$$

$$j_r(r) = -(j_{\varphi}(r) + r \cdot j'_{\varphi}(r)) / \alpha, \quad (26)$$

$$j_z(r)\alpha = r \cdot j_{\varphi}(r) \frac{\chi}{\alpha}, \quad (27)$$

$$h_z(r) \equiv 0, \quad (28)$$

$$h_{\varphi}(r) = -j_r(r) / \chi, \quad (29)$$

$$h_r(r) = -j_{\varphi}(r) / \chi. \quad (30)$$

3. Energy fluxes

Electromagnetic flux density is determined in the same way as described in Chapter 5, i.e.

$$S = \begin{bmatrix} S_r \\ S_{\varphi} \\ S_z \end{bmatrix} = \rho(J \times H) = \rho \begin{bmatrix} J_{\varphi}H_z - J_zH_{\varphi} \\ J_zH_r - J_rH_z \\ J_rH_{\varphi} - J_{\varphi}H_r \end{bmatrix}. \quad (12)$$

or

$$S = \begin{bmatrix} S_r \\ S_{\varphi} \\ S_z \end{bmatrix} = \rho \iiint_{r,\varphi,z} \begin{bmatrix} (j_{\varphi}h_z - j_zh_{\varphi}) \cdot si^2 \\ (j_zh_r - j_rh_z) \cdot si \cdot co \\ (j_rh_{\varphi} - j_{\varphi}h_r) \cdot si \cdot co \end{bmatrix} dr \cdot d\varphi \cdot dz. \quad (14)$$

Fig. 2.1-2.4 the right-hand column shows the functions

$$\begin{bmatrix} \overline{S_r}(r) \\ \overline{S_{\varphi}}(r) \\ \overline{S_z}(r) \end{bmatrix} = \begin{bmatrix} (j_{\varphi}h_z - j_zh_{\varphi}) \\ (j_zh_r - j_rh_z) \\ (j_rh_{\varphi} - j_{\varphi}h_r) \end{bmatrix}. \quad (15)$$

Taking into account designations (15), from (14) we obtain:

$$S = \begin{bmatrix} S_r \\ S_{\varphi} \\ S_z \end{bmatrix} = \rho \iiint_{r,\varphi,z} \begin{bmatrix} \overline{S_r}(r) \cdot si^2 \\ \overline{S_{\varphi}}(r) \cdot si \cdot co \\ \overline{S_z}(r) \cdot si \cdot co \end{bmatrix} dr \cdot d\varphi \cdot dz. \quad (16)$$

or

$$S = \rho \left(\int_r \begin{bmatrix} \overline{S_r}(r) \\ \overline{S_\phi}(r) \\ \overline{S_z}(r) \end{bmatrix} dr \right) \cdot \left(\iint_{\phi,z} \begin{bmatrix} si^2 \\ si \cdot co \\ si \cdot co \end{bmatrix} d\phi dz \right). \quad (17)$$

Appendix 4 in Chapter 5 contains evaluations of the double integrals from equation (17).

$$\left(\iint_{\phi,z} \begin{bmatrix} si^2 \\ si \cdot co \\ si \cdot co \end{bmatrix} d\phi dz \right) = \begin{bmatrix} D_3 \\ D_2 \\ D_2 \end{bmatrix}, \quad (18)$$

where

$$\tilde{D}_2 \approx \frac{1}{\alpha\chi}, \quad (19)$$

$$\tilde{D}_3 \approx b - 0.5\tilde{D}_2, \quad (20)$$

b – number of helical trajectory per unit length.

Through combining (17, 18) we finally obtain:

$$S = \rho \left(\int_r \begin{bmatrix} \tilde{D}_3 \overline{S_r}(r) \\ \tilde{D}_2 \overline{S_\phi}(r) \\ \tilde{D}_2 \overline{S_z}(r) \end{bmatrix} dr \right). \quad (21)$$

So, fluxes (21) circulate in the wire with ring current. They are internal fluxes. They are produced by currents and magnetic intensities generated by these currents. In turn, these fluxes generate currents in the same way as Lorentz forces. In this case total energy of these fluxes is spent on thermal losses.

Chapter 6. Single-Wire Energy Emission and Transmission

Contents

1. Wire Emission
2. Single-Wire Transmission of Energy
3. Experiments Review

1. Wire Emission

Once again (as in Chapter 2), we deal with an AC low-resistance wire. It incurs radiation loss, though loses no heat. Emission comes from the side surface of the wire. Vector of emission energy flux density is directed along the wire radius and has S value, see 2.4.4 – 2.4.6 in Chapter 2. So,

$$\overline{S}_r = \eta \iint_{r, \varphi} [\mathbf{s}_r \cdot \mathbf{s}^2] dr \cdot d\varphi, \quad (1)$$

where

$$s_r = (e_\varphi h_z - e_z h_\varphi) \quad (2)$$

or, with regard to formulas given in the Table 1 of Chapter 2,

$$s_r = -e_z(R)h_\varphi(R) = -\frac{2\chi R}{\alpha} \sqrt{\frac{\varepsilon}{\mu}} e_\varphi^2(R) = -\frac{2A^2\chi R}{\alpha} \sqrt{\frac{\varepsilon}{\mu}} R^{2\alpha-2}, \quad (3)$$

where R means a wire radius. In addition, consider formula (see (32) in the Appendix 1 of Chapter 2).

$$\chi = \pm \frac{\omega}{c} \sqrt{\varepsilon\mu} \quad \text{или} \quad \chi = \text{sign}(\chi) \cdot \frac{\omega}{c} \sqrt{\varepsilon\mu}, \quad \text{где} \quad \text{sign}(\chi) = \pm 1. \quad (4)$$

Thus, we obtain:

$$\overline{s}_r = -\text{sign}(\chi) \cdot \frac{2A^2\omega\varepsilon}{\alpha c} R^{2\alpha-1}, \quad (5)$$

From (1,5) we obtain:

$$\overline{S}_r = -\text{sign}(\chi) \cdot \frac{2A^2\omega\varepsilon}{\alpha c} R^{2\alpha-1} \eta \int_\varphi s^2 d\varphi = -\text{sign}(\chi) \cdot \frac{2A^2\omega\varepsilon}{\alpha c} R^{2\alpha-1} \eta \pi.$$

With additional (1.4.2), we finally obtain:

$$\overline{S}_r = -\text{sign}(\chi) \cdot \frac{A^2\omega\varepsilon}{2\alpha} R^{2\alpha-1}. \quad (6)$$

Obviously, the value must be positive, as emission does exist. By the way, this fact disproves a well-known theory of an energy flux propagating beyond the wire and entering it from the outside.

As value (6) is positive, condition

$$- \text{sign}(\chi) \cdot \text{sign}(\alpha) = 1, \quad (7)$$

must assert, i.e. values $\chi, \cdot \alpha$ must be of opposite sign. In this connection, for later use we take formula of the type

$$\overline{S}_r = \frac{A^2 \omega \varepsilon}{2|\alpha|} R^{2\alpha-1}. \quad (8)$$

The formula calculates the amount of energy flux emitted by the wire of unit length. Correlate this formula with the one (2.4.15) for the density of energy flux flowing along the wire:

$$\overline{S}_z = \frac{A^2 c \sqrt{\varepsilon/\mu} (1 - \cos(4\alpha\pi))}{8\pi\alpha(2\alpha-1)} R^{2\alpha-1}. \quad (9)$$

Consequently,

$$\zeta = \frac{\overline{S}_r}{\overline{S}_z} = \frac{4\pi(2\alpha-1)\omega\sqrt{\varepsilon\mu}}{c \cdot (1 - \cos(4\alpha\pi))}. \quad (10)$$

So, the wire emits a portion of a longitudinal energy flux of

$$\overline{S}_r = \zeta \cdot \overline{S}_z. \quad (11)$$

Let energy flux is \overline{S}_{z0} in the beginning of wire. Energy flux the wire emits along the L length, can be obtained from the following formula

$$\overline{S}_{rL} = \overline{S}_{z0} (1 - \zeta)^L. \quad (12)$$

Energy flux remaining in the wire

$$\overline{S}_{zL} = \overline{S}_{z0} - \overline{S}_{rL} = \overline{S}_{z0} (1 - (1 - \zeta)^L). \quad (13)$$

Thus, we can calculate the length of wire where the flux remains

$$\overline{S}_{zL} = \beta \cdot \overline{S}_{z0}. \quad (14)$$

The length can be found from the expression

$$\beta = (1 - (1 - \zeta)^L),$$

i.e.

$$L = \ln(1 - \beta) / \ln(1 - \zeta). \quad (15)$$

Example 1. With $\alpha = 1.2$, $\varepsilon = 1$, $\mu = 1$, we obtain $\zeta \approx 10\omega/c$. If $\omega = 3 \cdot 10^3$ so will $\zeta \approx 3 \cdot 10 \cdot 10^3 / 3 \cdot 10^{10} = 10^{-6}$. The length of wire that keeps 1% of initial flux makes

$$L = \ln(1 - 0.01) / \ln(1 - \zeta) \approx 9950 \text{ sm.}$$

2. Single-Wire Transmission of Energy

A body of convincing experiments show the transmission of energy along one wire.

1. [29] analyses a transmitting antenna of long wire type that finds its use in amateur short-wave communication. The author says the antenna has “an adequate circular pattern that allows the communication to be established almost in all directions”, whereas in the direction of wire axis “a considerable amplification develops and grows as antenna length increases... As the length of the increases, the main lobe of the pattern tends to approach antenna axis as close as possible. In the process, emission directed towards the main lobe gets stronger”. Both from the fact that long wire emits in all directions and from the previous part it follows that energy flux flows along the wire. It is significant that energy flux exists without any external electrical voltage at the wire tips.



Рис. 1.

2. S.V. Avramenko’s long-known experiment in single-wire transmission of electrical energy, also named Avramenko’s fork. First, it was described in [30] and then in [31] -see Fig.1. [30] reported that the experimental arrangement included a generator 2 up to 100 kWt of power to generate 8 kHz voltage that went to Tesla’s transformer. One tip of the secondary winding was loose, while the other end connected Avramenko’s fork. Avramenko’s fork was a closed circuit that included two series diodes 3 and 4 , whose common point was connected to the wire 1, and a load, with capacitor 5 connected in parallel to it. Several incandescent lamps – resistance 6 (alternative 1) or discharger (alternative

2) formed the load. Open circuit allowed Avramenko to transmit about 1300 Wt of power between the generator and the load. Electrical bulbs glowed brightly. Wire current was very weak, and a thin tungsten wire in the line 1 did not even run hot. That was the main reason why the findings of the Avramenko's experiment were difficult to explain.

On the one hand, the structure offers quite an attractive method of electrical energy transmission, whereas, on the other hand, it apparently violates laws of electrical engineering. Since then, many authors experimented with that structure and offered theories to explain phenomena observed – see e.g. [32-34]. However, no theory has been universally accepted. the wire tips. Here also energy flux exists without any external electrical voltage at the wire tips.

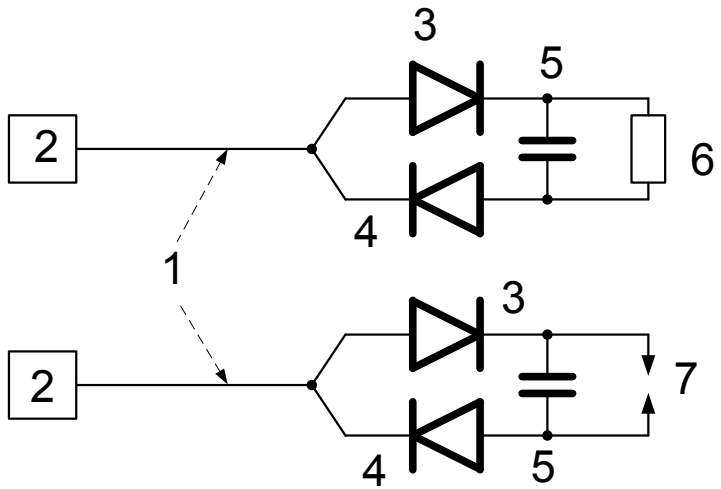
3. Laser beam should also be included in this list. Laser obviously directs energy flux into the laser beam. The energy, that may be rather considerable, incurs almost no loss when transmitted along the laser beam and, on its exit, is converted into the heat energy.

4. Known are experiments by Kosinov [35] that showed the glowing of the burned incandescent lamps. It was reported that *“incandescent lamps burned most often in more than two places, with not only spiral, but current conductors of the lamp burning. With the first circuit break took place, over some time lamps light was even brighter than one produced before burning. The lamps kept glowing until burning of the next portion of the circuit. In this experiment, inner circuit of one lamp burned in as many as four places! Spiral burned in two places, as well as both lead electrodes in the lamp. The lamp went off no sooner than the fourth leg of the circuit burned, i.e. the electrode where the spiral is attached”*. Here, too, energy flux exists with no external electrical voltage at the wire tips. It is significant that burned lamp consumes even more power sufficient to burn the next leg of the spiral.

Consideration of equation for the electromagnetic wave in the wire cannot reveal physical nature of the wave existence: any component of intensity, current and density of energy flux can be seen as an exposure governing all the rest. A longitudinal electrical intensity is accepted to be such an exposure. Facts reported earlier testify possible exceptions, e.g. when exposure is an energy flux at the wire inlet. [19,17] show that energy flux can be viewed as fourth electromagnetic induction.

Thus, inlet energy flux propagates along the wire, and, (almost with no loss, see pp.2.3.4) reaches its distant end. Current can propagate alongside with the energy flux. Yet, this correlation does not need to be

(see pp. 2,3 above). It is significant output energy flux can be rather considerable and make a part of the load. The lack of energy flux –to-current correlation was approached and explained in the Section 2.5.

3. Experiments Review

Return to "long-wire" antenna. It emits in all directions. As is obvious from the Section 1, \overline{S}_r energy flux emitted makes a part of a longitudinal \overline{S}_z energy flux, see (1.11). Their coefficient of proportionality ζ relies, in its turn, on frequency ω - see Example 1. Because of this, reduction of frequency ω drops emission of energy flux \overline{S}_r .

Section 2.5. considered and correlated currents and energy fluxes in the wire. It showed that, generally, currents and energy fluxes inside the wire exist as "jets" of opposite direction. This fits with the existence of active and re-active energy fluxes.

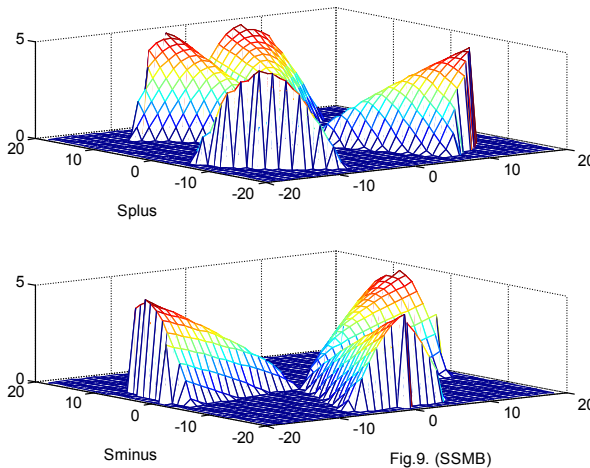

Formation of such "jets" may be assumed in the "long wire". If "long wire" emits all the incoming energy, then one of the fluxes (active power flux) prevails, and the generator wastes its energy to support it. If "long wire" does NOT emit, energy flux flowing in one direction returns the opposite way, the generator SAVES the energy (re-active power flux circulates), and no current forms in the wire. Clearly, there are some intermediate cases when "long wire" emits only a part of energy it receives.

With some combinations of parameters, total currents in opposing jets have are equal in absolute value, and, as well as total energy fluxes of opposing jets. For the sake of reader's convenience, Fig.9 from the Section 4 is replicated above. It shows the functions of the opposing jets:

Splus - energy flux jet directed from the energy source;

Sminus - energy flux jet directed to the energy flux;

For illustration, functions plots are shown with the opposite sign. They obey the following relationships between integrals of sectional area, Q , of the wire:

$$\int_{\varrho} S_{\text{plus}} \cdot dQ = - \int_{\varrho} S_{\text{minus}} \cdot dQ,$$

$$\int_{\varrho} J_{\text{plus}} \cdot dQ = - \int_{\varrho} J_{\text{minus}} \cdot dQ.$$

As follows from experiments (later considered in more details), currents and jets can complete at the broken wire – see Fig.3, where 1 means a wire, 2 means a direct “jet”, 3 means a reverse “jet”, and 4 means a closing circuit. In this case, there arises the question of the nature of electromotive force that makes the current to overcome the spark gap. [19,17] show that energy flux can be viewed as fourth electromagnetic induction.



Рис. 3.

Consider these experiments. Prominent experiments by Kosinov [35] evidently prove the hypothesis offered: the arch that forms at the broken spiral is to have a beginning and an end. Electromotive force should be applied between them. When expanding arch reaches the next leg of the spiral, this leg, together with connecting arch, joins a long line etc. Kosinov observed as many as eight such legs.

Avramenko's fork is a circuit that includes two series diodes and a load – see Fig.1. The circuit forms the arch shown in Fig.3. An air gap of discharger 7 can serve as a load, an equivalent of arch from Kosinov's experiments. Resistor 6 – energy receiver in single-wire energy transmission system – can, too, serve as a load. Wire 1 of this structure can be identified with “long wire”. In this case (at low frequency of 8 kHz) the wire 1 does not emit. Consequently, it carries two opposing energy fluxes but no current.

Which means single-wire energy transmission follows from Maxwell's equations without any contradiction.

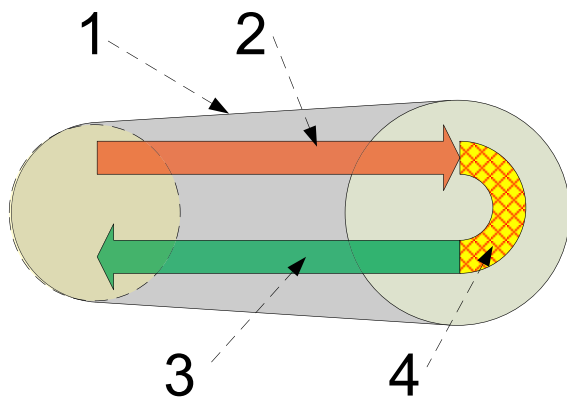
Chapter 7. Solution of Maxwell's equations for a capacitor in constant circuit. Nature of potential energy of capacitor.

Contents

1. Introduction
2. System of Equation Solution
3. Intensities and Energy Flows
4. Discussion

1. Introduction

The electromagnetic field of a capacitor in an alternative current circuit is investigated in [1]. Below the electromagnetic field in a capacitor being charged as well as the field existing in the charged capacitor are examined.

We use the Maxwell equations in the GHS system of unit written in the following form with ε , μ differing from 1:

$$\operatorname{rot}(E) + \frac{\mu}{c} \frac{\partial H}{\partial t} = 0, \quad (\text{a})$$

$$\operatorname{rot}(H) - \frac{\varepsilon}{c} \frac{\partial E}{\partial t} = 0, \quad (\text{b})$$

$$\operatorname{div}(E) = Q(t), \quad (\text{c})$$

$$\operatorname{div}(H) = 0, \quad (\text{d})$$

where

H , E - are the current, the magnetic field strength, and the electric field strength, respectively;

ε , μ - are the dielectric permeability and the magnetic permeability, respectively,

$Q(t)$ - charge on capacitor plate, which appears and accumulates during charging.

This system of partial differential equations has a solution represented by the sum of a particular solution of this system and a general solution of the corresponding homogeneous system of equations. Homogeneous system of equations can be written as follows:

$$\operatorname{rot}(E) + \frac{\mu}{c} \frac{\partial H}{\partial t} = 0, \quad (1)$$

$$\operatorname{rot}(H) - \frac{\varepsilon}{c} \frac{\partial E}{\partial t} = 0, \quad (2)$$

$$\operatorname{div}(E) = 0, \quad (3)$$

$$\operatorname{div}(H) = 0, \quad (4)$$

i.e. it differs from the system (a-d) by the absence of term $Q(t)$. Particular solution with given t is a solution, which associates electric intensity $E_z(t)$ between the capacitor plates with electric charge $Q(t)$. If $E_z(t)$ varies with time, then a solution of the system of equations (1-4) shall exist at given $E_z(t)$. Exactly this solution we're going to seek further on.

Electromagnetic wave propagation in charging capacitor is shown, and mathematical description of this wave is proved to be a solution of Maxwell's equations (1-4). It was shown that a charged capacitor accommodates a stationary flux of electromagnetic energy, and the energy contained in the capacitor, which was considered to be electric potential energy, is, indeed, electromagnetic energy stored in the capacitor in the form of the stationary flux.

2. System of Equation Solution

Let us consider a solution to the Maxwell equations (1.1-1.4). In the cylindrical coordinate system r, φ, z these equations take the form:

$$\frac{E_r}{r} + \frac{\partial E_r}{\partial r} + \frac{1}{r} \cdot \frac{\partial E_\varphi}{\partial \varphi} + \frac{\partial E_z}{\partial z} = 0, \quad (1)$$

$$\frac{1}{r} \cdot \frac{\partial E_z}{\partial \varphi} - \frac{\partial E_\varphi}{\partial z} = v \frac{dH_r}{dt}, \quad (2)$$

$$\frac{\partial E_r}{\partial z} - \frac{\partial E_z}{\partial r} = v \frac{dH_\varphi}{dt}, \quad (3)$$

$$\frac{E_\varphi}{r} + \frac{\partial E_\varphi}{\partial r} - \frac{1}{r} \cdot \frac{\partial E_r}{\partial \varphi} = v \frac{dH_z}{dt}, \quad (4)$$

$$\frac{H_r}{r} + \frac{\partial H_r}{\partial r} + \frac{1}{r} \cdot \frac{\partial H_\varphi}{\partial \varphi} + \frac{\partial H_z}{\partial z} = 0, \quad (5)$$

$$\frac{1}{r} \cdot \frac{\partial H_z}{\partial \varphi} - \frac{\partial H_\varphi}{\partial z} = q \frac{dE_r}{dt} \quad (6)$$

$$\frac{\partial H_r}{\partial z} - \frac{\partial H_z}{\partial r} = q \frac{dE_\varphi}{dt}, \quad (7)$$

$$\frac{H_\varphi}{r} + \frac{\partial H_\varphi}{\partial r} - \frac{1}{r} \cdot \frac{\partial H_r}{\partial \varphi} = q \frac{dE_z}{dt} \quad (8)$$

where

$$v = -\mu/c, \quad (9)$$

$$q = \varepsilon/c, \quad (10)$$

- E_r, E_φ, E_z are the electric intensities;
- H_r, H_φ, H_z are the magnetic intensities.

The solution shall be found for non-zero intensity E_z .

For brevity, the following abbreviated forms will be used below:

$$co = \cos(\alpha\varphi + \chi z), \quad (11)$$

$$si = \sin(\alpha\varphi + \chi z), \quad (12)$$

where α, χ are constants. Let us write the unknown functions in the following form:

$$H_r = h_r(r)co \cdot (\exp(\omega t) - 1), \quad (13)$$

$$H_\varphi = h_\varphi(r)si \cdot (\exp(\omega t) - 1), \quad (14)$$

$$H_z = h_z(r)si \cdot (\exp(\omega t) - 1), \quad (15)$$

$$E_r = e_r(r)si \cdot (1 - \exp(\omega t)), \quad (16)$$

$$E_\varphi = e_\varphi(r)co \cdot (1 - \exp(\omega t)), \quad (17)$$

$$E_z = e_z(r)co \cdot (1 - \exp(\omega t)), \quad (18)$$

where $h(r), e(r)$ - some functions of coordinate r . Here, the bias current is

$$J_z = \frac{d}{dt} E_z = -\omega \cdot e_z(r)co \cdot \exp(\omega t) \quad (19)$$

Fig. 1 shows these variables as a function of time and their time derivatives for $\omega = -300$: H_z is shown with solid lines, E_z with dashed lines, and J_z with a dotted line. This provides good evidence that in the system of equations (1-8) the amplitudes of all strength components simultaneously approach a constant value and the current amplitude

tends to zero with $t \Rightarrow \infty$. These conditions correspond to the capacitor charging via a fixed resistor.

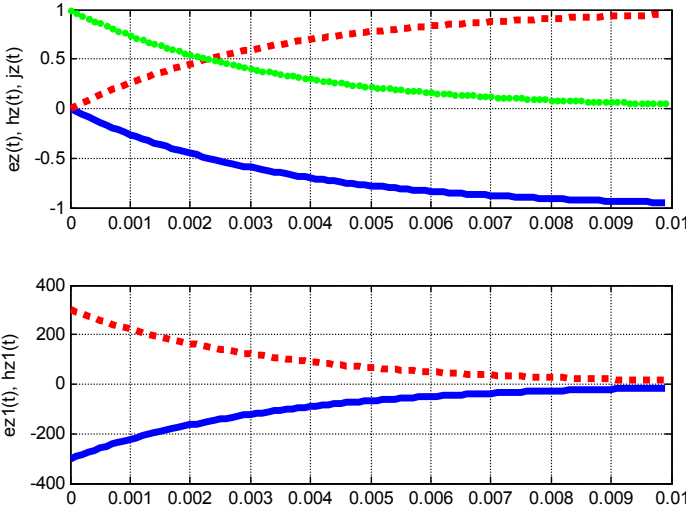

Fig.1. (SSMB6.1)

After the capacitor becomes charged, the current stops to flow. However, as shown below, the stationary flow of electromagnetic energy persists.

Direct substitution of functions (13-18) makes it possible to transform the system of equations (1-8) with four arguments r, φ, z, t into a system of equations with one argument r and unknown functions $h(r), e(r)$. This system of equations has the form:

$$\frac{e_r(r)}{r} + e'_r(r) - \frac{e_\varphi(r)}{r} \alpha - \chi \cdot e_z(r) = 0, \quad (21)$$

$$-\frac{1}{r} \cdot e_z(r) \alpha + e_\varphi(r) \chi - \frac{\mu\omega}{c} h_r = 0, \quad (22)$$

$$e_r(r) \chi - e'_z(r) + \frac{\mu\omega}{c} h_\varphi = 0, \quad (23)$$

$$\frac{e_\varphi(r)}{r} + e'_\varphi(r) - \frac{e_r(r)}{r} \cdot \alpha + \frac{\mu\omega}{c} h_z = 0, \quad (24)$$

$$\frac{h_r(r)}{r} + h'_r(r) + \frac{h_\varphi(r)}{r} \alpha + \chi \cdot h_z(r) = 0, \quad (25)$$

$$\frac{1}{r} \cdot h_z(r) \alpha - h_\varphi(r) \chi - \frac{\varepsilon\omega}{c} e_r = 0, \quad (26)$$

$$-h_r(r) \chi - h'_z(r) + \frac{\varepsilon\omega}{c} e_\varphi = 0, \quad (27)$$

$$\frac{h_\varphi(r)}{r} + h'_\varphi(r) + \frac{h_r(r)}{r} \cdot \alpha + \frac{\varepsilon\omega}{c} e_z(r) = 0. \quad (28)$$

It is identical to the similar system of equations for a capacitor in an alternative current circuit – see chapter 2. The solution of this system is also identical to the solution obtained in chapter 2 and has the following form:

$$e_\varphi(r) = \text{kh}(\alpha, \chi, r), \quad (30)$$

$$e_r(r) = \frac{1}{\alpha} (e_\varphi(r) + r \cdot e'_\varphi(r)), \quad (31)$$

$$e_z(r) = r \cdot e_\varphi(r) \frac{q}{\alpha}, \quad (32)$$

$$h_\varphi(r) = -\frac{\varepsilon\omega}{c} e_r(r) \frac{1}{\chi}, \quad (33)$$

$$h_r(r) = \frac{\varepsilon\omega}{c} e_\varphi(r) \frac{1}{\chi}, \quad (34)$$

$$h_z(r) \equiv 0. \quad (35)$$

where $\text{kh}()$ is the function determined in chapter 2,

$$q = \left(\chi - \frac{\mu\varepsilon\omega^2}{c^2\chi} \right). \quad (36)$$

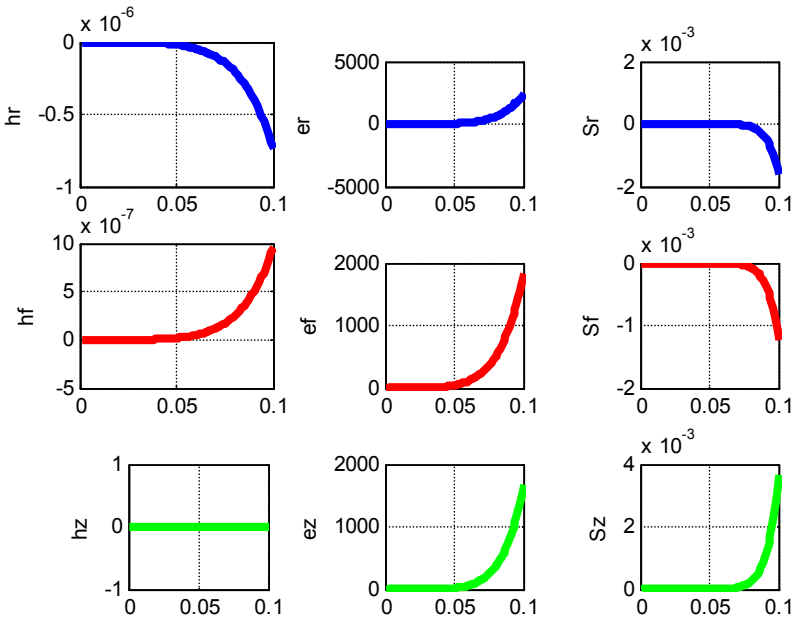

Fig.1. (SSB6(3).m)

Thus, the solution of the Maxwell equations for a capacitor being charged and for a capacitor in a sinusoidal current circuit differs only in that the former includes exponential functions of time and the latter contains sinusoidal time-functions.

3. Intensities and Energy Flows

As in chapter 2, the density of energy flows along the coordinates can be determined by the formula:

$$\bar{S} = \begin{bmatrix} \overline{S_r} \\ \overline{S_\varphi} \\ \overline{S_z} \end{bmatrix} = \eta \iint_{r,\varphi} \begin{bmatrix} s_r \cdot si^2 \\ s_\varphi \cdot si \cdot co \\ s_z \cdot si \cdot co \end{bmatrix} dr \cdot d\varphi. \quad (1)$$

where

$$s_r = (e_\varphi h_z - e_z h_\varphi)$$

$$s_\varphi = (e_z h_r - e_r h_z), \quad (2)$$

$$s_z = (e_r h_\varphi - e_\varphi h_r)$$

$$\eta = c/4\pi. \quad (3)$$

Let us consider functions (2) and $e_r(r)$, $e_\varphi(r)$, $e_z(r)$, $h_r(r)$, $h_\varphi(r)$, $h_z(r)$. Fig. 2 shows, for example, these functions plotted for $A=1$, $\alpha=5.5$, $\mu=1$, $\varepsilon=2$, $\chi=50$, $\omega=300$. The conditions of this example differ from conditions of a similar example in chapter 2 for a capacitor in an alternative current circuit only in the value of parameter ω which is equal to $\omega=-300$ in this paper ($\omega=300$ in chapter 2). It is evident that these functions differ only in sign.

It must be emphasized once again that these functions are not zero at any time moment, i.e. after charging of the capacitor the electric and magnetic intensities remain and take stationary, but non-zero values. Only magnetic intensity $H_z(r) \equiv 0$ permanently equals zero, and when charging is completed, offset current interrupts.

The stationary electromagnetic energy flow is also retained. Its existence does not contradict our physical understanding [3]. The presence of this flow in a static system was studied by Feynman [13]. He provides an example of an energy flow in a system consisting of an electric charge and a permanent magnet which are fixed and closely spaced.

Other experiments [38] demonstrating this effect are also available. Fig. 2 shows an electromagnet which retains its attractive force after the current is switched off. Edward Leedskalnin is assumed to use such electromagnets in constructing the famous Coral Castle, see Fig. 3 [38]. In these electromagnets (or solenoids), the electromagnetic energy is not zero at the instant the current is switched off. This energy can be dissipated by radiation and heat loss. However, if these factors are not significant (at least at the initial phase), the electromagnetic energy must be conserved. With electromagnetic oscillations, the electromagnetic energy flow must be induced and propagate WITHIN the solenoid structure. This flow can be interrupted by destructing the structure. In this case, according to the energy conservation law, the work should be done equal to the electromagnetic energy which dissipates on destruction of the solenoid structure. This means that a "destructor" should overcome a force. It is this fact that is demonstrated in the above-specified experiments. Mathematical models of similar solenoid structures based on the Maxwell equations are examined in [39]. The conditions are identified which are to be met to maintain the electromagnetic energy flow for an unlimited time period.



Рис. 2.



Рис. 3.

Thus, a stationary electromagnetic energy flow is formed in a capacitor. Let us consider the structure of this flow in more details. From (2.11, 2.12, 3.1) it follows that at each point in the dielectric the components of energy flows can be determined using the formula:

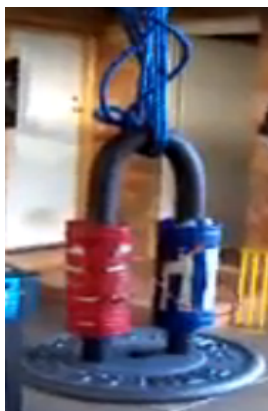
$$S = \begin{bmatrix} S_r \\ S_\varphi \\ S_z \end{bmatrix} = \begin{bmatrix} s_r \cdot si^2 \\ s_\varphi \cdot si \cdot co \\ s_z \cdot si \cdot co \end{bmatrix} = \begin{bmatrix} s_r \cdot \sin^2(\alpha\varphi + \chi z) \\ s_\varphi \cdot 0.5 \sin(2(\alpha\varphi + \chi z)) \\ s_z \cdot 0.5 \sin(2(\alpha\varphi + \chi z)) \end{bmatrix}. \quad (4)$$

where, as it follows from (2.30-2.35, 3.2),

$$\begin{aligned}
 s_r &= (-e_z h_\varphi) = \frac{q}{\alpha} \frac{\varepsilon \omega}{\chi c} r \cdot e_\varphi(r) \cdot e_r(r) \\
 s_\varphi &= (e_z h_r) = \frac{q}{\alpha} \frac{\varepsilon \omega}{\chi c} r \cdot e_\varphi^2(r) \\
 s_z &= (e_r h_\varphi - e_\varphi h_r) = -\frac{\varepsilon \omega}{\chi c} (e_r^2(r) + e_\varphi^2(r))
 \end{aligned}
 \tag{5}$$

For example, let us consider a development of a cylinder with a given radius r . At the circle of this radius vector S always points in the direction of a radius increase and oscillates in value as $\sin^2(\alpha\varphi + \chi z)$. The total vector $(S_\varphi + S_z)$ is always at an angle of $\arctg(s_z/s_\varphi)$ to the radius line and its value oscillated as $\sin(2(\alpha\varphi + \chi z))$. Fig. 4 shows the vector field $(S_\varphi + S_z)$ for $\alpha = 1.35$, $\chi = 50$. Here, the horizontal line and the vertical line correspond to coordinates φ , z

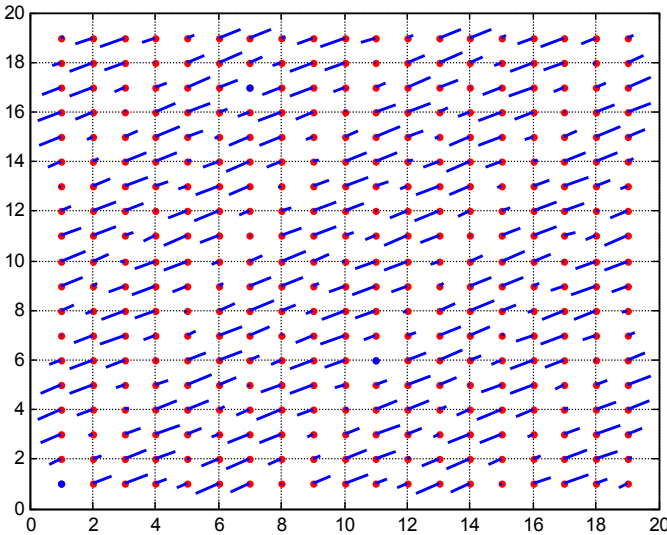

Fig.4. (SSMB.88)

4. Discussion

It is demonstrated that an electromagnetic wave propagates through a capacitor as it is being charged, and the mathematical description of this wave is a solution of the Maxwell equations. In this case, in the dielectric body (i.e. where the field intensities e_z does exist)

the electric and the magnetic field intensities components exist. There are also present:

- the circumferential energy flow S_ϕ , which changes its sign depending on ϕ ,
- the vertical energy flow S_z , which changes its sign depending on ϕ ,
- the radial energy flow S_r , always directed from the center. This means that the charged capacitor radiates via the side surface.

The energy flow still persists in the charged capacitor as a stationary electromagnetic energy flow. It is this flow where the electromagnetic energy stored in the capacitor circulates. Hence, the energy which is contained in the capacitor and which is considered to be the electrical potential energy, is the electromagnetic energy stored in the capacitor in the form of the stationary flow.

There are experiments exist for detection of magnetic field between charged plates of a capacitor using a compass [49, 50]. According to the above, in a round capacitor the compass needle shall deflect perpendicularly to capacitor radius. The observed deflection of the compass needle from capacitor axis can be explained by non-uniform charge distribution over the square plate.

Chapter 7a. Solution of Maxwell's equations around the end of a magnet

Above we consider a capacitor with electric charge, where an electric intensity exist between its plates.

Let's now consider **a gap in an annular magnet**. There is a magnetic intensity between the planes forming this gap.

Due to the symmetry of Maxwell's equations, an electromagnetic field shall exist in the "gap" of a magnet, similar to the electric field in the gap of a charged capacitor. The difference between these fields is that in the field equations electric and magnetic components of intensity change places. In particular, in a charged round capacitor an electric intensity ($E_z \neq 0$) exists, and there is no magnetic intensity ($H_z = 0$). In non-charged capacitor with a magnet a magnetic intensity exists ($H_z \neq 0$), and there is no electric intensity ($E_z = 0$).

Similar to (7.2.30-7.2.35) we obtain:

$$h_\varphi(r) = kh(\alpha, \chi, r), \quad (1)$$

$$h_r(r) = \frac{1}{\alpha} (h_\varphi(r) + r \cdot h'_\varphi(r)), \quad (2)$$

$$h_z(r) = r \cdot h_\varphi(r) \frac{q}{\alpha}, \quad (3)$$

$$e_\varphi(r) = -\frac{\mu\omega}{c} h_r(r) \frac{1}{\chi}, \quad (4)$$

$$e_r(r) = \frac{\mu\omega}{c} h_\varphi(r) \frac{1}{\chi}, \quad (5)$$

$$e_z(r) \equiv 0. \quad (6)$$

Here, the same as in capacitor, parameter ω is included into exponential factor $\exp(\omega t)$, which characterizes the process of magnetizing permanent magnet during its formation ("charging" – similar to capacitor)

Thus, the electric and magnetic intensities exist in the gap of our magnet (i.e. where intensity h_z exists).

При существовании этих напряженностей in the gap of our magnet формируется стационарный поток электромагнитной энергии. Напомним формулу (7.3.4), которая в данном случае определяет проекции потоков энергии определяются по формуле:

$$S = \begin{bmatrix} S_r \\ S_\varphi \\ S_z \end{bmatrix} = \begin{bmatrix} s_r \cdot si^2 \\ s_\varphi \cdot si \cdot co \\ s_z \cdot si \cdot co \end{bmatrix} = \begin{bmatrix} s_r \cdot \sin^2(\alpha\varphi + \chi z) \\ s_\varphi \cdot 0.5 \sin(2(\alpha\varphi + \chi z)) \\ s_z \cdot 0.5 \sin(2(\alpha\varphi + \chi z)) \end{bmatrix}. \quad (7)$$

where, as it follows from (1-6, 7.3.2),

$$\begin{aligned} s_r &= (h_z e_\varphi) = \frac{q}{\alpha} \frac{\mu\omega}{\chi c} r \cdot h_\varphi(r) \cdot h_r(r) \\ s_\varphi &= (-e_r h_z) = \frac{q}{\alpha} \frac{\mu\omega}{\chi c} r \cdot h_\varphi^2(r) \\ s_z &= (e_r h_\varphi - e_\varphi h_r) = -\frac{\mu\omega}{\chi c} (h_r^2(r) + h_\varphi^2(r)) \end{aligned} \quad (8)$$

Отсюда следует, что существуют

- the circumferential energy flow S_φ , which changes its sign depending on φ ,
- the vertical energy flow S_z , which changes its sign depending on φ ,
- the radial energy flow S_r , always directed from the center.

As it was shown in Section 1.5, together with these energy flows the momentums directed along the radius, circumferentially and along the axis also exist within the electromagnetic wave. There are also the angular momentums about any radius, any circle and about the axis.

Obviously, these conclusions do not depend on the gap length. Therefore, we can say that

energy flows, momentums and angular momentums exist around the end of a magnet.

As it was shown in (1.5.6), angular momentum about the axis of the magnet in this point of the "gap" (r, φ, z)

$$L_z(r, \varphi, z) = S_z r / c \quad (9)$$

or, taking (7, 8) into account,

$$L_z(r, \varphi, z) = S_z \frac{r}{c} = \frac{r S_z}{2c} \cdot \sin(2(\alpha\varphi + \chi z)) =$$

$$= -\frac{\mu\omega r}{2\chi c^2} (h_r^2(r) + h_\varphi^2(r)) \sin(2(\alpha\varphi + \chi z)) \quad (10)$$

where $h_r(r)$, $h_\varphi(r)$ are determined by (1, 2). Total angular momentum along the entire circle of a given radius and at a given distance from the end

$$L_{zr} = \int_0^{2\pi} L_z(r, \varphi, z) d\varphi = -\frac{\mu\omega r}{2\chi c^2} (h_r^2(r) + h_\varphi^2(r)) \int_0^{2\pi} \sin(2(\alpha\varphi + \chi z)) d\varphi. \quad (11)$$

Here all the parameters can be found experimentally, and they are currently unknown. However, it can be said that at non-integer α $L_{zr} \neq 0$ always exists.

Appendix

The existence of the angular momentum in magnet could be confirmed experimentally. But the necessary facilities are not available for the author. That's why we offer to consider the experiments, which (**probably!**) demonstrate the existence of angular momentum in magnet.

1. The experiment widely known in the Internet, is shown in Fig. 1, where

- M - magnet with induction B,
- K - iron ring with a gap V (which is required in order to exclude the assumption of current in the ring),
- N – thread,
- L, D, A, C, d – dimensions.

When the ring is lowered, at a certain position it starts to rotate fast and rotates for some time T, then it stops and starts to rotate in the opposite direction. This rotation lasts for a time $t \ll T$. Rotations with alternating direction repeat 3-5 times and then stop.

The author carried out this experiment as follows:

- Variant 1: B = 1 Tesla, T = 30 sec,
(L, D, A, C, d) = (200, 15, 10, 15, d) mm;
- Variant 2: B = 1 Tesla, T = 20 sec,
(L, D, A, C, d) = (200, 20, 05, 15, d) mm.

This experiment can be explained by the existence of a torque, which in the steady state is equilibrated by the torque of the thread. In another way this experiment is explained by changing of the thread

torque, when it is pulled due to attraction of the ring K to the magnet M. This explanation seems to be unconvincing, when doing the experiment yourself.

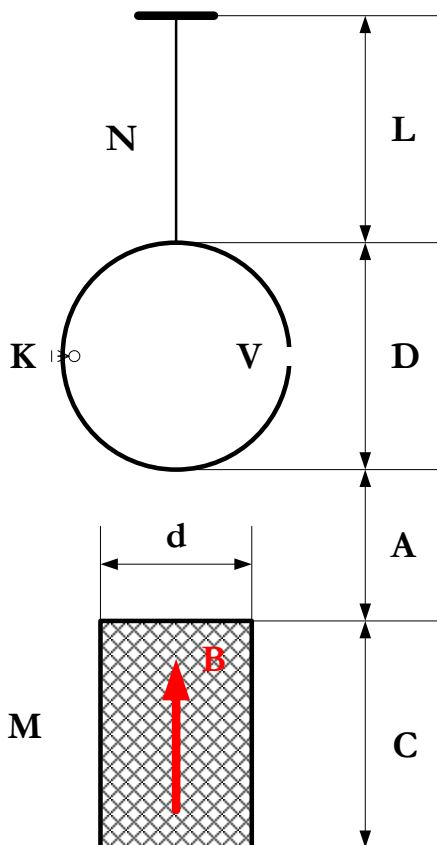

Fig. 1.

2. In the Internet [46] another experiment is demonstrated — see Fig. 2, where

- M - magnet,
- K – magnet in the shape of an iron ring,
- S – wooden rod,
- S - holder of the rod S.

The ring K is held at a certain distance from the end of the magnet M and rotates on the wooden rod S. The idea of this experiment can be used for precise experimental proof of existence of the angular momentum about the axis of a magnet.

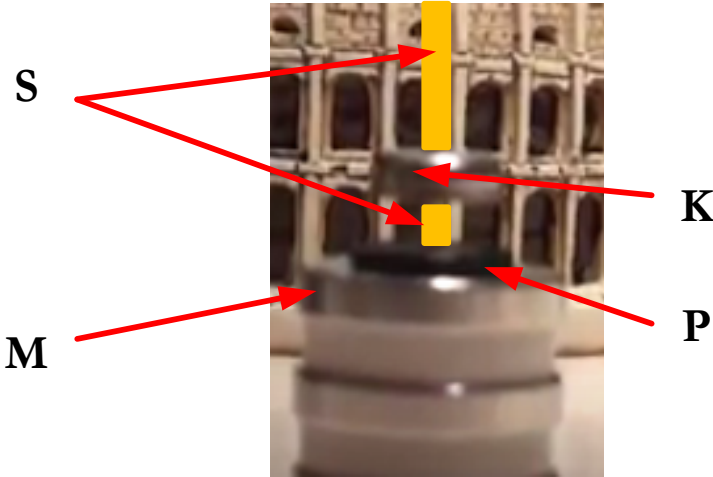

Fig. 2.

3. In the Internet [47] the one can find another experiment which is easy to repeat. Two annular magnets are hung at a hook on a long thread — see Fig. 3.1. In the first case the magnets are attached one to the other by flat surfaces of the ring (see Fig. 3.2), and in the second case – touch one another with external cylindrical surfaces. In the first case the structure is showing no motion, and in the second case it is rotating. As the weight of the structure does not change, then influence of the thread is excluded.



Рис. 3.1.



Рис. 3.2.



Рис. 3.3.

4. Known on the Internet and experiment as a particular case of experiments 1 and 3, but with solid rectangular magnet instead of the lower annular magnet – see Fig. 4, where designations from Fig.1 are used. The structure was rotating the same way as in experiment 3 [48].

This can be explained by the existence of angular momentum about the axis of the magnet.



Рис. 4.

Two annular magnets in experiment 3 can be considered as two combined structures from Fig. 4:

- the lower ring as a magnet for the upper ring,
- the upper ring as a magnet for the lower ring,

In this case all 4 experiments can be explained by the existence of angular momentum in the magnet.

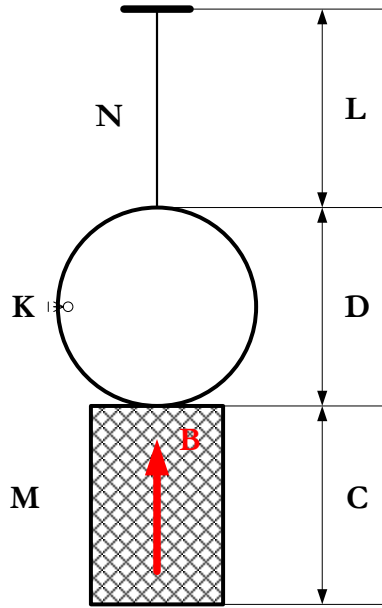
Experiments 1, 3, 4 can be represented by a general scheme – see Fig. 5. A magnet M produces magnetic flux B_1 , directed into a ring K. (The other part of magnetic flux from the magnet M is not considered). This flux is splitting inside the ring K in two fluxes B_2 . Then, the fluxes B_2 are closed by the flux B_3 inside the ring and the flux B_4 outside the ring. Thus,

$$B_1 = 2 \cdot B_2 - B_3, \quad B_4 = 2 \cdot B_2 - B_3, \quad B_1 = B_4,$$

i.e. the flux $B_3 > 0$ exists in any case. This flux, as shown above, has angular momentum.

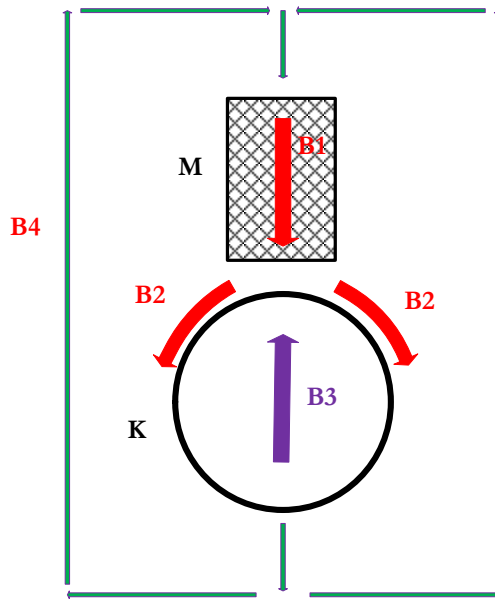

Fig. 5.

Chapter 8. Solution of Maxwell's Equations for Spherical Capacitor

Contents

1. Introduction
 2. Solution of the Maxwell Equations in the Spherical Coordinate System
 3. The solution of Maxwell's equations for the vacuum
 5. Energy fluxes
 6. An Electromagnetic Wave in a Charged Spherical Capacitor
 7. Electromagnetic wave around spherical charge
- Appendix 1. Solution of Maxwell's equations for the medium
Appendix 2. Solution of Maxwell's equations for conductive dielectric

1. Introduction

The electromagnetic wave in a capacitor in an alternating current or constant current circuit is investigated in главах 2 и 7. In this paper, a spherical capacitor in a sinusoidal current circuit or an constant current circuit is considered. The capacitor electrodes are two spheres having the same center and radii $R_2 > R_1$.

2. Solution of the Maxwell Equations in the Spherical Coordinate System

Let us first consider a spherical capacitor in a sinusoidal current circuit. Fig. 1 shows the spherical coordinate system (ρ, θ, φ) . Expressions for the rotor and the divergence of vector \mathbf{E} in these coordinates are given in Table 1 [4]. The following notation is used:

- E - electrical intensities,
- H - magnetic intensities,
- μ - absolute magnetic permeability,
- ε - absolute dielectric constant.

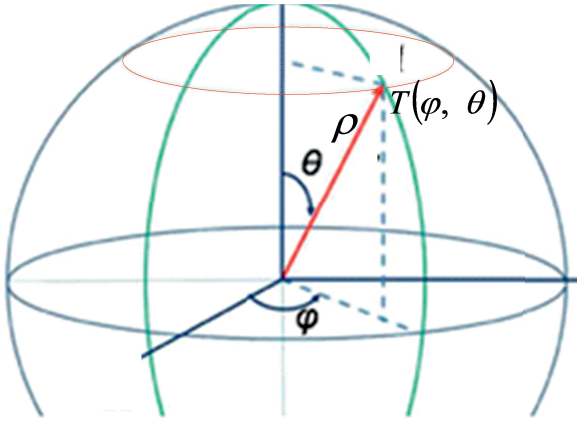

Fig. 1.

Table 1.

1	2	3
1	$\text{rot}_\rho(E)$	$\frac{E_\varphi}{\rho \text{tg}(\theta)} + \frac{\partial E_\varphi}{\rho \partial \theta} - \frac{\partial E_\theta}{\rho \sin(\theta) \partial \varphi}$
2	$\text{rot}_\theta(E)$	$\frac{\partial E_\rho}{\rho \sin(\theta) \partial \varphi} - \frac{E_\varphi}{\rho} - \frac{\partial E_\varphi}{\partial \rho}$
3	$\text{rot}_\varphi(E)$	$\frac{E_\theta}{\rho} + \frac{\partial E_\theta}{\partial \rho} - \frac{\partial E_\rho}{\rho \partial \varphi}$
4	$\text{div}(E)$	$\frac{E_\rho}{\rho} + \frac{\partial E_\rho}{\partial \rho} + \frac{E_\theta}{\rho \text{tg}(\theta)} + \frac{\partial E_\theta}{\rho \partial \theta} + \frac{\partial E_\varphi}{\rho \sin(\theta) \partial \varphi}$

With no charge on and no current between the spherical capacitor electrodes, the Maxwell equations in the spherical coordinate system take the form presented in Table 2.

Table 2.

1	2
1.	$\text{rot}_\rho H - \frac{\varepsilon}{c} \frac{\partial E_\rho}{\partial t} = 0$
2.	$\text{rot}_\theta H - \frac{\varepsilon}{c} \frac{\partial E_\theta}{\partial t} = 0$

3.	$\text{rot}_\varphi H - \frac{\varepsilon}{c} \frac{\partial E_\varphi}{\partial t} = 0$
4.	$\text{rot}_\rho E + \frac{\mu}{c} \frac{\partial H_\rho}{\partial t} = 0$
5.	$\text{rot}_\theta E + \frac{\mu}{c} \frac{\partial H_\theta}{\partial t} = 0$
6.	$\text{rot}_\varphi E + \frac{\mu}{c} \frac{\partial H_\varphi}{\partial t} = 0$
7.	$\text{div}(E) = 0$
8.	$\text{div}(H) = 0$

Below the solution will be sought for in form of functions E , H , which presented in Table. 3, where the functions of the form $E_{\varphi\rho}(\rho)$ to be calculated. It is important to note that

- these functions are independent of the argument φ ;
- if $E(\theta) = \sin(\theta)$, then

$$\frac{E}{\text{tg}(\theta)} + \frac{\partial E}{\partial \theta} = 2 \cos(\theta). \quad (11)$$

Table 3.

1	2
	$E_\rho = E_{\rho\rho}(\rho)\cos(\theta)\sin(\omega t)$
	$E_\theta = E_{\theta\rho}(\rho)\sin(\theta)\sin(\omega t)$
	$E_\varphi = E_{\varphi\rho}(\rho)\sin(\theta)\sin(\omega t)$
	$H_\rho = H_{\rho\rho}(\rho)\cos(\theta)\cos(\omega t)$
	$H_\theta = H_{\theta\rho}(\rho)\sin(\theta)\cos(\omega t)$
	$H_\varphi = H_{\varphi\rho}(\rho)\sin(\theta)\cos(\omega t)$

We substitute the functions E , H from the Table 3 in Table 1 and take into account (11). Then we obtain Table 4.

Table 4.

1	2	3
1	$\text{rot}_\rho(E)$	$\frac{2E_{\varphi\rho}}{\rho} \cos(\theta) \sin(\omega t)$
2	$\text{rot}_\theta(E)$	$-\left(\frac{E_\varphi}{\rho} + \frac{\partial E_\varphi}{\partial \rho}\right) \sin(\theta) \sin(\omega t)$
3	$\text{rot}_\varphi(E)$	$\left(\frac{E_\theta}{\rho} + \frac{\partial E_\theta}{\partial \rho}\right) \sin(\theta) \sin(\omega t)$
4	$\text{div}(E)$	$\left(\left(\frac{E_\rho}{\rho} + \frac{\partial E_\rho}{\partial \rho}\right) + \frac{2E_{\theta\rho}}{\rho}\right) \cos(\theta) \sin(\omega t)$

Expressions for the rotor and divergence function H differ from those shown in the Table. 4 only in that instead of factors $\sin(\omega t)$ are factors $\cos(\omega t)$. Substituting the expression for the curl and divergence in Maxwell's equations (see Table 2), differentiating with respect to time and reducing common factors, we obtain a new form of Maxwell's equations - see Table. 5.

Table 5.

1	2
1	$\frac{2E_{\varphi\rho}}{\rho} - \frac{\omega\mu}{c} H_{\rho\rho} = 0$
2	$-\left(\frac{E_{\varphi\rho}}{\rho} + \frac{\partial E_{\varphi\rho}}{\partial \rho}\right) - \frac{\omega\mu}{c} H_{\theta\rho} = 0$
3	$\left(\frac{E_{\theta\rho}}{\rho} + \frac{\partial E_{\theta\rho}}{\partial \rho}\right) - \frac{\omega\mu}{c} H_{\varphi\rho} = 0$
4	$\left(\left(\frac{E_{\rho\rho}}{\rho} + \frac{\partial E_{\rho\rho}}{\partial \rho}\right) + \frac{2E_{\theta\rho}}{\rho}\right) = 0$
5	$\frac{2H_{\varphi\rho}}{\rho} - \frac{\omega\varepsilon}{c} E_{\rho\rho} = 0$
6	$-\left(\frac{H_{\varphi\rho}}{\rho} + \frac{\partial H_{\varphi\rho}}{\partial \rho}\right) - \frac{\omega\varepsilon}{c} E_{\theta\rho} = 0$

7	$\left(\frac{H_{\theta\rho}}{\rho} + \frac{\partial H_{\theta\rho}}{\partial \rho} \right) - \frac{\omega\varepsilon}{c} E_{\varphi\rho} = 0$
8	$\left(\left(\frac{H_{\rho\rho}}{\rho} + \frac{\partial H_{\rho\rho}}{\partial \rho} \right) + \frac{2H_{\theta\rho}}{\rho} \right) = 0$

3. The solution of Maxwell's equations for the vacuum

First, we consider the equations for a vacuum where in the GHS system we have: $\varepsilon = \mu = 1$. At the same table. 5 takes the following form:

Table 5a.

1	2
1	$\frac{2E_{\varphi\rho}}{\rho} - qH_{\rho\rho} = 0$
2	$-\left(\frac{E_{\varphi\rho}}{\rho} + \frac{\partial E_{\varphi\rho}}{\partial \rho} \right) - qH_{\theta\rho} = 0$
3	$\left(\frac{E_{\theta\rho}}{\rho} + \frac{\partial E_{\theta\rho}}{\partial \rho} \right) - qH_{\varphi\rho} = 0$
4	$\left(\left(\frac{E_{\rho\rho}}{\rho} + \frac{\partial E_{\rho\rho}}{\partial \rho} \right) + \frac{2E_{\theta\rho}}{\rho} \right) = 0$
5	$\frac{2H_{\varphi\rho}}{\rho} - qE_{\rho\rho} = 0$
6	$-\left(\frac{H_{\varphi\rho}}{\rho} + \frac{\partial H_{\varphi\rho}}{\partial \rho} \right) - qE_{\theta\rho} = 0$
7	$\left(\frac{H_{\theta\rho}}{\rho} + \frac{\partial H_{\theta\rho}}{\partial \rho} \right) - qE_{\varphi\rho} = 0$
8	$\left(\left(\frac{H_{\rho\rho}}{\rho} + \frac{\partial H_{\rho\rho}}{\partial \rho} \right) + \frac{2H_{\theta\rho}}{\rho} \right) = 0$

where

$$q = \frac{\omega}{c}. \tag{12}$$

Then Maxwell's equations are completely symmetrical with respect to the intensities E and H . Find the sum pairs of (1-4) and (5-8). Then we get:

$$\frac{2W_{\varphi\rho}}{\rho} - qW_{\rho\rho} = 0, \quad (13)$$

$$\left(\frac{W_{\varphi\rho}}{\rho} + \frac{\partial W_{\varphi\rho}}{\partial \rho} \right) + qW_{\theta\rho} = 0, \quad (14)$$

$$\left(\frac{W_{\theta\rho}}{\rho} + \frac{\partial W_{\theta\rho}}{\partial \rho} \right) - qW_{\varphi\rho} = 0, \quad (15)$$

$$\left(\left(\frac{W_{\rho\rho}}{\rho} + \frac{\partial W_{\rho\rho}}{\partial \rho} \right) + \frac{2W_{\theta\rho}}{\rho} \right) = 0, \quad (16)$$

where

$$W = E + H. \quad (17)$$

The system of 4 equations (13-16) defines 3 unknown functions - the system is overdetermined. We show that there is a solution that satisfies all equations

Direct substitution can be seen that the equations (14, 15) has the following solution:

$$W_{\theta\rho} = A \cdot \frac{-i}{\rho} \exp(iq(\rho - R) + \beta), \quad (18)$$

$$W_{\varphi\rho} = -A \cdot \frac{1}{\rho} \exp(iq(\rho - R) + \beta), \quad (19)$$

where A , R , ω , β , c - constants. We find from equations (13, 18):

$$W_{\rho\rho} = \frac{2W_{\varphi\rho}}{\rho} \frac{c}{\omega} = -\frac{2A}{q\rho^2} \exp(iq(\rho - R) + \beta), \quad (20)$$

$$\frac{\partial W_{\rho\rho}}{\partial \rho} = A \left(\frac{2i}{q\rho^3} - \frac{2}{\rho^2} \right) \exp(iq(\rho - R) + \beta). \quad (21)$$

Substituting equations (19-21) to (16), we see that equation (16) turns into the identical relation $0=0$. Therefore, three functional relations (18-20) comply with four equations (13-16), which was to be proved.

The decision does not change if instead of (17) will be used condition

$$W = (E + H) \frac{2}{(1 + i)}. \quad (22)$$

Next, we will look for a solution in which

$$E = iH. \quad (23)$$

From (76, 77), we find:

$$W = (1+i)H \frac{2}{(1+i)} = 2H \quad (24)$$

or

$$H = W/2. \quad (25)$$

From (77, 79), we find:

$$E = Wi/2. \quad (26)$$

From (18-20, 79, 80), we find:

$$H_{\theta\rho} = \frac{-Ai}{2\rho} \exp(iq(\rho - R) + \beta), \quad (27)$$

$$H_{\varphi\rho} = \frac{-A}{2\rho} \exp(iq(\rho - R) + \beta), \quad (28)$$

$$H_{\rho\rho} = \frac{-A}{q\rho^2} \exp(iq(\rho - R) + \beta), \quad (29)$$

$$E_{\theta\rho} = \frac{A}{2\rho} \exp(iq(\rho - R) + \beta), \quad (30)$$

$$E_{\varphi\rho} = \frac{-Ai}{2\rho} \exp(iq(\rho - R) + \beta), \quad (31)$$

$$E_{\rho\rho} = \frac{-Ai}{q\rho^2} \exp(iq(\rho - R) + \beta). \quad (32)$$

The solution obtained is a complex value. It is known that the real part of a complex solution is also a solution. It follows that one can take the real parts of functional relations (27-32) as a solution instead of these functional relations:

$$H_{\theta\rho} = \frac{A}{2\rho} \sin(q(\rho - R) + \beta), \quad (33)$$

$$H_{\varphi\rho} = \frac{-A}{2\rho} \cos(q(\rho - R) + \beta), \quad (34)$$

$$H_{\rho\rho} = \frac{-A}{q\rho^2} \cos(q(\rho - R) + \beta), \quad (35)$$

$$E_{\theta\rho} = \frac{A}{2\rho} \cos(q(\rho - R) + \beta), \quad (36)$$

$$E_{\varphi\rho} = \frac{A}{2\rho} \sin(q(\rho - R) + \beta), \quad (37)$$

$$E_{\rho\rho} = \frac{A}{q\rho^2} \sin(q(\rho - R) + \beta), \quad (38)$$

To check this solution, one can substitute these functions into equations in Table 3 to make sure that these equations become equalities.

Thus, the solution of Maxwell's equations for the spherical vacuum capacitor has the form of equations (33-38).

To find all these functions, it suffices to know the values of constants A, R, ω, β, c . This solution means that **an electromagnetic wave does exist in the spherical capacitor in a sinusoidal current circuit.**

The solution of Maxwell's equations for the case when the dielectric is not a vacuum is given in Appendix 1 and for the case when the dielectric has some electrical conductivity – in Appendix 2.

4. Electric and magnetic intensities

Let us consider a point T with coordinates φ, θ on a sphere of radius ρ . Vectors H_φ and H_θ , going from this point are in plane P, tangent to this sphere at point $T(\varphi, \theta)$ - see Fig. 2. These vectors are perpendicular to each other. Hence, at each point (φ, θ) the sum vector

$$H_{\varphi\theta} = H_\varphi + H_\theta \quad (39)$$

is in plane P and has an angle of ψ to a parallel line. As it follows from (33, 34) and the Table 3, the module of this vector $|H_{\varphi\theta}|$ and the angle ψ defined by the following formulas:

$$H_{\varphi\theta} = |H_{\varphi\theta}| \sin(\theta) \cos(\omega t), \quad (39a)$$

$$|H_{\varphi\theta}| = \frac{A}{2\rho} \quad (40)$$

$$\cos(\psi) = \frac{H_{\varphi\rho}}{|H_{\varphi\theta}|} = \sin\left(\frac{\omega}{c}(\rho - R) + \beta\right)$$

or

$$\psi = \frac{\pi}{2} - \frac{\omega}{c}(\rho - R) - \beta. \quad (41)$$

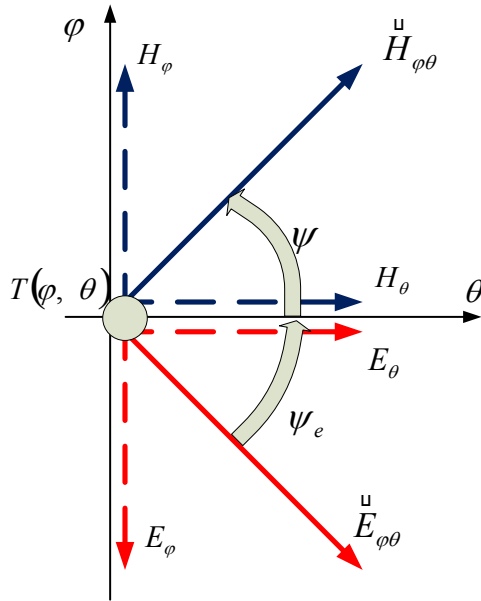

Fig. 2.

Similarly, the same relationships exist for the vectors \vec{E}_φ and \vec{E}_θ . At each point (φ, θ) the total vector

$$\vec{E}_{\varphi\theta} = \vec{E}_\varphi + \vec{E}_\theta \quad (42)$$

lies in the plane P and is directed at an angle ψ_e to a line parallel. It follows from (36, 37) and Table 3, the module of this vector and the angle ψ_e defined by the following formulas:

$$|\vec{E}_{\varphi\theta}| = \frac{A}{2\rho} \quad (43)$$

$$\cos(\psi_e) = \frac{E_{\theta\rho}}{|\vec{E}_{\varphi\theta}|} = \cos\left(\frac{\omega}{c}(\rho - R) + \beta\right)$$

or

$$\psi_e = \frac{\omega}{c}(\rho - R) - \beta \quad (44)$$

or

$$\psi_e = \frac{\pi}{2} - \psi. \quad (45)$$

The angle between $\vec{H}_{\varphi\theta}$ и $\vec{E}_{\varphi\theta}$ in the plane P is straight.

Therefore, in a spherical capacitor we can consider only one vector of the electrical field intensities $\vec{E}_{\varphi\theta}$ and only one vector of the magnetic field intensities $\vec{H}_{\varphi\theta}$. As these vectors lie on the sphere, they will be called spherical vectors.

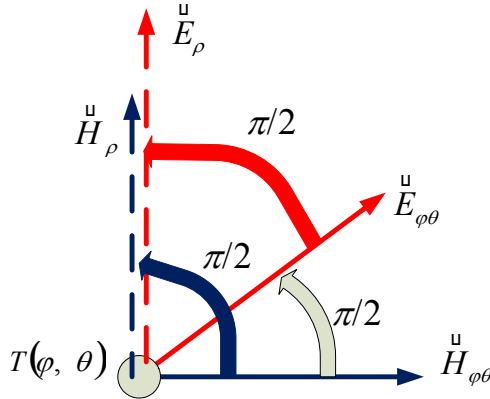

Fig. 3.

In Fig. 3 shows the vectors $\vec{H}_{\varphi\theta}$ and $\vec{E}_{\varphi\theta}$ lying in the plane P, and vectors \vec{H}_ρ and \vec{E}_ρ lying on a radius.

Note that there are many solutions distinguished by value β . This fact reflects the arbitrary rule in the choice of mathematical coordinate axes.

Angle ψ (30) is constant for all vectors $\vec{H}_{\varphi\theta}$ for a given radius ρ . This means that the directions of all vectors $\vec{H}_{\varphi\theta}$ constitute the same angle ψ with all parallels on a sphere with a radius of ρ . This implies in turn that there are the magnetic equatorial plane inclined to the mathematical equatorial plane at angle ψ , magnetic axis, magnetic poles, and magnetic meridians, along which vectors $\vec{H}_{\varphi\theta}$ are directed – see Fig. 4, where thin lines mark the mathematical meridional grid, thick lines mark the magnetic meridional grid, the mathematical axis mm , and magnetic axis aa and electric axis bb are shown. It is important to note that the magnetic axis aa , electric axis bb and all vectors $\vec{E}_{\varphi\theta} \perp \vec{H}_{\varphi\theta}$ are perpendicular.

When $\frac{\omega}{c} \approx 0$ and $\beta = 0$ the magnetic axis coincides with the mathematical axis.

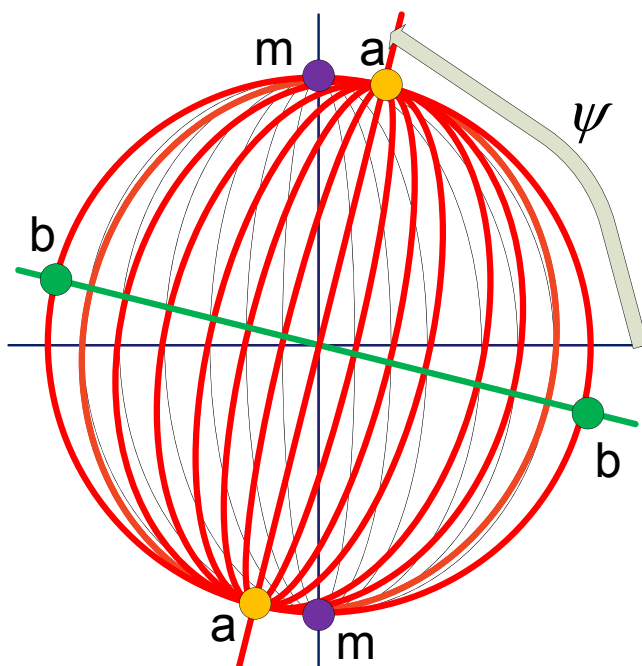

Fig. 4.

Spherical vectors depend on $\sin(\theta)$. Radial vectors depend on $\cos(\theta)$ – see Table 3. Therefore, there are the radial intensities only in locations where the spherical intensity is zero.

5. Energy fluxes

Similarly to Chapter 1, density of electromagnetic energy flux is Poynting vector

$$S = \eta E \times H, \quad (1)$$

where

$$\eta = c/4\pi. \quad (2)$$

In spherical coordinates φ, θ, ρ density of electromagnetic energy flux has three components $S_\varphi, S_\theta, S_\rho$, along radial, circumferential and axial directions, respectively. They can be determined as follows:

$$S = \begin{bmatrix} S_\varphi \\ S_\theta \\ S_\rho \end{bmatrix} = \eta(E \times H) = \eta \begin{bmatrix} E_\theta H_\rho - E_\rho H_\theta \\ E_\rho H_\varphi - E_\varphi H_\rho \\ E_\varphi H_\theta - E_\theta H_\varphi \end{bmatrix}. \quad (4)$$

From this and Table 3 it follows that

$$S = \eta \begin{bmatrix} \left(E_{\theta\rho} \sin(\theta)\sin(\omega t)H_{\rho\rho} \cos(\theta)\cos(\omega t) - \right. \\ \left. - E_{\rho\rho} \cos(\theta)\sin(\omega t)H_{\theta\rho} \sin(\theta)\cos(\omega t) \right) \\ \left(E_{\rho\rho} \cos(\theta)\sin(\omega t)H_{\varphi\rho} \sin(\theta)\cos(\omega t) - \right. \\ \left. - E_{\varphi\rho} \sin(\theta)\sin(\omega t)H_{\rho\rho} \cos(\theta)\cos(\omega t) \right) \\ \left(E_{\varphi\rho} \sin(\theta)\sin(\omega t)H_{\theta\rho} \sin(\theta)\cos(\omega t) - \right. \\ \left. - E_{\theta\rho} \sin(\theta)\sin(\omega t)H_{\varphi\rho} \sin(\theta)\cos(\omega t) \right) \end{bmatrix}$$

or

$$S = \eta \begin{bmatrix} \left(E_{\theta\rho}H_{\rho\rho} \right) - E_{\rho\rho}H_{\theta\rho} \sin(\theta)\cos(\theta)\sin(\omega t) \cos(\omega t) \\ \left(E_{\rho\rho}H_{\varphi\rho} - E_{\varphi\rho}H_{\rho\rho} \right) \sin(\theta)\cos(\theta)\sin(\omega t) \cos(\omega t) \\ \left(E_{\varphi\rho}H_{\theta\rho} - E_{\theta\rho}H_{\varphi\rho} \right) \sin^2(\theta)\sin(\omega t) \cos(\omega t) \end{bmatrix}$$

or

$$S = \eta \sin(\omega t) \cos(\omega t) \begin{bmatrix} \left(E_{\theta\rho}H_{\rho\rho} \right) - E_{\rho\rho}H_{\theta\rho} \sin(\theta)\cos(\theta) \\ \left(E_{\rho\rho}H_{\varphi\rho} - E_{\varphi\rho}H_{\rho\rho} \right) \sin(\theta)\cos(\theta) \\ \left(E_{\varphi\rho}H_{\theta\rho} - E_{\theta\rho}H_{\varphi\rho} \right) \sin^2(\theta) \end{bmatrix}$$

or

$$S = \frac{\eta}{4} \sin(2\omega t) \begin{bmatrix} \left(E_{\theta\rho}H_{\rho\rho} - E_{\rho\rho}H_{\theta\rho} \right) \sin(2\theta) \\ \left(E_{\rho\rho}H_{\varphi\rho} - E_{\varphi\rho}H_{\rho\rho} \right) \sin(2\theta) \\ 2\left(E_{\varphi\rho}H_{\theta\rho} - E_{\theta\rho}H_{\varphi\rho} \right) \sin^2(\theta) \end{bmatrix}. \quad (5)$$

Let's define

$$\gamma = (q(\rho - R) + \beta). \quad (6)$$

Substituting (3.33-3.38, 6) into (5) we obtain the following:

$$S = -\frac{\eta}{4} \sin(2\omega t) \frac{A}{2\rho} \frac{A}{q\rho^2} \begin{bmatrix} \left(-\cos^2(\gamma) - \sin^2(\gamma) \right) \sin(2\theta) \\ \left(-\cos(\gamma)\sin(\gamma) + \cos(\gamma)\sin(\gamma) \right) \sin(2\theta) \\ 2\left(\sin^2(\gamma) + \cos^2(\gamma) \right) \sin^2(\theta) \end{bmatrix}$$

or

$$S = \begin{bmatrix} S_\varphi \\ S_\theta \\ S_\rho \end{bmatrix} = \frac{\eta A^2}{8q\rho^3} \sin(2\omega t) \begin{bmatrix} -\sin(2\theta) \\ 0 \\ 2\sin^2(\theta) \end{bmatrix}. \quad (7)$$

Therefore, in spherical capacitor with sinusoidal characteristic of voltage there are two energy fluxes — meridional and radial with densities, respectively:

$$S_{\phi} = \frac{-\eta A^2}{8q\rho^3} \sin(2\omega t) \sin(2\theta), \quad (8)$$

$$S_{\rho} = \frac{\eta A^2}{4q\rho^3} \sin(2\omega t) \sin^2(\theta). \quad (9)$$

6. An Electromagnetic Wave in a Charged Spherical Capacitor

A solution of the Maxwell equations for a parallel-plate capacitor being charged (see chapter 7) systems from a solution of these equations for a parallel-plate capacitor in a sinusoidal current circuit (see chapter 3). In this paper the method described in chapter 7 will be used in solving the Maxwell equations for a spherical capacitor being charged.

Electromagnetic wave propagation in charging spherical capacitor is shown, and mathematical description of this wave is proved to be a solution of Maxwell's equations. It was shown that a charged spherical capacitor accommodates a stationary flux of electromagnetic energy, and the energy contained in the capacitor, which was considered to be electric potential energy, is, indeed, electromagnetic energy stored in the capacitor in the form of the stationary flux.

For charged spherical capacitor the system of Maxwell's equations shown in Table 2 shall be changed so that instead of equation (7) the following equation is used:

$$\operatorname{div}(E) = Q(t), \quad (a)$$

where $Q(t)$ - charge on capacitor plate, which appears and accumulates during charging. The system of partial differential equations obtained in such a way has a solution represented by the sum of a particular solution of this system and a general solution of the corresponding homogeneous system of equations. Homogeneous system is shown in Table 2, i.e. it only differs from this new system by the absence of term $Q(t)$. Particular solution with given t is a solution, which associates electric intensity $E_{\rho}(t)$ between the capacitor plates with electric charge $Q(t)$. If $E_{\rho}(t)$ varies with time, then a solution of the system of equations from Table 2 shall exist at given $E_z(t)$. Exactly this solution we're going to seek further on.

Let us consider the field intensities in the form of functions presented in Table 6. These functions differ from functions of Table 3 only by the type of time dependence: in Table 3, E and H functions depend on time as $\sin(\omega t)$, $\cos(\omega t)$, respectively, while in Table 6, E and H functions depend on time as $(1 - \exp(\omega t))$, $(\exp(\omega t) - 1)$, respectively. Although the indicated substitution, the solution of Maxwell's equations remain unchanged.

Table 6.

1	2
	$E_\rho = E_{\rho\rho}(\rho)\cos(\theta)(1 - \exp(\omega t))$
	$E_\theta = E_{\theta\rho}(\rho)\sin(\theta)(1 - \exp(\omega t))$
	$E_\varphi = E_{\varphi\rho}(\rho)\sin(\theta)(1 - \exp(\omega t))$
	$H_\rho = H_{\rho\rho}(\rho)\cos(\theta)(\exp(\omega t) - 1)$
	$H_\theta = H_{\theta\rho}(\rho)\sin(\theta)(\exp(\omega t) - 1)$
	$H_\varphi = H_{\varphi\rho}(\rho)\sin(\theta)(\exp(\omega t) - 1)$

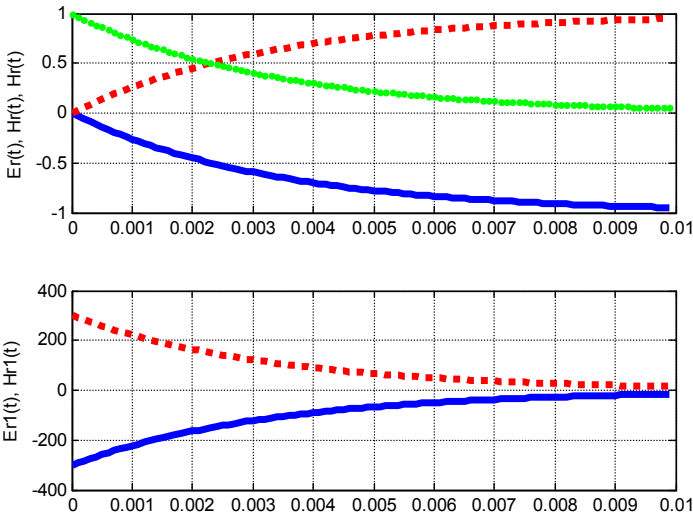

Fig.6. (SSMB6.1)

Bias Current

$$J_\rho = \frac{d}{dt} E_\rho = -\omega E_{\rho\rho}(\rho)\cos(\theta)\exp(\omega t) \tag{46}$$

Fig. 6 presents intensities components and their time derivatives as well as the bias current as a function of time for $\omega = -300$: H_ρ is shown with a solid line, with a dashed line, and J_ρ with dotted line. It is evident that with $t \Rightarrow \infty$ the amplitudes of all intensities components tend to a constant together, while the current amplitude approaches zero. This corresponds to the capacitor charging via a fixed resistor.

Similar to (39a, 40, 41) we can write equations for vector $\mathbf{H}_{\varphi\theta}$, modulus of this vector $|\mathbf{H}_{\varphi\theta}|$ and angle ψ :

$$H_{\varphi\theta} = |\mathbf{H}_{\varphi\theta}| \sin(\theta) (\exp(\omega t) - 1), \quad (47)$$

$$|\mathbf{H}_{\varphi\theta}| = \frac{A}{2\rho}, \quad (48)$$

$$\psi = \frac{\pi}{2} - \frac{\omega}{c}(\rho - R) - \beta, \quad (49)$$

where A , R , ω , β , c – constants which can be determined experimentally, R – radius of the external sphere of the capacitor. Constant $\omega = -\frac{1}{\tau}$, where τ – time constant in the capacitor charge circuit.

The structure of the electromagnetic wave remains the same - see Section 3. As it was shown in this section, electromagnetic wave existing in a spherical capacitor has only spherical $\mathbf{E}_{\varphi\theta}$, $\mathbf{H}_{\varphi\theta}$ and radial \mathbf{E}_ρ , \mathbf{H}_ρ vectors.

Thus, it's fare to say, that spherical capacitor is a device which is equivalent to both - magnet and, at the same time, electret which axes are perpendicular.

Let's consider energy fluxes in a charged spherical capacitor. Similarly to Section 5, we can calculate densities of energy fluxes

$$S = \begin{bmatrix} S_\varphi \\ S_\theta \\ S_\rho \end{bmatrix} = \eta(\mathbf{E} \times \mathbf{H}) = \eta \begin{bmatrix} E_\theta H_\rho - E_\rho H_\theta \\ E_\rho H_\varphi - E_\varphi H_\rho \\ E_\varphi H_\theta - E_\theta H_\varphi \end{bmatrix}. \quad (50)$$

From this and Table 6 it follows that

$$S = \eta \begin{bmatrix} \left(E_{\theta\rho} \sin(\theta)(1 - \exp(\omega t)) H_{\rho\rho} \cos(\theta)(\exp(\omega t) - 1) - \right. \\ \left. - E_{\rho\rho} \cos(\theta)(1 - \exp(\omega t)) H_{\theta\rho} \sin(\theta)(\exp(\omega t) - 1) \right) \\ \left(E_{\rho\rho} \cos(\theta)(1 - \exp(\omega t)) H_{\phi\rho} \sin(\theta)(\exp(\omega t) - 1) - \right. \\ \left. - E_{\phi\rho} \sin(\theta)(1 - \exp(\omega t)) H_{\rho\rho} \cos(\theta)(\exp(\omega t) - 1) \right) \\ \left(E_{\phi\rho} \sin(\theta)(1 - \exp(\omega t)) H_{\theta\rho} \sin(\theta)(\exp(\omega t) - 1) - \right. \\ \left. - E_{\theta\rho} \sin(\theta)(1 - \exp(\omega t)) H_{\phi\rho} \sin(\theta)(\exp(\omega t) - 1) \right) \end{bmatrix}.$$

or

$$S = -\eta(1 - \exp(\omega t))^2 \begin{bmatrix} (E_{\theta\rho} H_{\rho\rho} - E_{\rho\rho} H_{\theta\rho}) \sin(\theta) \cos(\theta) \\ (E_{\rho\rho} H_{\phi\rho} - E_{\phi\rho} H_{\rho\rho}) \sin(\theta) \cos(\theta) \\ (E_{\phi\rho} H_{\theta\rho} - E_{\theta\rho} H_{\phi\rho}) \sin^2(\theta) \end{bmatrix}$$

or

$$S = \frac{\eta}{2} (1 - \exp(\omega t))^2 \begin{bmatrix} (E_{\theta\rho} H_{\rho\rho} - E_{\rho\rho} H_{\theta\rho}) \sin(2\theta) \\ (E_{\rho\rho} H_{\phi\rho} - E_{\phi\rho} H_{\rho\rho}) \sin(2\theta) \\ 2(E_{\phi\rho} H_{\theta\rho} - E_{\theta\rho} H_{\phi\rho}) \sin^2(\theta) \end{bmatrix}. \quad (51)$$

From this, similarly to Section 5, we can obtain:

$$S = \begin{bmatrix} S_\phi \\ S_\theta \\ S_\rho \end{bmatrix} = \frac{\eta A^2}{2q\rho^3} (1 - \exp(\omega t))^2 \begin{bmatrix} -\sin(2\theta) \\ 0 \\ 2\sin^2(\theta) \end{bmatrix}. \quad (52)$$

Therefore, in charged spherical capacitor there are two energy fluxes — meridional and radial with densities, respectively:

$$S_\phi = \frac{-\eta A^2}{2q\rho^3} (1 - \exp(\omega t))^2 \sin(2\theta), \quad (53)$$

$$S_\rho = \frac{\eta A^2}{q\rho^3} (1 - \exp(\omega t))^2 \sin^2(\theta). \quad (54)$$

When the capacitor has been charged, current interrupts. However, stationary fluxes of electromagnetic energy remain. When $t \Rightarrow \infty$, from (53, 54) it follows that in charged spherical capacitor two energy fluxes exist — meridional and radial with densities, respectively:

$$S_\phi = \frac{-\eta A^2}{2q\rho^3} \sin(2\theta), \quad (55)$$

$$S_\rho = \frac{\eta A^2}{q\rho^3} \sin^2(\theta). \quad (56)$$

Thus, the solution of the Maxwell equations for a capacitor being charged and for a capacitor in a sinusoidal current circuit differs only in that the former includes exponential functions of time and the latter contains sinusoidal time-functions.

7. Electromagnetic wave around spherical charge

Single spherical charge can be considered as a spherical capacitor with infinitely large radius of external sphere. In this case, all the properties of charged spherical capacitor are true for this type of charge. Therefore, we can conclude that around solitary spherical charge exist the following:

- stationary Coulomb (electric) field,
- electromagnetic and almost stationary field — see (6.47-6.48),
- electromagnetic energy fluxes — meridional and radial with densities in the form (6.55, 6.56), respectively.

Exactly within this flux electromagnetic energy of the electric charge circulates. Thus, energy of an electric charge, which was considered to be electric potential energy, is indeed, electromagnetic energy accumulated around the charge in the form of stationary flux.

Appendix 1. Solution of Maxwell's equations for the medium

The solution of equations for the vacuum was considered above, where in the GHS system, $\varepsilon = \mu = 1$. At this time, we take a look at the more general case, where $\varepsilon \neq \mu$.

We consider again Table 5. We shall call

$$E = gE', \tag{60}$$

$$g = \sqrt{\mu/\varepsilon}. \tag{61}$$

Then Table 5 becomes Table 7. We perform simple transforms in Table 7 and get Table 8. In Table 5a:

- In lines 1, 2, 3, 4 the equations are divided by g ,
- At the same time, in lines 1, 2, 3 before variable H appears coefficient

$$q = \frac{\omega\mu}{c} / g = \frac{\omega}{c} \sqrt{\mu\varepsilon}, \tag{62a}$$

- In lines 5, 6, 7 the coefficient before variable E' is replaced with for

$$q = \frac{\omega \varepsilon}{c} g = \frac{\omega}{c} \sqrt{\mu \varepsilon}. \tag{62b}$$

Therefore, in this case the solution also has the form (33-38). The only difference is in the value of coefficient q; compare (12) and (62). Next, intensities E are defined by (60). Thus, in this case equations (33-38) become:

$$H_{\theta\rho} = \frac{A}{2\rho} \sin(q(\rho - R) + \beta), \tag{63}$$

$$H_{\varphi\rho} = \frac{-A}{2\rho} \cos(q(\rho - R) + \beta), \tag{64}$$

$$H_{\rho\rho} = \frac{-A}{q\rho^2} \cos(q(\rho - R) + \beta), \tag{65}$$

$$E_{\theta\rho} = \frac{Ag}{2\rho} \cos(q(\rho - R) + \beta), \tag{66}$$

$$E_{\varphi\rho} = \frac{Ag}{2\rho} \sin(q(\rho - R) + \beta), \tag{67}$$

$$E_{\rho\rho} = \frac{Ag}{q\rho^2} \sin(q(\rho - R) + \beta). \tag{68}$$

Table 7.

1	2
1	$\frac{2E'_{\varphi\rho}}{\rho} g - \frac{\omega\mu}{c} H_{\rho\rho} = 0$
2	$-\left(\frac{E'_{\varphi\rho}}{\rho} + \frac{\partial E'_{\varphi\rho}}{\partial \rho}\right) g - \frac{\omega\mu}{c} H_{\theta\rho} = 0$
3	$\left(\frac{E'_{\theta\rho}}{\rho} + \frac{\partial E'_{\theta\rho}}{\partial \rho}\right) g - \frac{\omega\mu}{c} H_{\varphi\rho} = 0$
4	$\left(\left(\frac{E'_{\rho\rho}}{\rho} + \frac{\partial E'_{\rho\rho}}{\partial \rho}\right) + \frac{2E'_{\theta\rho}}{\rho}\right) g = 0$
5	$\frac{2H_{\varphi\rho}}{\rho} - \frac{\omega\varepsilon}{c} E'_{\rho\rho} g = 0$
6	$-\left(\frac{H_{\varphi\rho}}{\rho} + \frac{\partial H_{\varphi\rho}}{\partial \rho}\right) - \frac{\omega\varepsilon}{c} E'_{\theta\rho} g = 0$

7	$\left(\frac{H_{\theta\rho}}{\rho} + \frac{\partial H_{\theta\rho}}{\partial \rho} \right) - \frac{\omega \varepsilon}{c} E'_{\rho\rho} g = 0$
8	$\left(\left(\frac{H_{\rho\rho}}{\rho} + \frac{\partial H_{\rho\rho}}{\partial \rho} \right) + \frac{2H_{\theta\rho}}{\rho} \right) = 0$

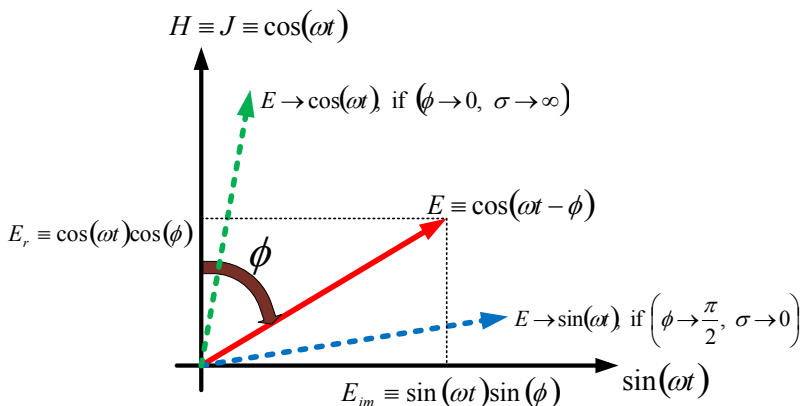

Fig. 11.

Appendix 2. Solution of Maxwell's equations for conductive dielectric

In Application 1 was considered the solution of equations for the dielectric, which was $\varepsilon \neq \mu$. Next, assume that the dielectric has a certain electrical conductivity σ . In this case, the equation of the form

$$\text{rot}H - \frac{\varepsilon}{c} \frac{\partial E}{\partial t} = 0 \quad (71)$$

is replaced by the equation of the form

$$\text{rot}H - \frac{\varepsilon}{c} \frac{\partial E}{\partial t} - \sigma E = 0 \quad (72)$$

Instead Table 3 in this case we use the Table 9, where ϕ - the phase angle between the magnetic and electric field intensities – see Fig. 11.

Table 9.

1	2
	$E_\rho = E_{\rho\rho}(\rho) \cos(\theta) (\sin(\phi) \sin(\omega t) + \sigma \cos(\phi) \cos(\omega t))$
	$E_\theta = E_{\theta\rho}(\rho) \sin(\theta) (\sin(\phi) \sin(\omega t) + \sigma \cos(\phi) \cos(\omega t))$

$E_\varphi = E_{\varphi\rho}(\rho)\sin(\theta)(\sin(\phi)\sin(\omega t) + \sigma\cos(\phi)\cos(\omega t))$
$H_\rho = H_{\rho\rho}(\rho)\cos(\theta)\cos(\omega t)$
$H_\theta = H_{\theta\rho}(\rho)\sin(\theta)\cos(\omega t)$
$H_\varphi = H_{\varphi\rho}(\rho)\sin(\theta)\cos(\omega t)$

At the same time the system of Maxwell's equations can be replaced by two independent systems of equations: in the first system is used the term $\sin(\phi)\sin(\omega t)$ from the Table 9, and in the second system - the term $\sigma\cos(\phi)\cos(\omega t)$ from the Table 9. After receiving the decision of the system the general solution is defined as the sum of the solutions found (by the linearity of systems). The solution of the first system is given in Appendix 1.

Table. 5 for the second system takes the form of Table 10 (modified formulas (5-7)). Next will also argue, as in Application 1. Let

$$E = gE'. \tag{73}$$

when

$$g = \sqrt{\frac{\mu}{\varepsilon \cdot \sigma \cdot \cos(\phi)}}. \tag{74}$$

Then the Table 10 takes the form of the Table 11 (similar transformations are presented in Table 7), and again we obtain Table 5a:

- In lines 1, 2, 3, 4 the equations are divided by g,
- At the same time, in lines 1, 2, 3 before variable H appears coefficient

$$q = \frac{\omega\mu}{c} / g = \frac{\omega}{c} \sqrt{\mu\varepsilon\sigma \cdot \cos(\phi)}, \tag{75}$$

- In lines 5, 6, 7 the coefficient before variable E' is replaced with for

$$q = \sigma \cdot \cos(\phi) \cdot g = \frac{\omega}{c} \sqrt{\mu\varepsilon\sigma \cdot \cos(\phi)}. \tag{76}$$

Therefore, in this case the solution also has the form (33-38). The only difference is in the value of coefficient q: compare (12) and (75). Next, intensities E are defined by (73). Therefore, in this case the solution also has the form (63-68). The only difference is in the value of coefficient g - compare (61) and (74).

By combining this solution of the second system with the solution the first system, we finally obtain:

$$E_{\rho\rho} = \frac{Ag}{q\rho^2} \sin(q(\rho - R) + \beta). \quad (77)$$

$$H_{\theta\rho} = \frac{A}{2\rho} (\sin(q_1(\rho - R) + \beta_1) + \sin(q_2(\rho - R) + \beta_2)), \quad (78)$$

$$H_{\phi\rho} = \frac{-A}{2\rho} (\cos(q_1(\rho - R) + \beta_1) + \cos(q_2(\rho - R) + \beta_2)), \quad (79)$$

$$H_{\rho\rho} = \frac{-A}{\rho^2} \left(\frac{1}{q_1} \cos(q_1(\rho - R) + \beta_1) + \frac{1}{q_2} \cos(q_2(\rho - R) + \beta_2) \right), \quad (80)$$

$$E_{\theta\rho} = \frac{A}{2\rho} (g_1 \cos(q_1(\rho - R) + \beta_1) + g_2 \cos(q_2(\rho - R) + \beta_2)), \quad (81)$$

$$E_{\phi\rho} = \frac{A}{2\rho} (g_1 \sin(q_1(\rho - R) + \beta_1) + g_2 \sin(q_2(\rho - R) + \beta_2)), \quad (82)$$

$$E_{\rho\rho} = \frac{A}{\rho^2} (w_1 \sin(q_1(\rho - R) + \beta_1) + w_2 \sin(q_2(\rho - R) + \beta_2)), \quad (83)$$

where

$$q_1 = \frac{\omega}{c} \sqrt{\mu\varepsilon}, \quad (84)$$

$$q_2 = \frac{\omega}{c} \sqrt{\mu\varepsilon\sigma \cdot \cos(\phi)}. \quad (85)$$

$$g_1 = \sqrt{\frac{\mu}{\varepsilon}}, \quad (86)$$

$$g_2 = \sqrt{\frac{\mu}{\varepsilon \cdot \sigma \cdot \cos(\phi)}}, \quad (87)$$

$$w_1 = \frac{g_1}{q_1} = \sqrt{\frac{\mu}{\varepsilon}} / \left(\frac{\omega}{c} \sqrt{\mu\varepsilon} \right) = \frac{c}{\omega\varepsilon}, \quad (88)$$

$$w_2 = \frac{g_2}{q_2} = \sqrt{\frac{\mu}{\varepsilon \cdot \sigma \cdot \cos(\phi)}} / \left(\frac{\omega}{c} \sqrt{\mu\varepsilon\sigma \cdot \cos(\phi)} \right) = \frac{c}{\omega\varepsilon\sigma \cdot \cos(\phi)}. \quad (89)$$

Table 10.

1	2
1	$\frac{2E_{\phi\rho}}{\rho} - \frac{\omega\mu}{c} H_{\rho\rho} = 0$
2	$-\left(\frac{E_{\phi\rho}}{\rho} + \frac{\partial E_{\phi\rho}}{\partial \rho} \right) - \frac{\omega\mu}{c} H_{\theta\rho} = 0$

3	$\left(\frac{E_{\theta\rho}}{\rho} + \frac{\partial E_{\theta\rho}}{\partial \rho} \right) - \frac{\omega\mu}{c} H_{\varphi\rho} = 0$
4	$\left(\left(\frac{E_{\rho\rho}}{\rho} + \frac{\partial E_{\rho\rho}}{\partial \rho} \right) + \frac{2E_{\theta\rho}}{\rho} \right) = 0$
5	$\frac{2H_{\varphi\rho}}{\rho} - \sigma \cos(\phi) E_{\rho\rho} = 0$
6	$- \left(\frac{H_{\varphi\rho}}{\rho} + \frac{\partial H_{\varphi\rho}}{\partial \rho} \right) - \sigma \cos(\phi) E_{\theta\rho} = 0$
7	$\left(\frac{H_{\theta\rho}}{\rho} + \frac{\partial H_{\theta\rho}}{\partial \rho} \right) - \sigma \cos(\phi) E_{\varphi\rho} = 0$
8	$\left(\left(\frac{H_{\rho\rho}}{\rho} + \frac{\partial H_{\rho\rho}}{\partial \rho} \right) + \frac{2H_{\theta\rho}}{\rho} \right) = 0$

Table 11.

1	2
1	$\frac{2E_{\varphi\rho}}{\rho} g - \frac{\omega\mu}{c} H_{\rho\rho} = 0$
2	$- \left(\frac{E_{\varphi\rho}}{\rho} + \frac{\partial E_{\varphi\rho}}{\partial \rho} \right) g - \frac{\omega\mu}{c} H_{\theta\rho} = 0$
3	$\left(\frac{E_{\theta\rho}}{\rho} + \frac{\partial E_{\theta\rho}}{\partial \rho} \right) g - \frac{\omega\mu}{c} H_{\varphi\rho} = 0$
4	$\left(\left(\frac{E_{\rho\rho}}{\rho} + \frac{\partial E_{\rho\rho}}{\partial \rho} \right) + \frac{2E_{\theta\rho}}{\rho} \right) g = 0$
5	$\frac{2H_{\varphi\rho}}{\rho} - \sigma \cos(\phi) E_{\rho\rho} g = 0$
6	$- \left(\frac{H_{\varphi\rho}}{\rho} + \frac{\partial H_{\varphi\rho}}{\partial \rho} \right) - \sigma \cos(\phi) E_{\theta\rho} g = 0$
7	$\left(\frac{H_{\theta\rho}}{\rho} + \frac{\partial H_{\theta\rho}}{\partial \rho} \right) - \sigma \cos(\phi) E_{\varphi\rho} g = 0$
8	$\left(\left(\frac{H_{\rho\rho}}{\rho} + \frac{\partial H_{\rho\rho}}{\partial \rho} \right) + \frac{2H_{\theta\rho}}{\rho} \right) = 0$

Chapter 9. The Nature of Earth's Magnetism

It is known that the Earth electrical field can be considered as a field "between spherical capacitor electrodes" [51]. These electrodes are the Earth surface having a negative charge and the ionosphere having a positive charge. The charge of these electrodes is maintained by continuous atmospheric thunderstorm activities.

It is also known that there is the Earth magnetic field. However, in this case no generally accepted explanation of the source of this field is available. "The problem of the origin and retaining of the field has not been solved as yet." [52].

It was shown above that there are the magnetic equatorial plane, magnetic axis, magnetic poles and magnetic meridians, along which vectors $H_{\phi\theta}$ are directed – see Fig. 4 in chapter 8. The angle between the magnetic axis and the axis of the mathematical model can not be determined from the mathematical model. Moreover, not determined angle between the magnetic axis and the Earth's physical axis of rotation.

Spherical vectors depend on $\sin(\theta)$. Radial vectors depend on $\cos(\theta)$ – see table 6 in chapter 8. Therefore, there are the radial intensities only in locations where the spherical intensity is zero. We find the angle ϕ of inclination. From Table 6 and the formulas (47-49) in chapter 8 it follows that

$$tg(\phi) = \frac{|H_{\phi\theta}|}{|H_{\rho}|} = \frac{\frac{A}{2\rho} \sin(\theta)}{\frac{Ac}{\omega\rho^2} \cos(\theta)} = \frac{\omega \cdot \rho \cdot tg(\theta)}{2}. \quad (50)$$

It flows from the above mentioned that **the Earth electrical field is responsible for the Earth magnetic field.**

Let us consider this problem in more details.

The vector field $H_{\phi\theta}$ in a diametral plane passing through the magnetic axis is shown in Fig. 8. Here, $|H_{\phi\theta}| = 0.7$; $\rho = 1$. The vector

field H_ρ in a diametral plane passing through the magnetic axis is shown in Fig. 9. Here, $|H_\rho| = 0.4$; $\rho = 1$. The vector field $H = H_{\phi\theta} + H_\rho$ in a diametral plane passing through the magnetic axis is shown in Fig. 10. Here, $|H_{\phi\theta}| = 0.3$; $|H_\rho| = 0.2$; $\rho = 1$.

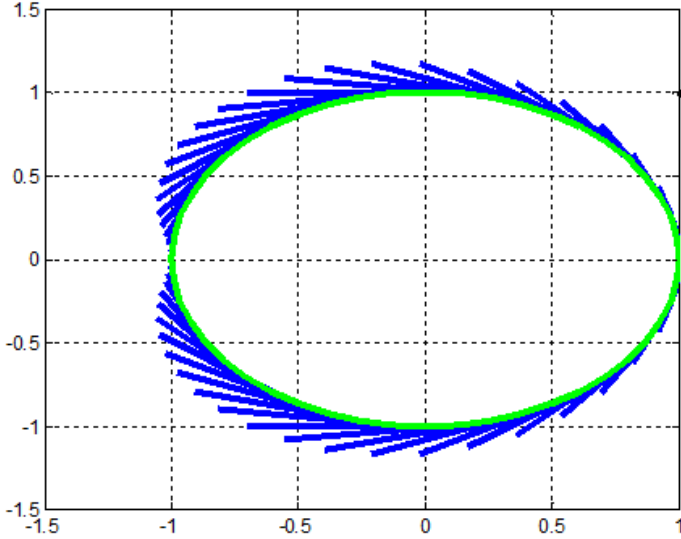

FIG. 8. (Sfera.88)

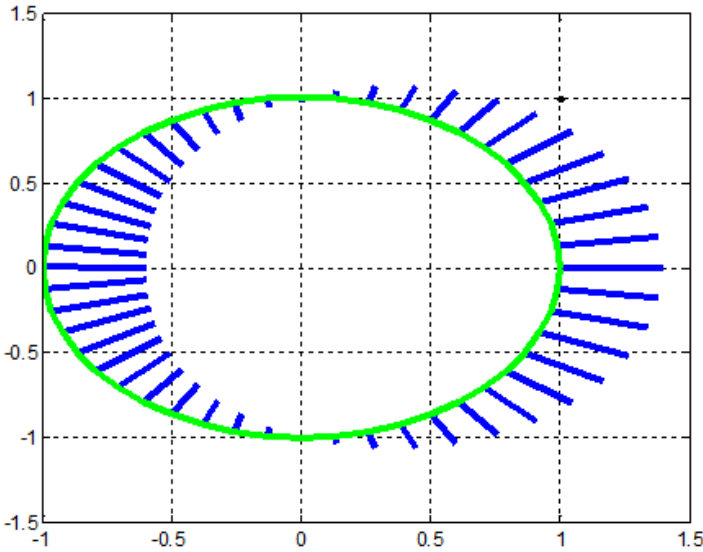
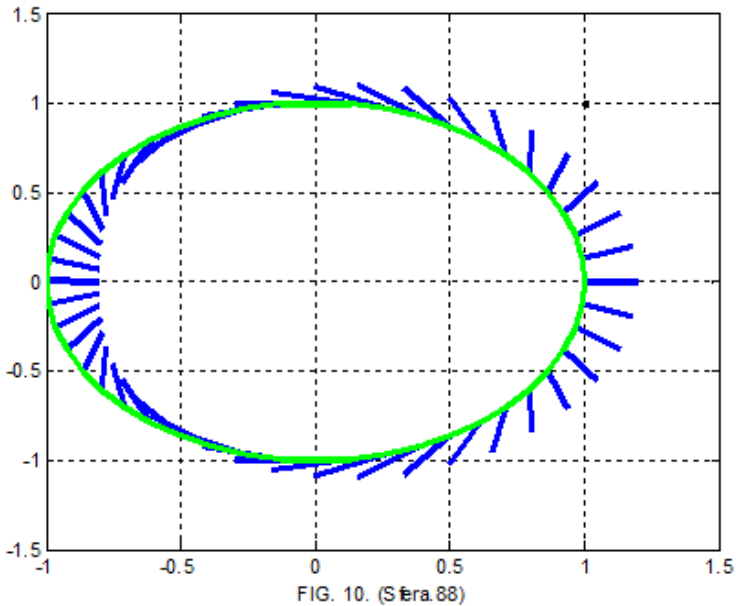

FIG. 9. (Sfera.88)



Similarly, can be described the electric field of the Earth. Importantly, the electric field and the magnetic field are perpendicularly.

Once again, the very existence of the electric field is not in doubt, and the charge of “Earth's spherical capacitor” is supported by the thunderstorm activity [51, 52].

Also consider the comparative quantitative estimates of magnetic and electric intensity of the Earth's field.

In a vacuum, where $\varepsilon = \mu = 1$, there is a relation between the magnetic and electric intensity in any direction in the GHS system [51]

$$E = H. \quad (9)$$

This relation is true if these intensities are measured in the GHS system at a given point in the same direction. To go to the SI system, one shall take into account that

for H: 1 GHS unit = 80 A/m

for E: 1 GHS unit = 30,000 B/m

Hence, the equation (9) takes the following form in the SI system:

$$3000E = 80H \quad (10)$$

or

$$E \approx 0.03H. \quad (11)$$

or

$$H \approx 30E \cdot \text{tg}(\beta). \quad (12)$$

An additional argument in favor of the existence of the electric field of the structure specified is the existence of the telluric currents [2]. There is no generally accepted explanation of their causes. On the basis of the foregoing, it shall be assumed that these currents must have the largest value in the direction of the parallels.

It is possible that the electric field of the Earth can be detected using a freely suspended electric dipole, made in the form of a long isolated rod with metal balls at the ends. It is also possible that oscillations of the rod will be recorded at the low frequency of changing in dipole charges.

Based on the hypothesis suggested, it can be assumed that the magnetic field shall be observed among planets with an atmosphere. Indeed, the Moon and Mars, free of the atmosphere, lack the magnetic field. However, there is no magnetic field at Venus. This may be due to the high density and conductivity of the atmosphere – it cannot be considered as an insulating layer of the spherical capacitor.

Chapter 10. Solution of Maxwell's Equations for Ball Lightning

Contents

1. Introduction
2. The solution of Maxwell equations in spherical coordinates
3. Energy
4. The Energy Flow
 - 4.1. Radial Energy Flux
 - 4.2. Spherical Energy Flux
 - 4.3. Total Energy Flux
5. About Ball Lightning Stability
6. About Luminescence of the Ball Lightning
7. About the Time of Ball Lightning Existence
8. About a Possible Mechanism of Ball Lightning Formation

1. Introduction

The hypotheses that were made about the nature of ball lightning are unacceptable because they are contrary to the law of energy conservation. This occurs because the luminescence of ball lightning is usually attributed to the energy released in any molecular or chemical transformation, and so it is suggested source of energy, due to which the ball lightning glows is located in it.

Kapitsa P.L. 1955 [41]

This assertion (as far as the author knows) is true also today. It is reinforced by the fact that the currently estimated typical ball lightning contains tens of kilojoules [42], released during its explosion.

It is generally accepted that ball lightning is somehow connected with the electromagnetic phenomena, but there is no rigorous description of these processes.

A mathematical model of a globe lightning based on the Maxwell equations, which enabled us to explain many properties of the globe lightning, is proposed in [55]. However, this model turned out be quite intricate as to the used mathematical description. Another model of the ball lightning which is substantiated to a greater extent and make is

possible to obtain less intricate mathematical description is outlined below [56]. Moreover, this model agrees with the model of a spherical capacitor – see chapter 8.

When constructing the mathematical model, it will be assumed that the globe lightning is plasma, i.e. gas consisting of charged particles – electrons, and positive charged ions, i.e. the globe lightning plasma is fully ionized. In addition, it is assumed that the number of positive charges equal to the number of negative charges, and, hence, the total charge of the globe lightning is equal to zero. For the plasma, we usually consider charge and current densities averaged over an elementary volume. Electric and magnetic fields created by the average “charge” density and the “average” current density in the plasma obey the Maxwell equations [62]. The effect of particles collision in the plasma is usually described by the function of particle distribution in the plasma. These effects will be accounted for the Maxwell equations assuming that the plasma possesses some electric resistance or conductivity.

And so on based on the Maxwell's equations and on the understanding of the electrical conductivity of the body of ball lightning, a mathematical model of ball lightning is built; the structure of the electromagnetic field and of electric current in it is shown. Next it is shown (as a consequence of this model) that in a ball lightning the flow of electromagnetic energy can circulate and thus the energy obtained by a ball lightning when it occurs can be saved. Sustainability, luminescence, charge, time being, the mechanism of formation of ball lightning are briefly discussed.

2. The solution of Maxwell equations in spherical coordinates

Fig. 1 shows a system of spherical coordinates (ρ, θ, φ) and the Table 1 gives the expressions for rotor and divergence of vector \mathbf{E} in these coordinates [4]. Here and further

E - intensity of electric field,

H - intensity of magnetic field,

J - currents density,

μ - absolute permeability,

ε - absolute dielectric permittivity,

σ - conductivity.

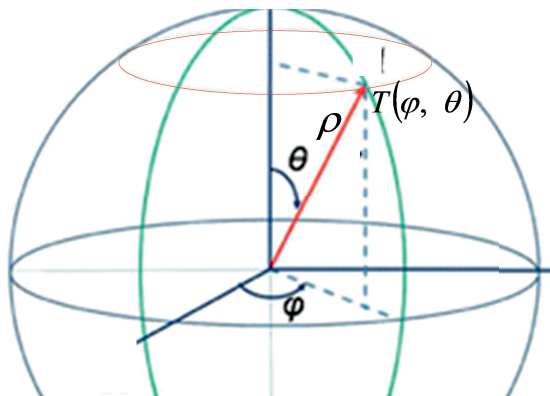

Fig. 1.

Table 1.

1	2	3
1	$\text{rot}_\rho(E)$	$\frac{E_\varphi}{\rho \text{tg}(\theta)} + \frac{\partial E_\varphi}{\rho \partial \theta} - \frac{\partial E_\theta}{\rho \sin(\theta) \partial \varphi}$
2	$\text{rot}_\theta(E)$	$\frac{\partial E_\rho}{\rho \sin(\theta) \partial \varphi} - \frac{E_\varphi}{\rho} - \frac{\partial E_\varphi}{\partial \rho}$
3	$\text{rot}_\varphi(E)$	$\frac{E_\theta}{\rho} + \frac{\partial E_\theta}{\partial \rho} - \frac{\partial E_\rho}{\rho \partial \varphi}$
4	$\text{div}(E)$	$\frac{E_\rho}{\rho} + \frac{\partial E_\rho}{\partial \rho} + \frac{E_\theta}{\rho \text{tg}(\theta)} + \frac{\partial E_\theta}{\rho \partial \theta} + \frac{\partial E_\varphi}{\rho \sin(\theta) \partial \varphi}$

The Maxwell equations in the spherical coordinates in the GHS system without any non-compensated charges are presented in Table 2.

Table 2.

1	2
1.	$\text{rot}_\rho H - \varepsilon \frac{\partial E_\rho}{\partial t} - J_\rho = 0$
2.	$\text{rot}_\theta H - \varepsilon \frac{\partial E_\theta}{\partial t} - J_\theta = 0$
3.	$\text{rot}_\varphi H - \varepsilon \frac{\partial E_\varphi}{\partial t} - J_\varphi = 0$

4.	$\text{rot}_\rho E - \mu \frac{\partial H_\rho}{\partial t} = 0$
5.	$\text{rot}_\theta E - \mu \frac{\partial H_\theta}{\partial t} = 0$
6.	$\text{rot}_\varphi E - \mu \frac{\partial H_\varphi}{\partial t} = 0$
7.	$\text{div}(E) = 0$
8.	$\text{div}(H) = 0$

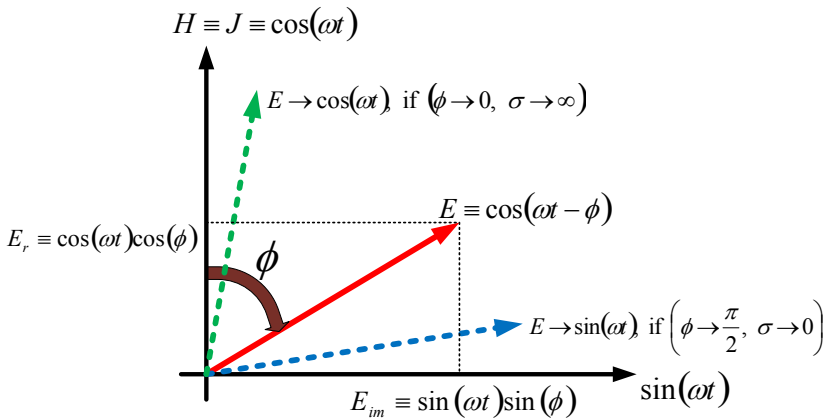

Fig. 2.

A monochromatic solution to these equations will be sought for below. For this purpose, let us write the functions E , H , J in the time domain in the following form:

$$H = H_o \cos(\omega t),$$

$$E = E_o (\sin(\omega t)\sin(\phi) + \cos(\omega t)\cos(\phi)),$$

$$J = E_o \sigma \cos(\omega t)\cos(\phi),$$

where ϕ is the phase angle between the electric and the magnetic strength - see Fig. 2. Considering this assumption, the solution to the Maxwell equations will be sought for in the form of functions E , H , J presented in Table 3, where the functions of type $E_{\varphi\rho}(\rho)$ are to be determined. It should be noted here that these functions are independent of the argument ϕ .

Table 3.

1	2
	$E_\rho = E_{\rho\rho}(\rho)\cos(\theta)(\sin(\phi)\sin(\omega t) + \sigma\cos(\phi)\cos(\omega t))$
	$E_\theta = E_{\theta\rho}(\rho)\sin(\theta)(\sin(\phi)\sin(\omega t) + \sigma\cos(\phi)\cos(\omega t))$
	$E_\varphi = E_{\varphi\rho}(\rho)\sin(\theta)(\sin(\phi)\sin(\omega t) + \sigma\cos(\phi)\cos(\omega t))$
	$H_\rho = H_{\rho\rho}(\rho)\cos(\theta)\cos(\omega t)$
	$H_\theta = H_{\theta\rho}(\rho)\sin(\theta)\cos(\omega t)$
	$H_\varphi = H_{\varphi\rho}(\rho)\sin(\theta)\cos(\omega t)$

It is demonstrated in chapter 8 that this solution exists with

$$H_{\theta\rho} = \frac{A}{2\rho} (\sin(q_1(\rho - R) + \beta_1) + \sin(q_2(\rho - R) + \beta_2)), \quad (1)$$

$$H_{\varphi\rho} = \frac{-A}{2\rho} (\cos(q_1(\rho - R) + \beta_1) + \cos(q_2(\rho - R) + \beta_2)), \quad (2)$$

$$H_{\rho\rho} = \frac{-A}{\rho^2} \left(\frac{1}{q_1} \cos(q_1(\rho - R) + \beta_1) + \frac{1}{q_2} \cos(q_2(\rho - R) + \beta_2) \right), \quad (3)$$

$$E_{\theta\rho} = \frac{A}{2\rho} (g_1 \cos(q_1(\rho - R) + \beta_1) + g_2 \cos(q_2(\rho - R) + \beta_2)), \quad (4)$$

$$E_{\varphi\rho} = \frac{A}{2\rho} (g_1 \sin(q_1(\rho - R) + \beta_1) + g_2 \sin(q_2(\rho - R) + \beta_2)), \quad (5)$$

$$E_{\rho\rho} = \frac{A}{\rho^2} (w_1 \sin(q_1(\rho - R) + \beta_1) + w_2 \sin(q_2(\rho - R) + \beta_2)), \quad (6)$$

where

$$q_1 = \frac{\omega}{c} \sqrt{\mu\varepsilon}, \quad (7)$$

$$q_2 = \frac{\omega}{c} \sqrt{\mu\varepsilon\sigma \cdot \cos(\phi)}. \quad (8)$$

$$g_1 = \sqrt{\frac{\mu}{\varepsilon}}, \quad (9)$$

$$g_2 = \sqrt{\frac{\mu}{\varepsilon \cdot \sigma \cdot \cos(\phi)}}, \quad (10)$$

$$w_1 = \frac{c}{\omega \varepsilon}, \quad (11)$$

$$w_2 = \frac{c}{\omega \varepsilon \sigma \cdot \cos(\phi)}. \quad (12)$$

A, β_1, β_2 are the constants.

It is demonstrated in chapter 8 that instead of the pair of vectors H_φ and H_θ we can consider a single sum vector

$$H_{\varphi\theta} = H_\varphi + H_\theta, \quad (13)$$

which is in the plane tangent to the sphere of radius ρ and has an angle Ψ to the parallel line. The module of this vector and angle Ψ can be determined from the following correlations:

$$|H_{\varphi\theta}| = \frac{A}{2\rho}, \quad (14)$$

$$\Psi = \frac{\pi}{2} - \frac{\omega}{c}(\rho - R) - \beta, \quad (15)$$

where R is the radius of the sphere, and $\beta = \beta_1 = \beta_2$. From (14) and Table 3 it follows that

$$H_{\varphi\theta} = |H_{\varphi\theta}| \sin(\theta) \cos(\omega t) = \frac{A}{2\rho} \sin(\theta) \cos(\omega t). \quad (16)$$

Similar correlations do exist for the vectors E_φ and E_θ , namely:

$$|E_{\varphi\theta}| = \frac{A}{2\rho}, \quad (17)$$

$$\Psi_e = \frac{\omega}{c}(\rho - R) - \beta \quad (18)$$

or

$$\Psi_e = \frac{\pi}{2} - \Psi. \quad (19)$$

From (17) and Table 3 it follows that

$$E_{\varphi\theta} = \frac{A}{2\rho} \sin(\theta) (\sin(\phi) \sin(\omega t) + \sigma \cos(\phi) \cos(\omega t)). \quad (20)$$

Fig. 3 shows vectors $H_\varphi, H_\theta, E_\varphi, E_\theta, H_{\varphi\theta}, E_{\varphi\theta}$ going from point T with coordinates (ρ, θ) . The angle between the vectors $H_{\varphi\theta}$ и $E_{\varphi\theta}$ in the plane P is right.

Thus, in a sphere we may consider only one vector of the electrical field strength $E_{\varphi\theta}$ and only one vector of the magnetic field strength $H_{\varphi\theta}$. As these vectors lie on sphere, we shall call them spherical vectors. Hence, only spherical $H_{\varphi\theta}$ and $E_{\varphi\theta}$ and radial H_ρ and E_ρ strength components exist in the sphere. Fig. 4 shows vectors $H_{\varphi\theta}$ and $E_{\varphi\theta}$ lying in the plane P and vectors H_ρ and E_ρ lying along the radius.

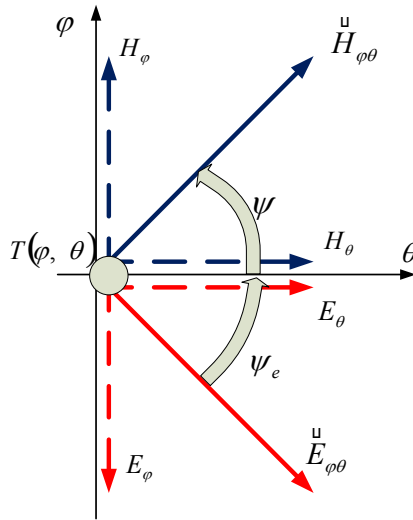

Fig. 3.

Bear in mind that this solution has been obtained under the following assumptions: the sphere is conductive and neutral (does not have any uncompensated charges). Obviously, this solution is not unique. Its existence means only that in a conductive and neutral sphere, an electromagnetic wave can exist, and currents can circulate.

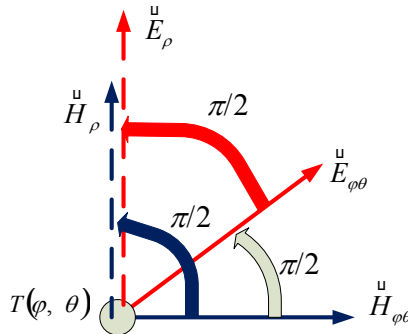

Fig. 4.

3. Energy

From Table 3 follows that a globe lightning contains the following energy components

- Active loss energy W_a – see the second term in the expression for the electric strength:
- Reactive electric energy W_e – see the first term in the expression for the electric strength:
- Reactive magnetic energy W_h – see the expression for the magnetic strength

Let us write these characteristics

$$W_a = (\sigma \cos(\phi) \cos(\omega t))^2 \iint_{\rho, \theta} \left(\left(E_{\rho\rho}(\rho) \cos(\theta) \right)^2 + \sin^2(\theta) \left(\left(E_{\theta\rho}(\rho) \right)^2 + \left(E_{\varphi\rho}(\rho) \right)^2 \right) \right) d\rho d\theta, \quad (21)$$

$$W_e = (\sin(\phi) \sin(\omega t))^2 \iint_{\rho, \theta} \left(\left(E_{\rho\rho}(\rho) \cos(\theta) \right)^2 + \sin^2(\theta) \left(\left(E_{\theta\rho}(\rho) \right)^2 + \left(E_{\varphi\rho}(\rho) \right)^2 \right) \right) d\rho d\theta, \quad (22)$$

$$W_h = (\cos(\omega t))^2 \iint_{\rho, \theta} \left(\left(H_{\rho\rho}(\rho) \cos(\theta) \right)^2 + \sin^2(\theta) \left(\left(H_{\theta\rho}(\rho) \right)^2 + \left(H_{\varphi\rho}(\rho) \right)^2 \right) \right) d\rho d\theta. \quad (23)$$

Obviously, the amplitudes of energies W_e and W_h can be equal when the A , β_1 , β_2 - see (1–6) have certain values. In this case, the energies W_e and W_h transform into each other – see multipliers $(\sin(\omega t))^2$ and $(\cos(\omega t))^2$ in correlations (22, 23). Thus, the energy conservation law is fulfilled for the globe lighting as a whole in the obtained solution.

At the same time, Table 3 demonstrates that the energy conservation law is not met at each point of the sphere. Hence, there are energy flows between sphere points. This fact will be proved rigorously below.

4. The Energy Flow

4.1. Radial Energy Flux

There is an electromagnetic energy flux along the radius at each point of the sphere, see Fig. 5. The density vector of this flux is equal to

$$\mathbf{S}_\rho = \mathbf{E}_{\varphi\theta} \times \mathbf{H}_{\varphi\theta}. \quad (24)$$

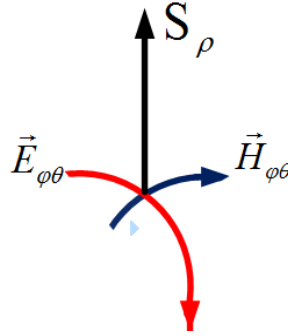

Fig. 5.

As the vectors $H_{\phi\theta}$, $E_{\phi\theta}$ are perpendicular, from (16, 20) it follows that:

$$|S_\rho| = |E_{\phi\theta}| |H_{\phi\theta}| = \frac{A^2}{4\rho^2} (\sin(\theta)(\sin(\phi)\sin(\omega t) + \sigma \cos(\phi)\cos(\omega t))) (\sin(\theta)\cos(\omega t))$$

or

$$|S_\rho| = \frac{A^2}{4\rho^2} \sin^2(\theta)\cos(\omega t)(\sin(\phi)\sin(\omega t) + \sigma \cos(\phi)\cos(\omega t))$$

or

$$|S_\rho| = \frac{A^2}{4\rho^2} \sin^2(\theta) \left(\frac{1}{2} \sin(\phi)\sin(2\omega t) + \sigma \cos(\phi)\cos^2(\omega t) \right) \quad (25)$$

In particular, for $\sigma = 0$ we have: $\sin(\phi) = 1$ and

$$|S_\rho| = \frac{A^2}{8\rho^2} \sin^2(\theta)\sin(2\omega t). \quad (26)$$

4.2. Spherical Energy Flux

At each point of the sphere, there are two fluxes of the electromagnetic energy tangent to the sphere, see Fig. 6. The density vector of these fluxes can be written as

$$S_1 = E_{\phi\theta} \times H_\rho, \quad (27)$$

$$S_2 = H_{\phi\theta} \times E_\rho. \quad (28)$$

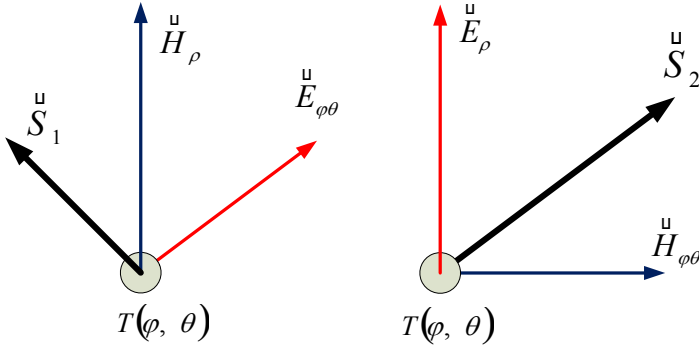

Fig. 6.

As the multiplied vectors are perpendicular, from (14, 16, 20) and Table 3 we can obtain:

$$|S_1| = |E_{\varphi\theta}||H_{\rho}| = \frac{A}{2\rho} \sin(\theta) (\sin(\phi) \sin(\omega t) + \sigma \cos(\phi) \cos(\omega t)) \bullet$$

$$\bullet H_{\rho\rho}(\rho) \cos(\theta) \cos(\omega t)$$

$$|S_2| = |H_{\varphi\theta}||E_{\rho}| = \frac{A}{2\rho} \sin(\theta) \cos(\omega t) \bullet$$

$$\bullet E_{\rho\rho}(\rho) \cos(\theta) (\sin(\phi) \sin(\omega t) + \sigma \cos(\phi) \cos(\omega t))$$

or

$$|S_1| = \frac{A}{2\rho} H_{\rho\rho}(\rho) \sin(\theta) \cos(\theta) \cos(\omega t) \left(\frac{\sin(\phi) \sin(\omega t) + \sigma \cos(\phi) \cos(\omega t)}{\sin(\phi) \sin(\omega t) + \sigma \cos(\phi) \cos(\omega t)} \right),$$

$$|S_2| = \frac{A}{2\rho} E_{\rho\rho}(\rho) \sin(\theta) \cos(\theta) \cos(\omega t) \left(\frac{\sin(\phi) \sin(\omega t) + \sigma \cos(\phi) \cos(\omega t)}{\sin(\phi) \sin(\omega t) + \sigma \cos(\phi) \cos(\omega t)} \right).$$

As these fluxes are perpendicular, the module of their sum can be determined by the formula

$$S_3 = |S_1 + S_2| = \left(\begin{array}{l} \frac{A}{2\rho} \sqrt{(H_{\rho\rho}^2(\rho) + E_{\rho\rho}^2(\rho))} \bullet \\ \bullet \sin(\theta) \cos(\theta) \cos(\omega t) \left(\frac{\sin(\phi) \sin(\omega t) + \sigma \cos(\phi) \cos(\omega t)}{\sin(\phi) \sin(\omega t) + \sigma \cos(\phi) \cos(\omega t)} \right) \end{array} \right) \quad (29)$$

In particular, for $\sigma = 0$ we have $\sin(\phi) = 1$ and

$$S_3 = |S_1 + S_2| = \left(\begin{array}{l} \frac{A}{2\rho} \sqrt{(H_{\rho\rho}^2(\rho) + E_{\rho\rho}^2(\rho))} \bullet \\ \bullet \sin(\theta) \cos(\theta) \cos(\omega t) \sin(\omega t) \end{array} \right)$$

or

$$S_3 = |S_1 + S_2| = \left(\frac{A}{8\rho} \sqrt{(H^2_{\rho\rho}(\rho) + E^2_{\rho\rho}(\rho))} \cdot \sin(2\theta) \sin(2\omega t) \right) \quad (30)$$

Considering (3, 6), for $\sigma = 0$ we have

$$S_3 = \frac{A^2 \sqrt{2}}{8\rho^3 q_1} \sin(2\theta) \sin(2\omega t). \quad (31)$$

4.3. Total Energy Flux

Let us find the electromagnetic energy flux divergence for $\sigma = 0$ from (26, 30):

$$\begin{aligned} \operatorname{div}(S_\rho + S_3) &= \frac{\partial S_\rho}{\partial \rho} + \frac{\partial S_3}{\partial \theta} = \\ &= \frac{\partial}{\partial \rho} \left(\frac{A^2}{8\rho^2} \sin^2(\theta) \sin(2\omega t) \right) + \frac{\partial}{\partial \theta} \left(\frac{A^2 \sqrt{2}}{8\rho^3 q_1} \sin(2\theta) \sin(2\omega t) \right) = \\ &= \frac{-2A^2}{8\rho^3} \sin^2(\theta) \sin(2\omega t) + \frac{2A^2 \sqrt{2}}{8\rho^3 q_1} \cos(2\theta) \sin(2\omega t) = \\ &= \frac{A^2}{4\rho^3} \left(\frac{\sqrt{2}}{q_1} \cos^2(\theta) - \left(\frac{\sqrt{2}}{q_1} + 1 \right) \sin^2(\theta) \right) \sin(2\omega t) \end{aligned} \quad (32)$$

Considering (7), we obtain that $\frac{\sqrt{2}}{q_1} \gg 1$. Then, from (32) one can find

that:

$$\operatorname{div}(S_\rho + S_3) = \frac{A^2 \sqrt{2}}{4\rho^3 q_1} \cos(2\theta) \sin(2\omega t). \quad (33)$$

This divergence of the total electromagnetic energy flux is not zero at many points of the sphere. This means that the energy flux passing through a point is not generally equal to zero. Hence, there is energy exchange between the sphere points. However, the energy conservation law is met for the overall sphere (see above). Thus, in the globe lightning:

- the energy conservation law is met,
- there is an electromagnetic energy flux.

5. About Ball Lightning Stability

The question of stability for bodies, in which a flow of electromagnetic energy is circulating, has been treated in [43]. Here we shall consider only such force that acts along the diameter and breaks the ball lightning along diameter plane perpendicular to this diameter. In the first moment it must perform work

$$A = F \frac{dR}{dt}. \quad (34)$$

This work changes the internal energy of the ball lightning, i.e.

$$A = \frac{dW}{dt}. \quad (35)$$

Considering (34, 35) together, we find:

$$F = \frac{dW}{dt} \bigg/ \frac{dR}{dt}. \quad (36)$$

If the energy of the global lightning is proportional to the volume, i.e.

$$W = aR^3. \quad (37)$$

where a – is the coefficient of proportionality, then

$$\frac{dW}{dt} = 3aR^2 \frac{dR}{dt}. \quad (38)$$

Thus,

$$F = \frac{dW}{dt} \bigg/ \frac{dR}{dt} = 3aR^2 = \frac{3W}{R}. \quad (39)$$

Thus, the internal energy of a ball lightning is equivalent to the force creating the stability of ball lightning.

6. About Luminescence of the Ball Lightning

The problem was solved above considering the electric resistance of the globe lightning. Naturally, it is not zero, and when current flows through it, thermal energy is released. This thermal energy is radiated that is the cause of globe lightning illumination.

7. About the Time of Ball Lightning Existence

We can assume that the globe lightning energy is equal to the amplitude of the electric energy, i.e. according to (22),

$$W = \sin^2(\phi) \iint_{\rho, \theta} \left((E_{\rho\rho}(\rho) \cos(\theta))^2 + \sin^2(\theta) \left((E_{\theta\rho}(\rho))^2 + (E_{\varphi\rho}(\rho))^2 \right) \right) d\rho d\theta. \quad (40)$$

The heat loss power is equal to the derivative of the heat loss energy with respect to time. Expression (23) gives the instantaneous energy of heat losses. Therefore,

$$P = \sqrt{2}(\sigma \cos(\phi))^2 \iint_{\rho, \theta} \left((E_{\rho\rho}(\rho) \cos(\theta))^2 + \sin^2(\theta) \left((E_{\theta\rho}(\rho))^2 + (E_{\varphi\rho}(\rho))^2 \right) \right) d\rho d\theta. \quad (41)$$

The existence time of the globe lightning is equal to the time the electrical energy transforms into the heat losses, i.e.

$$\tau = \frac{W}{P}. \quad (42)$$

From (40-42) we can obtain:

$$\tau = \frac{\sin^2(\phi)}{\sqrt{2}(\sigma \cos(\phi))^2} = \frac{tg^2(\phi)}{\sqrt{2}\sigma^2}. \quad (43)$$

8. About a Possible Mechanism of Ball Lightning Formation

The leader of a linear lightning, meeting a certain obstacle, may alter the motion trajectory from linear to circular. This may become the cause of the emergence of the described above electromagnetic fields and currents.

In [44] this process was described as follows:

Another strong bolt of lightning, simultaneous with a bang, illuminated the entire space. I can see how a long and dazzling beam in the color of sun beam approaches to me right in the solar plexus. The end of it is sharp as a razor, but further it becomes thicker and thicker, and reaches something like 0,5 meter. Further I can't see, as I am staring at a downward angle.

Instant thought that it is the end. I see how the tip of the beam approaches. Suddenly it stopped and between the tip and the body began to swell a ball the size of a large grapefruit. There was a thump as if a cork popped from a bottle of champagne. The beam flew into a ball. I see the blindingly bright ball, color of the sun, which rotates at a breakneck pace, grinding the beam inside. But I do not feel any touch, any heat.

The ball grinds the ray and increases in size. ... The ball does not issue any sounds. At first it was bright and opaque, but then begins to fade, and I see that it is empty. Its shell has changed and it became like a soap bubble. The shell rotates, its diameter remained stable, but the surface was with metallic sheen.

General conclusions

“To date, whatsoever effect that would request a modification of Maxwell’s equations escaped detection” [36]. Nevertheless, recently criticism of validity of Maxwell equations is heard from all sides. This criticism is based mainly on the fact that the known solution of Maxwell's equations describing the electromagnetic wave, has the following two properties:

- it does not satisfy the law of conservation of energy, because the electromagnetic energy flux density pulsating harmonically,
- it prove phase synchronism of electrical and magnetic components of intensities in an electromagnetic wave ; but this is contrary to the idea of constant transformation of electrical and magnetic components of energy in an electromagnetic wave.

These properties of known solutions are clearly visible in Fig. 1.

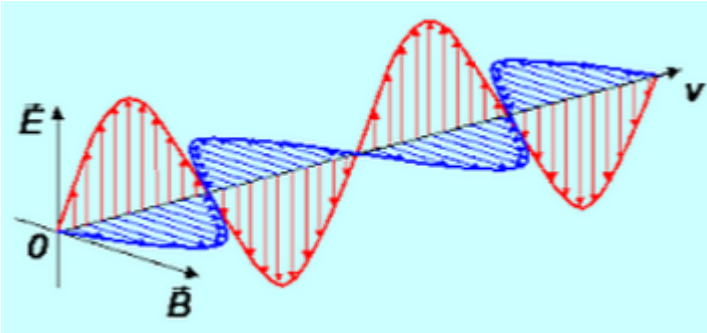

Fig. 1.

Such results following from the known solution of Maxwell equations allow doubting the authenticity of Maxwell equations. However, we must stress that these results follow **only from the found solution**. But this solution, as has been stated above, can be different (in their partial derivatives, equations generally have several solutions). Above shows **another solution** of Maxwell's equations. Electric and magnetic intensities in Cartesian coordinates, obtained as a result of this decision, are shown in Fig. 2.

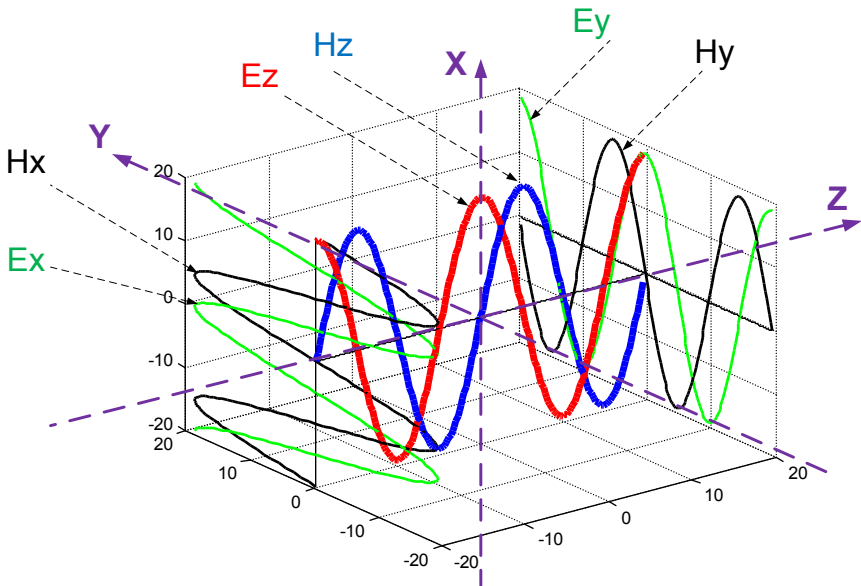

Fig. 2.

The resulting solution describes a wave. The main distinctions from the known solution are as follows:

1. Instantaneous (and not average by certain period) energy flow does **not change** with time, which complies with the **Law of energy conservation**.
2. Magnetic and electrical intensities on one of the coordinate axes **phase-shifted by a quarter of period**.
3. The vectors of electrical and magnetic intensities are **orthogonal**.
4. The flow of electromagnetic energy **propagates along** a wave (not only in vacuum but also in the wire).

In addition, consider an electromagnetic wave in wire. With an assumed negligibly low voltage, Maxwell's equations for this wave literally coincide with those for the wave in vacuum. Yet, electrical engineering eludes any known solution and employs the one that connects an intensity of the circular magnetic field with the current in the wire (for brevity, it will be referred to as "electrical engineering solution"). This solution, too, satisfies the Maxwell's equations. However, firstly, it is one more solution of those equations (which invalidates the theorem of the only solution known). Secondly, and the most important, electrical engineering solution does not explain the famous experimental fact.

The case in point is skin-effect. Solution to explain skin-effect should contain a non-linear radius-to-displacement current (flowing along the wire) dependence. According to Maxwell's equations, such dependence should fit with radial and circular electrical and magnetic intensities that have non-linear dependence from the radius. Electrical engineering solution offers none of these. Explanation of skin-effect bases on the Maxwell's equations, yet it does not follow from electrical engineering solution. It allows the statement that electrical engineering solution does not explain the famous experimental fact.

Now, refer to energy flux in wire. The existing idea of energy transfer through the wires is that the energy in a certain way is spreading outside the wire [13]. Such theory contradicts the Law of energy conservation. Indeed, the energy flow, travelling in the space must lose some part of the energy. But this fact was found neither experimentally, nor theoretically. But, most important, this theory contradicts the following experiment. Let us assume that through the central wire of coaxial cable runs constant current. This wire is isolated from the external energy flow. Then whence the energy flow compensating the heat losses in the wire comes? With the exception of loss in wire, the flux should penetrate into a load, e.g. winding of electrical motors covered with steel shrouds of the stator. This matter is omitted in the discussions of the existing theory.

The obtained solution of Maxwell's equations simulate a structure of an electromagnetic wave, in which there is a flow of electromagnetic energy propagating in and **along** the wire.

The resulting solution describes the electromagnetic wave

- in vacuum,
- in wire with alternating and constant current,
- in magnetic circuit of alternating current,
- in charging and charged capacitor – flat and spherical,
- in ball lightning,
- in the vicinity of solitary electrical charge.

The resulting solution allows us to explain

- twisted of light,
- single-wire transmission of energy,
- nature of the Earth's magnetism,
- nature of energy stored in a charged capacitor,
- nature of the energy stored in ball lightning, and some of its properties,
- functioning Milroy engine.

The solution obtained shows that path of the point, which moves along a cylinder of given radius in such a manner, that each intensity value varies harmonically with time, is described by a helix. This statement is true for an electromagnetic wave in the wire, in any environment, in vacuum - Fig. 4.

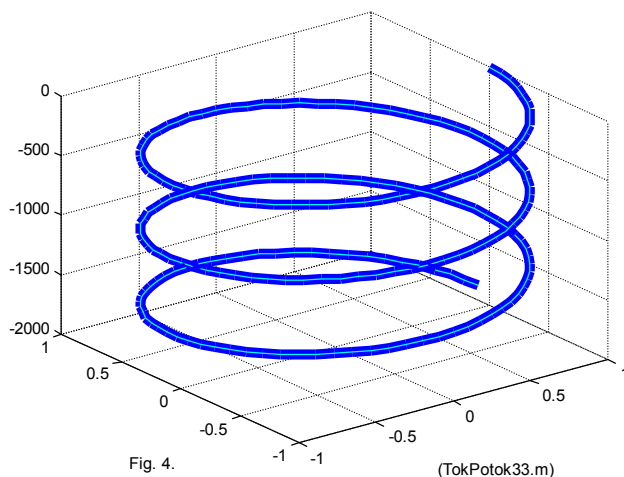

At each point, which moves along this helix, vectors of magnetic and electric intensities:

- exist only in the plane which is perpendicular to the helix axis, i.e. there only two projections of these vectors exist,
- vary in a sinusoidal manner,
- are shifted in phase by a quarter-period.

Resultant vectors:

- rotate in these plane,
- have constant moduli,
- are orthogonal to each other.

References

- Comment:* **Vixra**, <http://vixra.org>,
DNA – The Papers of independent Authors,
ISSN 2225-6717, <http://dna.izdatelstwo.com/>
1. Kann K.B. Electrodynamics. Electromagnetic waves, <http://electrodynamics.narod.ru/em-waves.html>
 2. The bias current and Maxwell's equations, <http://www.webpoliteh.ru/subj/dinamo/767-25-tok-smeshheniya-i-sistema-uravnenij-maksvella.html>
 3. Rozanov N.N. Special sections of mathematical physics. Part 3. The electromagnetic waves in a vacuum. ITMO. St. Petersburg, 2005.
 4. Andre Ango. Mathematics for Electrical and Radio Engineers, publ. "Nauka", Moscow, 1964, 772 p. (in Russian).
 5. Khmel'nik S.I. The Second Solution of Maxwell's Equations, ViXra, 2016-01-26, <http://vixra.org/abs/1602.0084>; and ViXra, 2016-01-26, <http://vixra.org/abs/1601.0292> (in Russian); and DNA, № 35, 2016, see [here](#) (in Russian).
 6. Khmel'nik S.I. Mathematical Model of Electric Tornado, ViXra, 2015-04-11, <http://vixra.org/abs/1504.0088>; and DNA, № 33, 2015, see [here](#) (in Russian); and ViXra, 2015-04-11, <http://vixra.org/abs/1504.0088> (in Russian); and DNA, № 33, 2015, see [here](#).
 7. Khmel'nik S.I. The Second Structure of Constant Current, ViXra, 2015-11-24, <http://vixra.org/abs/1511.0231>; and ViXra, 2015-11-21, <http://vixra.org/abs/1511.0206> (in Russian); DNA, № 35, 2016, see [here](#) (in Russian)
 8. Khmel'nik S.I. Electromagnetic Energy Flux in a Conductor with a Alternating Current, ViXra, 2015-03-10, <http://vixra.org/abs/1503.0068> (in Russian).
 9. Khmel'nik S.I. Electromagnetic Energy Flux in a Conductor with a Constant Current, ViXra, <http://vixra.org/abs/1503.0048>, 2015-03-07 (in Russian); and DNA-33, 2015 (in Russian).
 10. Khmel'nik S.I. Structure of Constant Current, ViXra, <http://vixra.org/abs/1503.0241>, 2015-03-29 (in Russian); and DNA-33, ID16537771, 2015 (in Russian).

11. Khmelnik S.I. The Flow Structure of the Electromagnetic Energy in the Wire with Constant Current, ViXra, <http://vixra.org/abs/1504.0061>, 2015-04-08 (in Russian); *and* DNA-33, 2015 (in Russian).
12. Torshin V.V., Busygin B.P., Pashchenko F.F., Krukovskiy L.E. Effect of direct electric current generation in static conductor in constant magnetic field. Trapeznikov Institute of Control Sciences of Russian academy of Sciences Journal of Modern Science and Education, issue 12, 2008 (in Russian), <http://cyberleninka.ru/article/n/effekt-generatsii-postoyannogo-elektricheskogo-toka-v-nepodvizhnom-provodnike-v-postoyannom-magnitnom-pole>
13. R.P. Feynman, R.B. Leighton, M. Sands. The Feynman Lectures on Physics, volume 2, 1964.
14. Khmelnik S.I. Flow of Electromagnetic Energy in the Wire and the Milroy Engine, Vixra, <http://vixra.org/abs/1510.0396>, 2015-10-26 (in Russian).
15. Khmelnik S.I. The Electromagnetic Wave in Alternating Current Wire, Vixra, 1603.0020, 2016-03-02, <http://vixra.org/abs/1603.0260>; *and* Vixra, 1603.0020, 2016-03-02, <http://vixra.org/abs/1603.0020> (in Russian).
17. Khmelnik S.I. The Experiment Confirming the Existence of the Fourth Electromagnetic Induction, ViXra, <http://vixra.org/abs/1601.0215>, 2016-01-20 (in Russian).
18. Khmelnik S.I. Khmelnik Force, DNA-28.153; *and* Vixra - <http://vixra.org/abs/1407.0076>.
19. Khmelnik S.I. The Fourth Electromagnetic Induction, DNA-31.197 (in Russian), *and* Vixra, <http://vixra.org/abs/1412.0224>.
20. <https://ru.wikipedia.org/wiki/Рельсотрон> (in Russian).
21. L.D. Landau, E.M. Lifshitz, Field theory.
22. Tamm I.E. Fundamentals of the theory of electricity, Moscow, FIZMATLIT, 2003, p. 547.
23. Khmelnik S.I. Faraday Unipolar Motor and the Impulse Preservation Law, DNA-23.155 (in Russian), *and* Vixra - <http://vixra.org/abs/1404.0428> (in Russian).
24. Khmelnik S.I. To the Question of intranuclear Forces, DNA-28.125, *and* Vixra, <http://vixra.org/abs/1405.0347>.
25. Khmelnik S.I. Lorentz Force, Ampere Force and Momentum Conservation Law Quantitative. Analysis and Corollaries, DNA-28.145, *and* Vixra, <http://vixra.org/abs/1407.0066>.

References

26. Khmelnik S.I. Invertibility Principle in Faraday Unipolar Machines, DNA-28.160, *and* Vixra, <http://vixra.org/abs/1407.0146>.
27. Khmelnik S.I. Experiment for the proof of Newton's Third Law Violation in Unipolar Motor, Vixra, <http://vixra.org/abs/1501.0102>.
28. Strebkov D.S. Electric power transmission without metal wires, <http://www.electrolibrary.info/tesla/peredachaenergii.htm>
29. Rothammel K. Antennas, publ. "Energy", 1967, [http://www.radiouniverse.ru/book/antenny/2-1-antenna-v-
vide-dlinnogo-provoda](http://www.radiouniverse.ru/book/antenny/2-1-antenna-v-vide-dlinnogo-provoda)
30. N.E. Zaev. Superconductors engineer Avramenko. "Technology - Youth", №1, Moscow, 1991 (in Russian).
31. Inventor, 1992, №5, 6, 1-32 (in Russian).
32. Кулигин В.А., Корнева М.В., Кулигина Г.А., Большаков Г.П. Безинерциальные заряды и токи, <http://www.n-t.ru/ac/iga/> (in Russian).
33. M. Lobo, G. Shipov, Tawatchai Laosirihongthong, Supakit Chotigo. Experimental observation of scalar electromagnetic field. King Mongkut's University of Technology, Thonburi, Bangkok, 10140, Thailand, [http://www.trinitas.ru/rus/doc/0231/004a/1032-
MonopolE.pdf](http://www.trinitas.ru/rus/doc/0231/004a/1032-MonopolE.pdf) (in Russian)
34. N.E. Zaev, S.V. Avramenko, V.N. Lisin. Measurement of conduction current excited by polarization current. <http://rusphysics.ru/dissertation/269/> (in Russian)
35. N.V. Kosinov. Experiments in wireless energy transmitting: proof of N. Tesla's revolutionary ideas, <http://kosinov.314159.ru/kosinov31.htm>
36. Wikipedia, Maxwell's equations, (in Russian), https://ru.wikipedia.org/wiki/Уравнения_Максвелла.
37. Khmelnik S.I. The Electromagnetic Wave in the Dielectric and Magnetic Circuit of Alternating Current, Vixra, <http://vixra.org/abs/1603.0151>
38. Leedskalnin "Perpetual Motion Holder" (PMH) Bond Effect [http://peswiki.com/index.php/Directory:Leedskalnin %22P
erpetual Motion Holder%22 \(PMH\) Bond Effect](http://peswiki.com/index.php/Directory:Leedskalnin_%22Perpetual_Motion_Holder%22_(PMH)_Bond_Effect)
39. Khmelnik S.I. To the Theory of Perpetual Motion Holder. DNA-22.66; *and* ViXra, <http://vixra.org/abs/1310.0239>.
40. Coulomb's Law (in Russian),

-
- https://ru.wikipedia.org/wiki/Закон_Кулона
41. Kapitsa P.L. On the nature of ball lightning. DAN USSR, 1955, Volume 1 (in Russian).
 42. http://www.wikiznanie.ru/ru-wz/index.php/Шаровая_молния (in Russian).
 43. Khmelnik S.I. To the Question of Intranuclear Forces. DNA-27; *and* Vixra, To the Question of Intranuclear Forces, <http://vixra.org/abs/1405.0347>, 2014-05-28.
 44. Anatoly Mäkeläinen (Finland), Valery Buerakov (Ukraine). Flying on ball lightning, https://drive.google.com/file/d/0B4rZDrYTBG_pMFZ1RFNOd2hSTDA/edit (in Russian)
 45. Khmelnik S.I. Variational Principle of Extremum in Electromechanical and Electrodynamic Systems. Publisher by “MiC”, printed in USA, Lulu Inc., ID 1142842, 2014, ISBN 9780557082315.
 46. <https://www.youtube.com/watch?v=zQYFMJSKiu8>
 47. Really working perpetuum mobile on magnets, part 2, <http://x-faq.ru/index.php?topic=4144.msg119758;topicseen#msg119758>
 48. <http://x-faq.ru/index.php?topic=4144.new#new>, message 1271, 25.10.2016.
 49. The magnetic field inside the capacitor (in Russian), <https://www.youtube.com/watch?v=RNkYd1mueYk>
 50. Compass inside the condenser (in Russian), <https://www.youtube.com/watch?v=A4vO2rLvtug>
 51. D.V. Sivukhin. The general course of physics. Volume 3. Electricity (in Russian).
 52. Earth's magnetic field (in Russian), https://ru.wikipedia.org/wiki/Магнитное_поле_Земли
 53. Earth currents, Wikipedia (in Russian), https://ru.wikipedia.org/wiki/Земные_токи
 54. Khmelnik S.I. The Electromagnetic Wave in a Spherical Capacitor and the Nature of Earth Magnetism, Vixra, <http://vixra.org/abs/1604.0371>, 2016-04-26; *and* DNA-36.103 (in Russian).
 55. Khmelnik S.I. Mathematical Model of Ball Lightning, DNA-33, 2015 - см. [здесь](#) (in Russian); *and further*: Vixra, <http://vixra.org/abs/1503.0076>, 2015-03-11 (in Russian); *and further*: Vixra, <http://vixra.org/abs/1503.0065>, 2015-03-09.
 56. Khmelnik S.I. Second Mathematical Model of Ball Lightning, <http://vixra.org/abs/1605.0279>, 2016-05-28.
-

57. Wen Y K. Dynamic tornado wind loads on tall buildings / Wen Y.K. // Journ. Of Struct. Div., Proc. ASCE, 1975, STI, p.169.
58. A.A. Vlasov. About vibration properties of electron gas, Journal of Experimental and Theoretical Physics, 1938, Vol. 8 (3), in Russian,
http://ufn.ru/ufn67/ufn67_11/Russian/r6711f.pdf,
https://ru.wikipedia.org/wiki/Уравнение_Власова
59. P.B. Rutkevich, P.P. Rutkevich Axisymmetric model of tornado type instability, in Russian,
http://d33.infospace.ru/d33_conf/2011v8n4/76-82.pdf
60. Spouts and Tornado (in Russian),
http://www.krugosvet.ru/enc/nauka_i_tehnika/fizika/smerc_hi_i_tornado.html?page=0,3
61. Modelling of the "eye" of cyclones, tornados, tornadoes, global ocean currents, in Russian,
http://old.msun.ru/vector/Konuhov_ATR/Glaz_ciklona.htm
62. Artsimovich L.A., Sagdeev R.Z. Plasma physics for physicists. M.: "Atomizdat", 1979 (in Russian).
63. Ivanov V.V. Course of general physics (in Russian).
http://lms.physics.spbstu.ru/pluginfile.php/2134/mod_resource/content/1/opt_1_03.pdf
64. Igor Ivanov Twisted light and twisted electrons: review of the recent results, http://elementy.ru/nauchno-populyarnaya_biblioteka/432009/Zakruchennyy_svet_i_zakruchenny_elektrony_obzor_poslednikh_rezultatov