

HORIZONTAL PLANAR MOTION MECHANISM (HPMM) INCORPORATED TO THE EXISTING TOWING CARRIAGE FOR SHIP MANOEUVRING STUDIES

Akhil Balagopalan

Department of Ocean Engineering
Indian Institute of Technology, Madras
Chennai, India. 600036
Email: bgakhil@gmail.com

Kunal N. Tiwari

Department of Ocean Engineering
Indian Institute of Technology, Madras
Chennai, India. 600036
Email: kt@fourier.in

P Krishnankutty

Department of Ocean Engineering
Indian Institute of Technology, Madras
Chennai, India. 600036
Email: pkrishnankutty@iitm.ac.in

ABSTRACT

Planar Motion Mechanism (PMM) equipment is a facility generally attached with Towing Tank to perform experimental studies with ship models to determine the manoeuvring characteristics of a ship. Ship model is oscillated at prescribed amplitude and frequency in different modes of operation while it is towed along the towing tank at predefined speed. The hydrodynamic forces and moments are recorded, analyzed and processed to get the hydrodynamic derivatives appearing in the manoeuvring equations of motion of a ship. This paper presents the details about the Horizontal Planar Motion Mechanism (HPMM) equipment which is designed, developed and installed in Towing Tank laboratory at IIT Madras.

NOMENCLATURE

r	Yaw velocity.
u	Surge velocity.
v	Sway velocity.
x_E	Position in x-direction.
y_E	Position in y-direction.
y_a	Sway amplitude.
x_s	Distance between load cell mounting and midship.
β	Drift angle.
ψ	Euler angle for rotation about z-axis.
ψ_a	Yaw amplitude.

1 INTRODUCTION

Manoeuvring quality assessment for ships are essential for the navigational safety purpose. International Maritime Organisation (IMO) has prescribed safety guidelines for the sea going vessels to ensure its navigational safety and operational efficiency. Manoeuvrability of ships depends on the and the effectiveness of rudder or other control devices. The accurate prediction of manoeuvring behaviour of the vessel has to be done at design stage itself. Directional stability and control characteristics of ship are understood by solving the manoeuvring equation of motion, for which the knowledge of hydrodynamic derivatives are essential. The quality of manoeuvring behaviour prediction relies on the accuracy at which the hydrodynamic derivatives are estimated. The hydrodynamic derivatives are usually determined by theoretical, numerical or experimental methods. Empirical relations provided by researchers such as M Hirano *et al.* [1], Kijima *et al.* [2] gives a rough estimate of the hydrodynamic derivatives but fails to predict non linear and coupled derivatives accurately. More reliable values can be obtained only by conducting captive model testings on ship models, of which Planar Motion Mechanism is the widely used one. Planar Motion Mechanism (PMM) pioneered by Gertler and Goodman *et al.* (1962) [3] is considered to be the major outbreak for captive model testings in ship manoeuvring area. Large amplitude planar motion mechanisms installed around the world in early years of 1980s provided much more enlightenment in ship motion predictions. PMM facility installed in a towing tank enable us to perform the dynamic tests in pure sway, pure yaw and combined sway and yaw modes of model oscillations. These dynamic tests provide

the data for almost all the linear as well as non linear hydrodynamic derivatives, both velocity and acceleration dependent ones. The Fourier series representation of the force and moment time histories recorded from the model during these tests leads to the determination of the hydrodynamic derivatives. These hydrodynamic derivatives can be used to simulate the vessel trajectory to assess the manoeuvring quality of the ship.

This paper describes about the Planar Motion Mechanism setup recently installed in the Towing Tank Laboratory of Ocean Engineering Department, IIT Madras. Preliminary calculation of forces and moments in different PMM motions are estimated during the initial stage of design. After considerable study of the limitations of the existing Towing Tank and Towing Carriage, PMM design parameter are determined. As the In house fabrication of the mechanical and electronic components are not a viable option, the fabrication of PMM setup was awarded to Rockwell Automation India Pvt. Ltd.

2 PMM Design Aspects



FIGURE 1. Towing Tank and Carriage

IIT Madras Towing Tank (Fig. 1) has a length of 83m, breadth 3.2m and depth 2.8m, which are used for different ship model testings. Towing carriage is of length 4m in length and 3.75m in breadth and is capable of towing the ship model at a maximum speed of 5m/s. Four DC servo motors are connected to each of the carriage wheels in series and are controlled by Ward Leonard drive system. Towing carriage test well is of 3m x 1.35m in dimension and is slightly off from the centre line of the towing tank to accommodate the control consoles inside the carriage. PMM design was formulated by considering these aspects and are listed in Table 1.

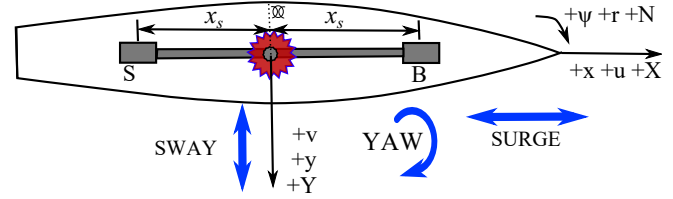

FIGURE 2. Sign Conventions

TABLE 1. PMM Design parameters

Parameter	Design consideration	Maximum value
Sway Amplitude	1. Adequate clearance between ship model and tank wall 2. Minimum interaction with wall. [4]	380 mm
Angular Frequency	1. Number of cycles in steady speed condition 2. Minimum 4-5 cycles.	2.5 rad/s
Yaw Amplitude	1. Adequate clearance between ship model and tank wall 2. Minimum interaction with wall.	15°
Model Size	1. Towing carriage test well limitations. 2. Tank wall clearances.	4.5 m

3 Horizontal Planar Motion Mechanism

PMM is mechanism where ship model is held and subjected to specific harmonic motions while being towed along the length of towing tank. Traditionally two independent oscillators were used to produce oscillations [5–7]. Due to space constrains in our towing tank, a different twin motor approach was considered. Two different motors are used to produce transnational motion in y_0 direction and rotational motion with respect to z-axis respectively (refer Fig 5 and Fig. 4).

The block diagram of the PMM mechanism is given in Fig. 3. Different motion felt by various components of mechanism is chalked out on the right side of the figure. Carriage, PMM base frame and sway mechanism experience just surge motion. Yaw mechanism experiences sway motion along with the surge. Loadcell and ship model experience all the three forced mode of motion (surge, sway and yaw). It should be noted that ship model is free to pitch and heave. The flow of data is represented by means of blue lines. The communication between servo motor and drive takes place through customised Allan-Bradly feedback cable while those between drive, PLC for PMM, PLC for carriage (existing system) and HMI (existing hardware with updated software) takes place through ethernet.

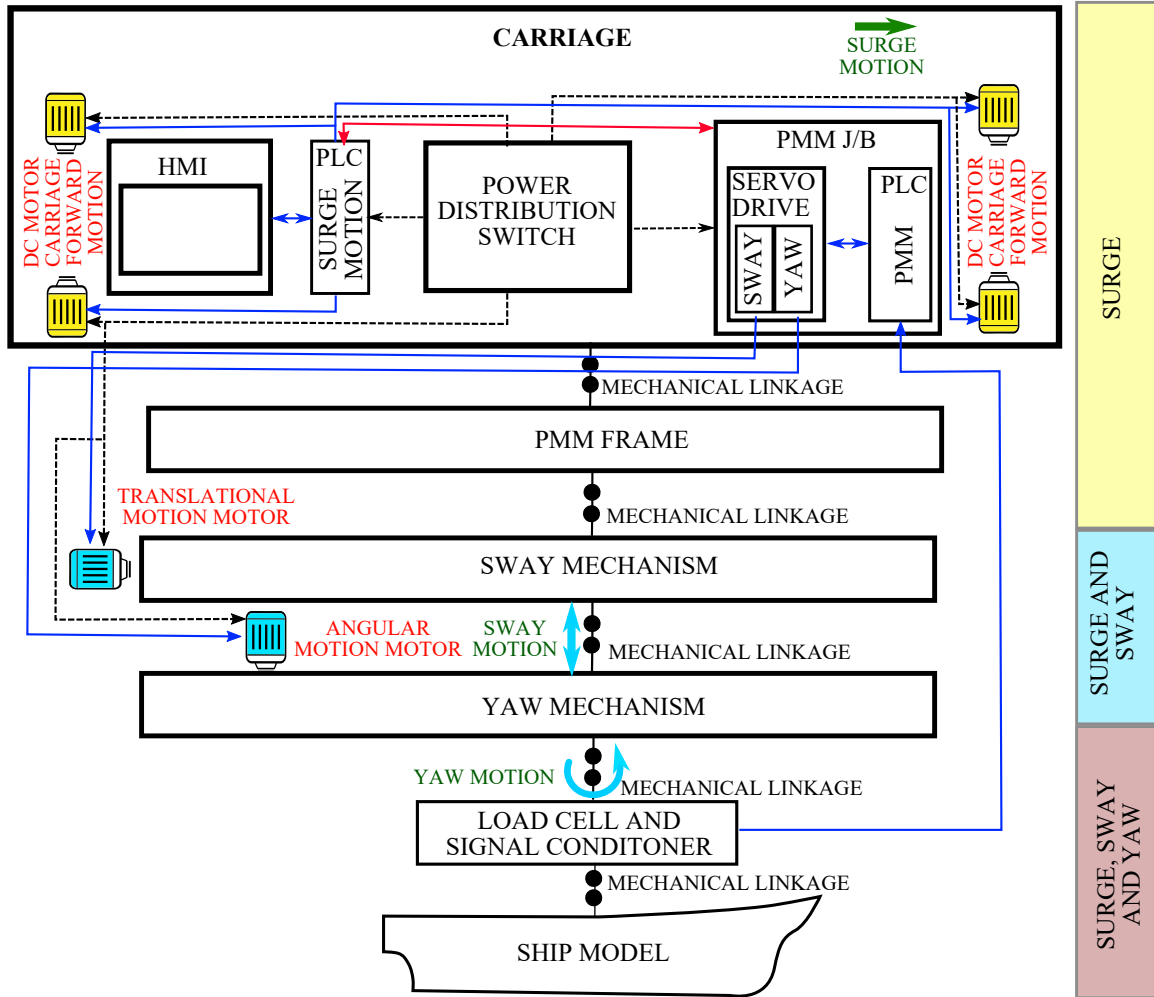

FIGURE 3. Block Diagram for HPMM setup

PMM uses a standard right handed coordinate system with x-axis (surge) is positive in the forward direction of carriage movement, y-axis (sway) is positive to starboard relative to the forwards motion of the carriage and z-axis (heave) pointing downwards (into the paper). Rotation around the z-axis (Yaw) is positive for rotation to starboard, clockwise when looking down on the model with bow pointing in the forward direction of the carriage movement (refer Fig. 2 for clarity).

3.1 Pure Sway

In pure sway mode of operation, the model is oscillated sinusoidally in the lateral direction with its axis always parallel to the axis of the towing tank while it is moving forward with a specified speed (Fig 6). This motion is generated by keeping the angular motor locked and subjecting transnational motion motor to follow cosine motion as follows,

$$y_E = y_a \cos(\omega t) \quad (1)$$

$$\psi_E = 0^\circ \quad (2)$$

This ensures that yaw velocity and yaw acceleration are zero; the forces measured will be resulting due to sway motion alone.

The linear or sway motion is achieved in PMM setup through the servomotor and with a lead screw mechanism. Servomotor is attached to the lead screw using a belt drive arrangement. When the linear motor rotates, the slide plate arrangement, which includes rotational bevel gear and vertical shaft, move to and fro transversely through the linear guide (refer Fig. 7). The linear motion will be transmitted to the ship model through the PMM arms, which is connected to the ship model.

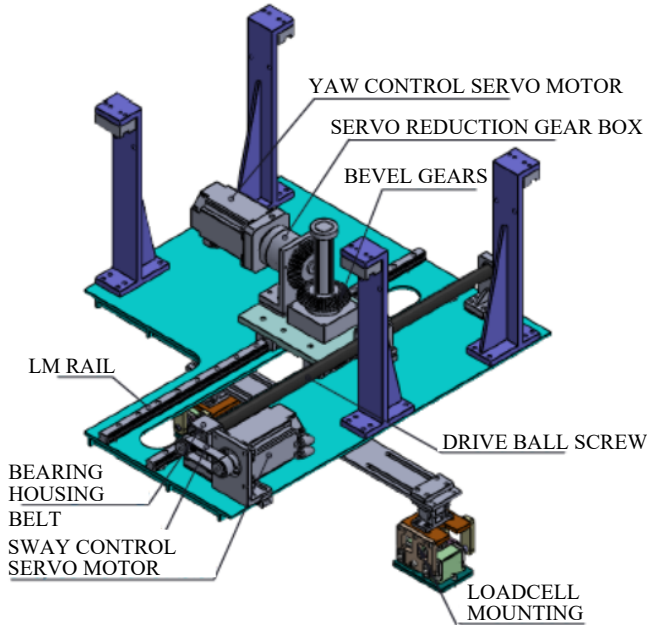

FIGURE 4. Birds eye view of PMM design

3.2 Pure Yaw

In pure yaw mode of operation, the model is oscillated sinusoidally in the lateral direction with its axis always tangential to the sinusoidal path while it is moving forward with a specified speed (refer Fig. 8). The idea is to ensure sway velocity and acceleration is zero. The cam points required for this mode are generated using,

$$y_E = y_a \cos(\omega t) \quad (3)$$

$$\psi = -\psi_a \sin(\omega t) \quad (4)$$

The rotary or yaw motion is achieved through a centrally mounted gear mechanism. The bevel gear assembly with pinion is mounted on the linear motion slide plate assembly through a central vertical shaft (Fig. 9). The assembly is provided with thrust bearings and end supports. Servomotor is attached with the bevel gear mechanism by using fixtures. Use of cosine function for translation motion motor (as opposed to sine function used traditionally [5–8]) ensures that jerk at start of the motion is minimized.

3.3 Combined Mode

In the combined sway and yaw mode of operation, the model is oscillated sinusoidally in the lateral direction with its axis always having a prescribed drift angle along the sinusoidal path

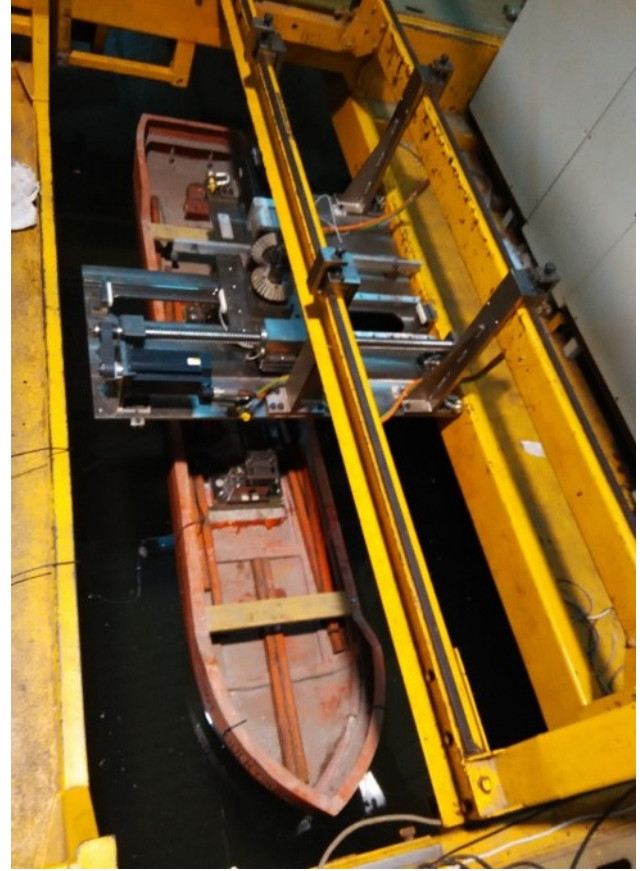

FIGURE 5. Ship model attached to PMM setup

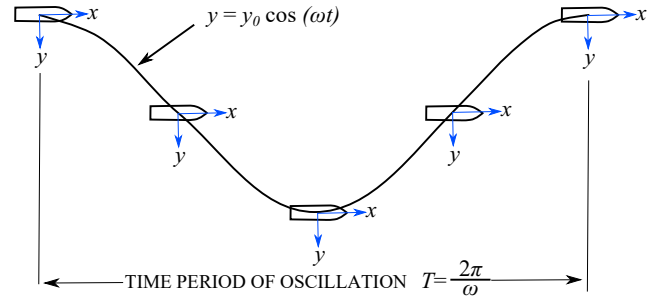

FIGURE 6. Path and orientation of model in pure sway mode

while it is moving forward with a specified speed (refer Fig. 10). The cam points required for this mode are generated using,

$$y_E = y_a \cos(\omega t) \quad (5)$$

$$\psi_E = -\psi_a \sin(\omega t) + \beta \quad (6)$$

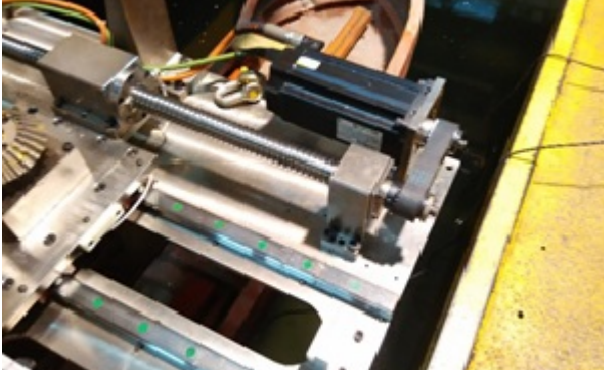

FIGURE 7. Transnational drive mechanism

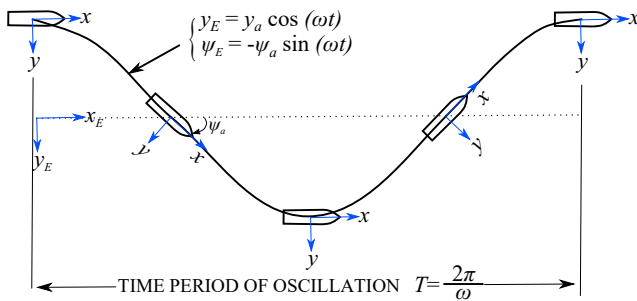

FIGURE 8. Path and orientation of model in pure yaw mode

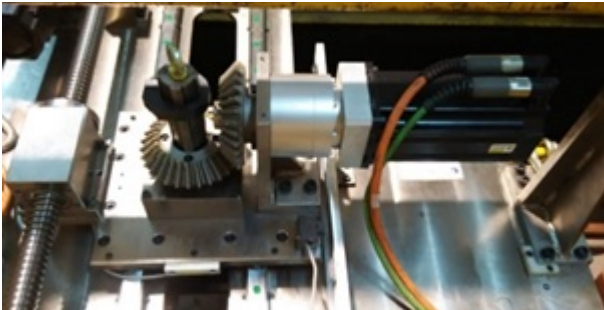

FIGURE 9. Angular drive mechanism

4 Instrumentation and Data Acquisition

The objective of PMM is to measure forces and moments acting on hull when the model is being oscillated in prescribed manner. In this section we will discuss the transducers used to measure forces on model and mechanical arrangement to ensure proper resolution of forces.

4.1 Load Cells

Two S-type loadcells (refer [9] for strain gauge based load-cell details) are mounted on ship model; one at forward side and one at aft equidistant from the midship (refer Fig. 2). A special

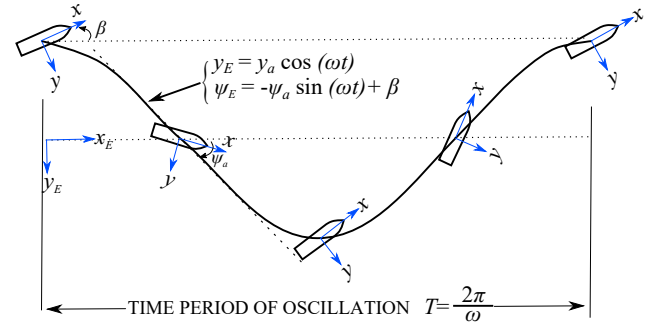

FIGURE 10. Path and orientation of model in combined sway and yaw mode

mounting arrangement (refer Fig. 11 and Fig. 12) made in order to ensure only forces in y-direction (direction of sway) are measured while other forces and moments are ignored. Another feature of mounting arrangement is that loadcell experiences compression when the model is experiencing positive sway and tension when model is experiencing negative sway, this enables us to measure forces in both (negative and positive) direction for sway motion. The maximum distance from midship at which the loadcell can be mounted (maximum x_s) is 0.45m for current mechanism. Currently we are having provision to use either 10kg IPA loadcells or 100kg Honeywell loadcell.

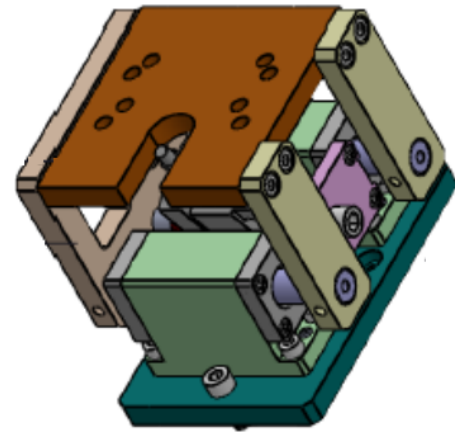

FIGURE 11. loadcell mounting arrangement design

4.2 Signal Conditioner

The signal conditioner unit consists of an instrumentation amplifier that is designed to accept low-level differential signals from a transducer bridge [10]. The amplified output is relayed to 4 channel analog input module of Control Logix Processor through shielded two core twisted pair cable. Grounding of the

