

# The Sugar Project & the Hydro-magnetic Catalyst: On the Origin of Conscious Life

Carlino Christian Francesco

## Abstract

Following work deals with the realization of an experimental model called Hydro-Magnetic Catalyst (HMC) which has allowed to provide early experimental confirmations for a new paradigm of In-Formation of matter, useful for the study of the origin of consciousness and life. In the first and second parts of the manuscript the author tries to answer to following questions: how can self-awareness, experiential semantics, higher brain functions such as thought and memory arise from a physical system of any complexity? The results obtained with the experimental model of the Hydro-magnetic Catalyst (HMC) allow to infer the following conclusions: -The brain can be considered as a highly sophisticated system of decoding data coming from phenomenal reality (Explicated Order) and from the hidden alocal and atemporal in-formation holographic field (Implicated Order):

- Consciousness and mind are no longer considered as a consequentially necessary product of the action of a complex physical system such as the brain, but as the product of a process of decoding information coming from the Implicate Order (or Holographic Matrix), among which, those concerning self-awareness, are the first to be captured and decoded.

- Fractals and toroidal patterns, by virtue of their geometric properties, can be the "dimensional bridge" through which the communication between the holographic matrix and the phenomenal space-time reality occurs within the brain where the interaction between vicinal water and magnetic fields of weak intensity and frequency included in the alpha range (8-13Hz), determines the appearance of fractal wave and toroidal structures.

- the interaction between water and magnetic fields oscillating with frequency in the alpha and beta range is also fundamental for the qualitative perception of stimuli from the external environment (qualia). This perception can be measured by means of an index called Quantillium (QI) which represents the ratio between the excitability variation of the aqueous medium (core) with respect to the excitability variation of the computational system, following the application of stimuli of various kind.

- neurons and neuronal networks are not the repositories of consciousness and higher brain functions. They constitute the information decoding hardware. This decoding is mostly digital, but passive properties of the neuronal cells and their interconnections allow for a digital-to-analog reversion of the signal with a system similar to the r-ladder one. This analog signal is probably responsible for the transmission of information to the aqueous environment (where the interaction with the oscillating magnetic fields determines the presence of fractal dimensional bridges), for their amplification through feedback phenomena, and for the perception, during waking state, of a continuous and conscious thought flow.

## **Index**

- **Pag.3: Why Sugar Project?**
- **Pag.4: Introduction**
- **Pag.6: The Hydro-Magnetic Catalyst Part One: Causal Power, Qualia and Quantillium**
- **Pag.19: The Hydro-Magnetic Catalyst Part Two: Consciousness and the Holographic Universe**
- **Pag.24: The Hydro-Magnetic Catalyst Part Three: Origin of Life**
- **Pag.26: Conclusions**
- **Pag.27: References**
- **Pag.29: Appendix**

# **The Sugar Project & The Hydro-Magnetic Catalyst**

## ***On the Origin of Conscious Life***

*Cast thy bread upon the waters: for thou shalt find it after many days.  
Give a portion to seven, and also to eight; for thou knowest not what evil shall be upon the earth.  
(Ecclesiastes, 11;1-2)*

### **Why Sugar Project?**

When I was a boy I had a Shih-Tzu, I was a fairly good pianist and I loved Science Fiction. These three situations, apparently disconnected from each other, were actually the supporting pillars on which, thirty years later, this work would be born.

Sugar, this is the name of my little dog, suffered from epilepsy and a curious form of "musicophilia". In fact, whenever I was about to touch the black and white keys of my beloved instrument, he abandoned all activity and literally rushed beside me.

He also seemed to have his own musical taste; in fact he stayed listening in an ecstatic way to works of Chopin or Beethoven while, as soon as I started the performance of a more "modern" piece (I was also fond of Blues and Boogie-Woogie) he walked away with annoyance . Even today I get emotional to think of Sugar's love for music and the sad fate that united him to one of his favorite composers; with age, in fact, the little Shih-Tzu became completely deaf.

At thirteen, music filled a large part of my life but, even more, I fed on science fiction stories; I dreamed of travel in time, space, on the edge of reality and I loved poetic visions of novels such as Clifford D. Simak's "City".

Therefore, I too decided to try my hand in a science fiction story. I described a possible future society, obviously hyper-technological, in which automata, strengthened by their immortality as machines, would have replaced mankind, creating a new, more righteous and peaceful civilization.

I had my father read the text and He made a startling observation: "no automaton can ever replace man without first discovering that "something" that makes a human being truly such. If the origin of life and soul is not understood, this can never be reproduced nor delivered to any machine".

More than thirty years have passed since then but I can still remember the sense of "revelation" that arose from those words; it was as if my father had suddenly opened a door on a mysterious landscape to which I felt I was attracted with my whole being.

I immediately understood that studying the brain and conscious life would have marked my future life.

And the first step of my research began with a certainty. That enigmatic "something" my father had told me about was not only present in me, as a human being, but also in my faithful friend. In owning it, Sugar and I were certainly similar, even brothers, even if in each of us it expressed itself in a different way (for example with partially divergent musical tastes).

So, that's why when it came to having to name the project that has occupied my thoughts for all these years, it was natural to remember little Sugar, the epileptic lion-dog, with a touching passion for classical music.

## **Introduction**

In recent decades many researchers, and even some Nobel laureates, have devoted their efforts to the study and interpretation of consciousness mystery. But every theory born from the fatigue of these men of thought has never received experimental confirmation.

Moreover, failure of computer and cybernetic sciences in the development of an artificial entity endowed with consciousness is evident to all.

Extremely intelligent machines have been created, capable of independently learning the game of chess or go, at levels such as to embarrass even the most skilled human being.

But they actually represent the equivalent of logical schemes, devoid of any emotional and experiential content.

Machine is not pleased with its result or frustrated by failure; it simply waits for another task.

Machine does not design its own future; it simply applies more or less complex algorithms.

Machine does not dream, does not feel pain, hunger, desire for freedom, fear of death; it does not tend to exceed its limits. It processes the symbols, but remains devoid of any intentional semantic capacity towards the surrounding world.

Machine does not possess sensations, objective values, motivations and purposes; it is devoid of individuality. Any machine can be replaced by another completely identical one.

Machine effectively measures quantity but is totally ineffective in assessing quality.

Hence the failure of all those sciences that converge in the broader term of Artificial Intelligence brings us back to the living brain. In it, obviously, there must be a hidden something in which resides one of the greatest mysteries of the universe.

### **Physicalism, Causal Agency and Theory of Complexity**

In the research on the origins of consciousness, the currently dominant position seems to be that of physicalism, based on which mental processes can be traced back to the set of physico-chemical processes that take place in the highly integrated neuronal networks of our brain.

However, physicalist vision, taken to the extreme (reductionist physicalism), by virtue of the determinism that distinguishes it, tends to cancel any possibility of subjectivity and free will.

At this point, the only hope to confirm our intuition of subjectivity and freedom would lie in the possibility of demonstrating that the brain is a non-deterministic system.

The philosopher of the mind John R Searle offers us an alternative view, with the theory of Causal Agency which postulates the existence of a Causal Power inherent in the physical structure of the brain. This Causal Power would originate, in a way that is not yet clear, from the order of nature and would allow the brain to initiate free mental processes with real subjectivity.

Until now, the theory of Causal Agency has seemed impracticable; not only is it not yet known what physical phenomenon could be at the origin of the Causal Power but, if it really exists, it still remains to be explained how mental process can act on the physical world creating the perception of the subjective mental activity and of the surrounding world.

According to Theory of Complexity <sup>28</sup> this theory consciousness and Causal Power would be an "emergent property" of the brain, seen as a non-linear system, or a complex adaptive system, in balance between excessive order and excessive disorder, where the final result of the interaction between the elements of the system is greater than the sum of the properties of the individual elements.

Following work deals with the realization of an experimental setup called Hydro-Magnetic Catalyst (HMC) which should provide early experimental results useful for the study of the origin of consciousness and subjective experience, with a look at Causal Agency theory and foundations on some hypotheses arising from experiential observations and experimental data.

## Fundamental hypotheses

*Hypothesis 1); the number of neurons and their connections is not binding for presence of consciousness.*

Observation 1

In the animal kingdom the brain of each species has a different and peculiar neuronal content (e.g. about 530 million cortical neurons for dogs, 250 million for cats and 16 billion for humans) but it is considered undeniable the presence of a content of consciousness for many of them.

Observation 2

As far as humans are concerned, there are pathological conditions characterized by a marked reduction in the number of neurons (i.e. ischemic insults, traumatic events or large surgical resections) anyhow associated with an adequate level of consciousness. On the other hand, there are also pathological conditions characterized by the absence or marked reduction of the content of consciousness even in the presence of limited or focal neuronal damage.

Observation 3

The cerebellum has a higher number of neurons than the supratentorial brain parenchyma, but is devoid of any "imprint" of consciousness. In fact anomalies or acquired lesions of more or less large portions of the cerebellum do not compromise state of consciousness.

*Hypothesis 2); neurons and, more generally, neuronal activity, are not the repositories of consciousness.*

Observation

Neurons represent the "hardware" needed to process information that reaches the brain. Absurdly, a brain deprived of consciousness can still act as an information processor even though it is not able to attribute semantic, emotional and experiential meaning to what is perceived.

*Hypothesis 3); in the interaction between water and oscillating magnetic fields of low intensity could be hidden the singularity from which consciousness originates.*

Observation 1

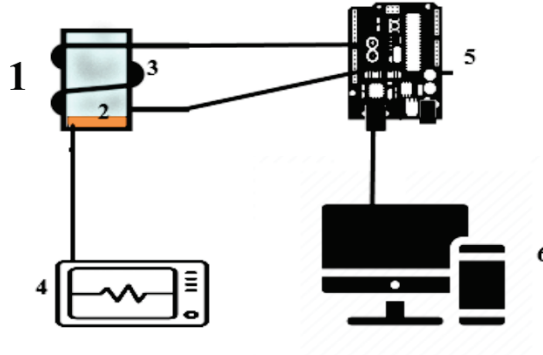
90% of the brain is made up of water.

Observation 2

The brain has an oscillating electromagnetic activity, variable in frequency and intensity, according to the state of consciousness<sup>3</sup>.

# The Hydro-Magnetic Catalyst Part One: Causal Power, Qualia and Quantillium

The experimental verification of the fundamental hypotheses previously set out necessarily involved the creation of an experimental model called Hydro-Magnetic Catalyst (HMC), made up of the following elements (Fig.1):



**Fig.1: basic structure of HMC**

- the core (1) with the stimulation coil (2) and the external recording coil (3)
- the function generator (4)
- the microcontroller with ADC (5)
- the data processing and storage and spectral analysis system (6)

## Core (1)

The core consists of a 150cc glass container filled with gelled water. A copper coil (2) (10 coils of enamelled copper with  $R=2$  cm) is immersed in the base of the container. The dimensions and the number of turns of the coil are calculated in such a way as to generate, at the passage of current, an oscillating magnetic field with an intensity of a few microT (10-20 microT)

The external surface of the core is covered with 100 enamelled copper turns that make up the recording coil (3).

## Function Generator (4)

The stimulation coil of the Core is connected to a wave function generator (FeelTech FY3200S Dual Channel) programmable in order to obtain an oscillating magnetic field of the desired frequency. The intensity of the magnetic field generated by the coil is also determined by the amount of current that flows when the function generator is activated (about 30 mA).

### **Microcontroller and ADC (5)**

Microcontrollers inserted in HMC are two Arduino Uno boards. These microcontrollers are able to convert any analog information perceived in the core environment into digital format and transfer it to a PC for displaying on the screen, mathematical processing and digital storage. The Arduino microcontrollers can also be programmed in C to perform numerous operations on the detected data.

One Arduino Uno is connected to the coil on the external surface of the core while the other can be associated to an electric probe submerged in the aqueous environment of the core.

### **Signal processing system (6)**

PC is used to record signals detected by the microcontroller and for their processing, for spectral analysis and to programme the microcontrollers in C.

### **Vicinal Water**

The most important element of the HMC is vicinal (or interstitial) water.

In recent years, studies and experiments conducted by Prof Gerald Pollack about the characteristics of water, strongly demonstrated that water contained in tissues of living organisms (vicinal water) has properties that are quite distinct from those of bulk water <sup>21</sup>.

In proximity to organic, hydrophilic surfaces, which tend to be negatively charged, water molecules are arranged in such a way as to create a layer of negative charges, in contact with the organic surface, due to the "like likes like" phenomenon and consequently creating an accumulation of remote positive charges in the bulk water.

The negative aqueous layer is referred to as the Exclusion Zone (EZ) as it rejects virtually any solute. Furthermore, the subdivision of the positive and negative charges in the interstitial water volume actually means that, in presence of oscillating magnetic fields, movements of these electrical charges can occur, due to the effect of Faraday's law, and if these moving charges cross the internal surface of a coil they can induce a measurable Electromotive Force.

### **First experiment**

This experiment analyzes what happens to the hydro-magnetic catalyst in the presence / absence of water and in the presence / absence of an oscillating magnetic field.

For subsequent experiment microcontroller Arduino Uno has been programmed in cycles of 10,000 loops of 1 msec each. Microcontroller has also been equipped with a sum algorithm capable of increasing by one every time a valid action potential is perceived (regardless of the intensity) and thus returning a total every 10,000 detection loops (= 1 Cycle).

To summarize: every 10 sec (10000 loops=1 Cycle) the microcontroller returns the sum of 10000 detections where, in case of potential > 0 the number returned is 1 while in case of potential = 0 the number returned is 0 (e.g. if the number of potentials > 0 is 50% the microcontroller will return the number 5000). Each loop restarts after 10 msec.

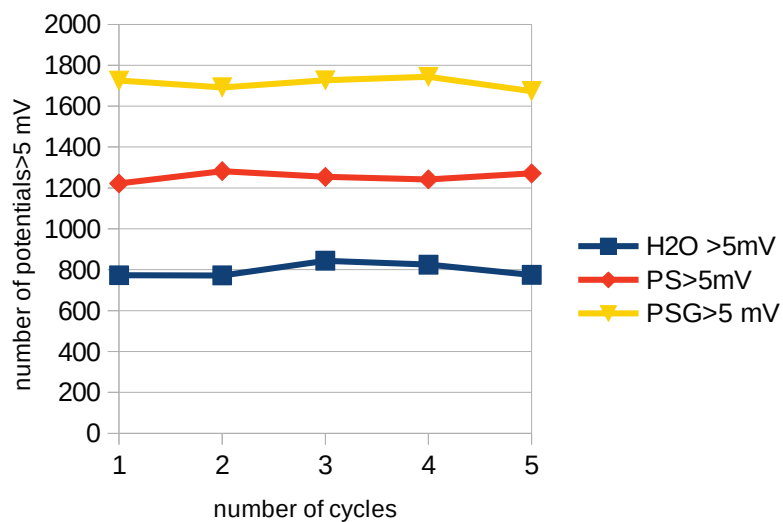
To obtain a statistically significant number of data for each experiment, 100 consecutive cycles were taken in order to obtain  $10^6$  detections every 20 min approximately (see Sketch 1 in Appendix 1).

## Results

1) In the absence of H<sub>2</sub>O the microcontroller does not detect any information, both in the presence and in the absence of an oscillating magnetic field.

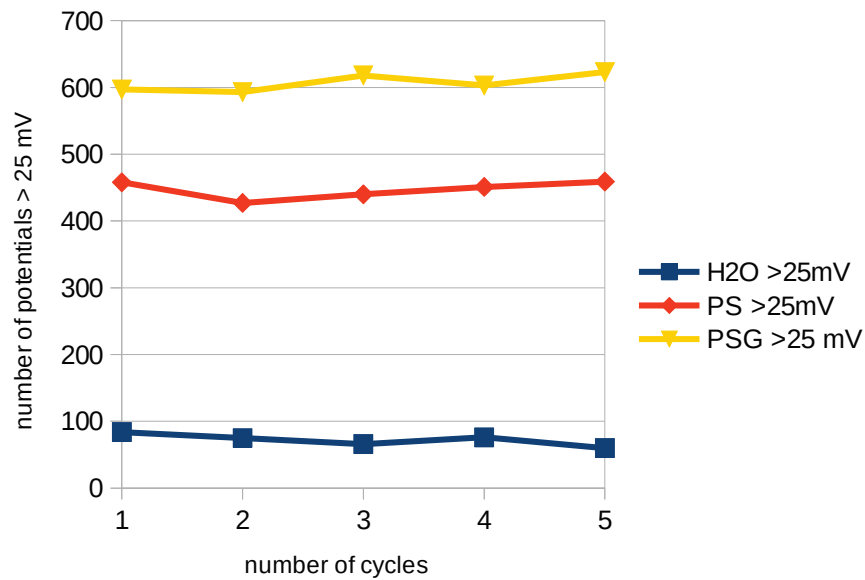
2) In presence of H<sub>2</sub>O and oscillating magnetic field, the Arduino Uno microcontroller allows to detect rather chaotic variations in field potential, probably related to the movement of charges in the aqueous medium and through the inner surface of the coil 3.

Graphs 1,2 and 3 show the variation of number of potentials (>5mV, >25 mV, >50 mV) detected by the microcontroller, under the same frequency of stimulation (8Hz), in three samples of water: demineralized water (H<sub>2</sub>O), physiological solution (P.S.)and physiological solution gelled (8% solution of cornstarch) (PSG).

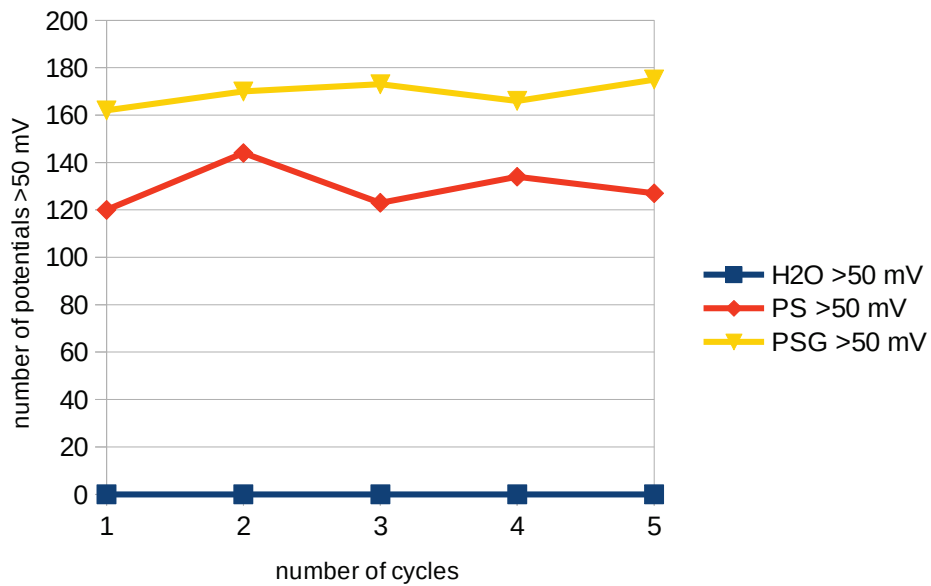


**Graph 1: Number of potentials > 5mV in various samples of water (8Hz stimulation)**





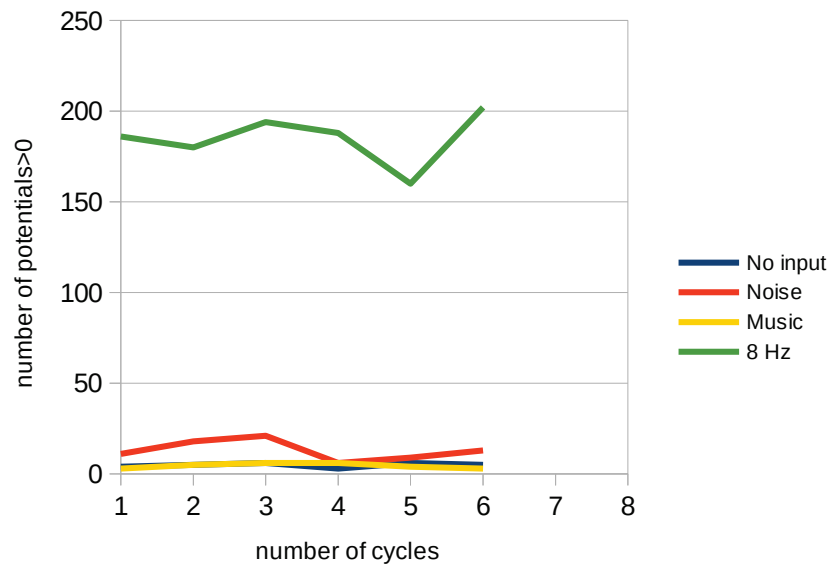
**Graph 2: Number of potentials > 25mV in various samples of water (8Hz stimulation)**



**Graph 3: Number of potentials > 50mV in various samples of water (8Hz stimulation)**

Number of potentials definitely increases when water samples have been supplemented with salts (i.e. ions) and, according to Pollack, when have been gelled (probably due to an increase of the exclusion zone).

It is also interesting to note that only stimulation with oscillating magnetic fields is able to determine production of electric potentials. In fact, if we replace the oscillating magnetic fields with magnetic fields generated by stimuli of different nature (e.g. noise or music), the number of detected potentials does not undergo significant variations compared to the baseline in the absence of magnetic stimulation (Fig.2).

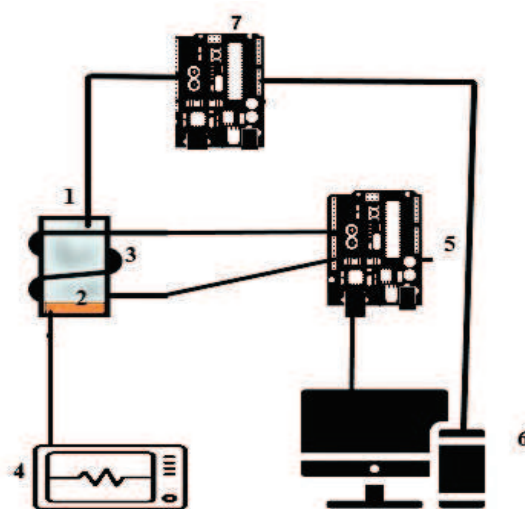


**Fig 2: detected potentials with different stimulations**

### Second experiment

In this experiment, both Arduino boards was used, programmed in the same way (see Sketches 1 and 2 in Appendix1).

The second Arduino Board (7) was connected to an electric probe introduced directly into the aqueous environment of the core (Fig. 3).



**Fig.3; Arduino Board (7) connected to electric probe in the core (1) of the HMC**

Both microcontrollers send the detected data to the PC.

This experiment analyzes what happens according to the stimulation modalities and the presence or absence of an aqueous environment inside the core.

## Results

### *Case 1: absence of stimulation and water*

The external microcontroller (Arduino Uno), connected to the coil on the HMC surface, does not detect any potential. The microcontroller connected to the electric probe inside the core, in the absence of water, since it records from a constantly open analog pin, in a nonreferenced measurement system configuration, reports the detection of numerous potentials related to environmental electrical noise (floating source).

### *Case 2: presence of an oscillating magnetic field and absence of water.*

A situation very similar to that of case 1 occurs.

In fact, the external microcontroller does not detect any potential while the internal probe of the core, in the absence of water, still reports the recording of numerous potentials related to the environmental electrical noise.

### *Case 3; presence of oscillating magnetic field, with variable frequency, and gelled water in the core.*

Both microcontrollers detect electrical potentials due to the interaction between water and oscillating magnetic fields.

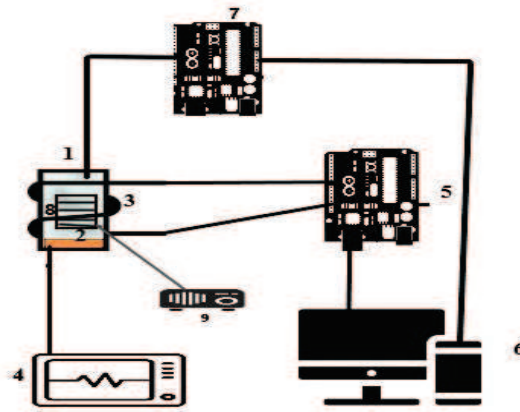
Furthermore, analyzing potentials obtained it can be deduced the existence of two kinds of energy that are produced by the interaction between water and oscillating magnetic fields of low frequency and low intensity.

First type of energy is detected inside the core, it is linked to the formation of electrical charges and therefore an electric field within the medium, and is not very sensitive to the variation of the stimulation frequency of the magnetic field. We can define this energy as Intrinsic Causal Power (ICP).

Second Type of energy is due to the movement of electrical charges through the internal surface of the external coil of the core. Furthermore this energy is much more sensitive to the variation of the magnetic field frequency and has been defined as the Extrinsic Causal Power (ECP) of the Hydro-Magnetic Catalyst.

## Third Experiment

In this experiment, the composition of the HMC, used in experiment 2, was modified by the introduction of following elements (fig 4):



**Fig. 4: HMC implemented with audio player (9) connected to the coil (8) inside the core (1)**

- an audio player (9)
- an additional stimulation coil, inside the core (in the aqueous environment), connected to the output of the audio player (8)

The aim of the following experiment has been to evaluate whether the Causal Power previously detected could somehow be at the basis of the subjective perception of external reality. For this purpose both the Intrinsic Causal Power and the Extrinsic Causal Power of the HMC were evaluated in the presence of electromagnetic stimuli of different nature; a musical audio file (Nocturne in E minor Op. 72 n ° 1 by Chopin) and white noise.

### Results

In spite of a low variability of the ICP, for any type of frequency and stimulus, the variation of the ECP instead undergoes considerable variations both based on the stimulation frequency and depending on the type of input coming from the external environment (the audio player).

If we analyze for each single stimulation frequency the variation of the ICP according to the type of stimulus from the external environment and we relate it to the variation of the ECP according to the type of stimulus from the external environment, we can obtain an index, that has been called Quantillium (QI):

$$QI = | ICPb - ICPx | / | ECPb - ECPx |$$

Where:

*ICPb = Intrinsic Causal Power (number of optentials detected by internal probe in dt) without environmental stimulus*

*ICPx = Intrinsic Causal Power (number of optentials detected by internal probe in dt) with environmental stimulus (Noise or Music)*

*ECPb = Extrinsic Causal Power (number of optentials detected by external coil in dt) without environmental stimulus*

*ECPx = Extrinsic Causal Power (number of optentials detected by external coil in dt) with environmental stimulus (Noise or Music)*

This index actually expresses the extent of the variation of the ICP compared to the variation of the ECP and has a rather peculiar behavior. In fact, it has been observed that the QI, for stimulation frequencies between 8 and 17 Hz, associated in vivo with the alpha and beta states of alert consciousness, has significantly higher values for external stimuli of a musical type (M) compared to stimulation with noise (N) (Tab.1).

	<b>Hz</b>	<b>ICP</b>	<b>ECP</b>	<b>QI</b>	<b>% approx</b>
	<b>3</b>	7457	1870		
N		7348	4418	0,043	4
M		7491	2268	0,085	8,5
	<b>5</b>	7218	2220		
N		7224	4300	0,003	0,3
M		7250	1960	0,12	12
	<b>8</b>	7364	1669		
N		7345	4419	0,007	<b>0,7</b>
M		7456	1891	0,41	<b>41</b>
	<b>10</b>	7463	1894		
N		7310	4427	0,06	<b>6</b>
M		7427	1973	0,455	<b>45,5</b>
	<b>13</b>	7382	1936		
N		7169	4428	0,085	<b>8,5</b>
M		7397	1977	0,365	<b>36,5</b>
	<b>17</b>	7038	1963		
N		6824	4409	0,087	<b>9</b>
M		7050	2008	0,267	<b>27</b>
	<b>21</b>	7554	1854		
N		7416	4385	0,055	5,5
M		7551	1887	0,09	9
	<b>34</b>	7606	1815		
N		7460	4465	0,055	5,5
M		7612	1889	0,08	8
	<b>40</b>	7602	1940		
N		7445	4370	0,065	6,5
M		7605	2039	0,03	3
	<b>100</b>	7617	1928		
N		7440	4410	0,07	7
M		7627	2024	0,10	10

**Tab 1**

In Tab 2 are also reported results obtained with Type 1 musical input (M1; Amazing Grace instrumental with harmonica), Type 2 musical input (M2; Eruption electric guitar solo by Van Halen), Noise (N) and Classical Music (M3; Nocturne in E minor Op. 72 n ° 1 by Chopin).

<b>Hz</b>	<b>ICP</b>	<b>ECP</b>	<b>QI</b>	<b>%approx</b>
<b>3</b>	7305	525		
<b>M1</b>	7282	566	0.56	56.00%
<b>M2</b>	7286	658	0,14	14,00%
<b>N</b>	7247	606	0.71	71.00%
<b>M3</b>	7301	531	0.666	67.00%
<b>8</b>	7563	549		
<b>M1</b>	7551	574	0.48	<b>48.00%</b>
<b>M2</b>	7550	666	0,11	11.00%
<b>N</b>	7572	622	0,12	12.00%
<b>M3</b>	7565	551	1	<b>100.00%</b>
<b>10</b>	7555	522		
<b>M1</b>	7543	556	0.35	35.00%
<b>M2</b>	7536	625	0.18	18.00%
<b>N</b>	7526	605	0,349	35.00%
<b>M3</b>	7531	545	1.04	<b>104.00%</b>
<b>13</b>	7513	540		
<b>M1</b>	7535	573	0.666	<b>67.00%</b>
<b>M2</b>	7501	679	0.086	9.00%
<b>N</b>	7491	637	0.22	22.00%
<b>M3</b>	7523	549	1.11	<b>111.00%</b>

**Tab 2**

According to data recorded and reported in Tab 1 and 2 we can infer that sensory inputs endowed with some positive emotional value (particularly classical music in our experiments) seem to determine a greater perturbation of the aqueous environment of the core compared to sensory stimuli endowed with a negative emotional value or devoid of emotional value.

For this reason, Quantillium (QI) can be considered a good indicator of the perception of the qualitative / subjective aspects of conscious experiences (qualia).

Finally it is interesting to note that QI can be defined only for analogic inputs.

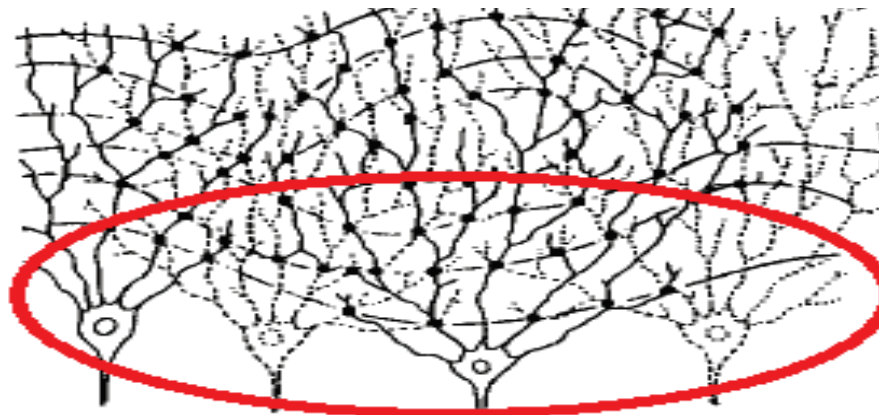
### **Consciousness flow and neuronal activity**

Neurons are digital structures as they can assume only two configurations, on-off, from which inhibitory or excitatory behaviors and any feedbacks then follow <sup>2,9</sup>.

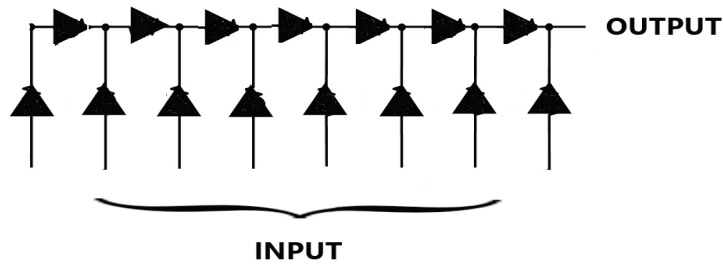
So how can a continuous stream of thoughts, an analogical perception of reality, originate from a discrete neuronal activity?

Furthermore, if the QI can only be obtained with analogue information, how can informations, digitally processed by neuronal networks, reach the vicinal water retaining most of their qualities?

Connections between neurons can develop in various ways, such as the following (Fig. 5-6):

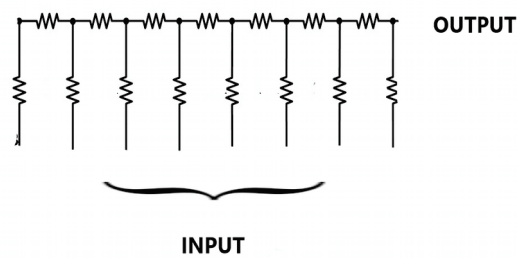


**Fig.5: neurons and connections (from Pribram <sup>22,23</sup>)**



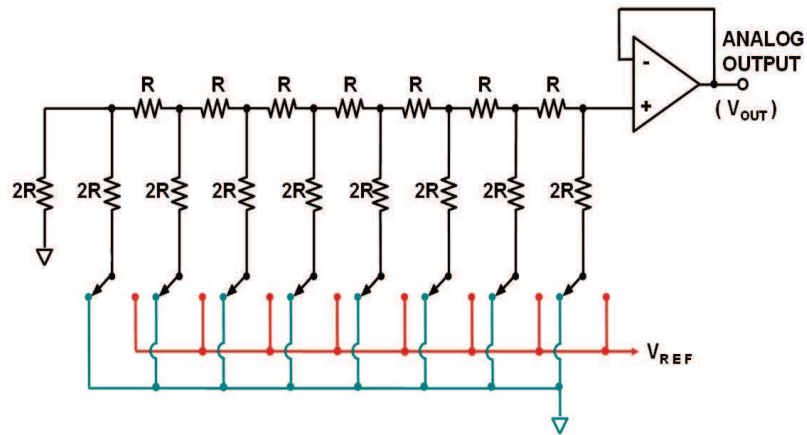
**Fig.6: a simple scheme of connections between neurons**

Each neuron, however, is characterized by its own electrical resistance, varying from  $10^4$  to  $10^9$  ohm depending on whether the fibers are non-myelinated or myelinated. The previous image can then be modified as follows (Fig. 7):



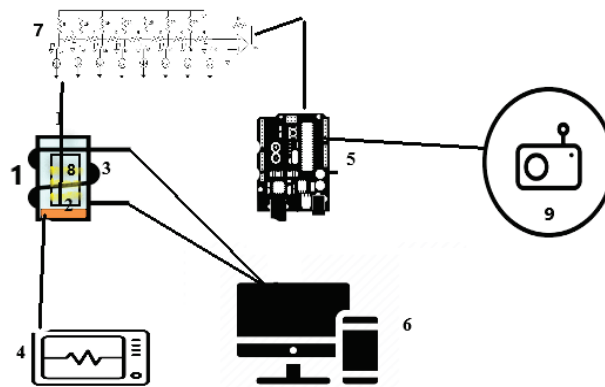
**Fig.7: a simple scheme of connections between neurons with electric resistance**

However, if we look closely at this scheme we can notice an apparent analogy with a particular electronic circuit called R-ladder which is nothing else than a digital analog converter <sup>29</sup>(DAC; Fig. 8).



**Fig.8: DAC scheme**

Arduino technology allows us to create an 8-bit R2R ladder which can then be integrated into the HMC system according to the following scheme (Fig. 9).



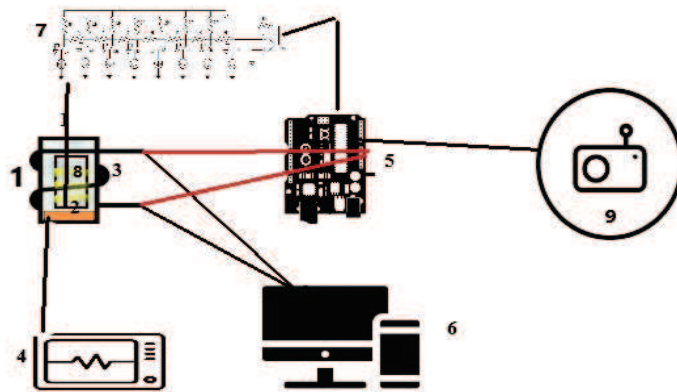
**Fig.9: HMC with DAC**

At this point, the sensory input to the aqueous core of the HMC is no longer provided by direct connection between the internal stimulation coil and the audio player, but by the R2R DAC (7) inserted at the output of the microcontroller. In this case the audio impulse (9) is fed into the Arduino (5) through an analog pin, converted into a digital signal (as in fact the brain neurons would do) and subsequently reconverted, by the 8-bit neuronal system, in an analog signal which is then sent to the core through the internal stimulation coil (8).

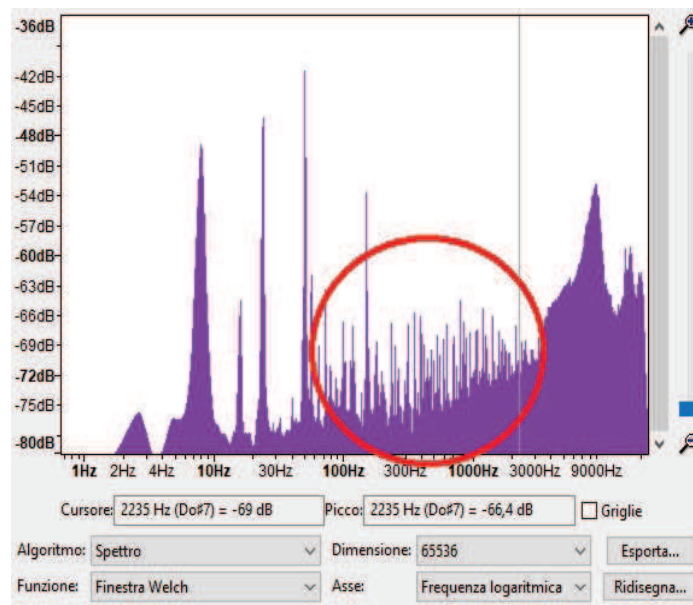
The analog signal that thus reaches the core can allow to evaluate the QI, index, as we have seen previously, of the qualitative / subjective perception of sensory input.



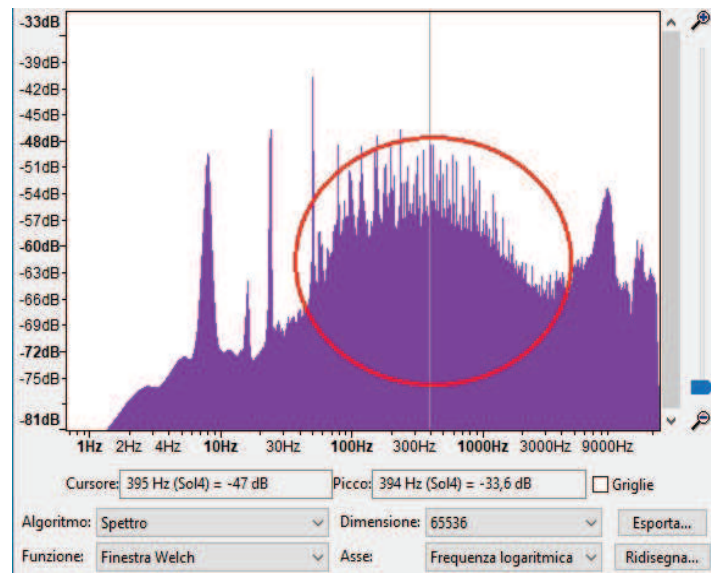
Furthermore, if we introduce a feedback system, where the output of coil 3 is sent not only to the PC but also to the microcontroller (Fig. 10, red lines), we get an important amplification of the analog input (in this case audio input) without energy consumption (Fig.11 and Fig.12).



**Fig.10: HMC with DAC and feedback**



**Fig.11: R-ladder without feedback**



**Fig.12: R-ladder with feedback**

For completeness in Appendix 2 are reported the power spectrum variations of an analog audio input under different frequency stimulation and different configuration of the HMC, and we can still see how the definition of the analog input spectrum is much better using feedback circuit and stimulation frequencies included in the alpha and beta range.

Obviously the poor computational power of the microcontroller used in our experimental model (8 bit) allows a rather spartan processing of the audio input, but we can well imagine the efficacy of a high computational power like that of human cerebral cortex made up of billions of interconnected neuronal cells.

## **The Hydro-Magnetic Catalyst Part Two: Consciousness and the Holographic Universe**

Chalmer's Hard Problem of consciousness is problematic in a mechanistic and reductionist context in which consciousness and universe are considered separated entities.

However in the last century a new paradigm has pervaded more and more deeply the natural sciences and the philosophy of mind; fundamental reality is information lying in an alocal and timeless universe. This alocal and timeless universe, already foreseen by some millenary spiritual traditions (see for example the Akasha of Hindu spirituality), from the scientific point of view has been described and identified with various definitions: divine matrix, zero point field, quantum vacuum, holographic matrix <sup>3,12,25</sup>.

It has been above all Bohm's Holographic theory that mathematically proved the existence of a hidden order that permeates the entire universe (Implicate Order) from which material world and phenomenal reality (Explicate Order) arise by means of a continuous movement of enfolding and unfolding called holomovement <sup>1,26</sup>.

Space-time thus becomes a three-dimensional hologram encoded in a hidden 4th spatial dimension of informations, orthogonal to the real dimensions, measured in imaginary units and characterized by a fractal structure.

According to Bohm's theory, Consciousness and Mind are not located in the brain but derives from the exchange of information between the Implicate Order and the Explicate Order represented by the biochemical and neurophysiological nature of the brain.

### **Brain as information decoder**

The term information refers to the exchange of knowledge, in the form of data, between an emitting source and a receiving one.

According to David Bohm it would be more appropriate to talk about In-Formations, meaning by this term a real process of "formation" of the recipient by a sort of alocal and atemporal connection between events in different points of the universe of the Explicate Order.

Consciousness then becomes cosmic In-Formation which is simply transmitted and processed by the brain and, just like a symphony reproduced by a radio, it exists regardless of its reproduction or whether the radio is on or off.

At this point we can infer that information perceived and processed by the brain still depends on its correct functioning.

If we analyze the electrical activity of the brain from the point of view of non-linear dynamics, we can find some peculiar characteristics <sup>4,5,7,8,10,11,17,24</sup>.

In conditions of relaxed wakefulness (or state of rest) the space-time dynamics are partly chaotic and partly ordered. The physiological changes of this state consequent to the execution of particular cognitive tasks or to the onset of a state of sleep determine an imbalance of the dynamics of the system towards a state of greater or lesser complexity, respectively. On the other hand, important variations in the degree of synchronization interfere in a more serious way on the processes of information processing and on the state of consciousness.

Even meditative states can be analyzed from the perspective of non-linear dynamics <sup>13,14,19</sup>.

Meditation can be thought of as a deeper relaxed state than sleep in a waking state.

The EEG data during the deepest states of meditation therefore showed a high intra and interhemispheric coherence especially in the field of alpha and theta waves.

This increase in EEG synchronization appears to reach a "peak" during the deeper states of consciousness or experience of wholeness.

Based on the neurophysiological data presented above, we can therefore identify at least four different modes of functioning of the brain.

The first is that which occurs during states of deep sleep, characterized by constant and amalgamated electrical activity on a narrow band of low frequency oscillations.

The other three modalities concern the waking state.

During the waking state, a rather chaotic brain activity can be found in which several functionally independent cortical areas are partially integrated by a more coherent background activity. In these cases we can speak of computational modality, characteristic of intelligence and of the logical-deductive abilities with which more or less complex problems are solved.

However, an excessive predominance of disorganized activity (too much chaos) determines pathological situations characterized by a marked reduction in the coherence of brain activity (negative emotions, anxiety, depression, paranoid or schizoid behaviors).

If, on the other hand, brain activity is globally more coherent and integrated, the brain operates according to a modality that we could define as metacomputational, typical of situations in which the intuitive abilities of the subject prevail over the logical-computational ones. The metacomputational brain can be considered as the seat of intuition and creativity.

Furthermore, an excessive predominance of coherent activity seems to be the neurophysiological correlation of both physical and mental situations of "well-being" typical for example of deep meditative states or states of perceived "union with the whole". This last modality can be defined as "Ecstatic".

Therefore quantity and quality of information that we can grasp from reality strongly depends on the functioning of the brain and its ability to "transcend" the computational mode towards the metacomputational one or even towards the ecstatic one.

In the information process, the data can be "captured" in a jagged, less organized way, providing information that is not very useful or even misleading or incomplete. Or they can be received in a much more orderly way providing useful information for an effective expansion of knowledge.

To summarize, the fundamental assumption of the second part of the Sugar Project provides that consciousness and mind can no longer be considered as a consequentially necessary product of the action of a complex physical system such as the brain, but as the product of the decoding of informations coming from the Implicate Order, among which, those concerning one's own essence (from which self-awareness arises), are the first to be perceived and decoded.

Subsequently, the transition from computational to metacomputational and / or ecstatic state involves a progressive increase in the degree of knowledge in the following order: self-awareness, higher brain functions (thought, memory), episteme and insight (logical and intuitive understanding).

Finally, a correct "tuning" of the Explicate Order (the brain) could actually lead, to the extreme limit, to the global knowledge of the atemporal and alocal universe of the Implicate Order.

But which is the transmission channel between Implicate and Explicate Order?

## **HMC and fractals**

If we connect the external coil of the HMC core to a spectrum analyzer it is interesting to note (see Fig.13-14-15) that only for stimulation frequencies below 20 Hz it is possible to detect the appearance of wave structures with fractal characteristics, which they appear at various scales of magnification.

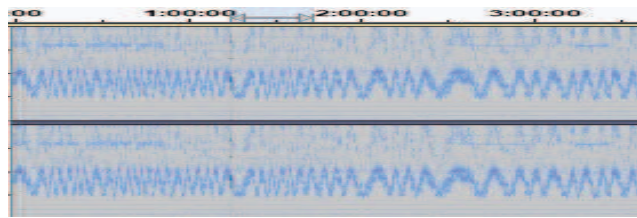


Fig.13: 8 Hz fractals first magnification: waves / h

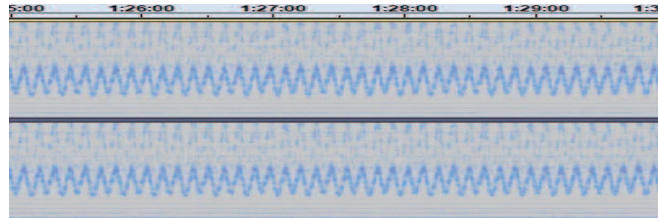


Fig.14: 8 Hz fractals higher magnification: waves/min

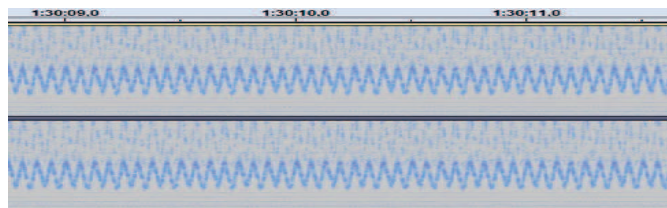


Fig.15: 8 Hz fractals further enlargement: waves/sec

Fractals are mysterious geometric structures with the following main characteristics <sup>15,16,20</sup>:

- a) self-similarity: each fractal figure derives from the union of a number of parts which, enlarged by a certain factor, reproduce exactly the fractal itself. Each fractal is therefore the union of copies of itself at different scales.
- b) scale invariance: the fractals present details at every magnification.
- c) Self-similarity dimension > topological dimension: fractals have a non-integer dimension, defined as Kolmogorov - Housdorff dimension, which derives from the ratio between the natural log of the number of copies and the natural log of the magnification.

Fractals are considered as the geometric representatives of the harmony of the universe. In them order and chaos interpenetrate (again the balance between order and chaos!), shaping each other , reaching a shape, a meaning.

They "participate of the infinite" because the smaller the yardstick used to measure them, the greater the measurement detected. Therefore the Fractal Dimension is not a measure of quantity but rather of the quality of the relationship between observer and observed.

From a mathematical point of view, fractals are often described by equations that contemplate the use of complex numbers.

In mathematical equations, the unreal number  $\sqrt{-1}$  represents an extra, invisible, hidden dimension (where time and space do not exist); thus complex numbers are fundamental for the description and understanding of the quantum universe, where entanglement and non-locality are fundamental principles.

It is therefore interesting that HMC allows the identification of fractal structures only for stimulation frequencies associated in vivo with states of intact consciousness. The fractal size of these structures varies from 1.5 to 1.8 depending on the frequency of stimulation.

Furthermore, by varying the magnification of the power spectrum we can see that only for frequencies between 8 and 13 Hz (alpha waves) it is possible to find the appearance of a repeated toroidal figure, nested between the fractal waves (Fig. 16). It is difficult to attribute a definitive meaning to these findings, but it is certainly interesting to note how many scientists are now in agreement in proposing torus structure as the ideal pattern of bidirectional communication between Explicate Order of matter and mind and the alocal and timeless reality of Implicate Order 4th dimension<sup>16</sup>.

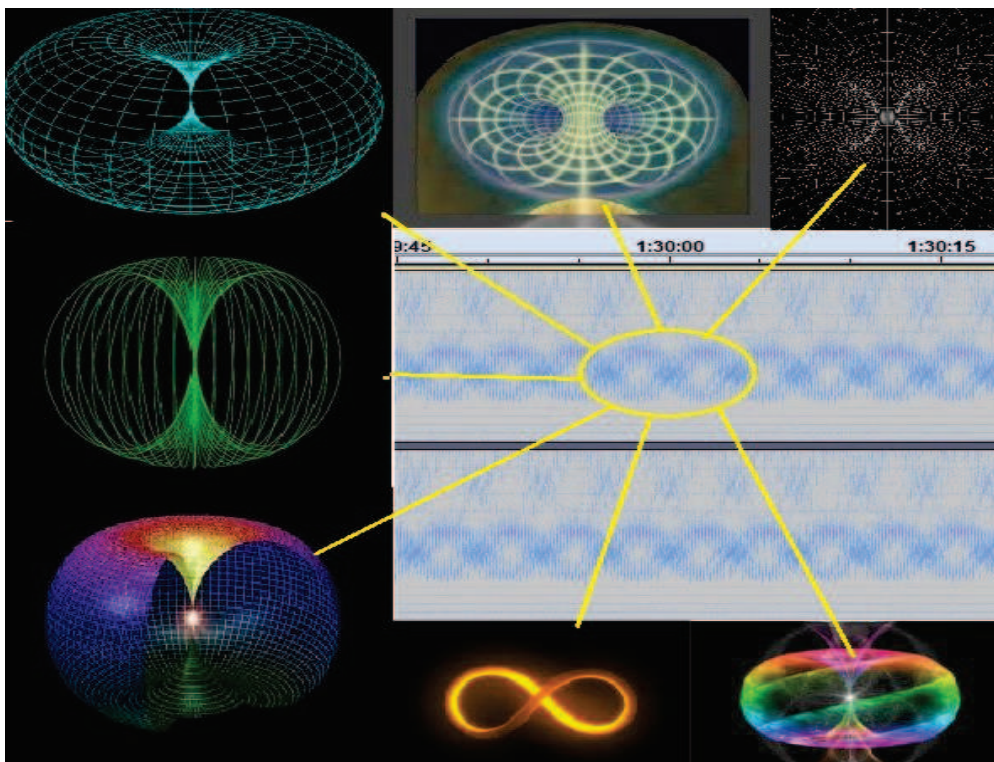


Fig.16

## Summary

The fundamental question to which we have tried to answer in the first and second parts of the manuscript is the following: how can self-awareness, experiential semantics, higher brain functions such as thought and memory arise from a physical system of any complexity?

The results obtained with the experimental model of the Hydro-magnetic Catalyst (HMC) allow us to infer the following conclusions:

- The brain can be considered as a highly sophisticated system of decoding data coming from phenomenal reality (Explicated Order) and from the hidden alocal and atemporal information holographic field (Implicated Order).

- Consciousness and mind are no longer considered as a consequentially necessary product of the action of a complex physical system such as the brain, but as the product of a process of decoding information coming from the Implicate Order (or Holographic Matrix), among which, those concerning self-awareness, are the first to be captured and decoded.

- Fractals and toroidal patterns, by virtue of their geometric properties, can be the "dimensional bridge" through which the communication between the holographic matrix and the phenomenal space-time reality occurs within the brain where the interaction between vicinal water and magnetic fields of weak intensity and frequency included in the alpha range (8-13Hz), determines the appearance of fractal wave and toroidal structures .

- the interaction between water and magnetic fields oscillating with frequency in the alpha and beta range is also fundamental for the qualitative perception of stimuli from the external environment (qualia). This perception can be measured by means of an index called Quantillium (QI) which represents the ratio between the excitability variation of the aqueous medium (core) with respect to the excitability variation of the computational system, following the application of stimuli of various kinds.

- neurons and neuronal networks (mainly cortical ones) are not the repositories of consciousness and higher brain functions. They constitute the information decoding hardware. This decoding is mostly digital but passive properties of the neuronal cells and their interconnections allow for a digital-to-analog reversion of the signal with a system similar to the r-ladder one. This analog signal is probably responsible for the transmission of information to the aqueous environment (where the interaction with the oscillating magnetic fields determines the presence of fractal dimensional bridges), for their amplification through feedback phenomena, and for the perception, during waking state, of a continuous and conscious thought flow.

## The Hydro-Magnetic Catalyst Part Three: Origin of Life

In 1953 the famous Miller and Urey experiment showed how by subjecting a mixture of water and reducing gases (CH<sub>4</sub>, NH<sub>3</sub>, H<sub>2</sub>) to the action of electric discharges, there was the possibility of synthesis of various amino acids.

In this experiment, however, there was no trace of nucleotide bases, indispensable constituents of DNA or RNA life.

In 2017 Ferus, Petrucci, Saitta et al <sup>6</sup> demonstrated how, by subjecting a model of a reducing atmosphere (composed simply of NH<sub>3</sub>, CO and H<sub>2</sub>O) not only to the action of electric discharges but also to the possible action of high-energy shock waves, it was possible to obtain the synthesis of formamide and intermediate reactive species, from which purine and pyrimidine bases may actually originate.

At this point we encounter the first problem, the so called "phosphate problem". Phosphate is ubiquitous in key biomolecules and hence also in nucleotidic chains. However in natural waters phosphate usually reacts with calcium to form apatite minerals.

Toner and Catling <sup>27</sup> showed that higher free phosphate concentrations could have been achieved in primordial alkaline lakes hosted in mafic terrains (rich of magnesium and iron).

The second problem is linked to this question: ATP in an aqueous environment is found mainly in hydrolyzed form; so, in the prebiotic era, what kind of process could have provided the necessary energy to allow nucleotides bond?

The hydrolysis of ATP to ADP releases about 7.3 Kcal / mole of energy; considering Avogadro number ( $6.02 \times 10^{23}$  molecules) we obtain that every single molecule of free ATP produces approximately  $1.2 \times 10^{-23}$  Kcal =  $4 \times 10^{-20}$  J. If we consider a single unit of elementary charge  $4 \times 10^{-20}$  J correspond to 250 mV potential. This is the potential that must be reached by the interaction between water and oscillating magnetic fields to allow the formation of phosphodiesteric bonds between the nucleotide bases present in the "primordial soup" of the alkaline lakes.

Now we have to search for the origin of oscillating magnetic field necessary for the aforementioned interaction.

### Schumann Resonance <sup>30</sup>

In 1952 the physicist Winfried Otto Schumann calculated the existence of oscillating electromagnetic waves generated and excited by the electrical discharges of lightning in the cavity between the earth's surface and the ionosphere, which in this case acts as a wave guide.

Such electromagnetic waves are observable in the power spectrum of natural background electromagnetic noise, as separate peaks, in extremely low frequencies (ELFs). These peaks, in fact, correspond to 7.83 Hz, **14.1 Hz**, 20.3 Hz, 26.4 Hz, 32.4 Hz .

In particular, it is interesting to focus on higher intensity peak at 14.1 Hz. In fact using this frequency (or its 7 hz subharmonic) in the hydro-magnetic catalyst, not only potentials greater than 250 mV are generated, but, analyzing the power spectrum of the signal obtained from the interaction between the oscillating magnetic field and the volume of H<sub>2</sub>O, the appearance of fractal structures is detected. Furthermore these fractal structures show, hidden inside among the various



enlargements, the image of a double helix (Fig.17,18,19).

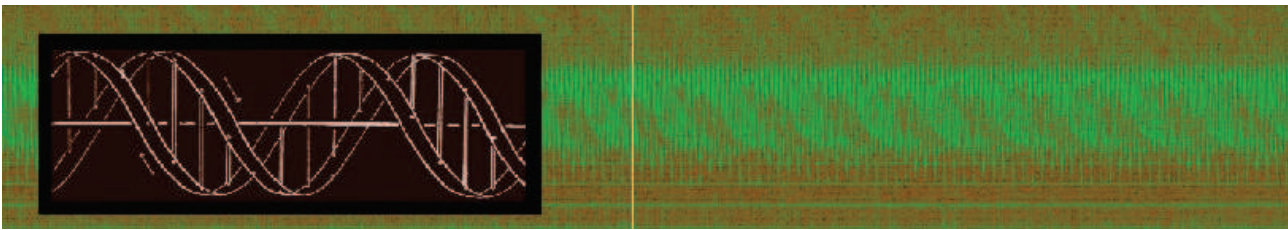


Fig.17

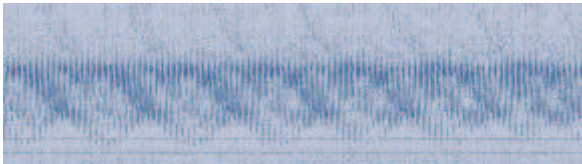


Fig.18

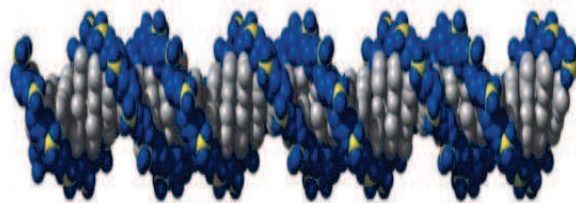


Fig.19

This last observation fits perfectly with the concept of in-formation as what gives shape to matter and energy. Furthermore, the double helix figure is actually found only in 14 Hz (or 7 Hz subharmonic) stimulation and completely disappears in H<sub>2</sub>O absence.

It is also to note that at the beginning of the 21st century, Prof. Luc Montagnier et al <sup>18</sup> experimentally demonstrated that, by applying low intensity 7 Hz oscillating magnetic fields to aqueous solutions of nucleotides, it is possible to determine the formation of nucleotide sequences corresponding to those of very specific biological samples (i.e. nucleic acid of HIV).

## Summary

About four billion years ago an "explosive" mixture of reducing gases, electric discharges and high-energy shock waves linked to the impact with extraterrestrial bodies (meteorites, comet fragments, etc.) created the conditions for the birth of nitrogenous bases. Closed-basin, alkaline lakes hosted in mafic terrains (thanks to their higher phosphate concentrations), could have been the ideal environment for the origin of life. However, an energy source was needed that was able to allow the formation of the phosphodiester bond between nucleotides. The interaction between the water of primordial alkaline lakes and the oscillating magnetic field of the Schumann resonance (generated by the electrical discharges of lightning between the ionosphere and the earth's surface and amplified by the iron constituent of mafic terrains) could have provided the proper energy (continuous and inexhaustible) allowing the formation of the nucleotide chains. These last could then have assumed a helix or double helix conformation following the process of "in-formation" of matter by the 14.1 Hz frequency (or 7 Hz subharmonic).

Therefore the interaction between water and oscillating magnetic fields is able to attribute a new dimensional order to matter that cannot derive from matter itself.

In-formed living matter (especially conscious living matter) in turn can send informations to the holographic matrix. These Informations spread in the alocal e atemporal hidden 4th dimension, springing up in many spacetime realities. In the holographic matrix there is neither before nor after; informations create life and life creates informations in a continuous circular motion with no starting point.

Eventually it could be appropriate to conclude with the words of E.Laszlo <sup>12</sup>:

"Evolution never starts from scratch and is not at the mercy of the fortunate condition...The evolution of life on Earth did not rely on random mutations, nor did it require the physical importation of organisms or proto-organisms from somewhere else in the solar system, as suggested by the theories of "biological insemination" about the origins of life. ..Life on Earth was not inseminated at the biological level, but at the level of information; and its evolution continues to be shaped by life wherever it exists in the universe ".

## **Conclusions**

Compared with other much more relevant theoretical studies this work deals with the development of a physical system (HMC) that could be useful for the experimental investigation of a new paradigm of neuroscience, where interaction between water and magnetic fields, not neurons, is the repositorie of conscious experience and subjectivity. The same paradigm and experimental set up can also be employed for testing new hypotheses on the origin of life.

Other experimental projects are in progress and the author is open to any collaborations and partnerships.

If this new paradigm will receive substantial confirmations it will probably provide a huge push forward not only in the technological field, but above all in the ethical field, toward an expansion of mind, providing a deep knowledge of the relationship between Universe, Life and Mankind.

## References

1. Bohm D (1980). Wholeness and the Implicate Order. London, Routledge, Kegan Paul.
2. Debanne, D., Bialowas, A. & Rama, S (2013). What are the mechanisms for analogue and digital signalling in the brain?. *Nat Rev Neurosci* **14**, 63–69 (2013).
3. Di Biase F (2009). Quantum-holographic informational consciousness. *Neuroquantology*;7;4;657-664
4. Dong-Yu Wu, Gui Cai, Ying Yuan (2011). Application of nonlinear dynamics analysis in assessing unconsciousness:a preliminary study. *Clinical Neurophysiology*;122;3;490-498
5. Fell J, Fernandez G, Elger C (2003). More than synchrony: EEG chaoticity may be necessary for conscious brain functioning. *Medic Hypoth*;61(1);158-160
6. Ferus M, Pietrucci F, Saitta AM, Knížek A, Kubelík P, Ivanek O, Shestivska V, Civiš S. Formation of nucleobases in a Miller-Urey reducing atmosphere. *Proc Natl Acad Sci U S A*. 2017 Apr 25;114(17):4306-4311.
7. Fries P (2005). A mechanism for cognitive dynamics: neuronal communication through neuronal coherence. *Trends in cogn sci*;9;10;474-480
8. Jensen O, Colgin LL (2007). Cross-frequency coupling between neuronal oscillations. *Trends Cogn Sci*;11;7;267-269
9. John ER (2002). The neurophysics of consciousness. *Brain Res Review*;39;1-28
10. Korn H, Faure P. Is there chaos in the brain? I Concepts of nonlinear dynamics and methods of investigation (2001). *C.R.Acad.Sci.Paris, Sciences de la vie/Life Sciences*;324;773-793
11. Korn H, Faure P (2003). Is there chaos in the brain? II Experimental evidence and related models. *CR Biologies*;326;787-840
12. Laszlo E. Science and the Akashic Plan (Italian Edition). Feltrinelli Editore.
13. Lutz A, Dunne JP, Davidson RJ. Meditation and the neuroscience of consciousness; an introduction. *The Cambridge Handbook of consciousness*. Cambridge Press.
14. Lutz A, Greischar L, Rawlings NB et al (2004). Long-term meditators self-induce high-amplitude synchrony during mental practice. *Proc Nat Acad Sci*; 101; 46; 16369-16373.
15. Marks-Tarlow Terry (2013). Fractal Geometry as a bridge between realms. Private Practice (USA)
16. Meijer, Dirk & Geesink, Hans. (2017). Consciousness in the Universe is Scale Invariant and Implies an Event Horizon of the Human Brain. *NeuroQuantology*. 15 ; 3; 41-79 doi: 10.14704/nq.2017.15.3.1079. 15. 41-79. 10.14704/nq.2017.15.3.1079.
17. Meyer-Lindenberg A (1996). The evolution of complexity in human brain development: an EEG study. *Electroenceph and Clinic Neurophysiol*;99;405-411
18. Montagnier L, Del Giudice E, Aissa J et al (2015). Transduction of DNA information through water and electromagnetic waves. *Electromagn Biol Med*;34(2): 106-12.
19. Orme-Johnson DW, Haynes CT. EEG phase coherence, pure consciousness, creativity, and TM--Sidhi experiences. *Int J Neurosci*. 1981;13(4):211-7. doi: 10.3109/00207458108985804. PMID: 7026478.
20. Peitgen HO, Jurgens H, Saupe D (2004). Chaos and Fractals – New frontiers of science. Springer Science
21. Pollack GH. (2013). The Fourth phase of water. Ebner and sons

22. Pribram K (1969). The neurophysiology of remembering. *Scientific American*;220
23. Pribram K (1991). *Brain and Perception*. Hillsdale: Lawrence Erlbaum
24. Stam CJ (2005). Nonlinear dynamical analysis of EEG and MEG: review of an emerging field. *Clinical Neurophysiology*;116;2266–2301
25. Talbot M (1997). *Tutto è uno*. Edizioni Urra.
26. Teodorani M (2006). *Bohm: la fisica dell'infinito*. MacroEdizioni
27. Toner JD, Catling DC (2020). A carbonate-rich lake solution to the phosphate problem of the origin of life. *Proc Natl Acad Sci U S A*.117(2):883-888
28. [https://it.wikipedia.org/wiki/Teoria\\_della\\_complessita'](https://it.wikipedia.org/wiki/Teoria_della_complessita')
29. [https://en.wikipedia.org/wiki/Resistor\\_ladder](https://en.wikipedia.org/wiki/Resistor_ladder)
30. [https://en.wikipedia.org/wiki/Schumann\\_resonances](https://en.wikipedia.org/wiki/Schumann_resonances)

## APPENDIX 1: Arduino Sketches

### SKETCH 1: External Causal Power (ECP)

```
void(* resetFunc) (void) = 0;
```

```
int x = 1;  
byte tot[10000] = {};  
long somma = 0;  
byte contatore = 1;
```

```
void setup() {
```

```
    Serial.begin(9600);  
}
```

```
void loop(){
```

```
    for(x; x < 10000; x++){
```

```
        int A = analogRead(A0);
```

```
        if (A >= 4){
```

```
            A = 1;
```

```
        }
```

```
        else {
```

```
            A = 0;
```

```
        }
```

```
        tot[x] = (A);
```

```
        somma = (somma) + (tot[x]);
```

```
        delay (1);
```

```
    }
```

```
    Serial.println(somma);
```

```
    delay (10);
```

```
    resetFunc();
```

```
}
```

## SKETCH 2: Internal Causal Power (ICP)

```
void(* resetFunc) (void) = 0;
int x = 1;
byte tot[10000] = {};
long somma = 0;
byte contatore = 1;

void setup() {

  Serial.begin(9600);

  pinMode(15,OUTPUT);
  pinMode(16,OUTPUT);
  pinMode(17,OUTPUT);
  pinMode(18,OUTPUT);
  pinMode(19,OUTPUT);
}

void loop(){

  for(x; x <10000; x++){

    int A = analogRead(A0);

    if (A >= 1){          //change this parameter to reduce noise effects
      A = 1;
    }
    else {
      A = 0;
    }

    tot[x] = (A);
    somma = (somma) + (tot[x]);

    delay (10);
  }

  Serial.println(somma);

  delay (1);

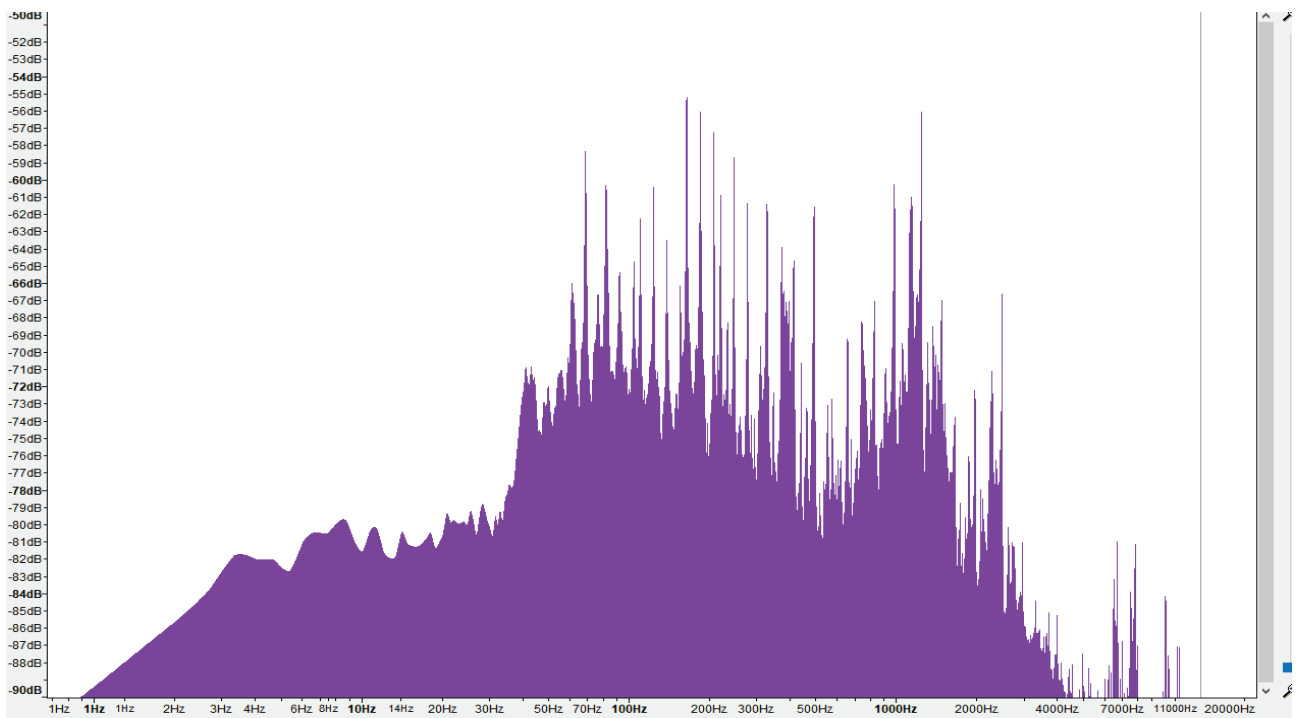
  resetFunc();
}
```

**SKETCH 3: R-Ladder (with two inputs; see fig.14)**

```
void setup() {  
  for (byte i=0;i<8;i++){  
    pinMode(i,OUTPUT);  
  }  
  
}  
  
void loop() {  
  int A = analogRead(A0);  
  int B = analogRead(A2);  
  int C = (A + B +1)/4 - 1;  
  if (C < 0){  
    C = 0;  
  }  
  PORTD = C;  
}
```

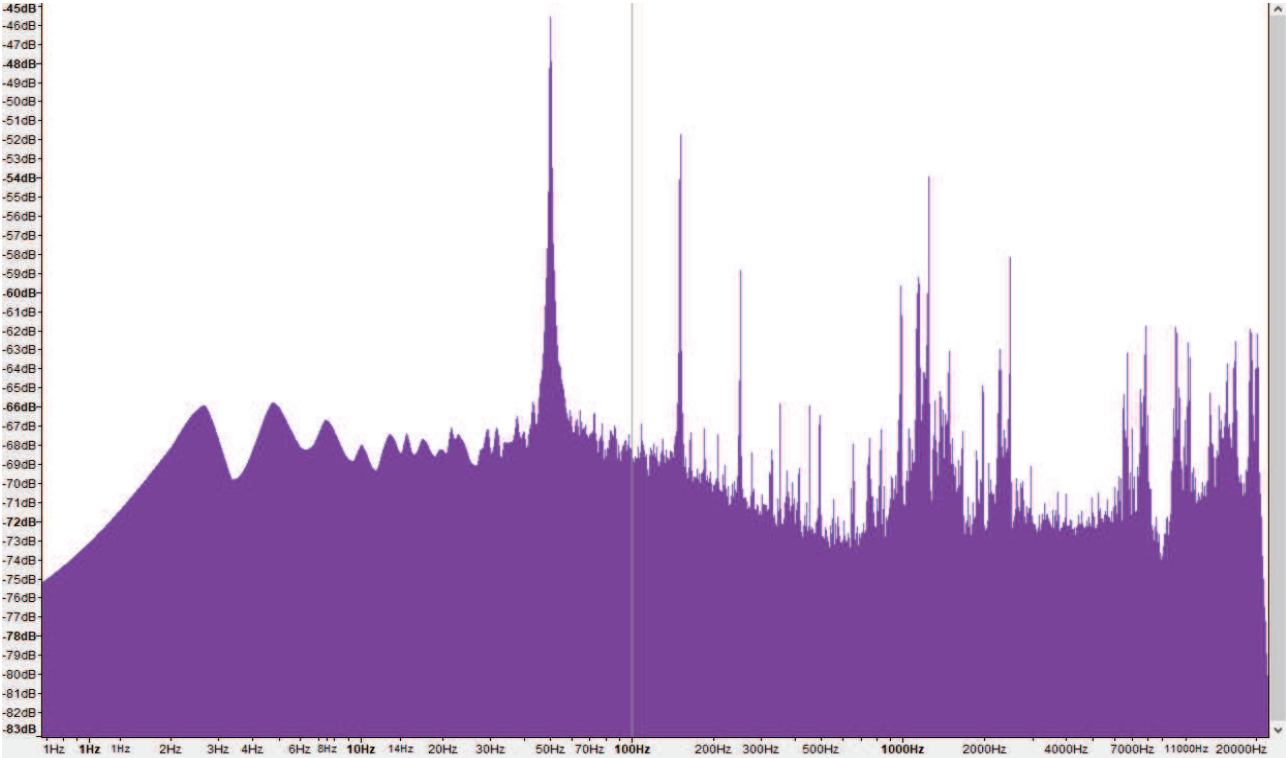
## APPENDIX 2: Spectral Analysis of audio input

N.B: INPUT= Amazing Grace by Buddy Green's Harmonica

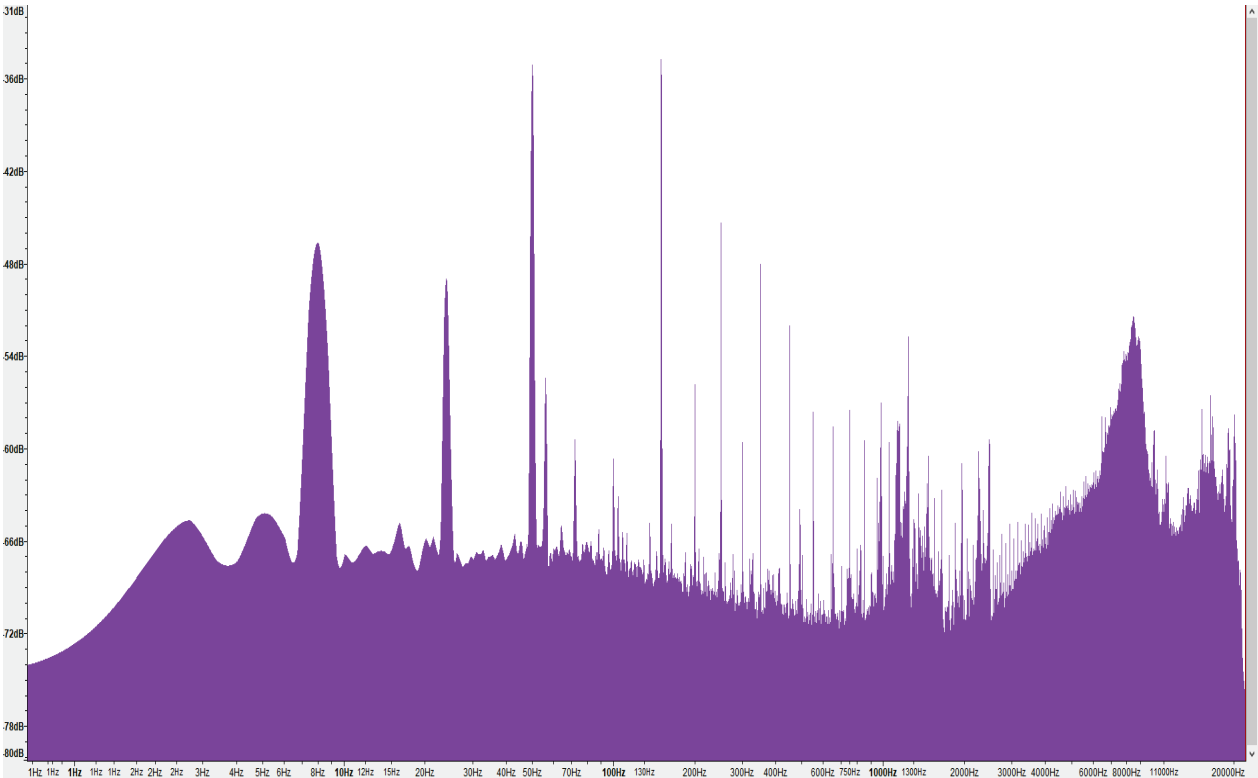




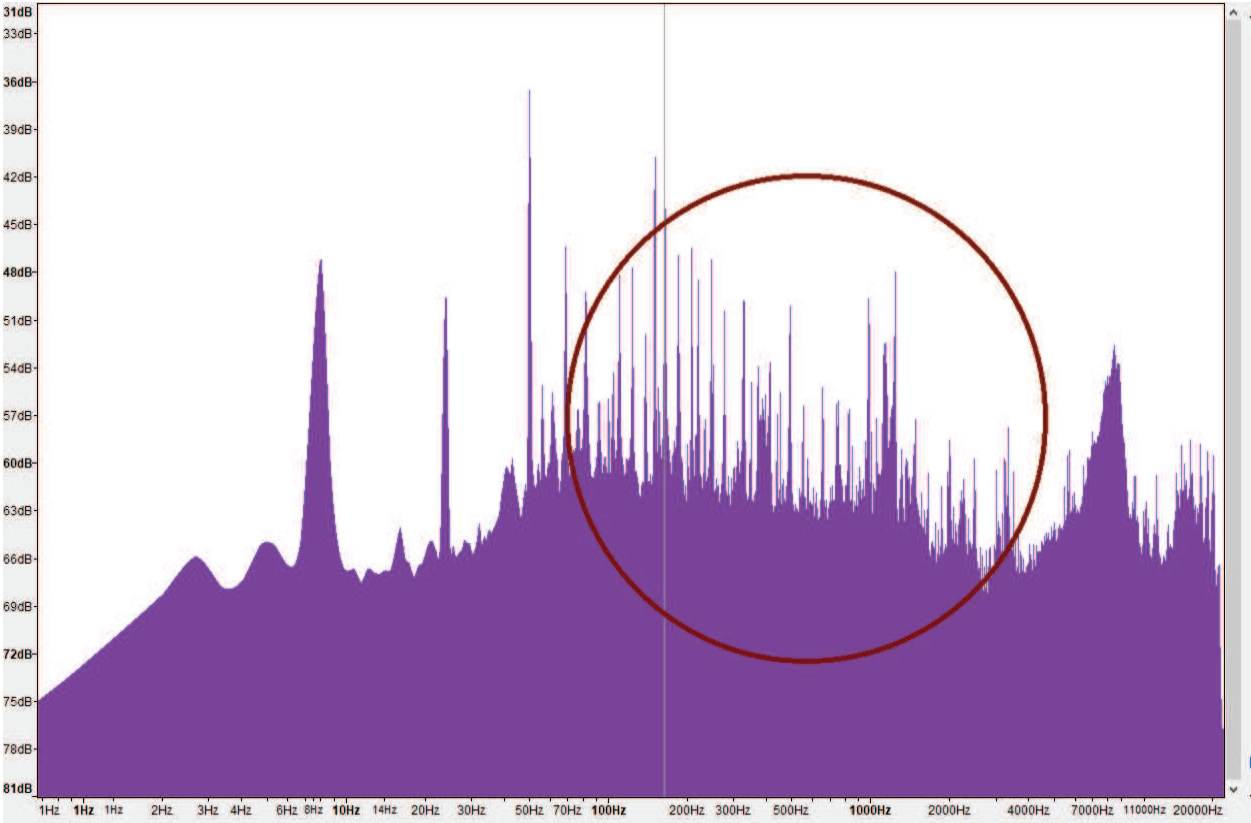
1) HMC + R-Ladder + Input- No Hz stimulation



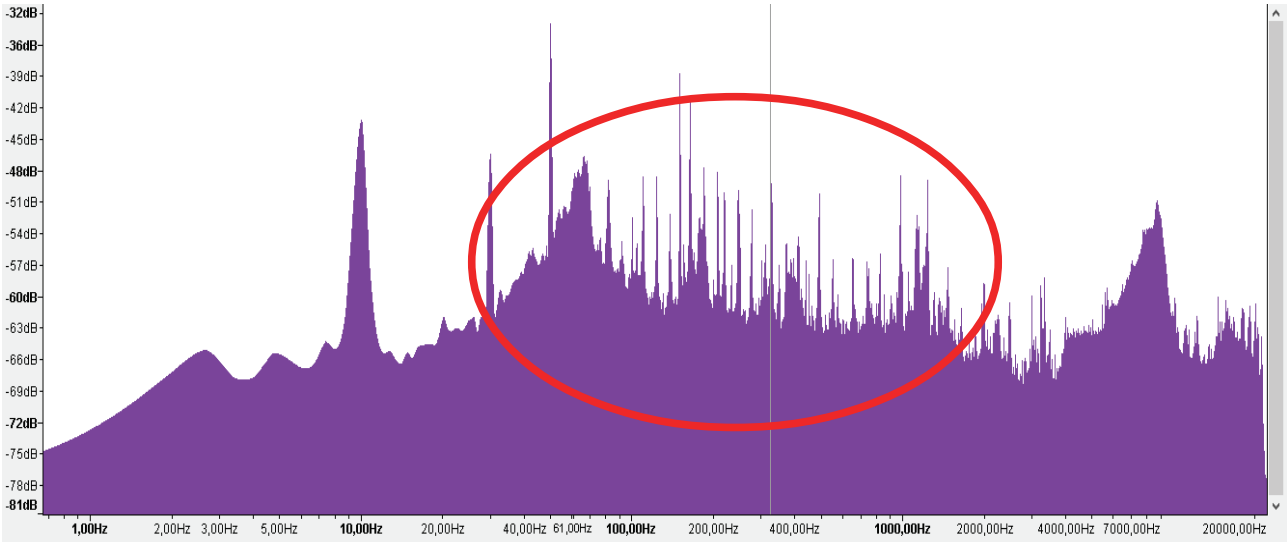
2) HMC + R-Ladder + Input + 8 Hz stimulation



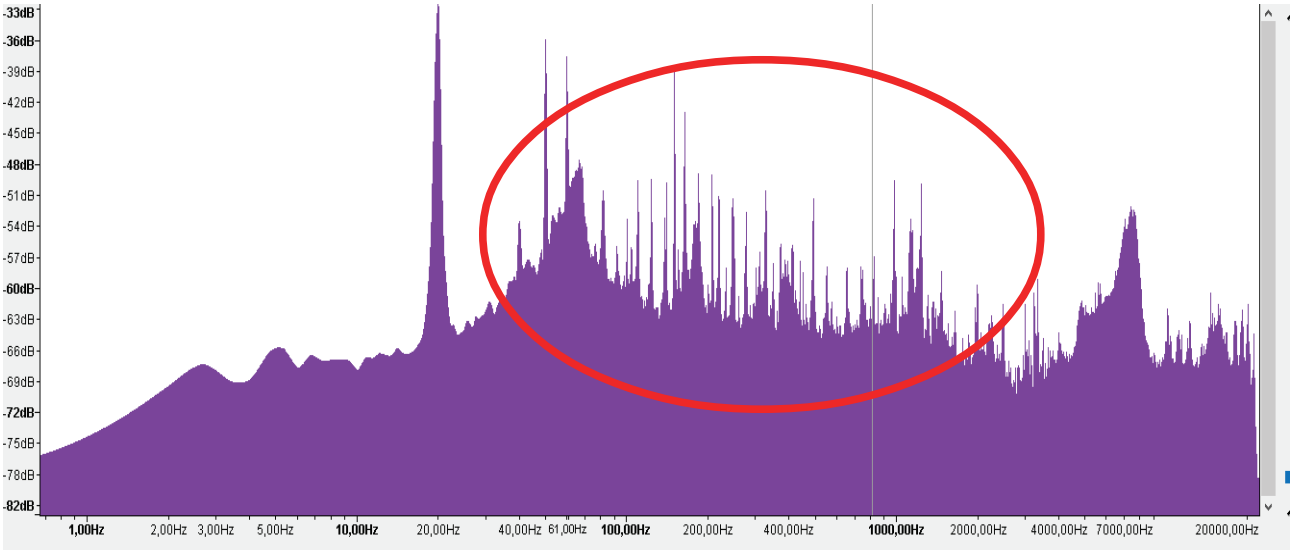
3) HMC + R-Ladder + Input + 8 Hz stimulation + feedback



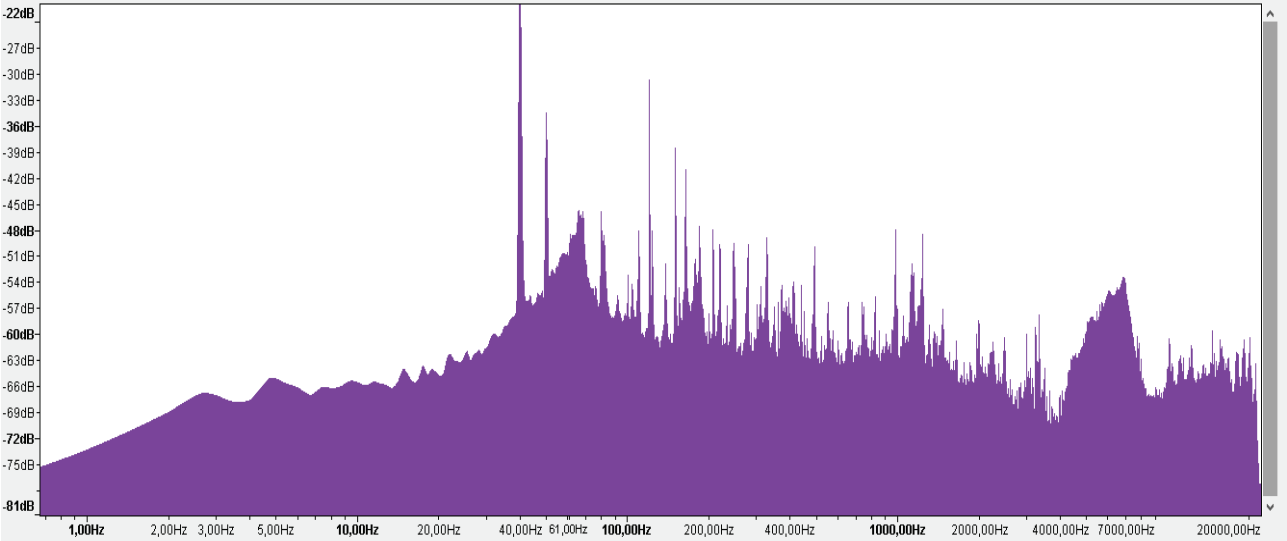
4) HMC + R-Ladder + Input + 10 Hz stimulation + feedback



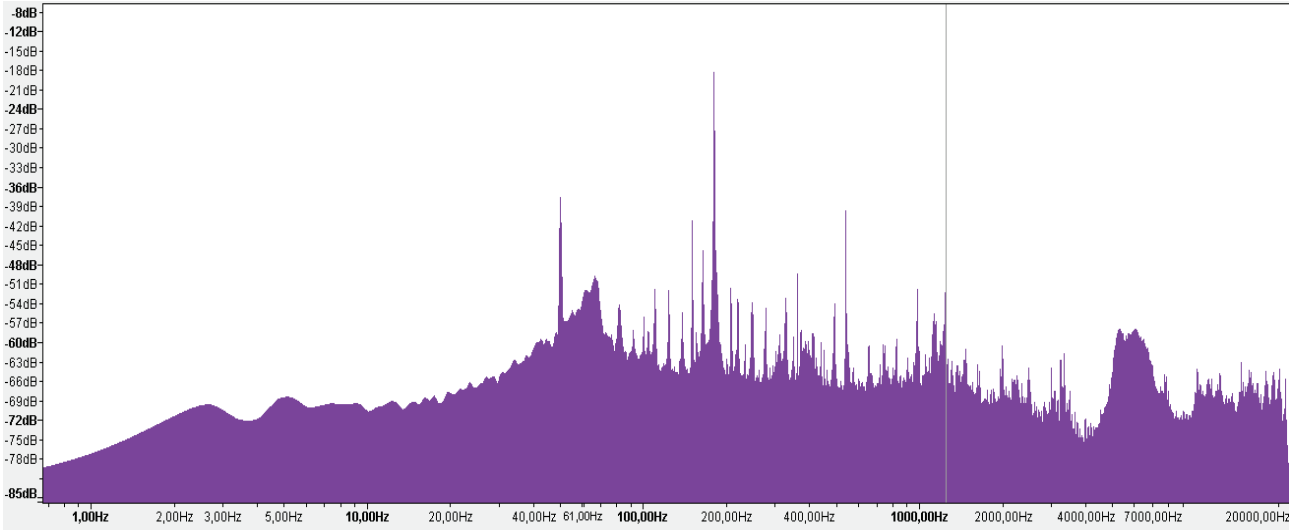
5) HMC + R-Ladder + Input + 20 Hz stimulation + feedback



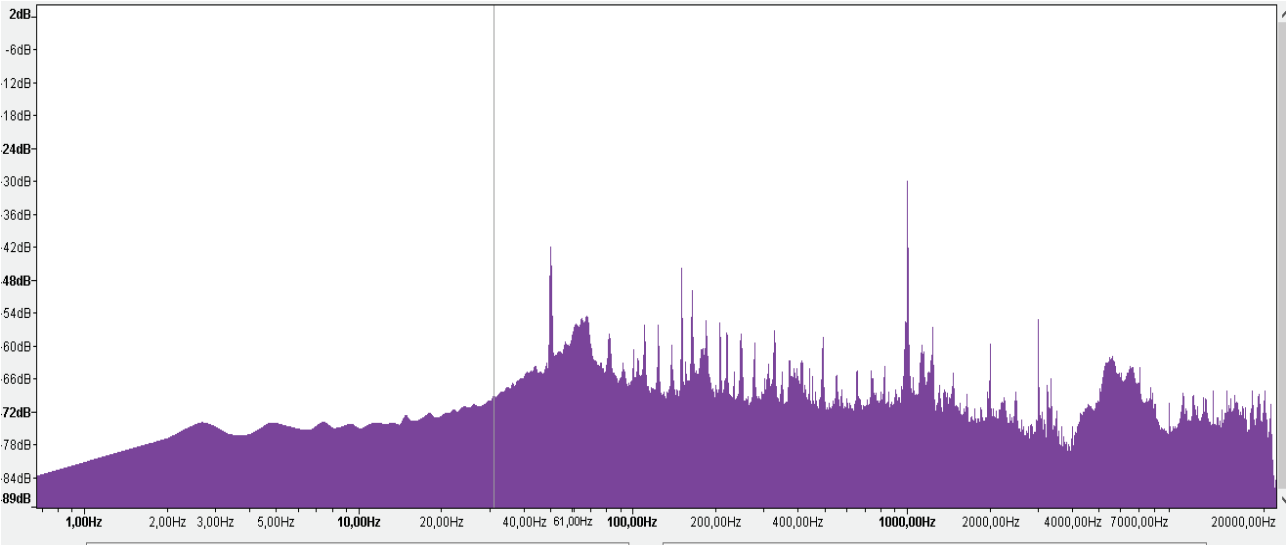
6) HMC + R-Ladder + Input + 40 Hz stimulation + feedback



7) HMC + R-Ladder + Input + 180 Hz stimulation + feedback



8) HMC + R-Ladder + Input + 1 KHz stimulation + feedback



9) HMC + R-Ladder + Input + 3 Hz stimulation + feedback

