



All Universes begin as Quantum Fluctuations of the Empty Set = Void by Quantum Fluctuation of Compact E8(-248) Real Form of E8 which is the First Grothendieck Universe and they all evolve according to David Finkelstein's Iteration of Real Clifford Algebras:

$n = 0$	$\emptyset$	= Void
---------	-------------	--------

$n = 1$	$\{\emptyset\}$	= CI(0)
---------	-----------------	---------

$n = 2$	$\emptyset$ $\{\emptyset\}$	= CI(1)
---------	-----------------------------	---------

$n = 4$	$\emptyset$ $\{\{\emptyset\}\}$ $\{\emptyset \& \{\emptyset\}\}$ $\{\emptyset\}$	= CI(2)
---------	---	---------

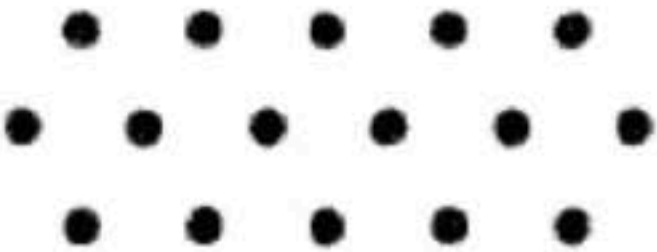
$n = 16$		= CI(4)
----------	--	---------

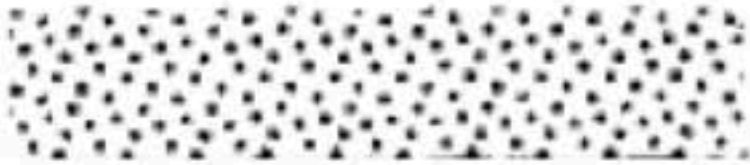
$n = 65,536$		= CI(2^4=16) = CI(16)
--------------	--	-----------------------

### Kaluza-Klein Spacetime

M4 x CP2

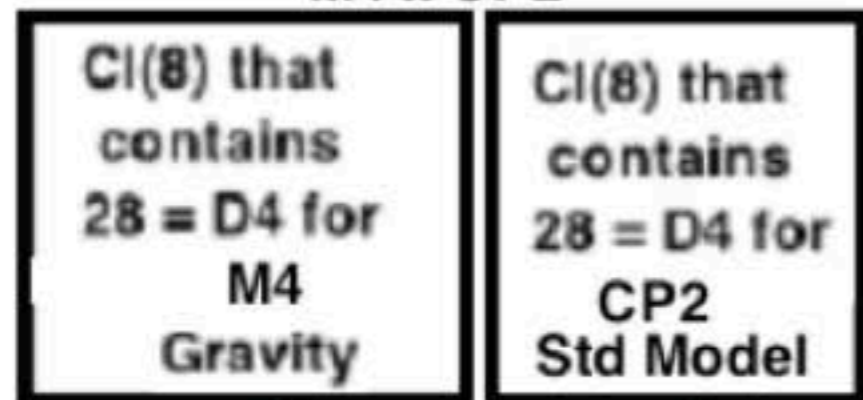

1
16
120
560
1820
4368
8008
11440
12870
11440
8008
4368
1820
560
120
16
1

Cl(8) is M16(R)

=  
16 x 16 Matrix Algebra  
of Real Numbers.

<b>TriVectors</b>	56	56	560
<b>BiVectors</b>	28	28	120
<b>Vectors</b>	8	8	16

$$Cl(8) \times Cl(8) = Cl(16)$$

8-Periodicity tensor product

$$Cl(8) \text{ Spinors} \times Cl(8) \text{ Spinors} = Cl(16) \text{ Spinors}$$

8-Periodicity tensor product

$$Cl(8) \text{ Spinors} = 8 S^+ + 8 S^-$$

$$8 S^+ + 8 S^- \times 8 S^+ + 8 S^- =$$

$$= 8 \times 8 S^{++} + 8 \times 8 S^{+-} + 8 \times 8 S^{-+} + 8 \times 8 S^{--}$$

$$Cl(16) \text{ helicity consistent half-Spinors} = 64 S^{++} + 64 S^{--} = 128$$

Cl(16) is M256(R) = 256 x 256 Matrix Algebra of Real Numbers

with

Vectors = 16-dim IV(8) Complex Domain Lie Ball  
of Symmetric Space Spin(10) / Spin(8)xU(1)  
with Lie Sphere Shilov Boundary RP1 x S7

BiVectors with an antisymmetric Bracket Product form a Lie Algebra.  
120-dim Cl(16) BiVectors + 128-dim Cl(16) half-Spinors = 248-dim E8

TriVectors with a symmetric Jordan Product form a Jordan Algebra.  
560-dim Cl(16) TriVectors = 10 copies of 56-dim Fr3(O)  
Fr3(O) = Complexification of 27-dim J3(O)

$$560 = 56 + 8 \times 28 + 28 \times 8 + 56$$

$$120 = 28 + 8 \times 8 + 28$$

**Cl(8) structure is in African IFA divination through its  $16 \times 16 = 2^8 = 256$  Odu and is also represented by the 256 Elementary Cellular Automata**

the binary nature of which has its historical origin in Africa.

Ron Eglash (in his book "African Fractals" (Rutgers 1999) and on his web site) says:

**"... a historical path for base-2 calculation ... begins with African divination ..."**

**Cellular Automata (CA):**

**The 256 CAs correspond to the 256-dim Cl(8) Real Clifford Algebra:**

$$8+28+16 = 52 \text{ F4}$$

**16**

**Cl(8) Primitive Idempotent has 16 Terms**

$$f = (1/2)(1 + e_{1248})(1/2)(1 + e_{2358})(1/2)(1 + e_{3468})(1/2)(1 + e_{4578}) =$$

$$= (1/16)(1 + e_{1248} + e_{2358} + e_{3468} + e_{4578} + e_{5618} + e_{6728} + e_{7138} + e_{8357} + e_{4671} + e_{5712} + e_{6123} + e_{7234} + e_{1345} + e_{2456} + e_{3567})$$

corresponding to 16 of the 256 Cellular Automata

**Tensor Product Cl(8) x Cl(8) = Cl(16)**

$$(F4 \text{ in } Cl(8)) \times (F4 \text{ in } Cl(8)) =$$

$$= 8 \times 8 + 28 \times 1 + 1 \times 28 + 16 \times 16 =$$

$$= 120 \text{ Cl(16) BiVectors} + (128 + 128) \text{ Cl(16) Spinors}$$

$$120 \text{ Cl(16) BiVectors} + 128 \text{ Cl(16) Half-Spinors} = E8$$

**Cl(8) Triality**

- 8 half-spinors
- 8 half-spinors
- 8 vectors

**8**

**Grade 0**

**1**

**Grade 1**

**2**

**Grade 2**

**Grade 3**

**Grade 4**

**Grade 5**

**Grade 6**

**Grade 7**

**8**

# There are two D4 = Cl(8) BiVectors in the D8 = Cl(16) BiVectors that live in E8

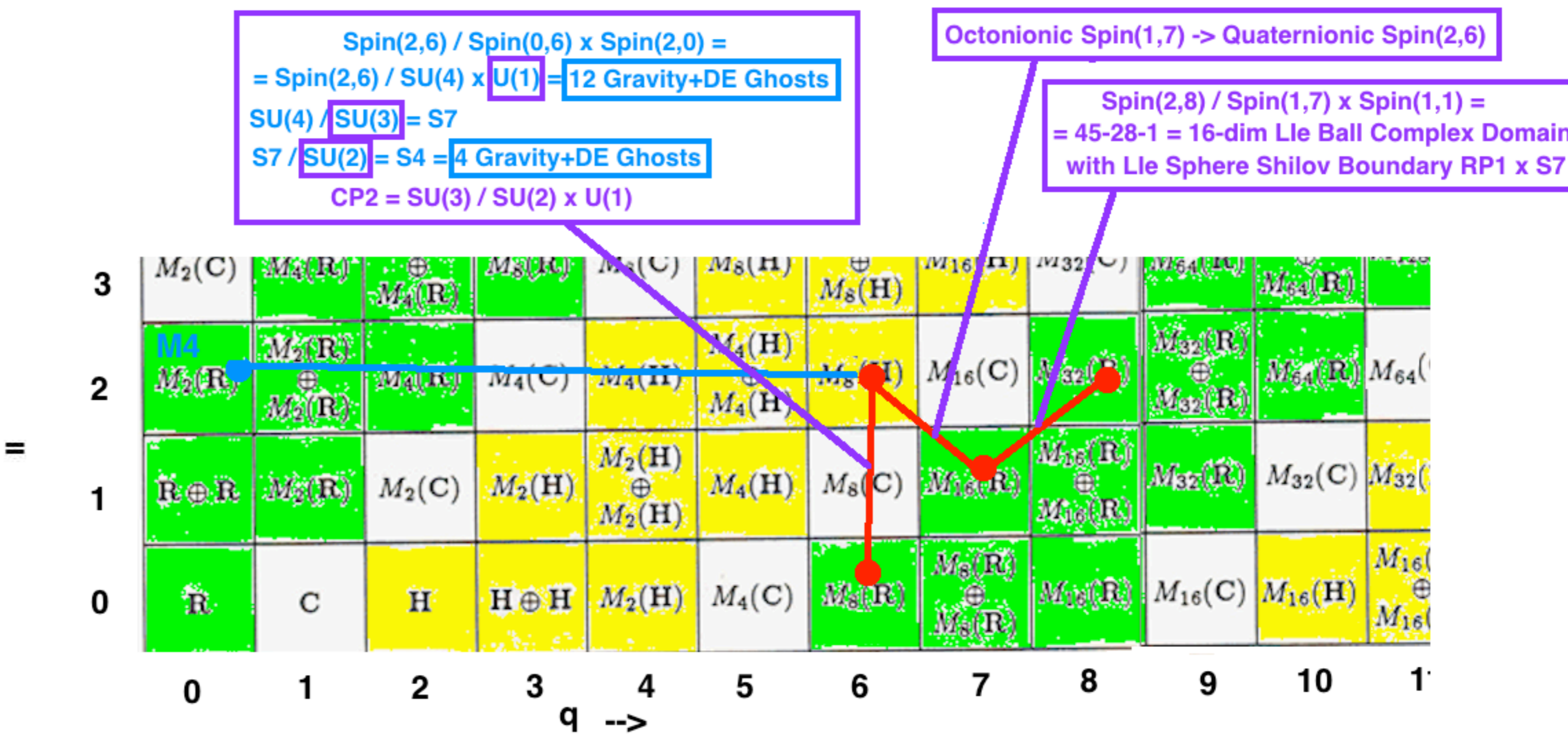
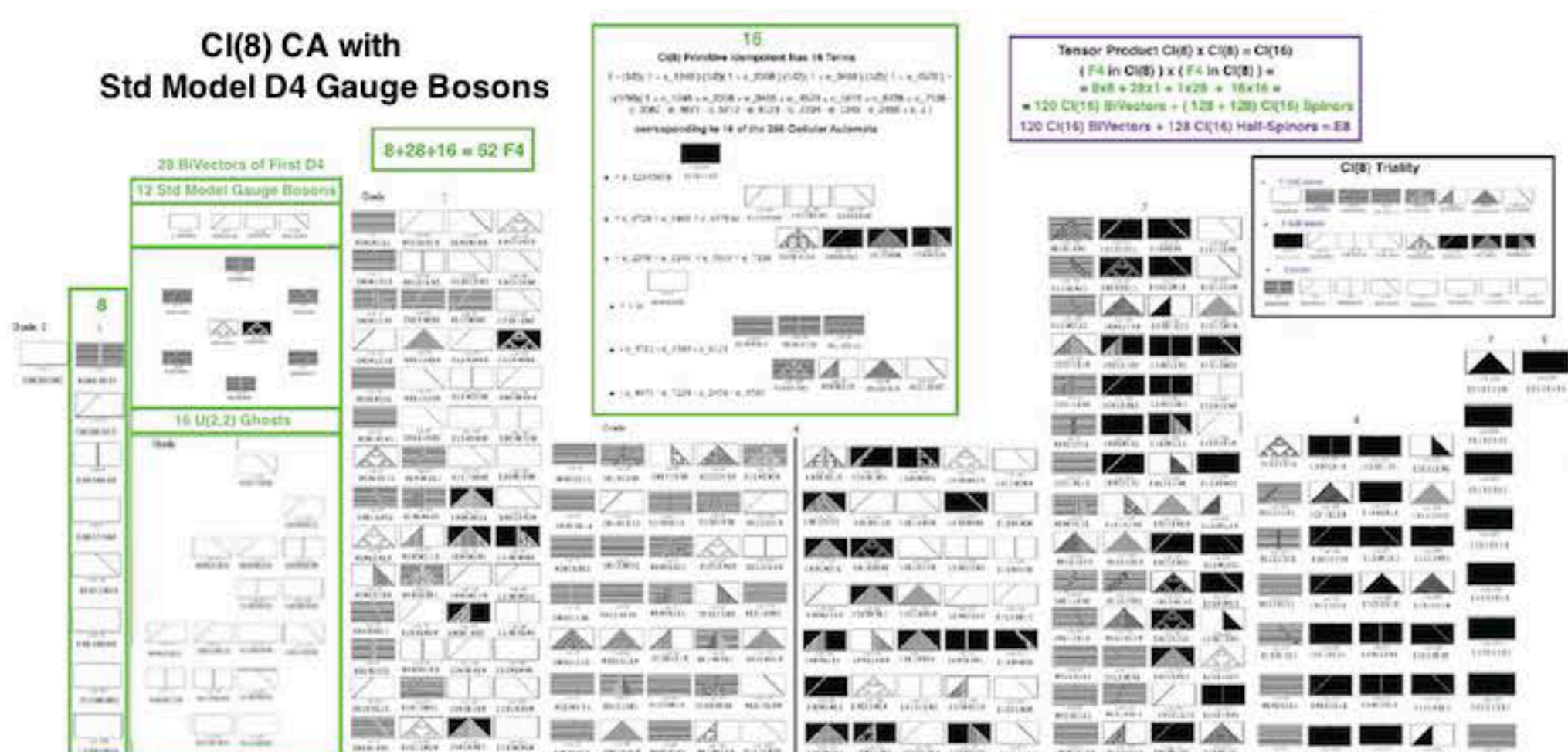
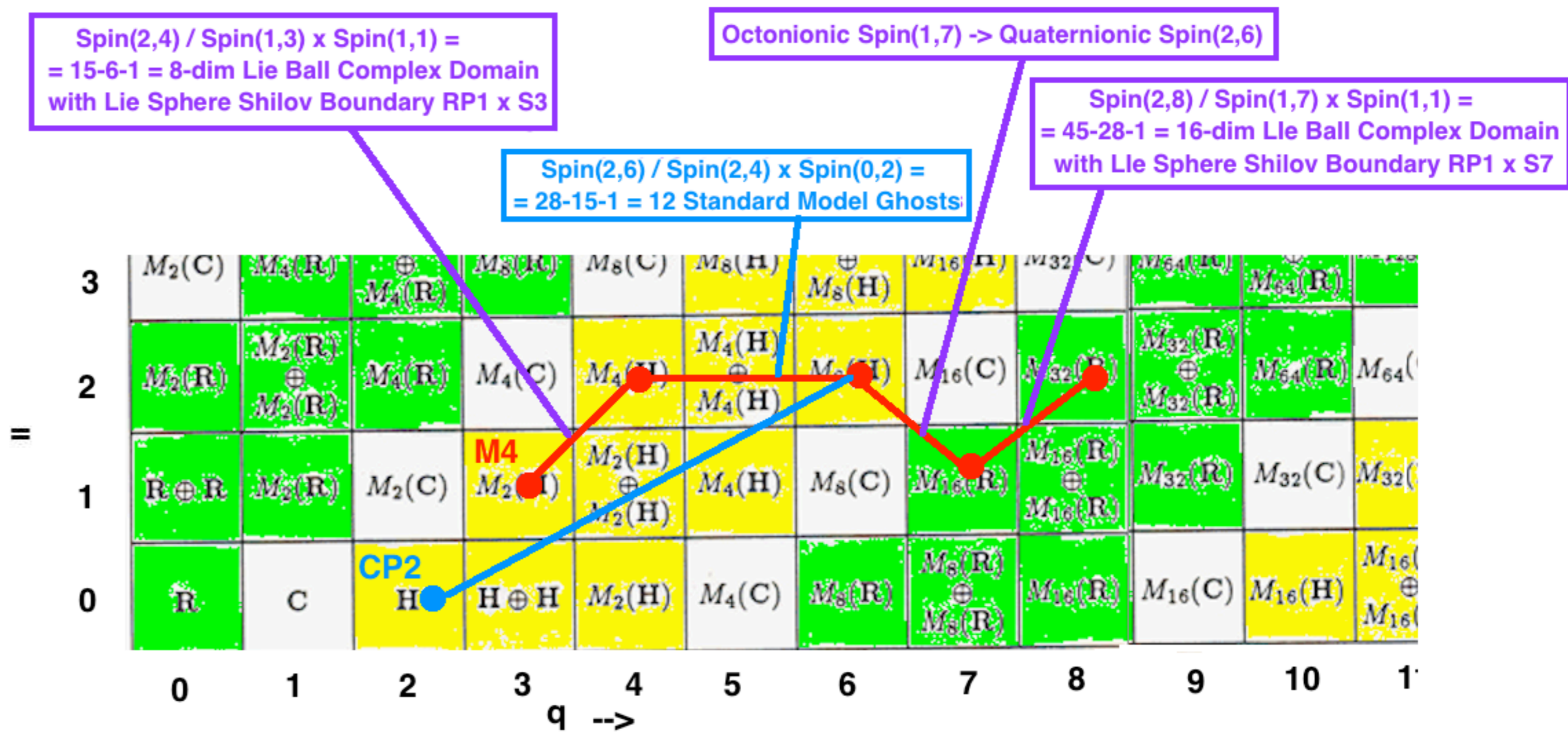
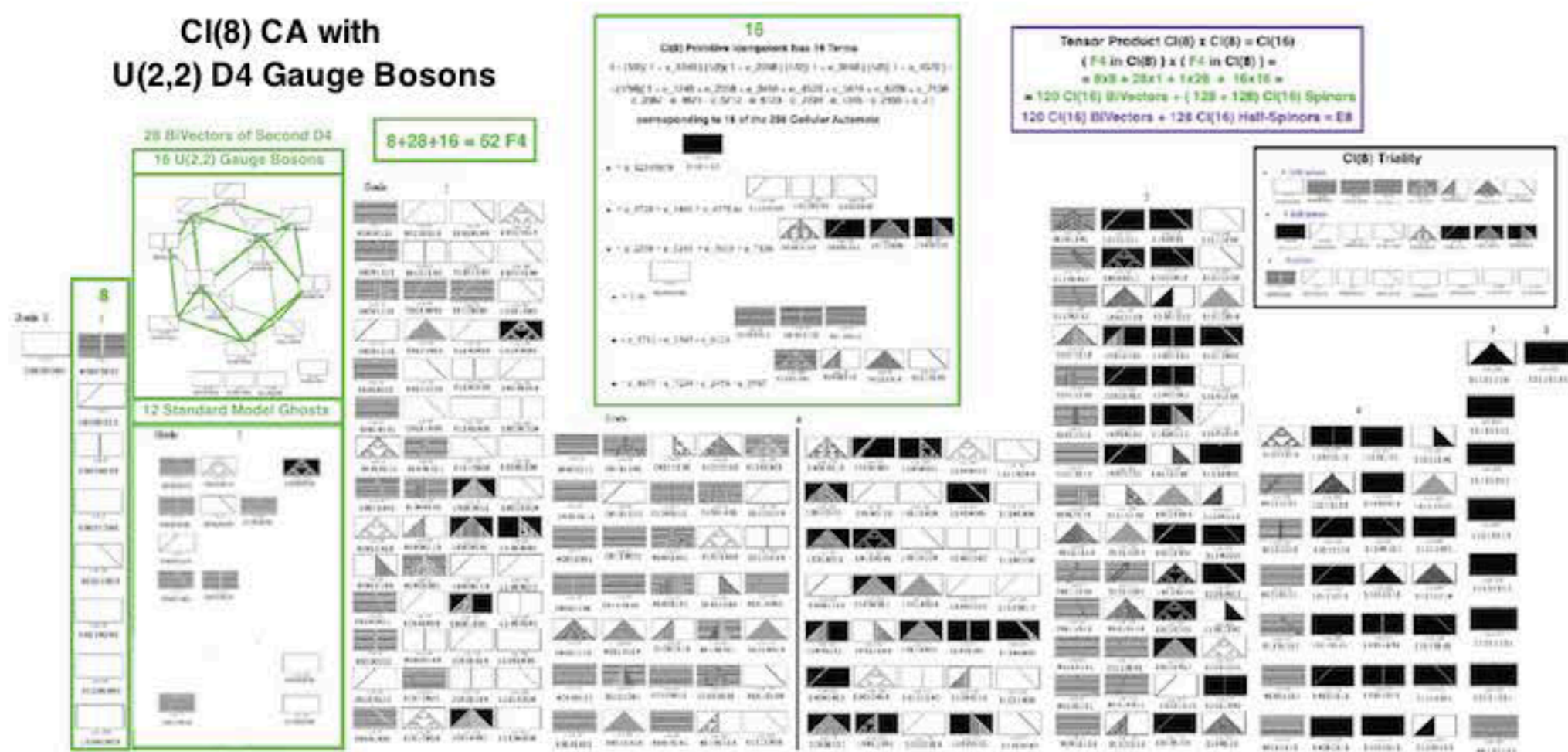

# Kaluza-Klein Spacetime M4 x CP2

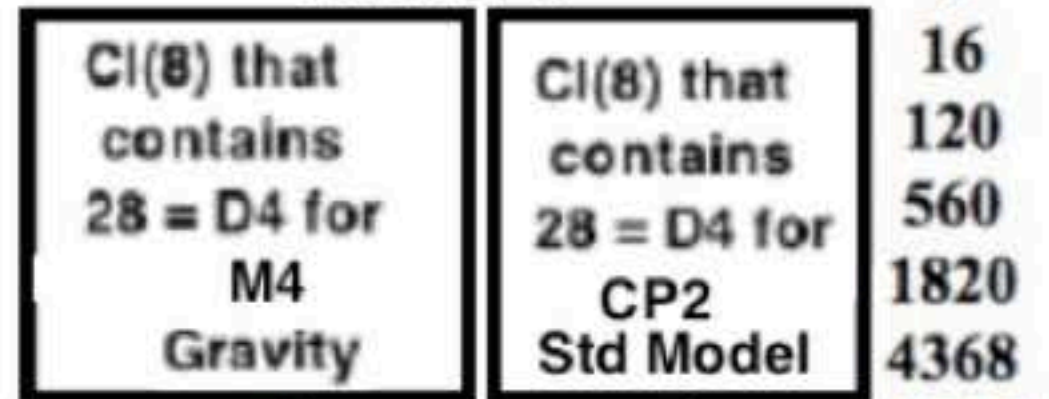

- 1
- 16
- 120
- 560
- 1820
- 4368
- 8008
- 11440
- 12870
- 11440
- 8008
- 4368
- 1820
- 560
- 120
- 56
- 28
- 8
- 1

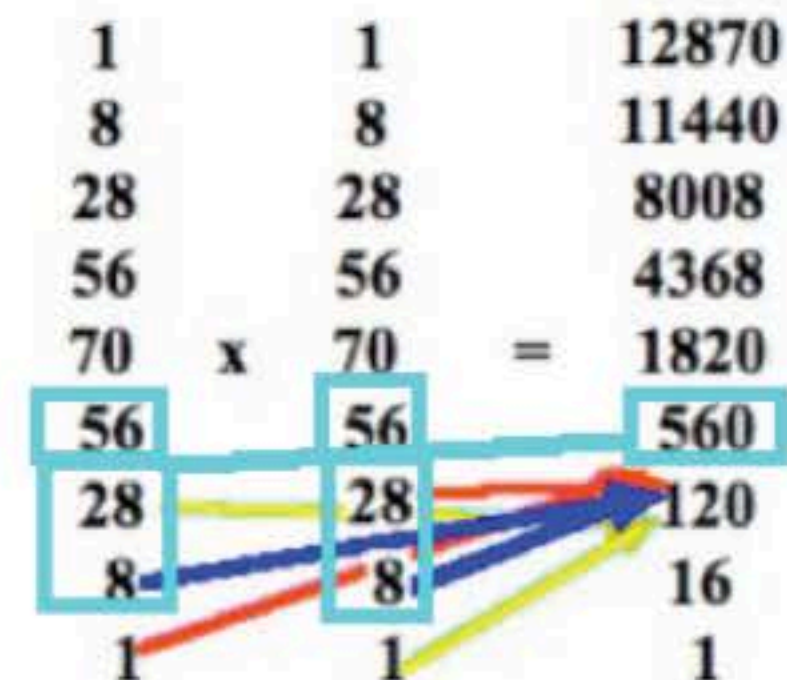

$Cl(8) \times Cl(8) = Cl(16)$

256 Spinors  $(8s \times 8s + 8s \times 8c)$   
 $(8s+8c) \times (8s+8c) = (8c \times 8s + 8c \times 8c)$

$(8s \times 8s + 8c \times 8c)$  128 half-Spinors + 120 D8 = 248 E8  
 with 240 Root Vectors

560 = 10 copies of 56 Fr3(O)

## Cl(8) CA with U(2,2) D4 Gauge Bosons

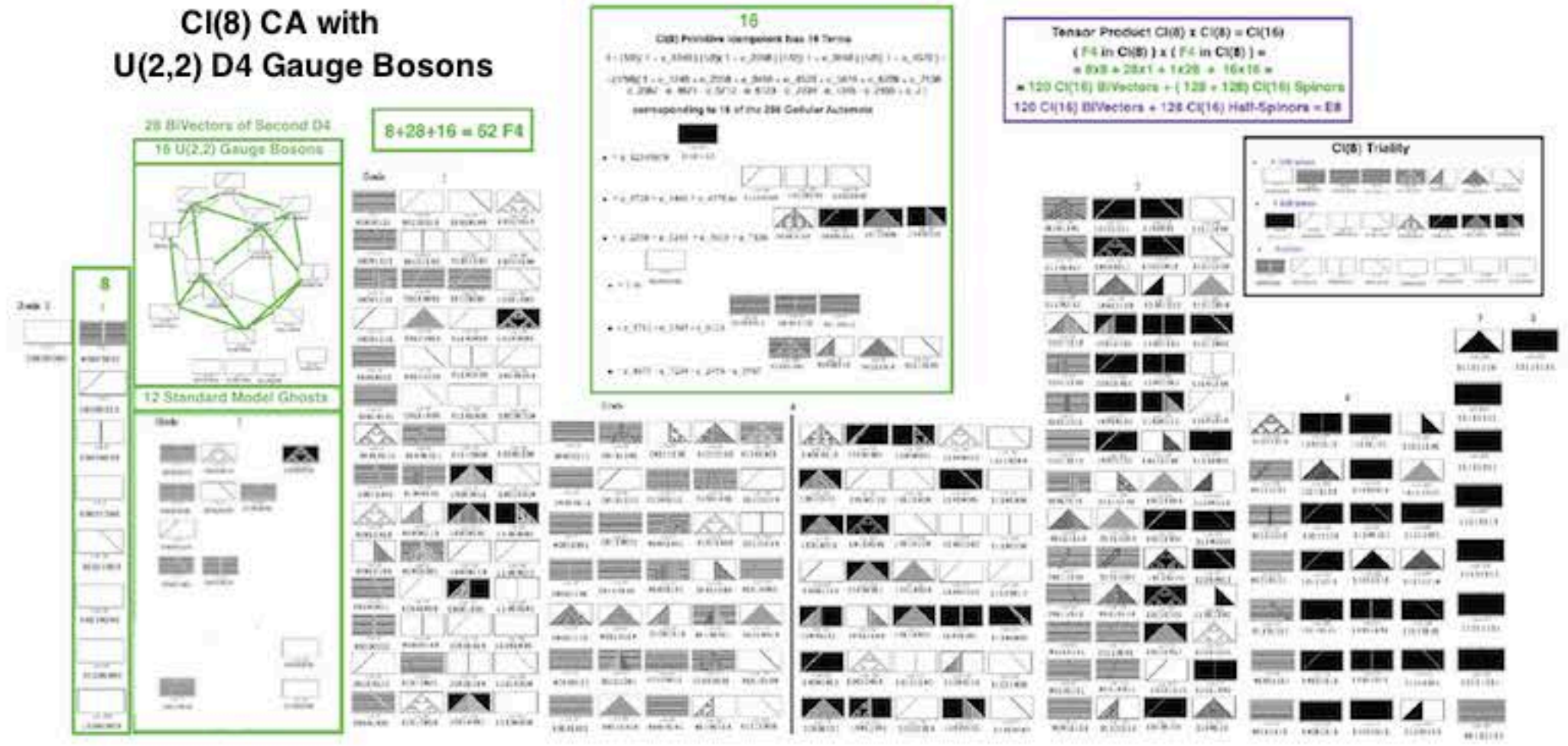

## Cl(8) CA with Std Model D4 Gauge Bosons

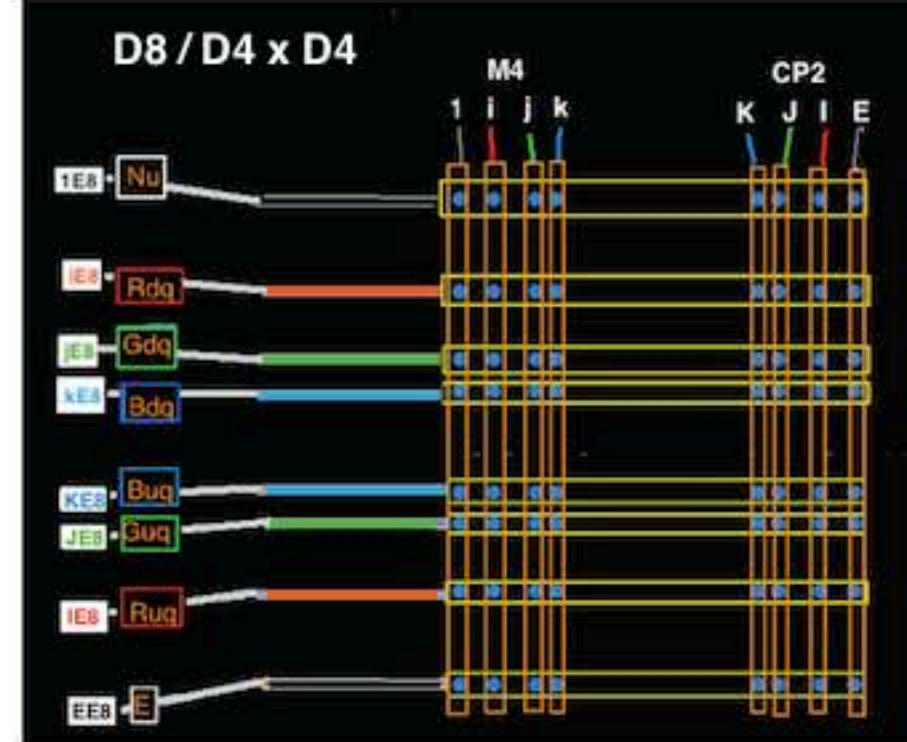
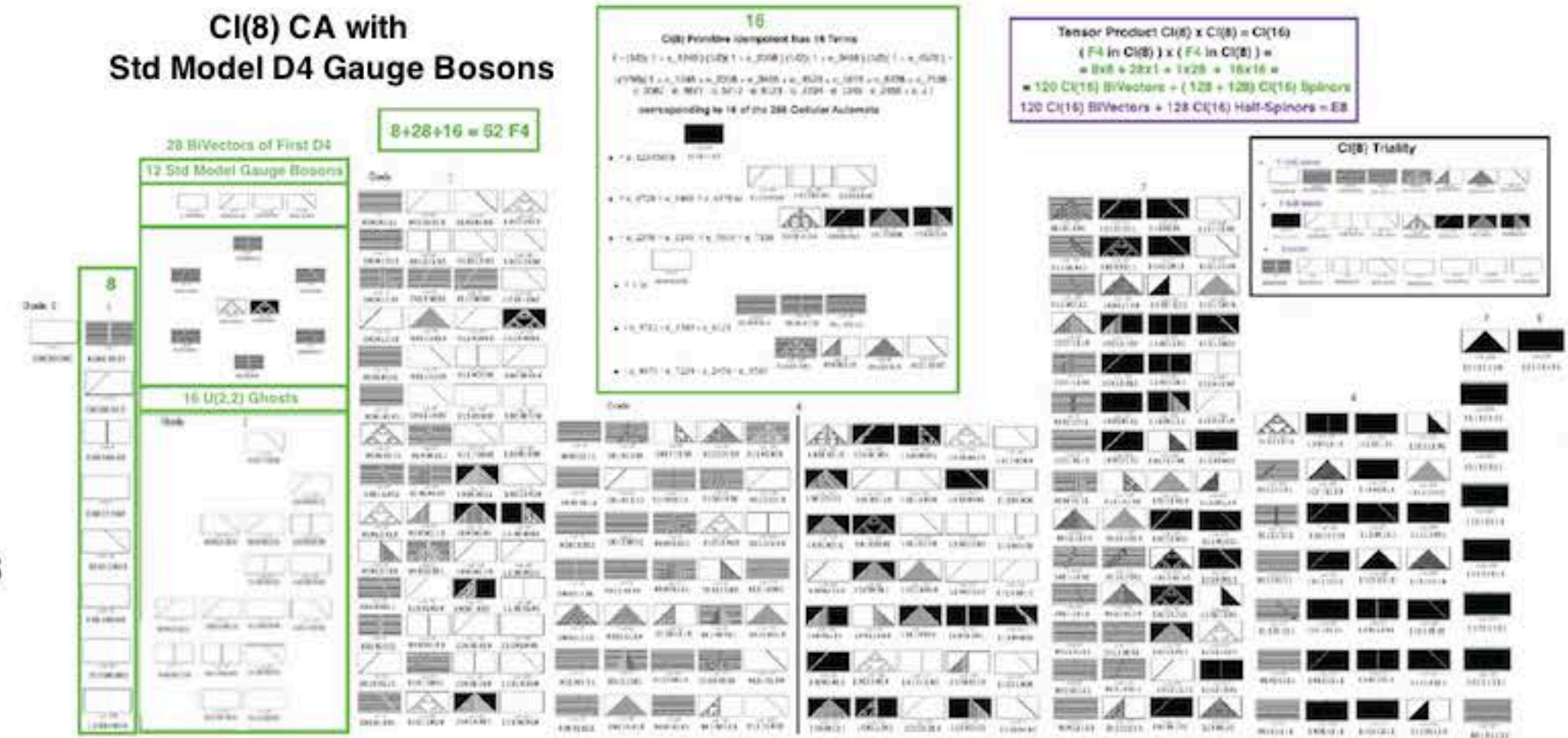

- Nu
- RDQ
- GDQ
- BDQ
- E
- RUQ
- GUQ
- BUQ

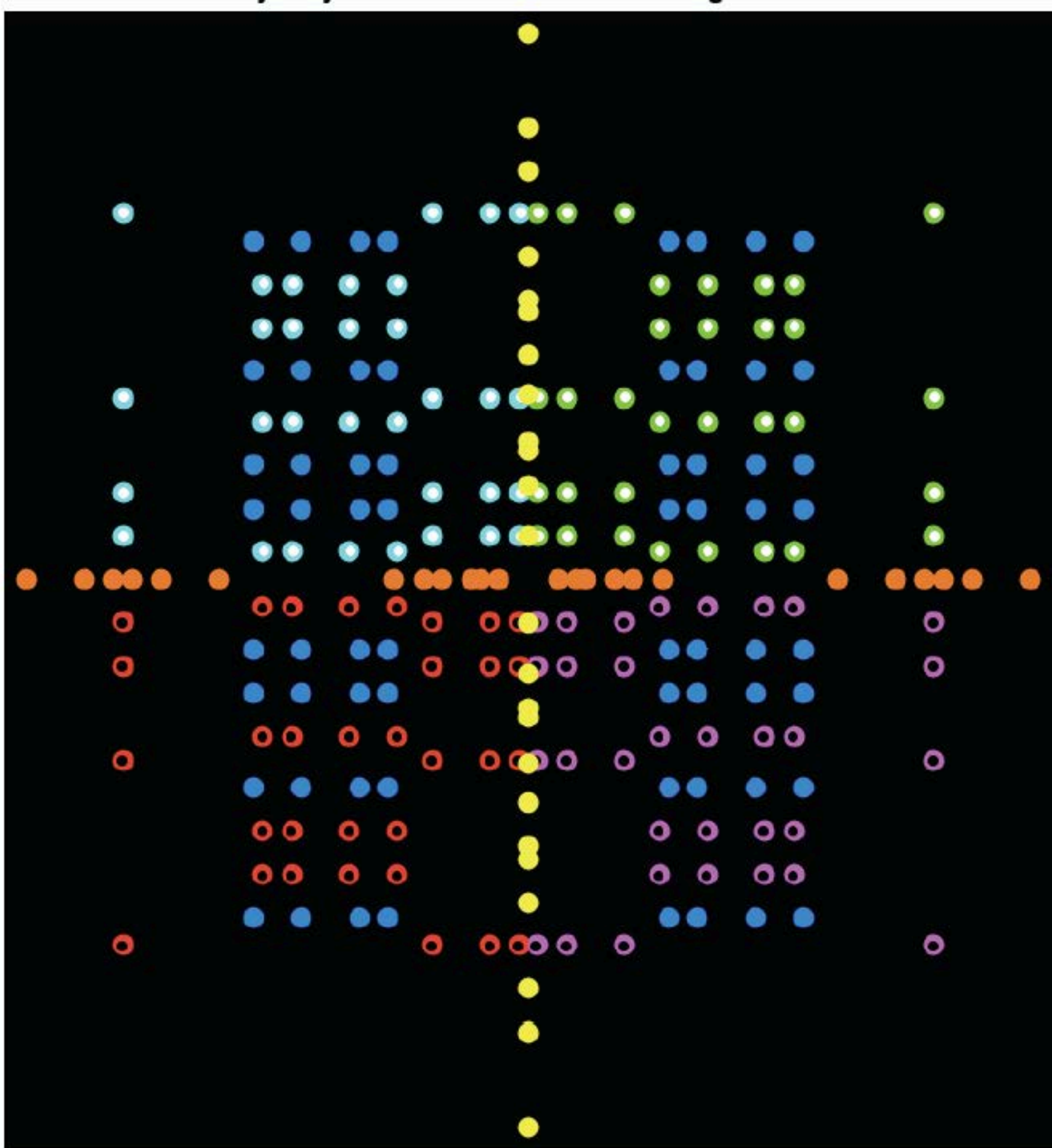

**240 E8 Root Vectors = 112 D8 Root Vectors + 128 D8 half-spinors**

**128 D8 half-spinors = 128 elements of E8 / D8**

**Green and Cyan dots with white centers (32+32=64 dots) = Fermion Particles**

**Red and Magenta dots with black centers (32+32=64 dots) = Fermion AntiParticles**

**112 D8 Root Vectors = 64 D8 / D4xD4 (blue) + 24 D4 (yellow) + 24 D4 (orange)**

In terms of 16x16 Matrices of CI(8) and 256x256 Matrices of CI(16)  
 ( Matrices of Real Numbers. CI(8) TriVectors = 2-color dots with dark blue outer part. )

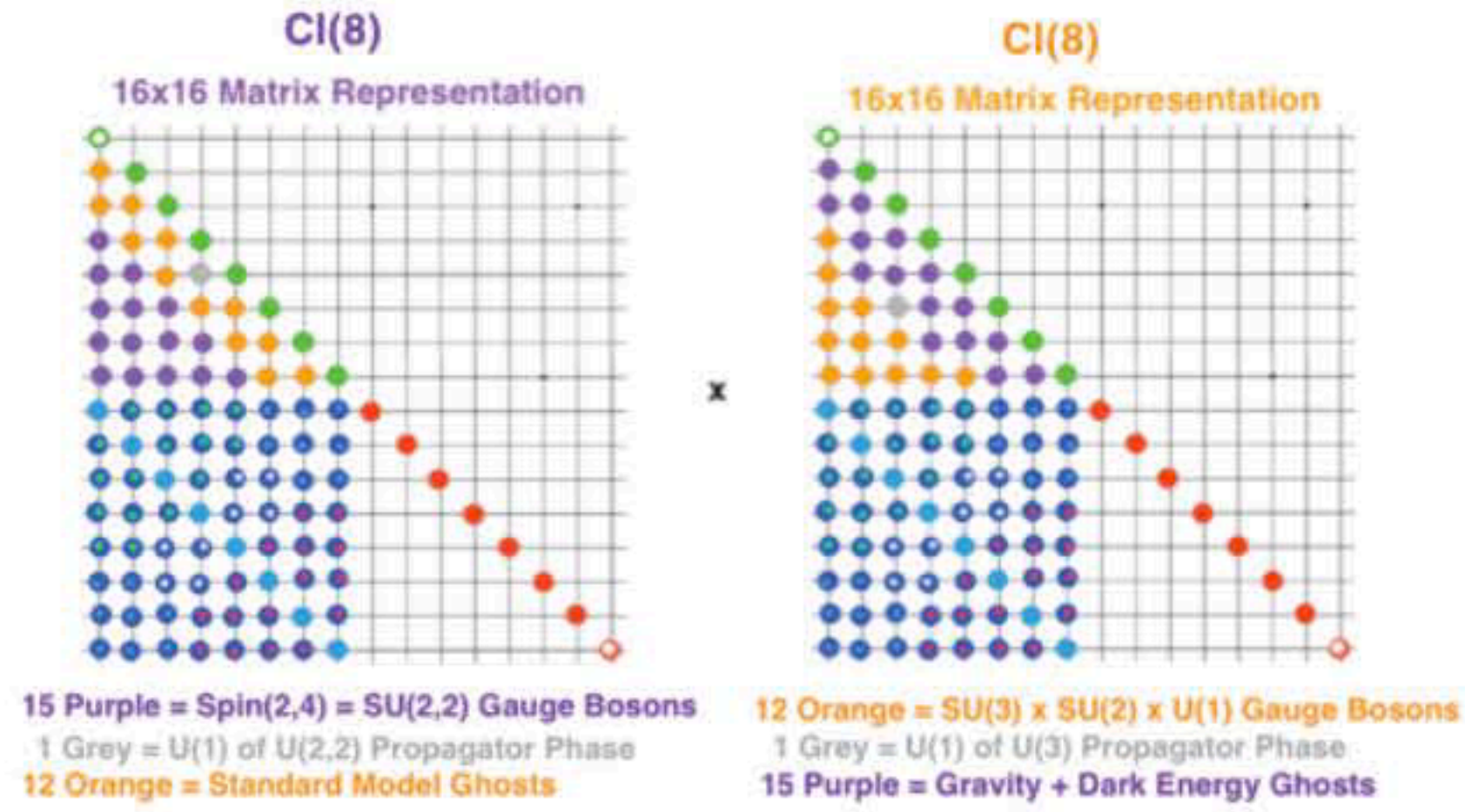

CI(16) 256x256 Matrix Representation

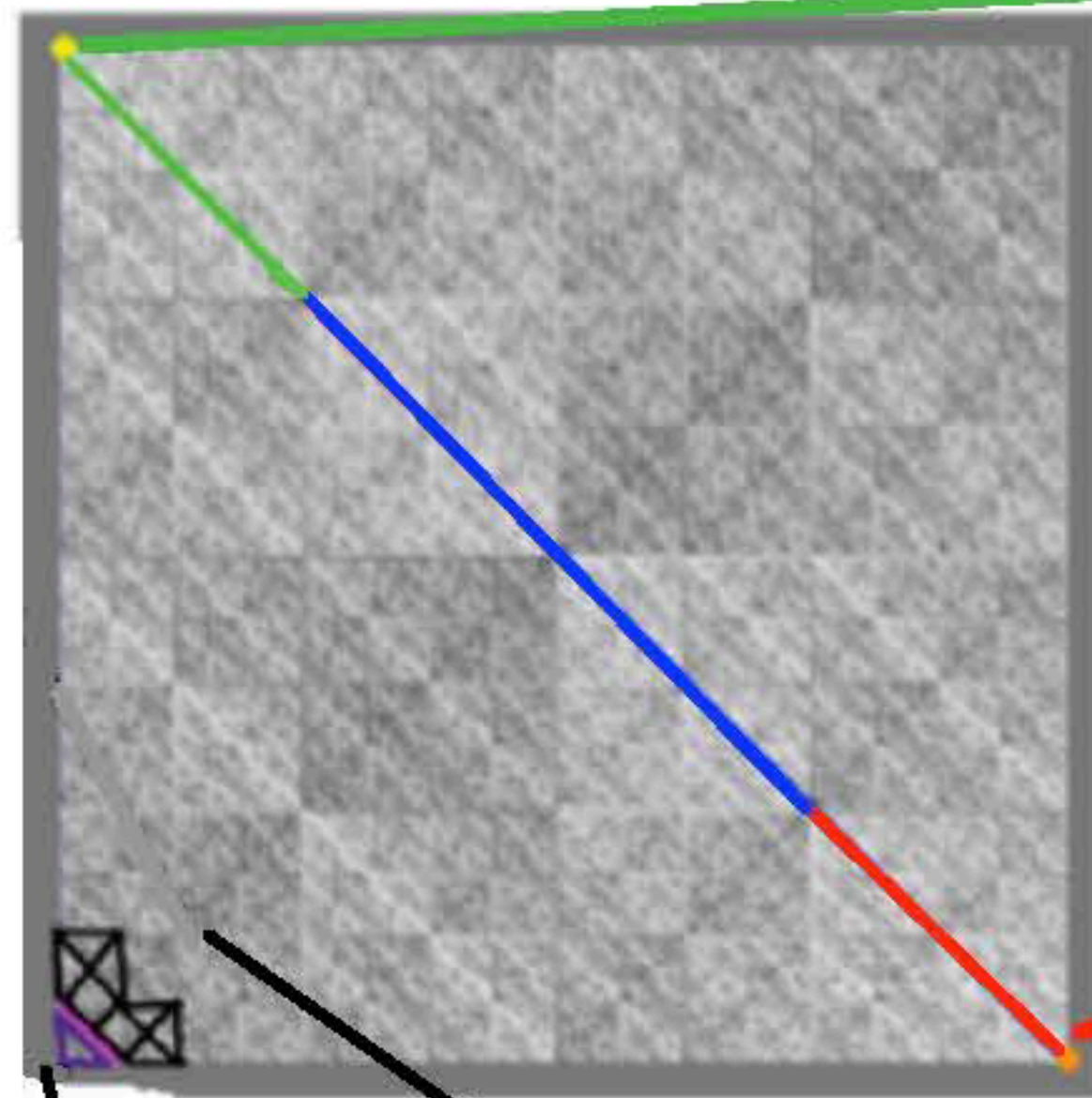

8 Components of 8 Fermion Particles

8 Components of 8 Fermion AntiParticles

E8 / D8

Spinor Fermions

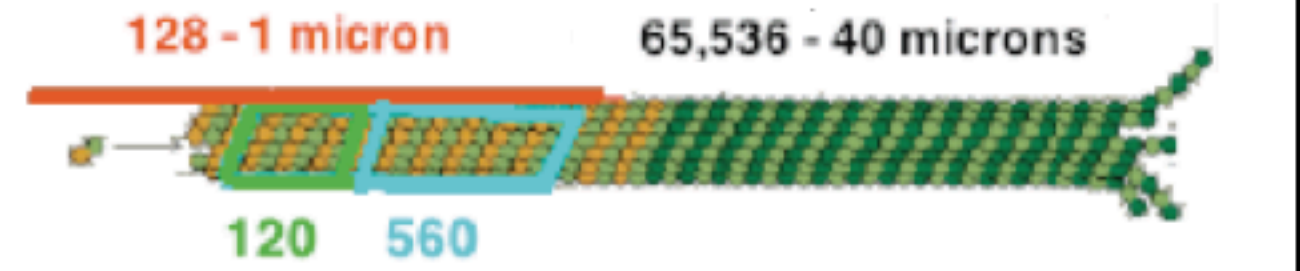

Human Brain Microtubules 40 microns = 65,536 Tubulin Dimers

Physical Body contains Information

CI(16) = 65,536

- 16 Vector Complex Domain
  - 128 half-Spinor part of E8
  - 120 BiVector part of E8
  - 560 TriVector Fr3(O)
- = 64,712 Ethereal Information

each Human Microtubule with 65,536 Tubulin Dimers can have a Bohm Quantum Resonant Connection with a Spirit World Unit Lattice Cell with 65,536-element CI(16) Structure

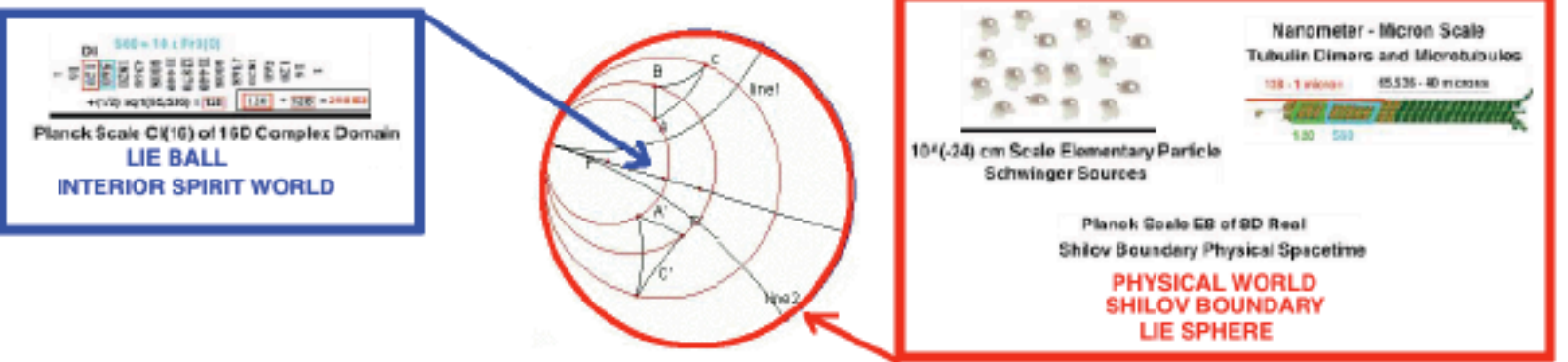

The Earthly World is the 8-real-dim Lie Sphere Shilov Boundary  $RP^1 \times S^7$

The Spirit World is the interior of that Shilov Boundary which is the Type IV(8) Bounded Complex Domain corresponding to the Lie Ball Symmetric Space  $D_5 / D_4 \times U(1)$

CI(16) Vectors  
 BiVectors  
 TriVectors

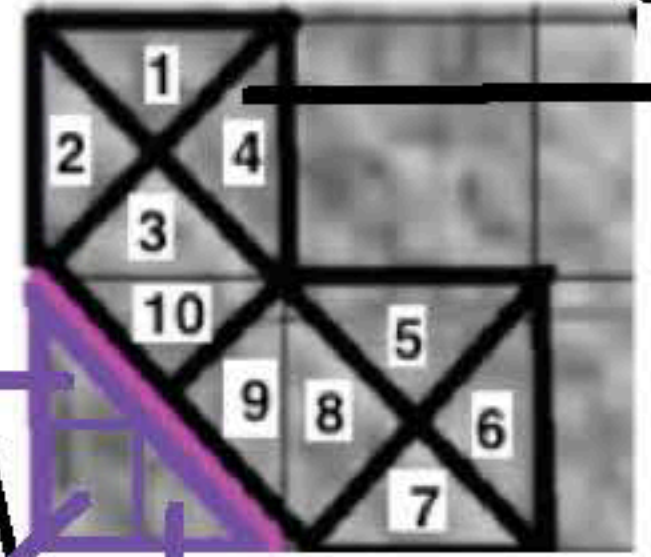

Fr3(O) is Zorn-type matrices  
 a,b,d,d',e,e',f,f' are Real Numbers  
 S+,S'+,V, V',S-,S'- are Octonions  
 \* = Conjugate

Second D4

Standard Model Gauge Bosons  
 Gravity + Dark Energy Ghosts  
 propagator phase Ghost

M4 CP2

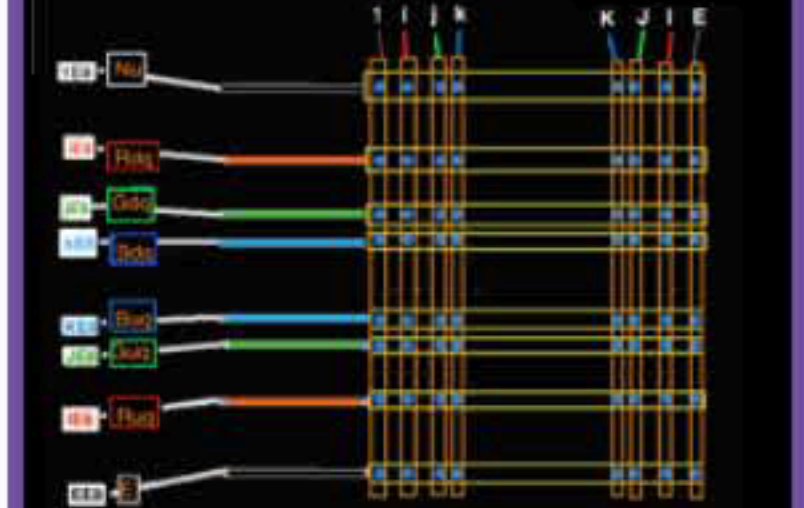

D8 / D4xD4  
 Base Manifold

First D4

Gravity + Dark Energy Gauge Bosons  
 propagator phase  
 Standard Model Ghosts

16x16 Matrix Representation of CI(8)  
 CI(8) TriVectors (4 grey, 8 blue, 8 green, 8 red)  
 representing 56-dim Fr3(O)  
 which contains two copies of 27-dim J3(O)  
 Each J3(O) contains 26-dim traceless part J3(O)0  
 which represents a copy of 26DString Theory

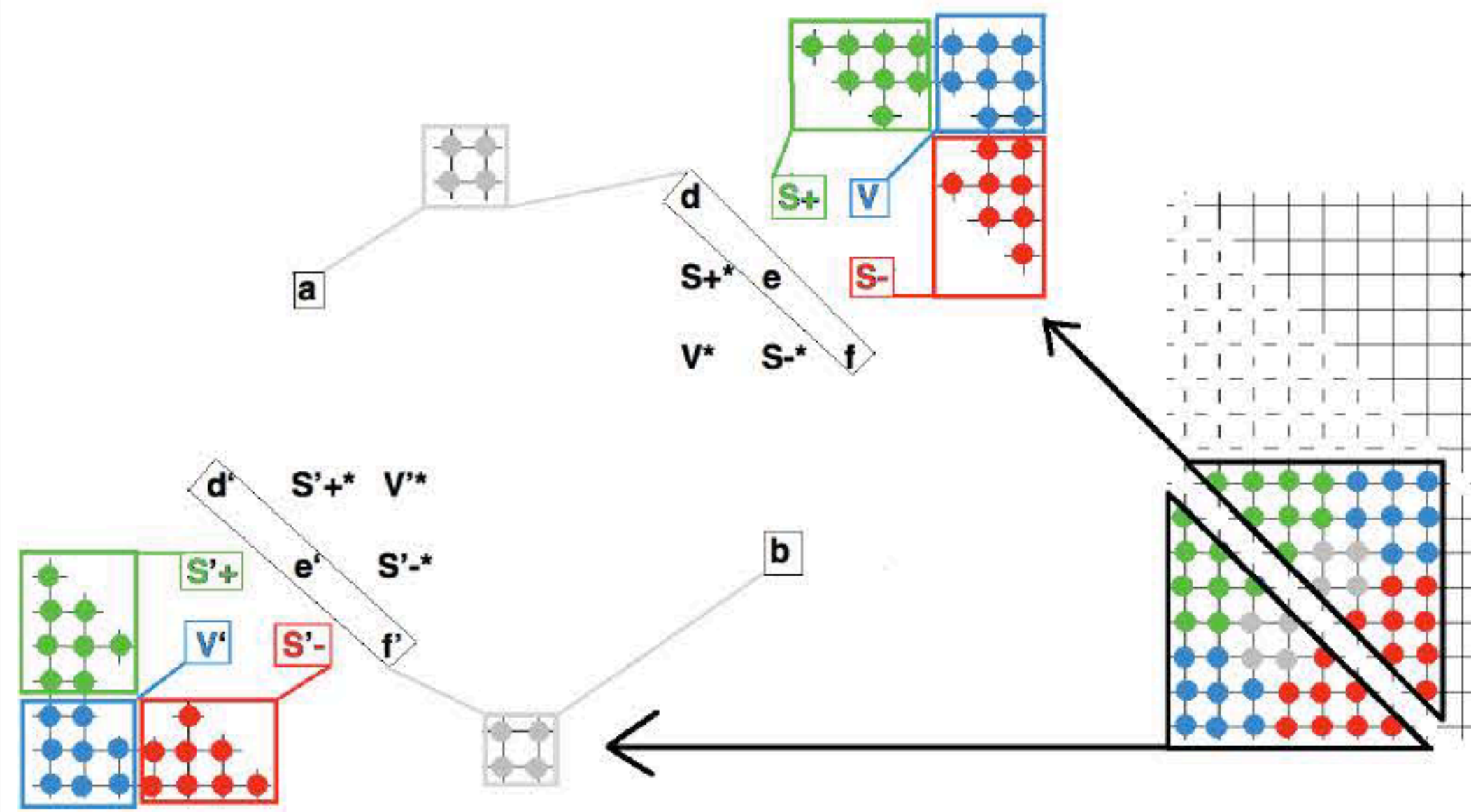



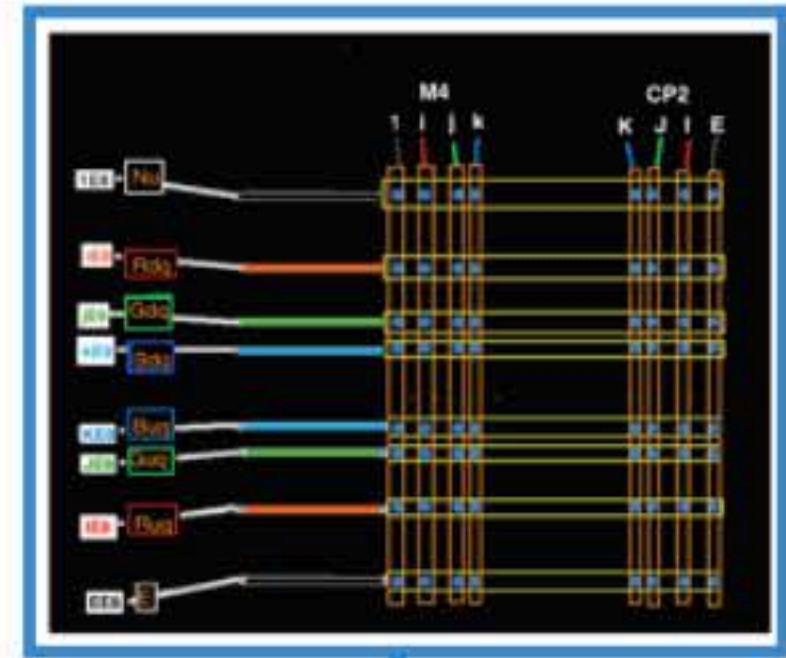

Base Manifold



Gravity + Dark Energy  
Gauge plus  
Bosons and Ghosts  
propagator phase



Standard Model  
Gauge Bosons and Ghosts

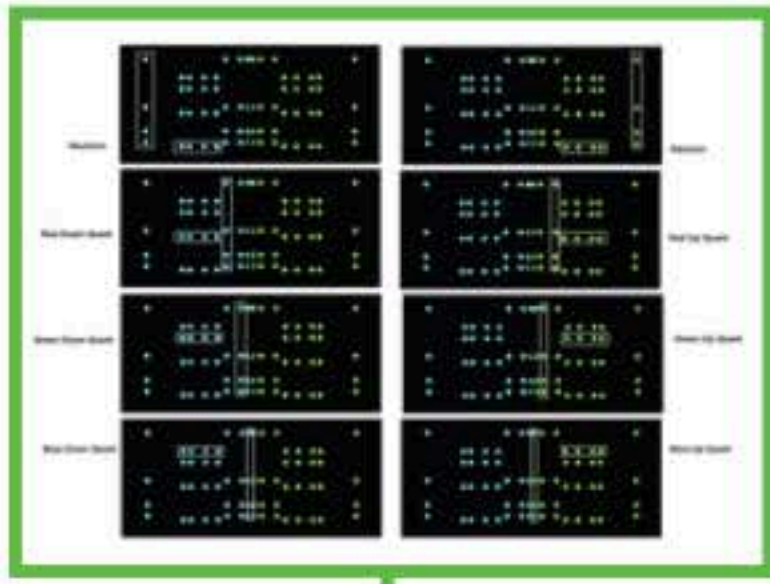

8 Components of 8 Fermion Particles

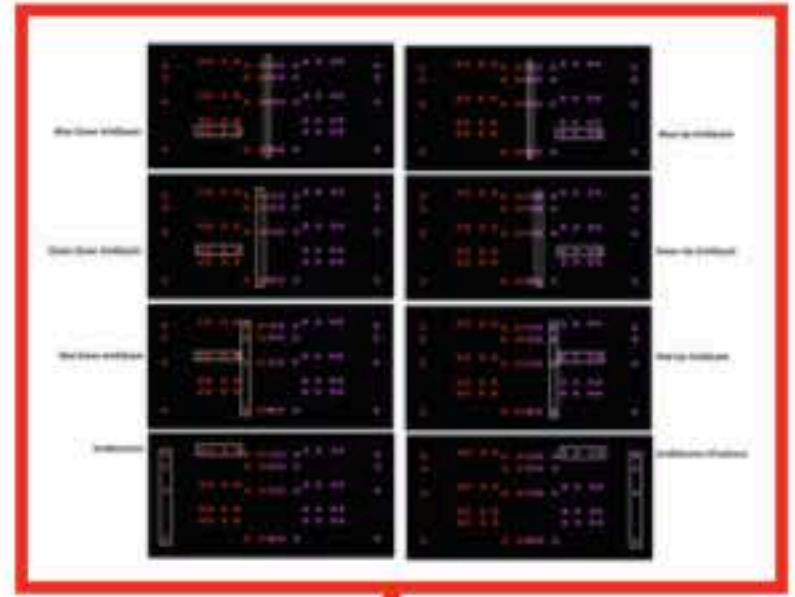

8 Components of 8 Fermion AntiParticles

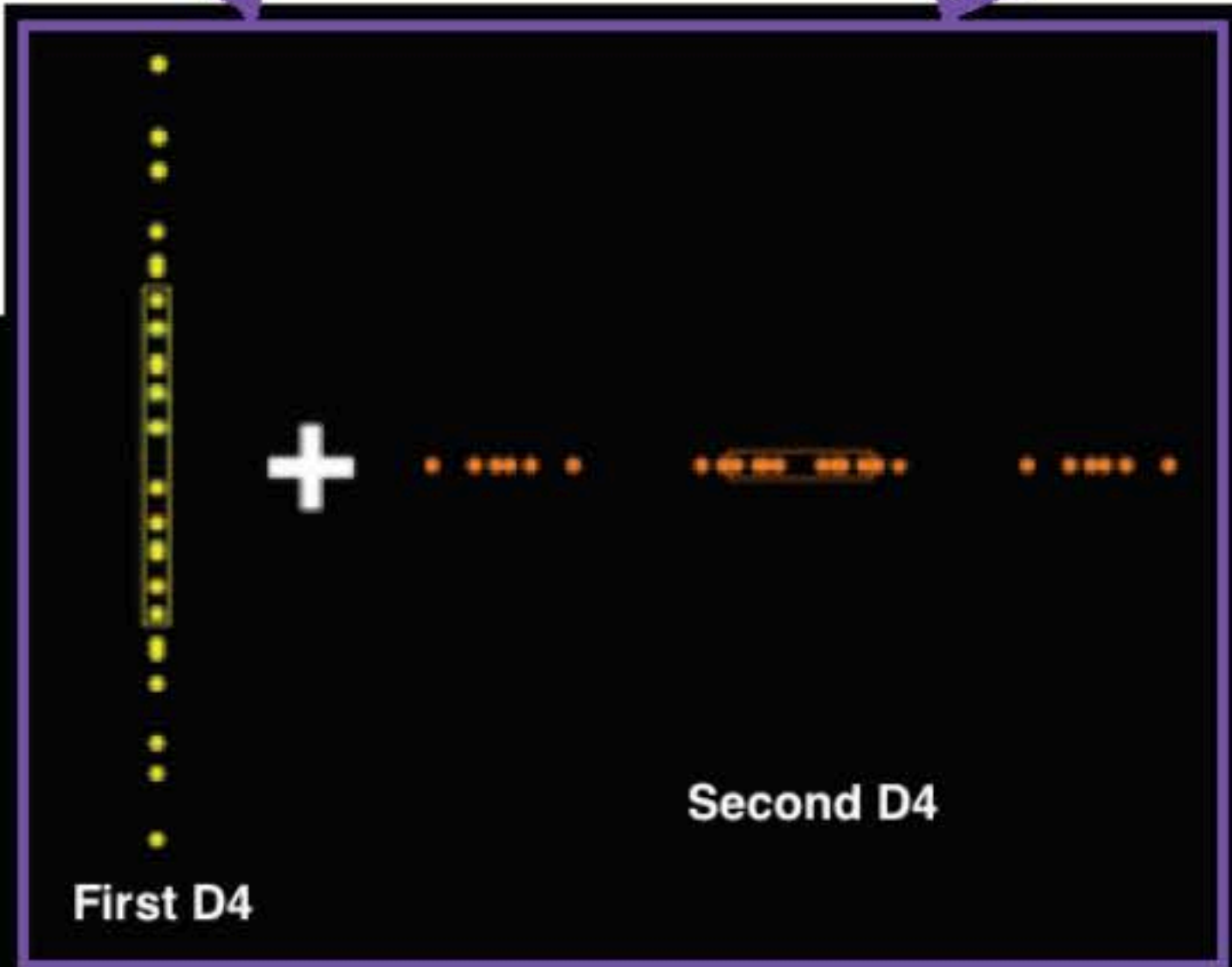
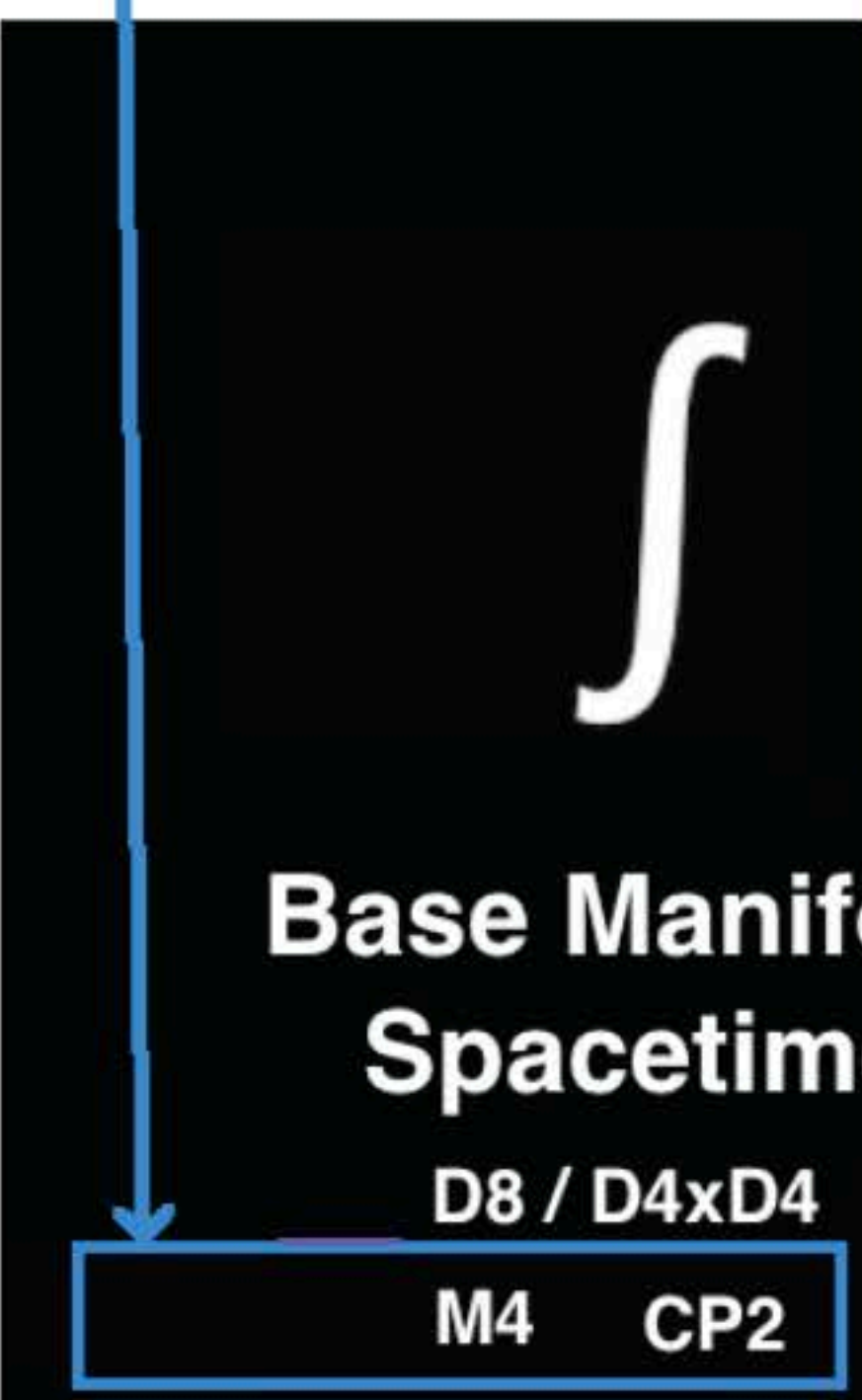

Gauge Bosons and Ghosts  
D4xD4

8D Lagrangian

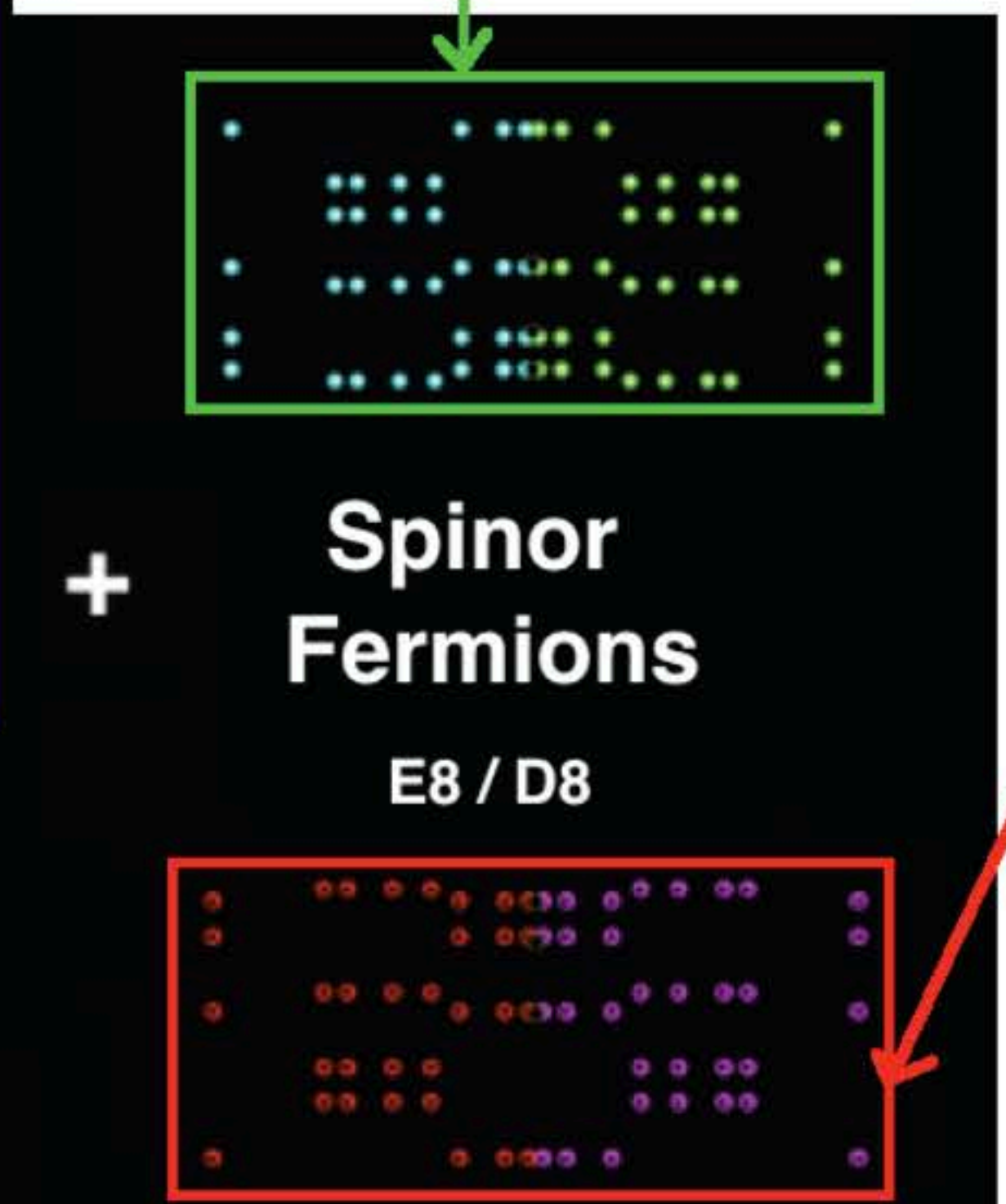

Spinor Fermions  
E8 / D8

E8 / D8

## The 8D-4D E8 Lagrangian System has these characteristics:

Lagrangian has 8-dim Lorentz structure satisfying Coleman-Mandula because its Fermionic fundamental spinor representations are built with respect to spinor representations for 8-dim Spin(1,7) spacetime - see Steven Weinberg, "The Quantum Theory of Fields" Volume III

Lagrangian is UltraViolet finite because each Fermionic Term Fermion has in 8-dim Spacetime units of  $\text{mass}^{(7/2)}$  and each Bosonic Gauge Boson + Ghost Term has units of  $\text{mass}^{(1)}$ , so, since  $(8+8) \times (7/2) = 56 = 28 + 28$  the Fermionic Terms cancel the Bosonic Terms - see Steven Weinberg "1986 Dirac Lectures Elementary Particles and the Laws of Physics"

Lagrangian is Chiral because E8 contains Cl(16) half-spinors (64+64) for a Fermion Generation but does not contain Cl(16) Mirror Fermion AntiGeneration half-spinors. Fermion +half-spinor Particles with high enough velocity are seen as left-handed. Fermion -half-spinor AntiParticles with high enough velocity are seen as right-handed.

Lagrangian obeys Spin-Statistics because the CP2 part of M4xCP2 Kaluza-Klein has index structure Euler number  $2+1 = 3$  and Atiyah-Singer index  $-1/8$  which is not the net number of generations because CP2 has no spin structure but you can use a generalized spin structure (Hawking and Pope (Phys. Lett. 73B (1978) 42-44)) to get (for integral m) the generalized CP2 index  $n_R - n_L = (1/2) m (m+1)$   
Prior to Dimensional Reduction:  $m = 1$ ,  $n_R - n_L = (1/2) \times 1 \times 2 = 1$  for 1 generation  
After Reduction to 4+4 Kaluza-Klein:  $m = 2$ ,  $n_R - n_L = (1/2) \times 2 \times 3 = 3$  for 3 generations  
Hawking and Pope say: "Generalized Spin Structures in Quantum Gravity ... what happens in CP2 ... one could replace the electromagnetic field by a Yang-Mills field whose group G had a double covering  $G_{\sim}$ . The fermion field would have to occur in representations which changed sign under the non-trivial element of the kernel of the projection ...  $G_{\sim} \rightarrow G$  while the bosons would have to occur in representations which did not change sign ...". For E8 physical gauge bosons are in the  $28+28=56$ -dim D4xD4 subalgebra. D4 = SO(8) is the Hawking-Pope G with double covering  $G_{\sim} = \text{Spin}(8)$ . The 8 fermion particles / antiparticles are D4 half-spinors represented within E8 by anti-commutators and so do change sign while the 28 gauge bosons are D4 adjoint represented within E8 by commutators and so do not change sign.

E8 Lagrangian inherits from F4 the property whereby its Spinor Part need not be written as Commutators but can also be written in terms of Fermionic AntiCommutators - see Pierre Ramond hep-th/0112261 -also, F4 lives in Cl(8) as Vectors + BiVectors + Spinors and by 8-Periodicity Cl(16) = tensor product Cl(8) x Cl(8) and E8 lives in Cl(16) as BiVectors + half-Spinors.

# Lagrangian

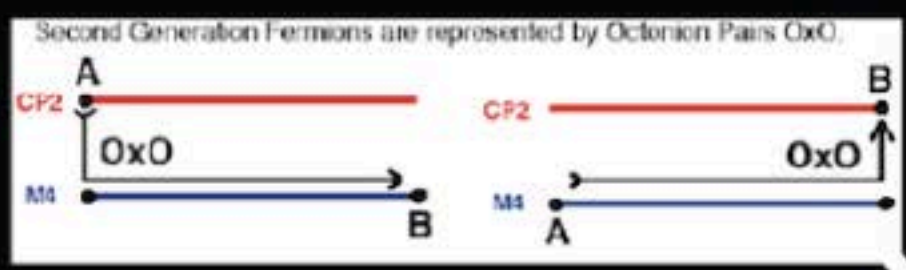
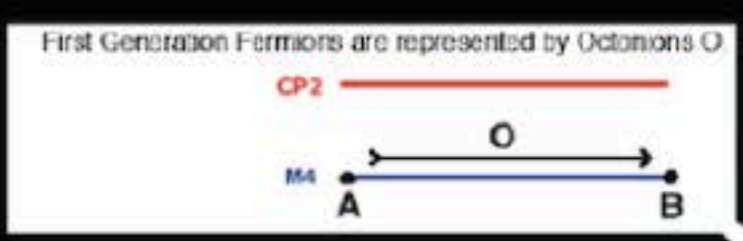

3 Kaluza-Klein Fermion Generations

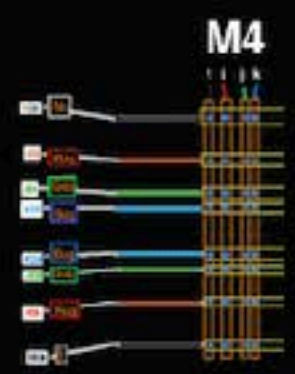

NJL Higgs as Condensate of  $T\bar{T}$

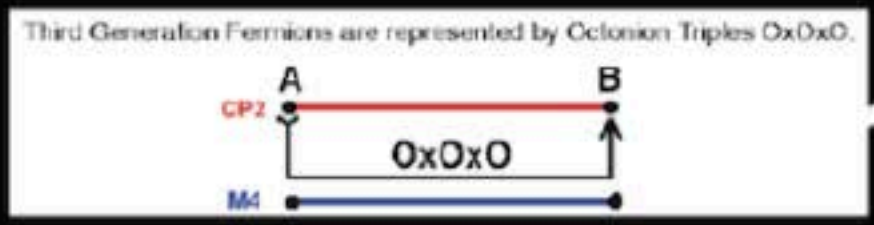

RGB Truth Quarks



The Real Form of E8 at Initial Big Bang is Compact E8(-248) with SO(16) Symmetry.

The Real Form of E8 during Inflation is E8(8) with SO(8,8) Symmetry.  
 In the 8D Lagrangian the Base Manifold Spacetime is 8-dim Octonion with respect to which Quantum Processes are Non-Unitary so that during Inflation Particles are created.

After Inflation the Symmetry of Spacetime is broken from Octonion to Quaternion, the Real Form of E8 becomes E8(-24) with  $SO^*(16) = Sk(8,H)$  Symmetry, and the Base Manifold Spacetime becomes  $M4 \times CP2$  Kaluza-Klein (where  $M4 =$  Minkowski and  $CP2 = SU(3) / SU(2) \times U(1) =$  Internal Symmetry Space)

Breaking Spacetime and World-Lines of Particles into  $M4 \times CP2$  Kaluza-Klein produces Higgs (Mayer and Trautman in Acta Physica Austriaca, Suppl. XXIII (1981)) and Fermion Generations 2 and 3 which produces a Nambu - Jona-Lasinio System of Higgs and Truth Quarks (Yamawaki et al in hep-ph/9603293 and hep-ph/0311165 ) that has Higgs as Truth Quark-AntiQuark condensate and 3 mass states:

- Higgs at 125 GeV and Truth Quark at 130 GeV
- Higgs at 200 GeV and Truth Quark at 174 GeV
- Higgs at 250 GeV and Truth Quark at 220 GeV

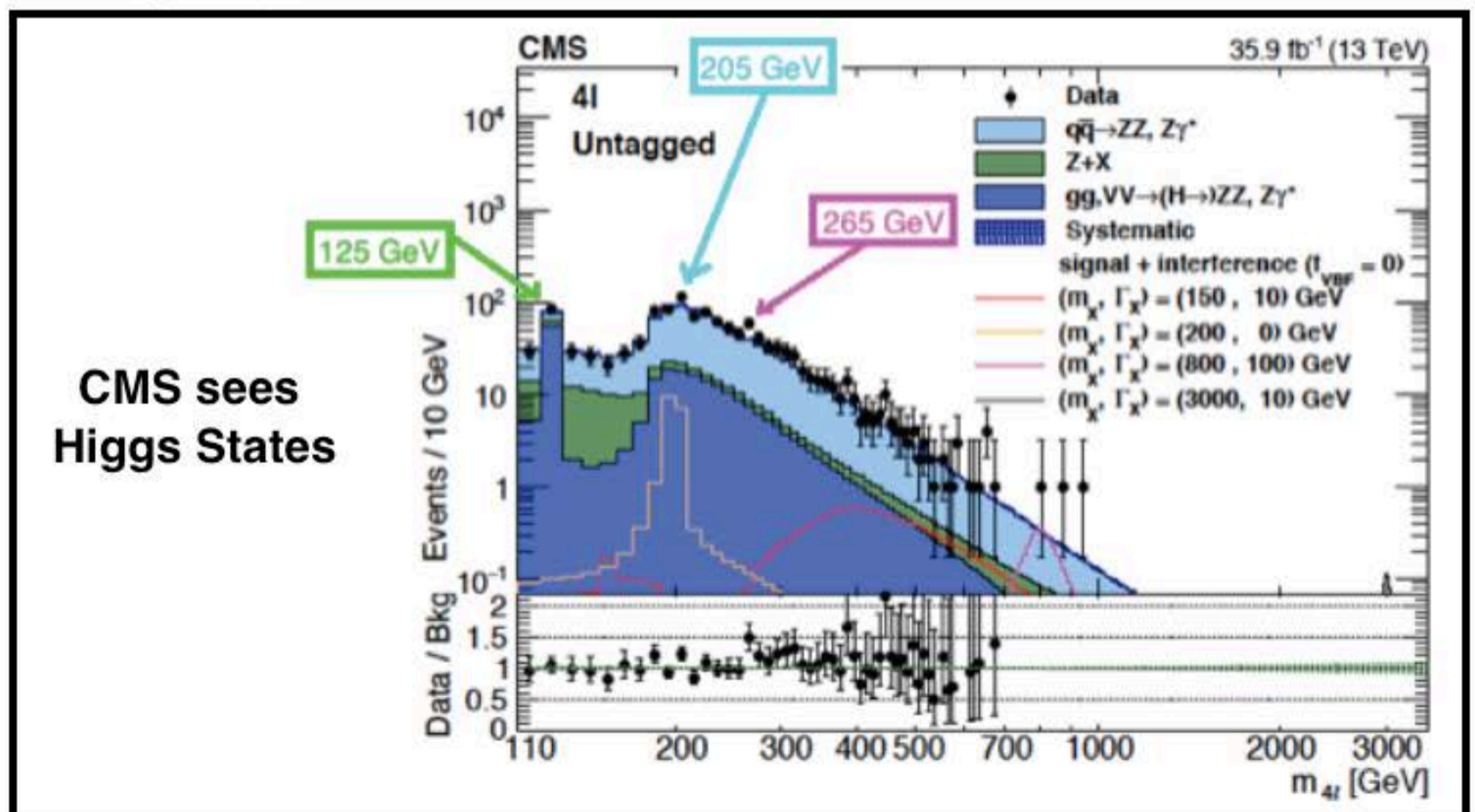
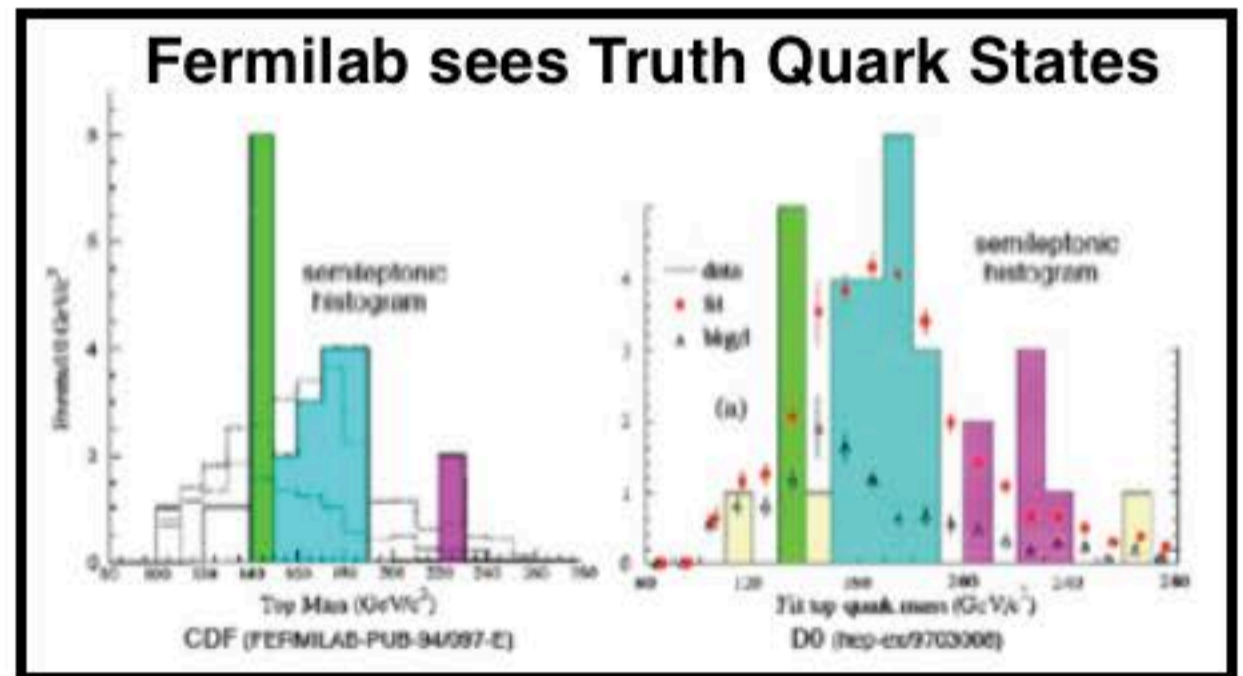
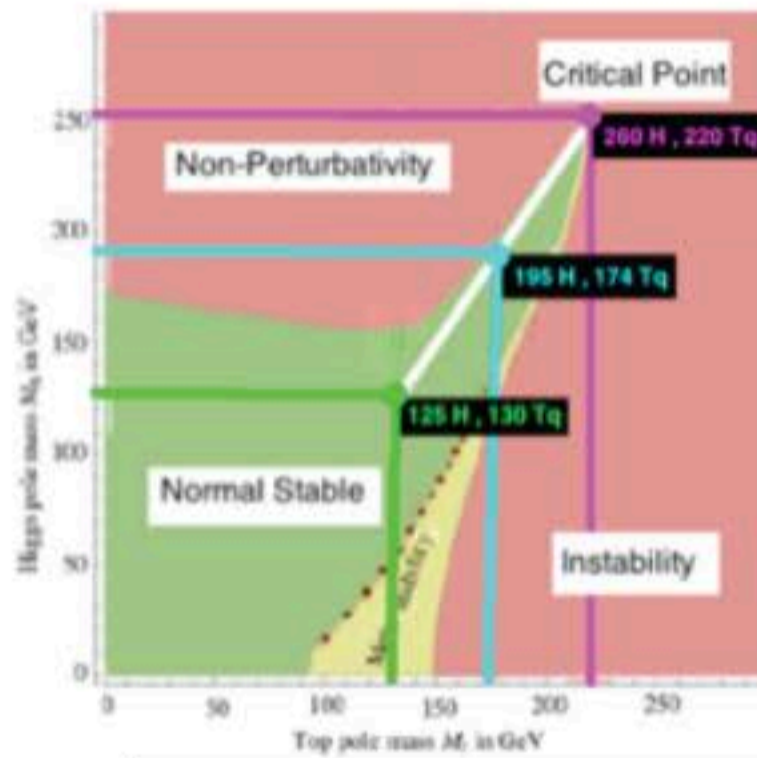

CMS sees Higgs States

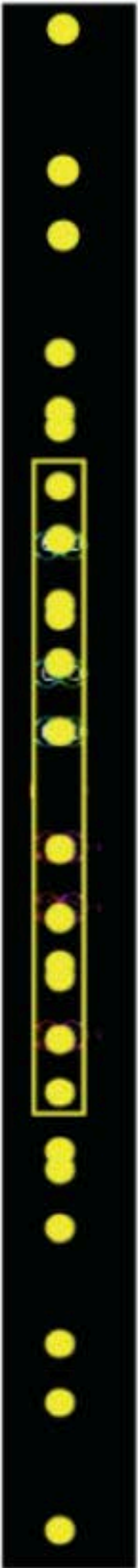

The 24 Yellow Root Vectors of the D4 of E8 Gravity + Standard Model Ghosts are on the Vertical Y-axis.

12 of them in the Yellow Box represent the 12 Root Vectors of the Conformal Gauge Group  $SU(2,2) = Spin(2,4)$  of Conformal Gravity + Dark Energy.

The 4 Cartan Subalgebra elements of  $SU(2,2) \times U(1) = U(2,2)$  correspond to the 4 Cartan Subalgebra elements of D4 of E8 Gravity + Standard Model Ghosts and to the other half of the 8 Cartan Subalgebra elements of E8.

The other  $24 - 12 = 12$  Yellow Root Vectors represent Ghosts of 12D Standard Model whose Gauge Groups are  $SU(3) SU(2) U(1)$ .

Gravity and Dark Energy come from its Conformal Subgroup  $SU(2,2) = Spin(2,4)$

- see Mohapatra "Unification and Supersymmetry section 14.6  
R. Aldrovandi and J. G. Peireira in gr-qc/9809061

$SU(2,2) = Spin(2,4)$  has 15 generators:

1 Dilation representing Higgs Ordinary Matter

4 Translations representing Primordial Black Hole Dark Matter

10 = 4 Special Conformal + 6 Lorentz representing Dark Energy

(see Irving Ezra Segal, "Mathematical Cosmology and Extragalactic Astronomy" (Academic 1976))

The basic ratio Dark Energy : Dark Matter : Ordinary Matter = 10:4:1 = 0.67 : 0.27 : 0.06

When the dynamics of our expanding universe are taken into account, the ratio is calculated to be **0.75 : 0.21 : 0.04**

### Ghosts correspond to Gauge Bosons:

Steven Weinberg in The Quantum Theory of Fields Volume II Section 15.7 said:

"... there is a beautiful geometric interpretation of the ghosts and the BRST symmetry ...

The gauge fields  $A_a^\mu$  may be written as one-forms  $A_a = A_{a\mu} dx^\mu$ , where  $dx^\mu$  are a set of anticommuting c-numbers. ... This can be combined with the ghost to compose a one-form  $A_a = A_a + w_a$  in an extended space.

Also, the ordinary exterior derivative  $d = dx^\mu d/dx^\mu$  may be combined with the BRST operator  $s$  to form an exterior derivative  $D = d + s$  in this space, which is nilpotent because  $s^2 = d^2 = sd + ds = 0$  ...".

The 24 Orange Root Vectors of the D4 of E8 Standard Model + Gravity Ghosts are on the Horizontal X-axis.



8 of them in the Orange Box represent the 8 Root Vectors of the Standard Model Gauge Groups SU(3) SU(2) U(1).

Their 4 Cartan Subalgebra elements correspond to the 4 Cartan Subalgebra elements of D4 of E8 Standard Model + Gravity Ghosts and to half of the 8 Cartan Subalgebra elements of E8.

The other 24-8 = 16 Orange Root Vectors represent Ghosts of 16D U(2,2) which contains the Conformal Group SU(2,2) = Spin(2,4) that produces Gravity + Dark Energy by the MacDowell-Mansouri mechanism.

Standard Model Gauge groups come from CP2 = SU(3) / SU(2) x U(1) (as described by Batakis in Class. Quantum Grav. 3 (1986) L99-L105)

Electroweak SU(2) x U(1) is gauge group as isotropy group of CP2.

SU(3) is global symmetry group of CP2 but due to Kaluza-Klein M4 x CP2 structure of compact CP2 at every M4 spacetime point, it acts as Color gauge group with respect to M4.

### Ghosts correspond to Gauge Bosons:

Jean Thierry-Mieg in J. Math. Phys. 21 (1980) 2834-2838 said:

“... The ghost and the gauge field:

The single lines represent a local coordinate system of a principal fiber bundle of base space-time.

The double lines are 1 forms.

The connection of the principle bundle  $\omega$  is assumed to be vertical.

Its contravariant components  $\phi^i$  and  $X^i$  are recognized, respectively, as the Yang-Mills gauge field and the Faddeev-Popov ghost form ...

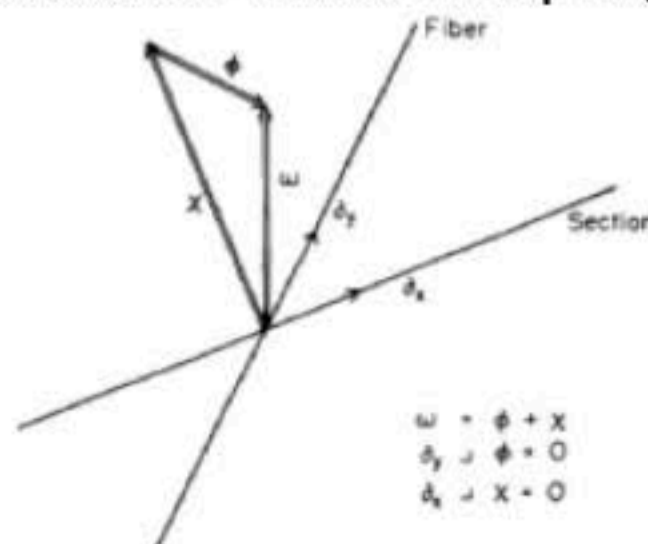

# 56 Cl(8) TriVectors correspond to Fr3(O) of 26D World-Line=String Theory

56 Cl(8) TriVectors

Circle 3

9000111	00101010	01010100	10010010
00101011	00101100	01011000	10010100
00101111	00110010	01100011	10110010
00101110	00110010	01100010	10100011
00101011	00110100	01100100	10100100
00101010	00110000	01100000	10100100
00101110	01000011	01110000	10101000
00110001	00100101	10000011	10110000
90011110	01000110	10000101	11000001
90011100	01001001	10000110	11000010
00100001	01001010	10001001	11000100
00100101	01001100	10001010	11000100
00100110	01010001	10001100	11010000
00101001	01010010	10001001	11000000

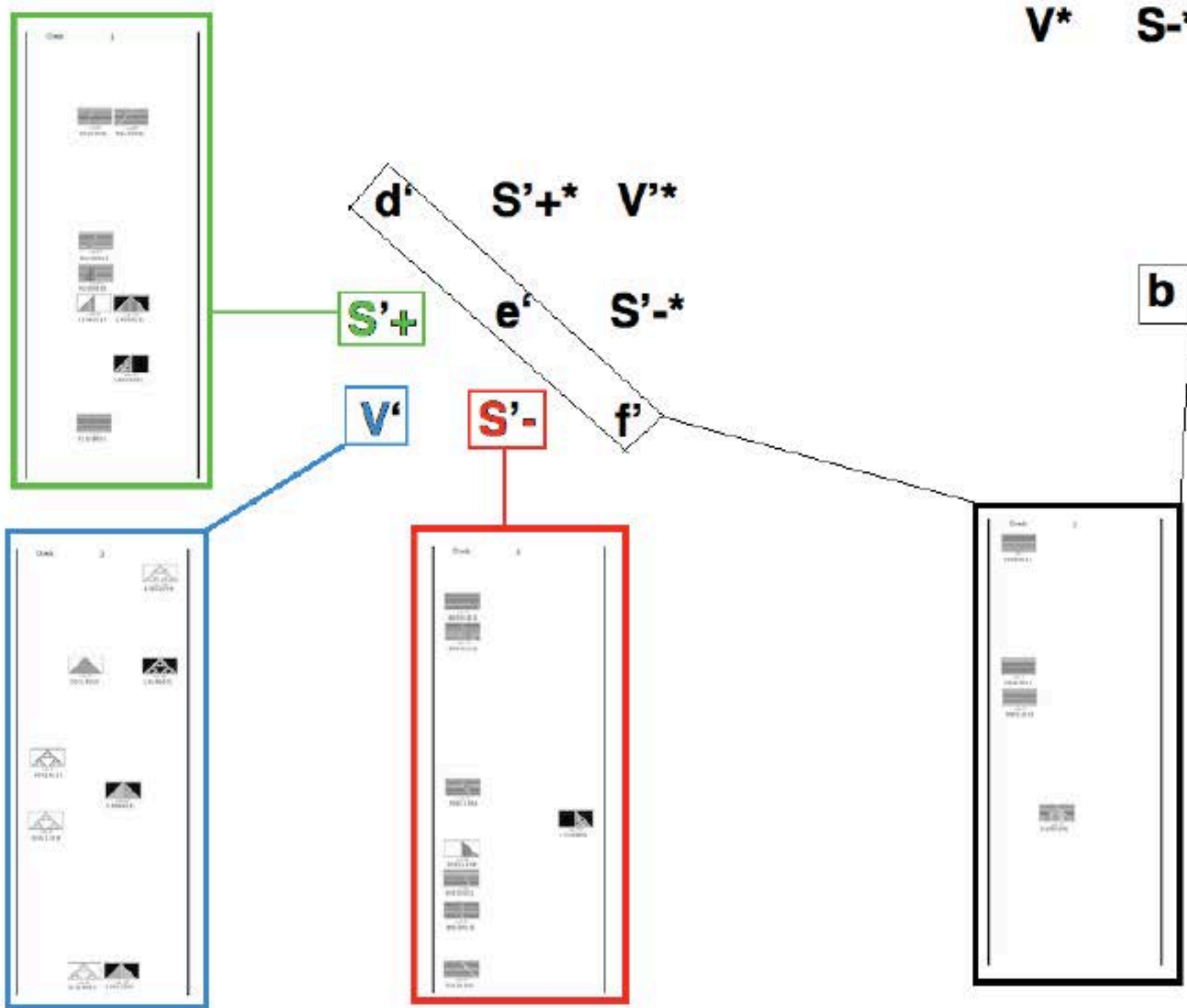
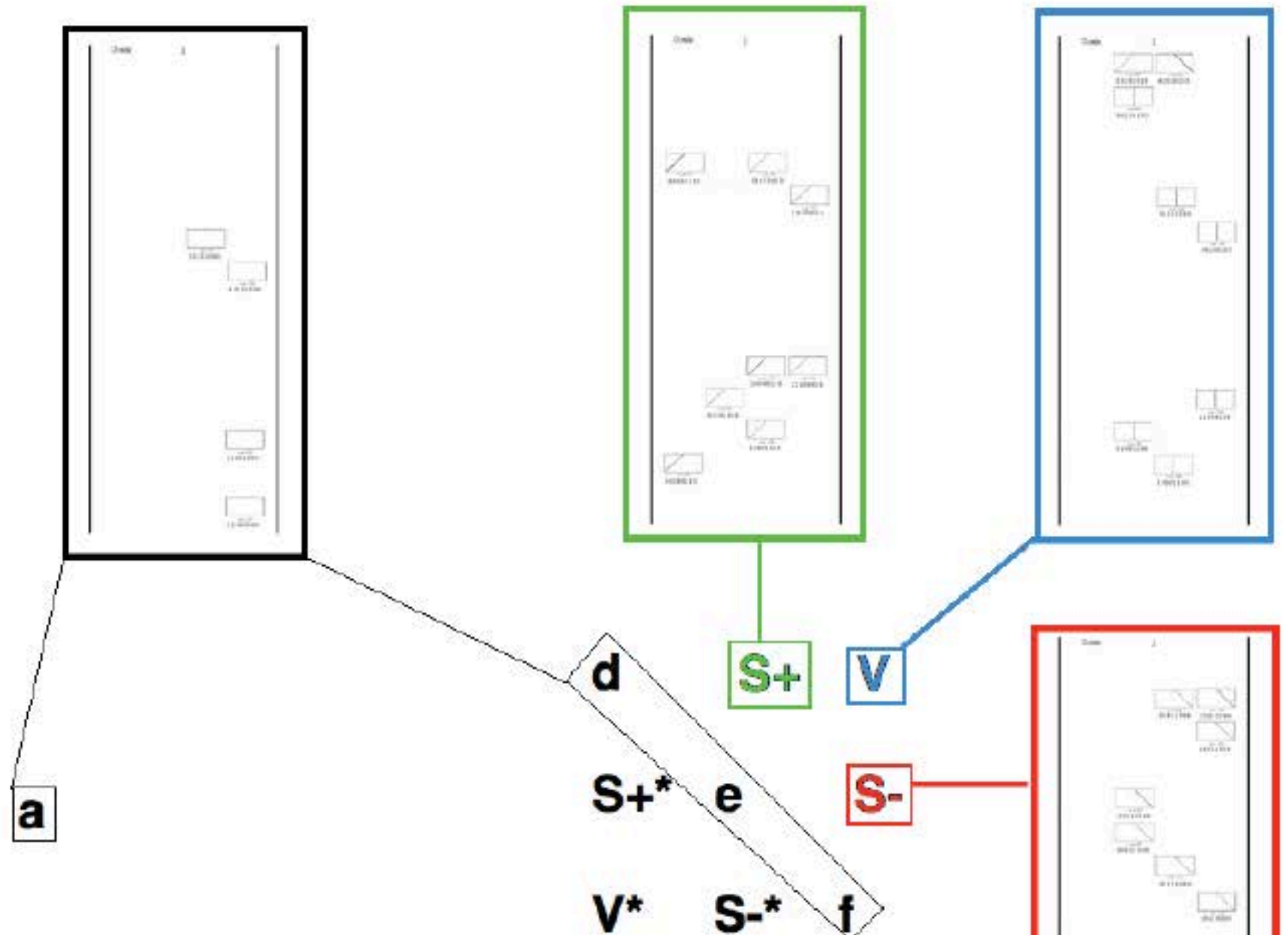

To see how  $Fr_3(O)$  gives String Theory look at one of the  $J_3(O)_o$  in  $Fr_3(O)$

	<b>d</b>	<b>S+</b>	<b>V</b>
<b>One of the two 26D traceless <math>J_3(O)_o</math> parts of <math>Fr_3(O)</math></b>	<b>S+*</b>	<b>-d-f</b>	<b>S-</b>
	<b>V*</b>	<b>S-*</b>	<b>f</b>

**S+** = 8 First-Generation Fermion Particles

**S-** = 8 First-Generation Fermion AntiParticles

**S+** and **S-** are Orbifolded in the 26D String Theory Space

leaving  $26 - 16 = 10$  dimensions of 8-dim **V** and 1-dim **d** and 1-dim **f**.

**d** and **f** act to make 10-dim **V+d+f** a Conformal Space over 8-dim **V**  
with Octonionic symmetries  $Spin(1,9) = SL_2(O)$  and  $Spin(0,8) = Spin(1,7)$   
due to the Clifford Algebra isomorphism  $Cl(0,8) = Cl(1,7) = M_{16}(R)$

Green, Schwartz, and Witten, in "Superstring Theory" vol. 1, describe 26D String Theory saying ".... The first excited level ... consists of ...

the ground state ... **tachyon** ...

and ... a scalar ... '**dilaton**' ...

and ... **SO(24)** ... **little group of a ...[26-dim]... massless particle** ...

and ... a ... **massless ... spin two state** ...".

Tachyons localized at orbifolds of fermions produce virtual clouds of particles / antiparticles that dress fermions by filling their Schwinger Source regions.

Dilatons are Goldstone bosons of spontaneously broken scale invariance that (analagous to Higgs) go from mediating a long-range scalar gravity-type force to the nonlocality of the Bohm-Sarfatti Quantum Potential.

The  $SO(24)$  little group is related to the Monster automorphism group that is the symmetry of each cell of Planck-scale local lattice structure.

**The massless spin 2 state = Bohmion = Carrier of the Bohm Force  
of the Bohm Quantum Potential.**

**Similarity of the spin 2 Bohmion to the spin 2 Graviton accounts for  
the Bohmion's ability to support Penrose Consciousness  
with Superposition Separation Energy Difference  $G m^2 / a$**

where, for a Human Brain,  $m$  = mass of electron and  $a$  = 1 nanometer in Tubulin Dimer



Andrew Gray ( quant-ph/9712037v2 ) said:

“... A new formulation of **quantum mechanics ... assign[s] ... probabilities ... to entire fine-grained histories ... [It] is fully relativistic and applicable to multi-particle systems ...[and]...**

makes the same experimental predictions as quantum field theory ...

consider space and time cut up into small volume elements

... and then take the limit as ... volume ...  $\rightarrow 0$  ...

get the final amplitude ... by considering all possible distributions at a time  $t$  earlier ...

for each such distribution the amplitude for it to occur [is] multiplied by the amplitude to

get ... the final distribution ... **the interference factor ... is a measure of how much**

**interference between the different possible histories that contain the distribution of interest there is at each time ... This result is the ...**

**Feynman amplitude squared times the product of all the interference factors ...”.**

Consider the Gray Fine-Grained History to be a World-Line String.



The Gray Fine-Grained History Quantum Theory is equivalent to

the Nambu-Goto action of 26D String Theory.

Nambu-Goto 24x24 traceless spin-2 particle

is

**Quantum Bohmion carrier of Bohm Quantum Potential**

Roderick I. Sutherland ( arXiv 1509.02442v3 ) has given a Lagrangian

for the Gray Fine-Grained Nambu-Goto Quantum Bohm Potential

that has been extended by Jack Sarfatti to include nonlinear Back-Reaction

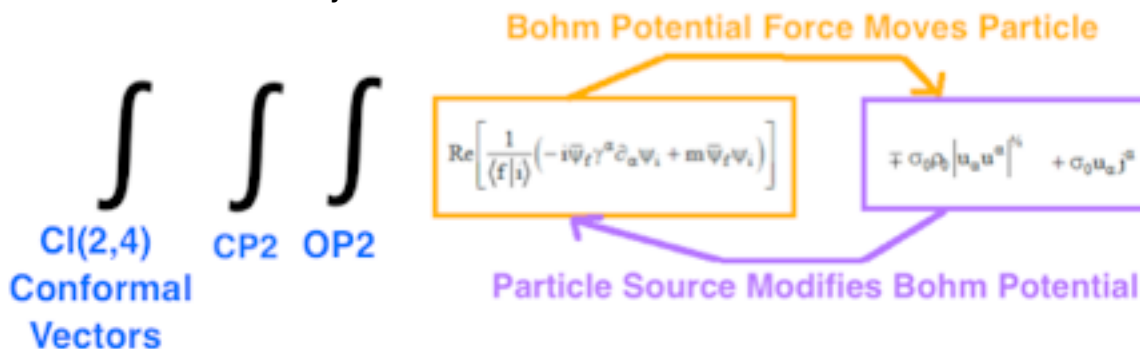

that enables Penrose-Hameroff Quantum Consciousness and Free Will, justifying Clifford's characterization of Real Clifford Algebras as

“... **mind-stuff tak[ing] the form of ... human consciousness ...”.**

**Tachyons localized at orbifolds of fermions  
produce virtual clouds of particles / antiparticles that dress fermions  
and so produce Schwinger Sources.**

**When a fermion particle/antiparticle appears in E8 spacetime it does not remain a single Planck-scale entity because Tachyons create a cloud of particles/antiparticles. The cloud is one Planck-scale Fundamental Fermion Valence Particle plus an effectively neutral cloud of particle/antiparticle pairs forming a Kerr-Newman black hole. That cloud constitutes the Schwinger Source. Its structure comes from the 24-dim Leech lattice part of the Monster Group which is**

**$2^{(1+24)}$  times the double cover of Co1, for a total order of about  $10^{26}$ .**

Since a Leech lattice is based on copies of an E8 lattice and since there are 7 distinct E8 integral domain lattices there are 7 (or 8 if you include a non-integral domain E8 lattice) distinct Leech lattices. The physical Leech lattice is a superposition of them, effectively adding a factor of 8 to the order.

The volume of the Kerr-Newman Cloud is on the order of  $10^{27}$  x Planck scale, so the Kerr-Newman Cloud Source should contain about  $10^{27}$  particle/antiparticle pairs and its size should be about  $10^{(27/3)} \times 1.6 \times 10^{(-33)}$  cm = roughly  $10^{(-24)}$  cm.

# Quantum Kernel Functions and Schwinger Source Green's Functions

Fock "Fundamental of Quantum Mechanics" (1931) showed that it requires Linear Operators "... represented by a definite integral [of a]... kernel ... function ...".

Hua "Harmonic Analysis of Functions of Several Complex Variables in the Classical Domains" (1958) showed Kernel Functions for Complex Classical Domains.

Schwinger (1951 - see Schweber, PNAS 102, 7783-7788) "... introduced a description in terms of Green's functions, what Feynman had called propagators ... The Green's functions are vacuum expectation values of time-ordered Heisenberg operators, and the field theory can be defined non-perturbatively in terms of these functions ...[which]... gave deep structural insights into QFTs; in particular ... the structure of the Green's functions when their variables are analytically continued to complex values ...".

Wolf (J. Math. Mech 14 (1965) 1033-1047) showed that the Classical Domains (complete simply connected Riemannian symmetric spaces) representing 4-dim Spacetime with Quaternionic Structure are:

$S^1 \times S^1 \times S^1 \times S^1 = 4$  copies of  $U(1)$

$S^2 \times S^2 = 2$  copies of  $SU(2)$

$CP^2 = SU(3) / SU(2) \times U(1)$

$S^4 = Spin(5) / Spin(4) =$  Euclidean version of  $Spin(2,3) / Spin(1,3)$

**Armand Wyler** (1971 - C. R. Acad. Sc. Paris, t. 271, 186-188) showed how to use **Green's Functions = Kernel Functions** of Classical Domain structures characterizing **Sources = Leptons, Quarks, and Gauge Bosons,** to calculate **Particle Masses and Force Strengths**

Cl(16) Physics constructs the **Lagrangian** integral such that the **mass m emerges as the integral over the Schwinger Source spacetime region** of its Kerr-Newman cloud of virtual particle/antiparticle pairs plus the Valence Fermion so that the volume of the Schwinger Source fermion defines its mass, which, being dressed with the particle/antiparticle pair cloud, gives **quark mass as constituent mass**.

**Armand Wyler used Harmonic Geometry to calculate:**

**Fermion masses** as a product of four factors:

$$V(Q_{\text{fermion}}) \times N(\text{Graviton}) \times N(\text{octonion}) \times \text{Sym}$$

$V(Q_{\text{fermion}})$  is the volume of the part of the half-spinor fermion particle manifold  $S^7 \times RP^1$  related to the fermion particle by photon, weak boson, or gluon interactions.

$N(\text{Graviton})$  is the number of types of Spin(0,5) graviton related to the fermion.

$N(\text{octonion})$  is an octonion number factor relating up-type quark masses to down-type quark masses in each generation.

Sym is an internal symmetry factor, relating 2nd and 3rd generation massive leptons to first generation fermions. It is not used in first-generation calculations.

**Force Strengths** are made up of two parts:

the relevant spacetime manifold of gauge group global action

the U(1) photon sees 4-dim spacetime as  $T^4 = S^1 \times S^1 \times S^1 \times S^1$

the SU(2) weak boson sees 4-dim spacetime as  $S^2 \times S^2$

the SU(3) weak boson sees 4-dim spacetime as  $CP^2$

the Spin(5) of gravity sees 4-dim spacetime as  $S^4$

and

the volume of the Shilov boundary corresponding to the symmetric space with local symmetry of the gauge boson. The nontrivial Shilov boundaries are:

for SU(2) Shilov =  $RP^1 \times S^2$

for SU(3) Shilov =  $S^5$

for Spin(5) Shilov =  $RP^1 \times S^4$

Schwinger Sources as described above are continuous manifold structures of Bounded Complex Domains and their Shilov Boundaries but the E8-Cl(16) model at the Planck Scale has spacetime condensing out of Clifford structures forming a Lorentz Leech lattice underlying 26-dim String Theory of World-Lines

with  $8 + 8 + 8 = 24$ -dim of fermion particles and antiparticles and of spacetime.

**The automorphism group of a single 26-dim String Theory cell modulo the Leech lattice is the Monster Group of order about  $8 \times 10^{53}$ .**

## Cl(1,25) Algebraic Quantum Field Theory ( AQFT )

26D String Theory has a Real Clifford Algebra Cl(1,25) constructed from

$Cl(16) = Cl(8) \times Cl(8) \rightarrow Cl(8) \times Cl(8) \times Cl(8) = Cl(24)$   
to get to the Leech Lattice 24-dim Vector Space

Conformal Structure of 2x2 matrices with entries in Cl(24)  
( Porteous, Clifford Algebras and the Classical Groups and  
Lounesto and Porteous, Lectures on Clifford (Geometric) Algebras and Applications )  
gives  $M(2, Cl(24)) = Cl(1,25)$  with Lorentz Leech Lattice Vector Space.

Since all the matrix entries are tensor product of 3 copies of Cl(0,8)  
8-Periodicity allows formation of the tensor products of copies of Cl(1,25)

$$Cl(1,25) \times \dots (N \text{ times tensor product}) \dots \times Cl(1,25)$$

For  $N = 2^8 = 256$  the copies of Cl(1,25) are on the 256 vertices  
of the 8-dim HyperCube

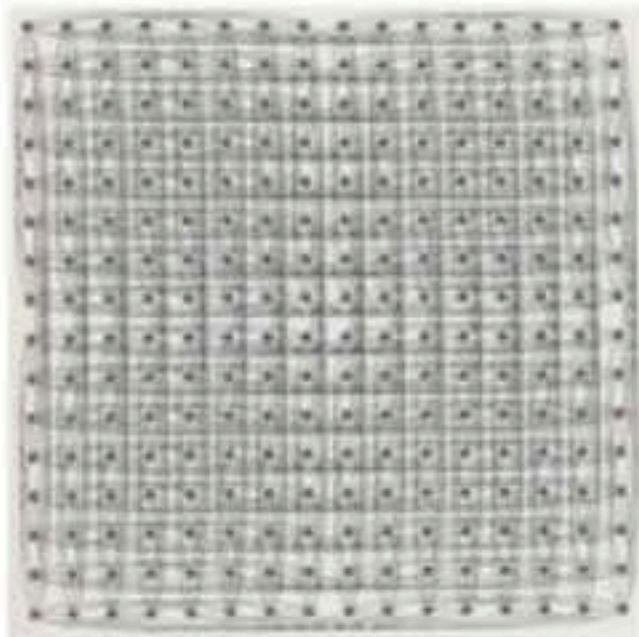

For  $N = 2^{16} = 65,536$  the copies of Cl(1,25) fill in the 8-dim HyperCube  
William Gilbert's web page says: "... The n-bit reflected binary Gray code  
will describe a path on the edges of an n-dimensional cube that can be  
used as the initial stage of a Hilbert curve that will fill an n-dim... cube. ...".

As N grows, the copies of Cl(1,25) continue to fill the 8-dim HyperCube of  
E8 SpaceTime using higher Hilbert curve stages from the 8-bit reflected  
binary Gray code subdividing the initial 8-dim HyperCube into more and  
more sub-HyperCubes.

If edges of sub-HyperCubes, equal to the distance  
between adjacent copies of Cl(1,25), remain constantly at the Planck  
Length, then the full 8-dim HyperCube of our Universe expands as N grows  
to  $2^{16}$  and beyond similarly to the way shown by this 3-HyperCube  
example for  $N = 2^3, 4^3, 8^3$  from William Gilbert's web page:

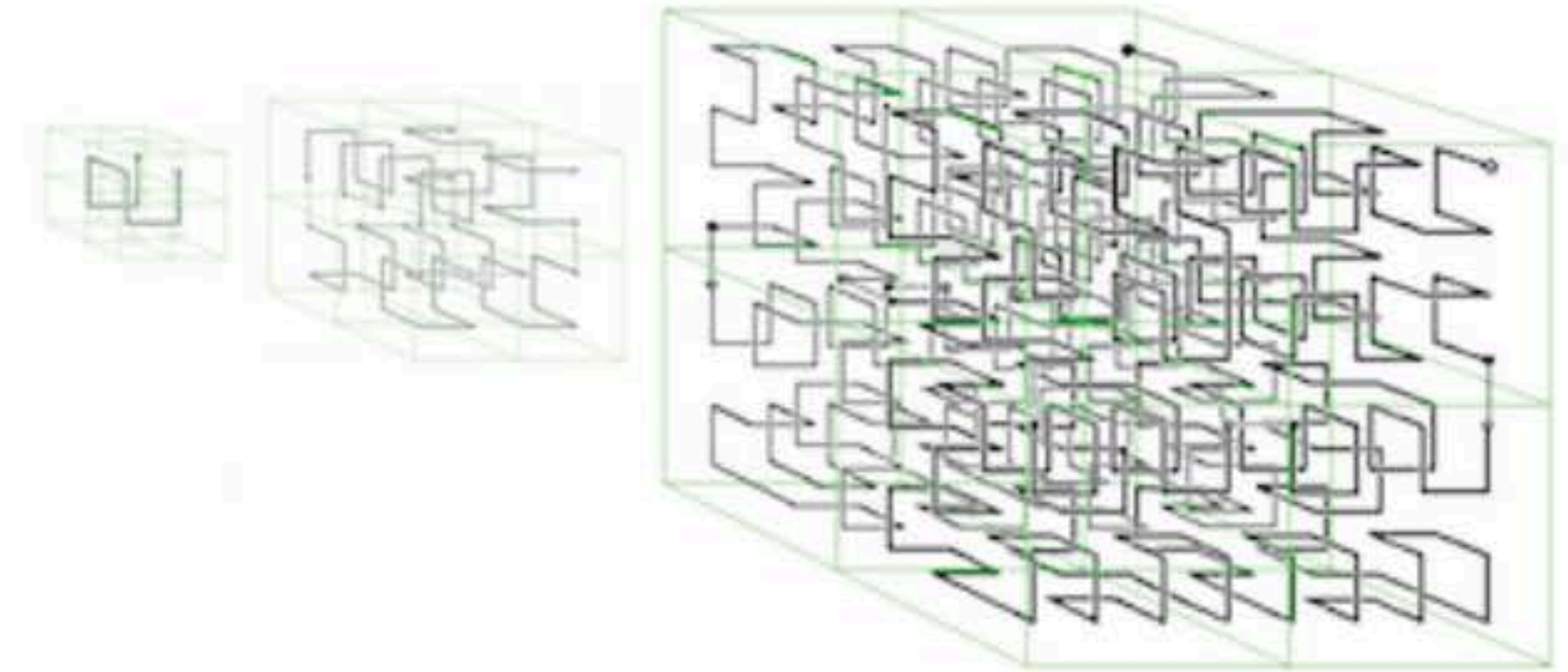

**Completion of Union of All Tensor Products of Cl(1,25) =  
= hyperfinite AQFT = Algebraic Quantum Field Theory =  
= the Third Grothendieck Universe**

The AQFT contains a copy of E8 within Cl(16) within each copy of Cl(1,25)  
**The E8 is a Recipe for a Realistic Physics Lagrangian  
so the AQFT has a natural realistic Lagrangian structure.**

The Vector Space of Cl(1,25) is the Spacetime of a 26D String Theory  
in which Strings are World-Lines of Particles  
and  
**the Massless Symmetric Spin 2 State is the Carrier  
of the Bohm Quantum Potential with Sarfatti Back-Reaction**

The Cl(1,25) AQFT being the completion of the union of all tensor products of Cl(1,25)  
it is the Real Clifford Algebra (8-Periodicity) analog  
of the completion of the union of all tensor products of the Complex Clifford Algebra  
(2-Periodicity) Cl(2;C) of 2x2 Complex Matrices = M2(C) of Spinor Fock Space that  
is the Hyperfinite II1 von Neumann factor algebra.

## Results of E8 Physics Calculations:

Here is a summary of E8 Physics model calculation results. Since ratios are calculated, values for one particle mass and one force strength are assumed. Quark masses are constituent masses. Most of the calculations are tree-level, so more detailed calculations might be even closer to observations.

Fermions as Schwinger Sources have geometry of Complex Bounded Domains with Kerr-Newman Black Hole structure size about  $10^{(-24)}$  cm.

( for calculation details see viXra 1804.0121 )

Dark Energy : Dark Matter : Ordinary Matter = 0.75 : 0.21 : 0.04

Particle/Force	Tree-Level	Higher-Order
e-neutrino	0	0 for nu_1
mu-neutrino	0	$9 \times 10^{(-3)}$ eV for nu_2
tau-neutrino	0	$5.4 \times 10^{(-2)}$ eV for nu_3
electron	0.5110 MeV	
down quark	312.8 MeV	charged pion = 139 MeV
up quark	312.8 MeV	proton = 938.25 MeV
		neutron - proton = 1.1 MeV
muon	104.8 MeV	106.2 MeV
strange quark	625 MeV	
charm quark	2090 MeV	
tauon	1.88 GeV	
beauty quark	5.63 GeV	
truth quark (low state)	130 GeV	(middle state) 174 GeV (high state) 218 GeV
W+	80.326 GeV	
W-	80.326 GeV	
W0	98.379 GeV	Z0 = 91.862 GeV
Mplanck	$1.217 \times 10^{19}$ GeV	
Higgs VEV (assumed)	252.5 GeV	
Higgs (low state)	126 GeV	(middle state) 182 GeV (high state) 239 GeV
Gravity Gg (assumed)	1	
(Gg)(Mproton <sup>2</sup> / Mplanck <sup>2</sup> )		$5 \times 10^{(-39)}$
EM fine structure	1/137.03608	
Weak Gw	0.2535	
Gw(Mproton <sup>2</sup> / (Mw+ <sup>2</sup> + Mw- <sup>2</sup> + Mz0 <sup>2</sup> ))		$1.05 \times 10^{(-5)}$
Color Force at 0.245 GeV	0.6286	0.106 at 91 GeV

Kobayashi-Maskawa parameters for W+ and W- processes are:

	d	s	b
u	0.975	0.222	0.00249 -0.00388i
c	-0.222 -0.000161i	0.974 -0.0000365i	0.0423
t	0.00698 -0.00378i	-0.0418 -0.00086i	0.999

The phase angle d13 is taken to be 1 radian.

The problem of the determination of the quark masses is not trivial. We can define as a “current” quark mass the mass entering in the Lagrangian (or Hamiltonian) representation of a hadron; this comes out to be of the order of some  $\text{MeV}/c^2$  for  $u, d$  quarks, and  $\sim 0.2 \text{ GeV}/c^2$  for  $s$  quarks. However, the strong field surrounds the quarks in such a way that they acquire a “constituent” (effective) mass including the equivalent of the color field; this comes out to be of the order of some  $300 \text{ MeV}/c^2$  for  $u, d$  quarks, and  $\sim 0.5 \text{ GeV}/c^2$  for  $s$  quarks. Current quark masses are almost the same as constituent quark mass for heavy quarks. Alessandro De Angelis · Mário Pimenta

Introduction to Particle and Astroparticle Physics Second Edition

Constituent Mass Quarks (Schwinger Sources)  
combine to form Nuclei for Atoms such as  
Deuterium and Palladium.

Wikipedia says (I added red material specifically about Pd): “...

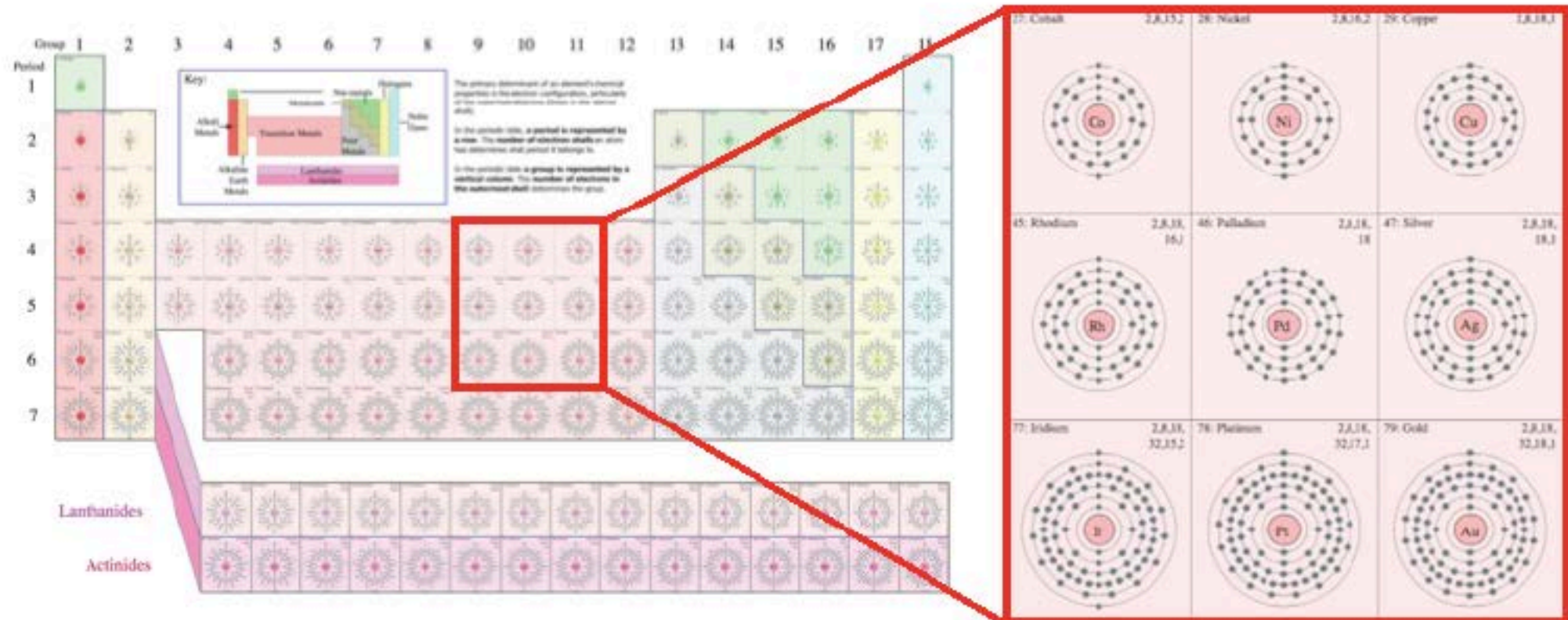

... Each s subshell holds at most 2 electrons Each p subshell holds at most 6 electrons  
 Each d subshell holds at most 10 electrons Each f subshell holds at most 14 electrons  
 Each g subshell holds at most 18 electrons ...

Shell name	Subshell name	Subshell max electrons	Shell max electrons
K	1s	2	2
L	2s	2	2 + 6 = 8
	2p	6	
M	3s	2	2 + 6 + 10 = 18
	3p	6	
	3d	10	
N	4s	2	2 + 6 + 10 + 14 = 32
	4p	6	
	4d	10	
	4f	14	

## Palladium

2

$2+6 = 8$

$2+6+10 = 18$

$2+6+10 = 18$

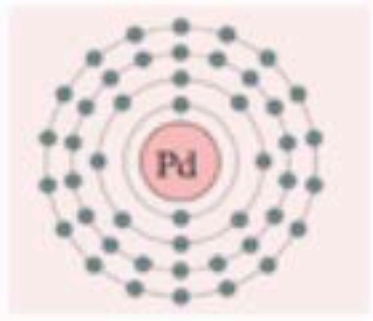

... palladium (atomic number 46) has no electrons in the fifth shell, unlike other atoms ...[in its periodic table neighborhood]...” .



A full N-shell has  $s + p + d + f = 2 + 6 + 10 + 14 = 32$  electrons.

Palladium N-shell has  $2 + 6 + 10 = 18$  electrons and “holes” to receive 14 electrons:

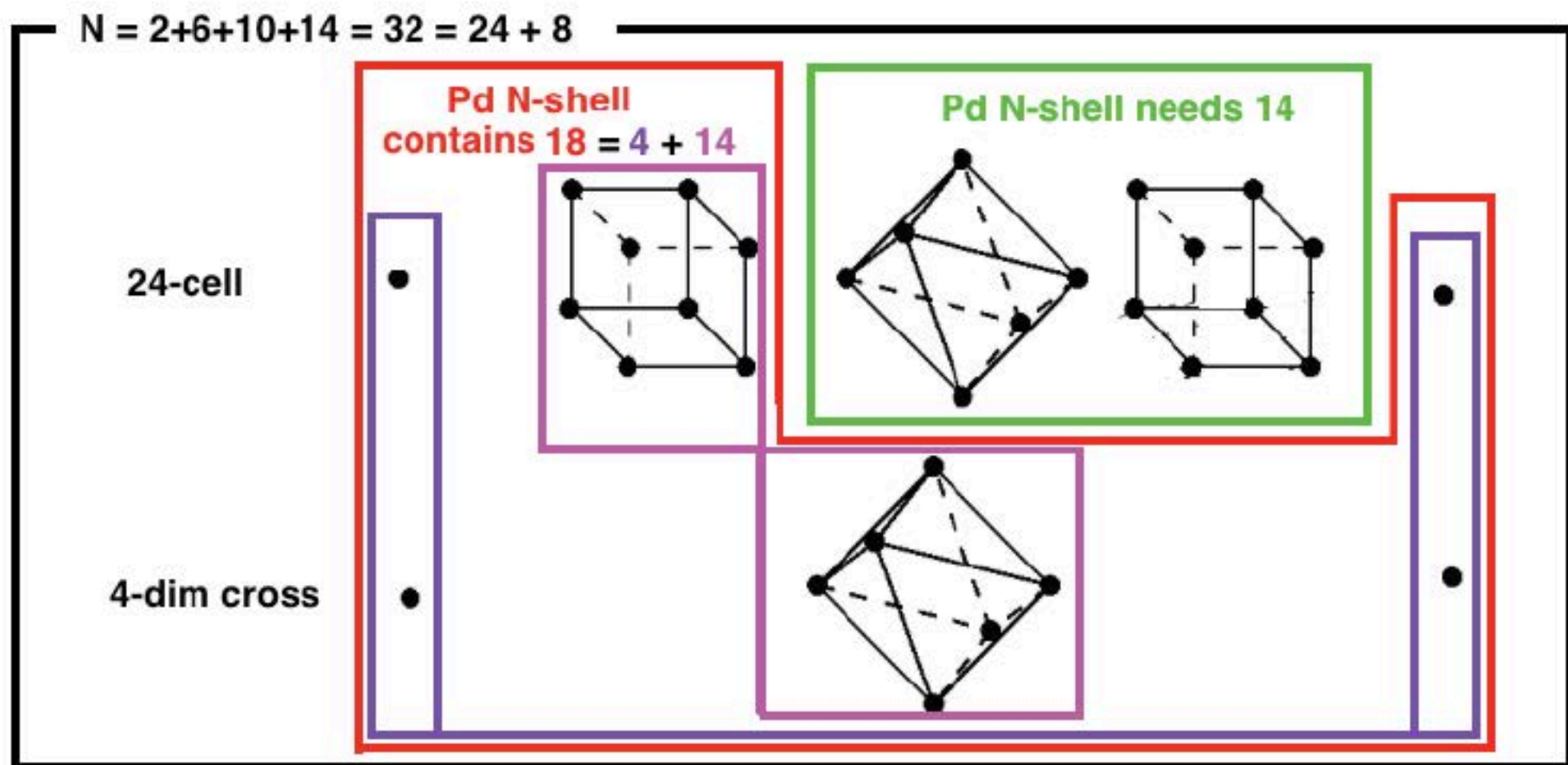

Each Palladium atom has  $18-14 = 4$  N-shell electrons that can interact with 4 electrons of 4 Deuterium atoms absorbed into a Pd cluster, helping them to participate in a Schwinger coherent quantum state for TSC Fusion.

Further, each Palladium atom has 14 N-shell electrons  
12 to fill needs of other Pd atoms  
and 2 for a Dirac Fermion Band for Klein Paradox Tunnelling.

# What is the structure of the icosahedral 147-atom Pd cluster ?

The icosahedral 147-atom ground state has 12 exterior icosahedra and a central icosahedron with 12 interior vertices which are the innermost vertices of 12 exterior TSC Fusion site icosahedra:

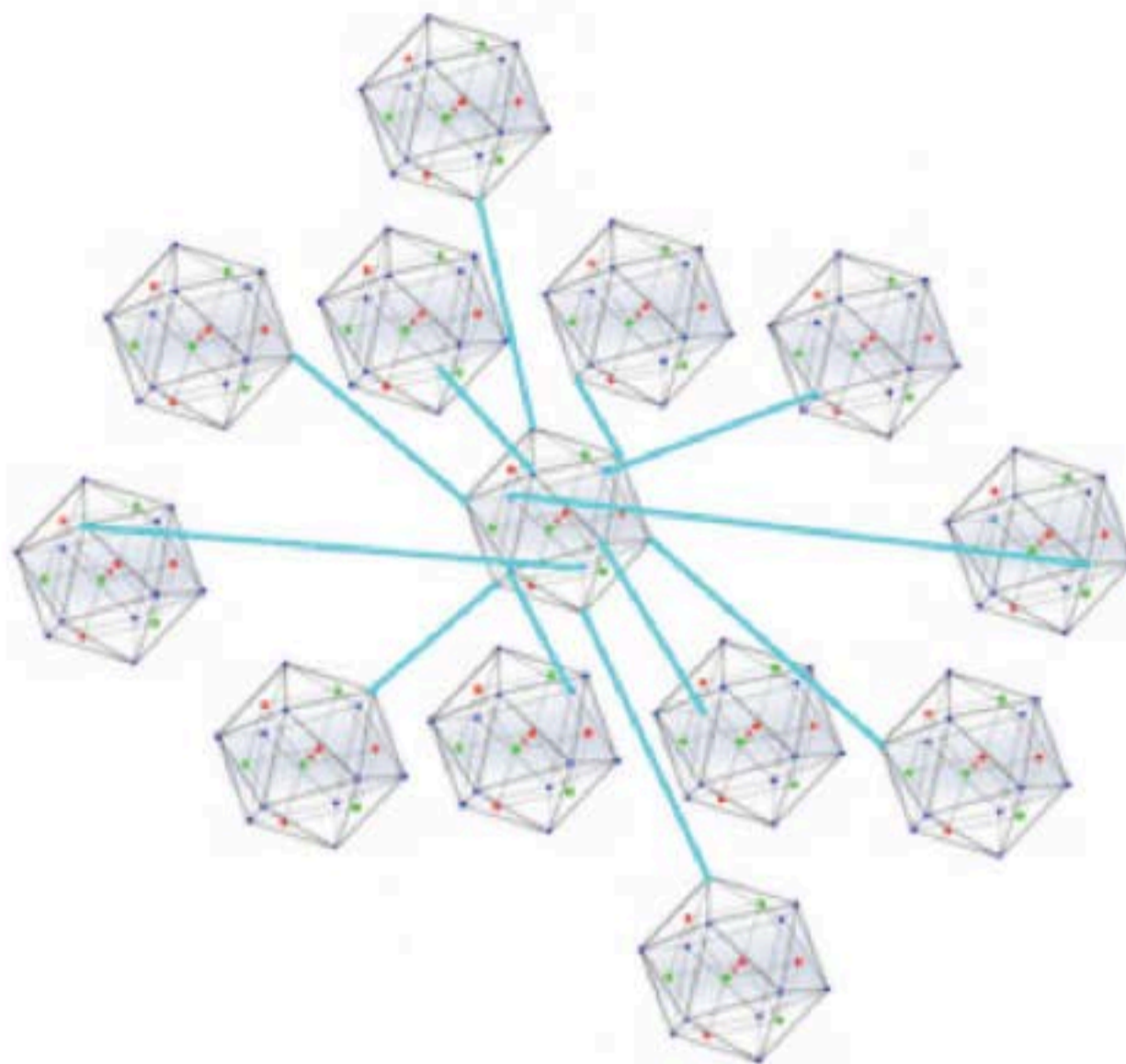

The 12 exterior icosahedra each have outer faces on the outer boundary of the 147-atom cluster.

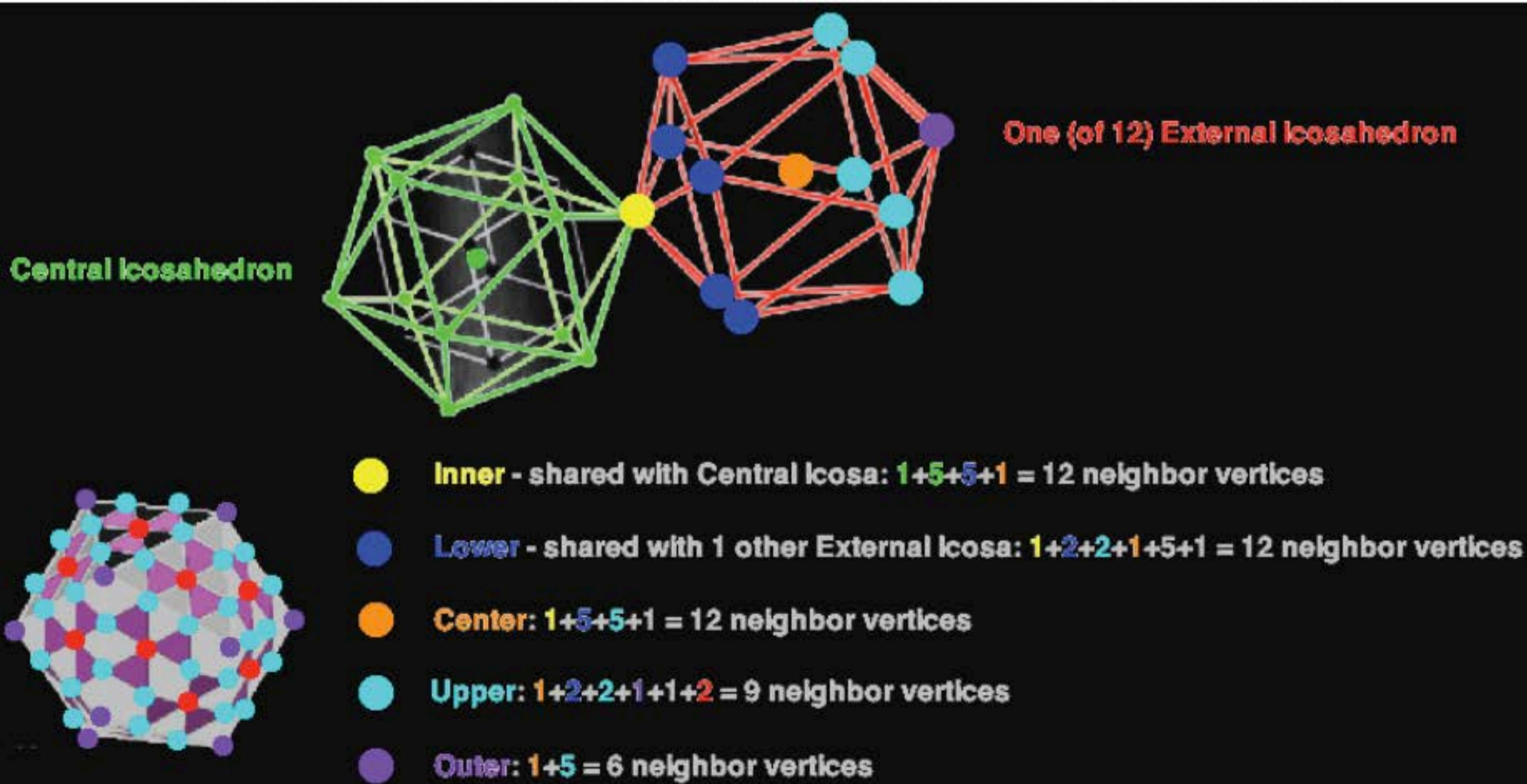

## In TSC Icosahedra of a Pd cluster 4 D (D+D+D+D) form a Schwinger Coherent Quantum State

From a classical approximation point of view there are  $12+1 = 13$  Pd nuclei (blue) within which there is a 2-tetrahedral configuration of 4 D nuclei (red) and 4 D electrons (green)

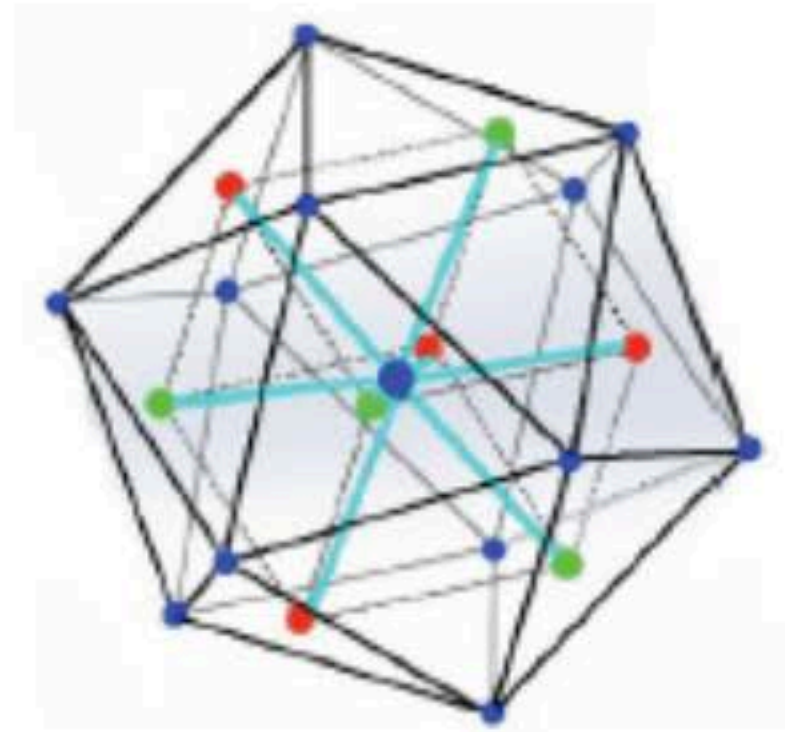

In the Schwinger coherent quantum state (yellow) the 4 D nuclei and 4 D electrons are smeared out all over the interior of the icosahedral TSC cell

and

the 4 D electrons screen out the positive charge of the 4 D nuclei making the Schwinger coherent quantum cloud effectively neutral with no Coulomb repulsion or attraction.

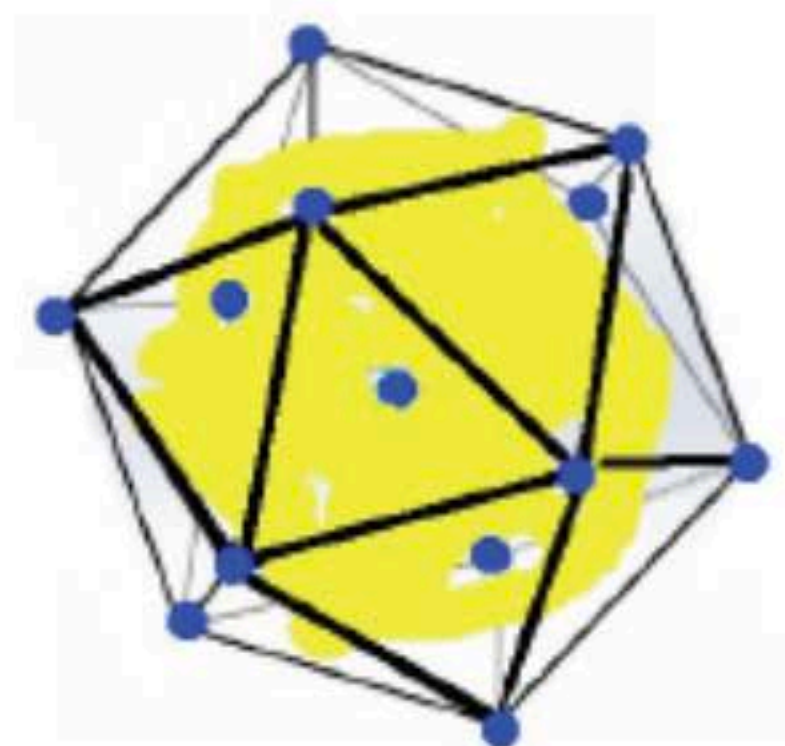

**The process of forming the Schwinger State which collapses to the central Pd atom where Deuterium nuclei undergo Cold Fusion is called by Akito Takahashi Tetrahedral Symmetric Condensation (TSC).**

**The D Schwinger State nuclei go to the central Pd atom  
and by Klein Paradox Tunnelling 4 D nuclei undergo TSC Cold Fusion  
producing  $4\text{He} + 4\text{He} + 47.6 \text{ MeV}$**

Now look at the central Pd atom in the TSC cell.

Its outer electron shell of 18 electrons has 4 free electrons

(14 of them being bound to the outer 12 Pd atoms plus 2 forming a Dirac Fermion Band)

which 4 free electrons pull the 4 D nuclei out of the Schwinger quantum cloud  
into the Central Pd Atom

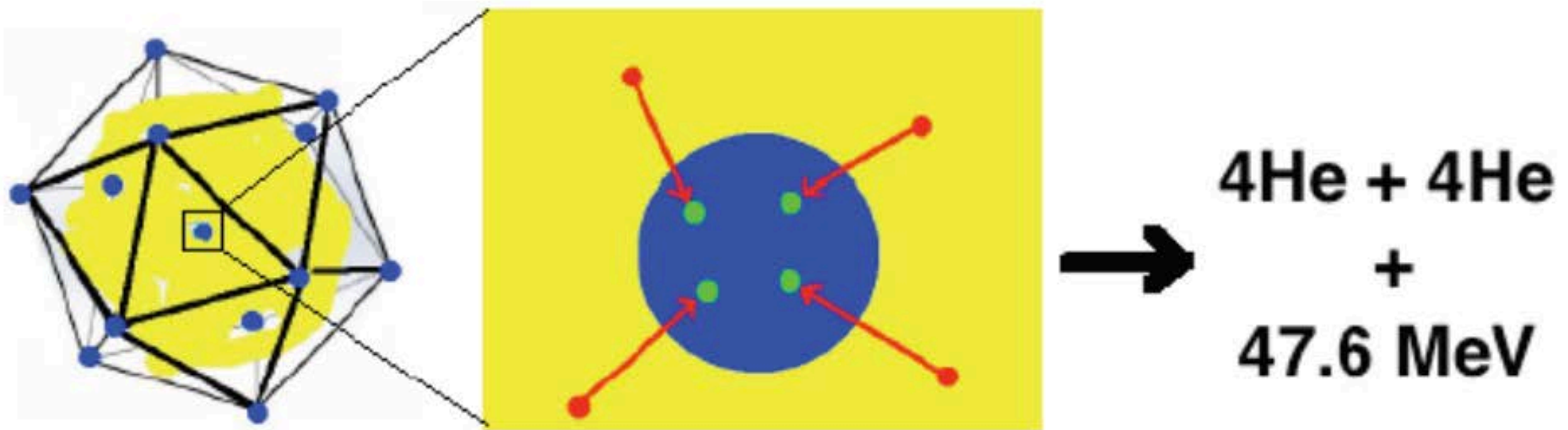

When the 4 D nuclei get into the small volume of the Central Pd Atom  
they “see” each other as repulsive like electrical charges  
resulting in a very high Coulomb barrier between them

but

that is when the Dirac Fermion Band takes effect  
and gets them to rapidly penetrate the barrier by Klein Paradox Tunnelling

Some of the TSC Fusion Energy goes to a Jitterbug transformation

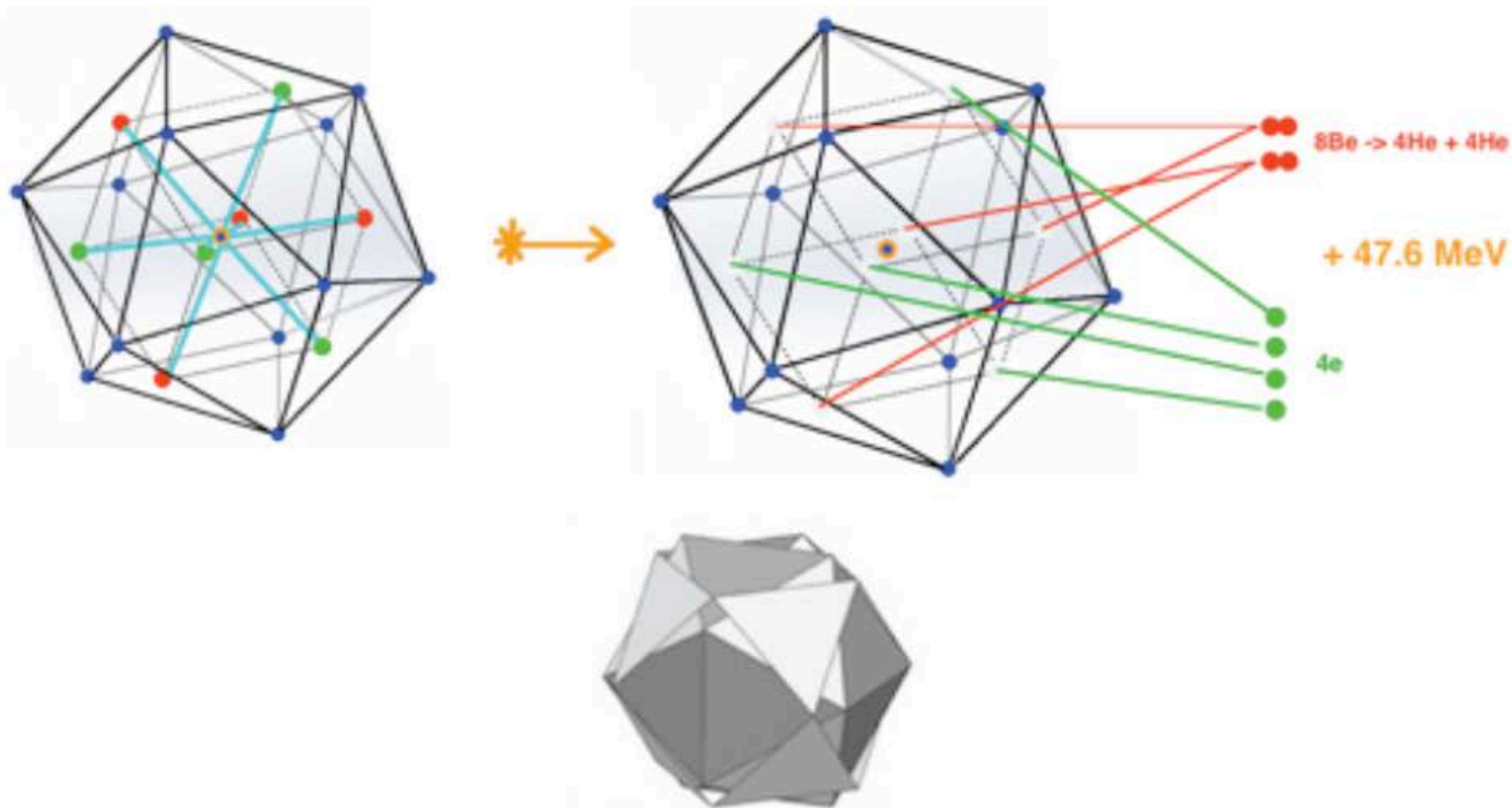

of the icosahedral Palladium, depleted of Deuterium fusion fuel, to a cuboctahedral configuration

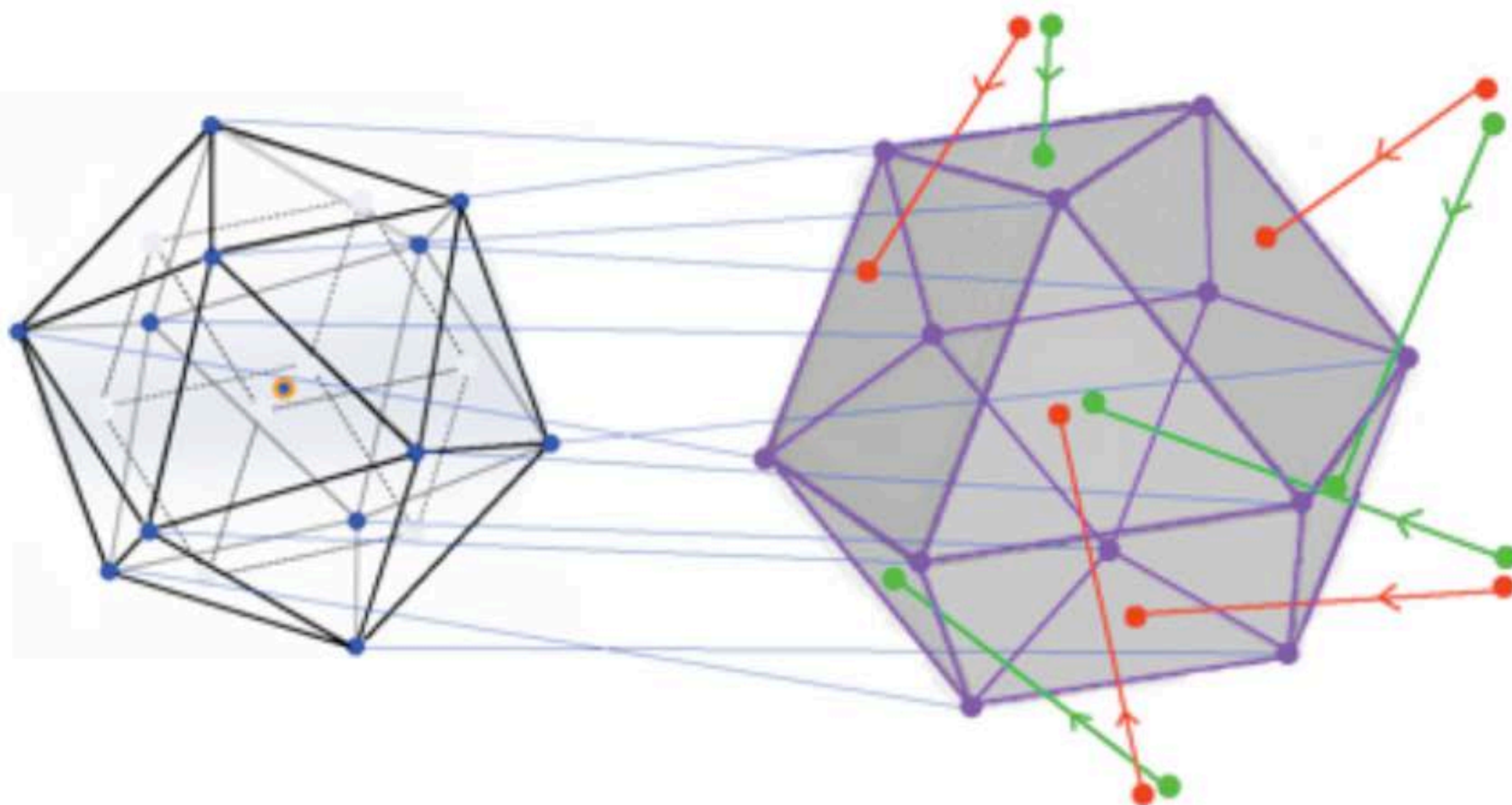

which has 6 large square openings through which the  $4\text{He}$  TSC Fusion Product Ash can leave the Pd cluster and ambient Deuterium Fuel can enter to reload the Palladium cluster.

Then, since the icosahedral configuration is the Palladium cluster ground state, another Jitterbug transformation

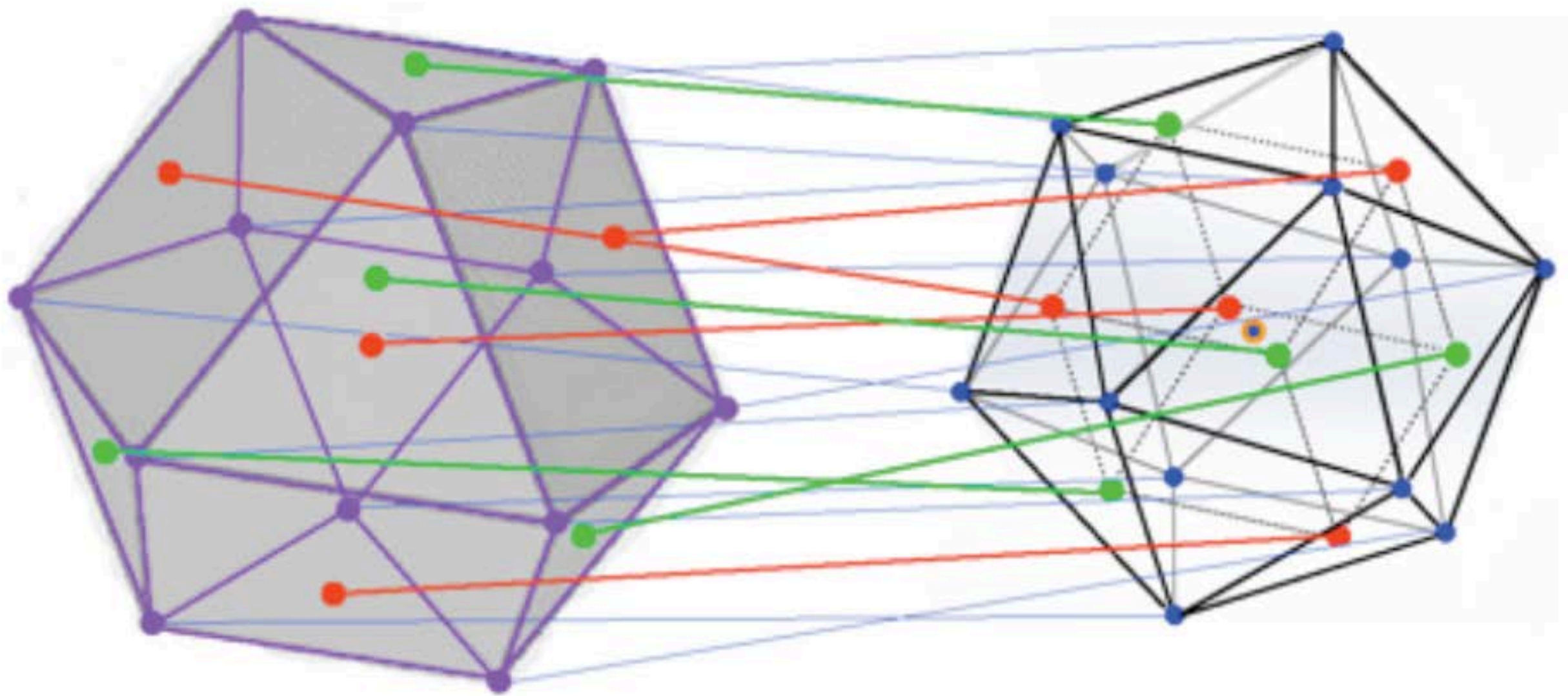

takes the Palladium cluster to an icosahedral configuration with the replenished Deuterium nuclei and electrons ready for another round of TSC fusion

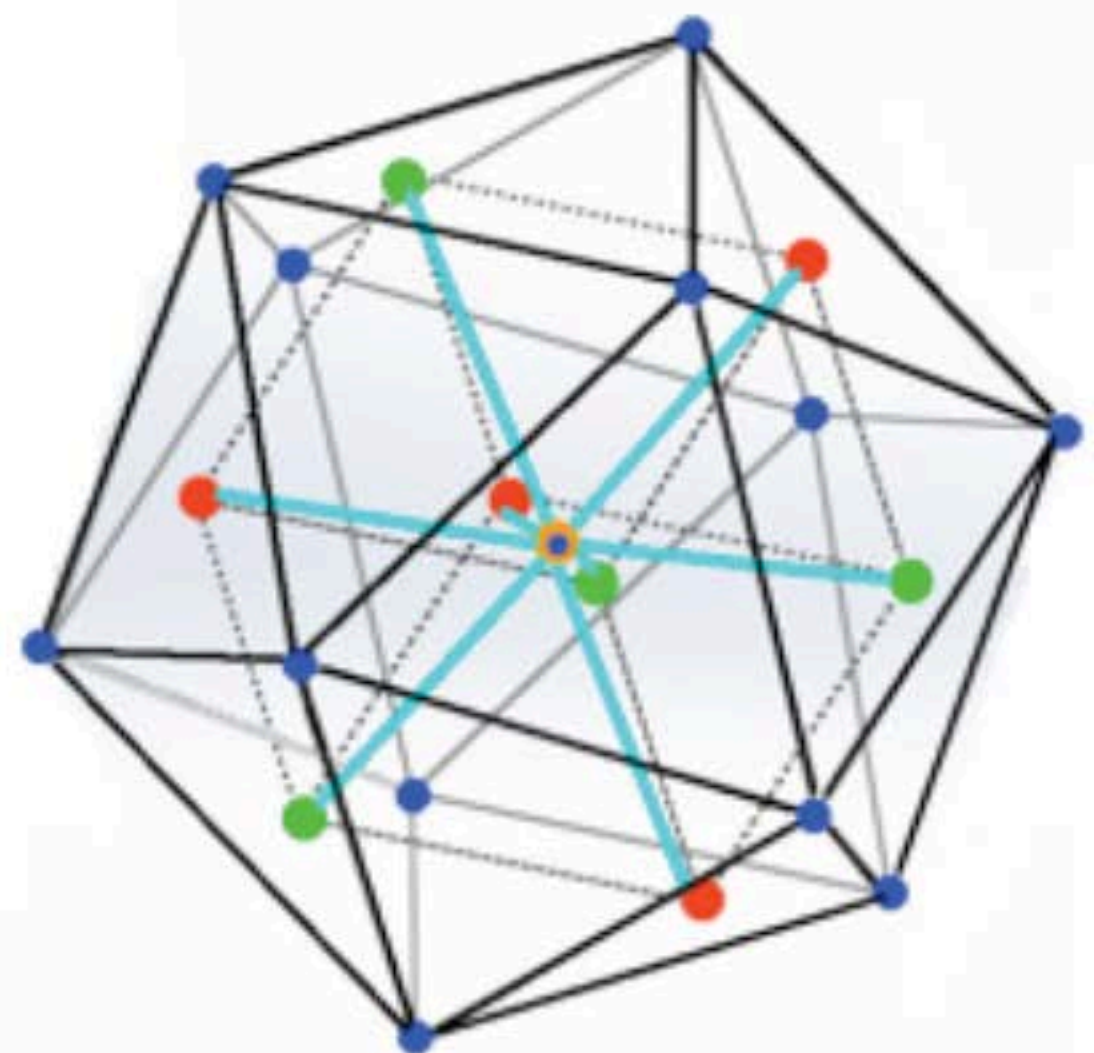
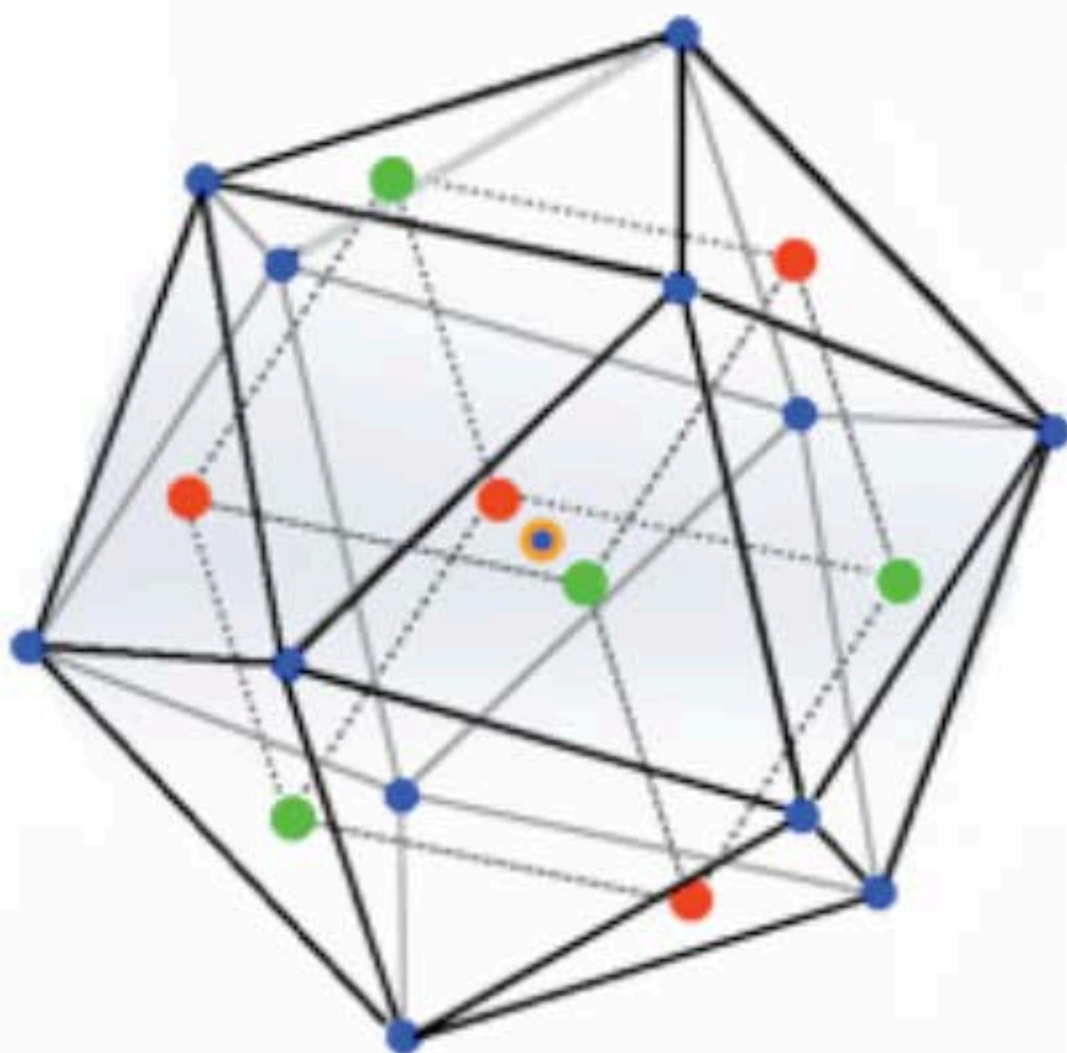

Deuterium Gas

D2O HEAVY WATER

TSC~Jitterbug Fusion  
Reaction Chamber 1

Heat / Cooling Chamber 2

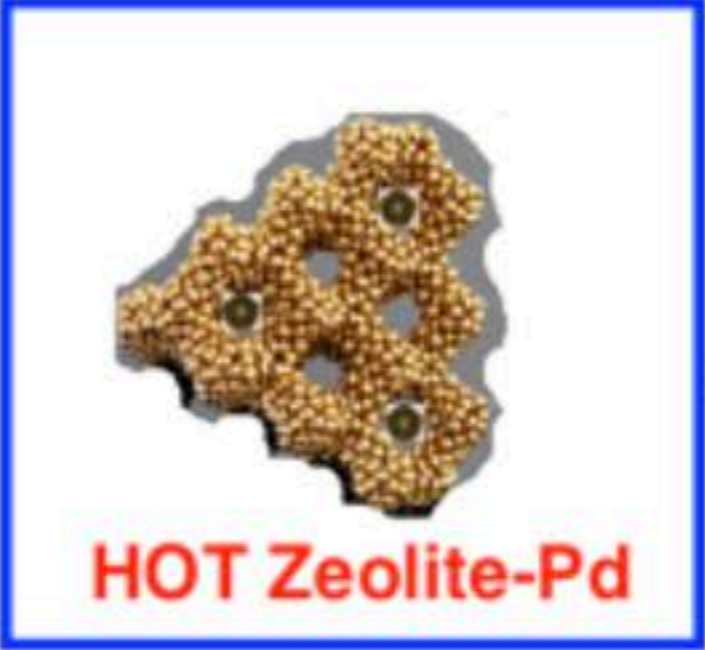
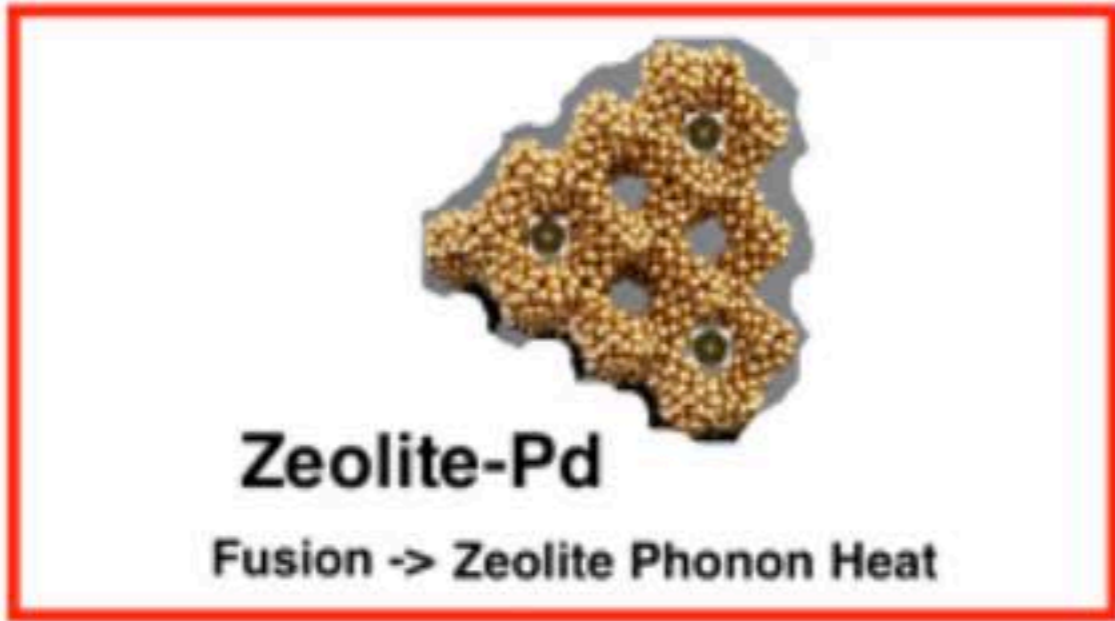

D2O STEAM

Recycle back to Chamber 1

Cooled Dried Zeolite-Pd

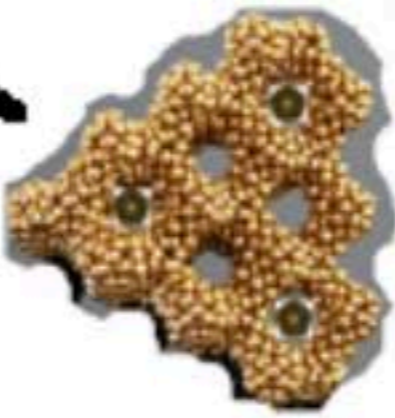

As more layers are added, the deformations of tetrahedra and octahedra accumulate and eventually destabilize the structures necessary for Jitterbug and TSC Fusion. The next Mackay cluster beyond 147 atoms has  $147+162 = 309$  atoms.

Barretau, Desjonqueres, and Spanjaard in Eur. Phys. J. D. 11 (2000) 395-402 say:

“... the icosahedron is the preferred structure at small sizes, and the critical size at which the relative stability becomes favorable to cuboctahedrons is  $N = 561$  for PdN clusters ...[for which]... For  $N = 13$  the cuboctahedron is ... unstable.

For  $N = 55, 147,$  and  $309$  atoms the cuboctahedron is metastable and slightly distorted. Its transformation to a perfect icosahedral structure needs an activation energy of  $12$  meV for  $N = 55,$   $28$  meV for  $N = 147$  and  $45$  meV for  $N = 309.$  The activation energies involved in the inverse transformation are  $61$  meV for  $N = 55,$   $51$  meV for  $N = 147$  and  $48$  meV for  $N = 309.$  ...[ compare  $47.6$  MeV for each TSC Fusion event ]...

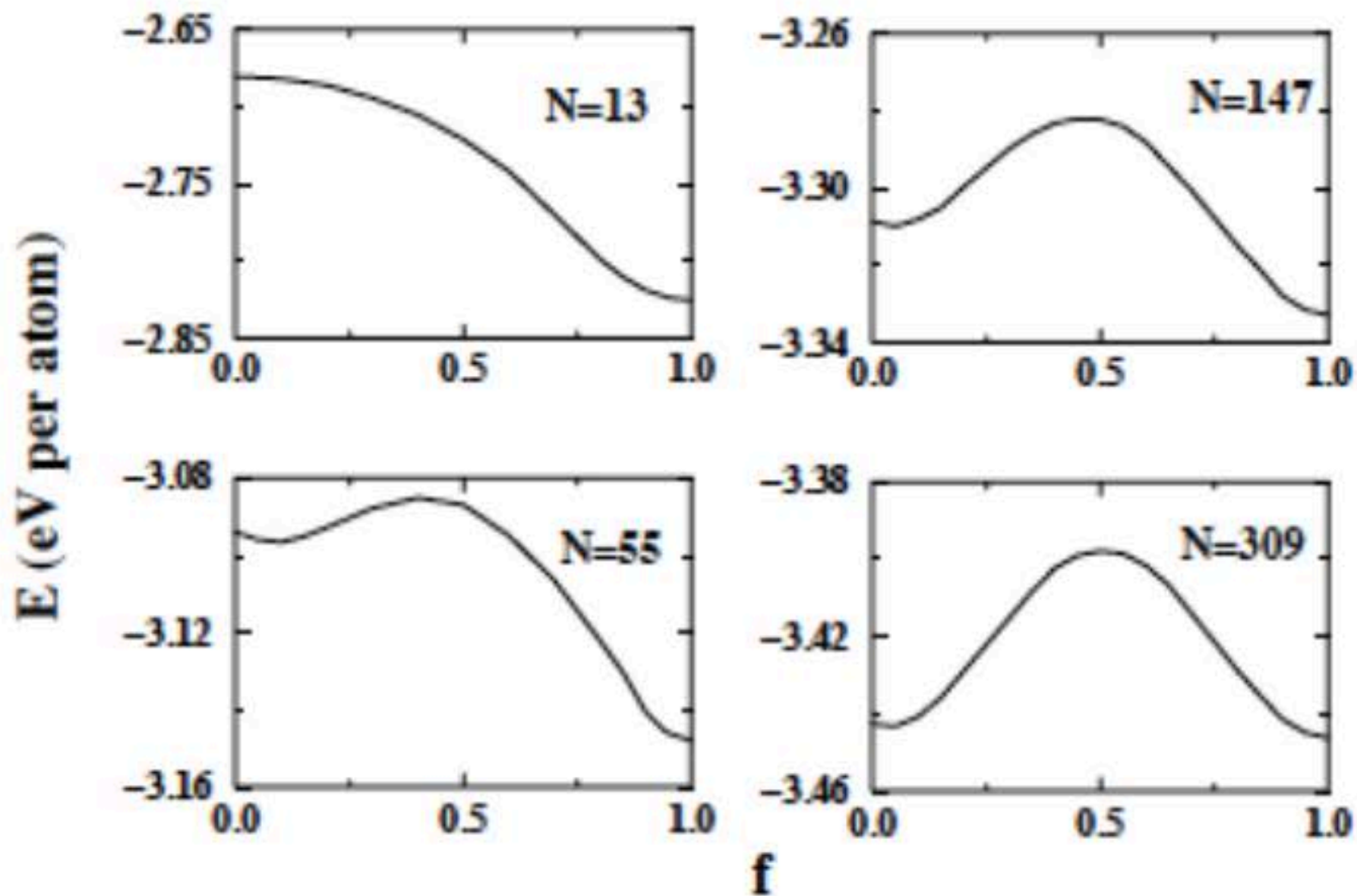

... The evolution of the potential energy profile of homogeneously relaxed ... PdN clusters during the Mackay [Jitterbug] transformation for increasing values of  $N.$   $f$  is a fraction of the displacements ...  $f = 0$  and  $1$  correspond to the ... cuboctahedron and icosahedron, respectively ...”.

$N = 309$  is disfavored for TSC-Jitterbug Fusion with respect to  $N = 147$  for two reasons:  
 energy levels are too close for rapid Jitterbug cubocta to icosah transition

$N = 309$  Pd Cluster is too large (2 nm) to fit  
 through 1.5 nm expanded Sodium Zeolite Y pore

so

**147 atoms is optimal for Pd cluster Cold Fusion**



**I would like to see experiments  
with Zeolite directly using Sandia 1.5 nm Palladium NanoClusters.**

**If there is difficulty with getting the Sandia Clusters  
to fit into the Sodium Zeolite Y  
then  
I would like to see experiments  
with Zeolite ITQ-37**

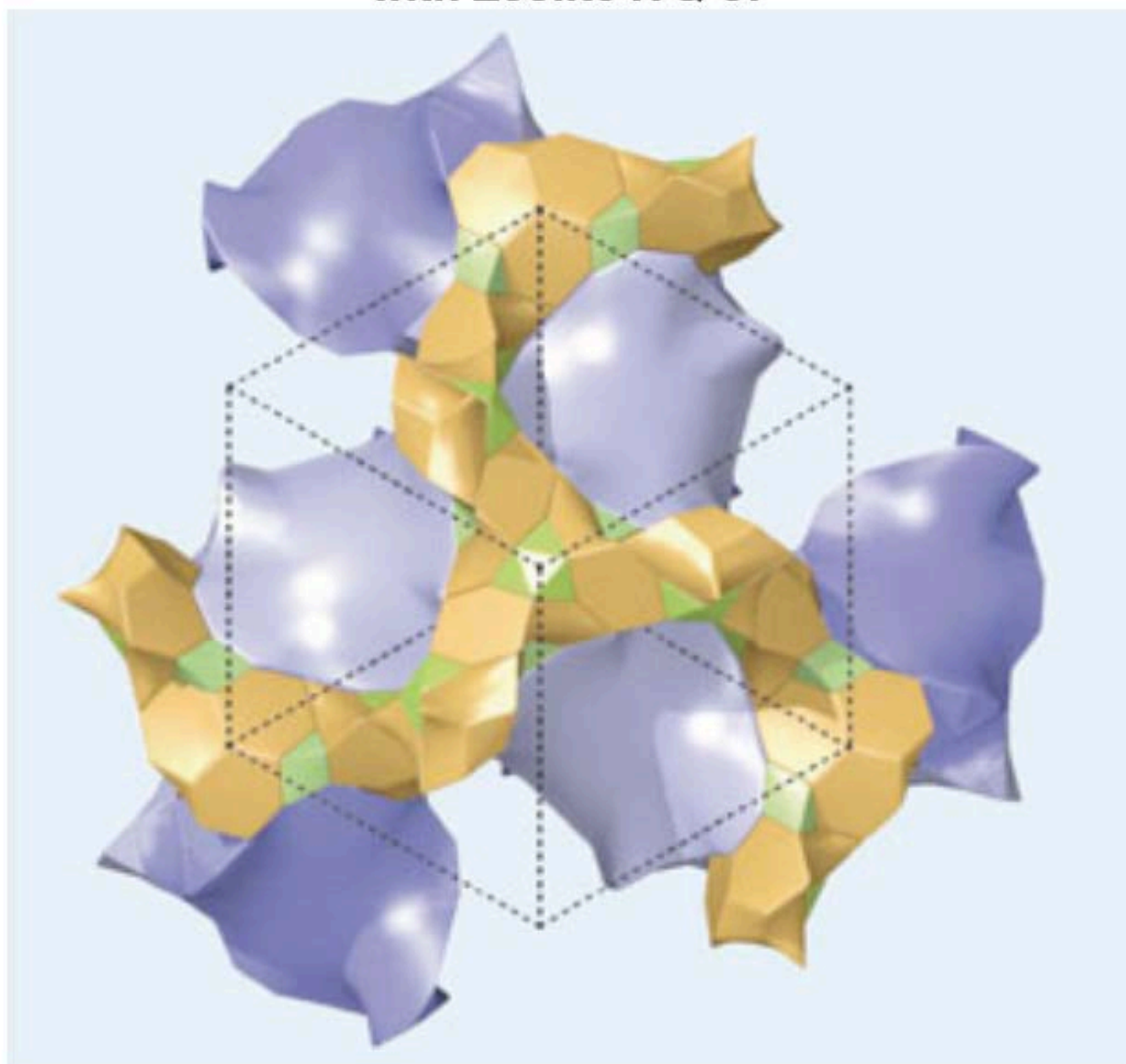

**which has pore size about 2 nanometers.**

(Royal Society of Chemistry, 29 April 2009 and Sun et al, Nature 2009)

Julian Schwinger in 1990 lecture at Universite de Bourgogne said:

**“... in the very low energy cold fusion, one deals essentially with a single state, described by a single wave function, all parts of which are coherent ...”.**

**Akito Takahashi proposed a process Tetrahedral Symmetric Condensation (TSC) that for 4 Deuterons (D) in an icosahedral cluster of Palladium (Pd) atoms produces a Schwinger coherent quantum state**

**that effectively distributes the electron population among deuterons** so that the Coulomb barrier is eliminated and the four Deuterium (D) nuclei can simultaneously interact and fuse, forming two  $4\text{He}$  nuclei plus 47.6 MeV energy.

Peter Hagelstein used phonon models for Relativistic Coupling Between Lattice Vibrations and Nuclear Excitation, enabled by break-down of Foldy-Wouthuysen transformation due to 8-15 THz Lattice Vibration Modes, to show direct transfer of the 47.6 MeV energy of Cold Fusion to the Pd lattice as excited optical phonon modes.

**The only Cold Fusion experiments producing heat consistently and reproducibly are the detections of heat using Pd Clusters and Deuterium gas**

**by Arata and Zhang ( replicated by McKubre at SRI ) and by Iraj Parchamazad.**

Arata and Zhang ( and SRI ) used Palladium black with initial cluster sizes distributed around 5 nm so that a substantial number of Pd clusters had diameter 1.5 nm.

However, clumping increased the cluster size to around 40 nm at which size Takahashi et al said, based on their similar work, the “heat-power level drop[ped]... drastically”.

( see Current Science 108 (25 Feb 2015) LENR Special Section Preface )

Iraj Parchamazad and Melvin Miles avoided the clumping problem by growing the Pd clusters within Zeolite cavities. Using Sodium Zeolite Y whose cavity size is around 1.2 nm ( but capable of expansion by about a factor of 2 ), they produced Pd clusters of 1.5 nm size size which were dispersed within the Zeolite cavities thus preventing clumping. Upon exposure of his Pd clusters in Zeolite to Deuterium gas, he produced heat in 10 out of 10 experiments with

**Cold Fusion Energy on the scale of kiloWatts per milligram of Palladium.**

( see [coldfusionnow.org/iraj-parchamazad-lenr-with-zeolites/](http://coldfusionnow.org/iraj-parchamazad-lenr-with-zeolites/) )

For Everybody on Earth to be Happy, the Abundant Cheap Energy must provide a high Standard of Living (current USA standard) for a lot of people (10 billion), and:

last for a long time (more than decades) - rules out Oil, Gas, Methane, and Coal;

have no serious radioactive waste - rules out Uranium, Thorium, and Tritium (Lithium);

have realistically scalable capital cost - rules out Solar which would require Satellite collectors with area 1% of  $\pi \times 6,000^2 = 1,000,000 \text{ km}^2 = (1,000 \text{ km})^2$  or cloud-free collectors on Earth surface with the same area. Less than 100% efficiency would require correspondingly larger area of collectors.

**That leaves one possible source of Abundant Cheap Energy for 10 billion people:**

	<b>Reserves (Terawatt-years)</b>	<b>Duration (years)</b>
<b>Deuterium</b>	<b><math>1.9 \times 10^9</math> (1/1000 of ocean supply)</b>	<b>2,000,000</b>

**Energy is only necessary, but not sufficient,  
for 10 billion humans to be happy in a harmonious society.**  
Humanity also needs (image from Doonesbury)

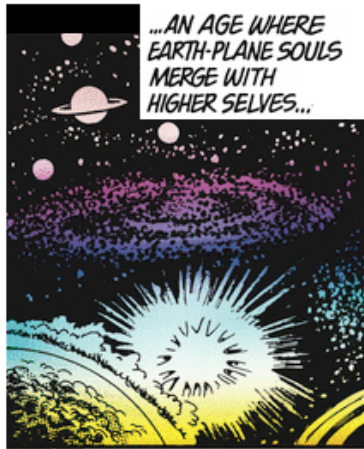

and  
to  
avoid



Nuclear Annihilation could occur if USA or Russia or China decided that a First Strike were in their best interest because the Other seemed to be preparing for Nuclear War and that Nuclear War could be survivable due to First Strike Suppression of Retaliation and historical facts such as Hiroshima has rebuilt, Nagasaki had no Firestorm, and the Kuwaiti Firestorm did not cause a Nuclear Winter. It could be avoided if **USA and Russia and China agreed to share Power over Earth just as Spain and Portugal did in 1494 in the Treaty of Tordesillas.**

“... Rudolf Steiner (1861-1925) ... was the founder of Anthroposophy, a philosophy and spiritual movement whose aim ... is to develop supersensible capacities that enable access to what Steiner described as a spiritual dimension underlying all of life ...  
“**Geisteswissenschaft**” ... **is the re-awakening of a spiritual awareness ...**”  
( Jennie Louise Cain - 2016 U. Michigan Ph.D. thesis )

Rudolf Steiner, in Cosmic Memory, said “... The Fourfold Man ... consists of ... the **physical** body, the **ether** ... body, the **astral** body and the “ I “ ...”.

In my view - see <http://vixra.org/pdf/1810.0365v2> -

Spirit World = Complex Domain Lie Ball  
Physical World = Shilov Boundary Lie Sphere

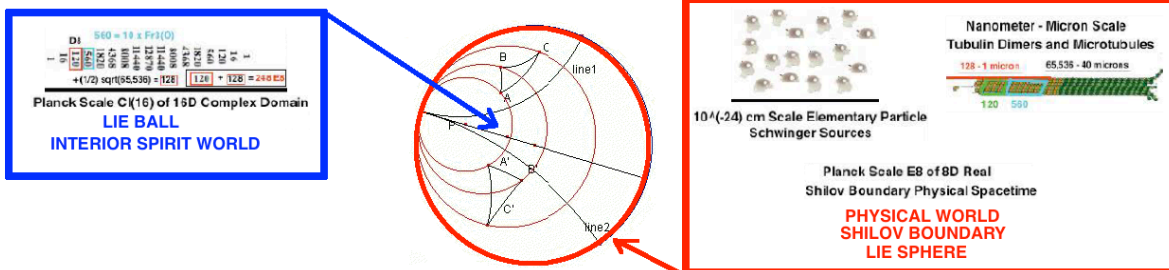

are related by Poisson Kernel and Bergman Kernel = Green's Function Propagator

**Physical Body** is constructed of 40-micron Microtubules = 65,536 Tubulin Dimers  
**Ether Body** is Quantum Consciousness Information = 64,712 elements per Microtubule

**Astral Body** is 26D World-Line Theory Lattice Cell with 65,536-dim Cl(16) Symmetry  
 “ I “ is Cl(16) Clifford Algebra Information = 64,712 elements per Lattice Cell

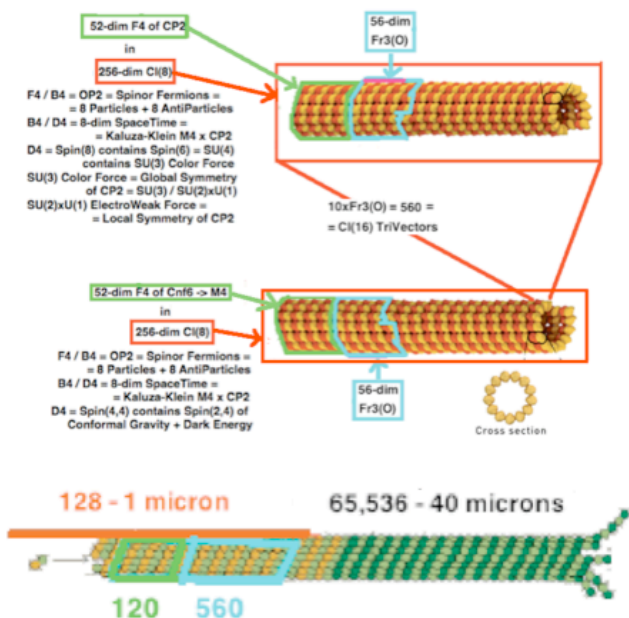

Human Brain Microtubules 40 microns = 65,536 Tubulin Dimers

**Physical Body** contains Information

- Cl(16) = 65,536
- 16 Vector Complex Domain
- 128 half-Spinor part of E8
- 120 BiVector part of E8
- 560 TriVector Fr3(O)
- = 64,712 Ethereal Information

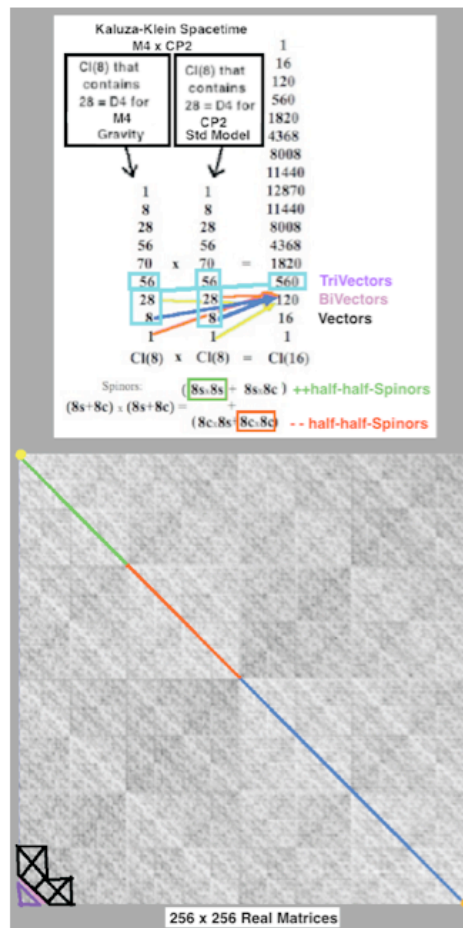

**Astral Body** contains Information

Cl(16) = 65,536 - 16 - 128 - 120 - 560 =  
 = 64,712 Spirit Information

“... Steiner ... regards ...the ancient Egyptians ... as oriented toward connection and interaction with the outer world, and ... the greater astronomical cosmos ... the age of the Egyptian pyramids [was] the time of development of the “Empfindungsseele” ... the ability to experience the outer world internally ...”.

( Jennie Louise Cain - 2016 U. Michigan Ph.D. thesis )

**36,000 Years Ago - National Geographic Genographic YDNA -  
M168 - YAP - M96 - M35 Humans follow North Star Vega  
up the Nile to Giza and Mediterranean**

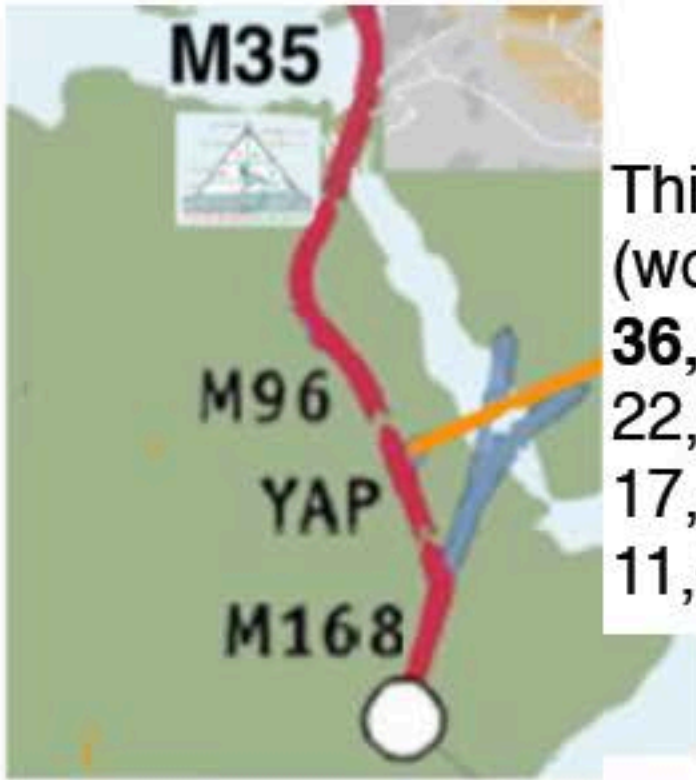

This coincided with the beginning of Egyptian History according to Manetho (working under Alexander's General and successor Ptolemy I):

**36,525 years ago - Rule of Gods - North Star Vega - Geminga Shock - Glaciation**

**22,625 years ago - Rule of Demigods - last Glacial Maximum**

**17,413 years ago - Rule of Spirits of the Dead - end of last Glacial Maximum**

**11,600 years ago - Rule of Mortal Humans - North Star Vega - Vela X - end of Ice Age**

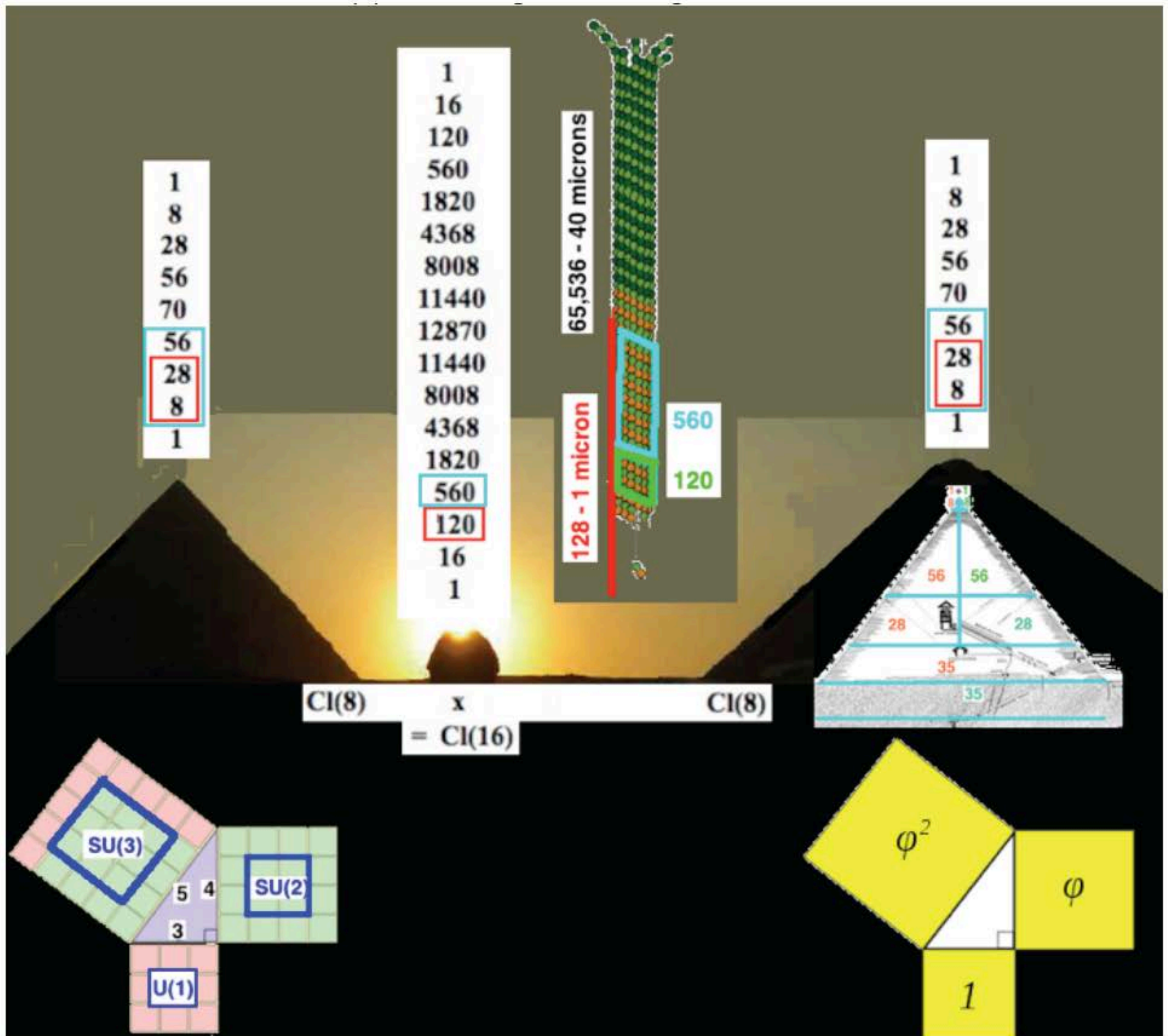

The Sphinx represents 65,536-dim  $Cl(16)$  containing 248-dim  $E_8$  as tensor product of 256-dim  $Cl(8)$  containing 52-dim  $F_4_{sm}$  of  $CP^2$  and 256-dim  $Cl(8)$  containing 52-dim  $F_4_{gde}$  of  $M_4$  of  $M_4 \times CP^2$

Clifford Algebras were not known to European mathematicians until Clifford in the 19th century and not known to European physicists until Dirac in the 20th century but it seems to me that their structure was known to Africans in ancient times. The courses of the Great Pyramid of Giza correspond to the graded structure of 256-dim  $Cl(8)$ :

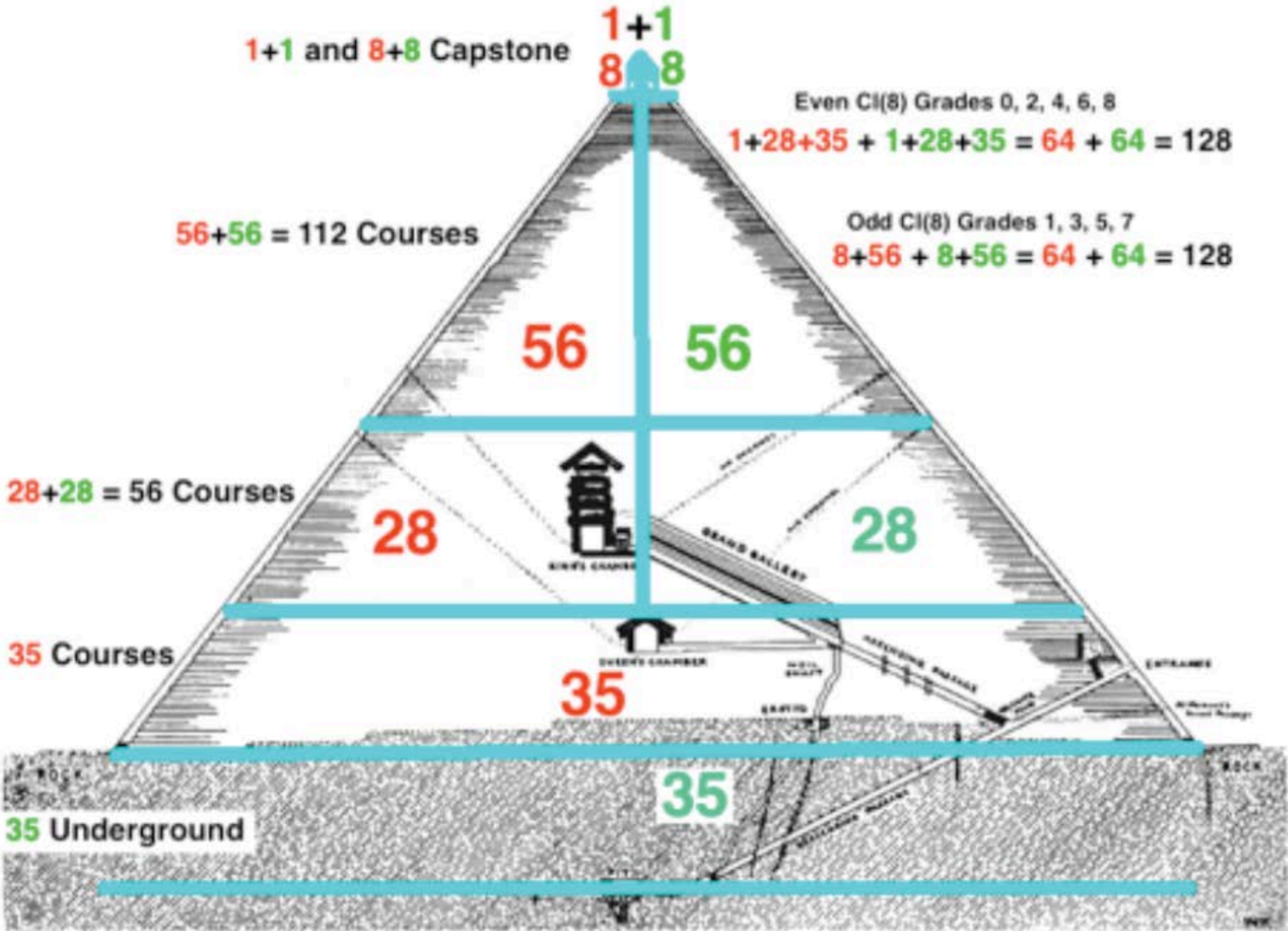

$$1 + 8 + 28 + 56 + ( 35 + 35 ) + 56 + 28 + 8 + 1$$

( image adapted from David Davidson image - for larger size see [tony5m17h.net/GreatPyrCl8.png](http://tony5m17h.net/GreatPyrCl8.png) )

William Kingdon Clifford (1845 - 1879), according to Wikipedia said in (1878, "On the Nature of Things-in-Themselves", Mind, Vol. 3, No. 9, pp. 57–67),  
 "... That element of which ... even the simplest feeling is a complex,  
 I shall call **Mind-stuff**.

A moving molecule of inorganic matter does not possess mind or consciousness ; but it possesses a small piece of mind-stuff. ...

When molecules are ... combined together ... **the elements of mind-stuff** which go along with them ... **combine ... to form the ... beginnings of Sentience**.

When the molecules are so combined as to form the brain and nervous system ... the corresponding elements of mind-stuff are so combined as to form some kind of consciousness ... changes in the complex which take place at the same time get so linked together that the repetition of one implies the repetition of the other.

**When matter takes the complex form of a living human brain, the corresponding mind-stuff takes the form of a human consciousness ..."**

Tensor Product  $Cl(0,8) \times Cl(p,q) = M(R,16) \times Cl(p,q) = Cl(p,q+8)$

Real Clifford Algebras  $Cl(p,q)$

8	$M_{16}(R)$	$M_{16}(C)$	$M_{16}(H)$	$M_{16}(H) \oplus M_{16}(H)$	$M_{32}(H)$	$M_{64}(C)$	$M_{128}(R)$	$M_{128}(R) \oplus M_{128}(R)$	$M_{256}(R)$									
7	$M_8(C)$	$M_8(H)$	$M_8(H) \oplus M_8(H)$	$M_{16}(H)$	$M_{32}(C)$	$M_{64}(R)$	$M_{64}(R) \oplus M_{64}(R)$	$M_{128}(R)$	$M_{128}(C)$	$M_{128}(H)$								
6	$M_4(H)$	$M_4(H) \oplus M_4(H)$	$M_8(H)$	$M_{16}(C)$	$M_{32}(R)$	$M_{32}(R) \oplus M_{32}(R)$	$M_{64}(R)$	$M_{64}(C)$	$M_{64}(H)$	$M_{64}(H) \oplus M_{64}(H)$	$M_{128}(H)$							
5	$M_2(H) \oplus M_2(H)$	$M_4(H)$	$M_8(C)$	$M_{16}(R)$	$M_{16}(R) \oplus M_{16}(R)$	$M_{32}(R)$	$M_{32}(C)$	$M_{32}(H)$	$M_{32}(H) \oplus M_{32}(H)$	$M_{64}(H)$	$M_{128}(C)$	$M_{256}(R)$						
4	$M_2(H)$	$M_4(C)$	$M_8(R)$	$M_8(R) \oplus M_8(R)$	$M_{16}(R)$	$M_{16}(C)$	$M_{16}(H)$	$M_{16}(H) \oplus M_{16}(H)$	$M_{32}(H)$	$M_{64}(C)$	$M_{128}(R)$	$M_{128}(R) \oplus M_{128}(R)$	$M_{256}(R)$					
3	$M_2(C)$	$M_4(R)$	$M_4(R) \oplus M_4(R)$	$M_8(R)$	$M_8(C)$	$M_8(H)$	$M_8(H) \oplus M_8(H)$	$M_{16}(H)$	$M_{32}(C)$	$M_{64}(R)$	$M_{64}(R) \oplus M_{64}(R)$	$M_{128}(R)$	$M_{128}(C)$	$M_{128}(H)$				
2	$M_2(R)$	$M_2(R) \oplus M_2(R)$	$M_4(R)$	$M_4(C)$	$M_4(H)$	$M_4(H) \oplus M_4(H)$	$M_8(H)$	$M_{16}(C)$	$M_{32}(R)$	$M_{32}(R) \oplus M_{32}(R)$	$M_{64}(R)$	$M_{64}(C)$	$M_{64}(H)$	$M_{64}(H) \oplus M_{64}(H)$	$M_{128}(H)$			
1	$R \oplus R$	$M_2(R)$	$M_2(C)$	$M_2(H)$	$M_2(H) \oplus M_2(H)$	$M_4(H)$	$M_8(C)$	$M_{16}(R)$	$M_{16}(R) \oplus M_{16}(R)$	$M_{32}(R)$	$M_{32}(C)$	$M_{32}(H)$	$M_{32}(H) \oplus M_{32}(H)$	$M_{64}(H)$	$M_{128}(C)$	$M_{256}(R)$		
0	$R$	$C$	$H$	$H \oplus H$	$M_2(H)$	$M_4(C)$	$M_8(R)$	$M_8(R) \oplus M_8(R)$	$M_{16}(R)$	$M_{16}(C)$	$M_{16}(H)$	$M_{16}(H) \oplus M_{16}(H)$	$M_{32}(H)$	$M_{64}(C)$	$M_{128}(R)$	$M_{128}(R) \oplus M_{128}(R)$	$M_{256}(R)$	
	0	1	2	3	4	5	6	7	8	9	10	11	12	13	14	15	16	

$q \rightarrow$

**H = Quaternion**

**C = Complex**

**R = Real**



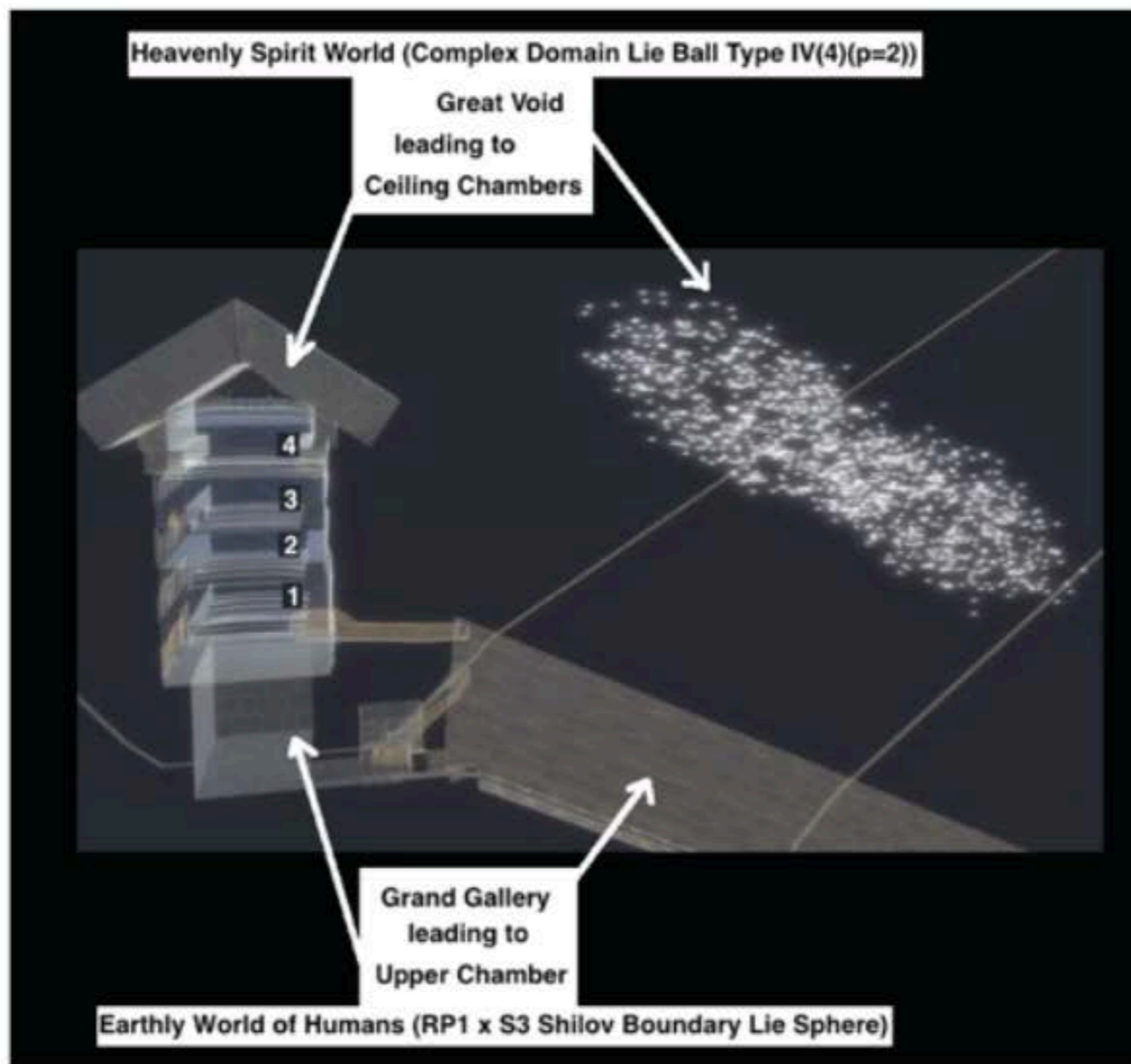

The Builders of the Great Pyramid represented the Real Shilov Boundary Physical world by the Grand Gallery and Upper Chamber that are easily accessible by Humans with Microtubule Quantum Consciousness and they represented the Imaginary Complex World of CI(16) Spacetime Cells mirroring the Human Microtubule World as Ceiling Chamber spaces and the Great Void that are more accessible to Souls of the Spirit World than to Physical Humans.

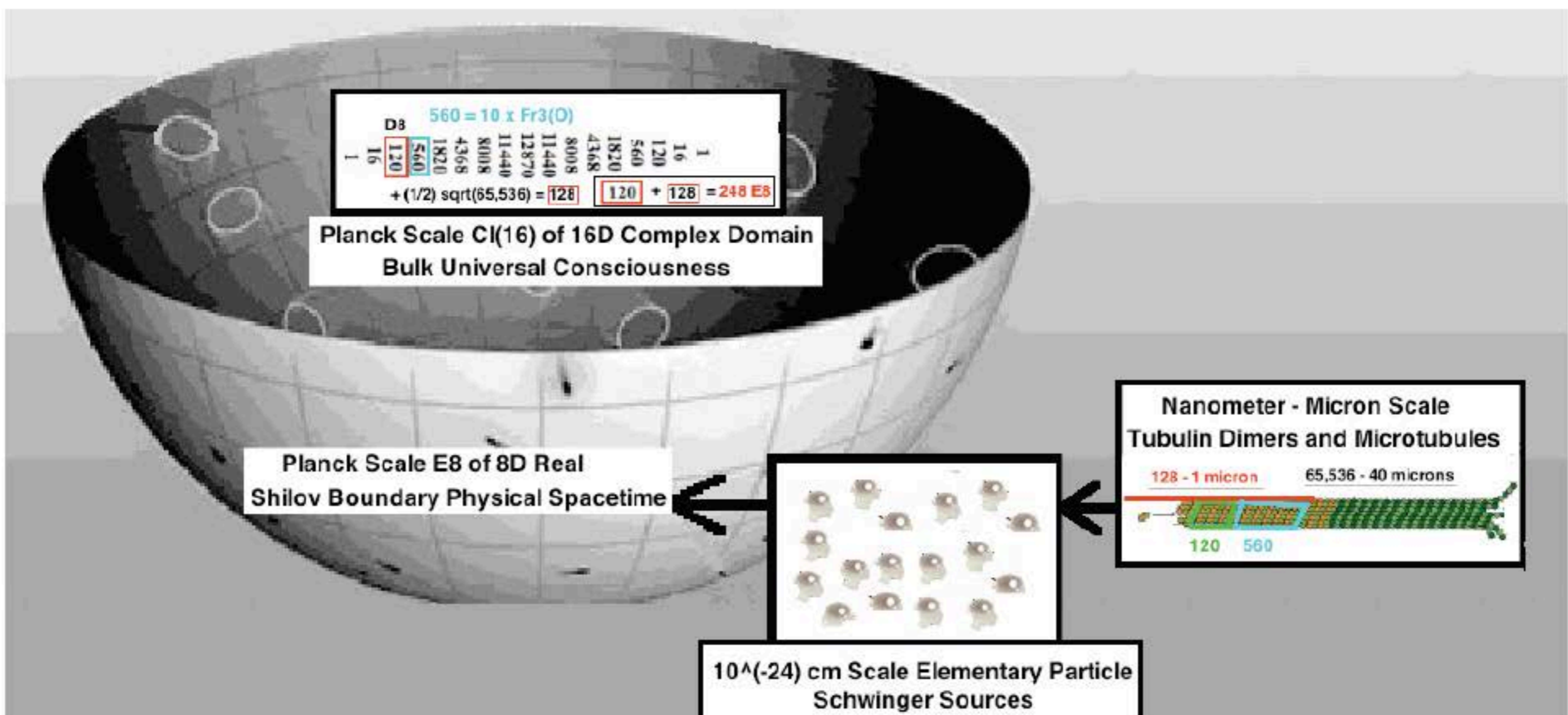

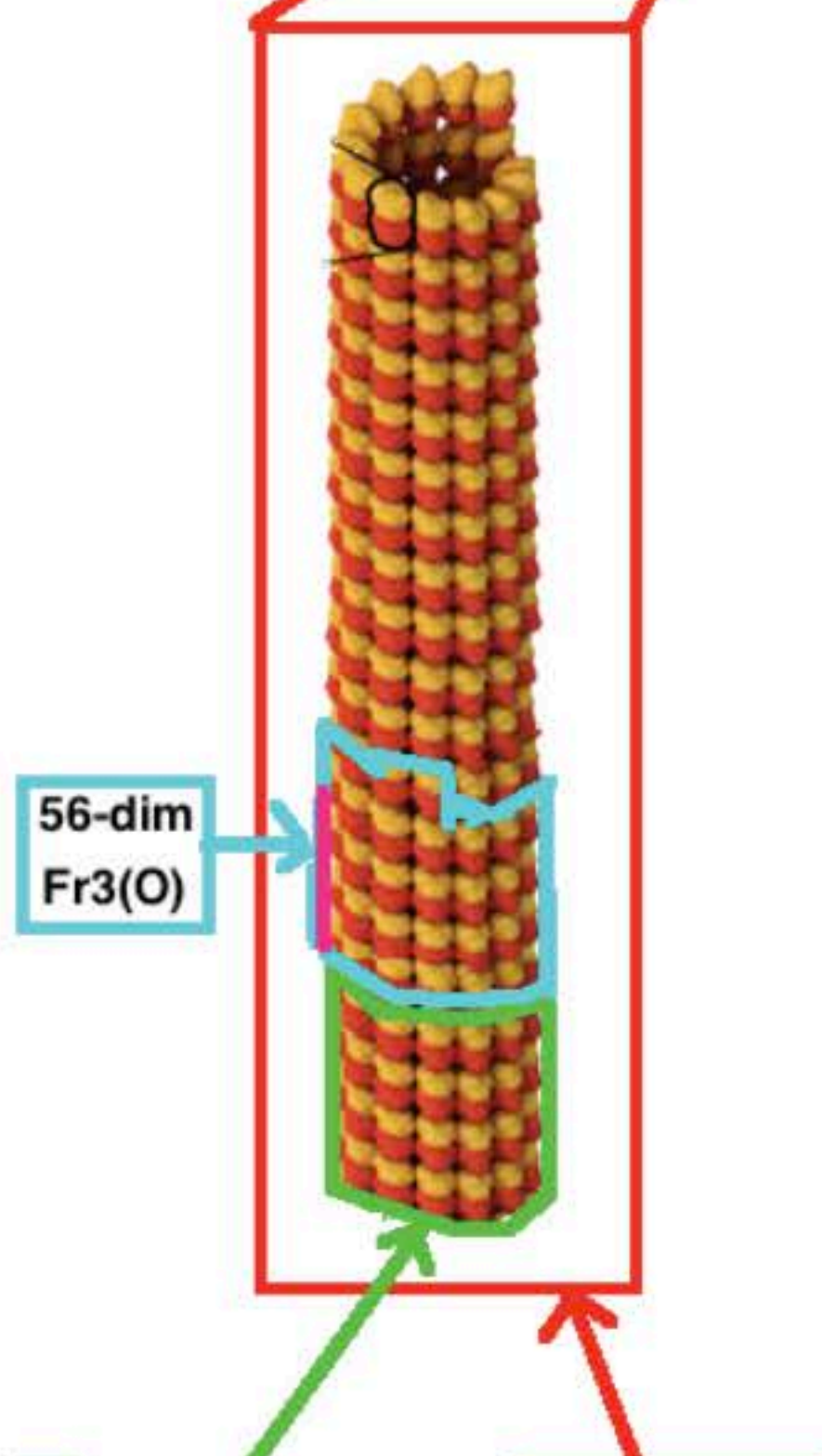

56-dim Fr3(O)

52-dim F4 of CP2 in 256-dim Cl(8)

F4 / B4 = OP2 = Spinor Fermions =  
= 8 Particles + 8 AntiParticles  
B4 / D4 = 8-dim SpaceTime =  
= Kaluza-Klein M4 x CP2  
D4 = Spin(8) contains Spin(6) = SU(4)  
contains SU(3) Color Force  
SU(3) Color Force = Global Symmetry  
of CP2 = SU(3) / SU(2)xU(1)  
SU(2)xU(1) ElectroWeak Force =  
= Local Symmetry of CP2



**B4**  
28  
8

**CP2**  
+ sqrt(256) = 16 = 52 F4  
CP2 = SU(3) / SU(2)xU(1)

**(Cnf6 -> M4) x CP2**

**D8**  
120 + (1/2) sqrt(65,536) = 128 = 248 E8

**B4**  
28  
8

**Cnf6 -> M4**  
+ sqrt(256) = 16 = 52 F4

1
8
28
56
70
56
28
8
1

128 - 1 micron

1
16
120
560
1820
4368
8008
11440
12870
11440
8008
4368
1820
560
120
16
1

65,536 - 40 microns

1
8
28
56
70
56
28
8
1

Cl(8) x Cl(8) = Cl(16)

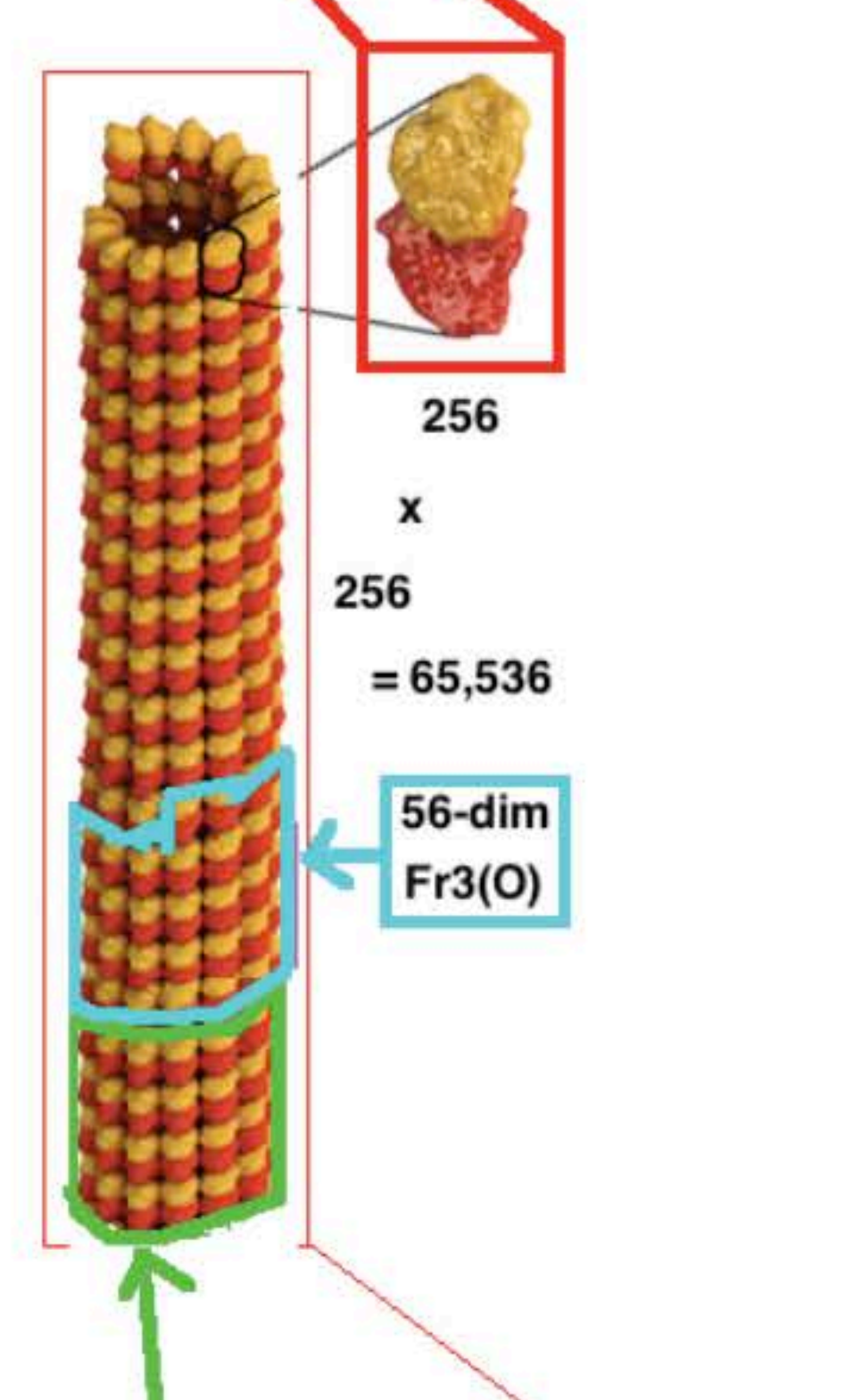

56-dim Fr3(O)

52-dim F4 of Cnf6 -> M4 in 256-dim Cl(8)

F4 / B4 = OP2 = Spinor Fermions =  
= 8 Particles + 8 AntiParticles  
B4 / D4 = 8-dim SpaceTime =  
= Kaluza-Klein M4 x CP2  
D4 = Spin(4,4) contains Spin(2,4) of  
Conformal Gravity + Dark Energy



**E8 Kaluza-Klein (Cnf6 -> M4) x CP2**

In ( Cl(8) of CP2 ) x ( Cl(8) of Cnf6 -> M4 ) = Cl(16) containing E8  
at each of the 256 points of Cl(8) of Cnf6 -> M4 there are all 256 points of Cl(8) of CP2

**D8 = Cl(16) BiVectors = 120**

**E8 / D8 = 128-dim Fermion Spinor Space = 8 components of 8+8 Fermions**

**D8 / D4 x D4 = A7+1 = 64 = 8-dim position x 8-dim momentum**

**D4 containing D3 = Spin(2,4) = A3 = SU(2,2) for Conformal Gravity + Dark Energy**

**D4 containing D3 = SU(4) containing Color Force SU(3)**

**10xFr3(O) = Cl(16) TriVectors = 560**

# Rig Veda / Angkor Wat

About 50,000 years ago (National Geographic Genographic)  
 YAP and M174 went out of Africa to Sunda  
 (then dry land South of Angkor Wat  
 and SouthEast of India)  
 and on to Japan and Tibet

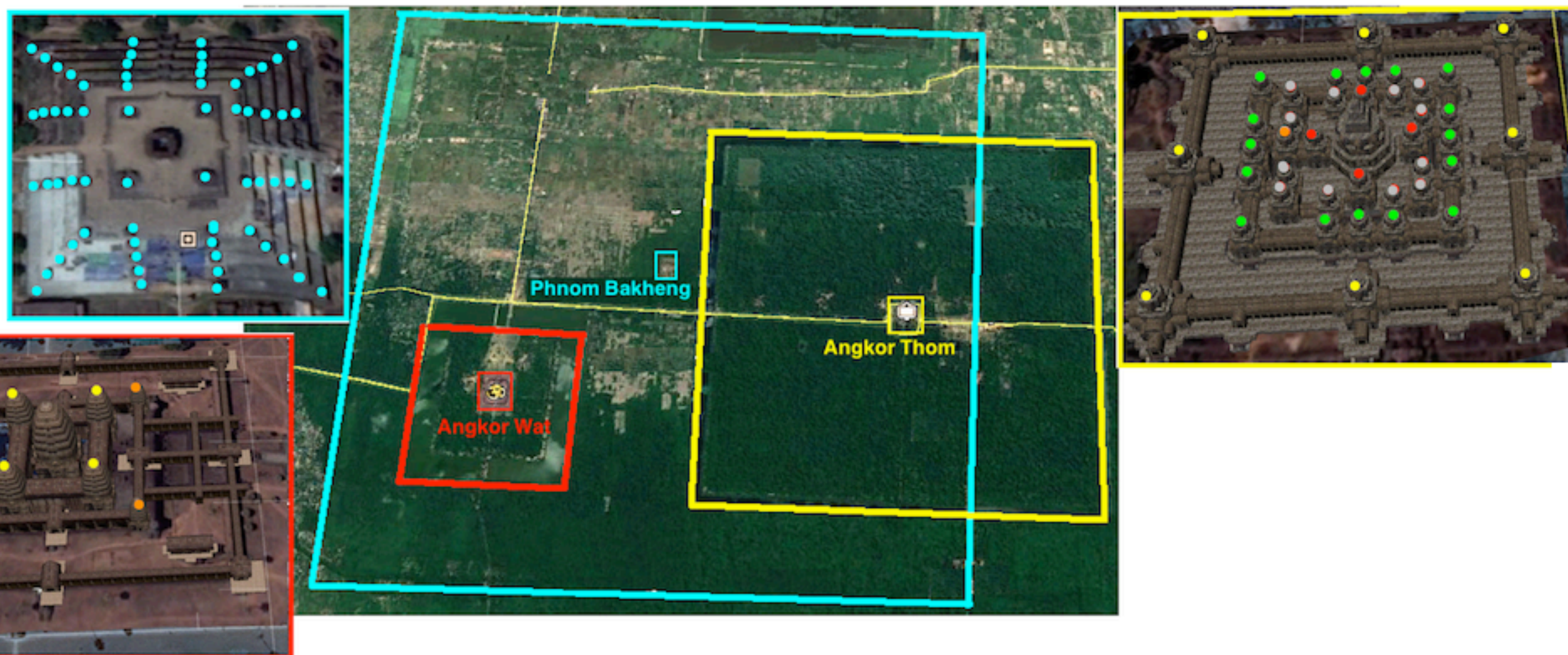
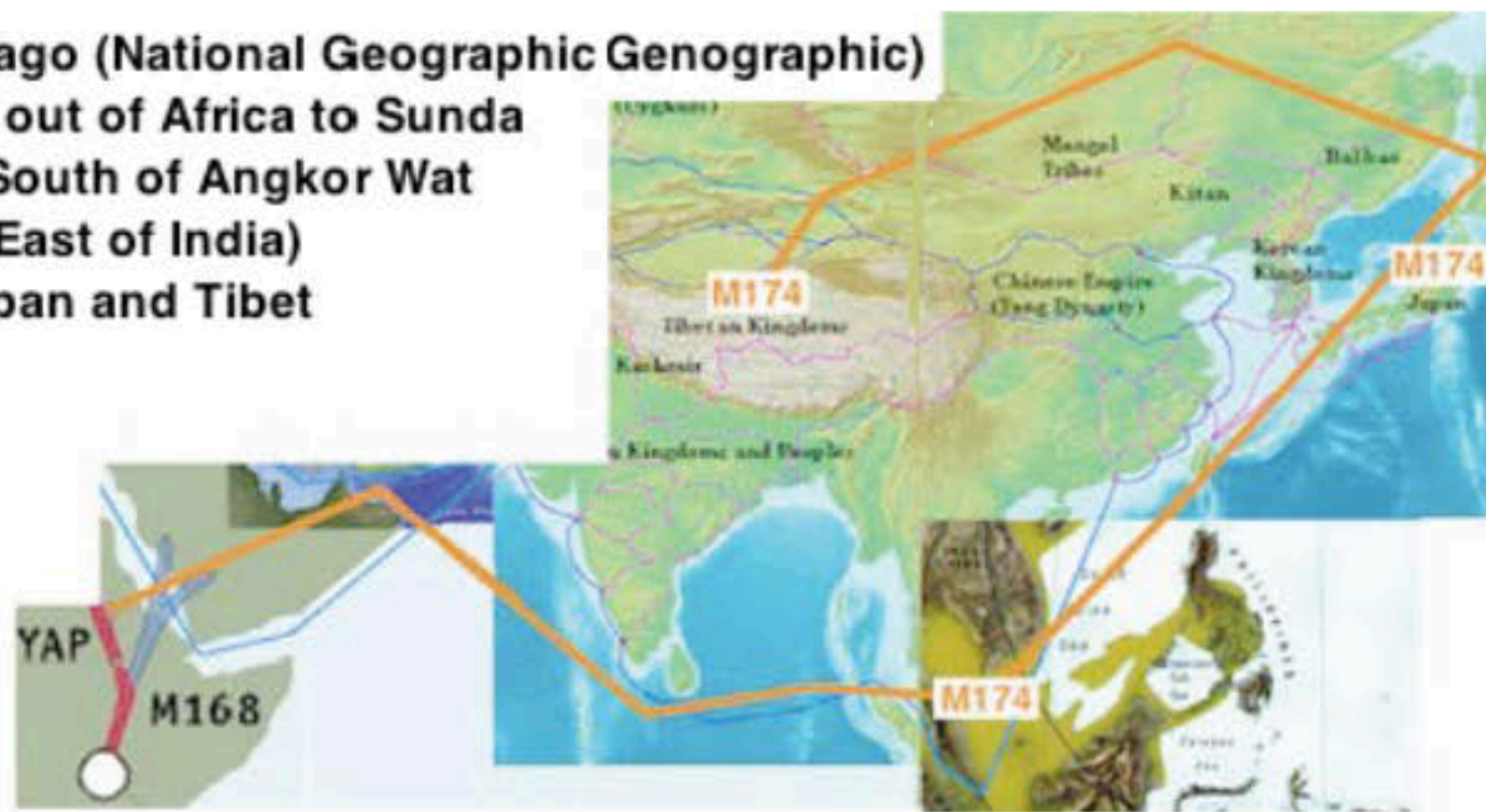

Angkor Thom, Angkor Wat, Phnom Bakheng

<-->

Giza Great Pyramid Cl(8) (D4gde), Second Pyramid Cl(8) (D4sm), Sphinx Cl(16) (E8 + Fr3(O))

Angkor Thom: 8 yellow Outer Towers + 16 green Middle Towers = 24-dim  $O \times O \times O$  of  $Fr_3(O)$  26-D String=World-Line Theory  
 1 orange Inner Tower = Bohm Quantum Potential from Cl(16) TriVectors  
 4 red + 12 gray Inner Towers = Fundamental Lepton + Quark Particles / AntiParticles from Cl(16) half-Spinors

Angkor Wat: 4 yellow Inner Towers = 4-dim Minkowski Physical Spacetime of Kaluza-Klein  $M_4 \times CP^2$  from Cl(16) BiVectors  
 4 orange Middle Towers = 4-dim  $CP^2 = SU(3) / SU(2) \times U(1)$  of Kaluza-Klein  $M_4 \times CP^2$  from Cl(16) BiVectors

Phnom Bakheng: 64 cyan Towers =  $D_8 / D_4 \times D_4 =$  by Cl(16) Triality = ++half-Spinor Fermion Particles  
 = --half-Spinor Fermion AntiParticles  
 ++half-Spinor Fermion Particles + --half-Spinor Fermion AntiParticles = 64+64 = 128 =  $E_8 / D_8$

**Rig Veda Mandala 1 encodes the 240 Root Vectors of E8 = 24 + 24 + 64 + 64 + 64**

Akashkar	Buddhi	Manas	Akash	Vayu	Agni	Jal	Prithvi	Akashkar	Buddhi	Manas	Akash	Vayu	Agni	Jal	Prithvi	Akashkar	Buddhi	Manas	Akash	Vayu	Agni	Jal	Prithvi
अकृ	नि	मी	ळे	पु	रो	हि	तं	य	ज्ञ	स्यं	दे	व	मु	त्वि	जम्	हो	ता	रं	रं	लु	धा	तं	मम्
AK	NI	MI	LE	PU	RO	HI	TAM	YA	GYA	SYA	DE	VA	MRI	TVI	JAM	HO	TA	RAM	RA	TNA	DHA	TA	MAM
अ	भिः	पू	वै	भिः	अ	भिः	प्रि	री	ड	सो	नू	तं	ने	इ	त	स	दे	वाँ	ए	ह	दं	च	ति
अ	भिः	नां	उ	भिः	भं	श्न	उ	त्वो	षं	शे	ख	दि	वे	दि	वे	सु	श	सं	खो	र	वं	त	मम्
अ	भे	यं	यु	ज	मं	ध्व	रं	वि	श्च	कं	प	दि	पु	र	सिं	स	इ	दे	वे	धुं	ग	च्छ	ति
अ	भिर	हो	वां	क	वि	कं	रुः	सु	त्यश्	चि	त्र	श्रं	व	स्त	पः	दे	वो	दे	वे	भि	रा	गं	मव
य	ड	ङ्ग	दा	सु	षे	तु	वं	अ	गं	पु	इं	क	रि	प्य	त्रिं	त	वेत्	तत्	सु	त्व	मं	ङ्गि	रः
उ	पं	त्वा	शे	दि	वे	दि	वे	दो	र्षां	व	स्व	दी	दि	वि	मम्	न	मो	भ	रं	नु	ए	मं	सि
रा	वं	न्त	म	ध्व	रा	शां	गो	पा	मुं	त	स्व	दी	दि	वि	म	व	धै	मा	तुं	सु	वे	द	सं
स	नः	पि	ते	वं	सु	न	वे	अ	गं	सु	षा	पु	नो	भं	वं	स	वं	सु	आ	नः	स्व	स्त	यं

24 First Richa Syllables + 24 First Richa Gaps = D4sm + D4gde (purple box)

8x8 = 64 Last-8 Syllables of Last 8 lines = D8 / D4sm x D4gde (blue box)

8x8 = 64 (red box) plus 8x8 = 64 (green box) give 128 = E8 / D8 = Fermions  
Middle-8 Syllables of Last 8 lines plus First-8 Syllables of Last 8 Lines

According to Wikipedia and emails from John Small:  
“... The Rig Veda is composed of ten books (called mandalas in Sanskrit) [that correspond to 10 Spacetime dimensions of 26D World-Line=String Theory] ...

The first book [RV1] is a collection of hymns from seers of different families [encapsulating the whole Rig Veda] ...

Seven of the books [RV2 through RV8] each relate primarily to one great seer [and represent the 7 imaginary Octonions] ...

The ninth book is [RV9] Soma hymns [and represent the Octonion Real Axis] Terence McKenna postulates that the most likely candidate for soma is the mushroom Psilocybe cubensis, a hallucinogenic mushroom that grows in cow dung ... the 9th mandala of the Rig Veda makes ... references to the cow as the embodiment of soma ...

The tenth book [RV10] [complements the first and fills in the gaps]...”

RV2 through RV9 together represent  
the Octonion Structure of Spin(0,8) = Spin(1,7)  
and the RP1 x S7 Lie Sphere Shilov Boundary of Type IV(8) Complex Domain  
of Lie Ball Symmetric Space Spin(2,8) / Spin(8) x U(1)

RV1 and RV10 together represent  
the (1,1) Conformal Structure of Spin(1,9) = Spin(2,8) = SL(2,O)

Graham Hancock, in *Heaven's Mirror*, said "... Our current world age is Pisces because on the spring equinox ... Pisces rises just ahead of the sun ... because of precession ... ( 1 degree in 72 years) ... the sun spends around 2160 years [ 2160 = second layer vertices of all E8 Lie Algebra Lattices ] in each constellation - a complete revolution taking 26,000 years! The great Hindu temple-complex ... spread over 200 square miles confirms that they correspond to the stars in the constellation of Draco, as they appeared in 10,500 BC! ...

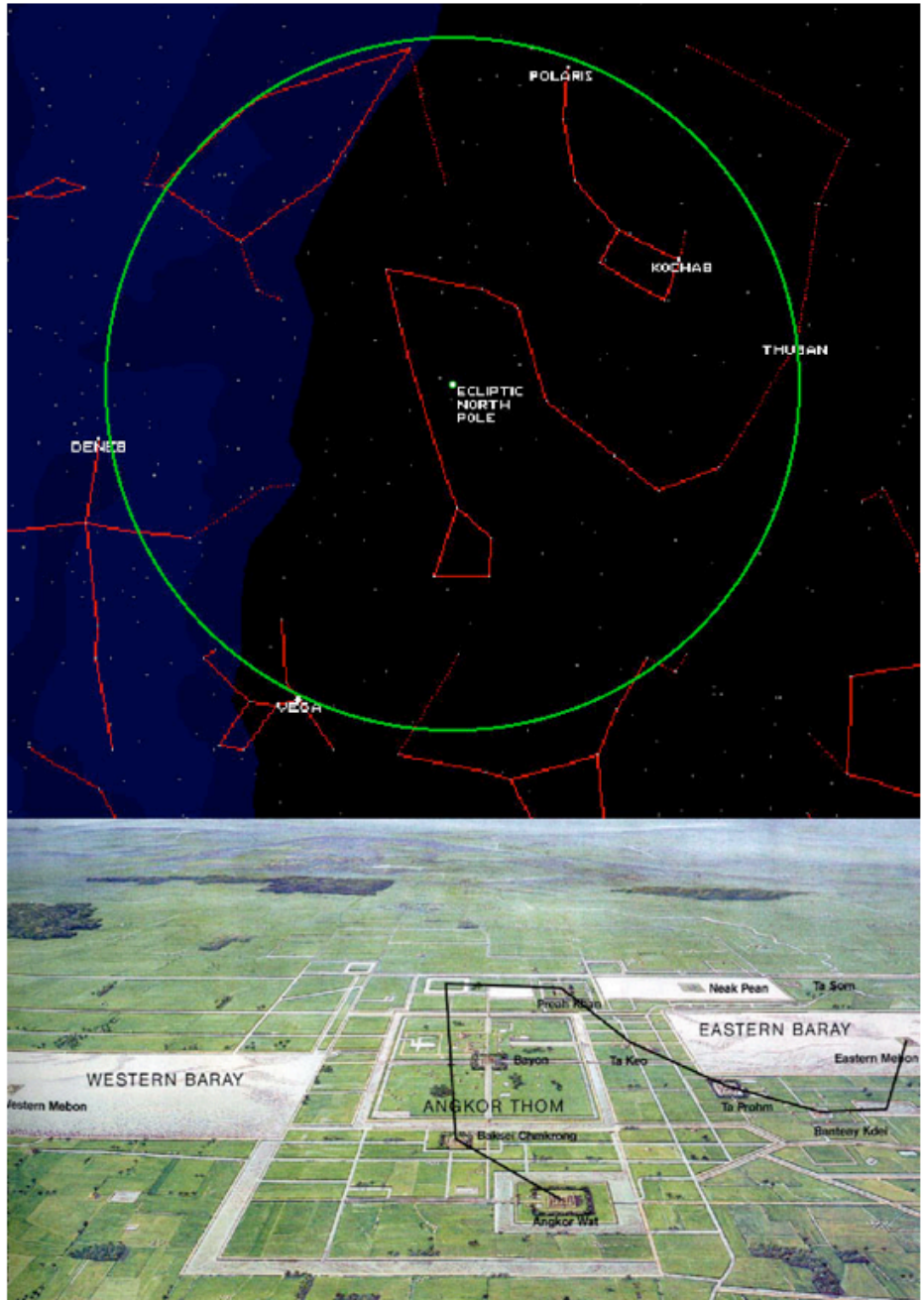

... "

The same star configuration of 10,500 BC = 12,500 years ago would have appeared in the previous precession period about 38,500 years ago, with Vega as North Star and Angkor Thom as the Ecliptic North Pole, about the time humans first arrived from Africa.

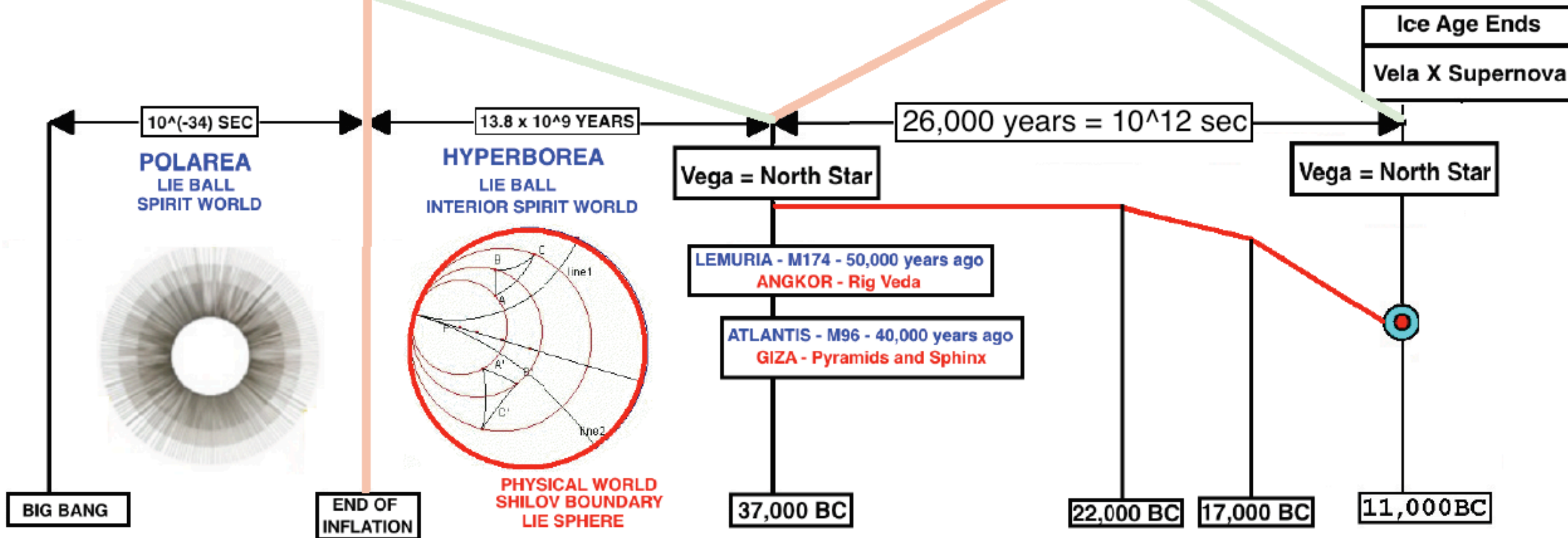
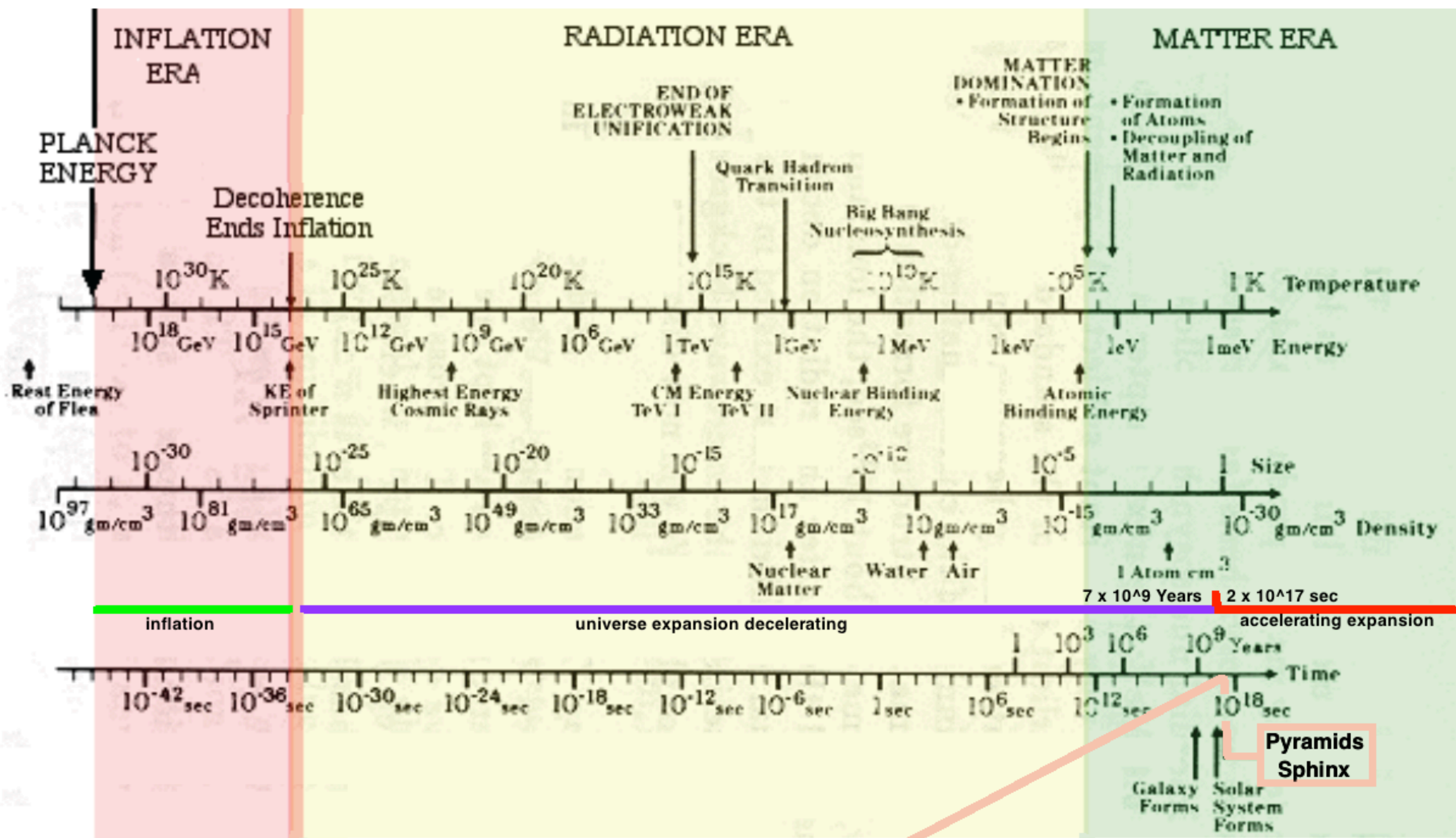

**Manetho decline of the Gods:**  
 Gods -> Demigods -> Spirits of the Dead -> Mortal Humans