

Division by zero.

LESZEK MAZUREK

© Copyright 2020 Leszek Mazurek. All rights reserved

<https://www.linkedin.com/in/leszekmazurek/>
[e-mail: Leszek.Mazurek@op.pl](mailto:Leszek.Mazurek@op.pl)

Abstract

This paper solves the problem of division by zero. Starting with a deep analysis of multiplication and division, it is presented that they are one in the same, as an operation. Together with the operation of selection, they are different forms of the transformation operation, that changes one pair of numbers into another pair of numbers. It is presented that the numbers are always in reference to some other numbers. Therefore, the only correct form of the number, is when it is a ratio between the certain value and the base measure, which this value is related to. It is clearly proven that the problem of division by zero is the result of unauthorized simplification, which was done by bringing all the rational numbers (which are represented by the ratio of the value to the measure) to the fractions, with a denominator of 1. This paper shows why we should not make fractions with different numerators and denominators equal, even so they seem to be in the same proportion. Finally, there are two graphs with the functions presented $1/x$ and $\text{tg}(x)$ with their discontinuity points, which are visible only on the real numbers graph. This result is from projecting points of the rational numbers graph onto the real numbers graph with a denominator of 1. These discontinuity points disappear when we present our graphs in rational numbers. This paper fixes one of the foundations of mathematics and shows us how to divide by zero. This is only the first issue that was solved, but based on the proper understanding of numbers in their natural form, still many other things need to be fixed. It is still difficult to predict all the consequences, which this change can bring, to everything that was created based on this wrong foundation.

Table of Contents

1. Introduction.....	5
2. Understanding multiplication and the division of numbers.....	6
3. Division and multiplication as a transformation.....	9
4. A fraction as an element that can transform itself.....	15
5. Unification of multiplication and division.....	16
6. Commutative property of multiplication.....	17
7. Introduction of the selection operation.....	18
8. The formal definition of transformation (multiplication, division and selection).....	19
9. Whether $1/2$ is equal to $2/4$?.....	25
10. Division by zero as a transformation.....	27
11. Whether $1/2$ is equal $1/2$?.....	27
12. What is the meaning of the ratio's numerator and denominator during the transformation?.....	30
13. The ratio as a natural form of the number.....	31
14. Definition of n-times ratio set.....	34
15. Interpretation of the point on the graph of ratios.....	36
16. The non-reality of the real line.....	39
17. Problems with terminology.....	41
18. Problems with numbers.....	42
19. Other consequences of perceiving rational numbers only by their projections onto the real axis.....	45
20. The graphical representation of the function $f(x) = 1/x$ in both real numbers and rational numbers.....	46
21. Graphical representation of the function $f(x) = tg(x)$ in both rational numbers and real numbers.....	48
22. Viewing the world through the perspective of rational numbers.....	50
23. Summary.....	51
24. Ending.....	51

The natural form of a number is its value, relative to a certain measure.

Leszek Mazurek

The worst are the consequences of errors made in assumptions.

Leszek Mazurek

1. Introduction.

Since the beginning of time, the ban on dividing by zero has been a serious problem for all thinking people, who have found this restriction hard to accept. Moreover, intuitively it seems very artificial and unjustified. In this work, I have made the effort to analyze this problem very carefully, to try and finally understand where it comes from, why it is a problem, a limitation, and what should be done to solve it. The results I have obtained, not only solve this problem, but also shed a whole new light on understanding numbers, the operation of numbers, and will probably have a number of other consequences. There are other areas of algebra, mathematics and related fields such as physics, chemistry or astronomy that it can influence. It is amazing that this problem has been left without proper understanding for so long.

2. Understanding multiplication and the division of numbers.

To understand the division of numbers correctly, and in particular, the division by zero, we must begin, by understanding the multiplication itself. In general form, multiplication can be represented as:

$$a \cdot b = c \quad (1)$$

By doing the multiplication, we are solving a problem that we have given **a** and **b**, and we are looking for **c**, that is equal to **a**-times **b** (a-times sum of b). We can illustrate this problem as follows:

$$a \cdot b = ? \quad (2)$$

Or in graphic form:

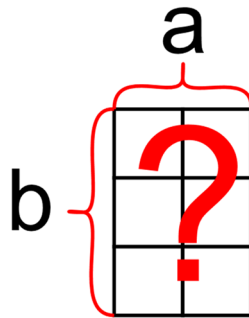

Figure 1. Problem to be solved during multiplication.

In the example presented on Figure 1 above

$$a = 2, b = 3 \quad (3)$$

so

$$c = a \cdot b \quad (4)$$

$$c = 2 - \text{times sum of } 3 \quad (5)$$

$$c = 3 + 3 \quad (6)$$

$$c = 6 \quad (7)$$

So, what will the division operation look like, after following these very basic symbolic notations? In general form, we can present division as:

$$\frac{c}{a} = b \quad (8)$$

The problem we want to solve, is that we have given **c**, which we divide into **a** equal groups and ask, how many elements there are in each group?

$$\frac{c}{a} = ? \tag{9}$$

The division operation presented above causes a lot of problems for mathematicians, because it has one, but very significant limitation. As long as there is no problem, like in the case of multiplication, to multiply by zero, because any number multiplied by zero (any number of zeros added to each other) gives zero as a result. In the case of division, the denominator of a fraction can't be zero, because we are not able to divide something into zero groups. It goes beyond our ability to interpret such phenomena based on the principles of logic and our mathematical reasoning.

Keeping in mind the general form of multiplication from (1):

$$a \cdot b = c \tag{10}$$

and defined in (2), the problem related with multiplication:

$$a \cdot b = ? \tag{11}$$

division can also be presented in a slightly modified form:

$$a \cdot ? = c \tag{12}$$

So, this time, the problem that we have to solve, we can describe as follows. We have given **a**, what do we do to get **c**? Using slightly different words. We **have a**, we **want to get c**, what do we need to do?

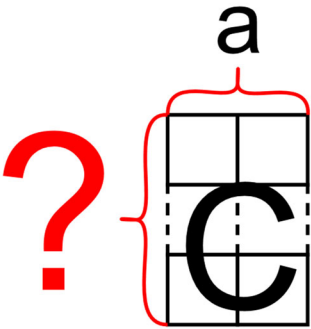

Figure 2. A problem to be solved during division.

Continuing the example with numbers **2,3** and **6**, the problem of divisibility would be as follows. We have given **2**, we want to get **6**, what do we need to do? Answer: Multiply it three-times (**3**-times).

The question posed above seems to be a more primary problem, but we usually try to solve it, by putting the matter "upside down," trying to calculate the value that we are searching for, by dividing **c** into **a** number of equal parts.

Let's consider another example carefully. Let's try to divide 1 by 2. So, let's look carefully at what the symbol

$$\frac{1}{2} \tag{13}$$

really means?

In the traditional sense it means, that we are dividing **one** into **two equal sets**. As a result of this operation we get **two sets** of "half"! At first glance this seems a bit strange, because dividing 1 by 2 seems to appear like we are getting in fact two times (two sets) of half, but not just half!? Listening with understanding the sentence "One divided by two is half" we conclude that it is not consistent with what we are observing. It would be more correct to say, that "**One** divided into **two** equal parts (into two equal sets) gives the **half** of one in each of two sets". It is worth noting that in order to be able to divide into **two sets**, what we actually divide, is initially represented by **one set**. Let's visualize this concept on the graph.

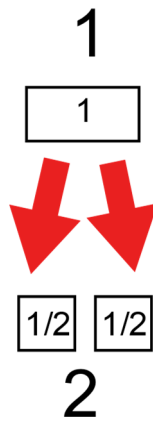

Figure 3. Division 1:2.

The inverse would be to sum up and combine these separated sets, as shown below, with the result being 1 again.

$$\frac{1}{2} + \frac{1}{2} = 2 \cdot \frac{1}{2} = 1 \tag{14}$$

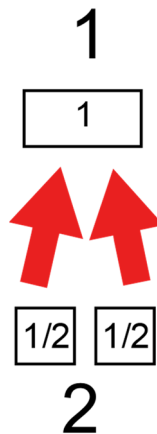

Figure 4. Inverse of the division $\frac{1}{2}$.

In the operation of multiplication, we are combining two sets of half, and as a result we have one, or more accurately one set of one.

3. Division and multiplication as a transformation.

Note that in the classic interpretation of a fraction we use top-down analysis. So, we start with the numerator and go to the denominator. Dividing one (numerator) by two (denominator). We can understand the operation in an opposite direction, which is multiplication by two, moving through a fraction from the bottom, up. We combine two (denominator) and create one (numerator).

$$\text{Division} \downarrow \frac{1}{2} \uparrow \text{Multiplication}$$

Figure 5. Multiplication and division as invert operations

Let's try to analyze one more case:

$$\frac{3}{5} \tag{15}$$

This fraction represents the operation of the division of 3 by 5, in other words, we have three and we want to divide it into five equal groups. The picture on Figure 6 presents this operation in graphical form.

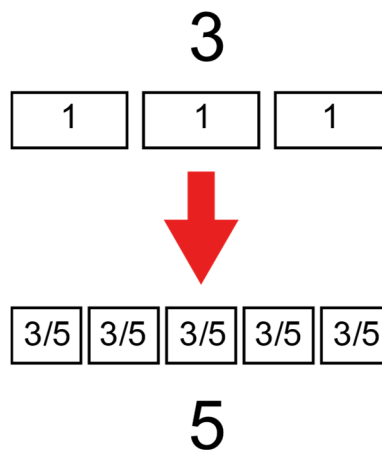

Figure 6. 3 divided by 5.

Mathematically, we can write it, e.g. as below.

$$3 : 5 = \frac{3}{5} \tag{16}$$

By performing the opposite of the above, we get the multiplication operation, which is.

$$\frac{3}{5} \cdot 5 = 3 \tag{17}$$

Or graphically:

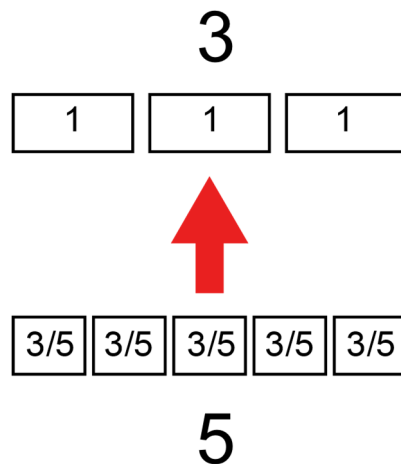

Figure 7. Multiplication 5 times $\frac{3}{5}$.

Carefully analyzing the examples presented above, we can see that in each case, we are actually dealing with **four numbers** that together, describe some kind of change (transformation). And for example, division $\frac{3}{5}$ means transformation:

$$3 \cdot 1 \rightarrow 5 \cdot \frac{3}{5} \quad (18)$$

The inverse operation (multiplication)

$$3 \cdot 1 \leftarrow 5 \cdot \frac{3}{5} \quad (19)$$

Or written from left to right

$$5 \cdot \frac{3}{5} \rightarrow 3 \cdot 1 \quad (20)$$

The division of 1 by 2 written in the form of four numbers, that makes the transformation

$$1 \cdot 1 \rightarrow 2 \cdot \frac{1}{2} \quad (21)$$

The inverse operation (multiplication)

$$1 \cdot 1 \leftarrow 2 \cdot \frac{1}{2} \quad (22)$$

The multiplication operation presented at the beginning of this chapter

$$2 \cdot 3 \rightarrow 6 \cdot 1 \quad (23)$$

The inverse operation representing $\frac{6}{3}$ or $\frac{6}{2}$

$$2 \cdot 3 \leftarrow 6 \cdot 1 \tag{24}$$

Note that the division operation causes a transformation that is inverted by the transformation associated with the multiplication operation.

$$3 \cdot 1 \rightarrow 5 \cdot \frac{3}{5} \rightarrow 3 \cdot 1 \tag{25}$$

Analyzing the above notation from left to right, we have 3 entities (that is, three times one), which we are dividing (transforming) into 5 equal parts of $\frac{3}{5}$. Then we are transforming, combining 5 of them together (multiplying it 5 times) we are getting 3 entities back.

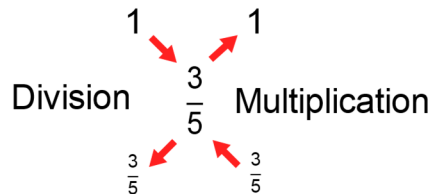

Figure 8. Division and multiplication as a transformation by $\frac{3}{5}$

The next example in Figure 9 can be read as follows.

Division: We have six entities (which is six times one, six elements of one, six sets of one) and we transform them into three equal sets (groups of elements) of two in each of them.

Then multiplication: We have two elements in three equinumerous groups and we transform them into six groups of one (six of one, in short, we can say just six).

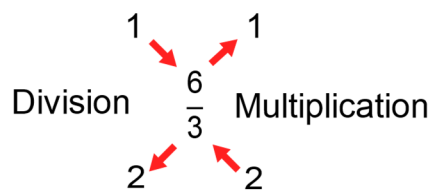

Figure 9. Division and multiplication as a transformation by $\frac{6}{3}$

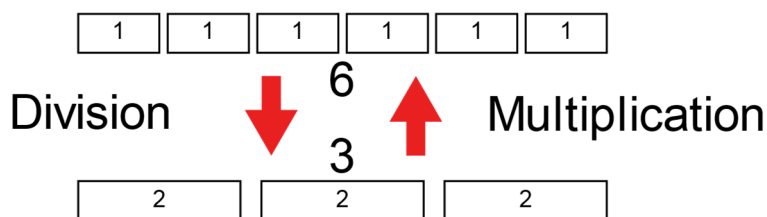

Figure 10. 6 groups of 1 \leftrightarrow 3 groups of 2.

Usually because of some reasons in these kinds of operations we have number 1, which is in formal mathematical notation omitted, however, these are only special cases and it does not have to be this way. The example below shows that this understanding of multiplication and division works just fine in more general cases.

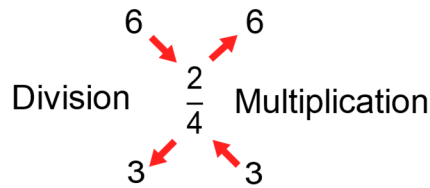

Figure 11. Division and multiplication as a transformation by $\frac{2}{4}$.

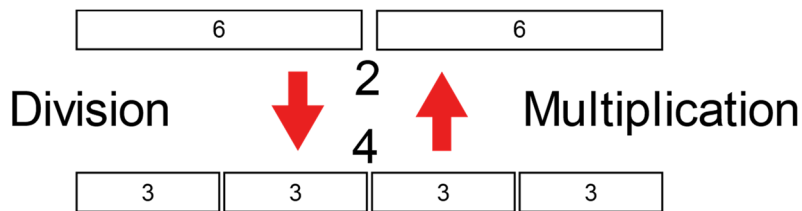

Figure 12. 2 groups of 6 \leftrightarrow 4 groups of 3.

We can read this example as follows.

Division: We have two groups of six elements and we transform them (dividing) into four groups of three elements.

Multiplication: We have four groups of three elements and we transform them (combine them) into two groups of six elements.

As it can be seen from all the examples above, for both **multiplication** and **division**, we are doing some kind of **transformation**, converting **two numbers into different two numbers**. In the example presented in Figure 11 and in Figure 12 we did a transformation of pair (2,6) into pair (4,3) and back.

$$(2,6) \leftrightarrow (4,3) \quad (26)$$

In this example the numbers 2 and 4 **define the transformation**, those are the numbers that make up the fraction $\frac{2}{4}$ (refer to the magnifying glass in Figure 13 below). Then the other two numbers, 6 and 3 are **undergoing this transformation** in either one direction or the other.

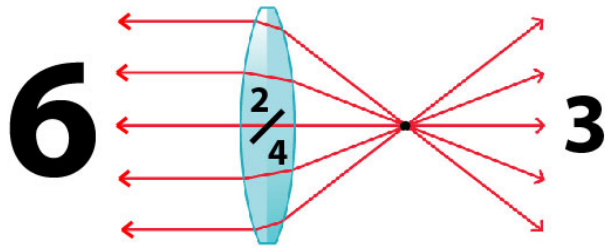

Figure 13. Fraction $\frac{2}{4}$ as a magnifying glass.

In the case of division, the fraction tells us how many groups we are transforming (in this case 2), into how many final groups (in this case 4).

In the case of multiplication (the opposite direction) we transform four groups into two.

Now that we have defined the transformation, we can transform.

In the case of division, we transform 6 (as a cardinality of the initial group) into 3 (as a cardinality of the final group).

In the case of multiplication (the opposite direction) we transform 3 (as a cardinality of the initial group) into 6 (which is the cardinality of the final group).

Division:

2 groups of 6 elements \rightarrow 4 groups of 3 elements

Multiplication:

2 groups of 6 elements \leftarrow 4 groups of 3 elements (as an inverse operation of division)

Or

4 groups of 3 elements \rightarrow 2 groups of 6 elements

It's easy to see that the ratio defined by a fraction $\frac{2}{4}$ (that defines the transformation) is exactly the same as the ratio between the cardinality of the final group and the cardinality of the division's initial group $\frac{3}{6}$.

$$\frac{2}{4} = \frac{3}{6} \tag{27}$$

$$\frac{\text{number of initial groups}}{\text{number of final groups}} = \frac{\text{cardinality of final group}}{\text{cardinality of initial group}} \tag{28}$$

In the case of division, we transform 6 through the ratio represented by fraction $\frac{2}{4}$ and as a result we get 3.

$$6 \cdot \frac{2}{4} = 3 \tag{29}$$

$$\text{cardinality of initial group} \cdot \frac{\text{number of initial groups}}{\text{number of final groups}} = \text{cardinality of final group} \quad (30)$$

Note, that the fraction (in this case $\frac{2}{4}$) does not clearly talk about the size of the initial group, which it is able to transform into the final group. It only represents a certain ratio, which we interpret as a ratio between the cardinality of the final group and the cardinality of the initial group. By default, we assume that the number of elements (cardinality) of the initial group is 1. Saying two, we understand that these are two entities, which we are dividing into four parts. In fact, what is explicitly presented, is just the number of the initial groups - 2 and the number of the final groups - 4 of this transformation and the ratio between them $\frac{2}{4}$. Let's compare the examples below in each of them we are using the same fraction $\frac{2}{4}$ to transform different numbers.

$$6 \cdot \frac{2}{4} = 3 \quad (31)$$

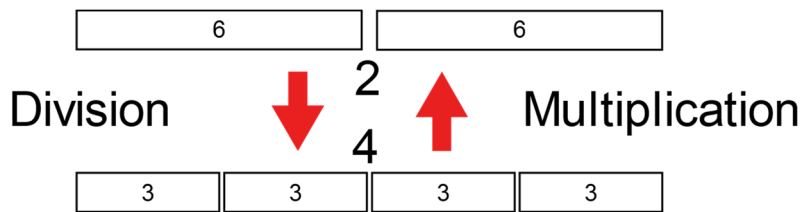

Figure 14. 2 groups of 6 <-> 4 groups of 3.

$$10 \cdot \frac{2}{4} = 5 \quad (32)$$

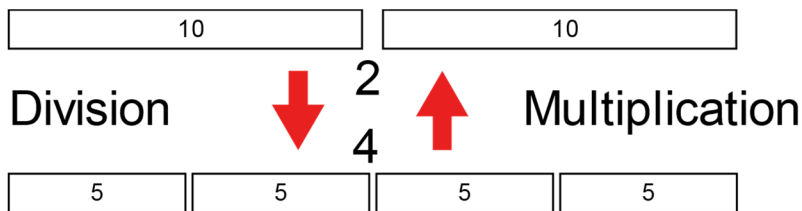

Figure 15. 2 groups of 10 <-> 4 groups of 5.

$$2 \cdot \frac{2}{4} = 1 \quad (33)$$

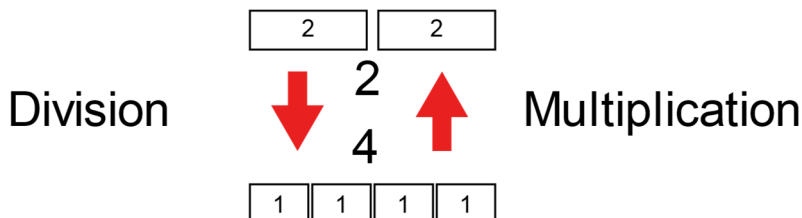

Figure 16. 2 groups of 2 <-> 4 groups of 1.

In general, we can say that the fraction $\frac{2}{4}$ represents:

- a) the transformation of **two** groups into **four** groups

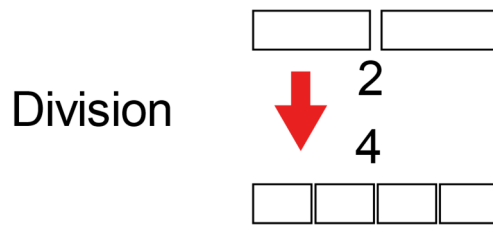

Figure 17. Transformation of 2 groups into 4 groups.

- b) the ratio between the cardinality of the **final** group , and the cardinality of the **initial** group

$$\frac{\text{input}}{\text{input}} = \frac{2}{4}$$

Figure 18. The ratio between cardinalities equals the fraction that performs the transformation.

But at the same time, it represents an inverse operation, which is multiplication (reading it in the opposite direction from the bottom up) (Figure 13). In this operation it represents:

- a) the transformation of **four** groups into **two** groups

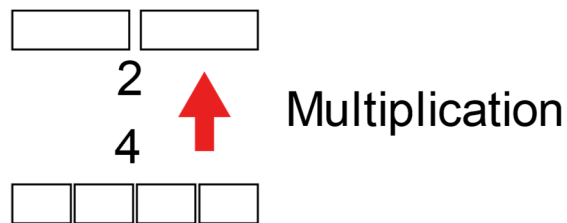

Figure 19.

- b) the ratio between the cardinality of the final group , and the cardinality of the initial group . But in this case, we are progressing from the bottom up, and transforming in **reverse**, that is why the fraction should be inverted.

$$\frac{\text{input}}{\text{input}} = \frac{4}{2}$$

Figure 20.

4. A fraction as an element that can transform itself.

If in the discussed example, we will take 4 as the cardinality of the initial group, then as a result we'll get the cardinality of the final group, which will be 2.

$$4 \cdot \frac{2}{4} = 2 \quad (34)$$

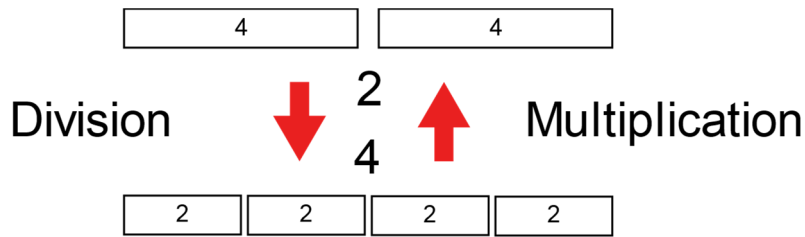

Figure 21.

As we can see in this case the fraction $\frac{2}{4}$ not only tells us about the transformation of two groups into four groups (red arrow in Figure 22), but also allows us to transform the cardinality of the initial group 4 (denominator), into the cardinality of the final group 2 (numerator) (blue arrow in Figure 22)

$$4 \cdot \frac{2}{4} = 2$$

Figure 22.

From the above example, we can see that the fraction has this feature, that it can transform its own elements, one into another. In this case the fraction $\frac{2}{4}$ transforms $4 \rightarrow 2$.

In the general case of fractions

$$\frac{\text{numerator}}{\text{denominator}} \tag{35}$$

This allows us to transform

$$\text{denominator} \rightarrow \text{numerator} \tag{36}$$

5. Unification of multiplication and division.

From the examples presented above, it can be clearly seen, that both multiplication and division can be reduced to one arithmetic operation – **transformation**.

By performing **division**, we begin with a certain number of groups containing a certain cardinality of elements, and we transform them into a different number of groups, containing a different cardinality of elements.

By performing **multiplication**, we begin from a certain number of groups, containing a certain cardinality of elements, and we are transforming them into a different number of groups, containing a different cardinality of elements.

Both operations tell us exactly about the same kind of operation - transformation. It means that they are not different operations but the same. The transformation operation (multiplication and division) keeps the ratio in this way, so it increases (or decreases) the number of groups during the transformation **n-times**, decreasing (or increasing) the number of elements in those groups in the same proportion - **n-times**.

In case of multiplication:

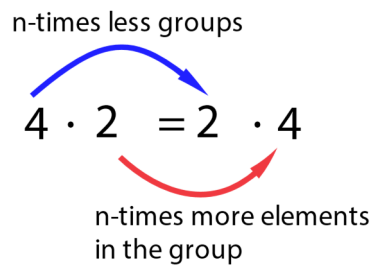

Figure 23.

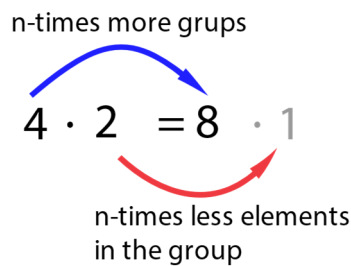

Figure 24.

In case of division:

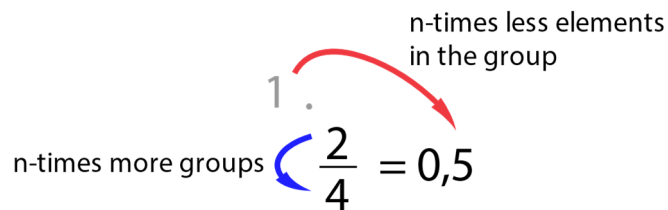

Figure 25.

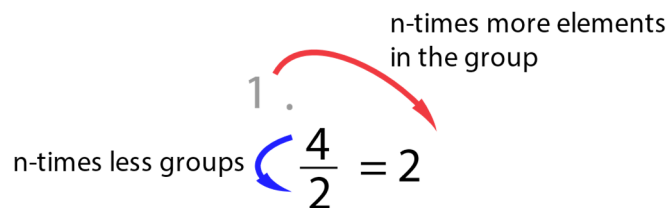

Figure 26.

The gray 1's are usually omitted in the mathematical notation, however, to fully illustrate the transformations taking place, it was useful to visualize them.

6. Commutative property of multiplication

Treating multiplication as a transformation of groups of elements into a different number of groups of elements, it is possible to visualize the commutative property of multiplication. Note, that in each of the transformations we are keeping the proportion

$$\frac{\text{number of initial group}}{\text{number of final group}} = \frac{\text{cardinality of final group}}{\text{cardinality of initial group}} \quad (37)$$

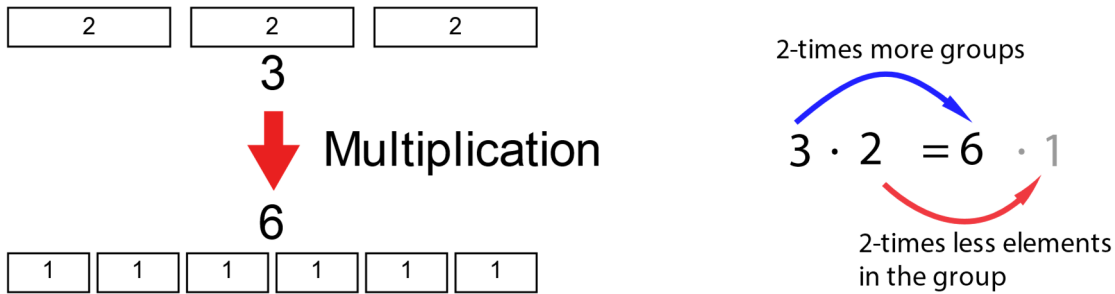

Figure 27.

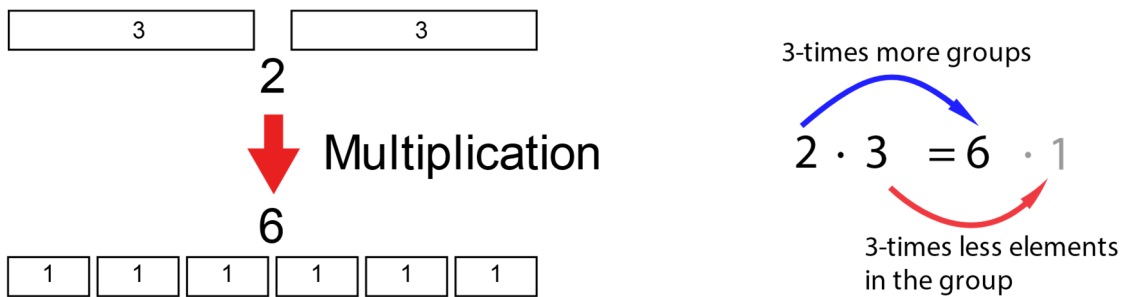

Figure 28.

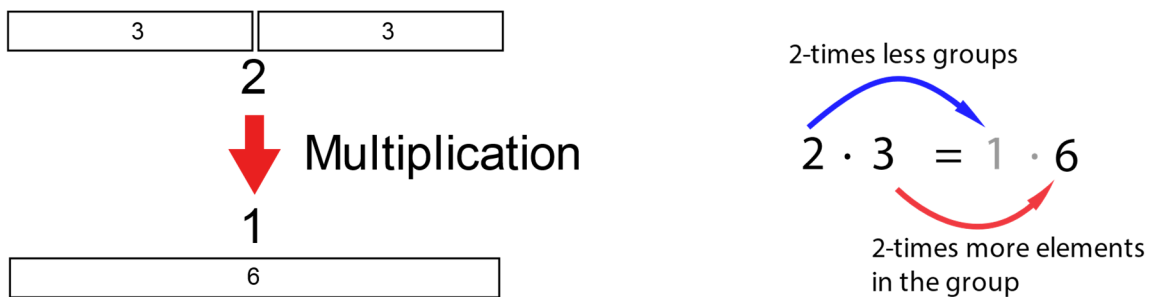

Figure 29.

7. Introduction of the selection operation.

The presented above operations of division and multiplication keep the quantity before and after the operation. It seems that they are only changing “the form” of numbers, keeping the total amount at the same time. When we sum up the length of the bars on the presented examples, their total length before and after the operation will be exactly the same. Multiplication and division require this property, but we can imagine another type of operation, which doesn’t have such a property.

For example: We have 7 elements and we are taking out 5 of them. So, we can say that we **selected** 5 elements out of 7.

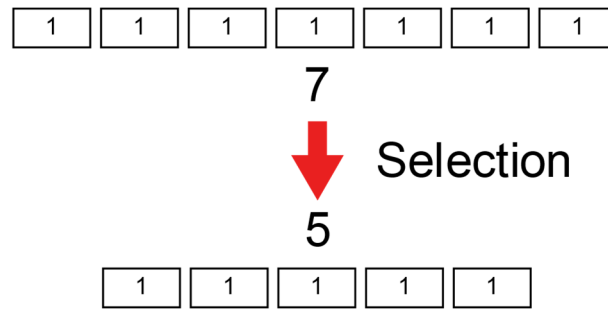

Figure 30

In case of selection we can have another possibility. We can select, not elements but a portion of the whole (Figure 30 and Figure 31).

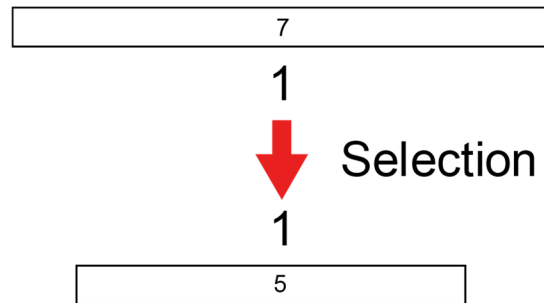

Figure 31

The operation of **selection** is different than multiplication and division in such a way, that it doesn't keep an initial amount, but changes it during the operation. The total quantity after the operation can be and usually is, different than it was before.

In case of the selection operation, not only the option to "scale down" is possible like $7 \rightarrow 5$, but also it is possible to "scale up" like $5 \rightarrow 7$. We will also call this operation, the selection. Even though it is not possible to select a bigger number of elements from a smaller group, we can interpret this kind of operation as our wish to select. For example, trying to select 7 elements, even though, only 5 of them are available.

8. The formal definition of transformation (multiplication, division and selection).

Let's define the following variables.

$g1$ – initial number of equinumerous groups of transformation

$c1$ – cardinality of elements in every one of these initial groups

$g2$ – final number of equinumerous groups of transformation

$c2$ – cardinality of elements in every one of those final groups

We will call the **Transformation (T)**, the operation that converts the pair $(g1, c1)$ into pair $(g2, c2)$.

$$T(g1, c1) \rightarrow (g2, c2) \quad (38)$$

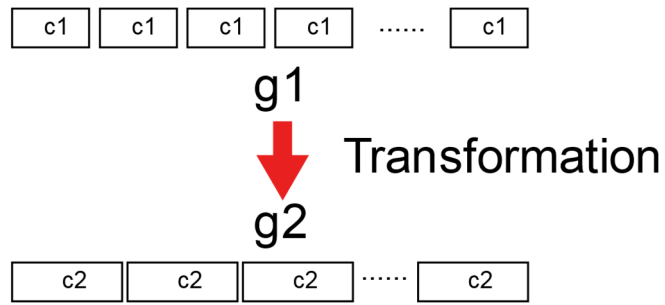

Figure 32.

We will call the **Transformation coefficient (p)** (or **transformative element**) the ratio defined below:

$$p = \frac{g2}{g1} \quad (39)$$

$$g1 \cdot p = g2 \quad (40)$$

Or

$$p = \frac{c2}{c1} \quad (41)$$

$$c1 \cdot p = c2 \quad (42)$$

Note that p transforms the number of groups or its cardinality depending on the case.

We will call the transformation **complete** if the following condition is **true**:

$$\forall (g1, g2, c1, c2) (g1 \cdot c1 = g2 \cdot c2) \quad (43)$$

(formally: $g1$ -times sum of $c1 = g2$ -times sum of $c2$)

In the case of full transformation, the proportion between the number of groups and the cardinality of groups is kept (44).

$$\frac{g1}{g2} = \frac{c2}{c1} \quad (44)$$

$$\frac{\text{number of initial groups}}{\text{number of final groups}} = \frac{\text{cardinality of final group}}{\text{cardinality of initial group}} \quad (45)$$

We will call the transformation **incomplete** if the following condition is **false**:

$$\forall (g1, g2, c1, c2) (g1 \cdot c1 = g2 \cdot c2) \quad (46)$$

We will call **multiplication** the kind of **complete transformation** when $g_2 = 1$.

$$T(g_1, c_1) \rightarrow (1, c_2) \quad (47)$$

then,

$$g_1 \cdot c_1 = 1 \cdot c_2 \quad (48)$$

$$c_1 \cdot g_1 = c_2 \quad (49)$$

Transformation coefficient p is:

$$p = \frac{c_2}{c_1} \quad (50)$$

$$p = \frac{g_1}{1} \quad (51)$$

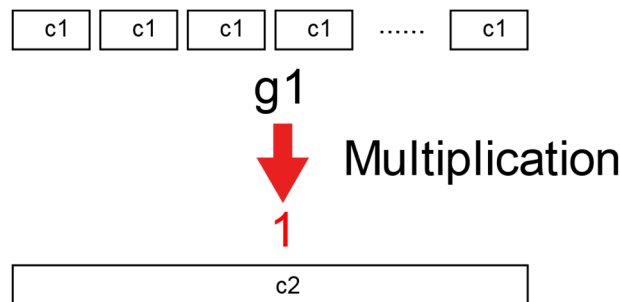

Figure 33.

We will call **multiplication** the kind of **complete transformation** when $c_2 = 1$.

$$T(g_1, c_1) \rightarrow (g_2, 1) \quad (52)$$

then,

$$g_1 \cdot c_1 = g_2 \cdot 1 \quad (53)$$

$$g_1 \cdot c_1 = g_2 \quad (54)$$

Transformation coefficient p is:

$$p = \frac{g_2}{g_1} \quad (55)$$

$$p = \frac{c_1}{1} \quad (56)$$

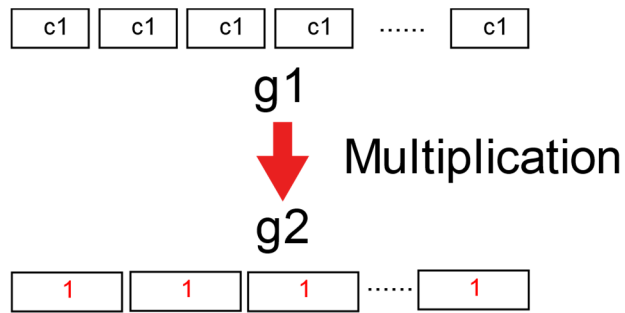

Figure 34.

We will call **division** the kind of **complete transformation** when $g1 = 1$.

$$T(\mathbf{1}, c1) \rightarrow (g2, c2) \tag{57}$$

$$1 \cdot c1 = g2 \cdot c2 \tag{58}$$

$$c1 = g2 \cdot c2 \tag{59}$$

$$\frac{c1}{g2} = c2 \tag{60}$$

Transformation coefficient p is:

$$c1 \cdot \frac{1}{g2} = c2 \tag{61}$$

$$\frac{1}{g2} = \frac{c2}{c1} \tag{62}$$

$$p = \frac{1}{g2} \tag{63}$$

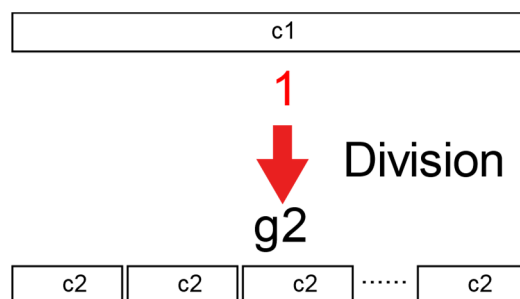

Figure 35.

We will call **division** the kind of **complete transformation** when $c_1 = 1$.

$$T(g_1, 1) \rightarrow (g_2, c_2) \quad (64)$$

$$g_1 \cdot 1 = g_2 \cdot c_2 \quad (65)$$

$$g_1 = g_2 \cdot c_2 \quad (66)$$

$$\frac{g_1}{c_2} = g_2 \quad (67)$$

Transformation coefficient p is:

$$g_1 \cdot \frac{1}{c_2} = g_2 \quad (68)$$

$$p = \frac{1}{c_2} \quad (69)$$

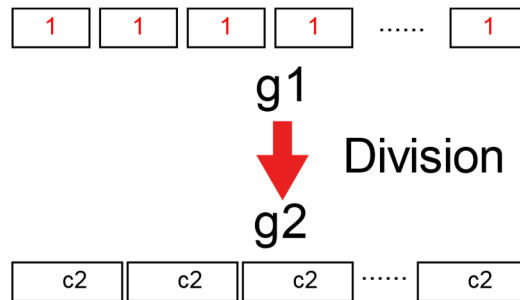

Figure 36.

We will call **selection** the kind of **incomplete transformation** when $g_1 = g_2 = 1$.

$$T(1, c_1) \rightarrow (1, c_2) \quad (70)$$

Then,

$$\frac{c_2}{c_1} = \frac{c_2}{c_1} \quad (71)$$

$$c_1 \cdot \frac{c_2}{c_1} = c_2 \quad (72)$$

Transformation coefficient p is:

$$p = \frac{c_2}{c_1} \quad (73)$$

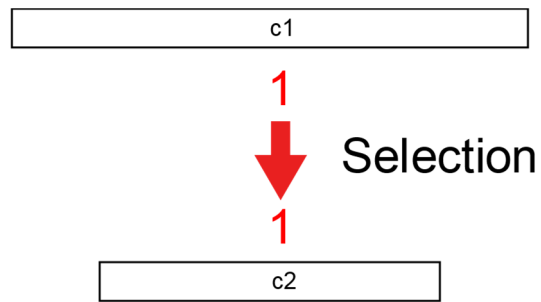

Figure 37.

We will call **selection** the kind of **incomplete transformation** when $c1 = c2 = 1$.

$$T(g1,1) \rightarrow (g2,1) \tag{74}$$

Then,

$$\frac{g2}{g1} = \frac{g2}{g1} \tag{75}$$

$$g1 \cdot \frac{g2}{g1} = g2 \tag{76}$$

Transformation coefficient p is:

$$p = \frac{g2}{g1} \tag{77}$$

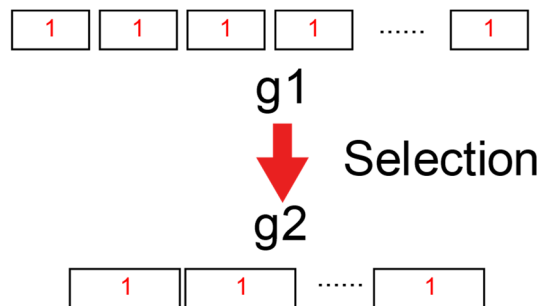

Figure 38.

Multiplication, division and selection are just different forms of the defined in (38) **transformation**.

Name of the operation	Definition of the transformation	The transformation coefficient (p)	The transformation $c1 \rightarrow c2$ $g1 \rightarrow g2$
Transformation (general form)	$T(g1, c1) \rightarrow (g2, c2)$	$p1, p2$	$c1 \cdot p1 = c2$ $g1 \cdot p2 = g2$
Multiplication	$T(g1, c1) \rightarrow (1, c2)$	$\frac{g1}{1}$	$c1 \cdot \frac{g1}{1} = c2$
Multiplication	$T(g1, c1) \rightarrow (g2, 1)$	$\frac{c1}{1}$	$g1 \cdot \frac{c1}{1} = g2$
Division	$T(1, c1) \rightarrow (g2, c2)$	$\frac{1}{g2}$	$c1 \cdot \frac{1}{g2} = c2$
Division	$T(g1, 1) \rightarrow (g2, c2)$	$\frac{1}{c2}$	$g1 \cdot \frac{1}{c2} = g2$
Selection	$T(1, c1) \rightarrow (1, c2)$	$\frac{c2}{c1}$	$c1 \cdot \frac{c2}{c1} = c2$
Selection	$T(g1, 1) \rightarrow (g2, 1)$	$\frac{g2}{g1}$	$g1 \cdot \frac{g2}{g1} = g2$

Table 1

9. Whether $\frac{1}{2}$ is equal to $\frac{2}{4}$?

We shall check what we will get from the comparison of $\frac{1}{2}$ and $\frac{2}{4}$ treated as transformations.

$\frac{1}{2}$	
$T(1, c1) \rightarrow (g2, c2)$ $T(1, 1) \rightarrow (2, c2)$ $c1 \cdot \frac{1}{g2} = c2$ $1 \cdot \frac{1}{2} = c2$ $c2 = \frac{1}{2}$ $T(1, 1) \rightarrow (2, \frac{1}{2})$	 <p style="text-align: center;">Figure 39.</p>

Table 2

$\frac{2}{4}$	
$T(g1,1) \rightarrow (g2, c2)$ $T(2,1) \rightarrow (4, c2)$ $g1 \cdot \frac{1}{c2} = g2$ $2 \cdot \frac{1}{c2} = 4$ $\frac{1}{c2} = \frac{4}{2}$ $c2 = \frac{2}{4}$ $c2 = \frac{1}{2}$ $T(2,1) \rightarrow \left(4, \frac{1}{2}\right)$	 <p style="text-align: center;"><i>Figure 40.</i></p>
<p>Or</p> $T(1, c1) \rightarrow (g2, c2)$ $T(1,2) \rightarrow (4, c2)$ $c1 \cdot \frac{1}{g2} = c2$ $2 \cdot \frac{1}{4} = c2$ $c2 = \frac{2}{4}$ $c2 = \frac{1}{2}$ $T(1,2) \rightarrow \left(4, \frac{1}{2}\right)$	 <p style="text-align: center;"><i>Figure 41.</i></p>

Table 3

As we can see, in each example, the result of the division $c2$ is equal to $\frac{1}{2}$. From this perspective, we can say that $\frac{1}{2} = \frac{2}{4}$, but it is also easy to see that each of the presented above transformations are **different!** This indicates the difference between $\frac{1}{2}$ and $\frac{2}{4}$. A proposal on how to solve this issue will be presented later in this work.

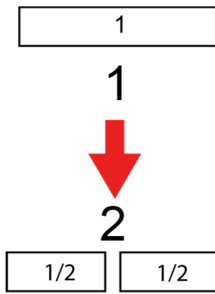
10. Division by zero as a transformation.

Let's try to analyze $\frac{1}{0}$ as a transformation.

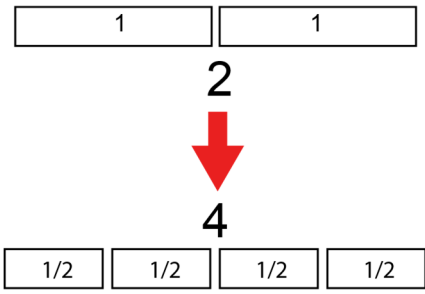
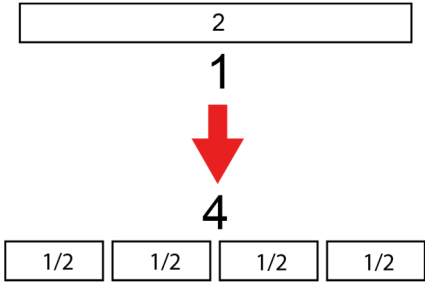
$T(1, c1) \rightarrow (g2, c2)$ $T(1, 1) \rightarrow (0, c2)$ $c1 \cdot \frac{1}{g2} = c2$ $1 \cdot \frac{1}{0} = c2$ $c2 = \frac{1}{0}$ $T(1, 1) \rightarrow \left(0, \frac{1}{0}\right)$	 <p style="text-align: center; margin-top: 10px;">Figure 42.</p>
--	--

Table 4

As we can see, the result of the transformation $\frac{1}{0}$ is $c2 = \frac{1}{0}$. What can we conclude from this result? This is something that we cannot cope with very much, we cannot divide 1 into zero groups, any attempt to divide $\frac{1}{0}$ leads us again to the symbol $\frac{1}{0}$. The question is, do we really need to do this? After comparing our transformation here to the examples with $\frac{1}{2}$ or $\frac{2}{4}$ above, we see that we are able to visualize this transformation, but we have a problem visualizing its result. **Maybe the core sense of division is NOT, as modern mathematics understands it, the result $c2$, but just a transformation itself?** One could say that we do not really have a problem with the symbol $\frac{1}{0}$. It seems the problem only arises, when we are trying to calculate it, when we want to reduce it to a number of a form 5, 7 or something similar to this. How to deal with $\frac{1}{0}$ will be explained later in this work.

11. Whether $\frac{1}{2}$ is equal $\frac{1}{2}$?

If we think about two different transformations, which are demonstrated in the examples below, the answer to this question would be no. Let us start from classical division, exactly as it was presented above. Treating $\frac{1}{2}$ as a division transformation we will get:

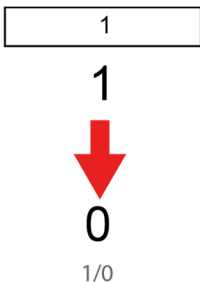
$\frac{1}{2}$ as a **division**:

$\frac{1}{2}$ as a division	
$T(1, c1) \rightarrow (g2, c2)$ $T(1, 1) \rightarrow (2, c2)$ $c1 \cdot \frac{1}{g2} = c2$	

$1 \cdot \frac{1}{2} = c2$ $c2 = \frac{1}{2}$ $T(1,1) \rightarrow \left(2, \frac{1}{2}\right)$	 <p style="text-align: center;">Figure 43.</p>
--	--

Table 5

But $\frac{1}{2}$ we can also understand as a **selection**:

$\frac{1}{2}$ as a selection	
$T(g1,1) \rightarrow (g2,1)$ $T(2,1) \rightarrow (1,1)$ $g1 \cdot \frac{g2}{g1} = g2$ $2 \cdot \frac{1}{2} = 1$	 <p style="text-align: center;">Figure 44.</p>
<p>Or</p> $T(1, c1) \rightarrow (1, c2)$ $T(1,2) \rightarrow (1,1)$ $c1 \cdot \frac{c2}{c1} = c2$ $2 \cdot \frac{1}{2} = 1$	 <p style="text-align: center;">Figure 45.</p>

Table 6

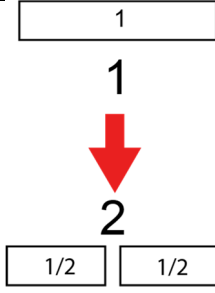
Note, that the ratio $\frac{1}{2}$ has such a **feature**, which does the transformation from two initial groups $g1$ into one final group $g2$ (Figure 44.) or from a doubled initial cardinality $c1$ into a single final cardinality $c2$ (Figure 45.)

$$2 \cdot \frac{1}{2} = 1$$

Figure 46.

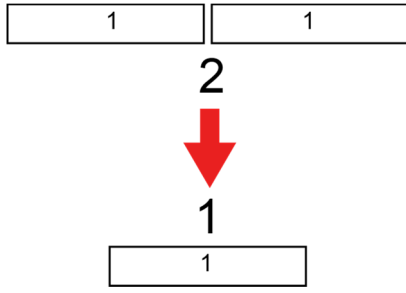
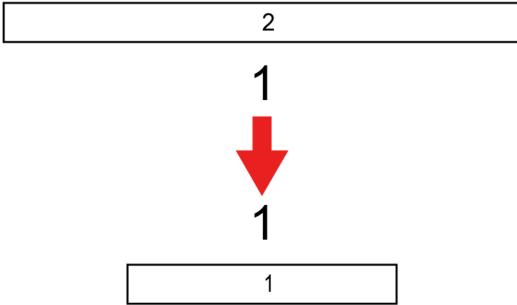
Is there a way to reconcile such different results with different possibilities of interpretation between division and selection?

What is exactly the same in all examples above, is that the coefficient p - ratio, which does the transformation in both cases is equal to $\frac{1}{2}$.

$$T(1, c1) \rightarrow (g2, c2) \tag{78}$$

In case of **division** initial $c1 = 1$ is transformed by $p = \frac{1}{2}$ into $c2 = \frac{1}{2}$.

$$1 \cdot \frac{1}{2} = \frac{1}{2}$$

Figure 47.

In case of **selection** initial $g1 = 2$ is transformed by $p = \frac{1}{2}$ into $g2 = 1$ (Figure 44.). It is the same in case of cardinality transformation (Figure 45.).

$$2 \cdot \frac{1}{2} = 1$$

Figure 48.

The difference between division and selection, as presented in the examples above is, that in case of division we read fractions from the top-down. One is **divided** by two and we get half.

$$\frac{1}{2} \downarrow$$

Figure 49.

While in case of **selection**, we read fractions from the bottom-up. From two, we are selecting one. We are selecting half.

$$\frac{1}{2} \uparrow$$

Figure 50.

In both cases, we are talking about **halves**. In the first case “**dividing in halves**” in the second “**selecting half**”.

What is the most important is the **ratio**, which in every example is the same. The ratio, in each case that we have, is between the **final** result of the transformation and the **initial** value which we started our transformation from.

$$\frac{1}{2} = \frac{1}{2} = \frac{1}{2}$$

Figure 51.

To unify our understanding of $\frac{1}{2}$, this symbol needs to be interpreted as a **ratio between two states of a certain transformation, the final state as a numerator and the initial state as a denominator.**

12. What is the meaning of the ratio's numerator and denominator during the transformation?

The ratio, which is the “transformative element” does a conversion of an initial element into a final result of the transformation. We can say that the initial element is the entity that we are starting with, but is also the element that already existed. That is why in the following parts of this work we will call it the **measure** (base measure), which represents the initial state and something that is given. Then, this base measure (initial element) is transformed by the ratio into the final element, thus the result of the transformation. This final element represents something that we got during the transformation, as a result of the conversion. It can also represent something that we want to get, are expecting to have, and want, as a result of transformation. We will call this element **value** (result value), the result of the transformation and expected value.

$$\text{measure} \cdot \frac{\text{value}}{\text{measure}} = \text{value}$$

Figure 52.

Two simple examples are demonstrated below:

- a) Division $\frac{3}{4}$ (division of three by four)

transformation

$$1 \cdot \frac{3}{4} = \frac{3}{4}$$

ratio

Figure 53.

Division $\frac{3}{4}$ means a transformation that converts **three** groups of **one**, and divides them into **four** groups of $\frac{3}{4}$.

b) Selection $\frac{3}{4}$ (selection three out of four)

transformation

$$4 \cdot \frac{3}{4} = 3$$

ratio

Figure 54.

Selection $\frac{3}{4}$ means a transformation, where, out of **four** elements **three** are selected. As we can see, the ratio that is performing this transformation is again $\frac{3}{4}$ and it is the ratio between the final value (**three**), and the base measure (**four**).

As seen in both cases, the ratio $\frac{3}{4}$ is performing different transformations, but in each case the ratio between the final **value** (result of transformation) and the base **measure** (what we started our transformation from) is kept. In both cases the ratios are the same.

13. The ratio as a natural form of the number

What number, is represented by the point below?

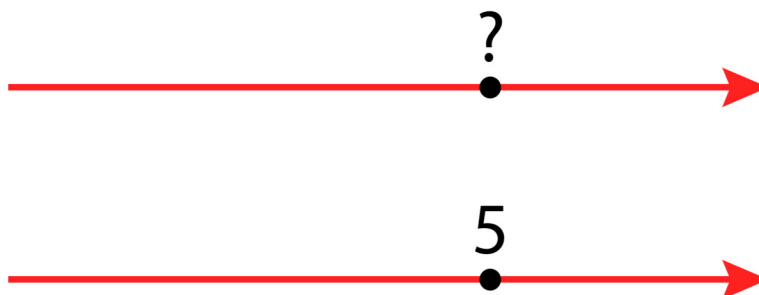

Is this 5?

Or maybe it is 7?



Or maybe -2?



The number itself without any „reference point” has no meaning at all! To understand it’s meaning we need to know what is 1.



Talking about numbers we are always using some, the more or less explicitly presented, reference point, that we are “referring this number to”. By saying 5 what we really mean is 5 in reference to 1. By saying -2 we really mean -2 in reference to 1. It not always needs to be one. It can be any other number including zero itself. To express any number, we need another number as a reference point. So, **number without any reference point has no meaning at all**. Conclusion is simple: **We need always two numbers to have the number**.

The number is always a certain value in relation to a certain “base” measure. The most natural of its form is the fraction – the ratio. It tells us what its value is, in relation to something that we treat as a base measure.

The natural form of the number is its **value** in relation to a certain **measure**.

$$\frac{value}{measure}$$

The available number of elements, or the initial quantity is represented by base **measure**. The number of elements or the quantity that we are selecting, or want to get, is represented by the **value**. The amount that this number defines is related to its own base measure. Even so, we are referring to natural numbers 2,5,7, etc. then we are always implicitly thinking about relations to the measure accepted as a standard base that is 1. Respectively 2 means $\frac{2}{1}$ (two times 1, two in relation to 1), 5 means $\frac{5}{1}$ (five times 1, five in relation to 1) etc. Even irrational numbers like $\sqrt{2}$, implicitly are in relation to measure 1, and in fact $\sqrt{2}$ means $\frac{\sqrt{2}}{1}$, although usually it is not directly stated. So, every number shows its value in relation to more (in case of fractions) or less (in case of non-fractions) explicitly presented measures. In the case of fractions, measures can be very different and there does not always need to be one.

For example, $\frac{1}{2}$ can mean ratio:

- a) In case of division, it is the ratio between the effect of this division, and the beginning of this division, which is something that has been divided.

$$\frac{\text{effect of division (value)}}{\text{what was divided (measure)}} \quad (79)$$

One divided by 2:

$$1 : 2 = \frac{1}{2} \quad (80)$$

$$\frac{\text{effect of division (value)}}{\text{what was divided (measure)}} = \frac{1}{2} = \frac{1}{2} \quad (81)$$

- b) In case of selection, it is the ratio between the effect of selection and the initial content that we selected from.

$$\frac{\text{effect of selection (value)}}{\text{what we selected from (measure)}} \quad (82)$$

In this case we selected 1 out of 2.

$$\frac{\text{effect of selection (value)}}{\text{what we selected from (measure)}} = \frac{1}{2} \quad (83)$$

To visualize the ideas presented in this work, let us graph numbers as a fraction, the ratio of *value* to *measure*. Each number can be presented in this form, on a graph that shows the relation between *measure* on its horizontal axis and *value* on its vertical axis.

Specific numbers in this form $\frac{v}{m}$ (*v*—*value*, *m* — *measure*) will be represented by the points with coordinates (*m*, *v*). On the graph below, the number $\frac{2}{3}$ is presented (*value*=2, in relation to *measure*=3), at the point of coordinates (3,2).

Remark: Most of the graphs in the remainder of this work, for an easier presentation and understanding, are usually limited to presenting ideas only to the extent where both *values* and *measures* are greater than, or equal to, zero. However, the ideas presented have full applicability on the full plain and can be also presented in the range < 0 .

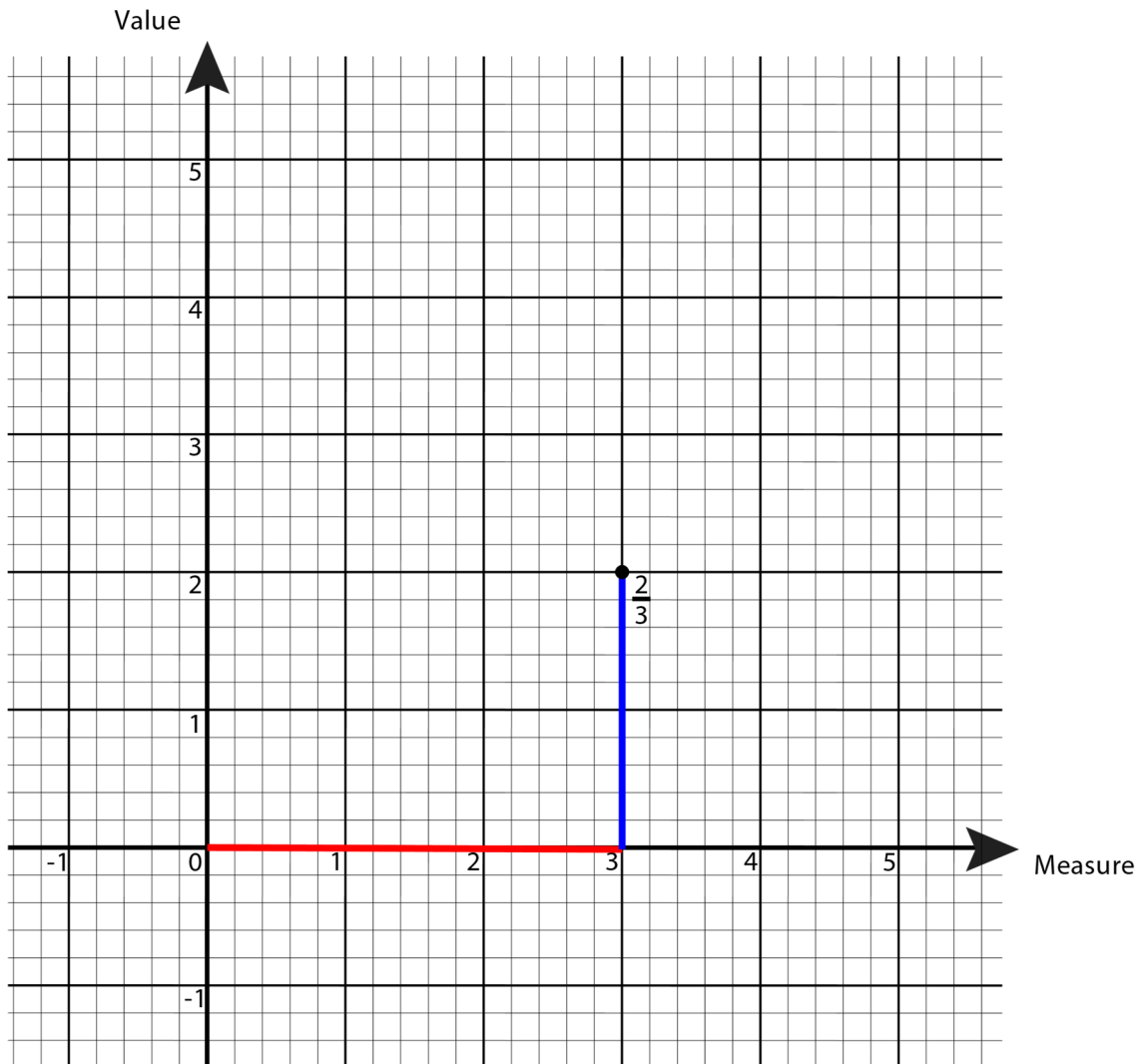

Figure 55.

14. Definition of n-times ratio set

Let us name **n-times ratio set** (or simpler n-times) the set of all such ratios so that they are equal to $\frac{n}{1}$.

For each n-times ratio set, let's define value $k_n = \frac{n}{1}$.

For example:

Half-times ($\frac{1}{2}$ - times) will be all ratios equal to $\frac{1}{2}$ which are for e.g. $\frac{1}{2}, \frac{2}{4}, \frac{3}{6}, \frac{50}{100}$ etc.

One-times - $\frac{1}{1}, \frac{2}{2}, \frac{3}{3}, \frac{4}{4}, \frac{100}{100} \dots$

Two-times - $\frac{2}{1}, \frac{4}{2}, \frac{6}{3}, \frac{8}{4}, \frac{200}{100} \dots$

Three-times - $\frac{3}{1}, \frac{6}{2}, \frac{9}{3}, \frac{12}{4}, \frac{300}{100} \dots$

And so on.

Below is the graph for **half-times** ($n = \frac{1}{2}$) with points that represent the ratio $\frac{n}{1}$ and point $k_n = k_{\frac{1}{2}} = \frac{1}{2}$. On the graph it is visible that the fractions (ratios) $\frac{1}{2}$ and $\frac{2}{4}$ represent a half-times ratio set.

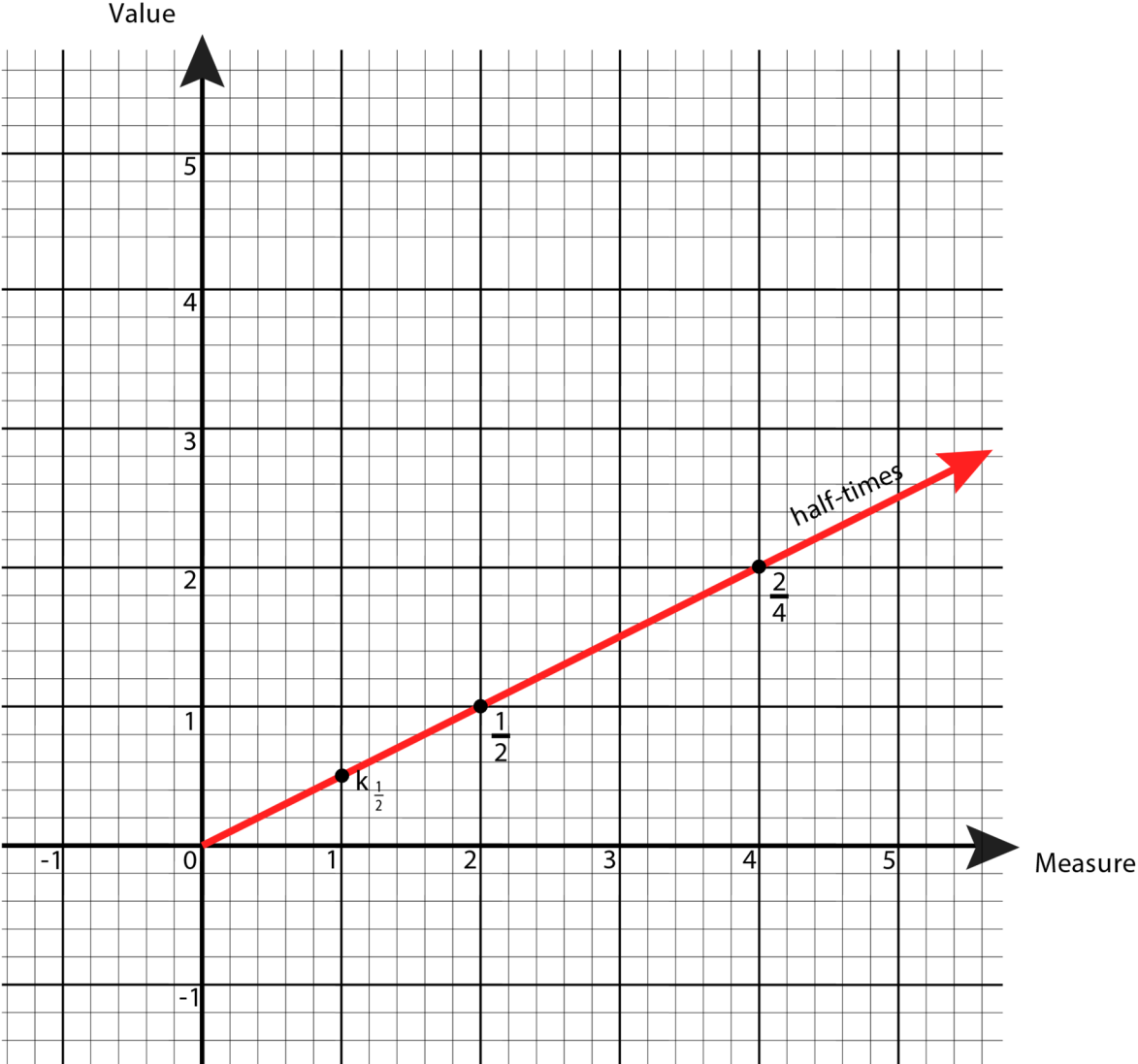

Figure 56.

The following graph presents a few other n-times ratio sets with marked points k_n .

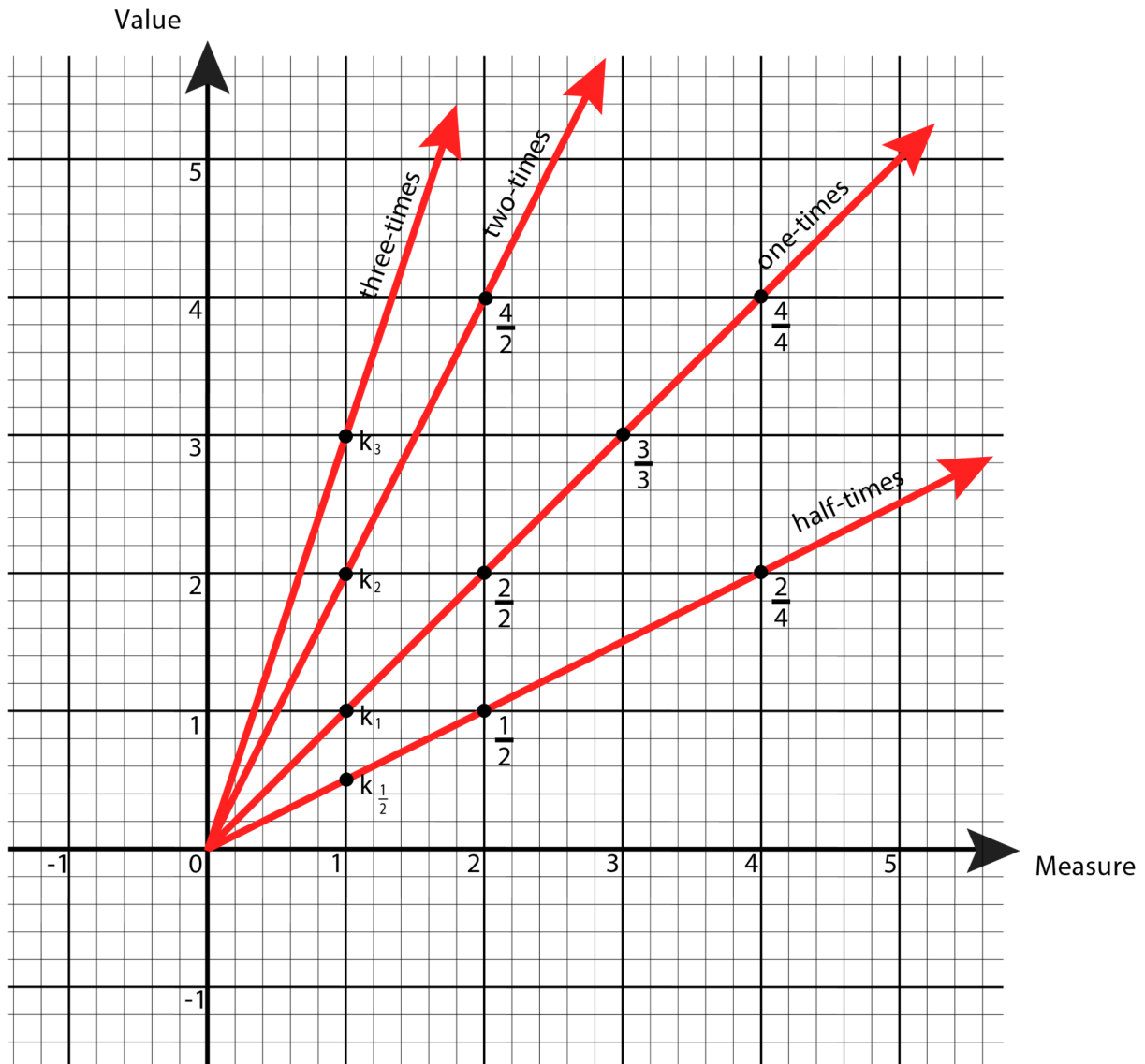

Figure 57.

15. Interpretation of the point on the graph of ratios.

Each point on the graph of ratios represents a certain **number in its real fractional (rational) form**, which is the ratio $\frac{\text{value}}{\text{measure}}$. This ratio can be understood as a transformative element, for example, in the operation of division or the operation of selection.

For ratio $\frac{2}{3}$ the operation of division looks like this:

transformation

$$1 \cdot \frac{2}{3} = \frac{2}{3}$$

↑
ratio

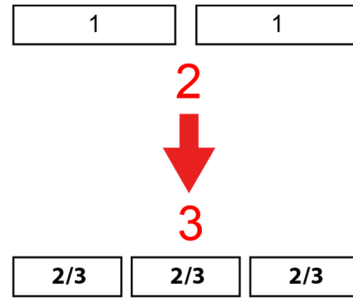

Figure 58.

Or in operation of selection:

transformation

$$3 \cdot \frac{2}{3} = 2$$

↑
ratio

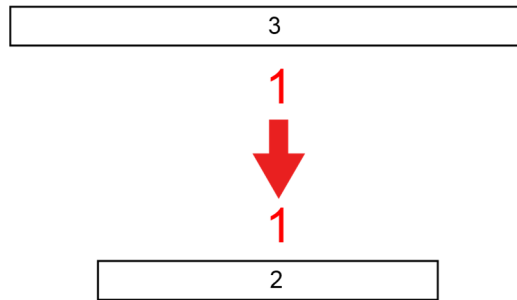

Figure 59.

Note that, the ratio between **the effect** (result) of the transformation, and what we have **started** from, is in each case the same.

$$\text{division} \rightarrow \frac{\frac{2}{3}}{1} = \frac{2}{3} \qquad \text{selection} \rightarrow \frac{2}{3} \qquad (84)$$

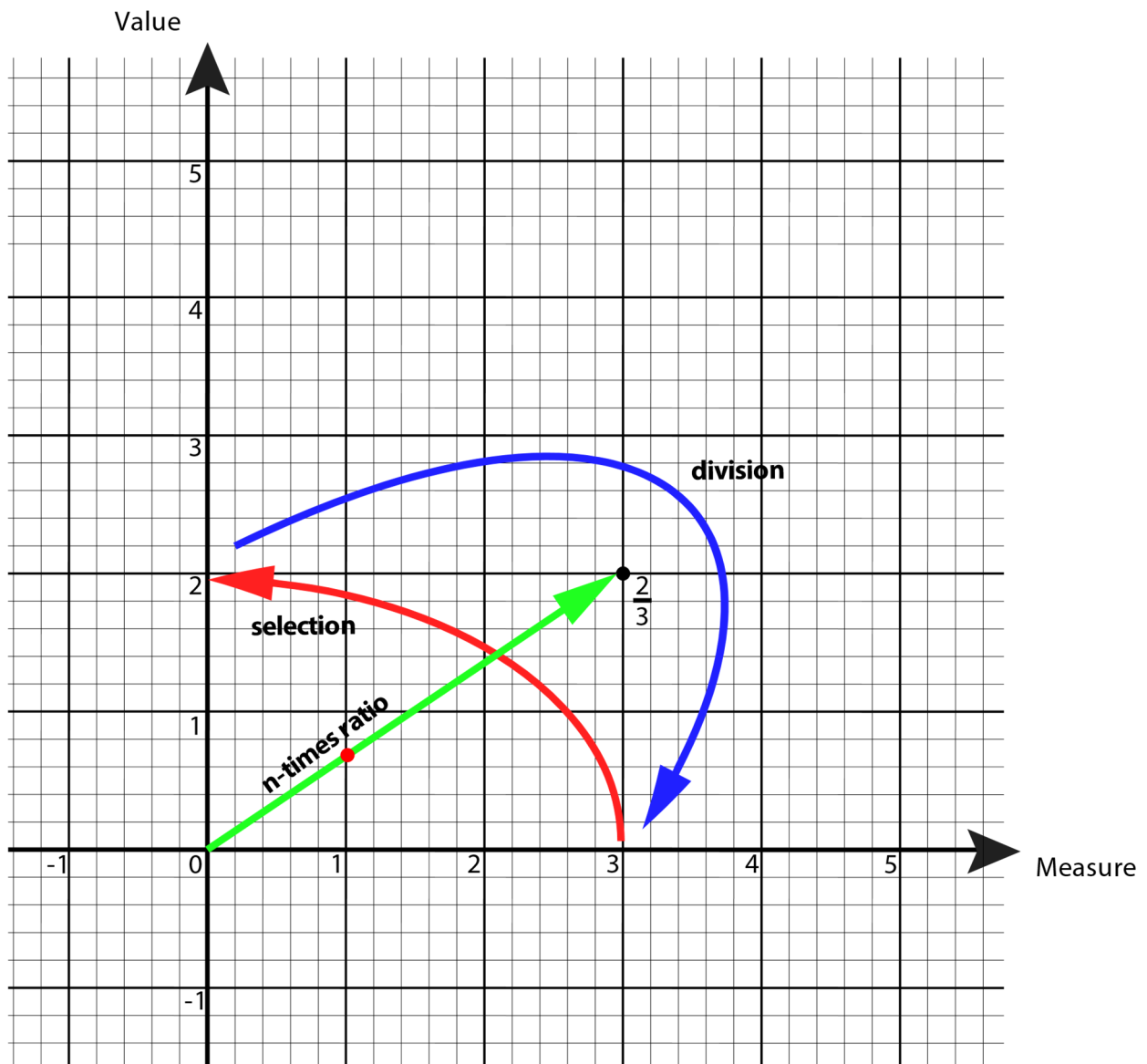

Figure 60.

Looking at the graph above it can easily be seen that $\frac{2}{3}$ can be interpreted in four different ways.

- 1) As a **division**, which is 2 divided by 3, and being more precise, the ratio, which is a transformative element of division, and represented by a **blue** arrow.
- 2) As a **selection**, in this case, we are selecting 2 out of 3, and being more precise, the ratio that is a transformative element of selection, and represented by a **red** arrow.
- 3) As a **representative of the certain n-times ratio set**, that we can project on the point $k_n = \frac{2}{3}$ (**red point**). This set is represented by a **green** arrow that goes through all the points of this **n-times ratio set**.
- 4) As a point, which is the **ratio between value and measure**, represented by the **black** point $\frac{2}{3}$, and it is the most correct and precise representation of the number.

16. The non-reality of the real line

The commonly accepted interpretation of numbers and fractions is limited only to the n-times ratio sets. This approach completely strips them apart from their diversity and real meaning.

Mathematicians projected all points from all particular n-times ratio sets onto their own points $k_n = \frac{n}{1}$. Note that all such points $\frac{n}{1}$, which are representing certain n-times ratio sets, are located on one line. This line is the **real axis**. So, for example:

$$\dots \frac{3}{6} = \frac{2}{4} = \frac{1}{2} = \frac{1}{2} = \frac{1}{2}$$

$$\dots \frac{4}{4} = \frac{3}{3} = \frac{2}{2} = \frac{1}{1} = 1$$

$$\dots \frac{6}{3} = \frac{4}{2} = \frac{2}{1} = 2$$

$$\dots \frac{9}{3} = \frac{6}{2} = \frac{3}{1} = 3$$

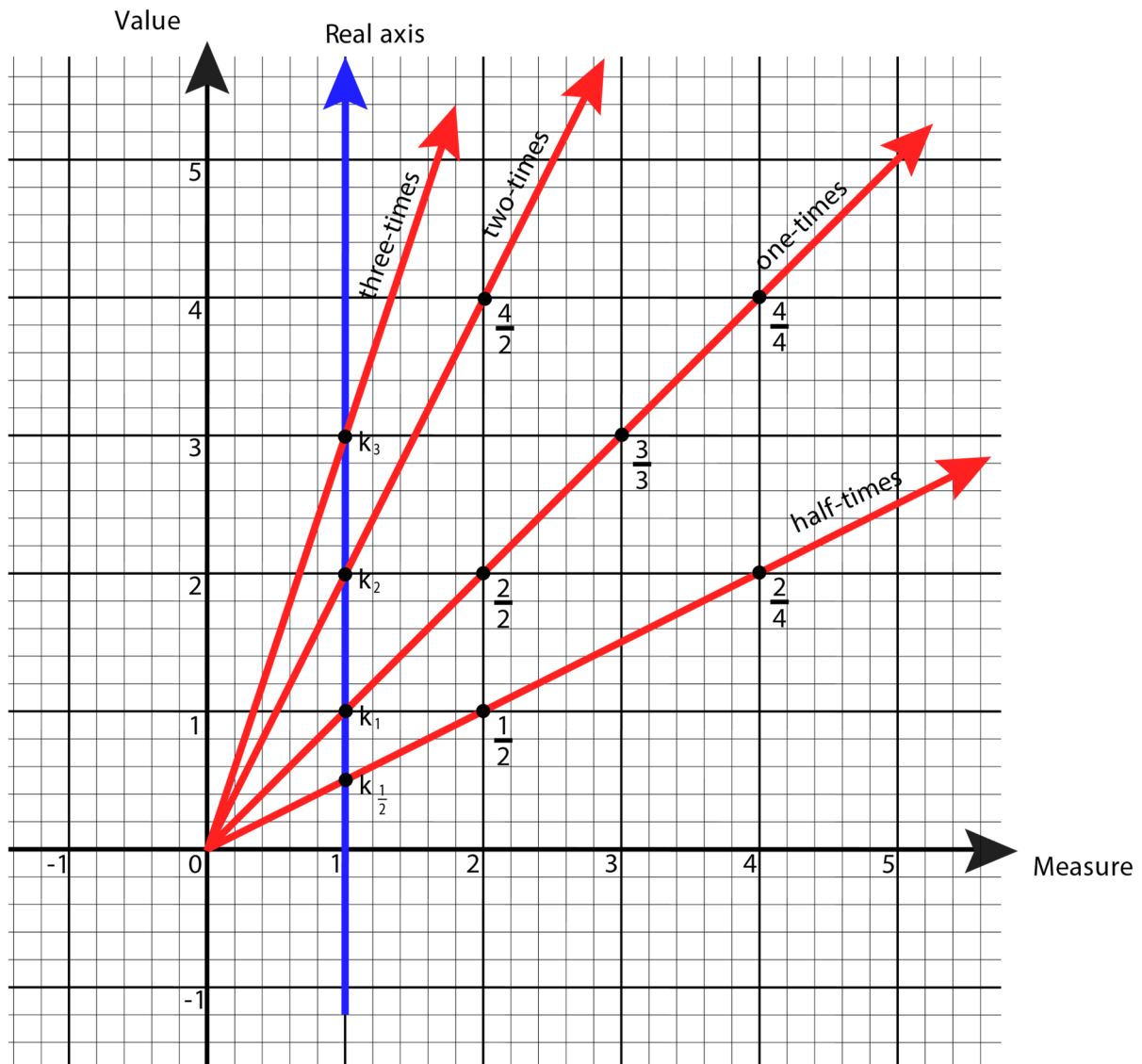

Figure 61.

On the graph above, the **real axis** is presented in blue. All points on this axis have **measure = 1**, in written form, this common classic understanding results in the fact, that we usually skip this **measure**. Instead of $\frac{x}{1}$ we just write x. The presented definition of the n-times ratio set is nothing other than, just the projection of certain points onto this blue axis (real line), which is done from the perspective of point $\frac{0}{0}$. For example, point $k_2 = \frac{2}{1}$ (simplified name 2) means in fact the **value = 2**, related to the **measure = 1**. It represents the **2-times ratio set** (Figure 61.) and all the points from this set (like for ex. $\frac{4}{2}, \frac{6}{3}, \frac{8}{4}, \dots$), projected onto the real line.

We are doing **unauthorized simplification** by not treating all the numbers as fractions $\frac{v}{m}$, which is the only correct way to look at them (Figure 61.). Usually, we are simplifying their meanings to real numbers $\frac{n}{1}$ that **represent them only**. For example, all points (numbers) that are representing the fractions $\frac{2n}{n}$ (like $\frac{4}{2}, \frac{6}{3}, \frac{8}{4}, \dots$) are projected onto the one and only point $\frac{2}{1}$ on the real axis. Even though each of them has additional meaning, which says something “extra” about the transformation. In each case, it is additional information about the ratio between different numbers, although their proportions are equal. By saying for example that $\frac{2}{1} = \frac{4}{2}$ we are **omitting** the fact, that in each of those ratios we are talking about different transformations. Instead of that, we are only thinking about **real numbers** that represent them or a particular n-times ratio set.

This situation is like watching the world through a window, we can perceive, that all that we see through that window (real axis $\frac{x}{1}$), exists within, while in fact it is behind. For example, the mountain, which is far away, may appear to have the same size as the home, which is closer. Exactly like $\frac{2000000000}{1000000000}$ which may look the same as $\frac{2000}{1000}$, because both of those fractions are represented by, and projected onto one point $\frac{2}{1}$, on the real axis.

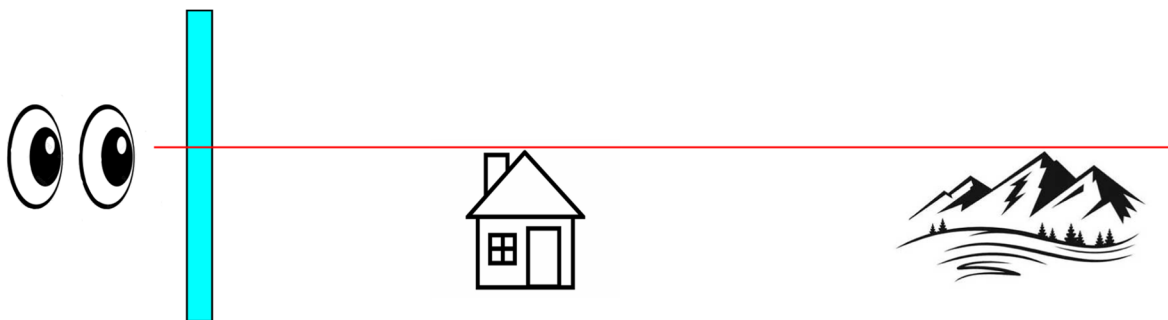

Figure 62.

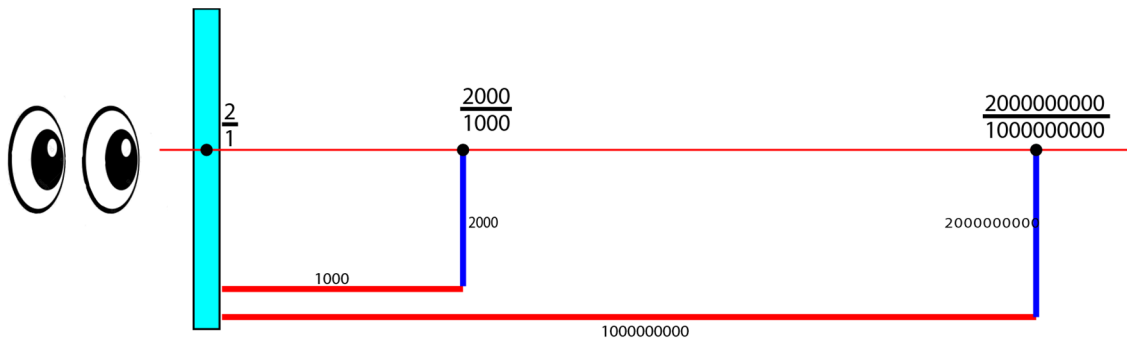

Figure 63

From the reasoning above, we can see that the real axis is in fact, not so “real” at all. It doesn’t “contain” all possible numbers, but only certain representations of them. This is also the reason why it is so difficult to understand “division by zero”. **All the numbers in the form of $\frac{x}{0}$, do not have their own representation on the real axis** (85). The axis, determined by all the numbers in the form of $\frac{x}{0}$, do **not cross real axis at all, because they are both parallel to each other** (this will be presented on one of the following graphs).

$$\frac{x}{0} = \frac{?}{1} \quad (85)$$

17. Problems with terminology.

Based on the proposed explanations, it seems that there is a conflict between the mathematics terminology, and the terminology proposed in this work. The first issue is with the term “rational numbers”. Definition from Wolfram MathWorld:

“A rational number is a number that can be expressed as a fraction $\frac{p}{q}$ where p and q are integers and $q \neq 0$.”

The presented definition is limited to integers for p , q and does not allow q to be equal 0. Those are **artificial limitations** and, in my opinion, should be removed. As a meaning, the term “ratio” is not only a mathematical fraction $\frac{p}{q}$, but it also can be understood as logical, intelligent, reasonable and rational. It would be good to use it for a representation of the numbers in the most extended way.

I propose to extend and to simplify its current definition, and to use the following meaning:

Rational number - any number represented by the fraction $\frac{value}{measure}$.

I don’t see any particular reason to limit the denominator, and not allow it to be zero. And I also do not see any reason to limit both the numerator and denominator to integers. This new definition would allow all the numbers to be represented by the ratio $\frac{value}{measure}$, and named rational numbers. Also, all the points on the graph representing the relation of value to measure could be called rational numbers. Following this logic, real numbers should be defined as:

Real number - any rational number that has the $measure = 1$, represented by the fraction $\frac{value}{1}$.

The consequence of the above definitions is that the set of **rational numbers** would be bigger than, and would contain a set of **real numbers** as a subset.

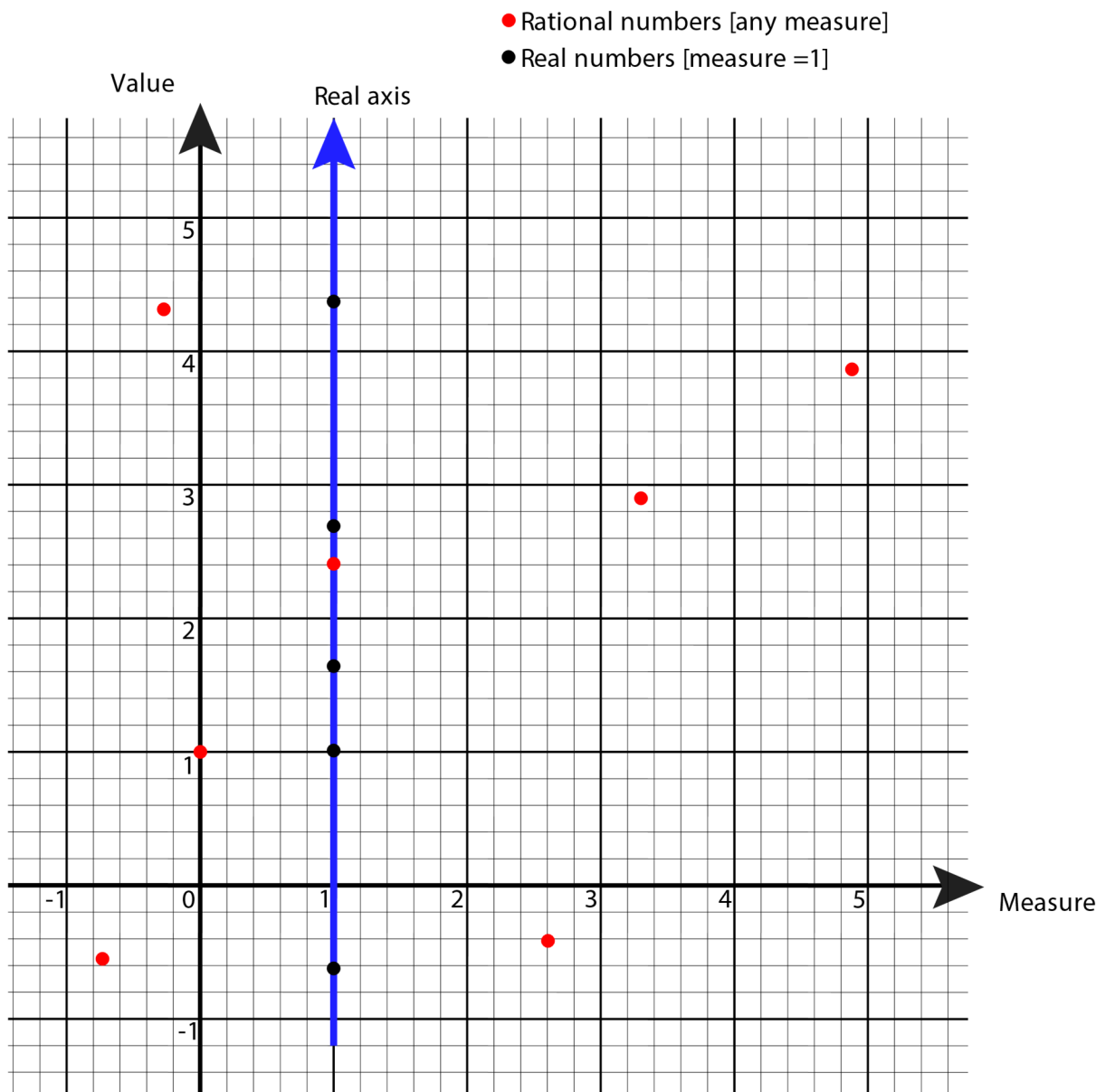

Figure 64.

18. Problems with numbers.

The projection of the whole plane of rational numbers onto the real axis $\frac{value}{1}$ as seen in Figure 61., has a whole series of consequences. The fact that every number, understood as a fraction $\frac{value}{measure}$ (*value* related to base *measure*) is treated as number in relation to *measure* = 1, has following consequences.

- a) It is wrong to treat all rational numbers that are on the same line, representing a particular n-time ratio set (like. $\frac{1}{2}$ i $\frac{2}{4}$), as equal to each other. If seen in their full meaning, they represent totally different things that have only one common attribute, the quotient - projection onto the real axis (Figure 61.)(86). It's enough to carefully rethink their sense, to understand the difference between them.

$$\frac{1}{2} \rightarrow \frac{1}{2} = \frac{1}{2} \leftarrow \frac{2}{4} \quad (86)$$

- b) All rational numbers in the form of $\frac{0}{x}$ (represented by points on the single line of zero-times ratio set (Figure 65.) were projected just to one number $\frac{0}{1}$ or simpler 0 only. This also distorts the true picture and the numbers true meaning. Trying to understand the sense of the numbers in the form of $\frac{0}{x}$, it is easy to do so, because they are just representing a certain ratio. The ratio between the two states, the first one, our starting state, in which x elements are available, and we are transforming this state to the second one, the ending state, with zero elements, there are no elements at all. It can also mean that we do not want, do not expect, do not select any one of them. They initially were there, and by saying that there are zero of them, we are losing information about the initial state of the transformation. At the end, we've got zero, but in the beginning, there was x of them. There is undoubtedly a difference of context, either we are selecting zero out of two, or selecting zero from a million, however the result is the same, we selected none (zero).

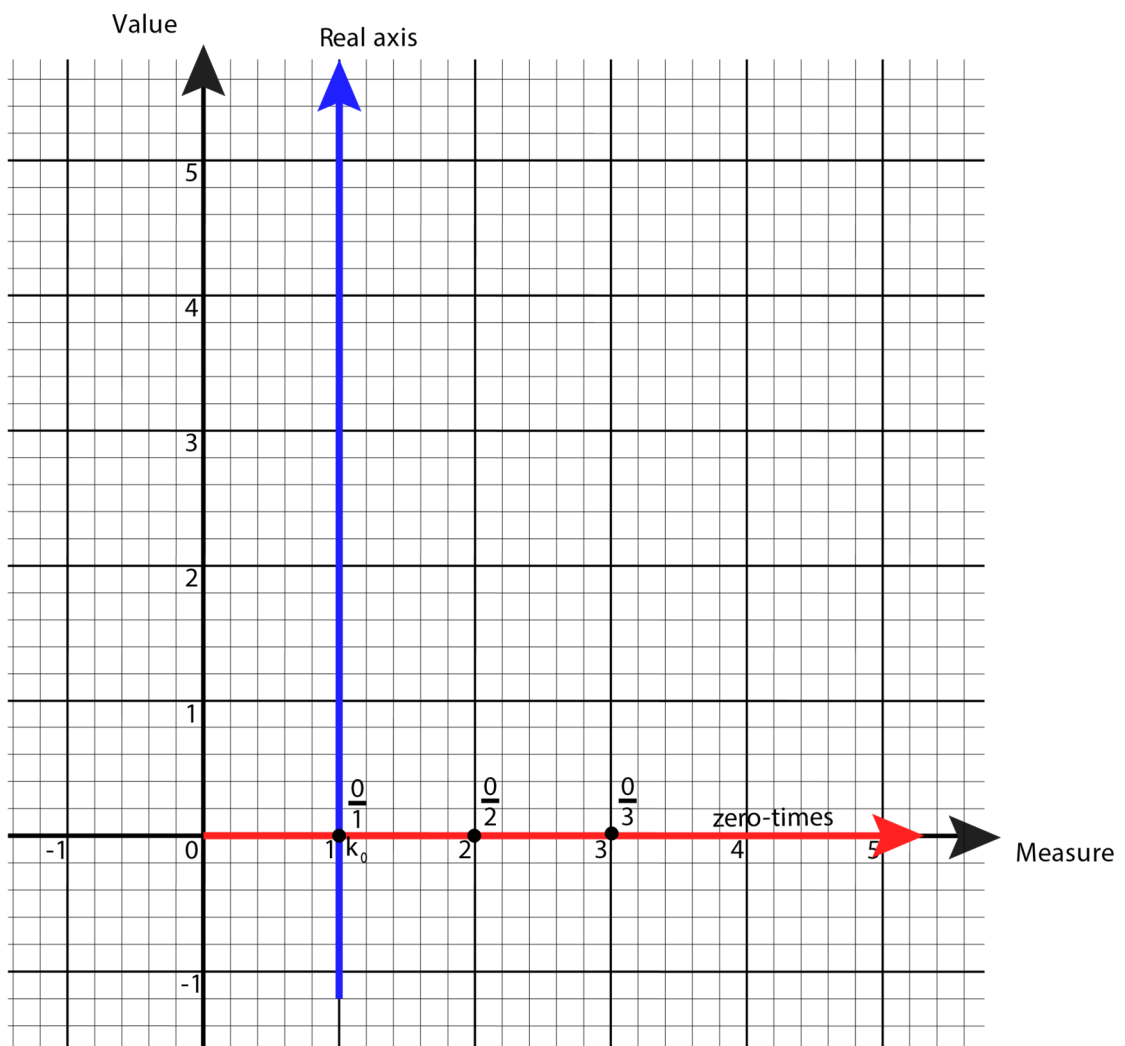

Figure 65.

- c) Division by zero is prohibited by artificial means. The reason for this, was the inability to understand, that the numbers in the form of $\frac{x}{0}$ are just normal rational numbers, numbers in their natural form $\frac{value}{measure}$, that represent $value = x$, related to the base $measure = 0$. The sense of such numbers is that, they are ratios between two states, the ending state is represented by $value$ (in this case x), and the initial state is represented by $measure$ (in this case 0). We can imagine it as a situation where we want to have x elements, or we expect to have them, but **zero** are available. This does not change the fact that we would like to be able to get x of these elements. Division by zero was prohibited, because the axis that connects all the numbers in the form of $\frac{x}{0}$ **does not cross** the axis of real numbers. **It wasn't possible then, to project onto it** as it was possible with all the others rational numbers. They were equated all together inside of one **n-times ratio set** and projected onto a point $\frac{x}{1}$ from the real axis. In the presented interpretation, there is no problem presenting the number, for example $\frac{3}{0}$, and to even say that it is something different than the number $\frac{1}{0}$.

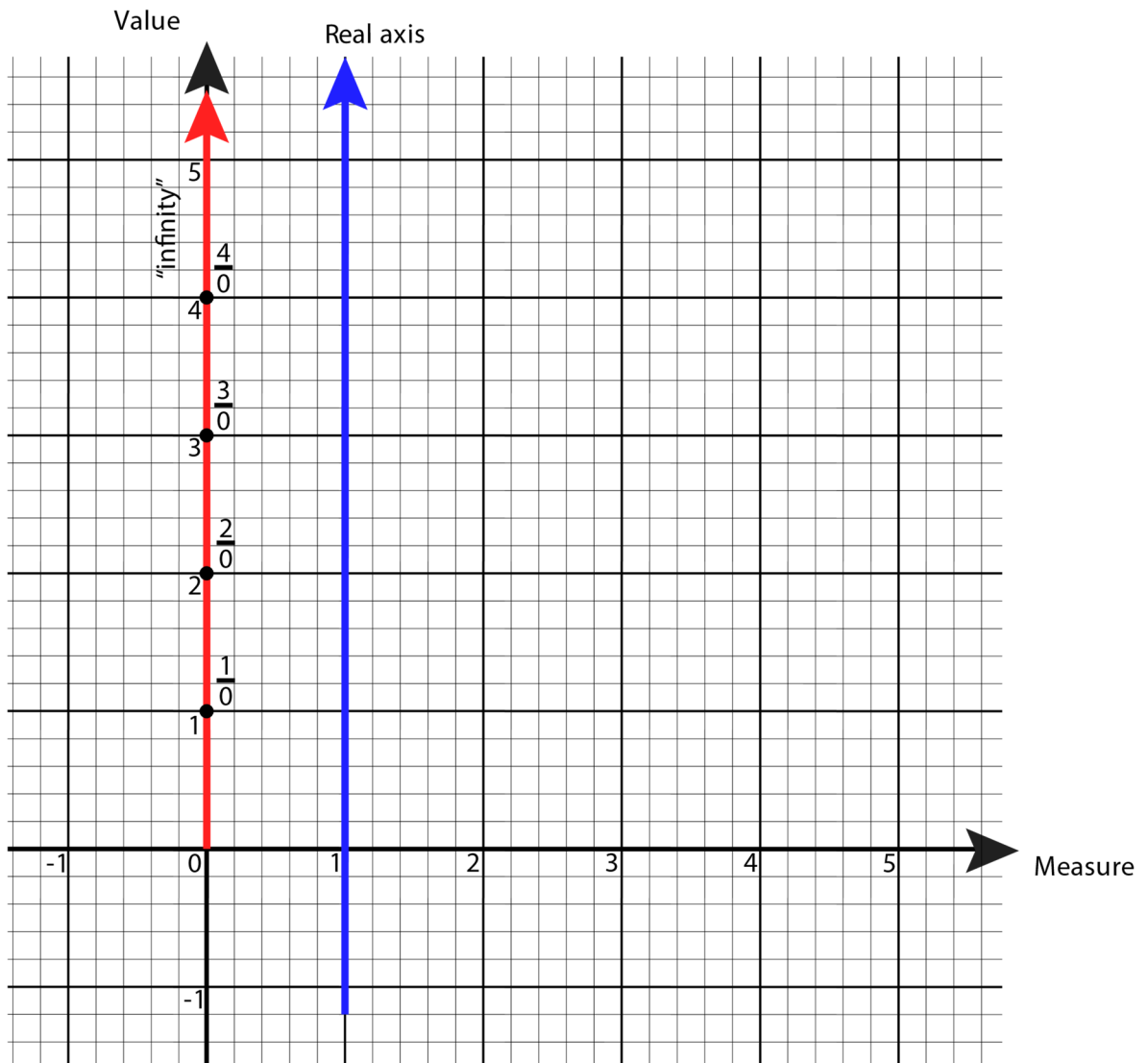

Figure 66.

19. Other consequences of perceiving rational numbers only by their projections onto the real axis.

Perceiving rational numbers only by their calculated quotient (conversion to real numbers) is deeply rooted in our minds. Its effect (or maybe the cause) is that, we perceive the changes close to the one-time ratio as the most quantitative. It means, the difference between the one-time ratio and the two-times ratio is relatively large and noticeable to us, while the difference between the 1000-times ratio and the 1001-times ratio is not. In fact, they are exactly the same. Life example: If someone has one car or two cars it seems to make a difference, but if someone has 1000 cars or 1001 cars it seems to be not so different. In both cases the difference is exactly the same as it is... just one car. The graph in Figure 67. presents where the difference is at.

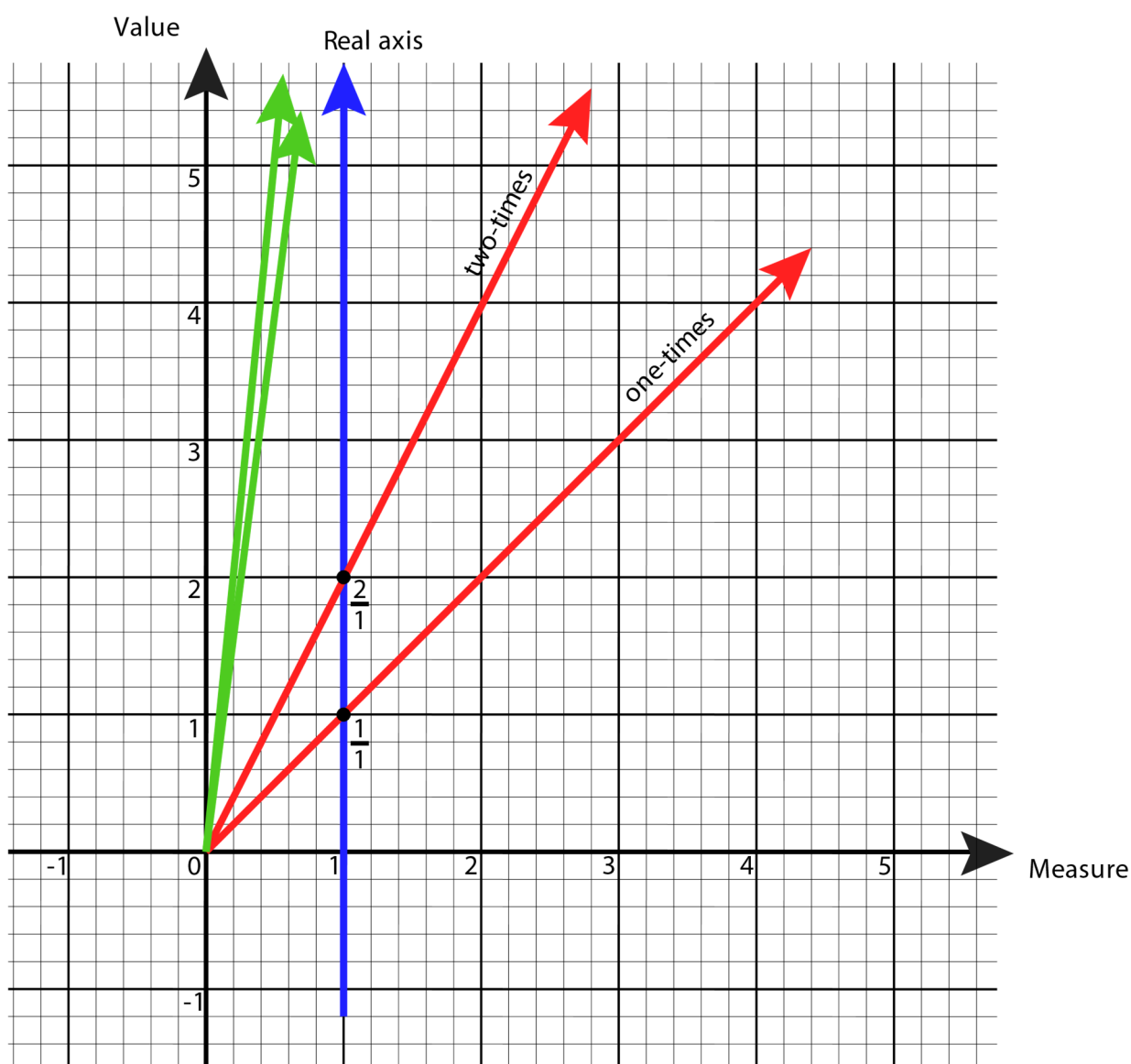

Figure 67.

The red lines show how we perceive the difference between the ratios $\frac{1}{1}$ and $\frac{2}{1}$ (for example between one car and two cars), the angle between those lines is wide. The green lines show how we perceive the difference between the ratios of $\frac{1000}{1}$ and $\frac{1001}{1}$ (or 1000 cars and 1001 cars) the angle between

green lines is narrow. In both cases these differences between the numbers of cars are the same – it is just one car.

20. The graphical representation of the function $f(x) = \frac{1}{x}$ in both real numbers and rational numbers.

The classical representation of the function $f(x) = \frac{1}{x}$, in the form which we all know from school, is presented on the graph in Figure 68. It has a discontinuity point at $x=0$. This representation is limited only to real numbers.

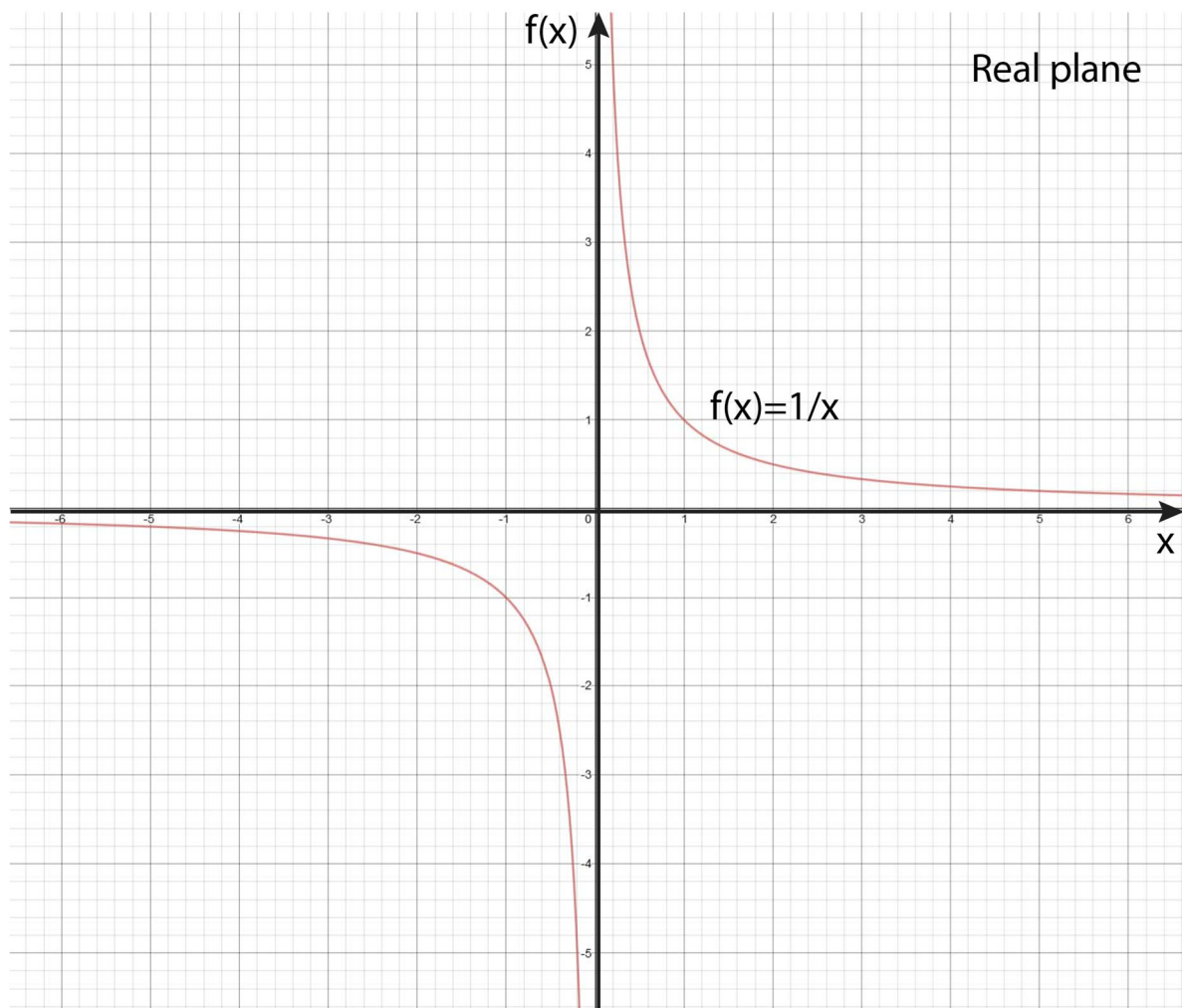

Figure 68.

On the following graphs we can see a representation of the same function in rational numbers. It means that the results of the function for each x are represented as a ratio $\frac{\text{value}}{\text{measure}}$ in this case $\frac{1}{x}$. For a better understanding, our function, the same 3D graph, is presented from different perspectives. In the rational numbers graph, the function $f(x) = \frac{1}{x}$ is represented by the **straight line in the blue color**. All the many different colored lines are the **n-times ratio sets**, that are mapping particular points from **our function** onto the real plane (measure=1).

Note that the only point that has no representation on the real plane, is the point for $x=0$. The line that goes through this point is parallel to the real plane, and doesn't cross with it.

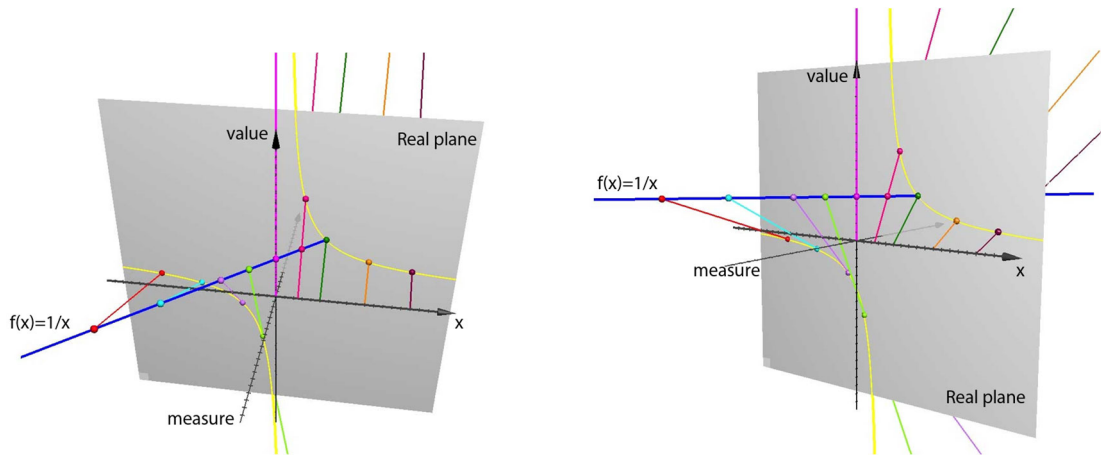

Figure 69.

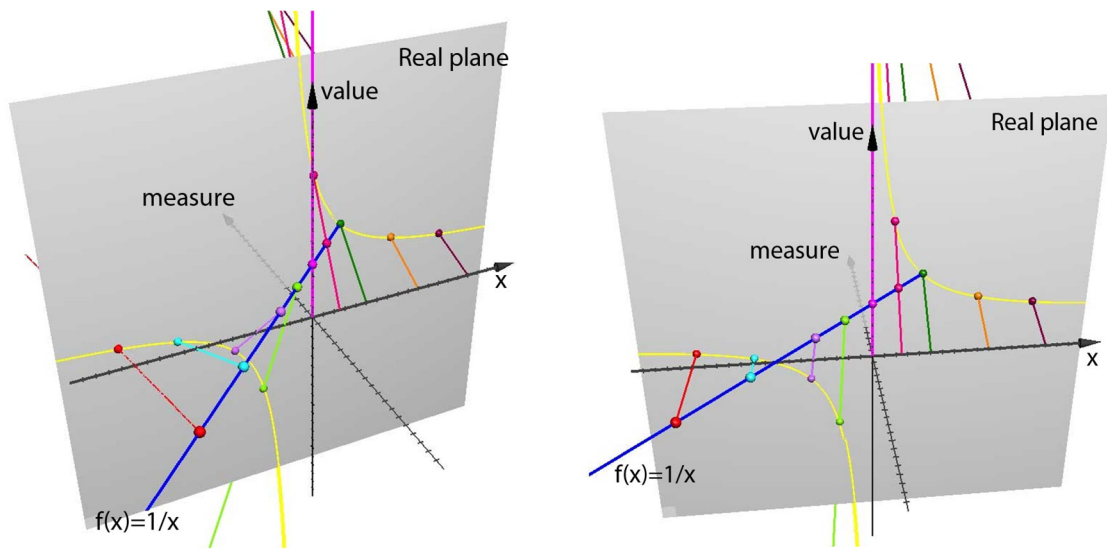

Figure 70.

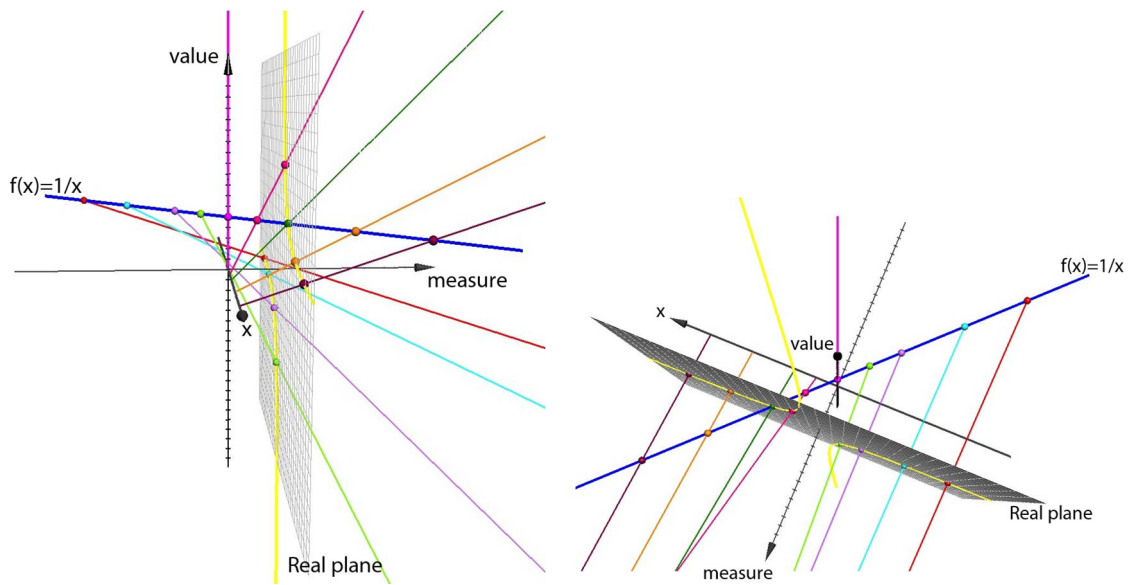

Figure 71.

The conclusion from the graphs above, is that the graph of the function $f(x) = \frac{1}{x}$ in rational numbers is a **straight line, that exists for every x!** The mapping of this function into real numbers (measure =1) changes the real view into the form that **we know from school**, with one discontinuity point for $x=0$. The discontinuity point in our mapping appears, because we are not able to map the point for $x=0$ from our straight line onto the real plane.

21. Graphical representation of the function $f(x) = tg(x)$ in both rational numbers and real numbers.

The situation which was presented in the previous example, is similar to the discontinuity points of the function $f(x) = tg(x)$. The traditional graph for this function is presented below. It shows what the graph of $tg(x)$ looks like in real numbers.

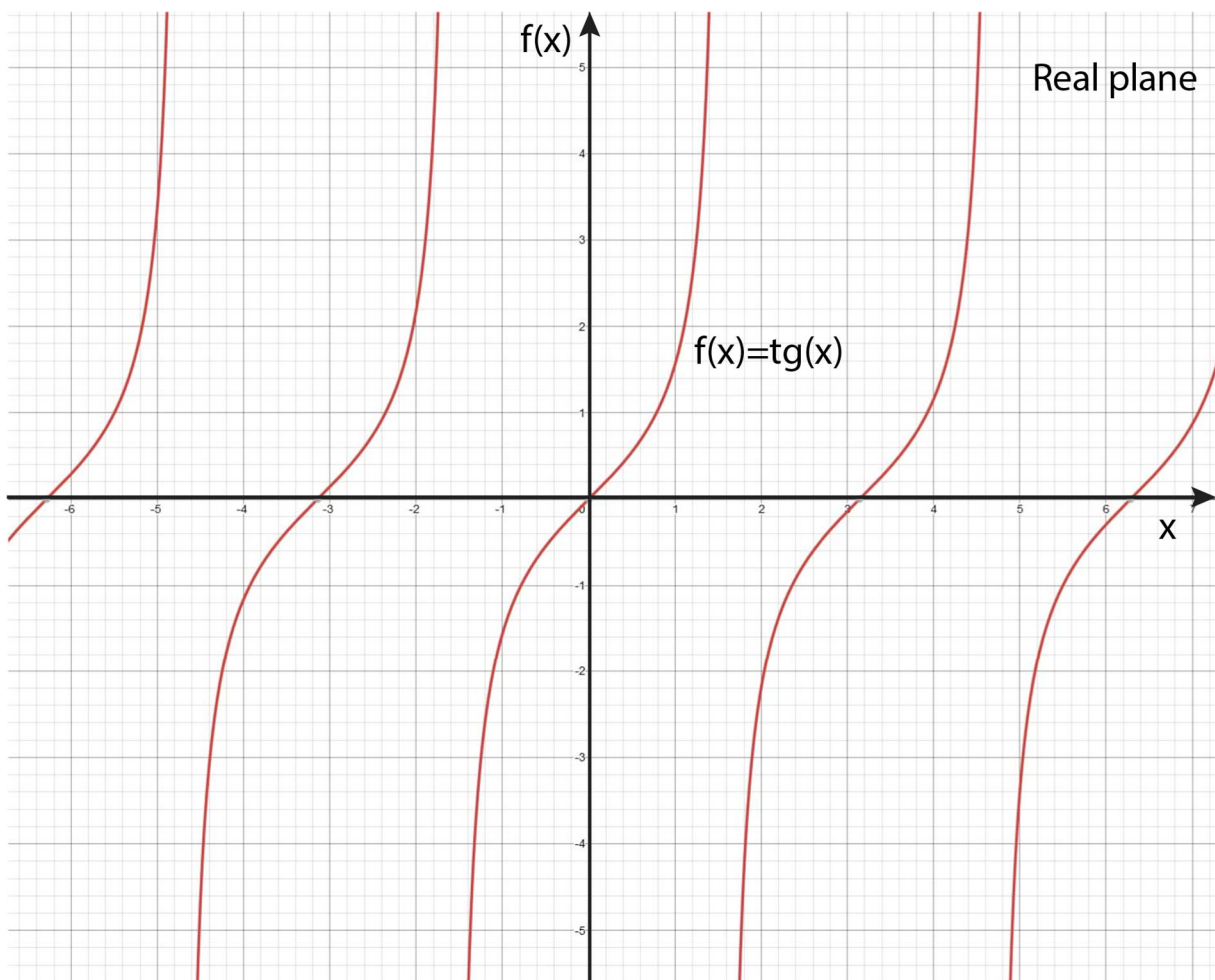

Figure 72.

Let's check this function and see what it will look like in rational numbers. In the following few pictures there are different perspectives on the same 3D graph. The function $f(x) = tg(x)$ is represented by the **blue spiral**. All the many different colored lines are n-times ratio sets, that are mapping particular points from our function onto the real plane (measure=1). We can see here again, that in the case of **x**, where this mapping is not possible, we have discontinuity points on our real plane.

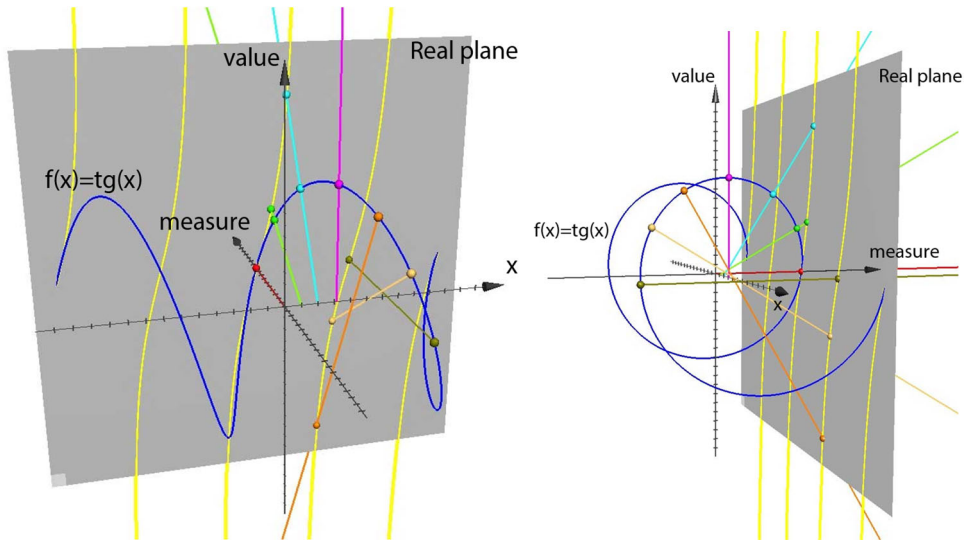

Figure 73.

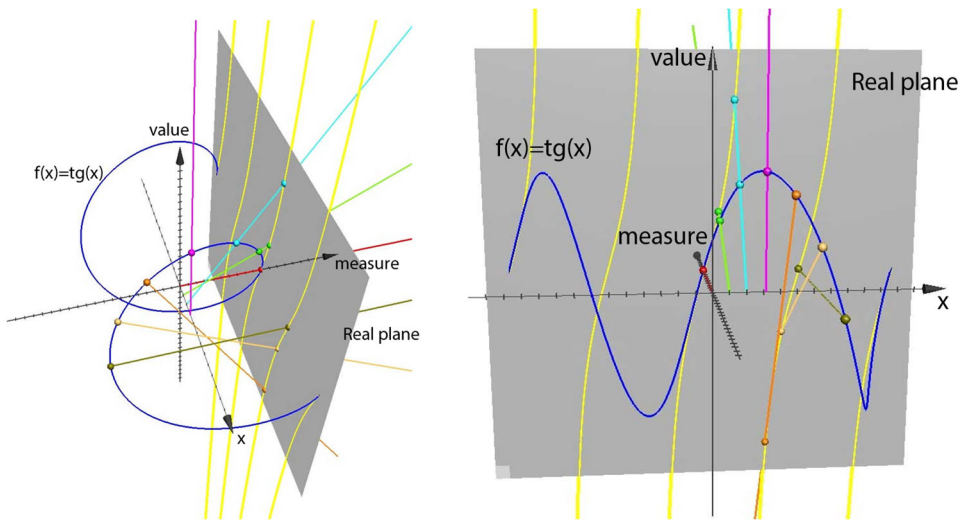

Figure 74.

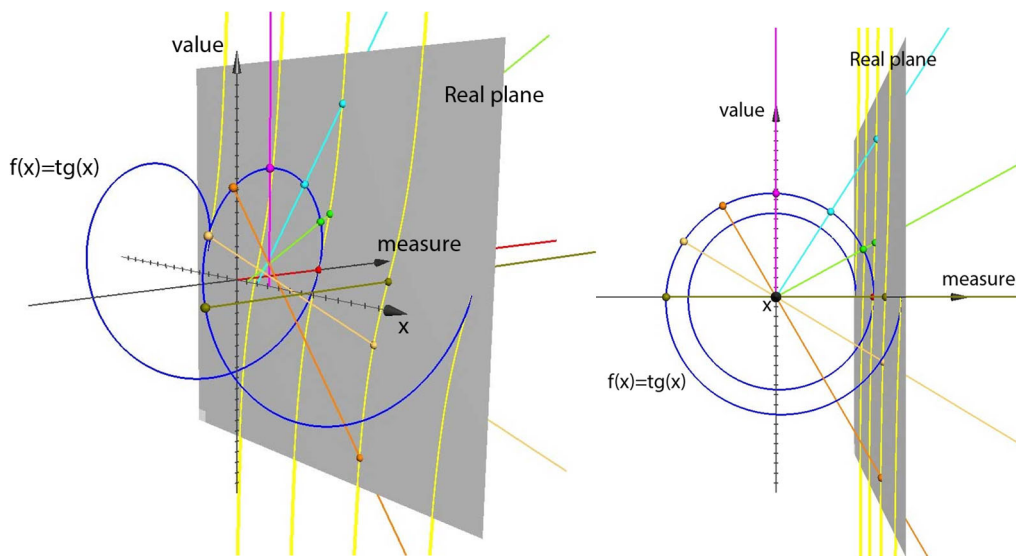

Figure 75.

22. Viewing the world through the perspective of rational numbers.

The nature of rational numbers is always represented by the ratio $\frac{value}{measure}$, or in other words, the ratio between $\frac{effect\ of\ transformation}{what\ was\ transformed}$. When we look at the graph of all such numbers, we can get some new and interesting observations and meanings.

Note, that the *value* and the *measure* in the ratio can also be understood as:

value - can be interpreted as the end result of the transformation, what we want to have as the final effect, what we have selected, what is at the end, and what we end up with ...

While,

measure – can be interpreted as the starting point, the element that is being transformed, that we have selected, and what we got from the beginning ...

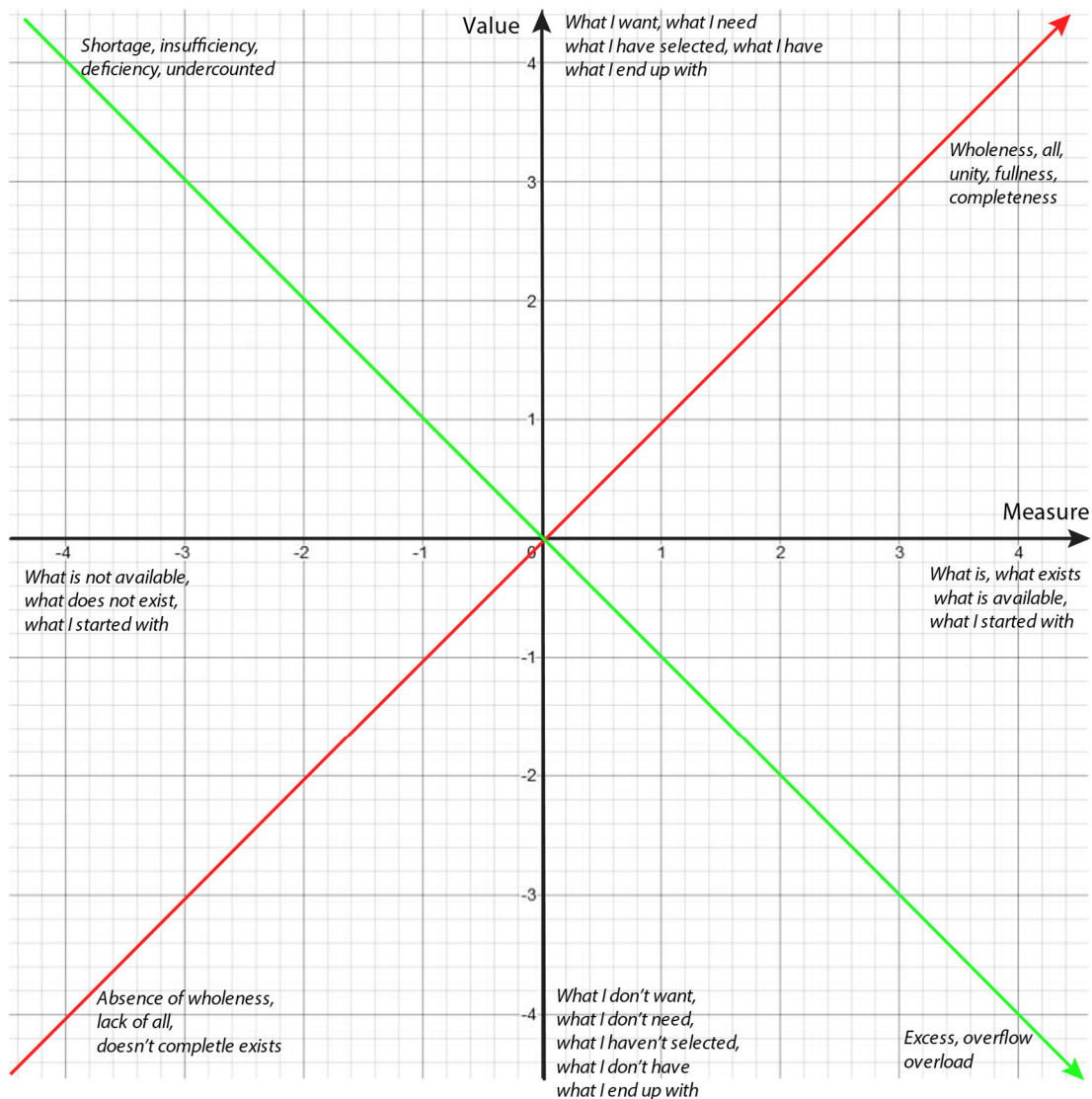

Figure 76.

23. Summary.

The transformation is an operation that changes one pair of numbers into another pair of numbers. Division and multiplication are only certain forms of the transformation. The operation of selection is another form of the transformation. The transformation can be complete as it is in the case of multiplication or division, or won't be complete in the case of selection. In each transformation it is possible to find the ratio between the result of the transformation and the element that was transformed, what we started from. We can say that this ratio performs this transformation. It converts the initial element into the final effect of the transformation. Each number in its own natural form is represented by the ratio between the certain value and the base measure to which it is related to. Modern mathematics is accepting an unauthorized simplification, by bringing all the rational numbers (which are represented by the ratio of the value to the measure) to the fraction with a denominator of 1. In this way, a whole diversity of rational numbers is rejected, while they are all projected onto the real line. This creates an equivalence of rational numbers, which are losing their true sense and meaning. But in fact, they are all representing totally different transformations. As a result of this simplification, modern mathematics is not able to handle division by zero, because rational numbers of the form $\frac{x}{0}$ don't have their own representations on the real line, and it is impossible to project them onto it. They can't be represented as ratios with denominators of 1. Rational numbers of the form $\frac{x}{0}$ tells us about the ratio between x and 0, and about the transformation which starts from 0 and ends up with x. We can say that it tells us about the process of "creation" or our "expectation". While numbers of the form $\frac{0}{x}$ represent the transformation that starts from x and ends up with 0. We can say that these numbers are about the process of "annihilation" or about our "lack of expectations".

24. Ending.

This work is presenting a new understanding of numbers, their ratios and the transformations of them. It explains division, multiplication, selection, and carries a whole series of consequences, and opens new possibilities of understanding of mathematics. It also has also a number of potential consequences in physics. This work allows us to understand division by zero, and through this experience, it leads us to a new way of understanding numbers. I think that it fixes one of the foundations of mathematics, because it was incorrect earlier. It is difficult to predict all the consequences this change can bring to everything that was created, based on this incorrect foundation.

"This is not the end. It is not even the beginning of the end.

But it is, perhaps, the end of the beginning."

Winston Churchill