

# Gravity's Origin, Impetus & Unification

Ken Gonder\*

Unaffiliated Independent

(Prepared for viXra.org open-access repository 3/6/2024)

## Abstract

Gravity and its unification with electromagnetism are easily resolved by simply recognizing the broader implications of already well-established, widely held theory: Subatomic particles spontaneously condense out of the all-pervasive field of radiant electromagnetic energy that comprises the universe. This produces a commensurate decrease in the universal field's density immediately around emerging particles that innately diffuses inward exponentially because of a field's uninterrupted continuity and a sphere's inherent geometry. This is what constitutes a particle and the bodies' they compose gravity field. Runaway gravitation naturally ensues as they mechanically pursue equilibrium in the ever-decreasing density of their ever-merging (electromagnetic) gravity fields.

## Contents

<b>Abstract</b> _____	<b>1</b>
<b>Origin</b> _____	<b>2</b>
<b>Impetus</b> _____	<b>3</b>
<b>Unification</b> _____	<b>4</b>
<b>Conclusion</b> _____	<b>16</b>
<b>Coda</b> _____	<b>16</b>
<b>Declarations</b> _____	<b>18</b>
<b>References</b> _____	<b>18</b>
<b>Bibliography</b> _____	<b>19</b>

\* kgonder0@gmail.com

## Origin

Something is never created from nothing. Particles don't just pop into existence out of nowhere. They condense into being out of the radiant electromagnetic energy that is the universe that expresses as an infinitely vast, all-pervasive universal field [1]. (Use **[Alt][←]** to return.)

The universal field is everywhere. It extends indefinitely. If it could be separated from matter, it'd correspond to all space. It's continuous. Its continuity is unbreakable. And it can't be interrupted. But just as it is with any ordinary field, its intensity, which is the same as density, can and does vary. None of this is the least bit controversial. It's central to the underlying tenets of orthodox cosmology.

Few would also disagree that there's no such thing as matter per se. Particles aren't composed of any actual material. Nor do they have a surface. They're just small condensed spherical fields of radiant energy of increasing density that reach some maximum concentration at their center. So there's no separation between a "particle" (or the objects they comprise) and the field they originate from and now reside [2].

In his book, *Relativity: The Special and the General Theory*, Einstein suggests that, "Physical objects are not *in space*, but these objects are *spatially extended* [3]." But a more correct interpretation would be that all objects are *electromagnetically extended*.

Because they're one and the same, every time a particle "spontaneously" congeals into existence the entire universal field is put at further loss.<sup>1</sup> Its density decreases commensurate with the emerging particle's condensing. But that minuscule thinning isn't spread evenly throughout the entire universe.

Nearly all of it occurs in the vicinity of the particle. What's not taken up and drawn into the particle is left diffusing inward immediately around it, dissipating exponentially toward its center, spherically, while the field's outward radial condensing continues infinitesimally without end.

1. You have to wonder, what is the catalyst behind a particle's inception? What is it exactly that initiates its congealing and causes it to suddenly "materialize"?

Despite the universal field's opposite inward diffusion, it still has to dissipate exponentially per the inverse square law just like any diffusion because of the inherent three-dimensional geometry of a sphere. Whether the diffusion dissipates inward or outward doesn't matter. It's still bound to the exponential gradient intrinsic to spherical geometry [4].

It's the inward diffusion of the universal field's ambient electromagnetic energy that's not been drawn into the particle but remains outside it and the bodies they've coalesced into that defines a gravity field. It's the innate compounding of those gravity fields that causes their density to always be at their least directly in between the bodies they surround. This occurs at their common center of mass, their center of gravity, regardless of the distance or extreme the conditions [5].

## **Impetus**

Naturally compelled to seek equilibrium in the varying density of their ever-merging gravity fields, all bodies from particles to galaxies are constantly pushed mechanically by the highest density toward the lowest. This causes their unrelenting gravitation toward one another. Runaway coalescing and its concomitant condensing naturally follow.

When enough material accumulates, the resultant pressure from the ever-decreasing density of their combining gravity fields begins to trigger fusion reactions. This ultimately transmutes every particle back into the electromagnetic radiation from which it arose.

At the scale of galaxies, gravitation's runaway nature gives rise to an ever-increasing infall of ever-coalescing material that ceaselessly migrates inward toward a galaxy's common center of mass. As material nears its core, the inward pressure from its exponential condensing collapses it back into the radiant energy it originated from and radiates it back out. Or in more evolved, well-developed spirals, it's spewed out in huge bipolar jets.

Eventually, it slows, cools, and at some point reconstitutes back into ordinary matter. It can then begin gravitating back to its or another nearby galaxy in a never-ending process of perpetual recycling.

## **Unification**

Gravity's unification with electromagnetism is naturally achieved with the self-evident realization that a gravity field is nothing more than an inward diffusing electromagnetic field. When particles innately spawn from and congeal out of the universe's elemental field of electromagnetic energy it creates a corresponding deficit in its density that manifests immediately around emerging particles and the bodies they compose.

It is a field's intrinsic uninterrupted continuity combined with the inherent properties of a sphere that adheres to the exponential gradient of the inverse square law that causes its inward exponential diffusion. This is how an electromagnetic field becomes a gravity field.

It's the innate compounding of inward diffusing electromagnetic/gravity fields that causes bodies to accelerate toward one another. Their combined highest field density constantly pushes bodies together toward their lowest that's always located directly in between them toward their common center of mass.

The ever-decreasing field density that naturally results leads to runaway coalescing/condensing as a matter of course. From this sensible, well-grounded, practical, physically tangible reality all else falls neatly into place.

(See **Figure 1**, Inverse Square Law, Field; **Figure 2**, Fields; **Figure 3**, Gravitation; **Figure 4.1, 4.2, 4.3, 4.4**, The Shape of Gravitating Bodies - 1, 2, 3, 4; **Figure 5.1**, Atoms; **Figure 5.2**, Neutrons & Isotopes; **Figure 5.3**, Ions; **Figure 5.4**, Aufbau or Build-up Principle of Electrons - next page)

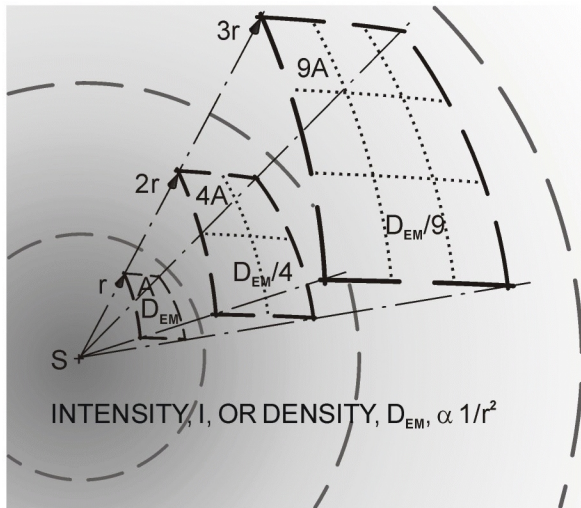

**1. ELECTROMAGNETIC FIELD**  
 ELECTROMAGNETIC FIELD INTENSITY, WHICH IS THE SAME AS DENSITY, DECREASES PROPORTIONAL TO THE INVERSE OF THE SQUARE OF THE RADIUS. THIS DIFFUSES ITS OUTWARD ACTING PRESSURE GRADIENT EXPONENTIALLY.

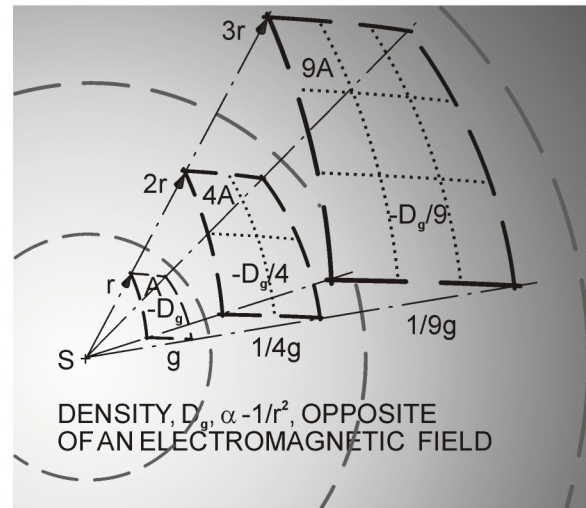

**2. GRAVITY FIELD**  
 GRAVITY FIELD INTENSITY, OR DENSITY, ALSO DECREASES PROPORTIONAL TO THE INVERSE OF THE RADIUS SQUARED. BUT ITS DIFFUSION IS INWARD. THIS INCREASES ITS OPPOSITE, NEGATIVE PRESSURE GRADIENT EXPONENTIALLY PER GRAVITY'S FORCE, g.

**INVERSE SQUARE LAW, FIELD**

An electromagnetic (EM) field, depicted in section view by the diffusing background in diagram 1, is subject to the inverse square law that's the product of the three-dimensional geometry of a sphere. So the field's intensity, which is the same as density, that produces pressure which is force, twice the distance from its source is diluted by four times the area. This reduces its density to 1/4 the original. At three times the distance, it's spread over nine times the area, which reduces the density to 1/9 the original, and so on where  $D_{EM}$  (the density at a given radius) =  $S$  (the original density) /  $4 r^2$  (the area of a sphere).

The tangible, radiant, EM energy of the universal field that particles condense out of is all-pervasive, continuous, inseparable, and it varies in density. So the remaining ambient radiation that's not been drawn into a congealed particle has to thin inward, diffusing exponentially toward its center. This is what constitutes their, or collectively the bodies they compose, gravity field, portrayed in section view as the diffusing background in diagram 2.

It's the opposite of an EM field. Its lowest density is reciprocal to the EM field's highest. Still bound to a sphere's inverse square law, its density, which is still intensity, which still equates to pressure and force, still has to dissipate exponentially. The gradient remains the same. It just expresses the opposite direction, diffusing inward instead of outward where  $D_g$  (the density at a given radius) =  $-S$  (the original point source strength or negative density established by a body's mass) /  $4 r^2$  (the area of a sphere).

So at twice the distance from the center, its original negative density is diffused over four times the area, which is 1/4 the original that reduces the inward acting pressure by the same amount, decreasing gravity's force to 1/4g. At three times the distance, its negative density is spread over nine times the area, which is 1/9 as dense as its original that decreases the inward acting pressure the same, reducing gravity to 1/9g, and so on.

**Figure 1**

(7.2 Inverse Sq Field v 8.1a)

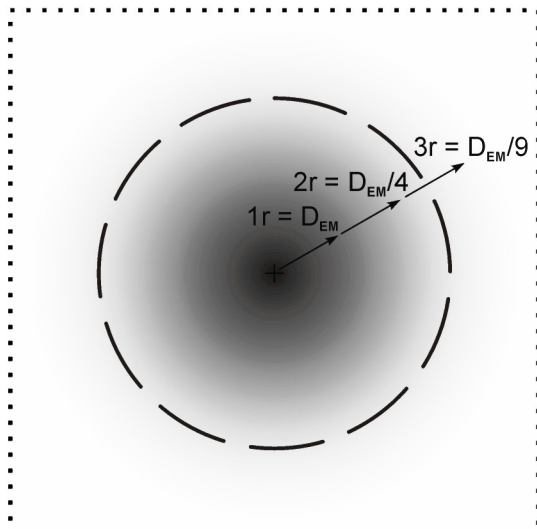

**1. ELECTROMAGNETIC FIELD**

POSITIVE DENSITY DIMINISHES,  $D_{EM} \quad 1/r^2$

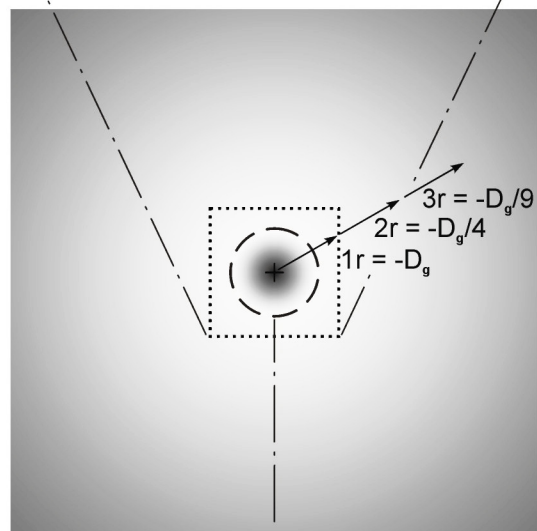

**2. GRAVITY FIELD**

NEGATIVE DENSITY DIMINISHES,  $D_g \quad -1/r^2$

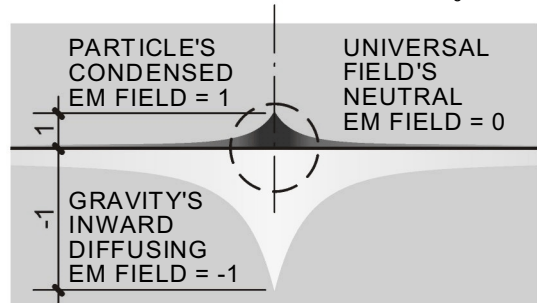

**3. RELATIVE FIELD DENSITY & SIZE**

THE UNIVERSAL FIELD'S CONDENSING INTO A PARTICLE CAUSES COINCIDING INVERSE DIFFUSION INTO A GRAVITY FIELD. THE APPARENT DIFFERENCE IN THEIR SIZE AND STRENGTH IS DUE TO A DIFFERENCE IN DENSITIES OF THEIR RECIPROCAL FIELDS.

**FIELDS**

The universe's elemental radiant energy manifests in two fundamental ways, as an electromagnetic (EM) field and a gravity field. They're the same universal field but with opposing densities. They coexist and coincide, but they're reciprocal. One does not exist without the other. And their continuity is impossible to disrupt.

They're portrayed in section view by the diffusing background in diagram 1 & 2. The EM field is shown in an expanded view. Its size is usually many magnitudes smaller than gravity's. The dashed circle represents the theoretical extent of any individual particle or body.

When the universal field "spontaneously" condenses into a subatomic particle, it's defined as matter with an assigned amount of mass. But at its essence, it remains radiant EM energy.

Its condensed state naturally gives it a higher density than the universal field's. The balance of the universal field that didn't congeal into the particle, its ambient gravity field, is naturally lower than the universal field's overall density.

The quantity of radiation composing the particle is the loss of radiation that composes its gravity field. They're the equivalent but inverse, different sides of the same coin, so to speak. Or yin and yang if you like.

If the universal field were assigned the neutral value of zero (0) and the particle, condensed EM field, a value of one (1), the resultant inward diffusing EM field, its gravity field, would have a corresponding negative quantity the equal and opposite value of negative one (-1). They naturally reciprocate despite the apparent difference in their size and strength, which is a product of their different but opposite densities, diagram 3.

EM fields diffuse outward exponentially. Gravity fields also diffuse exponentially but inward toward a particle's center. It makes no difference whether the diffusion dissipates inward or outward. The gradient still has to diminish exponentially. Both are subject to the same inherent geometry of a sphere that's bound to the inverse square law (Intensity or Density  $1/r^2$ ).

An EM field's exponential diffusion from higher inner density to lower outer density creates outward acting radial pressure. This should be interpreted as a positive charge, having a male or originative quality.

A gravity field's exponential diffusion from higher outer density to lower inner density creates inward acting radial pressure, which should be viewed as a negative charge, having a female or receptive quality. The greatest pressure of each occurs simultaneously at their coinciding centers.

**Figure 2**

(27 Fields v 11.1a)

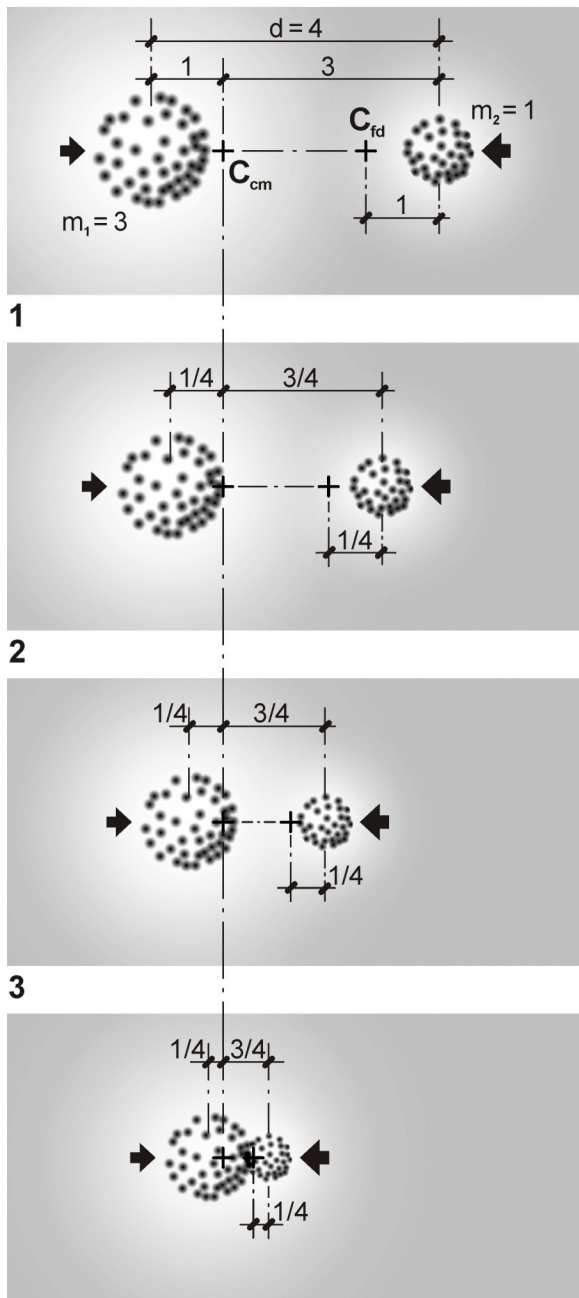

4

### COALESCING BODIES

BODIES AREN'T ATTRACTED TO ONE ANOTHER. THEY'RE CONSTANTLY PRESSED TOGETHER BY HIGHER FIELD DENSITY TOWARD LOWER FIELD DENSITY AS THEY MECHANICALLY REACTIVELY SEARCH FOR EQUILIBRIUM IN THE EVER-DECREASING DENSITY OF THEIR EVER-MERGING GRAVITY FIELDS.

## GRAVITATION

A natural consequence of a particle's emergence, gravity fields necessarily diffuse inward exponentially because of basic spherical geometry that's bound to the inverse square law, depicted in section view by the diffused background.

Gravity fields' innate compounding causes that inward diffusion to always be at its least directly in between the particles and the bodies they surround at their common center of mass,  $C_{cm}$ , which is the same as their common center of gravity.

Mechanically pursuing equilibrium in the ever-decreasing density of their ever-compounding gravity fields, all bodies, be it particles or galaxies, are constantly pushed by the highest field density toward the lowest. This inexorably leads to runaway coalescing that ultimately ends with fusion reactions transmuted all matter back into the radiant energy it originated from.

Because gravity fields not only surround but also permeate all bodies, including atoms, depicted as the small spheres comprising the spherical bodies, their compounding simultaneously causes both coalescing and condensing at all scales consistent with Newton's law of gravitation:  $F = G(m_1 m_2) / d^2$ , where  $F$  is the "attractive" force,  $G$  is the gravitational constant,  $m$  the mass, and  $d$  is the distance between their centers.

The distance to their  $C_{cm}$  from  $m_1$  is  $d_{cm} = m_1 d_1 + m_2 d_2 / m_1 + m_2$ , where  $d_{cm} = 3(0) + 1(4) / 3+1$  or 1. From  $m_2$ , it'd be  $1(0) + 3(4) / 3+1$  or 3.

$C_{fd}$  indicates the location in between them where they share a common field density. The distance to their  $C_{fd}$  is opposite of or naturally reciprocal to their  $C_{cm}$ . Both their  $C_{cm}$  and  $C_{fd}$  could be interpreted as non-centrifugal Lagrange points where the gravitational influence remains in equilibrium.

Actual Lagrange points incorporate orbital motion's centrifugal force. It's not included in this example for clarity. If it were, their  $C_{fd}$  would become the  $L_1$  Lagrange point that'd have to be closer to  $m_1$  to compensate for the outward centrifugal force.

The distance to their  $C_{cm}$  and  $C_{fd}$ , their relative rate of motion toward each other, and their relative condensing, all remain proportional to their masses as they relentlessly gravitate in the ever-thinning density of their ever-compounding gravity fields, conceptually portrayed in the sequence of diagrams 1-4 [6][7].

Figure 3

(28 Gravitation v 12.1a)

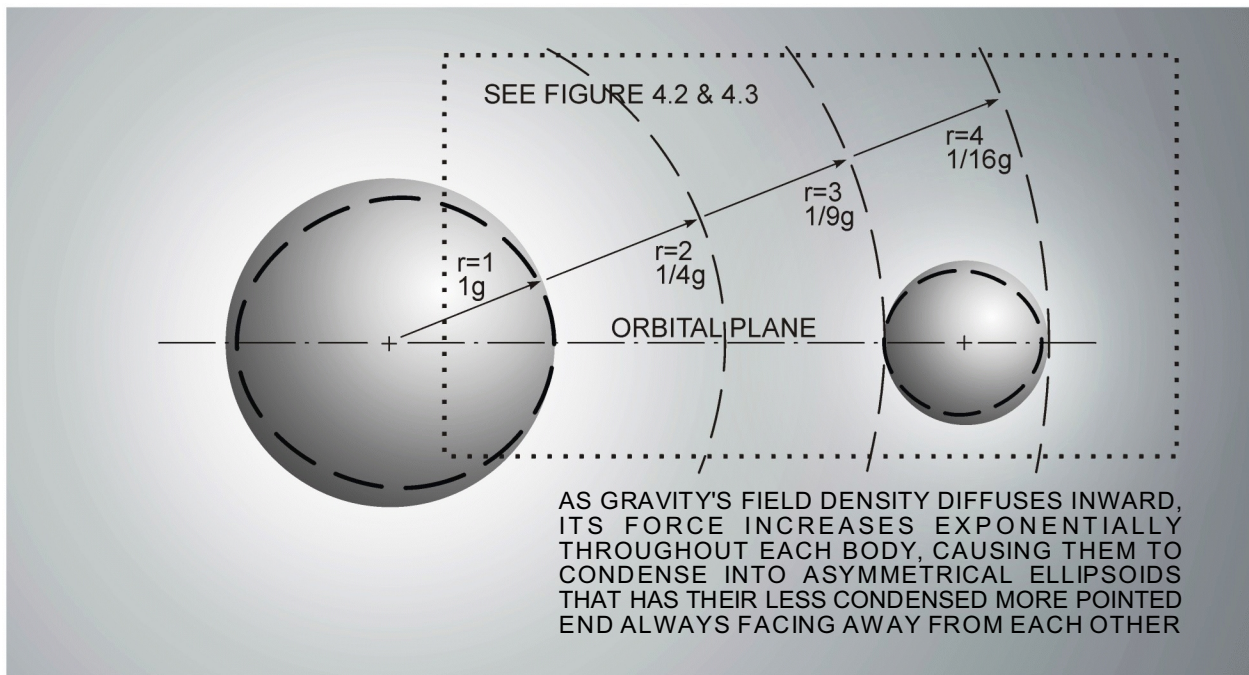

## GRAVITY'S CONDENSING

### THE SHAPE OF GRAVITATING BODIES - 1

Gravitating bodies don't stretch or "spaghettify" in gravity fields. They continue to condense, contracting spherically in an omnidirectional manner into ellipsoidal shapes that are slightly asymmetrical similar to an egg, depicted by the dashed ovals. This is due to the exponential decrease in density of their compounded gravity fields that permeates their bodies, portrayed in section view by the diffusing background.

For simplicity, if we set the smaller body's diameter equal to the larger's radius and located it three radiuses out then the larger's force of gravity, defined as  $1g$  at its surface, would radially affect the smaller sweeping across its entire body, exponentially decreasing from  $1/9g$  at its closest point to  $1/16g$  at its farthest, causing more condensing at the closer end. The smaller's gravity field would affect the larger in the same way but much less. This creates a slight asymmetry in their condensing that has their more pointed less condensed ends always pointing away from one another, or more precisely, directly opposite a common center of mass for any number of objects.

If the smaller body's orbit was decaying but with a slow orbital or rotation rate or none at all, the asymmetry of its deformation would remain the same while it continued to condense until they merged. For faster orbits and/or rotation where a stronger outward centrifugal force began to exceed gravity's inward condensing, the smaller body would begin to fragment and disperse. But that dispersion would begin first from its outermost point where the centrifugal force would be the greatest and gravity's compounded force would be at its weakest. The fanned dust tails of comets that always diffuse to the outside of their elliptical orbits opposite the Sun demonstrate this.

An obvious example of a body's asymmetrical ellipsoidal deformation is the Moon's, and to a lesser degree the Sun's, affect on the Earth's oceans. Water's pliability causes it to more readily distort than the rocky crust below, making its deformation easier to perceive. Tides are simultaneously at their highest both facing and opposite the Moon where they're slightly lower.

This is not the result of the "pull" of the Moon's gravity as some contend. And even if it was, there's nothing on the opposite side pulling those oceans into their high tide. Those are often explained as the result of no pull, or sometimes more reasonably but still incorrectly, the result of the centrifugal force of the Earth-Moon system [8].

**Figure 4.1**

(11.1 Shape v 10a)



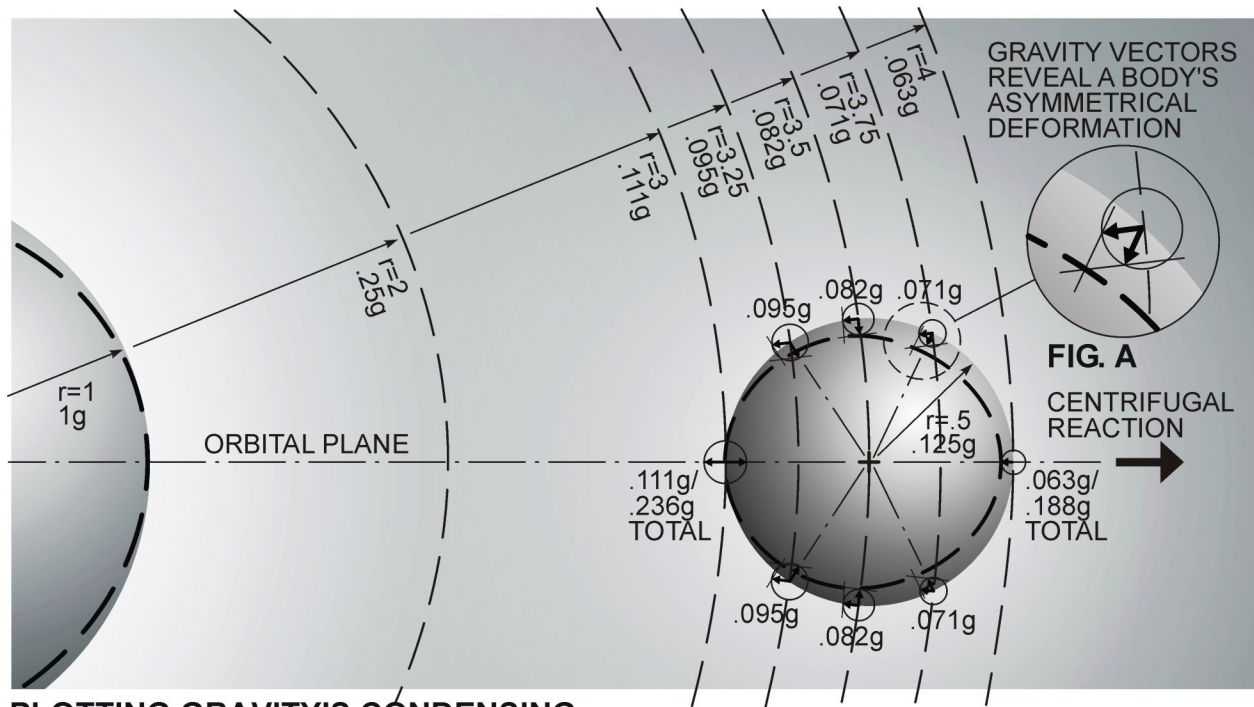

## PLOTTING GRAVITY'S CONDENSING

### THE SHAPE OF GRAVITATING BODIES - 2

Gravity fields compound, diffusing inward exponentially through gravitating bodies, causing their ongoing condensing into evermore compact asymmetrical ellipsoids. This can be demonstrated conceptually by plotting compounding proportional values for their gravity around their surface.

The relative gravity of the bodies can be established by comparing their volumes. Assuming they're both the same composition, if we set the larger's radius at 1 (the unit of measure doesn't matter), then its volume ( $V = 4/3 r^3$ ) will be 4.19 ( $V = 4/3 1^3$ ). For the smaller, whose radius is half of the larger's, its volume is .524 ( $V = 4/3 .5^3$ ). So the smaller body's volume will be about one eighth, .125 ( $.524/4.19$ ), of the larger's. That's the ratio we'll use for their relative gravity, the larger 1g, the smaller .125g.

Gravity's effect radiates spherically. So to determine the deformation of the smaller body by the larger, its gravity has to be applied equally to both bodies radially. This can be simply accomplished by applying radii vectors to each body proportional to the larger's gravity at each location where the larger's gravity radius intersects with the smaller's surface, as depicted in expanded view in Fig. A. The smaller's gravity can be considered constant.

At 3 gravity radiuses out where the bodies are closest, the larger's gravity ( $1/r^2$ ) will be .111g ( $1/3^2$  or  $1/9g$ ). So compounding proportional radii vectors from that location would be one .111 long vector pointing toward the center of the smaller body and another .111 vector pointing toward the center of the larger. Since they're pointing in opposite directions, their compounding cancels each other out. The total gravity at this location is .236g (.111g + .125g).

At 3.25 radiuses out, the larger's gravity decreases to .095g ( $1/3.25^2$  or  $1/10.56g$ ). The same method is used. Compounding .095 vectors to the center of both bodies determines the extent of the deformation at that location. At 3.5 radiuses, the larger's gravity diffuses to .082g ( $1/3.5^2$  or  $1/12.25g$ ). And at 3.75 radiuses, it's weakened to .071g ( $1/3.75^2$  or  $1/14.06g$ ). Same method.

At 4 radiuses, the smaller's farthest end, the larger's gravity has diminished to .063g ( $1/4^2$  or  $1/16g$ ). With the larger and smaller's radii pointing in the same direction, they overlap. So only .063 applies. The total gravity is .188g (.063g + .125g). With this total always being smaller than the closest end, bodies with faster rotation and/or orbital velocities where the centrifugal's outward dispersal is higher than gravity's inward condensing always begins to fragment from their outermost point first.

This simple numerical approximation conceptually shows how gravitating bodies distort into asymmetrical ellipsoids that continue condensing and only begin to lose material from their backside first when subject to high enough centrifugal forces.

**Figure 4.2**

(11.2 Shape v 10a)

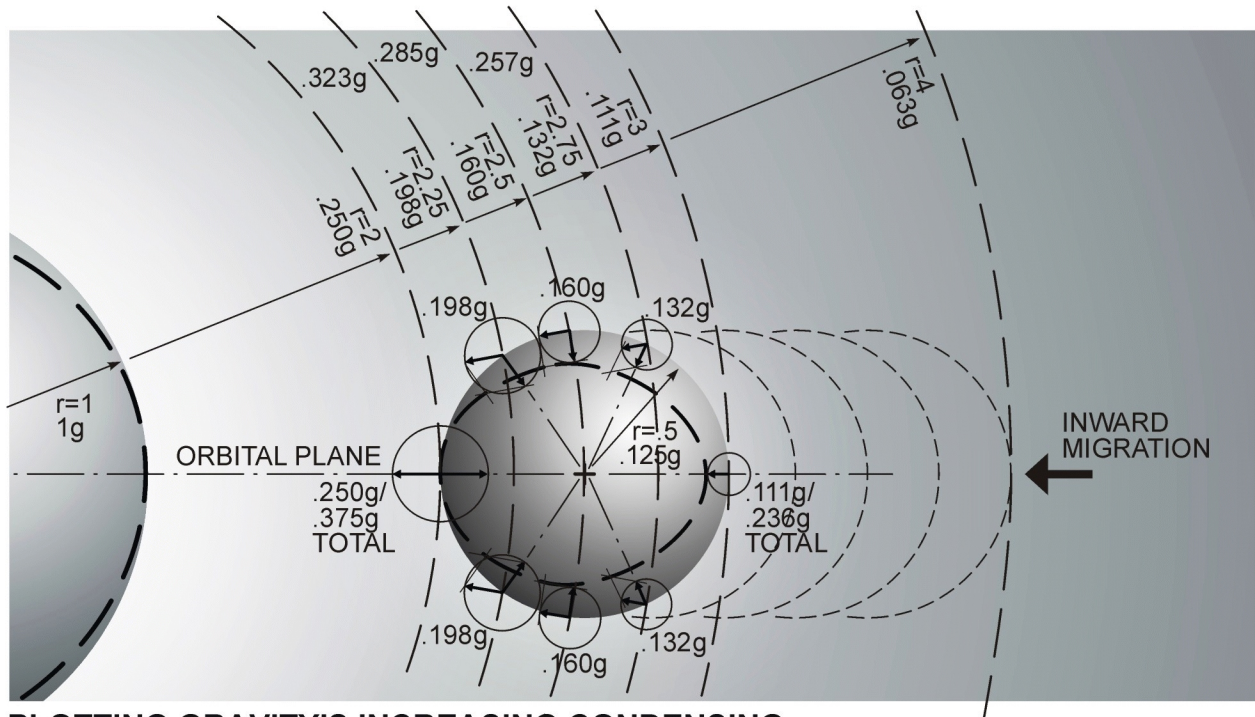

### PLOTTING GRAVITY'S INCREASING CONDENSING

### THE SHAPE OF GRAVITATING BODIES - 3

The continued condensing of gravitating bodies can be demonstrated by approximating gravity's force at the closer distance of 2 radiuses the same way we did at the 3 radius distance. Comparing the results, we can quickly see the compounding effect of gravity's diffusing fields: more asymmetrical ellipsoidal condensing with increasing distortion. No stretching. No spaghettifying.

With gravitation's inherent runaway coalescing, their condensing continues unabated until a centrifugal force disperses the smaller, its diffusion beginning from its backside, or their eventual merging creates enough inward pressure from their combined fields to trigger fusion reactions that convert them back into the radiant energy they originated from.

**Figure 4.3**

(11.3 Shape v 10a)

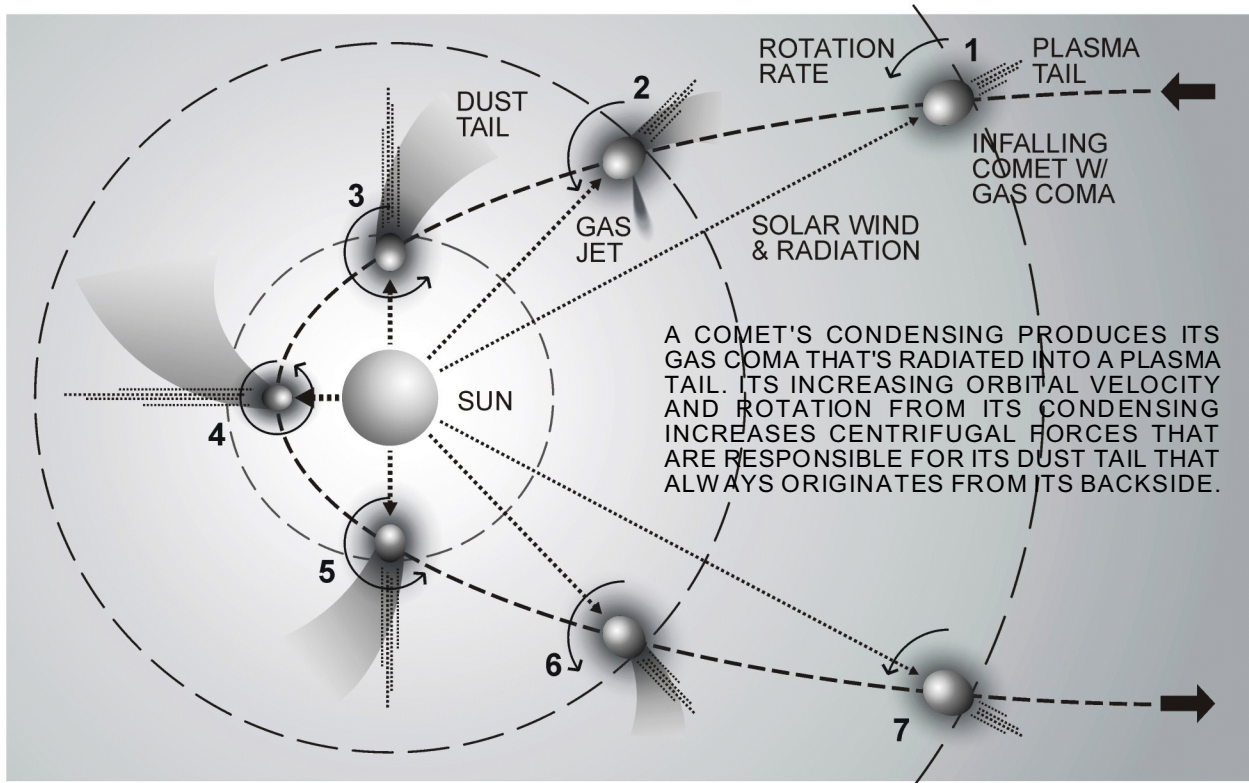

## GRAVITY'S EFFECT ON COMETS

### THE SHAPE OF GRAVITATING BODIES - 4

1. A comet that was theoretically uniform and pliable would assume the shape of an asymmetrical ellipsoid oriented with its smaller more pointed end always facing away from the Sun due to the compounding of its and the Sun's gravity field, portrayed in section view as the diffusing background. Its ongoing condensing in the exponentially decreasing density of the Sun's gravity field at first gently squeezes out its gas, mostly hydrogen, to form its coma that may or may not have been evaporated/sublimated from internal material by the intensifying pressure and heat from its increasing compression. The Sun's radiant energy then begins to ionize the gas and blow it straight back to form the comet's plasma tail.

2. As its condensing continues, the gas is sometimes seen jetting out at high velocities, confirming its internal origin that's more likely caused by pressure originating from its increasing condensing than external heat from increasing sunlight.

3. The comet's increasing condensing also increases its rate of rotation, indicated by the increasing length of the radiused arrows. When its outward acting rotational and orbital centrifugal forces begin to exceed gravity's inward acting condensing, its material begins to dislodge, fall away, and disperse into an arcing fan shape to form its dust tail. This always occurs from the comet's backside opposite the Sun where the combined centrifugal forces are the strongest and gravity's compounded condensing is the weakest.

4. The comet's coma along with its plasma and dust tails continue to increase until it reaches its closest point to the Sun, perihelion, where its condensing and centrifugal forces and the Sun's radiant energy are all at their maximum.

5. As it begins to leave the Sun's vicinity, the now increasing density of the Sun's gravity field begins to reverse the comet's condensing that in turn slows its rate of rotation. Together with its slowing orbital velocity, its rotational and orbital centrifugal forces weaken, curbing its loss of material, which reduces the size of its dust tail.

6. As it continues to move farther away, solar wind and radiation also diminish, reducing the size of its plasma tail as well.

7. The comet's condensing continues to ease all the way to its aphelion, its farthest point from the Sun, where the pressure from its compression that produces the outgassing that forms its coma is at its weakest [9].

**Figure 4.4**

(11.4 Shape v 10a)

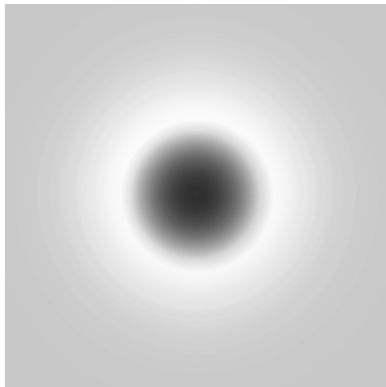

1. PROTON

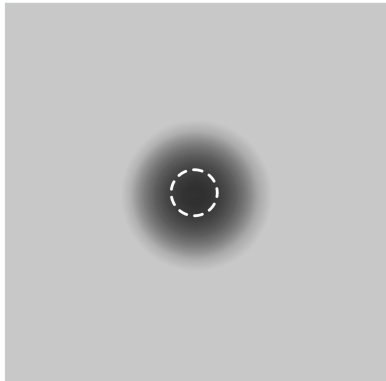

2. ELECTRON



3. HYDROGEN ATOM

## ATOMS

Protons should not be considered tiny physical particles within an electromagnetic field but as the field itself. There's no surface where the field stops and matter begins. The field becomes progressively more dense until it peaks at its center, represented in section view by the darker diffused circle in **1** & **3**. But because that proton field has condensed out of the universal field of electromagnetic radiation, the ambient radiation not drawn into the proton has to decrease in density around it diffusing exponentially like any field because of the geometry of a sphere.

But its diffusion disperses inward not outward, which defines its gravity field, depicted in section by the diffusing background in **1** & **3**. Because the decreasing density of a proton's gravity field is larger than the increasing density of its electromagnetic field, the gravity field's compounding with the fields of other particles tends to push them together as they naturally pursue equilibrium, mechanically seeking the lowest density that always lies directly between them. So protons should actually be considered negatively charged.

Convention has protons positive charged and electrons negative. Apparently, this has been mostly an arbitrary designation. But it doesn't correspond to physical reality. It's one of the reasons why gravitation and electromagnetism are not recognized as being the same effect.

Electrons should also be considered as having condensed out of the universal field. Its charge is considered equal to that of a proton. But its mass is 1/1837th as much. So it yields a much smaller gravity field, indicated by the small white dashed circle. For graphic clarity, it's shown proportionally much larger than it would actually be.

Being that the decreasing density of its gravity field is smaller than the increasing density of its electromagnetic field, it has a repulsive effect that when compounded with the fields of other electrons tends to push them away. So in reality it's positively charged. With the electromagnetic field of the electron still smaller than the gravity field of the proton, the compounding of their fields still pushes them toward one another.

An atom's electrons should not be envisioned as small objects that rapidly orbit the nucleus as always portrayed. They're more accurately conceived as having been pressed down and smeared out all over and around the entire nucleus, spherically, three-dimensionally, by the decreasing density of the universal field enveloping it, the atom's gravity field. It's compressed to a level where the repulsive effects of all the fields balance out and find equilibrium, as is implied in the section view through a hydrogen atom that has only one electron and one proton [10].

**Figure 5.1**

(18.1 Atoms v 8a)

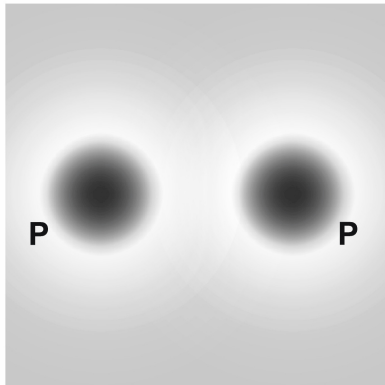

1. TWO PROTONS

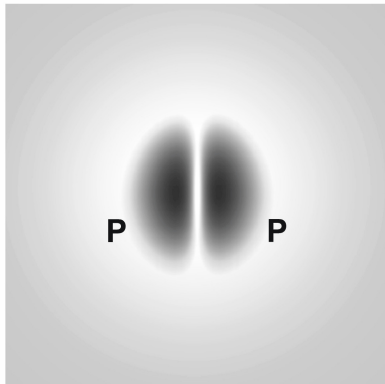

2. PAIRED PROTONS

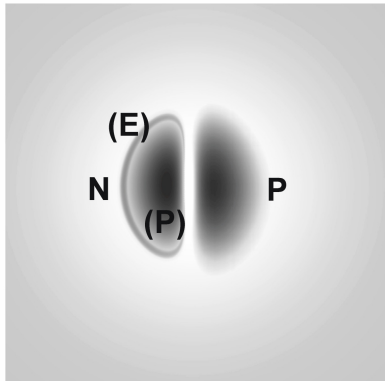

3. NEUTRON & PROTON

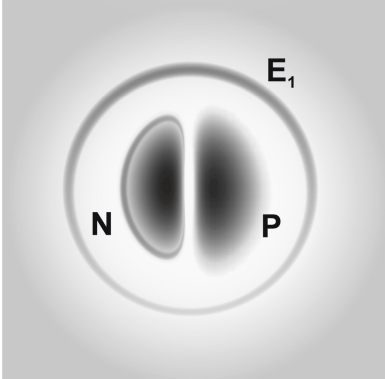

4. HYDROGEN ISOTOPE

## NEUTRONS & ISOTOPES

A neutron can be considered a merging of a proton and an electron. The compounding of their two electromagnetic fields and their two gravity fields are theoretically balanced to yield no charge, that is if it could stand alone. Its neutral charge suggests that the electromagnetic fields of protons and electrons are half as strong as their combined gravitational fields.

For numerical convenience, if we assume the strength of a proton's gravity field is (-1), negative because of the field's decreasing density, and we know that an electron's is 1/1837th of that (-.00054) then their electromagnetic fields would have to be half of (-1) + (-.00054) or (+.50027), positive because of its increasing density. So a proton's relative charge would be its gravity field (-1) plus its electromagnetic field (+.50027) or (-.49973). And an electron's relative charge would be its gravity field (-.00054) plus its electromagnetic field (+.50027) or (+.49973).

Neutrons usually only exist, though, through the initial pairing of two protons, located at **P**. The compounding of the decreasing density of their fields, (-.49973) + (-.49973) or (-.99946), first draws them together mechanically as they naturally seek equilibrium. Then the even higher decrease in density of their combined fields draws in and tightly holds an electron, which is positively charged (+.49973), located at **E**, to create, or define, a neutron, located at **N**.

It's likely that the electron may move back and forth between protons or at times envelop both at once. But the three together still have a negative charge, or a field of decreasing density of (-.49973), that can draw in another electron (+.49973), located at **E<sub>1</sub>**, to achieve a balanced state, in this case deuterium an isotope of hydrogen.

The actual distance to the electron would be over 60,000 times the radius of the nucleus. At the scale depicted that would put it more than 100yds away. The important principle that's trying to be conveyed here is that it's the sequence in which the particles assemble, which is facilitated by the relative densities or actual charge of their fields, that is responsible for the creation of a neutron. Otherwise, you'd just end up with a hydrogen atom [11][12].

**Figure 5.2**

(18.2 Atoms v 8a)

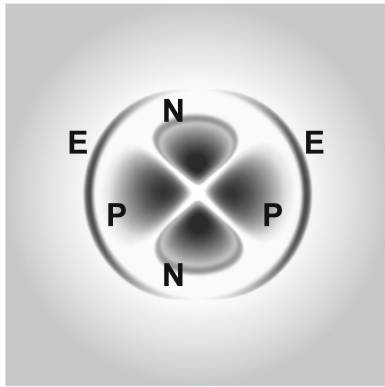

1. HELIUM ATOM



2. NEGATIVE ION (-E)



3. POSITIVE ION (+E)

## IONS

The actual charge of an ion is also opposite of convention. If we begin with a ground state helium atom, shown theoretically in a section view through its center, the electromagnetic and gravity fields of its two protons, located at **P**, and two electrons, at **E**, balance to neutralize its charge. Its neutrons, at **N**, already a combination of an electron and proton, remain neutral.

If one of the electrons is removed, as depicted in section view in **2**, the density of its combined fields would be decreased where its relative charge, as calculated in the previous diagram, would be (-.49973), where its gravity fields dominate, which would tend to draw in other particles, making its charge negative.

If an electron were added, as represented in section view in **3**, the density of its combined fields would be increased. Its relative charge would be (+.49973), where its electromagnetic fields dominate, which would tend to push away other particles, making its charge positive.

A decreasing density in the universal field, a gravity field, is a negative charge that tends to push inward. The increasing field density of a particle's electromagnetic field is a positive charge that tends to push outward. It's the inherent repulsive nature of a particle's, or any object's, electromagnetic field that mechanically causes them to seek equilibrium in the universal field that innately decreases in density around every particle, or object.

Their reactive search for the lowest density in their combined fields that always lies directly in between them, or toward a common center of mass for multiple objects, causes them to move toward one another in an apparent attraction. It's the same repulsive effect of their interacting fields that pushes or holds them apart when they attain equilibrium.

Protons and neutrons and electrons are not bound together or repelled by imaginary strong and weak nuclear forces that are magically transmitted by unseen massless particles. Gravitation resulting from electromagnetism is simply governing all their interactions [13].

**Figure 5.3**

(18.3 Atoms v 8a)

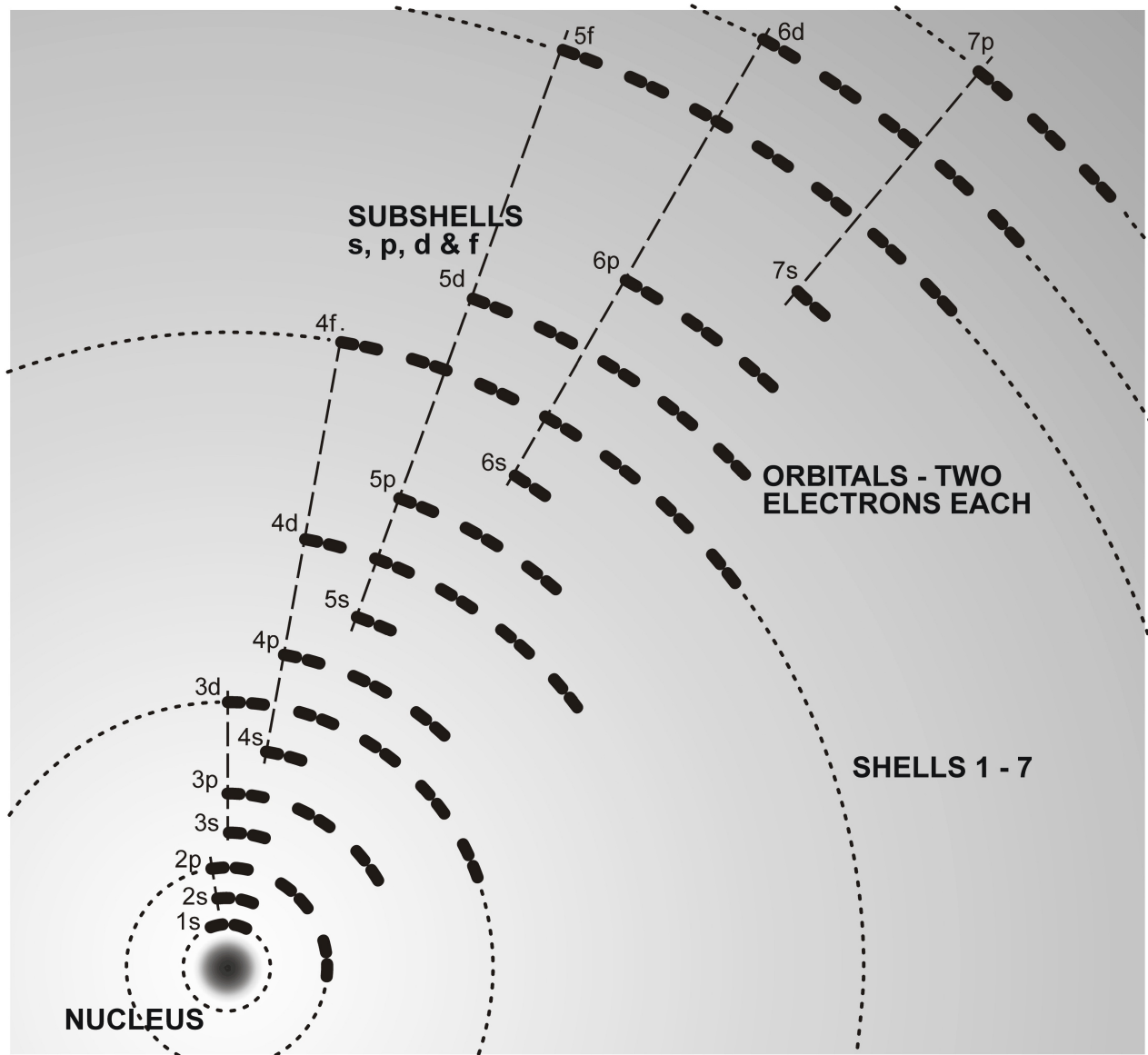

### AUFBAU OR BUILD-UP PRINCIPLE OF ELECTRONS

This diagram shows how the electrons of all the known elements theoretically distribute themselves around an atom's nucleus according to the build-up principle. It depicts seven shells (1 - 7) and their four subshells (s, p, d & f) that contain either 1, 3, 5 or 7 orbitals. Each orbital consists of two electrons.

Electrons tend to fill lower "energy" levels, or gravitate toward the nucleus, pushed inward and smeared out all around it by the increasing force of the decreasing density of the atom's gravity field, portrayed in section by the inward diffusing background, while the repulsive nature of their electromagnetic fields holds them apart. It always keeps them, along with the protons and neutrons at the nucleus, at their maximum distance from one another, which increases from the center out as gravity's force decreases exponentially.

It's important to note the electrons' outward diffusion. They disperse exponentially because of the geometry of a sphere. It's also important to know that they're not paired up side by side in each orbital as the diagram implies. Their repulsive nature ensures their even distribution over the entire nucleus. The same is true in the outward direction. Gravity's ever-decreasing field density pushes them inward causing them to nestle in between one another, naturally pursuing their most balanced and stable distribution that ends up forming shells and subshells that express symmetrically at each consecutive level [14].

**Figure 5.4**

(18.4 Atoms v 8a)

## **Conclusion**

If the fundamental constituent of the universe is an infinitely vast field of radiant electromagnetic energy, that it's continuous and uninterrupted, and that particles condense out of it then runaway gravitation has to naturally proceed as a matter of course from a particle's inception. Given the exponential gradient intrinsic to electromagnetic/gravity fields, what else can be concluded?

Is it actually possible that gravity and its long sought-after unification with electromagnetism could be no more difficult than simply recognizing this unassuming self-evident reality?

## **Coda**

The reason gravity and unification have been so elusive first begins with our incorrect assumption about space. It's not something. By definition, it doesn't exist. It's the nothingness between objects [15]. So there's nothing there to curve (or to expand, or stretch, or cause light's redshift from stretching). Then we try to meld that nonexistent space with a nonexistent time into an inconceivable four-dimensional "spacetime" [16].

Time also does not exist. It's not an inherent property of the universe [17]. It's a concept we've created through our selection of objects with periodic motion, like the Earth's rotation and orbit or the natural frequency of cesium atoms of atomic clocks, that establishes a convention that we use as a reference.

We then try to make that purely theoretical four-dimensional abstraction curve two-dimensionally as a nonexistent plane [18]. A plane by definition doesn't exist either. Its two-dimensionality can only define a location that's planar [19].

Curvature is a property limited to one or two dimensions [20]. In three dimensions, any change in a substance can only express as a variation in density [21]. Conceptually, it cannot curve.

Then we make that curving, two-dimensional, nonexistent plane of inconceivable, four-dimensional, nonexistent spacetime somehow dent underneath three-dimensional massive bodies as if they were all affected by the pull of the gravity



of a much more massive body positioned underneath them. The denting would somehow induce their attraction by somehow causing them to roll downhill toward one another despite not actually rolling or being uphill [22]. If this were actually possible, it'd be a mechanical reaction, which act instantaneously [23].

All of this conflicted nonsense is at odds with more unworkable dogma that has gravity propagated by a force similar to electromagnetism that somehow pulls bodies together, acting at the speed of light via waves [24]. But at the same time, that attraction is also somehow mitigated by unobservable massless graviton particles that somehow exist physically without mass [25]. Which if they actually were particles, wouldn't be able to act at the speed of light either. They'd relativistically become infinite [26].

Rarely is any of this entrenched proprietary ideology ever questioned. Ingrained and compulsory, we unwittingly proceed like lemmings under the rote groupthink assumption that it's all true despite its conspicuous untenability in our real nontheoretical world of three actual dimensions.

## Declarations

The author certifies that he did not receive any funding, grants, or any type of support from any individual, institution, or organization in the connection with the study or preparation of this work. The author further certifies that he does not have any financial or competing interests in connection with this work or ties of any kind to any individual or organization that might.

## References

- [1] "Radiant energy," Wikipedia: The Free Encyclopedia, last modified Jan 12, 2024, [https://en.wikipedia.org/wiki/Radiant\\_energy](https://en.wikipedia.org/wiki/Radiant_energy).
- [2] "Subatomic particle," Encyclopedia Britannica, last update Jul 13, 2023, <https://www.britannica.com/science/subatomic-particle>.
- [3] Albert Einstein, *Relativity: The Special and the General Theory*, 15th ed. Translated by Robert W. Lawson (New York: Three Rivers Press, 1961), *vii*.
- [4] "Inverse Square Law," Hyperphysics, last access Dec 28, 2022, <http://hyperphysics.phy-astr.gsu.edu/hbase/Forces/isq.html>.
- [5] "Center of mass," Wikipedia, last modified Jan 29, 2024, [https://en.wikipedia.org/wiki/Center\\_of\\_mass](https://en.wikipedia.org/wiki/Center_of_mass).
- [6] "Newton's law of universal gravitation," Wikipedia, last modified Feb 6, 2024, [https://en.wikipedia.org/wiki/Newton%27s\\_law\\_of\\_universal\\_gravitation](https://en.wikipedia.org/wiki/Newton%27s_law_of_universal_gravitation).
- [7] "Lagrange point," Wikipedia, last modified Jan 18, 2024, [https://en.wikipedia.org/wiki/Lagrange\\_point](https://en.wikipedia.org/wiki/Lagrange_point).
- [8] "Tides," NASA, last update Feb 19, 2024, <https://science.nasa.gov/moon/tides/>.
- [9] "Comet," Wikipedia, last modified Jan 11, 2024, <https://en.wikipedia.org/wiki/Comet>.
- [10] "Atom," Wikipedia, last modified Feb 19, 2024, <https://en.wikipedia.org/wiki/Atom>.
- [11] "Neutron," Wikipedia, last modified Feb 19, 2024, <https://en.wikipedia.org/wiki/Neutron>.
- [12] "Isotope," Wikipedia, last modified Feb 19, 2024, <https://en.wikipedia.org/wiki/Isotope>.
- [13] "Ion," Wikipedia, last modified Feb 15, 2024, <https://en.wikipedia.org/wiki/Ion>.
- [14] "Aufbau principle," Wikipedia, last modified Feb 12, 2024, [https://en.wikipedia.org/wiki/Aufbau\\_principle](https://en.wikipedia.org/wiki/Aufbau_principle).
- [15] "Space," Merriam-Webster Dictionary, last modified Mar 26, 2023, <https://www.merriam-webster.com/dictionary/space>.
- [16] Einstein, *Relativity*, 61-64.
- [17] "Time," Merriam-Webster, last modified Mar 28, 2023, <https://www.merriam-webster.com/dictionary/time>.

- [18] Einstein, *Relativity*, 71-73, 92-107, 112-116.
- [19] "Plane (mathematics)," Wikipedia: The Free Encyclopedia, last modified May 25, 2023, [https://en.wikipedia.org/wiki/Plane\\_\(mathematics\)](https://en.wikipedia.org/wiki/Plane_(mathematics)).
- [20] "Curvature," Britannica, last update Feb 17, 2023, <https://www.britannica.com/science/curvature>.
- [21] "Density," Britannica, last update Jul 4, 2023, <https://www.britannica.com/science/density>.
- [22] "Gravity," Wikipedia, last modified Jan 1, 2023, <https://en.wikipedia.org/wiki/Gravity>.
- [23] "Reaction, (physics)," Wikipedia, last modified Jul 9, 2023, [https://en.wikipedia.org/wiki/Reaction\\_\(physics\)](https://en.wikipedia.org/wiki/Reaction_(physics)).
- [24] Einstein, *Relativity*, 72.
- [25] "Graviton," Wikipedia, last modified Nov 29, 2022, <https://en.wikipedia.org/wiki/Graviton>.
- [26] Einstein, *Relativity*, 50.

## **Bibliography**

- Arp, Halton. *Seeing Red: Redshifts, Cosmology & Academic Science*. Montreal: Aperiron, 1998.
- Einstein, Albert. *The Meaning of Relativity*. 5th ed. Translated by Edwin Plimpton Adams, Ernst G. Straus, Sonja Bargmann. Princeton: Princeton University Press, 1953.
- Einstein, Albert. *Relativity: The Special and the General Theory*. 15th ed. Translated by Robert W. Lawson. NY: Three Rivers Press, 1961.
- Encyclopedia Britannica, last access 2024, <https://www.britannica.com>.
- Gonder, Ken. *The Reality of Relativity*. 7.4 240306, Last revision 2024. Amazon, Independently published, 2018, <https://www.amazon.com/dp/B07CVMDV66>, (LCCN: 2020901711).
- Hyperphysics, last access 2024, <http://hyperphysics.phy-astr.gsu.edu>.
- Merriam-Webster Dictionary, last access 2024, <https://www.merriam-webster.com>.
- NASA, last access 2024, <https://www.nasa.gov>.
- Science News*, 1999 - 2018. <https://www.sciencenews.org>.
- Scientific American*, 1994 - 2024, <https://www.scientificamerican.com>.
- Sky & Telescope*, 2000 - 2024, <https://skyandtelescope.org>.
- Wikipedia: The Free Encyclopedia, last access 2024, <https://www.wikipedia.org>.