

# On the L-functions from Generalized Riemann hypothesis, Birch and Swinnerton-Dyer conjecture, and the Prime numbers from Polignac's and Twin prime conjectures

By John Y. C. Ting, the corresponding author who contributes to all work in this research paper.

## Abstract

We analyze L-functions of elliptic curves (and apply Sign normalization) which support simplest version of Birch and Swinnerton-Dyer conjecture to be true. Dirichlet eta function (proxy function for Riemann zeta function as generating function for all nontrivial zeros) and Sieve of Eratosthenes (generating algorithm for all prime numbers) are essentially infinite series. We apply infinitesimals to their outputs. Riemann hypothesis asserts the complete set of all nontrivial zeros from Riemann zeta function is located on its critical line. It is proven to be true when usefully regarded as an Incompletely Predictable Problem. The complete set with derived subsets of Odd Primes contain arbitrarily large number of elements and satisfy Prime number theorem for Arithmetic Progressions, Generic Squeeze theorem and Theorem of Divergent-to-Convergent series conversion for Prime numbers. Having these theorems being satisfied, Polignac's and Twin prime conjectures are separately proven to be true when usefully regarded as Incompletely Predictable Problems.

## Contents

1. Generic Introduction to Generic Numbers, Generic Terms and Generic Equations	2
1.1. Formally linking Generalized Riemann hypothesis to Birch and Swinnerton-Dyer conjecture	14
2. General notations including Prime number theorem for Arithmetic Progressions and creating <i>de novo</i> Infinite Series	29
3. Generic Squeeze theorem as a novel mathematical tool in Number theory	37
4. Applying Theorem of Divergent-to-Convergent series conversion for Prime numbers in Polignac's and Twin prime conjectures	41
5. Subtypes of Countably Infinite Sets with Incompletely Predictable entities from Sieve of Eratosthenes and Riemann zeta function / Dirichlet eta function	44

---

Keywords: Birch and Swinnerton-Dyer conjecture, Centroid of n-dimensional geometric object, Hodge conjecture, Polignac's and Twin prime conjectures, Riemann hypothesis, Sign normalization, Theory of Symmetry from Langlands program

AMS Classification: Primary: 11M26, 11A41; Secondary: 81Q10.

©John Yuk Ching Ting.

6. Conclusions including applying infinitesimals to outputs from Sieve of Eratosthenes and Riemann zeta function / Dirichlet eta function	47
Acknowledgements, Declarations, Data Availability Statement, and Conflict of Interest Statement	51
References	52
Appendix A. Predictability properties of Dirichlet L-series from Dirichlet L-functions that are relevant to Riemann hypothesis, and Birch and Swinnerton-Dyer conjecture	52

## 1. Generic Introduction to Generic Numbers, Generic Terms and Generic Equations

The great Indian mathematician Srinivasa Ramanujan (December 22, 1887 - April 26, 1920) generalized Euler product for zeta function as  $\prod_{p \in \mathbb{P}} \left( x - \frac{1}{p^s} \right) \approx \frac{1}{\text{Li}_s(x)}$  for  $s > 1$  where  $\text{Li}_s(x)$  is polylogarithm. Here we use notation  $\mathbb{P}$  for set of all prime numbers and  $\mathbb{N}$  for set of all natural numbers; viz,  $\mathbb{P} = p \in \mathbb{N} \mid p \text{ is prime}$ . For  $x = 1$  the product is just  $\frac{1}{\zeta(s)}$ ; which is the reciprocal of Riemann zeta function  $\zeta(s)$ . In the same spirit, we generalize Diophantine equation [typically a polynomial equation in two or more unknowns with integer coefficients] for which only integer  $\mathbb{Z}$  or rational  $\mathbb{Q}$  solutions are of interest: **Generic  $n$ -variable degree  $n$  Diophantine equations = I. (Polynomial) Diophantine equations** e.g.  $2^n - 7 = x^2$  [Ramanujan-Nagell equation, which is an exponential Diophantine equation with additional variable(s) occurring as exponents],  $x^d + y^d - z^d = 0$  [equation of Fermat's Last Theorem],  $y^2 = x^3 + ax + b \equiv y^2 - x^3 - ax - b = 0$  [2-variable degree 3 Diophantine equations for elliptic curves] + **II. (Non-polynomial) Diophantine equations** e.g.  $1 + 2^x + 2^{2x+1} = y^2$ . We concentrate below on (Polynomial) Diophantine equations.

Problems involving 1-variable Diophantine equations of degree  $n$  e.g.  $3x^4 + 5x^3 + x^2 + 5x - 2 = 0$  [of degree 4], are "very easy" to solve. Problems involving  $\geq 3$ -variable Diophantine equations, e.g. from Bombieri-Lang conjecture and Brauer-Manin obstruction, are "very hard" to solve. Problems involving 2-variable degree 1 or degree 2 [viz, Genus 0] Diophantine equations e.g.  $x^2 + y^2 - 1 = 0$  [of degree 2] are "easy" to solve. Problems involving 2-variable degree  $\geq 4$  [viz, Genus  $\geq 2$ ] Diophantine equations e.g.  $y^2 - x^6 - x^2 - 1 = 0$  [of degree 6] are "hard" to solve. Problems involving 2-variable degree 3 [viz, Genus 1] Diophantine equations e.g. equations for all elliptic curves having various Analytic rank 0, 1, 2, 3, 4, 5... are neither "too hard" nor "too easy" to solve. A (non-)homogeneous Diophantine equation is a Diophantine equation that is further defined by a (non-)homogeneous polynomial e.g. *non-homogenous* 2-variable 3-degree Diophantine equations for elliptic curves [ $\equiv$  "mixed" Monomial of variable  $x$  degree 3 + Monomial of variable  $y$  degree 2 (as given above)], and *homogenous* 3-variable degree  $d$  Diophantine equations for Fermat's Last Theorem (as given above). The definition of elliptic curve from algebraic geometry is *connected non-singular projective curve of Genus 1 with a given rational point on it*.

**Generic Summary:** Polignac's and Twin prime conjectures are posits on Cardinality property of a chosen **Generic Number** called Prime numbers [which are '**OUTPUTS**' from Sieve of Eratosthenes]. Here, Twin prime conjecture (on even Prime gap = 2) is a subset of Polignac's conjecture (on all even Prime gaps 2, 4, 6, 8, 10...). Generic L-functions [see Remark 1.7], that must obey three Axioms [stated in Remark 1.3], are an important source of **Generic Equations** [with infinitely-many **Generic Terms**] having major properties of Algebraic rank, Analytic rank, trivial zeros and nontrivial zeros. Generalized Riemann hypothesis and 'special case' Riemann hypothesis are conjectures on, respectively, all (Generic) L-functions and two specific "prototypical" L-functions (known as Riemann zeta function and its *proxy* [via Analytic continuation] Dirichlet eta function, which are often [*incorrectly*] interchanged with each other). Together, they conjectured entire sets of unique nontrivial zeros (spectrum) [as '**OUTPUTS**'] of any L-function are always located on  $\sigma = \frac{1}{2}$ -Critical Line [or on Analytically normalized  $\sigma = \frac{1}{2}$ -Critical Line]. An important caveat: (Analytic rank 0) Riemann zeta function DO NOT have any nontrivial zeros *versus* (Analytic rank 0) Dirichlet eta function DO have all nontrivial zeros [albeit its first nontrivial zero is NOT given by  $t = 0$ ]. Birch and Swinnerton-Dyer (BSD) conjecture concern two nominated properties of a particular type of "more complex" (Analytic rank 0, 1, 2, 3, 4, 5...) L-functions present in all Elliptic curves [classified as degree 2; based on degree of these L-functions being the number  $J + 2K$  of Gamma factors occurring in their functional equations]. Specifically, it (mainly) proposes these L-functions that are "individualized" for each and every Elliptic curves have Algebraic rank = Analytic rank [ $\equiv$  Mordell-Weil rank as  $r$  integer values]. This statement is known to be correct for Analytic rank  $r = 0$  and 1; viz, upper bound on true Analytic rank is necessarily tight due to parity. For Analytic ranks  $r = 2$  and 3, results indicate this upper bound is also tight. For Analytic ranks  $r \geq 4$ , results for their upper bound are difficult to obtain. See Remarks 1.1 "Rank, Degree, Symmetry and Abelian group" and 1.5 "Algebraic rank vs Analytic rank".

[Note: Completely Predictable **trivial zeros** of an L-function are defined later on in Remark 1.3 below.] Incompletely Predictable **nontrivial zeros** (spectrum) of an L-function are the complex numbers from complex variable  $s [= \sigma \pm it]$  for which  $L(s) = 0$ . Under Generalized Riemann hypothesis, every nontrivial zero [as  $s$  having  $\mathbb{C}$  values, and conventionally represented by  $t$  having  $\mathbb{R}$  values in  $0 < t < +\infty$  range] lies on Critical Line  $\Re(s) = \frac{1}{2}$  (in Analytic normalization). The lowest nontrivial zero of an L-function  $L(s)$  is the least  $t > 0$  for which  $L(\frac{1}{2} + it) = 0$ . Note that even when  $L(\frac{1}{2}) = 0$ , the lowest nontrivial zero is by "traditional" definition a positive  $t$ -valued real number. As functions of complex variable  $s$ , L-functions for elliptic curves are denoted by  $L(E, s)$  or  $L_E(s)$ , with these symbols used interchangeably in this paper. **They have Analytic rank of zero integer value [whereby  $L(1) \neq 0$  and  $t \neq 0$  for first nontrivial zero] or non-zero integer values [whereby  $L(1) = 0$  and  $t = 0$  for first nontrivial zero].** Analytic rank 0  $\implies$  associated L-functions NEVER have first nontrivial zero given by ( $\mathbb{R}$ -valued) variable  $t = 0$ . Analytic rank  $\geq 1$  [viz, 1, 2, 3, 4, 5... up to an arbitrarily large number value]  $\implies$  associated L-functions ALWAYS have first nontrivial zero given by ( $\mathbb{R}$ -valued) variable  $t = 0$ . We recognize overlapping aspects of our major conjectures and hypotheses: "Non-elliptic" L-functions from Riemann hypothesis possess Analytic rank [= 0 in both cases]. "Elliptic" L-functions from elliptic curves have unique nontrivial zeros

(spectrum) that are all located on [Analytically normalized]  $\sigma = \frac{1}{2}$ -Critical Line. As per Appendix A, L-functions of various Elliptic curves have Analytic rank of 0, 1, 2, 3, 4, 5... with altered ["-ve odd"] Point symmetry / ["+ve even"] Line symmetry, frequency and complexity in nontrivial zeros (spectrums) that are correlated to increasing Analytic ranks. For every elliptic curve over  $\mathbb{Q}$  of conductor  $N$ , there is a **unique weight 2 newform for  $\Gamma_0(N)$**  [as its associated (classical) modular form] with same L-function. Modular forms of same weight and multiplier system that are defined over the same group form a  $\mathbb{C}$ -vector space. Finding complex relationships using e.g. Analytic rank, conductor  $N$ , size of [finite] integral points, various internal symmetry in their modular forms, etc is an important research aspect of BSD conjecture.

*Remark 1.1. Rank, Degree, Symmetry and Abelian group:* A group is abelian if its operation is commutative. An abelian variety defined over the field  $K$  is a smooth connected projective variety equipped with the structure of an algebraic group. The group law is automatically commutative. **An abelian variety of dimension 1 is the same as an elliptic curve.** The degree of an L-function is the number  $J + 2K$  of Gamma factors occurring in its functional equation. All elliptic curves have L-functions of degree 2, but can have Analytic rank 0, 1, 2, 3, 4, 5.... An abelian surface [e.g. given by product of two elliptic curves, Jacobian of a curve of genus 2, etc] is an abelian variety of dimension 2. A number field  $K$  is abelian if it is Galois over  $\mathbb{Q}$  and its Galois group  $Gal(K/\mathbb{Q})$  is abelian. A finite group  $G$  is metabelian if its commutator subgroup is abelian. Equivalently,  $G$  is an extension of an abelian group by an abelian group. Metabelian groups are solvable, and they include all abelian, dihedral, quaternion, metacyclic, extraspecial groups and groups of  $p$ -rank one. Every metacyclic group is metabelian, but the converse does not hold.

The rank of a finite group  $G$  is the minimal number of elements required to generate it, which is often smaller than the number of generators in a polycyclic presentation. The rank of a number field  $K$  is the size of any set of fundamental units of  $K$ . It is equal to  $r = r_1 + r_2 - 1$  where  $r_1$  is the number of real embeddings of  $K$  into  $\mathbb{C}$  and  $2r_2$  is the number of complex embeddings of  $K$  into  $\mathbb{C}$ . **The [Analytic] rank of an elliptic curve  $E$ , with L-function  $L(E, s)$ , defined over a number field  $K$  is the rank of its Mordell-Weil group  $E(K)$ .** Mordell-Weil Theorem says that  $E(K)$  is a finitely-generated abelian group, hence  $E(K) \cong E(K)_{\text{tor}} \times \mathbb{Z}^r$  where  $E(K)_{\text{tor}}$  is the finite torsion subgroup of  $E(K)$ , and  $r \geq 0$  is the rank. Since it is known that  $L(E, s)$  satisfies Hasse-Weil conjecture, then **the parity of Analytic rank [as explained later on below] is always compatible with the sign of its functional equation [as explained later on below]**. Rank is an isogeny invariant: all curves in an isogeny class have the same rank. [Please see Remark 1.5 below on Algebraic rank vs Analytic rank for elliptic curves.]

A  $p$ -adic field (or local number field) is a finite extension of  $\mathbb{Q}_p$ , equivalently, a nonarchimedean local field of characteristic zero. A  $p$ -group is a group whose order is a power of a prime  $p$ . A result of Higman and Sims shows that the number of groups of order  $p^k$  is  $p^{(2/27+o(1))k^3}$ , and this can be combined with a result of Pyber to show that, asymptotically, 100% of groups are  $p$ -groups. For  $p$ -groups, the rank can be computed by taking the  $\mathbb{F}_p$ -dimension of the quotient by the Frattini subgroup. Let  $A/\mathbb{F}_q$  be an abelian variety where  $q = p^r$ . The  $p$ -rank of an abelian variety is the dimension of the geometric  $p$ -torsion as a

$\mathbb{F}_p$ -vector space:  $p$ -rank( $A$ ) =  $\dim_{\mathbb{F}_p}(A(\overline{\mathbb{F}_p})[p])$ . The  $p$ -rank is at most the dimension of  $A$ , with equality if and only if  $A$  is ordinary; the difference between the two is the  $p$ -rank deficit of  $A$ .

**Symmetric power of an L-function:** Let  $L(s)$  be an L-function given by an Euler product  $L(s) = \prod_{p \notin S} \prod_{j=1}^r \left(1 - \frac{\alpha_j}{p^s}\right)^{-1} \times \prod_{p \in S} L_p(s)$ , where  $S$  is a finite set of primes. The symmetric  $n^{\text{th}}$  power of  $L(s)$  is an L-function given by an Euler product  $L(s, \text{sym}^n) = \prod_{p \notin S} \prod_{\substack{\text{degree}-n \\ \text{monomials } m}} \left(1 - \frac{m(\alpha_1, \dots, \alpha_r)}{p^s}\right)^{-1} \times \prod_{p \in S} L_p(s, \text{sym}^n)$ .

The Euler factors at the primes  $p \in S$  (the "bad" primes) are computed via a more complicated recipe which involves a non-trivial amount of information about the underlying object. The degree of an Euler factor at one of the "bad" primes will be smaller than the degree of the Euler factors outside the set  $S$ .

**Remark 1.2. Formal statements on Birch and Swinnerton-Dyer (BSD) conjecture:** The central value of an L-function is its value at central point of Critical Strip. The central point of an L-function is the point on real axis of Critical Line. Equivalently, it is the fixed point of functional equation. In Analytic normalization, the central point is  $s = \frac{1}{2}$ . In Arithmetic normalization, it is  $s = \frac{w+1}{2}$ , where  $w$  is the weight of L-function. These definitions are, of course, applicable to all L-functions of elliptic curves.

Rodriguez-Villegas and Zagier[5] have proven a formula, conjectured by Gross and Zagier[1], for central value of  $L(s, \chi^{2n-1})$ , namely  $L(1/2, \chi^{2n-1}) = 2 \frac{(2\pi \sqrt{7})^n \Omega^{2n-1} A(n)}{(n-1)!}$  where  $\Omega = \frac{\Gamma(1/7)\Gamma(2/7)\Gamma(4/7)}{4\pi^2}$ . By the functional equation  $A(n) = 0$  whenever  $n$  is even. For odd  $n$  Gross and Zagier conjectured that  $A(n)$  is a square [and provide tabulated values using their notation]. Rodriguez-Villegas and Zagier then prove that  $A(n) = B(n)^2$  where  $B(1) = 1/2$  and  $B(n)$  is an integer for  $n > 1$ ; and that  $A(n)$  is given by a remarkable recursion formula [not stated in this paper]. The accompanying incredible [derived] result of "for odd  $n$ ,  $B(n) \equiv -n \pmod{4}$ ", in one fell swoop, proves the non-vanishing of  $L(1/2, \chi^{2n-1})$  for all odd  $n$ .

BSD conjecture was famously proposed in the early 1960s by British mathematicians Bryan Birch and Peter Swinnerton-Dwyer. Usually stated as two forms, it relates the order of vanishing (or analytic rank) and the leading coefficient of the L-function associated to an elliptic curve  $E$  defined over a number field  $K$  at central point  $s = 1$  to certain arithmetic data, the BSD invariants of  $E$ . (1) The *weak* form of BSD conjecture states just that the analytic rank  $r_{an}$  (that is, the order of vanishing of  $L(E, s)$  at  $s = 1$ ), is equal to the rank  $r$  of  $E/K$ . (2) The *strong* form of BSD conjecture states also that the leading coefficient of the L-function is given by the formula  $\frac{1}{r!} L^{(r)}(E, 1) = |d_K|^{1/2} \cdot \frac{\#\text{III}(E/K) \cdot \Omega(E/K) \cdot \text{Reg}(E/K) \cdot \prod_p c_p}{\#E(K)_{\text{tor}}^2}$ .

The quantities appearing in this formula are as follows:  $d_K$  is the discriminant of  $K$ ;  $r$  is the rank of  $E(K)$ ;  $\text{III}(E/K)$  is the Tate-Shafarevich group of  $E/K$ ;  $\text{Reg}(E/K)$  is the regulator of  $E/K$ ;  $\Omega(E/K)$  is the global period of  $E/K$ ;  $c_p$  is the Tamagawa number of  $E$  at each prime  $p$  of  $K$ ;  $E(K)_{\text{tor}}$  is the torsion order of  $E(K)$ .

Let  $A/\mathbb{F}_q$  be an abelian variety of dimension  $g$  defined over a finite field. Its L-polynomial is the polynomial  $P(A/\mathbb{F}_q, t) = \det(1 - tF_q | H^1((A_{\overline{\mathbb{F}_q}})_{\text{et}}, \mathbb{Q}_l))$ , where  $F_q$  is the inverse of Frobenius acting on cohomology. This is a polynomial of degree  $2g$  with integer coefficients. By a theorem of Weil, the complex roots of this polynomial all have norm  $1/\sqrt{q}$ ; this means that there are only finitely many L-polynomials for any fixed

pair  $(q, g)$ . The L-polynomial of  $A$  is the reverse of Weil polynomial. Let  $K = F_q$  be the finite field with  $q$  elements and  $E$  an elliptic curve defined over  $K$ . By Hasse's theorem on elliptic curves, the precise number of rational points  $\#E(K)$  of  $E$ ; will comply with inequality  $|\#E(K) - (q + 1)| \leq 2\sqrt{q}$ . Implicit in the strong form of BSD conjecture is that the Tate-Sharafevich group  $\text{III}(E/K)$  is finite. There is a similar conjecture for abelian varieties over number fields.

We assign defining polynomial [see Remark 1.6] to be univariate Polynomial  $[x]$  for Riemann zeta function [Analytic rank 0] when based on linear equation " $P$ "  $x = 0$  [degree 1, rank of its Unit group = 0]. We [arbitrarily] assign the defining polynomial to be univariate Polynomial  $[\pm x]$  for its *proxy* function Dirichlet eta function [Analytic rank 0] when based on linear equation " $D$ "  $\pm x = 0$  [degree 1, rank of its Unit group = 0]. An elliptic curve " $E$ " over a field  $K$  is a smooth projective curve of Genus 1 together with a distinguished point  $O$  [viz, the unique point at infinity serving as the identity element]; whereby  $E$  over rational numbers  $\mathbb{Q}$  has a Weierstrass equation of the form  $E: y^2 = x^3 + ax + b$  with  $a, b \in \mathbb{Z}$  such that its discriminant  $\Delta := -16(4a^3 + 27b^2) \neq 0$  [viz, being square-free in  $x$  with the curve being non-singular]. This bivariate equation  $E$  can also be written as  $y^2 - x^3 - ax - b = 0$  [degree 2, Analytic rank 0, 1, 2, 3, 4, 5...]. Elliptic curves are abelian variety; viz, they have an algebraically defined group law with respect to being an abelian group. The algebraic condition discriminant  $\Delta \neq 0$  geometrically imply the graph of  $E$  has **no cusps, self-intersections, or isolated points**. In addition, the real graph of a non-singular curve has **two components if its discriminant is positive**, and **one component if it is negative**. One can [analogously] assign the defining polynomial for an elliptic curve to be a bivariate Polynomial  $[y^2 - x^3 - ax - b]$ . This is a "mixed" Polynomial  $P(x, y) = \text{Monomial } P(x) \text{ of degree 3} + \text{Monomial } P(y) \text{ of degree 2}$ . Topologically, elliptic curves are mathematical objects having **Genus 1** [viz, torus with one "hole"]. They are commonly described as "2-variable (Diophantine) cubic polynomial equations". The **integral points** on a given model of an elliptic curve  $E$  defined over  $\mathbb{Q}$  are points  $P = (x, y)$  on the model that have integral coordinates  $x$  and  $y$ . **The number of integral points is finite**, by a theorem of Siegel.

The order of a generator of Mordell-Weil group is the cardinality of cyclic subgroup it generates. All Analytic rank 0 elliptic curves with trivial Mordell-Weil group structure (Torsion order 1) DO NOT have integral point or torsion generator. Elliptic curves such as Analytic rank 3 LMFDB label 30376.a1  $\{y^2 = x^3 + x^2 - 25x - 21\}$  and Analytic rank 2 LMFDB label 1480.a1  $\{y^2 = x^3 - 28x + 52\}$  have Line Symmetry of horizontal  $x$ -axis, and will [expectedly] manifest " $\pm$  symmetrical" integral points. We list the integral points for e.g. LMFDB label 1480.a1:  $(-6, \pm 2), (-4, \pm 10), (-2, \pm 10), (1, \pm 5), (2, \pm 2), (4, \pm 2), (6, \pm 10), (9, \pm 23), (12, \pm 38), (17, \pm 67), (26, \pm 130), (46, \pm 310), (106, \pm 1090), (412, \pm 8362)$ .

The four basic arithmetic operations are addition, subtraction, multiplication and division. Product (viz, multiplication) of a sequence, denoted by  $\prod$ , can be finite  $\prod_{i=1}^N$  or infinite  $\prod_{i=1}^{\infty}$ . This extended operation in multiplication should be differentiated from dot product, matrix multiplication, scalar multiplication, multiplication of vectors, etc. In our elaborate scheme of defining the "Generic Equation", infinite product

of a sequence such as Euler product is NOT an Equation by itself. However, like computed integrals or derivatives, Euler products could mathematically form a Term, or part of a Term, in a Generic Equation.

Euler product is defined as the expansion of a Dirichlet series into an infinite product indexed by prime numbers. In general, if  $a$  is a bounded multiplicative function, then the Dirichlet series  $\sum_n \frac{a(n)}{n^s}$  is equal to  $\prod_p P(p, s)$  for  $\text{Re}(s) > 1$  where the product is taken over prime numbers  $p$ , and  $P(p, s)$  is the sum  $\sum_{k=0}^{\infty} \frac{a(p^k)}{p^{ks}} = 1 + \frac{a(p)}{p^s} + \frac{a(p^2)}{p^{2s}} + \frac{a(p^3)}{p^{3s}} + \dots$ . In fact, if we consider these as formal generating functions, the existence of such a formal Euler product expansion is a necessary and sufficient condition that  $a(n)$  be multiplicative: this exactly imply  $a(n)$  is the product of the  $a(p^k)$  whenever  $n$  factors as the product of the powers  $p^k$  of distinct primes  $p$ . An important special case is when  $a(n)$  is totally multiplicative, so that  $P(p, s)$  is a geometric series. Then  $P(p, s) = \frac{1}{1 - \frac{a(p)}{p^s}}$  as is the case for Riemann zeta function, where  $a(n) = 1$ , and more generally for Dirichlet characters.

A Dirichlet series is a formal series of the form  $F(s) = \sum_{n=1}^{\infty} \frac{a_n}{n^s}$  where  $a_n \in \mathbb{C}$ ,  $s = \sigma \pm it$  with  $\sigma, t \in \mathbb{R}$ , and  $i = \sqrt{-1}$  is the imaginary unit. A Dirichlet L-function is an L-function defined by a Dirichlet series of the form  $L(s, \chi) = \sum_{n=1}^{\infty} \frac{\chi(n)}{n^s}$ , where  $\chi$  is a Dirichlet character. Here, a Dirichlet character is a function  $\chi : \mathbb{Z} \rightarrow \mathbb{C}$  together with a positive integer  $q$  called the modulus such that  $\chi$  is completely multiplicative, i.e.  $\chi(mn) = \chi(m)\chi(n)$  for all integers  $m$  and  $n$ , and  $\chi$  is periodic modulo  $q$ , i.e.  $\chi(n+q) = \chi(n)$  for all  $n$ . If  $(n, q) > 1$  then  $\chi(n) = 0$ , whereas if  $(n, q) = 1$ , then  $\chi(n)$  is a root of unity. The character  $\chi$  is primitive if its conductor is equal to its modulus. A character has **odd/even parity if it is odd/even as a function**. A Dirichlet character  $\chi : \mathbb{Z} \rightarrow \mathbb{C}$  is odd if  $\chi(-1) = -1$  [ $\implies$  trivial zeros of  $L(s, \chi)$  occur at  $s = -1, -3, -5, -7, \dots$  which correspond to poles of  $\Gamma(\frac{s+1}{2})$  with  $\text{Re}(s) < 0$ ]; and even if  $\chi(-1) = 1$  [ $\implies$  trivial zeros of  $L(s, \chi)$  occur at  $s = 0, -2, -4, -6, -8, \dots$  {viz, also including a trivial zero at  $s = 0$ } which correspond to poles of  $\Gamma(\frac{s}{2})$  with  $\text{Re}(s) < 0$ ]. Let  $\chi_q(n, \cdot) = \prod_{p|q} \chi_{p^e}(n, \cdot)$  be the unique factorization of Dirichlet character  $\chi_q(n, \cdot)$  into characters of prime power modulus  $p^e$  under **Conrey labeling system** (see below). The parity of  $\chi_q(n, \cdot)$  is the **sum of parities of Dirichlet characters**  $\chi_{p^e}(n, \cdot)$ , which can be computed as follows:  
 for  $p > 2$ , the character  $\chi_{p^e}(n, \cdot)$  is even if and only if  $n$  is a square modulo  $p$ .  
 for  $p = 2$  and  $e > 1$  the character  $\chi_{p^e}(n, \cdot)$  is even if and only if  $n$  is a square modulo 4.  
 for  $p = 2$  and  $e = 1$  the character  $\chi_{p^e}(n, \cdot) = \chi_2(1, \cdot)$  is even.

As an example,  $\chi_q(1, \cdot)$  is always trivial,  $\chi_q(m, \cdot)$  is real if  $m^2 = 1 \pmod{q}$ , and for all  $m, n$  coprime to  $q$  we have  $\chi_q(m, n) = \chi_q(n, m)$ . For prime powers  $q = p^e$  we define  $\chi_q(n, \cdot)$  as follows:

For each odd prime  $p$  we choose the least positive integer  $g_p$  which is a primitive root for all  $p^e$ , and then for  $n \equiv g_p^a \pmod{p^e}$  and  $m \equiv g_p^b \pmod{p^e}$  coprime to  $p$  we define  $\chi_{p^e}(n, m) = \exp\left(2\pi i \frac{ab}{\phi(p^e)}\right)$ .

$\chi_2(1, \cdot)$  is trivial,  $\chi_4(3, \cdot)$  is the unique nontrivial character of modulus 4, and for larger powers of 2 we



choose  $-1$  and  $5$  as generators of the multiplicative group. For  $e > 2$ , if  $n \equiv \epsilon_a 5^a \pmod{2^e}$  and  $m \equiv \epsilon_b 5^b \pmod{2^e}$  with  $\epsilon_a, \epsilon_b \in \{\pm 1\}$ , then  $\chi_{2^e}(n, m) = \exp\left(2\pi i \left(\frac{(1 - \epsilon_a)(1 - \epsilon_b)}{8} + \frac{ab}{2^{e-2}}\right)\right)$ .

For general  $q$ , the function  $\chi_q(n, m)$  is defined multiplicatively:  $\chi_{q_1 q_2}(n, m) := \chi_{q_1}(n, m)\chi_{q_2}(n, m)$  for all coprime positive integers  $q_1$  and  $q_2$ . Chinese remainder theorem implies that this definition is well founded and that every Dirichlet character can be defined in this way. In particular, every Dirichlet character  $\chi$  of modulus  $q$  can be written uniquely as a product of Dirichlet characters of prime power modulus.

Introduced by Prof. Brian Conrey, Conrey labelling system is based on an explicit isomorphism between the multiplicative group  $(\mathbb{Z}/q\mathbb{Z})^\times$  and the group of Dirichlet characters of modulus  $q$  that makes it easy to recover the order, the conductor, and the parity of a Dirichlet character from its label, or to induce characters. The notation  $\chi_q(n, \cdot)$  under this labelling system is to identify Dirichlet characters  $\mathbb{Z} \rightarrow \mathbb{C}$ , where  $q$  is modulus, and  $n$  is index, a positive integer coprime to  $q$  that identifies a Dirichlet character of modulus  $q$ . Thus the LMFDB label  $q.n$ , with  $1 \leq n < \max(q, 2)$  uniquely identifies  $\chi_q(n, \cdot)$ .

**Remark 1.3. Definition and Axioms of all L-functions.** An (analytic) L-function is a Dirichlet series that has an Euler product and satisfies a certain type of functional equation, and allows analytic continuation. Then this L-function is also called Dirichlet L-function, associated with its Dirichlet L-series, which can be meromorphically continued to the complex plane, have an Euler product  $L(s, \chi) = \prod_p (1 - \chi(p)p^{-s})^{-1}$ , and satisfy a functional equation of the form  $\Lambda(s, \chi) = q^{\frac{s}{2}} \Gamma_{\mathbb{R}}(s) L(s, \chi) = \epsilon_{\chi} \overline{\Lambda}(1 - s)$ , where  $q$  is the conductor of  $\chi$ . For our purpose, the three main defining features of L-functions are **Axiom I: Analyticity** [or Analytic continuation]; viz, meromorphic continuation to entire complex plane with the only possible pole (if any) when  $s$  equals 1. **Axiom II: Euler product** [over prime  $p$  as previously defined above]. **Axiom III: Functional equation** [created using gamma factors as defined below].

**Wider aspects of L-function:** Introduced by Canadian mathematician Robert Langlands, an automorphic L-function is a function  $L(s, \pi, r)$  of a complex variable  $s$ , associated to an automorphic representation  $\pi$  of a reductive group  $G$  over a global field and a finite-dimensional complex representation  $r$  of Langlands dual group  ${}^L G$  of  $G$ , thus generalizing Dirichlet L-series of a Dirichlet character and Mellin transform of a modular form. Selberg class  $S$  is an attempt to capture core properties of L-functions in a set of axioms, thus encouraging study of properties on the class rather than of individual functions. Formal definition of  $S$  is set of all Dirichlet series  $F(s) = \sum_{n=1}^{\infty} \frac{a_n}{n^s}$  absolutely convergent for  $Re(s) > 1$  that satisfy four axioms.

The extra axiom is **Axiom IV: Ramanujan conjecture**  $a_1 = 1$  and  $a_n \ll_{\epsilon} n^{\epsilon}$  for any  $\epsilon > 0$ :  $O(n^{11/2+\epsilon})$ . It involves Ramanujan's tau function given by Fourier coefficients  $\tau(n)$  of cusp form  $\Delta(z)$  of weight 12.

The complex functions  $\Gamma_{\mathbb{R}}(s) := \pi^{-\frac{s}{2}} \Gamma\left(\frac{s}{2}\right)$  and  $\Gamma_{\mathbb{C}}(s) := 2(2\pi)^{-s} \Gamma(s)$  that appear in functional equation of an L-function are known as gamma factors. Here  $\Gamma(s) := \int_0^{\infty} e^{-t} t^{s-1} dt$  is Euler's gamma function, with poles located at  $s = 0, -1, -2, -3, -4, -5, \dots$ . The gamma factors satisfy  $\Gamma_{\mathbb{C}}(s) = \Gamma_{\mathbb{R}}(s)\Gamma_{\mathbb{R}}(s+1)$  and is also viewed as "missing" factors of Euler product of an L-function corresponding to (real or complex) archimedean places. Completely Predictable **trivial zeros** are zeros of an L-function  $L(s)$  that occur at



poles of its gamma factors. An L-function  $L(s) = \sum_{n=1}^{\infty} a_n n^{-s}$  is called arithmetic if its Dirichlet coefficients  $a_n$  are algebraic numbers. Thus for arithmetic L-functions, the poles are at certain negative integers.

All known analytic L-functions have functional equations that can be written in the form below [whereby  $\Lambda(s)$  is now called the **completed L-function**]  $\Lambda(s) := N^{\frac{s}{2}} \prod_{j=1}^J \Gamma_{\mathbb{R}}(s + \mu_j) \prod_{k=1}^K \Gamma_{\mathbb{C}}(s + \nu_k) \cdot L(s) = \varepsilon \bar{\Lambda}(1 - s)$  where  $N$  is an integer,  $\Gamma_{\mathbb{R}}$  and  $\Gamma_{\mathbb{C}}$  are defined in terms of the  $\Gamma$ -function,  $\text{Re}(\mu_j) = 0$  or  $1$  (assuming Selberg's eigenvalue conjecture), and  $\text{Re}(\nu_k)$  is a positive integer or half-integer,  $\sum \mu_j + 2 \sum \nu_k$  is real, and  $\varepsilon$  is the **sign of the functional equation**. With these restrictions on the spectral parameters [viz, the numbers  $\mu_j$  and  $\nu_k$  that appear as shifts in the gamma factors  $\Gamma_{\mathbb{R}}$  and  $\Gamma_{\mathbb{C}}$  (respectively)], the data in the functional equation is specified uniquely. **The integer  $d = J + 2K$  is the degree of the L-function. The integer  $N$  is the conductor (or level) of the L-function. The pair  $[J, K]$  is the signature of the L-function.** \*\*The sign  $\varepsilon$ , as complex number, appears as the fourth component of the Selberg data of  $L(s)$ ; viz,  $(d, N, (\mu_1, \dots, \mu_J : \nu_1, \dots, \nu_K), \varepsilon)$ . If all of the coefficients of the Dirichlet series defining  $L(s)$  are real, then necessarily  $\varepsilon = \pm 1$ . If the coefficients are real and  $\varepsilon = -1$ , then  $L(\frac{1}{2}) = 0^{**}$ .

NOTE: The functional equation for Riemann zeta function  $\zeta(s)$  [as Equation 3], and the (analogical) functional equation for Dirichlet eta function  $\eta(s)$  [given just after Equation 3] are provided in section 2.

The Riemann zeta function  $\zeta(s) = \sum_{n=1}^{\infty} \frac{1}{n^s} = \frac{1}{1^s} + \frac{1}{2^s} + \frac{1}{3^s} + \dots$ , having convergence when  $\Re(s) > 1$ , is prototypical "non-alternating zeta function (harmonic series)" L-function. Riemann zeta function is the only L-function of degree 1 and conductor 1, and (conjecturally) it is the only primitive L-function with a unique pole [located at  $s = 1$ ]; and is analytically continued to entire complex plane as Dirichlet eta function  $\eta(s) = \sum_{n=1}^{\infty} \frac{(-1)^{n+1}}{n^s} = \frac{1}{1^s} - \frac{1}{2^s} + \frac{1}{3^s} - \frac{1}{4^s} + \dots$ . The Dirichlet eta function, having convergence when  $\Re(s) > 0$ , is prototypical "alternating zeta function (harmonic series)" L-function. This continuation is defined by relationship  $\eta(s) = \gamma \cdot \zeta(s) = (1 - 2^{1-s}) \zeta(s)$  where  $\gamma = 1 - 2^{1-s}$  is the proportionality factor.

\*\*By way of note,  $(-1)^{n+1} = (-1)^{n-1}$  for all  $n = 1, 2, 3, 4, 5\dots$  OR for all  $n = 0, 1, 2, 3, 4, 5\dots$  without ambiguity or exception. In particular: for  $n = 0$ ,  $(-1)^1 = -1 \equiv (-1)^{-1} = \frac{1}{-1^1} = -1$ . Then, for example,

$$\eta(s) = \sum_{n=1}^{\infty} \frac{(-1)^{n+1}}{n^s} = \sum_{n=1}^{\infty} \frac{(-1)^{n-1}}{n^s} \text{ is always a true equality statement. **}$$

Euler product expressions for Elliptic curves  $\zeta_E(s)$  with associated L-functions  $L_E(s)$  and modular forms are possible. That for Riemann zeta function  $\zeta(s)$  having convergence when  $\Re(s) > 1$ , and for Dirichlet eta function  $\eta(s)$  having convergence when  $\Re(s) > 0$ , are (respectively) given by Equation 1 and Equation 2 in section 2. Using notation  $\mathbb{P}$  and  $\mathbb{N}$  defined previously, we give examples of Euler product expressions for various functions and constants. Riemann zeta function:  $\prod_{p \in \mathbb{P}} \left( \frac{1}{1 - \frac{1}{p^s}} \right) = \prod_{p \in \mathbb{P}} \left( \sum_{k=0}^{\infty} \frac{1}{p^{ks}} \right) = \sum_{n=1}^{\infty} \frac{1}{n^s}$

$= \zeta(s)$ . Dirichlet eta function [ $\eta(s) = \gamma \cdot \zeta(s)$  with proportionality factor  $\gamma = 1 - 2^{1-s}$ ]:  $\prod_{p \in \mathbb{P}} \left( \frac{1 - \frac{1}{p^s}}{1 - \frac{1}{p^s}} \right) =$

$$\prod_{p \in \mathbb{P}} \left( \sum_{k=0}^{\infty} \frac{1 - 2^{1-s}}{p^{ks}} \right) = \sum_{n=1}^{\infty} \frac{(-1)^{n+1}}{n^s} = \eta(s). \text{ Liouville function } \lambda(n) = (-1)^{\omega(n)}: \prod_{p \in \mathbb{P}} \left( \frac{1}{1 + \frac{1}{p^s}} \right) = \sum_{n=1}^{\infty} \frac{\lambda(n)}{n^s}$$

$$= \frac{\zeta(2s)}{\zeta(s)}. \text{ Mobius function } \mu(n): \prod_{p \in \mathbb{P}} \left( 1 - \frac{1}{p^s} \right) = \sum_{n=1}^{\infty} \frac{\mu(n)}{n^s} = \frac{1}{\zeta(s)} \text{ and } \prod_{p \in \mathbb{P}} \left( 1 + \frac{1}{p^s} \right) = \sum_{n=1}^{\infty} \frac{|\mu(n)|}{n^s} = \frac{\zeta(s)}{\zeta(2s)},$$

with ratio as  $\prod_{p \in \mathbb{P}} \left( \frac{1 + \frac{1}{p^s}}{1 - \frac{1}{p^s}} \right) = \prod_{p \in \mathbb{P}} \left( \frac{p^s + 1}{p^s - 1} \right) = \frac{\zeta(s)^2}{\zeta(2s)}$ . If  $\chi(n)$  is a Dirichlet character of conductor  $N$ , so that  $\chi$  is totally multiplicative and  $\chi(n)$  only depends on  $n \bmod N$ , and  $\chi(n) = 0$  if  $n$  is not coprime to  $N$ , then  $\prod_{p \in \mathbb{P}} \frac{1}{1 - \frac{\chi(p)}{p^s}} = \sum_{n=1}^{\infty} \frac{\chi(n)}{n^s}$  [here we conveniently omit primes  $p$  dividing conductor  $N$  from the product].

Leibniz formula for  $\pi$ ; viz,  $\frac{\pi}{4} = \sum_{n=0}^{\infty} \frac{(-1)^n}{2n+1} = 1 - \frac{1}{3} + \frac{1}{5} - \frac{1}{7} + \dots$  can be interpreted as a Dirichlet series using the (unique) Dirichlet character modulo 4, and converted to an Euler product of superparticular ratios (fractions where numerator and denominator differ by 1):  $\frac{\pi}{4} = \left( \prod_{p \equiv 1 \pmod{4}} \frac{p}{p-1} \right) \left( \prod_{p \equiv 3 \pmod{4}} \frac{p}{p+1} \right)$   
 $= \frac{3}{4} \cdot \frac{5}{4} \cdot \frac{7}{8} \cdot \frac{11}{12} \cdot \frac{13}{12} \dots$ , where each numerator is a prime number and each denominator is the nearest multiple of 4. Hardy-Littlewood twin prime constant:  $\prod_{p>2} \left( 1 - \frac{1}{(p-1)^2} \right) = 0.660161\dots$

**Modular forms and the Modularity theorem.** Having special spectacular properties resulting from surprising array of internal symmetries, modular forms describe several types of complex functions which have a certain type of functional equation and growth condition. The  $q$ -expansion of a modular form  $f(z)$  is its Fourier expansion at the cusp  $z = i\infty$ , expressed as a power series  $\sum_{n=0}^{\infty} a_n q^n$  in the variable  $q = e^{2\pi iz}$ . As exemplified by Dedekind eta function  $\eta(z) = q^{1/24} \prod_{n \geq 1} (1 - q^n)$  with  $\prod_{n \geq 1} (1 - q^n)$  as basic construction block of infinite products, this implies that many types of infinite products with this construction block are modular [but, of course, not similar-looking "micmicker" products of the type  $\prod (1 - q^{n^2})$  or  $\prod (1 - q^n)^n$ ]. L-function associated with a modular form can be expressed as Euler product over primes. The 2001 Modularity theorem states all elliptic curves over the field of rational numbers are UNIQUELY related to modular forms in a particular way. We use notation  $T = p^{-s} = \frac{1}{P^s}$  to indicate local polynomials of various degree. E.g., Sum-of-divisors function  $\sigma_z(n)$  has local polynomial  $F_p(T) = (1 - T)(1 - pT)$  of degree one. The functions  $L_p(s)$  are called Euler factors (or local factors), and for  $\sigma_z(n)$ , this is  $F_p(T)^{-1} = \frac{1}{F_p(T)}$   
 $= \frac{1}{(1 - T)(1 - pT)}$ . Local polynomials for elliptic curves are of degree 2 for all their infinitely-many "good" primes, and of degree 1 for their finitely-many "bad" primes. See Remark 1.4 below.

**Euler product of an L-function in details:** It is expected that the Euler product of an L-function of degree  $d$  and conductor  $N$  can be written as  $L(s) = \prod_p L_p(s)$  where for  $p \nmid N$   $L_p(s) = \prod_{n=1}^d \left( 1 - \frac{\alpha_n(p)}{p^s} \right)^{-1}$   
with  $|\alpha_n(p)| = 1$  and for  $p \mid N$ ,  $L_p(s) = \prod_{n=1}^{d_p} \left( 1 - \frac{\beta_n(p)}{p^s} \right)^{-1}$  where  $d_p < d$  and  $|\beta_n(p)| \leq 1$ . Again, the functions  $L_p(s)$  are called Euler factors (or local factors).

An eta quotient is any function  $f$  of the form  $f(z) = \prod_{1 \leq i \leq s} \eta^{r_i}(m_i z)$ , where  $m_i \in \mathbb{N}$  and  $r_i \in \mathbb{Z}$  and  $\eta(z)$  is the Dedekind eta function. An eta product is an eta quotient in which all the  $r_i$  are non-negative. We define the Dedekind eta function  $\eta(z)$  by the formula  $\eta(z) = q^{1/24} \prod_{n \geq 1} (1 - q^n)$ , where  $q = e^{2\pi iz}$ . The Dedekind eta function is a crucial example of a half-integral weight modular form, having weight  $1/2$  and level  $1$ . It is related to the Discriminant modular form via the formula  $\Delta(z) = \eta^{24}(z)$ .

All elliptic curves have UNIQUE local zeta functions, local L-functions and functional equations that can be equivalently expressed using Euler products, and fully satisfy Axioms I, II and III (Remark 1.3). Each elliptic curve over  $\mathbb{Q}$  has an integral Weierstrass model (or equation) of the form  $y^2 + a_1 xy + a_3 y = x^3 + a_2 x^2 + a_4 x + a_6$ , where  $a_1, a_2, a_3, a_4, a_6$  are integers. Reducing these coefficients modulo  $p$  defines an elliptic curve over finite field  $\mathbb{F}_p$  (except for a finite number of primes  $p$ , where the reduced curve has a singularity and thus fails to be elliptic, in which case  $E$  is said to be of bad reduction at  $p$ ). Each such equation, as unique minimal Weierstrass equation which satisfies the additional constraints  $a_1, a_3 \in \{0, 1\}$ ,  $a_2 \in \{-1, 0, 1\}$ , has a discriminant  $\Delta$  as nonzero integer divisible exactly by these "bad" primes  $p$ . Here, a minimal Weierstrass equation is one for which  $|\Delta|$  is minimal among all Weierstrass models for the same curve. The zeta function of an elliptic curve over a finite field  $\mathbb{F}_p$  is given by  $Z(E(\mathbb{F}_p), T) = \exp\left(\sum_{n=1}^{\infty} \# [E(\mathbb{F}_{p^n})] \frac{T^n}{n}\right)$ .

This is also given via a rational function in  $T$  [ $\equiv p^{-s} = \frac{1}{p^s}$ ] by  $Z(E(\mathbb{F}_p), T) = \frac{1 - a_p T + p T^2}{(1 - T)(1 - p T)}$ , where the 'trace of Frobenius' term  $a_p$  is defined to be difference between 'expected' number  $p + 1$  and number of points on elliptic curve  $E$  over  $\mathbb{F}_p$ , viz.  $a_p = p + 1 - \#E(\mathbb{F}_p)$  or equivalently,  $\#E(\mathbb{F}_p) = p + 1 - a_p$ .

The L-function of  $E$  over  $\mathbb{Q}$  is then defined by collecting this information together, for all primes  $p$  and is defined by  $L(E(\mathbb{Q}), s) = \prod_{p \nmid N} (1 - a_p p^{-s} + p^{1-2s})^{-1} \cdot \prod_{p \mid N} (1 - a_p p^{-s})^{-1}$  where  $N$  is the conductor of  $E$ ,

i.e. the product of primes with bad reduction. This product converges for  $\Re(s) > \frac{3}{2}$  [which can be *Analytically normalized* to converge for  $\Re(s) > 1$  by using  $\Gamma_{\mathbb{C}}(s + \frac{1}{2})$  instead of  $\Gamma_{\mathbb{C}}(s)$  in deriving the functional equation]. Hasse's conjecture then affirms that the L-function admits an Analytic continuation to the whole complex plane and satisfies a functional equation relating, for any  $s$ ,  $L(E, s)$  to  $L(E, 2 - s)$ .

This L-function, of a modular form whose Analytic continuation is known, has valid values of  $L(E, s)$  at any complex number  $s$  e.g. at  $s = 1$  (where the conductor product can be discarded as it is finite), the L-function becomes  $L(E(\mathbb{Q}), 1) = \prod_{p \nmid N} (1 - a_p p^{-1} + p^{-1})^{-1} = \prod_{p \nmid N} \frac{p}{p - a_p + 1} = \prod_{p \nmid N} \frac{p}{\#E(\mathbb{F}_p)}$ .

Examples of modular forms include classical modular forms, Maass waveforms, Hilbert modular forms, Bianchi modular forms, and Siegel modular forms. Analytic rank of a modular curve is the order of vanishing of its L-function at its central point, which is equal to sums of Analytic ranks of L-functions of the simple modular abelian varieties corresponding to Galois orbits of modular forms that are the isogeny factors of its Jacobian. When Analytic rank  $r$  is positive, the value is typically an **upper bound that is believed to be tight** (in the sense that there are known to be  $r$  zeroes located very near to the central point).

Analytic rank of a cuspidal modular form  $f$  is actually Analytic rank of L-function  $L(f, s) = \sum_{n \geq 1} a_n n^{-s}$  where  $a_n$  are complex coefficients that appear in  $q$ -expansion of modular form:  $f(z) = \sum_{n \geq 1} a_n q^n$ , whereby  $q = e^{2\pi iz}$ . The complex coefficients  $a_n$  depend on a choice of embedding of the coefficient field of  $f$  into complex numbers. It is also conjectured Analytic rank does not depend on this choice, and this conjecture has been verified for all classical modular forms. For modular forms, Analytic ranks are provably correct whenever the listed Analytic rank is 0, or the listed Analytic rank is 1 and the modular form is self dual (in **self dual case, the sign of functional equation determines the parity of Analytic rank**). BSD conjecture for modular abelian varieties  $\implies$  Analytic rank = Mordell-Weil rank of the Jacobian.

**Remark 1.4. The finitely-many "bad" primes and infinitely-many "good" primes in Elliptic curve  $E$  over  $\mathbb{Q}$  of conductor  $N$ :** A smooth proper variety  $X$  over a number field  $K$  is said to have good reduction at a prime  $p$  if it has a model over  $\mathcal{O}_{K,p}$  whose reduction modulo  $p$  is non-singular [viz, a smooth variety over the residue field]; more precisely,  $X$  has good reduction if it is the generic fiber of a smooth proper scheme over  $\mathcal{O}_{K,p}$ . Otherwise,  $p$  is said to be a prime of bad reduction. A "bad" prime [from bad reduction] for an L-function or modular form  $f$  is a prime dividing the conductor (level) of L-function or  $f$ . A "good" prime [from good reduction] is a prime that is not a "bad" prime; viz, a "good" prime does not divide this conductor (level). If an  $E$  has good reduction at  $p$ , then its Jacobian does too. The converse need not hold. An  $E$  defined over a number field  $K$  is said to have bad reduction at a prime  $p$  of  $K$  if the reduction of  $E$  modulo  $p$  is singular; viz, if and only if  $p$  divides its discriminant. There are three types of bad reduction:

- Split multiplicative reduction; viz, the reduction of  $E$  modulo  $\mathfrak{p}$  has a nodal singularity with both tangent slopes defined over the residue field at  $p$ .
- Non-split multiplicative reduction; viz, the reduction of  $E$  modulo  $p$  has a nodal singularity with tangent slopes not defined over the residue field at  $p$ .
- Additive reduction; viz, the reduction of  $E$  modulo  $p$  has a cuspidal singularity.

An  $E$  has good reduction at all primes  $p$  not dividing  $N$ , has multiplicative reduction at the primes  $p$  that exactly divide  $N$  (i.e. such that  $p$  divides  $N$ , but  $p^2$  does not, with this written as  $p||N$ ), and has additive reduction elsewhere (i.e. at the primes where  $p^2$  divides  $N$ ). Then Hasse-Weil zeta function of  $E$  is of the form  $Z_{V,\mathbb{Q}}(s) = \frac{\zeta(s)\zeta(s-1)}{L(E, s)}$ . Here,  $\zeta(s)$  is the usual Riemann zeta function and  $L(E, s)$  is called the L-function of  $E/\mathbb{Q}$ , which takes the form  $L(E, s) = \prod_p L_p(E, s)^{-1}$  where, for a given prime  $p$ ,

$$L_p(E, s) = \begin{cases} (1 - a_p p^{-s} + p^{1-2s}), & \text{if } p \nmid N \\ (1 - a_p p^{-s}), & \text{if } p \mid N \text{ and } p^2 \nmid N \\ 1, & \text{if } p^2 \mid N \end{cases}$$

where in the case of good reduction  $a_p$  is  $p + 1 -$  (number of points of  $E \bmod p$ ), and in the case of multiplicative reduction  $a_p$  is  $\pm 1$  depending on whether  $E$  has split (plus sign) or non-split (minus sign) multiplicative reduction at  $p$ . A multiplicative reduction of curve  $E$  by the prime  $p$  is said to be split if  $-c_6$  is a square in the finite field with  $p$  elements. There is a useful relation not using the conductor:

1. If  $p$  doesn't divide  $\Delta$  (where  $\Delta$  is the discriminant of the elliptic curve) then  $E$  has good reduction at  $p$ .
2. If  $p$  divides  $\Delta$  but not  $c_4$  then  $E$  has multiplicative bad reduction at  $p$ .
3. If  $p$  divides both  $\Delta$  and  $c_4$  then  $E$  has additive bad reduction at  $p$ .

Diophantine equations are effectively various "finite series" polynomial equations that generally involve operation of adding finitely many terms e.g. Fermat's equation  $x^n + y^n = z^n$  and elliptic curve  $y^2 = x^3 + ax + b$ . Proposed by Pierre de Fermat in 1637, Fermat's Last Theorem states that no three positive integers  $a$ ,  $b$  and  $c$  can satisfy Fermat's equation for any integer value of  $n$  greater than 2. The 2001 modularity theorem asserts that every elliptic curve is modular. This meant that all elliptic curves are associated with unique "infinite series" modular forms. In a nutshell, this was broadly a crucial step in proving Fermat's Last Theorem because it famously allowed Prof. Andrew Wiles to prove the theorem in 1994 by establishing a deep connection between [semistable] elliptic curves {as defined in Appendix A} and modular forms. Sir Andrew Wiles was deservedly awarded the 2016 Abel Prize for this work.

**Remark 1.5. Algebraic rank vs Analytic rank:** Denote  $P$  to be rational points (solutions); viz,  $P \in E(\mathbb{Q})$ . BSD conjecture asserts an elliptic curve  $E$ , defined over  $\mathbb{Q}$ , has either an infinite number or a finite number of  $P$  according to whether  $\zeta(1) = 0$  or  $\zeta(1) \neq 0$ , respectively. These  $P$  are points of an abelian variety and  $\zeta(1)$  is an associated zeta function  $\zeta(s)$  near point  $s = 1$ . The rank of  $E(\mathbb{Q})$  [ $\equiv$  subset of  $E(\mathbb{Q})$  with its elements  $P$  having infinite order] is finite number of copies of  $\mathbb{Z}$  in  $E(\mathbb{Q})$  or, equivalently, finite number of independent basis points on an elliptic curve mod  $p$ . It is **Algebraic rank** of  $E$ ; viz, "Infinite order Mordell-Weil generators" (denoted by  $r_E$ ). Rank 0 [having zero independent basis point with infinite order]: There is a subset of  $E(\mathbb{Q})$  in  $E$  either with zero finite integral points and zero finite  $E(\mathbb{Q})$  solutions or with non-zero finite integral points and non-zero finite  $E(\mathbb{Q})$  solutions]. Rank 1 [having one independent basis point with infinite order]: There is one subset of  $E(\mathbb{Q})$  in  $E$  with non-zero finite integral points and corresponding infinite  $E(\mathbb{Q})$  solutions. Higher Ranks 2 or more [having two or more independent basis point with infinite order]: There are 2 or more subsets of  $E(\mathbb{Q})$  with non-zero finite integral points and corresponding infinite  $E(\mathbb{Q})$  solutions. The simplest ("strong") version of BSD conjecture: **Proposition.** In an elliptic curve  $E$ , there are infinitely many  $E(\mathbb{Q})$  solutions when  $L_E(1) = 0$ ; viz, when Central value [at  $s = 1$ ] = 0. **Corollary.** In an elliptic curve  $E$ , there are finitely many (or zero)  $E(\mathbb{Q})$  solutions when  $L_E(1) \neq 0$ ; viz, when Central value [at  $s = 1$ ]  $\neq 0$ . The standard ("weak") version of BSD conjecture asserts  $r_E$  can be arbitrarily large, and **Algebraic**  $r_E$  [Order of zero at  $s = 1$  in  $L(E, s)$ ] = **Analytic**  $r'_E$  [related to leading coefficient of Taylor expansion of  $L(E, s)$  at  $s = 1$ ]. The canonical height of a rational point  $P \in E(\mathbb{Q})$  is computed by writing  $x$ -coordinate  $x(nP) = A_n(P)/D_n(P)$  as a fraction in lowest terms and setting  $\hat{h}(P) = \lim_{n \rightarrow \infty} \frac{1}{n^2} \log \max\{|A_n(P)|, |D_n(P)|\}$ . Properties of  $\hat{h}$ : [I]  $\hat{h}(P) = \log \max\{|A_1(P)|, |D_1(P)|\} + O(1)$  as  $P$  ranges over  $E(\mathbb{Q})$ . [II]  $\hat{h}(P) \geq 0$ ; and  $\hat{h}(P) = 0$  if and only if  $P$  is a torsion point. [III]  $\hat{h} : E(\mathbb{Q}) \rightarrow \mathbb{R}$  extends to a positive definite quadratic form on  $E(\mathbb{Q}) \otimes \mathbb{R}$ . The height pairing on  $E$  is the associated bilinear form  $\langle P, Q \rangle = \frac{1}{2}(\hat{h}(P + Q) - \hat{h}(P) - \hat{h}(Q))$ , which is used to compute the elliptic regulator of  $E$ . It is a symmetric positive definite bilinear form on  $E(\mathbb{Q}) \otimes \mathbb{R}$ . For a number field  $K$ , the canonical height of  $P \in E(K)$  is given by  $\hat{h}(P) = \lim_{n \rightarrow \infty} n^{-2} h(x(nP))$ , where  $h$  is the Weil height.

1.1. *Formally linking Generalized Riemann hypothesis to Birch and Swinnerton-Dyer conjecture. The treatise on Polignac's and Twin prime conjectures that asserts the infinity nature of Odd Primes derived from each and every even Prime gaps 2, 4, 6, 8, 10... is supplied later on.* Relevant to Langlands program, Generalized Riemann hypothesis (GRH) [and 'special case' Riemann hypothesis (RH)], and Birch and Swinnerton-Dyer (BSD) conjecture are "*catalogues*" in L-functions and modular forms database (LMFDB). Appendix A in this paper contains supplementary materials, practical computations and **Overall SUMMARY** on Predictability properties of Dirichlet L-series and Dirichlet L-functions. See Remark A.1 on **Q I Z(t) positivity / Q IV Z(t) negativity criterion in Graphs of Z-function** for elliptic curves. \*We imply the "simplest version" of BSD conjecture to be true, and outline an important research method at the end of Appendix A.\* There are Completely Predictable infinitely-many trivial zeros and Incompletely Predictable infinitely-many nontrivial zeros in an L-function. We assert entire sets of unique Incompletely Predictable nontrivial zeros (spectrum) in all L-functions [ $\equiv$  GRH]; and in L-functions of Riemann zeta function / Dirichlet eta function [ $\equiv$  RH], must pass through Centroid (Origin) point in **Polar graphs** whereby 0-dimensional "geometric" Origin point  $\equiv$  1-dimensional "mathematical" Critical Line.

Polar graph Figure 10 shows the graphed trajectory validly obtained for Riemann zeta function  $\zeta(s)$  / Dirichlet eta function  $\eta(s)$  with incorporating the important definition: **\*colinear lines or co-lines are two parallel lines that never cross over NEAR the Origin point\***. Supporting GRH and BSD conjecture to be true for L-functions of elliptic curves, one can [analogically] derive computed **Central values at vertical line  $s = 1$  in their functional equations** [relating  $L(E, s)$  to  $L(E, 2 - s)$  for any  $s$ ]; and construct **Polar graphs of  $\zeta_E(\sigma \pm it)$**  with all UNIQUE nontrivial zeros (as "individualized  $E$  spectrum") being ONLY located at [**Analytically normalized**]  $\sigma = \frac{1}{2}$ -Critical Line for each elliptic curve. Thus in a similar manner, we can apply *Principle of Equidistant for Multiplicative Inverse* (Remark 2.2) to elliptic functions and *Infinitesimal value  $\frac{1}{\infty}$  at just above / below  $\sigma = \frac{1}{2}$ -Origin point (Centroid point)* to graphed trajectories of elliptic curves  $E$  for **Analytically normalized  $\zeta_E(s)$** . The later action will depict trajectories in Polar graphs intersecting the Origin point (Centroid point) infinitely-many times ONLY when  $\sigma = \frac{1}{2}$ .

With complex variable  $s = \sigma \pm it$ , we further assert all L-functions with Analytic rank 0 [e.g. Dirichlet eta function (*proxy* function for Riemann zeta function) and those Elliptic curves having Analytic rank 0] DO NOT have first nontrivial zero located at  $t = 0$  on actual / normalized  $\sigma = \frac{1}{2}$ -Critical Line. A caveat here is the L-function of Riemann zeta function, as exception, DO NOT have nontrivial zeros. The corollary is then true in that all L-functions with Analytic rank 1 or higher [e.g. Elliptic curves having Analytic ranks of 1, 2, 3, 4, 5... (to an arbitrarily large number value)] DO have first nontrivial zero located at  $t = 0$  on the actual / normalized  $\sigma = \frac{1}{2}$ -Critical Line. The [more complex] L-functions of elliptic curves having relatively higher Analytic ranks are expected to generally have altered ["-ve odd"] Point symmetry / ["+ve even"] Line symmetry, frequency and complexity in appearances of nontrivial zeros (spectrums) that are correlated to increasing Analytic ranks. By the very definitions and constructions of Dirichlet L-series from Dirichlet L-functions, both mathematical objects must, by default, comply with three fundamental Axioms I, II and III of L-functions (see Remark 1.3). We recognize this deduction



allows us to derive  $\zeta_E(s)$ ,  $L_E(s)$ , functional equations and (equivalent) Euler products expressions based on Dirichlet coefficients  $a_n$  obtained from associated  $f(q)$  Modular forms.

The first nontrivial zero of Dirichlet eta function [viz, *proxy* function for Riemann zeta function] with Analytic rank 0, at **height  $\approx 14.134$ , is higher than that of any other algebraic L-function**. Then *any other algebraic L-function [with Analytic rank 0, 1, 2, 3, 4, 5...] will comparatively have more frequent nontrivial zeros [that first occur at a relatively lower height [for L-functions with Analytic rank 0], up to and including the (lowest) height of 0 [for L-functions with Analytic rank 1 or higher]*. At Analytically normalized  $\sigma = \frac{1}{2}$ -Critical Line, the mathematical objects of elliptic curves are "higher" analogues of BASIC Riemann zeta function  $\zeta(s)$  Eq. 1 with Analytic continuation to Dirichlet eta function  $\eta(s)$  Eq. 2 and its related / derived simplified- $\eta(s)$  Eq. 4, and Dirichlet Sigma-Power Law [=  $\int \text{sim-}\eta(s)dn$ ] Eq. 6.

**Useful preliminary information on Generic Numbers, Generic Terms and Generic Equation with their definitions and classification role:**

Hyperreal numbers extend real numbers to include certain classes of infinite and infinitesimal numbers. Surreal numbers is a totally ordered proper class containing the real numbers, infinite and infinitesimal numbers that are larger or smaller in absolute value than any positive real number. Quaternion number system extends the complex numbers. Quaternions have expression of the form  $a + b\mathbf{i} + c\mathbf{j} + d\mathbf{k}$ , where  $a, b, c, d$  are real numbers;  $\mathbf{i}^2 = \mathbf{j}^2 = \mathbf{k}^2 = -1$ ,  $\mathbf{ij} = -\mathbf{ji} = \mathbf{k}$ ,  $\mathbf{jk} = -\mathbf{kj} = \mathbf{i}$ ,  $\mathbf{ki} = -\mathbf{ik} = \mathbf{j}$ . These higher or more abstract number systems, and the main number systems below, form the **Generic Numbers**.

Integer numbers  $\mathbb{Z} \subset$  Rational numbers  $\mathbb{Q} \subset$  Real numbers  $\mathbb{R} \subset$  Complex numbers  $\mathbb{C}$ .

Natural numbers  $\mathbb{N} \{1, 2, 3, 4, 5, \dots\} \subset$  Whole numbers  $\mathbb{W} \{0, 1, 2, 3, 4, 5, \dots\} \subset$  Integer numbers  $\mathbb{Z} \{\dots -3, -2, -1, 0, 1, 2, 3, \dots\}$ . The pairing of Even numbers  $\mathbb{E} \{0, 2, 4, 6, 8, 10, \dots\}$  and Odd numbers  $\mathbb{O} \{1, 3, 5, 7, 9, 11, \dots\}$ , and the pairing of Prime numbers  $\mathbb{P} \{2, 3, 5, 7, 11, 13, 17, 19, 23, \dots\}$  and Composite numbers  $\mathbb{C} \{4, 6, 8, 9, 10, 12, 14, 15, 16, 18, 20, \dots\}$  can be separately combined to form  $\mathbb{W}$  whereby  $\{0, 1\}$  are neither prime nor composite. Complex number  $z = a + bi$  where imaginary unit  $i = \sqrt{-1}$ ;  $a, b \in \mathbb{R}$ ; and when  $b = 0$ ,  $z$  becomes a real number.  $\mathbb{Q} = \frac{p}{q}$  where  $p, q \in \mathbb{Z}$ ;  $\mathbb{Q}$  are  $\mathbb{Z}$  when  $p = 1$ ; and  $q = 0$  is undefined.

Irrational numbers  $\mathbb{R} \setminus \mathbb{Q} \subset$  Real numbers  $\mathbb{R}$  or Complex numbers  $\mathbb{C}$ . Then  $\mathbb{R} \setminus \mathbb{Q} =$  [I] Algebraic (irrational) numbers [viz,  $\mathbb{R}$  or  $\mathbb{C}$  that are the root of a non-zero polynomial of finite degree in one variable with integer or, equivalently, rational coefficients e.g. golden ratio  $(1 + \sqrt{5})/2$ ,  $\sqrt{2}$ ,  $\sqrt[3]{2}$ , etc] + [II] Transcendental (irrational) numbers [viz,  $\mathbb{R}$  or  $\mathbb{C}$  that are NOT the root of a non-zero polynomial of finite degree in one variable with integer or, equivalently, rational coefficients e.g.  $\pi$ ,  $e$ ,  $\ln 2$ ]. The only even Prime number  $\{2\}$  forms a Countably Finite Set (CFS).  $\mathbb{E}$ ,  $\mathbb{O}$ ,  $\mathbb{P}$ ,  $\mathbb{C}$ ,  $\mathbb{N}$ ,  $\mathbb{W}$ ,  $\mathbb{Z}$ ,  $\mathbb{Q}$  and Algebraic numbers form Countably Infinite Sets (CIS). Transcendental numbers,  $\mathbb{R} \setminus \mathbb{Q}$ ,  $\mathbb{R}$  and  $\mathbb{C}$  form Uncountably Infinite Sets (UIS).

We mathematically define the (finite)  $N$  terms in Generic Equation as: Generic Term  $T_1 +$  Generic Term  $T_2 +$  Generic Term  $T_3 +$  Generic Term  $T_4 + \dots$  Generic Term  $T_{N-1} +$  Generic Term  $T_N = 0$ . The finite Generic Equation with finite  $[n \rightarrow N]$  terms is  $\sum_{n=1}^N T_n = 0$ , and infinite Generic Equation with infinitely many



$[n \rightarrow \infty]$  terms is  $\sum_{n=1}^{\infty} T_n = 0$ . Then infinite series such as modular forms, power series and harmonic series are simply various types of Generic Equations having infinitely many Generic Terms. \*\*Euler products [infinite-like expressions], when used for expansions of Dirichlet series resulting in infinite products [viz, NOT infinite sums] indexed by prime numbers, are NOT Equations *per se* but could, in principle, form a Term(s) or part of a Term(s) in an Equation.\*\* The solutions or zeros (also sometimes called roots) of a **real-, complex-,** or generally **vector-**valued function  $f$  in a Generic Equation are members  $x$  of domain of  $f$  such that  $f(x)$  vanishes at  $x$ . Observe the  $n$  index for Generic Equation to commence from 0 or 1 is an arbitrary choice that is mathematically valid as long as consistency is maintained (viz, standardized).

$T_n$ , the  $n^{\text{th}}$  Term, is defined by either algebraic functions or non-algebraic (irrational or transcendental) functions; or a mixture of the two. Examples of [univariate or 1-variable] Terms involving  $x$  as variable (or indeterminate):  $a_n x^n$ ,  $a x^{-n} \equiv \frac{a}{x^n}$  [involving algebraic functions];  $a \sqrt[n]{x} \equiv a x^{\frac{1}{n}}$ ,  $a \sin^n x$ ,  $e^{nx}$ ,  $a \log_n x$  [involving irrational or transcendental functions];  $a_n x^n \sin^n x$  [involving mixed functions]. Notations:  $a$  = coefficient,  $n$  = exponent [or base for logarithm function, whereby when  $n = e$ ,  $a \log_e x = a \ln x$  involves the natural logarithm]. The "generic" Infinite series are of two types: Convergent series or Divergent series. In general, non-alternating harmonic series are usually Divergent series but alternating harmonic series are usually Convergent series.

With infinitely many Terms [Infinite series] that all have exponents (powers), Power series have  $T_n$  of the type  $a_n x^n$  e.g. alternating and non-alternating power series, geometric series, Taylor series, Maclaurin series, exponential function formula, sine formula, etc. Power series can also involve more than one variables. Having  $n$  as negative powers and fractional powers give rise to variants of power series called Laurent series and Puiseux series. Formal power series capture the essence of power series without being restricted to the fields of real and complex numbers, and without the need to talk about convergence.

With infinitely many unit fractions as Terms [Infinite series], Harmonic series have  $T_n$  of the type  $\frac{a}{x^n}$  e.g. alternating and non-alternating harmonic series, Riemann zeta function, Dirichlet eta function. Harmonic series could also involve more than one variables with coefficients  $a_n$  that could theoretically also be more complex and depend on variable  $x$ , etc. Egyptian fractions, being the finite sum of distinct unit fractions, are roughly like Finite harmonic series. Note 1: Not related to harmonic series *per se* is Harmonic functions giving rise to non-polynomial (transcendental) terms e.g. second derivatives  $e^x \sin y$  and  $-e^x \sin y$  of a 2-variable harmonic function; viz, twice continuously differentiable function  $f: U \rightarrow \mathbb{R}$  where  $U$  is an open subset of  $\mathbb{R}^n$  that satisfies this particular Laplace's equation  $f(x, y) = e^x \sin y$ . Note 2: **With 1-variable given here by  $s [= \sigma \pm it]$  in various L-functions  $L(s)$  as harmonic series associated with L-series,**  $s$  can be complex numbers, or be positive / negative real numbers given by  $\sigma$  when  $t = 0$ .

With finitely many Terms [Finite series] that all have exponents (powers), Polynomials have  $T_n$  of the type  $a_n x^n$  e.g. integer polynomial, real polynomial, complex polynomial [as defined by their coefficients derived from various number systems]; rational fraction [being the quotient (algebraic fraction) of two polynomials], exponential polynomials [a bivariate polynomial where the second variable is substituted

for an exponential function applied to the first variable such as  $P(x, e^x)$ ], matrix polynomial [a polynomial with square matrices as variables], trigonometric polynomial [a finite linear combination of functions  $\sin(nx)$  and  $\cos(nx)$  with  $n$  taking on the values of one or more natural numbers, and having real- or complex-valued coefficients]. Polynomial is formally defined as a mathematical expression consisting of indeterminates (variables) and coefficients, that involves only the operations of addition, subtraction, multiplication and exponentiation to nonnegative integer powers, and has a finite number of terms [viz, monomial with 1 term, binomial with 2 terms, polynomial with  $\geq 2$  terms (whereby each term can also be usefully labelled as a monomial)]. Polynomials can also involve more than one variables, as multivariate polynomial. Polynomials are roughly like "finite power series" [having finite degree], or equivalently, Power series are roughly like "infinite polynomials" [having infinite degree]. Laurent polynomials are like polynomials, but allow negative powers of the variable(s) to occur.

A number field can be defined by many different irreducible polynomials  $f(x) \in \mathbb{Q}[x]$ . The defining polynomial of a number field  $K$  is an irreducible polynomial  $f \in \mathbb{Q}[x]$  such that  $K \cong \mathbb{Q}(a)$ , where  $a$  is a root of  $f(x)$ . A root  $a \in K$  of the defining polynomial is a generator of  $K$ . Normalized polynomials are always monic with integer coefficients, such that the sum of the squares of the absolute values of all complex roots of  $f(x)$  is minimized. \*\*Note that the unit group of a number field  $K$  is the group of units of the ring of integers of  $K$ . It is a finitely generated abelian group with cyclic torsion subgroup. A set of generators of a maximal torsion-free subgroup is called a set of fundamental units for  $K$ .\*\* The defining polynomial of a  $p$ -adic field  $K$  is an irreducible polynomial  $f(x) \in \mathbb{Q}_p[x]$  such that  $K \cong \mathbb{Q}_p(a)$ , where  $a$  is a root of  $f(x)$ . The defining polynomial can be chosen to be monic with coefficients in  $\mathbb{Z}_p$ ; by Krasner's lemma, we can further take  $f(x) \in \mathbb{Z}[x]$ .

**Remark 1.6. Normalized defining polynomial for L-functions and Number fields:**

Integer '0' as Equation  $0 = 0$  is the zero polynomial  $P(x) = 0$  of undefined degree arbitrarily assigned as either  $-1$  or  $-\infty$ , with all coefficients = 0. It is the additive identity in set of polynomials; viz,  $P(x) + 0 = P(x)$ . Any nonzero integers  $c$  e.g.  $-3, -2, -1, 1, 2, 3, \dots$  as Equation  $c = c$  is the constant polynomial  $P(x) = c$  of degree 0 [since it can be written as  $c \cdot x^0$ ], with coefficient of  $x^0 = c$  and all other coefficients = 0.

Equation "P"  $x = 0 \equiv x + 0 = 0$  is the [linear] defining polynomial  $P(x) = x$  of degree 1 [since it can be written as  $1 \cdot x^1$ ] and rank of its Unit group = 0, with coefficient of  $x^1 = 1$  and all other coefficients = 0. **It represents the "most basic" 1-variable infinite non-alternating harmonic series, an unique L-function  $L_\zeta(s)$ , called Riemann zeta function  $\zeta(s)$  having infinitely many terms.**

Equation "D"  $\pm x = 0 \equiv \pm x + 0 = 0$  is [linear] defining polynomial  $P(x) = \pm x$  of degree 1 [since it can be written as  $\pm 1 \cdot x^1$ ] and rank of its Unit group = 0, with coefficient of  $x^1 = \pm 1$  & all other coefficients = 0. **It represents the "most basic" 1-variable infinite alternating harmonic series, an unique L-function  $L_\eta(s)$ , called Dirichlet eta function  $\eta(s)$  having infinitely many terms.**

Equation "K"  $x = \pm \sqrt{-1} = \pm i \equiv x^2 + 1 = 0$  is [non-linear] defining polynomial  $P(x) = x^2 + 1$  of degree 2 [and rank of its Unit group = 0], with coefficient of  $x^2 = 1$ , first coefficient = 1 & all other coefficients =

0, that connects  $\mathbb{R}$  to  $\mathbb{C}$  and **conceptually represents an important 1-variable infinite non-alternating harmonic series, as an unique L-function  $L_K(s)$  containing the field of Gaussian rational numbers, and is associated with Automorphic object "A" given by L-function  $L_A(s)$ . Having Analytic rank 0, both  $L_K(s)$  and  $L_A(s)$  have infinitely many terms.** The ring of integers,  $\mathbb{Z}[i]$ , is a Euclidean domain, hence unique factorization domain, with norm  $N(a + bi) = a^2 + b^2 = (a + bi)(a - bi)$ . Thus it is connected to the question of which positive integers can be written as sum of two squares, and more specifically, to the theorem of Fermat that a prime number  $p$  can be written as sum of two squares if and only if  $p \not\equiv 3 \pmod{4}$ , and that if  $p = a^2 + b^2$ , then representation is unique subject to  $0 < a \leq b$ .

Equation "E"  $y^2 = x^3 + ax + b \equiv y^2 - x^3 - ax - b = 0$  is the [non-linear] 2-variable (bivariate) defining polynomial  $P(x, y) = P(x)$  of degree 3 +  $P(y)$  of degree 2 =  $y^2 - x^3 - ax - b$  with coefficients 1, -1, -a, -b & all other coefficients = 0. Always of degree 2 but with possible Analytic rank of 0, 1, 2, 3, 4, 5...; all elliptic curves **give rise to important 1-variable infinite alternating harmonic series, as unique L-functions  $L_E(s)$  [ $\approx \zeta_E(s)$ ] associated with Modular forms** that act as (periodic) 'generating series or functions' based on elliptic functions. Both  $L_E(s)$  and Modular forms have infinitely many terms.

**(Analytic rank 0) Riemann zeta function  $\zeta(s)$  vs (Analytic rank 0) Dirichlet eta function  $\eta(s)$ :**  $\zeta(s)$  is the **1-variable prototypical non-alternating L-function**. Analytic continuation of  $\zeta(s)$  and its L-function  $L_\zeta(s)$  [with Convergence for complex number when  $\text{Re}(s) > 1$ ] to proxy function  $\eta(s)$  and its L-function  $L_\eta(s)$  [with Convergence for any complex number when  $\text{Re}(s) > 0$ ] is required to obtain nontrivial zeros. They are related via proportionality factor  $\gamma = (1 - 2^{1-s})$  as  $\eta(s) = \gamma \cdot \zeta(s)$ . From Remark 1.6, we reiterate that  $\eta(s)$  and  $L_\eta(s)$  is the **1-variable prototypical alternating L-function** having infinitely many terms.

Infinitely-many Completely Predictable Trivial zeros of  $\zeta(s)$  occurs at  $s = -2, -4, -6, -8, -10, \dots$

Infinitely-many Completely Predictable Trivial zeros of  $\eta(s)$  occurs at  $s = -2, -4, -6, -8, -10, \dots$

Nontrivial zeros of  $\zeta(s)$  DO NOT exist.

Infinitely-many Incompletely Predictable Nontrivial zeros in  $\eta(s)$  occurs at Critical Line as defined by  $\eta(s) = \frac{1}{2} \pm it$  with  $\pm t$  values  $\approx \pm 14.13, \pm 21.02, \pm 25.01, \pm 30.42, \pm 32.93, \pm 37.58, \dots$

**Particular values from Dirichlet eta function  $\eta(s)$  as an L-function:** In general, the  $k^{\text{th}}$  derivative of  $\eta(s)$ ; viz,  $\eta'(s), \eta''(s), \eta'''(s)$ , etc with convergence for  $\Re(s) > 0$  is denoted by  $\eta^{(k)}(s)$  for  $k = 1, 2, 3, \dots$ ; e.g. the first derivative with respect to parameter  $s$  for  $s \neq 1$ :  $\eta'(s) = \sum_{n=1}^{\infty} \frac{(-1)^n \ln n}{n^s} = 2^{1-s} \ln(2) \zeta(s) + (1 - 2^{1-s}) \zeta'(s)$ . Then,  $\eta'(1) = \ln(2) \gamma - \ln(2)^2 2^{-1}$ .

$\eta(0) = \frac{1}{2}$  [the Abel sum of Grandi's series  $1 - 1 + 1 - 1 + \dots$ ];  $\eta(-1) = \frac{1}{4}$  [the Abel sum of  $1 - 2 + 3 - 4 + \dots$ ].

For  $k$  an integer  $> 1$ , if  $B_k$  is the  $k^{\text{th}}$  Bernoulli number then  $\eta(1 - k) = \frac{2^k - 1}{k} B_k$ . Also,  $\eta(1) = \ln 2$  as an alternating harmonic series.  $\eta(2) = \frac{\pi^2}{12}$ ,  $\eta(4) = \frac{7\pi^4}{720} \approx 0.94703283$ ,  $\eta(6) = \frac{31\pi^6}{30240} \approx 0.98555109$ ,  $\eta(8) = \frac{127\pi^8}{120960} \approx 0.99623300$ ,  $\eta(10) = \frac{73\pi^{10}}{6842880} \approx 0.99903951$ ,  $\eta(12) = \frac{1414477\pi^{12}}{1307674368000} \approx 0.99975769$ .

The general form for even positive integers is:  $\eta(2n) = (-1)^{n+1} \frac{B_{2n} \pi^{2n} (2^{2n-1} - 1)}{(2n)!}$ . As  $n \rightarrow \infty$ , we obtain  $\eta(\infty) = 1$ . For  $n = 1, 2, 3, 4, 5 \dots$  via its functional equation,  $\eta(s)$  has Completely Predictable infinitely many trivial zeros at each even negative integer  $s = -2n = -2, -4, -6, -8, -10 \dots$ ; and DO have infinitely-many nontrivial zeros.

**Particular values from Riemann zeta function  $\zeta(s)$  as an L-function:** Riemann zeta function can also be defined in terms of multiple integrals by  $\zeta(s) = \underbrace{\int_0^1 \dots \int_0^1}_{s} \frac{\prod_{i=1}^s dx_i}{1 - \prod_{i=1}^s x_i}$ , and as a Mellin transform by

$$\int_0^\infty \text{frac}\left(\frac{1}{t}\right) t^{(s-1)} dt = -\frac{\zeta(s)}{s} \text{ for } 0 < \Re(s) < 1, \text{ where } \text{frac}(x) \text{ is the fractional part.}$$

In general, the  $k^{\text{th}}$  derivative of  $\zeta(s)$ ; viz,  $\zeta'(s), \zeta''(s), \zeta'''(s)$ , etc with convergence for  $\Re(s) > 1$  is denoted by  $\zeta^{(k)}(s)$  for  $k = 1, 2, 3, \dots$ ; for example, the first derivative of  $\zeta(s)$  is  $\zeta'(s) = -\sum_{n=1}^\infty \frac{\ln n}{n^s} = -\sum_{n=2}^\infty \frac{\ln n}{n^s}$  since

$\ln 1 = 0$ . When  $s = 0$ ,  $\zeta'(0) = -\frac{1}{2} \ln(2\pi)$ . When  $s$  is considered for (purely) real number values:  $\zeta(0) = -\frac{1}{2}$ ,  $\zeta(\frac{1}{2}) = -1.4603545 \dots$ , etc. Taking the limit  $s \rightarrow +\infty$  through the real numbers, one obtains  $\zeta(+\infty) = 1$ . But at complex infinity on the Riemann sphere the zeta function has an essential singularity.

For any positive even integer  $2n$ ,  $\zeta(2n) = \frac{|B_{2n}|(2\pi)^{2n}}{2(2n)!}$ , where  $B_{2n}$  is the  $(2n)^{\text{th}}$  Bernoulli number. For odd positive integers, no such simple expression is known, although these values are thought to be related to the algebraic  $K$ -theory of the integers.

In particular,  $\zeta(s)$  vanishes at negative even integers because  $B_m = 0$  for all odd  $m$  other than 1. These are the trivial zeros. The point  $s = 1$  in  $\zeta(s)$  corresponds to a simple pole with complex residue 1. Even though  $\zeta(1)$  is undefined as it diverges to  $\infty$ , its Cauchy principal value  $\lim_{\varepsilon \rightarrow 0} \frac{\zeta(1 + \varepsilon) + \zeta(1 - \varepsilon)}{2}$  exists and is equal to Euler-Mascheroni constant  $\gamma = 0.577218 \dots$  [a transcendental number].

For nonpositive integers [and where  $B_{n+1}$  is the  $(n + 1)^{\text{th}}$  Bernoulli number], one has  $\zeta(-n) = -\frac{B_{n+1}}{n + 1}$  for  $n \geq 0$  (using the convention that  $B_1 = \frac{1}{2}$ ). In particular,  $\zeta(s)$  vanishes at the negative even integers

because  $B_m = 0$  for all odd  $m$  other than 1. Then  $\zeta(-1) = -\frac{1}{12}$ ,  $\zeta(-3) = -\frac{1}{120}$ ,  $\zeta(-5) = -\frac{1}{252}$ , ...,  $\zeta(-11) = -\frac{691}{32760}$ ,  $\zeta(-13) = -\frac{1}{12}$ ,..... Special values of  $\zeta(s)$  involving small positive integer values of

$s$ :  $\zeta(1) = \infty$ ,  $\zeta(2) = \frac{\pi^2}{6}$ ,  $\zeta(3) = 1.2020569032 \dots$ ,  $\zeta(4) = \frac{\pi^4}{90}$ ,  $\zeta(5) = 1.0369277551 \dots$ ,  $\zeta(6) = \frac{\pi^6}{945}$ ,

$\zeta(7) = 1.0083492774 \dots$ ,  $\zeta(8) = \frac{\pi^8}{9450}$ ,  $\zeta(9) = 1.0020083928 \dots$ ,  $\zeta(10) = \frac{\pi^{10}}{93555}$ , etc. When  $s = 2, 4, 6, 8, 10 \dots$ ; computed  $\zeta(s)$  values all contain transcendental irrational number  $\pi$ . When  $s = 3, 5, 7, 9, 11 \dots$ ;

computed  $\zeta(s)$  values are "likely" all algebraic irrational numbers. Only  $\zeta(3)$  or Apéry's constant is proven to be an irrational number but it is unknown whether it is a transcendental number derived from (e.g.)  $\pi^3$  or another unrelated transcendental number. Here  $\zeta(3) = \frac{7}{180} \pi^3 - 2 \sum_{k=1}^\infty \frac{1}{k^3(e^{2\pi k} - 1)}$  [as series representation

found by Ramanujan] and  $\zeta(3) = \int_0^1 \int_0^1 \int_0^1 \frac{1}{1 - xyz} dx dy dz$ , [as integrand of known triple integral for

$\zeta(3)$ ]. Despite these unknowns, [e.g.] computed  $\zeta(s)$  solutions from substituting  $s =$  even numbers 2, 4,

6, 8, 10... versus  $s =$  odd numbers 3, 5, 7, 9, 11... should all be irrational numbers that are, crucially, *mutually exclusive* and **mathematically, geometrically and topologically** different from each other. For  $n = 1, 2, 3, 4, 5...$  via its functional equation,  $\zeta(s)$  has Completely Predictable infinitely many trivial zeros at each even negative integer  $s = -2n = -2, -4, -6, -8, -10...$ ; but DO NOT have any nontrivial zeros.

**Duality:** In mathematics, a duality translates concepts, theorems or mathematical structures into other concepts, theorems or structures in a one-to-one fashion, often (but not always) by means of an involution operation: if the dual of  $A$  is  $B$ , then the dual of  $B$  is  $A$ . Such involutions sometimes have fixed points, so that the dual of  $A$  is  $A$  itself. Any vector space  $V$  has a corresponding dual vector space consisting of all linear forms on  $V$  together with the vector space structure of pointwise addition and scalar multiplication by constants. In any finite group, the number of nonisomorphic irreducible representations over the complex numbers is precisely the number of conjugacy classes. A **ket** is of the form  $|v\rangle$  whereby it mathematically denotes a vector  $v$  in an abstract (complex) vector space  $V$  and physically represents a state of some quantum system; and a **bra** is of the form  $\langle f|$  whereby it mathematically denotes a linear form  $f : V \rightarrow \mathbb{C}$ , i.e. a linear map that maps each vector in  $V$  to a number in the complex plane  $\mathbb{C}$ . Then letting the linear functional  $\langle f|$  act on a vector  $|v\rangle$  is written as  $\langle f|v\rangle \in \mathbb{C}$ . L-functions are fundamental mathematical objects in Number theory that are dual to prime numbers; viz, each L-function can be viewed as a vector in certain Hilbert space, and each prime can then be viewed as a vector in the *dual* Hilbert space.

From above discussion, the ubiquitous deep theme of duality exist in Linear algebra [viz, vector space  $V \rightleftharpoons$  dual vector space  $V^*$  having elements called functionals], Quantum mechanics [viz, **bra**  $\rightleftharpoons$  **ket**], Group theory [conjugacy class  $\rightleftharpoons$  irreducible representations] and Number theory [viz, prime numbers  $\rightleftharpoons$  L-functions]. In particular, the duality present in Number theory is inevitably connected to Theory of Symmetry from Langlands program whereby various power series and harmonic series, L-series, Dirichlet series, Dirichlet eta function (proxy function for Riemann zeta function as the generating function for all nontrivial zeros), Sieve of Eratosthenes (as the generating algorithm for all prime numbers), etc are usefully regarded as variants of *infinite series*. The complex number  $z = a + bi$ . Its real part  $a$  and imaginary part  $b$  are real numbers. Its imaginary unit  $i$  satisfy power-series expansions  $\sum_{n=0}^{\infty} i^n$  [as well as basic facts

$$i^0 = 1, \quad i^1 = i, \quad i^2 = -1, \quad i^3 = -i,$$

about powers of  $i$ ] with given terms:  $i^4 = 1, \quad i^5 = i, \quad i^6 = -1, \quad i^7 = -i$ .

$$\vdots \quad \quad \quad \vdots \quad \quad \quad \vdots \quad \quad \quad \vdots$$

$$e^{ix} = 1 + ix + \frac{(ix)^2}{2!} + \frac{(ix)^3}{3!} + \frac{(ix)^4}{4!} + \frac{(ix)^5}{5!} + \frac{(ix)^6}{6!} + \frac{(ix)^7}{7!} + \frac{(ix)^8}{8!} + \dots$$

$$= 1 + ix - \frac{x^2}{2!} - \frac{ix^3}{3!} + \frac{x^4}{4!} + \frac{ix^5}{5!} - \frac{x^6}{6!} - \frac{ix^7}{7!} + \frac{x^8}{8!} + \dots$$

$$= 1 \left( \frac{x^0}{0!} - \frac{x^2}{2!} + \frac{x^4}{4!} - \frac{x^6}{6!} + \frac{x^8}{8!} - \dots \right) + i \left( \frac{x^1}{1!} - \frac{x^3}{3!} + \frac{x^5}{5!} - \frac{x^7}{7!} + \dots \right) = \cos x + i \sin x$$

Using power-series definition above, we prove Euler's formula for the real values of  $x$ . Note that when

$x = \pi$ ,  $e^{i\pi} = -1$  (Euler's identity). In the last step we recognize  $\frac{x^0}{0!} = 1$  and the two terms are Maclaurin series [**alternating power series** or, broadly, alternating infinite series] for  $\cos x = \sum_{n=0}^{\infty} \frac{(-1)^n x^{2n}}{(2n)!}$  and  $\sin x$

$= \sum_{n=0}^{\infty} \frac{(-1)^n x^{2n+1}}{(2n+1)!}$  with the rearrangement of terms justified because each series is absolutely convergent.

Recall that  $\cos x$  &  $\cosh x$  are even functions, so  $\cos(-x) = \cos(x)$  &  $\cosh(-x) = \cosh(x)$ ; and  $\sin x$  &  $\sinh x$  are odd functions, so  $\sin(-x) = -\sin(x)$  &  $\sinh(-x) = -\sinh(x)$ .

$$\sinh i = \frac{e^i - e^{-i}}{2} = i \sin 1, \cosh i = \frac{e^i + e^{-i}}{2} = \cos 1 \text{ \& \ } \tanh i = \frac{\sinh i}{\cosh i} = \frac{(e^i - e^{-i})}{(e^i + e^{-i})} = i \tan 1.$$

$$\sin i = i \frac{e^1 - e^{-1}}{2} = i \sinh 1, \cos i = \frac{e^1 + e^{-1}}{2} = \cosh 1 \text{ \& \ } \tan i = \frac{\sin i}{\cos i} = \frac{i(e^1 - e^{-1})}{(e^1 + e^{-1})} = i \tanh 1.$$

$$\cos i = \sum_{n=0}^{\infty} \frac{1}{(2n)!} = \frac{1}{0!} + \frac{1}{2!} + \frac{1}{4!} + \frac{1}{6!} + \frac{1}{8!} + \dots \text{ \& \ } \sin i = i \sum_{n=0}^{\infty} \frac{1}{(2n+1)!} = i \left( \frac{1}{1!} + \frac{1}{3!} + \frac{1}{5!} + \frac{1}{7!} + \dots \right)$$

[Note: For  $n = 0$  to  $\infty$ ,  $(i)^{2n} = (i^2)^n = (-1)^n$ ].

Euler's formula produces following analytical identities for sine, cosine and tangent in terms of  $e$  and  $i$ :

$$\sin x = \frac{e^{ix} - e^{-ix}}{2i}, \cos x = \frac{e^{ix} + e^{-ix}}{2} \text{ \& \ } \tan x = \frac{\sin x}{\cos x} = \frac{(e^{ix} - e^{-ix})}{i(e^{ix} + e^{-ix})}.$$

The related or extended Lindemann-Weierstrass theorem, Gelfond-Schneider theorem, Baker's theorem, four exponentials conjecture or Schanuel's conjecture could be used to establish transcendence of a large class of numbers constituted from the (algebraic) irrational numbers, transcendental (irrational) numbers and rational numbers. Natural logarithm of any natural number other than 0 and 1 (more generally, of any positive algebraic number other than 1) e.g.  $\ln 2$  and  $\ln \sqrt{2} = \ln 2^{\frac{1}{2}} = \frac{1}{2} \ln 2$  are transcendental numbers by the Lindemann-Weierstrass theorem. By the Gelfond-Schneider theorem,  $e^{\pi}$  [Gelfond's constant],  $2^{\sqrt{2}}$  [Gelfond-Schneider constant as an example of  $a^b$  where  $a$  is algebraic but not 0 or 1, and  $b$  is (algebraic) irrational number],  $e^{-\frac{\pi}{2}} = i^i$ , etc are all transcendental numbers.

As sum of infinite (power) series, Euler's number  $e = \sum_{n=0}^{\infty} \frac{1}{(n)!} = \sum_{n=1}^{\infty} \frac{1}{(n-1)!} = 1 + \frac{1}{1} + \frac{1}{1 \cdot 2} + \frac{1}{1 \cdot 2 \cdot 3} + \dots$

$\approx 2.71828$  is the limit  $\lim_{n \rightarrow \infty} \left(1 + \frac{1}{n}\right)^n$ . It can be characterized using integral  $\int_1^e \frac{dx}{x} = 1$ . As sum of

infinite series,  $\ln 2 = \sum_{n=1}^{\infty} \frac{(-1)^{n+1}}{n} = \frac{1}{1} - \frac{1}{2} + \frac{1}{3} - \frac{1}{4} + \dots \approx 0.693147$ . This infinite series can also be

expressed using Riemann zeta function as  $\sum_{n=1}^{\infty} \frac{1}{n} [\zeta(2n) - 1] = \ln 2$ . Some explicit formulas for  $\ln 2$  as

$$\text{a result of integration include } \int_0^1 \frac{dx}{1+x} = \int_1^2 \frac{dx}{x} = \ln 2, \int_0^{\infty} e^{-x} \frac{1 - e^{-x}}{x} dx = \ln 2, \int_0^{\infty} 2^{-x} dx = \frac{1}{\ln 2},$$

$$\int_0^{\frac{\pi}{3}} \tan x dx = 2 \int_0^{\frac{\pi}{4}} \tan x dx = \ln 2, -\frac{1}{\pi i} \int_0^{\infty} \frac{\ln x \ln \ln x}{(x+1)^2} dx = \ln 2. \text{ In principal branch of logarithm, } \ln(-1)$$

$= 0 + i\pi = i\pi$ . The analytic identity using natural logarithm  $-\ln(1-i)$  is analogous to Euler's formula for chosen transcendental (real) number values as based on inverse functions  $\ln i = \ln(e^{i\frac{\pi}{2}}) = 0 + \frac{\pi}{2}i =$

$1.57079632679i$  &  $e^i = \cos(1) + i \sin(1) = 0.540302306 + 0.841470985i$ . It conforms to *Langlands program's Theory of Symmetry* w.r.t. imaginary number (point)  $i = \sqrt{-1} = 0 + i = \cos(\frac{\pi}{2}) + i \sin(\frac{\pi}{2})$ ; viz,

$\ln(e^i) = i$  &  $e^{(\ln i)} = i$  [c.f. Figure 8 manifesting (perfect) diagonal symmetry via  $\ln(e^x) = x$  &  $e^{(\ln x)} = x$ ].

$$\begin{aligned}
\text{Then } -\ln(1-i) &= -\ln \sqrt{2+i} \frac{\pi}{4} \\
&= 0 + i + \frac{(i)^2}{2} + \frac{(i)^3}{3} + \frac{(i)^4}{4} + \frac{(i)^5}{5} + \frac{(i)^6}{6} + \frac{(i)^7}{7} + \frac{(i)^8}{8} + \dots \\
&= 0 + \frac{i}{1} - \frac{1}{2} - \frac{i}{3} + \frac{1}{4} + \frac{i}{5} - \frac{1}{6} - \frac{i}{7} + \frac{1}{8} \dots \\
&= 1 \left( 0 - \frac{1}{2} + \frac{1}{4} - \frac{1}{6} + \frac{1}{8} - \dots \right) + i \left( \frac{1}{1} - \frac{1}{3} + \frac{1}{5} - \frac{1}{7} + \dots \right)
\end{aligned}$$

Transcendental numbers  $-\ln \sqrt{2} = -\sum_{n=1}^{\infty} \frac{(-1)^{n+1}}{2n} \approx -0.3465\dots$  and  $\frac{\pi}{4} = \sum_{n=1}^{\infty} \frac{(-1)^{n+1}}{2n-1} \approx 0.7853\dots$  [aka

Leibniz formula for  $\pi$ ] as two **alternating power series** [or, broadly, alternating infinite series] are recognizably related to each other as they represent the two terms in the last step above. As expected, our **additive identity 0** in  $-\ln(1-i)$  is analogous to **multiplicative identity 1** [viz,  $\frac{x^0}{0!}$ ] in Euler's formula  $e^{ix}$ .

A formal series is an infinite series (sum) that is considered independently from any notion of convergence, and is manipulated with usual algebraic operations on series such as addition, subtraction, multiplication, division, partial sums, etc. A power series defines a function by taking numerical values for the variable WITHIN a radius of convergence. In contrast with NO requirements of convergence, a *formal* power series is a special kind of formal series whose terms are of the form  $ax^n$  where  $x^n$  is the  $n^{\text{th}}$  power of a variable  $x$  ( $n$  is a non-negative integer), and  $a$  is called the coefficient.

Not actually regarded as a function *per se* with its "variable" remaining an indeterminate, a generating function (or series) is a representation of infinite sequences of numbers as coefficients of a formal power series. More generally, a formal power series can include series with any finite (or countable) number of variables, and with coefficients in an arbitrary ring. Rings of formal power series are complete local rings, and this allows using calculus-like methods in the purely algebraic framework of algebraic geometry and commutative algebra. They are analogous in many ways to  $p$ -adic integers which can be defined as formal series of the powers of  $p$  (see Page 22 – 23 of [8]). Various types of generating functions include ordinary generating functions, exponential generating functions, Lambert series, Bell series, and Dirichlet series. Sieve of Eratosthenes (as generating algorithm for all prime numbers) and Dirichlet eta function (the *proxy* function for Riemann zeta function as generating function for all nontrivial zeros) are infinite series since they both encapsulate "infinite sequences of numbers". In this sense, *generating functions and generating algorithms are literally synonymous with infinite series*. By the same token, harmonic series formed by summing all positive [or alternating positive and negative] unit fractions, are infinite series and can thus also be conveniently regarded as generating functions.

*Remark 1.7. L-functions*, sometimes denoted by  $\mathbb{L}$  [e.g. Riemann zeta function, Dirichlet eta function, Dedekind zeta function, Dirichlet L-functions, Hecke L-functions, Automorphic L-functions, Artin L-functions, elliptic functions, etc] are **meromorphic functions on the complex plane, associated to one out of several categories of mathematical objects** [viz, anything that has been or could be formally defined, and with which one may do deductive reasoning and mathematical proofs] e.g. Dirichlet character, Hecke character, Artin representations of Galois group  $G$ , modular form,  $\lambda$ -ring, Hilbert space, dual vector space, elliptic curve  $E$  (abelian variety) defined over field  $K$  (which can be general field, finite fields,



quadratic field  $\mathbb{Q}\sqrt{d}$  with  $d$  a square-free integer, field of  $p$ -adic numbers  $\mathbb{Q}_p$ , rational numbers  $\mathbb{Q}$ , real numbers  $\mathbb{R}$  or complex numbers  $\mathbb{C}$ ), etc. Maass form, as a type of modular form, refers to automorphic forms on  $GL_n$  (for some positive integer  $n$ ), which are not holomorphic. Instead of satisfying Cauchy-Riemann equations (as holomorphic functions do), these functions are eigenfunctions of Casimir element in the universal enveloping algebra of the Lie algebra of  $GL_n$ . Although many well-known L-functions are associated with abelian objects or groups, there exist L-functions associated with non-abelian objects e.g. Galois groups can be of finite abelian groups or finite non-abelian groups.

A 'general' Dirichlet series is an infinite series of the form  $\sum_{n=1}^{\infty} a_n e^{-\lambda_n s}$  where  $a_n, s$  are complex numbers and  $\{\lambda_n\}$  is a strictly increasing sequence of nonnegative real numbers that tends to infinity. An 'ordinary' Dirichlet series  $\sum_{n=1}^{\infty} \frac{a_n}{n^s}$  is obtained by substituting  $\lambda_n = \ln n$  while a power series  $\sum_{n=1}^{\infty} a_n (e^{-s})^n$  is obtained when  $\lambda_n = n$ . \*\*Riemann zeta function  $\zeta(s)$  as non-alternating harmonic series Eq. (1) is the **most basic** 'ordinary' Dirichlet series with complex sequence  $a_n = 1$  for  $n = 1$  to  $\infty$ \*\*. Hurwitz zeta function is one of many zeta functions formally defined for complex variables  $s$  with  $\text{Re}(s) > 1$  and  $a \neq 0, -1, -2, -3, \dots$  by  $\zeta(s, a) = \sum_{n=0}^{\infty} \frac{1}{(n+a)^s}$ . This series is absolutely convergent for given values of  $s$  &  $a$ , and can be extended to a meromorphic function defined for all  $s \neq 1$ . \*\*Riemann zeta function is then  $\zeta(s, 1)$ \*\*.

**In more details:** Dirichlet L-series is a function of the form  $L(s, \chi) = \sum_{n=1}^{\infty} \frac{\chi(n)}{n^s}$  where  $\chi$  is a Dirichlet character and  $s$  a complex variable with  $\text{Re}(s) > 1$ . It is a special case of a Dirichlet series. By analytic continuation, it can be extended to a meromorphic function on whole complex plane, and is then called Dirichlet L-function and also denoted  $L(s, \chi)$ . Since Dirichlet character  $\chi$  is completely multiplicative, its L-function can also be written as an Euler product in the half-plane of absolute convergence  $L(s, \chi) = \prod_p (1 - \chi(p)p^{-s})^{-1}$  for  $\text{Re}(s) > 1$  where the product is over all prime numbers. Dirichlet L-functions may be written as a linear combination of Hurwitz zeta function at rational values. Fixing an integer  $k \geq 1$ , Dirichlet L-functions for characters modulo  $k$  are linear combinations, with constant coefficients, of  $\zeta(s, a)$  where  $a = \frac{r}{k}$  and  $r = 1, 2, 3, \dots, k$ . This means Hurwitz zeta function for rational  $a$  has analytic properties that are closely related to Dirichlet L-functions. Specifically, let  $\chi$  be a character modulo  $k$ . Then we can write its Dirichlet L-function as  $L(s, \chi) = \sum_{n=1}^{\infty} \frac{\chi(n)}{n^s} = \frac{1}{k^s} \sum_{r=1}^k \chi(r) \zeta\left(s, \frac{r}{k}\right)$ .

**In more details:** Dirichlet L-functions satisfy a functional equation, which provides a way to analytically continue them throughout the complex plane. The functional equation relates the value of  $L(s, \chi)$  to the value of  $L(1-s, \bar{\chi})$ . Let  $\chi$  be a primitive character modulo  $q$ , where  $q > 1$ . One way to express functional equation is  $L(s, \chi) = \varepsilon(\chi) 2^s \pi^{s-1} q^{1/2-s} \sin\left(\frac{\pi}{2}(s+a)\right) \Gamma(1-s) L(1-s, \bar{\chi})$ . In this equation,  $\Gamma$  denotes gamma function;  $a$  is 0 if  $\chi(-1) = 1$ , or 1 if  $\chi(-1) = -1$ ; and  $\varepsilon(\chi) = \frac{\tau(\chi)}{i^a \sqrt{q}}$  where  $\tau(\chi)$  is a Gauss sum  $\tau(\chi) = \sum_{n=1}^q \chi(n) \exp(2\pi i n/q)$ . It is a property of Gauss sums that  $|\tau(\chi)| = q^{1/2}$ , so  $|\varepsilon(\chi)| = 1$ . Another way

to state functional equation is in terms of  $\xi(s, \chi) = \left(\frac{q}{\pi}\right)^{(s+a)/2} \Gamma\left(\frac{s+a}{2}\right) L(s, \chi)$ . The functional equation is expressed as  $\xi(s, \chi) = \varepsilon(\chi) \xi(1-s, \bar{\chi})$ . The functional equation implies  $L(s, \chi)$  and  $\xi(s, \chi)$  are entire functions of  $s$ . Again, this assumes  $\chi$  is primitive character modulo  $q$  with  $q > 1$ . If  $q = 1$ , then  $L(s, \chi) = \zeta(s)$  has a pole at  $s = 1$ .

In mathematics and theoretical physics, techniques of dimensional regularization, analytic regularization and zeta function regularization are types of regularization or summability methods that assigns finite values to divergent sums or products. They are then used to define determinants and traces of some self-adjoint operators [which admit orthonormal eigenbasis with real eigenvalues]. Inspired by Method of Smoothed asymptotics developed by Prof. Terence Tao in 2010, we base some deductions in this paper on introduction in 2024 by Prof. Antonio Padilla and Prof. Robert Smith of a new ultra-violet regularization scheme for loop integrals in Quantum field theory dubbed  $\eta$  regularization. We outline in section 4 rich underlying connections between analytic number theory and perturbative quantum field theory.

The functoriality conjecture states that a suitable homomorphism of L-groups is expected to give a correspondence between Automorphic forms (in the global case) or Representations (in the local case). Roughly speaking, Langlands reciprocity conjecture is the special case of functoriality conjecture when one of the reductive groups is trivial. *Broadly viewed as vast "resource materials" that support completed 2001 proofs on modularity theorem*, we have bi-directional correspondences (bridges) existing between Number theory  $\leftrightarrow$  Harmonic analysis forming "framework" for L-functions and modular forms database (LMFDB, launched on May 10, 2016)[3] involving reciprocity conjecture, functoriality conjecture, etc: (i) {Elliptic curves  $\leftrightarrow$  Modular forms}; (ii) {Counting problem  $1 + p$ -number of solutions mod  $p$  [in *finite series* Elliptic curves]  $\leftrightarrow$  Coefficients of  $q^p$  [in *infinite series* Modular forms]} whereby nome  $q = e^{\pi i \tau}$  and  $p =$  prime numbers from Modular forms act as (periodic) 'generating series or functions' having Group of symmetry =  $SL_2(\mathbb{Z})$  [involving unit disk in complex plane], which is analogous to Group of symmetry = Group of integers  $\mathbb{Z}$  [involving real number line present in general solutions such as  $\sin(x + 2\pi n) = \sin(x)$  with  $n = \dots - 3, -2, -1, 0, 1, 2, 3, \dots$ ]; viz, these properties conform to the *Langlands program "Theory of Symmetry"* [for Transformations of Rotation, Translation, Dilation and Reflection]; and (iii) {Representations of Galois groups  $\leftrightarrow$  Automorphic forms} whereby Modular forms are classified as a specific type of these [more general] Automorphic forms, which are ultimate objects in Harmonic analysis.

We have infinities or infinitely large numbers as the unbounded and limitless quantities ( $\infty$ ) at the big end, and infinitesimals or infinitely small numbers as the extremely small but nonzero quantities ( $\frac{1}{\infty}$ ) at the small end. Applying infinitesimals to their corresponding outputs in section 6 allow us to prove 1859-dated Riemann hypothesis [viz, the proposal that relevant outputs as infinitely many nontrivial zeros or Origin intercept points of Riemann zeta function are all located on its  $\sigma = \frac{1}{2}$ -critical line or  $\sigma = \frac{1}{2}$ -Origin point], and Polignac's and Twin prime conjectures [viz, the proposal that relevant outputs as subsets of Odd Primes derived from every even Prime gaps 2, 4, 6, 8, 10... all contain infinitely many unique elements]. Referring to even Prime gap 2, 1846-dated Twin prime conjecture is simply a subset of 1849-dated Polignac's conjecture [which refers to all even Prime gaps 2, 4, 6, 8, 10...]. Altered terminology on

cardinality of Odd Primes being *arbitrarily large number* (ALN) instead of *infinitely many* was previously used by us to denote *Modified* Polignac's and Twin prime conjectures.

We opine our *generic mathematical approaches* for solving open problems is applicable to other branches of science such as relativistic quantum mechanics, quantum gravity or string theory. When construed as a self-sufficient research paper, correct and complete mathematical arguments condensed in this current paper are the major (core) arguments from publications [6], [7] & [8] whereby Riemann zeta function [= function that faithfully generates output of all nontrivial zeros via its *proxy* Dirichlet eta function] and Sieve of Eratosthenes [= algorithm that faithfully generates output of all prime numbers] are treated as de novo or derived infinite series in order to prove their connected open problems in Number theory. These infinite series are either convergent series or divergent series where partial sums of sequence from the former tends to a finite limit, while that from the later do not tend to a finite limit [viz, it tends to infinity]. Prime number theorem for Arithmetic Progressions [as Axiom 1], Generic Squeeze theorem [as Theorem 3.1] and Theorem of Divergent-to-Convergent series conversion for Prime numbers [as Theorem 4.1] are outlined (respectively) in section 2, section 3 and section 4. Lemma 5.1 and Lemma 5.2 in section 5 (respectively) introduce novel concept of Incompletely Predictable entities and innovatively classifying countably infinite sets into accelerating, linear or decelerating subtypes. To the extent that some associated minor (peripheral) arguments were not included in this paper, we advocate their absence [resulting in less distraction] do not adversely reflect the rigorous nature of our derived proofs but, rather, helps disseminate mathematical knowledge to the lay person and scientific community.

A function [sometimes loosely termed an operator or an equation] is usefully defined as relation between a set of inputs (called domain) and a set of possible outputs (called codomain) where each input is related to EXACTLY one output. More precisely, classical example of [linear] operator performed on [eligible] functions is differentiation. An algorithm is usefully defined as finite sequence of rigorous instructions typically used to solve a class of specific problems or to perform a computation. Functions or algorithms as infinite-dimensional vectors: A function or algorithm defined on real numbers  $\mathbb{R}$  can be represented by an uncountably infinite set of vectors (as a vector field) while a function or algorithm defined on natural numbers  $\mathbb{N}$  [or any other countably infinite domain such as prime numbers and composite numbers] can be represented by a countably infinite set of vectors (as a vector field). One could also use the later countably infinite set of vectors involving [discrete]  $\mathbb{N}$  {e.g. all nontrivial zeros of Riemann zeta function interpolated as "nearest"  $t$ -valued  $\mathbb{N}$  14, 21, 25, 30, 33, 38, 41, 43...} to approximate the former uncountably infinite set of vectors that "pseudo-represent" [continuous]  $\mathbb{R}$  {for the same nontrivial zeros when precisely given as  $t$ -valued transcendental numbers}  $\cong$  Law of continuity: If a quantity changes "continuously", then its value at any point between two given values can be determined by the process of interpolation.

Based on Figure 1 and Figure 2 that accommodate both positive (+ve) parts and negative (–ve) counterparts of prime numbers, composite numbers and nontrivial zeros, **we can represent eligible functions with complex vector space [having +ve and –ve complex vectors pointing in opposite directions] and eligible algorithms with real vector space [having +ve and –ve real vectors pointing in opposite**

*One-dimensional integer number line containing Prime and Composite numbers*

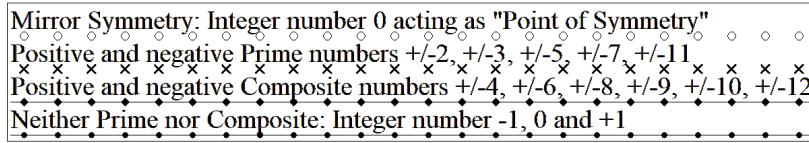

*Integer number line (from -12 to +12 depicted on the horizontal or x-axis)*  
 -12 -11 -10 -9 -8 -7 -6 -5 -4 -3 -2 -1 0 1 2 3 4 5 6 7 8 9 10 11 12

Figure 1. Narrow range of positive & negative prime and composite numbers plotted together on integer number line generated using Sieve-of-Eratosthenes and complement-Sieve-of-Eratosthenes. The combined [positive] image and [negative] mirror image will conceptually represent a one-dimensional line (state) having perfect Mirror symmetry with integer number 0 acting as the Point of symmetry.

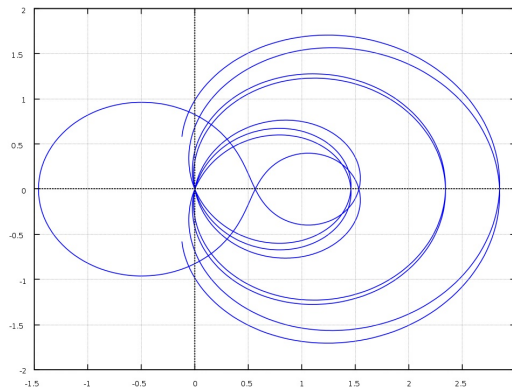

Figure 2. OUTPUT for  $\sigma = \frac{1}{2}$  as Gram points. Polar graph of  $\zeta(\frac{1}{2} + it)$  depicted as a two-dimensional figure (state) plotted along critical line for real values of  $t$  between  $-30$  and  $+30$  [viz, for  $s = \sigma \pm t$  range], horizontal axis:  $Re\{\zeta(\frac{1}{2} + it)\}$ , and vertical axis:  $Im\{\zeta(\frac{1}{2} + it)\}$ . Origin intercept points are present. There is manifestation of perfect Mirror symmetry about horizontal x-axis acting as the line of symmetry.

**directions]:** Recall that a row vector or a column vector is, respectively, a one-row matrix or a one-column matrix. Real numbers  $\mathbb{R}$  [and natural numbers  $\mathbb{N}$ ] are exactly one-dimensional vectors (on a line) and complex numbers  $\mathbb{C}$  are exactly two-dimensional vectors (in a plane). A complex vector (or complex matrix) as Cartesian representation  $z = x + iy$  or Polar representation  $z = r(\cos \theta + i \cdot \sin \theta)$  is simply a vector (matrix) of the complex numbers. A two-dimensional real vector (or real matrix) in a plane is given by Cartesian representation as  $v = x + y$  or Polar representation as  $v = r(\cos \theta + \sin \theta)$ .  $x$  &  $y$  are

$\mathbb{R}$ , modulus  $r = |z|$  or  $|v| = \sqrt{x^2 + y^2}$ , multi-valued  $\arg(z)$  or  $\arg(v)$  or principal-valued  $\text{Arg}(z)$  or  $\text{Arg}(v) = \theta = \arctan(y/x)$ , and imaginary unit  $i = \sqrt{-1}$ .

Integers  $\{0, 1\}$  are neither prime nor composite. Prime & composite numbers form distinct countably infinite sets of integers as two subsets in uncountably infinite set of real numbers. Both [algorithmic] inputs Sieve-of-Eratosthenes and Complement-Sieve-of-Eratosthenes in section 2 that faithfully generate outputs prime & composite numbers are visually represented by countably infinite set of real vectors. We recognize all real vector sub-spaces for even Prime gaps 2, 4, 6, 8, 10... with each unique sub-space constituted by its corresponding countably infinite set of real vectors, must imply Modified Polignac's and Twin prime conjectures are true.

Where  $\sigma, t, \text{Re}\{\zeta(s)\}, \text{Im}\{\zeta(s)\}, \text{Re}\{\eta(s)\}$  and  $\text{Im}\{\eta(s)\}$  are  $\mathbb{R}$ , (input) parameter  $s = \sigma \pm it$  used in (output) functions from section 2 such as non-alternating Riemann zeta function Eq. 1  $\zeta(s) = \text{Re}\{\zeta(s)\} + i \cdot \text{Im}\{\zeta(s)\}$  and alternating Dirichlet eta function Eq. 2  $\eta(s) = \text{Re}\{\eta(s)\} + i \cdot \text{Im}\{\eta(s)\}$  are recognized to all be given in  $z = x + iy$  format, thus allowing uncountably infinite set of complex vectors to visually represent them. Next consider the two derived functions from section 2: simplified Dirichlet eta function or  $\text{sim-}\eta(s)$  and Dirichlet Sigma-Power Law or DSPL [=  $\int \text{sim-}\eta(s)dn \equiv$  "signed area under a curve" for this Riemann integrable function] with their corresponding horizontal and vertical axes being perpendicular to each other or, equivalently, being  $\frac{\pi}{2}$  out-of-phase with each other (as per Page 12 of [6]). Complex vectors representing  $\text{sim-}\eta(s)$  and DSPL when combined together form an orthonormal set in the inner product space since all these vectors in the set are mutually orthogonal ("perpendicular") and can be depicted using their ("normalized") unit length. When equivalently expressed using countably infinite set of complex vectors; we recognize nontrivial zeros of  $\zeta(s), \eta(s), \text{sim-}\eta(s)$  or DSPL that only exist in unique  $\sigma = \frac{1}{2}$  complex vector sub-space, must imply Riemann hypothesis is true.

Non-alternating power series  $\sum_{n=0}^{\infty} a_n x^n = a_0 + a_1 x + a_2 x^2 + a_3 x^3 + \dots$

Alternating power series  $\sum_{n=0}^{\infty} (-1)^n a_n x^n = a_0 - a_1 x + a_2 x^2 - a_3 x^3 + \dots$

Non-alternating harmonic series $\sum_{n=1}^{\infty} \frac{1}{n} = \frac{1}{1} + \frac{1}{2} + \frac{1}{3} + \frac{1}{4} + \frac{1}{5} + \dots$
---

Alternating harmonic series $\sum_{n=1}^{\infty} \frac{(-1)^{n+1}}{n} = \frac{1}{1} - \frac{1}{2} + \frac{1}{3} - \frac{1}{4} + \frac{1}{5} - \dots$
--

\*\*When  $s = 1$  in Eq. 1  $\zeta(s)$  & Eq. 2  $\eta(s)$  with  $n = +ve$  integers, we (respectively) obtain the above **most basic** Non-alternating harmonic series and Alternating harmonic series\*\*. An infinite series [listed above as various types of power series and harmonic series] (or a finite series) is sum of  $[\geq 1]$  infinite (or finite) sequence of terms constituted by numbers, scalars, or anything *such as functions, vectors, matrices*. As previously discussed, power series [with VARYING coefficients  $a_n$ ] are infinite polynomials. Sieve-of-Eratosthenes & Complement-Sieve-of-Eratosthenes as well-defined infinite algorithms give rise to [infinite]  $n$  solutions of all primes & composites; viz, they are the "analogs" of power or harmonic series as well-defined infinite functions. With SAME coefficients  $a$ , the (non-alternating) geometric series

$\sum_{n=0}^{\infty} ax^n = a + ax + ax^2 + ax^3 + \dots$  having +ve common ratio  $x$  between successive terms, is simply a special case of (non-alternating) power series e.g. when  $a = \frac{1}{2}$  &  $\frac{1}{2}$  for +ve common ratio. **Cf** when  $a = \frac{1}{2}$  &  $-\frac{1}{2}$  for -ve common ratio in an "inverse" (alternating) geometric series, which is simply a special case of (alternating) power series (Page 56 of [8]):

$$\sum_{n=0}^{\infty} \frac{1}{2} \left(-\frac{1}{2}\right)^n = \frac{1}{2} - \frac{1}{4} + \frac{1}{8} - \frac{1}{16} + \dots = \frac{\frac{1}{2}}{1 - (-\frac{1}{2})} = \frac{1}{3} \quad \text{Cf} \quad \sum_{n=0}^{\infty} \frac{1}{2} \left(\frac{1}{2}\right)^n = \frac{1}{2} + \frac{1}{4} + \frac{1}{8} + \frac{1}{16} + \dots = \frac{\frac{1}{2}}{1 - (\frac{1}{2})} = 1.$$

Power and Harmonic (infinite) series defined over prime numbers  $p$ , with  $a_{p_n} = p_n$ , for example:

$$\text{Non-alternating power series } \sum_{n=1}^{\infty} a_{p_n} x^{p_n} = \sum_{n=1}^{\infty} p_n x^{p_n} = 2x^2 + 3x^3 + 5x^5 + 7x^7 + 11x^{11} + \dots$$

$$\text{Alternating power series } \sum_{n=1}^{\infty} (-1)^{n-1} a_{p_n} x^{p_n} = \sum_{n=1}^{\infty} (-1)^{n-1} p_n x^{p_n} = 2x^2 - 3x^3 + 5x^5 - 7x^7 + 11x^{11} - \dots$$

Non-alternating harmonic series $\sum_{n=1}^{\infty} \frac{1}{p} = \frac{1}{2} + \frac{1}{3} + \frac{1}{5} + \frac{1}{7} + \frac{1}{11} + \dots$
--

Alternating harmonic series $\sum_{n=1}^{\infty} \frac{(-1)^{n+1}}{p} = \frac{1}{2} - \frac{1}{3} + \frac{1}{5} - \frac{1}{7} + \frac{1}{11} - \dots$
---

An expression is in closed form if it is formed with constants, variables and a finite set of basic functions connected by arithmetic operations (viz, +, -, ×, ÷, and integer powers) and function composition. The commonly allowed functions are [I] the algebraic functions [viz, defined as the root of an irreducible polynomial equation] e.g.  $n^{\text{th}}$  root or raising to a fractional power and [II] the transcendental (non-algebraic) functions e.g. exponential function, logarithmic function,  $\Gamma$  function, trigonometric functions and their inverses. The algebraic and transcendental (non-algebraic) solutions form two subsets of closed-form expressions. Thus, a solution in radicals or algebraic solution is a closed-form expression, and more specifically a closed-form algebraic expression, that is solution of a polynomial equation, and relies only on addition, subtraction, multiplication, division, raising to integer powers, and extraction of  $n^{\text{th}}$  roots (square roots, cube roots, and other integer roots). Following directly from Galois theory using polynomial  $f(x) = x^5 - x - 1$  as a simplest example of non-solvable quintic polynomial, Abel-Ruffini theorem states that there is no solution in radicals to SOME general (finite) polynomial equations of degree five or higher with arbitrary coefficients. Here, *general* meant the coefficients of a polynomial equation are viewed and manipulated as indeterminates. We extrapolate: Any power series [e.g.  $e^x$ ,  $\sin x$ ,  $\sinh x$ ,  $\ln x$ , etc] as general (infinite) polynomial equations having infinitely many coefficients should have no solution in radicals [viz, have transcendental solutions]. However some power series with coefficients involving (infinite) polynomials [e.g. geometric series, binomial series, etc] can have solutions expressible in terms of radicals, provided the series converges within the domain where such expressions are valid. Similar to, but not categorized as, power series are various hypergeometric series [as defined by the generalized hypergeometric function] that could have either transcendental solutions or solutions in radicals.

Eq. 1  $\zeta(s)$  & Eq. 2  $\eta(s)$  have complex variable  $s = \sigma \pm it$ . In  $0 < \sigma < 1$  critical strip containing  $\sigma = \frac{1}{2}$  critical line,  $\eta(s)$  must act as proxy function for  $\zeta(s)$  [with both  $\equiv$  infinite series]. Useful relationship:  $z$  as a



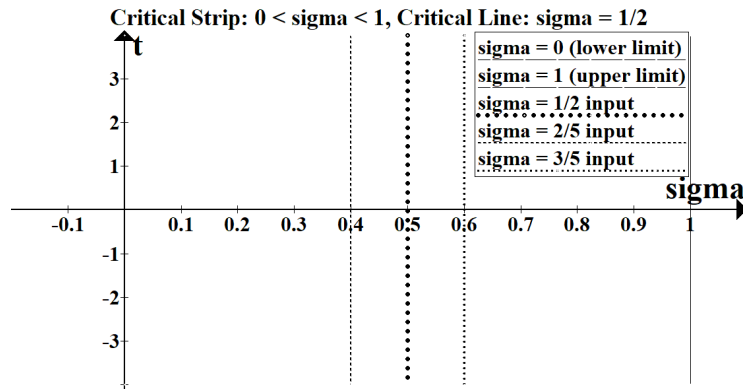

Figure 3. INPUT for  $\sigma = \frac{1}{2}$  (for Figure 4),  $\frac{2}{5}$  (for Figure 5), and  $\frac{3}{5}$  (for Figure 6). Riemann zeta function  $\zeta(s)$  has two countable infinite sets of firstly, Completely Predictable trivial zeros located at  $s =$  all negative even numbers and secondly, Incompletely Predictable nontrivial zeros located at  $\sigma = \frac{1}{2}$  as various  $t$ -valued transcendental numbers.

complex number  $\mathbb{C}$  is defined by  $z = a+bi$  with  $i$  being the imaginary unit, and  $a, b \in$  real numbers  $\mathbb{R}$ . Then  $\mathbb{R} \subset \mathbb{C}$  since when  $b = 0$ ,  $z = a + 0i = a$  will always be  $\mathbb{R}$ . Our "amalgated" *generic Fundamental Theorem of Algebra* heuristically  $\implies$  (eligible) general [finite or infinite or ALN] algorithms and functions (of degree  $n$  with real or complex coefficients) have exactly [finite or infinite or ALN]  $n$  roots or  $n$  solutions as real or complex numbers, counting *multiplicities* {e.g.  $\sin(x + 2\pi n)$  with  $n = \dots -3, -2, -1, 0, 1, 2, 3, \dots; \pm$ nontrivial zeros;  $\pm$ Primes;  $\pm$ Composites; etc}. Riemann hypothesis is true when nontrivial zeros as Origin point intercepts are the infinitely many  $n$  roots that only occur when parameter  $\sigma = \frac{1}{2}$  resulting in [optimal] "formula symmetry" for  $\eta(s)$  [as **infinite series**]. Polignac's and Twin prime conjectures are true when Sieve-of-Eratosthenes algorithm and its derived sub-algorithms [as "**infinite series**" via  $\sum_{n=i}^{ALN} p_{n+1} = 3 + \sum_{i=2}^n g_i$ ] have ALN of  $n$  solutions represented by the Set  $\equiv$  total] of Odd Primes and Subsets  $\equiv$  subtotals] of Odd Primes derived from all even Prime gaps.

## 2. General notations including Prime number theorem for Arithmetic Progressions and creating *de novo* Infinite Series

Common abbreviations used in this paper: CP = Completely Predictable, IP = Incompletely Predictable, FL = Finite-Length, IL = Infinite-Length, CFS = countably finite set, CIS = countably infinite set, IM = infinitely-many, ALN = arbitrarily large number. We treat eligible algorithms and functions as *de novo* infinite series. Critical strip  $\equiv \{s \in \mathbb{C} : 0 < \text{Re}(s) < 1\}$  & Critical line  $\equiv \{s \in \mathbb{C} : \text{Re}(s) = \frac{1}{2}\}$  in Figure 3. Phrase "*inside* the critical strip" refers to parameter  $s [= \sigma \pm it$  with  $0 < \sigma < 1$ ; viz,  $0 < \text{Re}(s) < 1$ ] having complex number values defined for  $\eta(s)$  as given by parameter  $t$  over  $\pm$  real numbers. Phrase "*outside* the critical strip" refers to parameter  $s [= \sigma \pm it$  with  $\sigma > 1$ ; viz,  $\text{Re}(s) > 1$ ] having complex number values defined for  $\zeta(s)$  as given by parameter  $t$  over  $\pm$  real numbers.



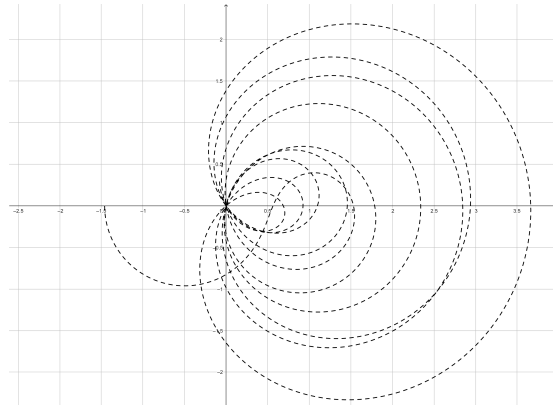

Figure 4. OUTPUT for  $\sigma = \frac{1}{2}$  as Gram points. Polar graph of  $\zeta(\frac{1}{2} + it)$  plotted along critical line for real values of  $t$  running from 0 to 34. Horizontal axis:  $Re\{\zeta(\frac{1}{2} + it)\}$ . Vertical axis:  $Im\{\zeta(\frac{1}{2} + it)\}$ . Presence of Origin intercept points. **Nil-shift w.r.t. Origin point when  $\sigma = \frac{1}{2}$ .**

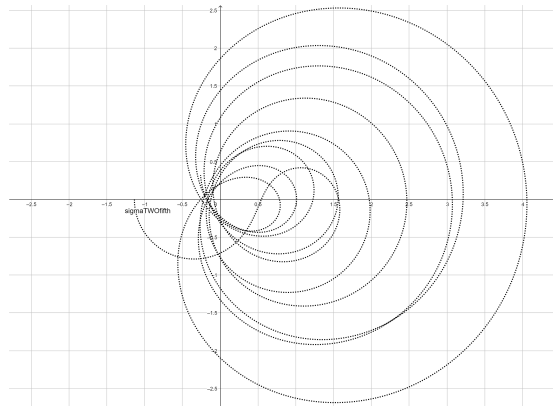

Figure 5. OUTPUT for  $\sigma = \frac{2}{5}$  as virtual Gram points. Varying Loops are shifted to left of Origin with horizontal axis:  $Re\{\zeta(\frac{2}{5} + it)\}$ , and vertical axis:  $Im\{\zeta(\frac{2}{5} + it)\}$ . Nil Origin intercept points. **Left-shift w.r.t. Origin point when  $\sigma < \frac{1}{2}$ ; viz,  $0 < \sigma < \frac{1}{2}$ .**

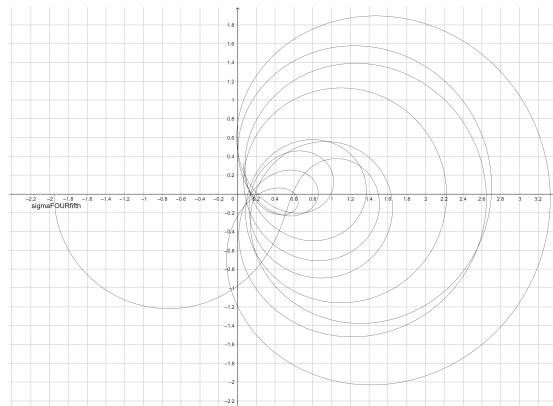

Figure 6. OUTPUT for  $\sigma = \frac{3}{5}$  as virtual Gram points. Varying Loops are shifted to right of Origin with horizontal axis:  $Re\{\zeta(\frac{3}{5} + it)\}$ , and vertical axis:  $Im\{\zeta(\frac{3}{5} + it)\}$ . Nil Origin intercept points. **Right-shift w.r.t. Origin point when  $\sigma > \frac{1}{2}$ ; viz,  $\frac{1}{2} < \sigma < 1$ .**

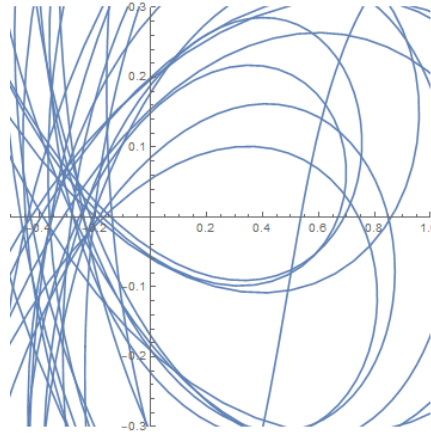

Figure 7. Close-up view of virtual Origin points when  $\sigma = \frac{1}{3}$ . OUTPUT for  $\sigma = \frac{1}{3}$  [ $\sigma < \frac{1}{2}$  situation] as virtual Gram points. Polar graph of  $\zeta(\frac{1}{3} + it)$  plotted along non-critical line for real values of  $t$  running between 0 and 100, horizontal axis:  $Re\{\zeta(\frac{1}{3} + it)\}$ , and vertical axis:  $Im\{\zeta(\frac{1}{3} + it)\}$ . Total absence of all Origin intercept points at "static" Origin point. Total presence of all virtual Origin intercept points (as additional negative virtual Gram[ $y=0$ ] points on  $x$ -axis) at "varying" [infinitely many] virtual Origin points. **With respect to  $\sigma = \frac{1}{2}$ -Origin point being analogically the  $\sigma = \frac{1}{2}$ -'Centroid', then the [depicted] "left-shifted"  $\sigma = \frac{1}{3}$  as being  $\frac{1}{3} - \frac{1}{2} = -\frac{1}{6}$  and the [undepicted] "right-shifted"  $\sigma = \frac{2}{3}$  as being  $\frac{2}{3} - \frac{1}{2} = +\frac{1}{6}$  are BOTH equidistant from 'Centroid' [thus fully satisfying (Remark 2.2) Principle of Equidistant for Multiplicative Inverse – see last paragraph discussion in section 6 Conclusions.**

#### List of abbreviations incorporating relevant definitions:

- CP entities:** These entities manifest CP *independent* properties.
- IP entities:** These entities manifest IP *dependent* properties.
- $\zeta(s)$ :  $f(n)$  Riemann zeta function [ $\equiv$  **infinite (converging) series** for  $Re(s) > 1$ ] – see Eq. (1) below containing variable  $n$ , and parameters  $t$  and  $\sigma$  will generate [via its *proxy* Dirichlet eta function] Zeroes when  $\sigma = \frac{1}{2}$  and virtual Zeroes when  $\sigma \neq \frac{1}{2}$ .
- $\eta(s)$ :  $f(n)$  Dirichlet eta function [ $\equiv$  **infinite (converging) series** for  $Re(s) > 0$ ] – see Eq. (2) below as the analytic continuation of  $\zeta(s)$ , containing variable  $n$ , and parameters  $t$  and  $\sigma$  will generate Zeroes when  $\sigma = \frac{1}{2}$  and virtual Zeroes when  $\sigma \neq \frac{1}{2}$ .
- sim- $\eta(s)$ :**  $f(n)$  simplified Dirichlet eta function [ $\equiv$  **infinite (converging) series** for  $Re(s) > 0$ ], derived by applying Euler formula to  $\eta(s)$ , containing variable  $n$ , and parameters  $t$  and  $\sigma$  will generate Zeroes when  $\sigma = \frac{1}{2}$  – see Eq. (4) below and virtual Zeroes when  $\sigma \neq \frac{1}{2}$  – see Eq. (5) below.
- DSPL:**  $F(n)$  Dirichlet Sigma-Power Law [ $\equiv$  "continuous" **infinite (converging) series** for  $Re(s) > 0$ ] =  $\int \text{sim-}\eta(s)dn$  containing variable  $n$ , and parameters  $t$  and  $\sigma$  will generate Pseudo-zeroes when  $\sigma = \frac{1}{2}$  – see Eq. (6) below and virtual Pseudo-zeroes when  $\sigma \neq \frac{1}{2}$  whereby the (virtual) Zeros = (virtual) Pseudo-zeros –  $\frac{\pi}{2}$  relationship allows (virtual) Pseudo-zeros to (virtual) Zeros conversion and *vice versa*.
- NTZ:** Nontrivial zeros located on the one-dimensional (mathematical)  $\sigma = \frac{1}{2}$ -critical line are precisely

equivalent to  $\mathbf{G}[\mathbf{x=0,y=0}]\mathbf{P}$ : Gram $[\mathbf{x=0,y=0}]$  points as Origin intercept points which are located at the zero-dimensional (geometrical)  $\sigma = \frac{1}{2}$ -Origin point [as per Figure 4]. These entities, mathematically defined by  $\sum ReIm\{\eta(s)\} = Re\{\eta(s)\} + Im\{\eta(s)\} = 0$ , are generated by equation  $\mathbf{G}[\mathbf{x=0,y=0}]\mathbf{P}-\eta(s)$  containing exponent  $\frac{1}{2}$  when  $\sigma = \frac{1}{2}$ .

·**GP or  $\mathbf{G}[\mathbf{y=0}]\mathbf{P}$** : 'usual' or 'traditional' Gram points = Gram $[\mathbf{y=0}]$  points = x-axis intercept points that are [multiple-positioned] located on one-dimensional x-axis line are generated by equation  $\mathbf{G}[\mathbf{y=0}]\mathbf{P}-\eta(s)$  when  $\sigma = \frac{1}{2}$ . These entities are mathematically defined by  $\sum ReIm\{\eta(s)\} = Re\{\eta(s)\} + 0$ , or simply  $Im\{\eta(s)\} = 0$ . Riemann hypothesis is usefully stated as none of the [additional] virtual  $\mathbf{G}[\mathbf{x=0}]\mathbf{P}$  generated by equation  $\mathbf{G}[\mathbf{x=0}]\mathbf{P}-\eta(s)$  when  $\sigma \neq \frac{1}{2}$  – as demonstrated by Figure 7 for  $\sigma = \frac{1}{3}$  – can be constituted by  $t$  transcendental number values that [incorrectly] coincide with  $t$  transcendental number values for NTZ when  $\sigma = \frac{1}{2}$ .

· **$\mathbf{G}[\mathbf{x=0}]\mathbf{P}$** : Gram $[\mathbf{x=0}]$  points = y-axis intercept points that are [multiple-positioned] located on one-dimensional y-axis line are generated by equation  $\mathbf{G}[\mathbf{x=0}]\mathbf{P}-\eta(s)$  when  $\sigma = \frac{1}{2}$ . These entities are mathematically defined by  $\sum ReIm\{\eta(s)\} = 0 + Im\{\eta(s)\}$ , or simply  $Re\{\eta(s)\} = 0$ .

·**virtual NTZ**: virtual nontrivial zeros or **virtual  $\mathbf{G}[\mathbf{x=0,y=0}]\mathbf{P}$** : virtual Gram $[\mathbf{x=0,y=0}]$  points. These are virtual Origin intercept points located at the multiple-positioned virtual Origin points which are generated by equation virtual- $\mathbf{G}[\mathbf{x=0,y=0}]\mathbf{P}-\eta(s)$  containing exponent values  $\neq \frac{1}{2}$  when  $\sigma \neq \frac{1}{2}$ . We note that each virtual NTZ when  $\sigma < \frac{1}{2}$  in Figure 5 equates to an [additional] negative virtual  $\mathbf{G}[\mathbf{y=0}]\mathbf{P}$  located at IP varying positions on horizontal axis, and each virtual NTZ when  $\sigma > \frac{1}{2}$  in Figure 6 equates to an [additional] positive virtual  $\mathbf{G}[\mathbf{y=0}]\mathbf{P}$  located at IP varying positions on horizontal axis. We observe overall less virtual  $\mathbf{G}[\mathbf{x=0}]\mathbf{P}$  when  $\sigma > \frac{1}{2}$ , and overall more virtual  $\mathbf{G}[\mathbf{x=0}]\mathbf{P}$  when  $\sigma < \frac{1}{2}$ .

·**Sieve-of-Eratosthenes (S-of-E)**: For  $i = 1, 2, 3, 4, 5\dots$  and with  $p_1 = 2$  [ $\equiv$  even prime number 2 forming a CFS with cardinality of 1] as the first term in S-of-E; the algorithm S-of-E as symbolically denoted by  $p_{n+1} = 2 + \sum_{i=1}^n g_i$  with  $g_n = p_{n+1} - p_n$  and its derived sub-algorithms faithfully generate the set of all prime numbers 2, 3, 5, 7, 11, 13... and subsets of Odd Primes derived from even Prime gaps 2, 4, 6, 8, 10... We now ignore even prime number 2 by changing variable  $i$  to instead commence from  $2^{nd}$  position. For  $i = 2, 3, 4, 5, 6\dots$  and with  $p_2 = 3$  [ $\equiv$  first Odd Prime 3] as the first term in Modified-S-of-E; the altered algorithm Modified-S-of-E as symbolically denoted by  $p_{n+1} = 3 + \sum_{i=2}^n g_i$  with  $g_n = p_{n+1} - p_n$  and its derived sub-algorithms will faithfully generate the set of all Odd Primes 3, 5, 7, 11, 13, 17... and subsets of Odd Primes derived from even Prime gaps 2, 4, 6, 8, 10... By performing summation [viz, conducting repeated addition of sequence from ALN of prime gaps and prime numbers that are arranged in a unique order] on above two algorithms as  $\sum_{n=i}^{ALN} p_{n+1} = 2 + \sum_{i=1}^n g_i$  and  $\sum_{n=i}^{ALN} p_{n+1} = 3 + \sum_{i=2}^n g_i$ , we obtain (de novo) infinite series. These infinite series are all **diverging series** for this two algorithms [and their derived sub-algorithms]. In contrast, Brun's constants as outlined in section 4 are **converging series**. The cardinality of CIS-ALN-decelerating is applicable for (i) set of all prime numbers, (ii) set of all Odd Primes, (iii) subsets of Odd Primes, and (iv) set of all even Prime gaps  $\implies$  Modified Polignac's and Twin prime

conjectures are true.

**Complement-Sieve-of-Eratosthenes:** For  $i = 1, 2, 3, 4, 5\dots$  and with  $c_1 = 4$ ; this algorithm as symbolically denoted by  $c_{n+1} = 4 + \sum_{i=1}^n c_i$  with  $g_n = c_{n+1} - c_n$  and its derived sub-algorithms will faithfully generate all composite numbers. Parallel arguments to construct de novo infinite series as **diverging series** for (sub)sets of composite numbers are also possible.

In general, we note the infinite-length sequence of a given converging series or diverging series can theoretically be constituted by either positive terms e.g.  $\zeta(s)$  as non-alternating harmonic series Eq. (1) OR alternating positive and negative terms e.g.  $\eta(s)$  as alternating harmonic series Eq. (2).

$$(1) \quad \zeta(s) = \sum_{n=1}^{\infty} \frac{1}{n^s} \\ = \frac{1}{1^s} + \frac{1}{2^s} + \frac{1}{3^s} + \frac{1}{4^s} + \frac{1}{5^s} + \dots \\ = \prod_{p \text{ prime}} \frac{1}{1-p^{-s}} = \frac{1}{1-2^{-s}} \cdot \frac{1}{1-3^{-s}} \cdot \frac{1}{1-5^{-s}} \cdot \frac{1}{1-7^{-s}} \cdot \frac{1}{1-11^{-s}} \dots \frac{1}{1-p^{-s}} \dots$$

Eq. (1) non-alternating harmonic series Riemann zeta function  $\zeta(s)$  is a function of complex variable  $s$  ( $= \sigma \pm it$ ) that continues sum of infinite series  $\zeta(s) = \sum_{n=1}^{\infty} \frac{1}{n^s} = \frac{1}{1^s} + \frac{1}{2^s} + \frac{1}{3^s} + \dots$  for  $\text{Re}(s) > 1$ , and its analytic continuation elsewhere for  $0 < \text{Re}(s) < 1$ . Containing no nontrivial zeros,  $\zeta(s)$  is defined only in  $1 < \sigma < \infty$  region where it is absolutely convergent. The common convention is to write  $s$  as  $\sigma + it$  with  $t = \sqrt{-1}$ , and with  $\sigma$  and  $t$  real. Valid for  $\sigma > 1$ , we write  $\zeta(s)$  as  $\text{Re}\{\zeta(s)\} + i\text{Im}\{\zeta(s)\}$  and note that  $\zeta(\sigma + it)$  when  $0 < t < +\infty$  is the complex conjugate of  $\zeta(\sigma - it)$  when  $-\infty < t < 0$ . In Eq. (1), the equivalent **Euler product formula** with product over all prime numbers implies the presence of Sieve of Eratosthenes. Also note that for all  $s \in \mathbb{C}$ ,  $s \neq 1$ , the integral relation  $\zeta(s) = \frac{1}{s-1} + \frac{1}{2} + 2 \int_0^{\infty} \frac{\sin(s \arctan t)}{(1+t^2)^{s/2} (e^{2\pi t} - 1)} dt$  holds true, which may be used for a numerical evaluation of the zeta function.

$$(2) \quad \eta(s) = \sum_{n=1}^{\infty} \frac{(-1)^{n+1}}{n^s} = \frac{1}{1^s} - \frac{1}{2^s} + \frac{1}{3^s} - \frac{1}{4^s} + \frac{1}{5^s} - \dots \\ = \prod_{p \text{ prime}} \frac{1-2^{1-s}}{1-p^{-s}} = \frac{1-2^{1-s}}{1-2^{-s}} \cdot \frac{1-2^{1-s}}{1-3^{-s}} \cdot \frac{1-2^{1-s}}{1-5^{-s}} \cdot \frac{1-2^{1-s}}{1-7^{-s}} \cdot \frac{1-2^{1-s}}{1-11^{-s}} \dots \frac{1-2^{1-s}}{1-p^{-s}} \dots \\ \text{When } s = 1, \prod_{p \text{ prime}} \frac{0}{1-p^{-1}} = \frac{0}{1-2^{-1}} \cdot \frac{0}{1-3^{-1}} \cdot \frac{0}{1-5^{-1}} \cdot \frac{0}{1-7^{-1}} \cdot \frac{0}{1-11^{-1}} \dots \frac{0}{1-p^{-1}} \dots = 0$$

For  $t = 0$  in  $s = \sigma + it$  [viz,  $s = \sigma = 1$ ], we get  $\eta(1) = \lim_{n \rightarrow \infty} \eta_{2n}(1) = \lim_{n \rightarrow \infty} R_n \left( \frac{1}{1+x}, 0, 1 \right) = \int_0^1 \frac{dx}{1+x} = \log 2 \neq 0$ . Otherwise, if  $t \neq 0$  [viz,  $\sigma = 0$  and  $s = it$ ], then  $|n^{1-s}| = |n^{-it}| = 1$ , which yields  $|\eta(s)| = \lim_{n \rightarrow \infty} |\eta_{2n}(s)| = \lim_{n \rightarrow \infty} \left| R_n \left( \frac{1}{(1+x)^s}, 0, 1 \right) \right| = \left| \int_0^1 \frac{dx}{(1+x)^s} \right| = \left| \frac{2^{1-s} - 1}{1-s} \right| = \left| \frac{1-1}{-it} \right| = 0$ , where  $R_n(f(x), a, b)$  denotes a special Riemann sum approximating the integral of  $f(x)$  over  $[a, b]$ .

Eq. (2) alternating harmonic series Dirichlet eta function  $\eta(s)$  that faithfully generates all three types of Gram points as three dependent CIS-IM-linear Incompletely Predictable entities when  $\sigma = \frac{1}{2}$  must represent and act as *proxy* function for Eq. (1) in  $0 < \sigma < 1$ -critical strip [viz, for  $0 < \text{Re}(s) < 1$ ] containing  $\sigma = \frac{1}{2}$ -critical line because  $\zeta(s)$  only converges when  $\sigma > 1$ . In Eq. (2), the equivalent **Euler product formula** with product over all prime numbers also implies the presence of Sieve of Eratosthenes. They are related to each other [via Analytic continuation] as  $\eta(s) = \gamma \cdot \zeta(s)$  or equivalently as  $\zeta(s) = \frac{1}{\gamma} \cdot \eta(s)$  with proportionality factor  $\gamma = 1 - 2^{1-s}$ .

$$(3) \quad \zeta(s) = 2^s \pi^{s-1} \sin\left(\frac{\pi s}{2}\right) \Gamma(1-s) \zeta(1-s)$$

$\zeta(s)$  satisfies **Eq. (3) as its reflection functional equation** whereby  $\Gamma$  is gamma function. Analogically,  $\eta(s)$  satisfies its **reflection functional equation**  $\eta(-s) = 2 \frac{1 - 2^{-s-1}}{1 - 2^{-s}} \pi^{-s-1} s \sin\left(\frac{\pi s}{2}\right) \Gamma(s) \eta(s+1)$ . [Note that derived for complex numbers with a positive real part,  $\Gamma$  is defined via a convergent improper integral  $\Gamma(z) = \int_0^\infty t^{z-1} e^{-t} dt$ ,  $\Re(z) > 0$ .  $\Gamma$  is then defined as analytic continuation of this integral function to a meromorphic function that is holomorphic in whole complex plane except zero and negative integers, where the function has simple poles. The main motivation for its development is  $\Gamma(x+1)$  interpolates factorial function  $x! = 1 \cdot 2 \cdot 3 \cdot \dots \cdot x$  to non-integer values. Important to String theory, **beta function** is a special function related to  $\Gamma$  and binomial coefficients; given by  $B(z_1, z_2) = \int_0^1 t^{z_1-1} (1-t)^{z_2-1} dt = \frac{\Gamma(z_1) \Gamma(z_2)}{\Gamma(z_1+z_2)}$  for complex number inputs  $z_1, z_2$  such that  $\Re(z_1), \Re(z_2) > 0$ .] As an equality of meromorphic functions valid on whole complex plane, functional equation Eq. (3) relates values of  $\zeta(s)$  at points  $s$  and  $1-s$ ; viz, it relates even positive integers with odd negative integers. The functional equation for  $\eta(s)$  relates values of  $\eta(s)$  at points  $-s$  and  $s+1$ ; viz, it relates even negative integers with odd positive integers. Owing to zeros of sine function, these functional equations implies both  $\zeta(s)$  and  $\eta(s)$  has a simple zero at each even negative integer  $s = -2, -4, -6, -8, -10, \dots$  known as trivial zeros of  $\zeta(s)$  and  $\eta(s)$ . When  $s$  is an even positive integer OR even negative integer, the (corresponding) product  $\sin(\frac{\pi s}{2}) \Gamma(1-s)$  OR  $\sin(\frac{\pi s}{2}) \Gamma(s)$  on right is non-zero because  $\Gamma(1-s)$  OR  $\Gamma(s)$  has a simple pole, which cancels simple zero of sine factor.

With perfect line symmetry at vertical line  $s = \frac{1}{2}$  and  $L_\zeta(s) \equiv \zeta(s)$ , we have a **symmetric version** of this functional equation applied to the Lambda-function given by  $\Lambda(s) = \pi^{-\frac{s}{2}} \Gamma\left(\frac{s}{2}\right) L_\zeta(s)$ , which satisfies  $\Lambda(s) = \Lambda(1-s)$  OR to the Riemann xi-function given by  $\xi(s) = \frac{1}{2} \pi^{-\frac{s}{2}} s(s-1) \Gamma\left(\frac{s}{2}\right) L_\zeta(s)$ , which satisfies  $\xi(s) = \xi(1-s)$ .  $\Lambda(s)$  OR  $\xi(s)$  is thus the 'completed zeta function' whereby  $\Gamma_{\mathbb{R}}(s) = \pi^{-\frac{s}{2}} \Gamma\left(\frac{s}{2}\right)$  is "gamma factor" as the local L-factor corresponding to Archimedean place, with the other factors in Euler product expansion being the local L-factors of non-Archimedean places. The conductor of L-function is positive integer  $N$  from  $N^{\frac{s}{2}}$ . For Riemann zeta function, its conductor  $N$  as derived from  $\pi^{-\frac{s}{2}} = \left(\frac{1}{\pi} \cdot 1\right)^{\frac{s}{2}}$  is 1.

*Remark 2.1.* Consider sequence  $\lambda_n = \frac{1}{(n-1)!} \frac{d^n}{ds^n} \left[ s^{n-1} \log \xi(s) \right] \Big|_{s=1}$ . As a possible pathway to solve Riemann hypothesis, Li's criterion states that this hypothesis is equivalent to the statement  $\lambda_n > 0$  for every positive integer  $n$  [viz, positivity of  $\lambda_n$ ]. The numbers  $\lambda_n$  (as the Additive invariants denoted by  $\mathbb{L}^*$  and sometimes defined with a slightly different normalization) are called Keiper-Li coefficients

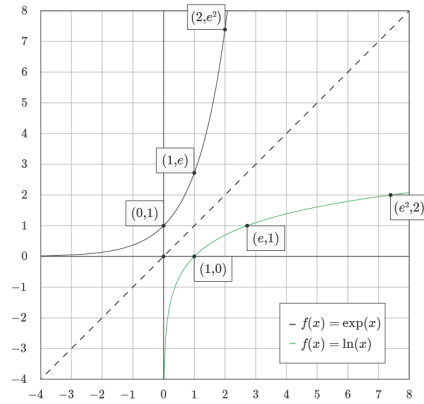

Figure 8. Natural logarithm function  $\log_e x$  or  $\ln(x)$ . Natural exponential function  $\exp(x)$  or  $e^x$ . The graphs of  $\log_e x$  and its inverse  $e^x$  are symmetric w.r.t. line  $y = x$ . Geometrically, this denote diagonal symmetry of the two functions; viz,  $\ln(e^x) = x$  and  $e^{\ln(x)} = x$ .

or Li coefficients. They may also be expressed in terms of nontrivial zeros of Riemann zeta function  $\lambda_n = \sum_{\rho} \left[ 1 - \left( 1 - \frac{1}{\rho} \right)^n \right]$  where the sum extends over  $\rho$ , the nontrivial zeros of the zeta function. This conditionally convergent sum should be understood in the sense usually used in Number theory; namely, that  $\sum_{\rho} = \lim_{N \rightarrow \infty} \sum_{|\text{Im}(\rho)| \leq N}$ . [Re(s) and Im(s) denote real and imaginary parts of s].

\*Remark 2.1 above outline a previously advocated (potential) pathway to solve Riemann hypothesis.\*

$$(4) \quad \text{At } \sigma = \frac{1}{2}, \text{ sim-}\eta(s) = \sum_{n=1}^{\infty} (2n)^{-\frac{1}{2}} 2^{\frac{1}{2}} \cos(t \ln(2n) + \frac{1}{4}\pi) - \sum_{n=1}^{\infty} (2n-1)^{-\frac{1}{2}} 2^{\frac{1}{2}} \cos(t \ln(2n-1) + \frac{1}{4}\pi)$$

$$(5) \quad \text{At } \sigma = \frac{2}{5}, \text{ sim-}\eta(s) = \sum_{n=1}^{\infty} (2n)^{-\frac{2}{5}} 2^{\frac{1}{2}} \cos(t \ln(2n) + \frac{1}{4}\pi) - \sum_{n=1}^{\infty} (2n-1)^{-\frac{2}{5}} 2^{\frac{1}{2}} \cos(t \ln(2n-1) + \frac{1}{4}\pi)$$

For any real number  $n$ ,  $e^{in} = \cos n + i \cdot \sin n$  is Euler's formula where  $e$  [ $\approx$ transcendental number 2.71828] is base of natural logarithm,  $i = \sqrt{-1}$  is imaginary unit. When  $n = \pi$  [ $\approx$ transcendental number 3.14159], then  $e^{i\pi} + 1 = 0$  or  $e^{i\pi} = -1$ , known as Euler's identity. Applying this formula to f(n)  $\eta(s)$  results in Eq. (4) f(n) simplified  $\eta(s)$  at  $\sigma = \frac{1}{2}$  that incorporate all nontrivial zeros [as Zeroes]. There is total absence of (non-existent) virtual nontrivial zeros [as virtual Zeroes]. Eq. (5) f(n) simplified  $\eta(s)$  at  $\sigma = \frac{2}{5}$  will incorporate all (non-existent) virtual nontrivial zeros [as virtual Zeroes]. There is total absence of nontrivial zeros [as Zeroes].

(6)

$$\text{At } \sigma = \frac{1}{2}, \text{ DSPL} = \frac{1}{2^{\frac{1}{2}}} \left( t^2 + \frac{1}{4} \right)^{\frac{1}{2}} \left[ (2n)^{\frac{1}{2}} \cos(t \ln(2n) - \frac{1}{4}\pi) - (2n-1)^{\frac{1}{2}} \cos(t \ln(2n-1) - \frac{1}{4}\pi) + C \right]_1^{\infty}$$

$F(n)$  Dirichlet Sigma-Power Law, denoted by DSPL, refers to  $\int \text{sim-}\eta(s) dn$ . Eq. (6) is F(n) DSPL at  $\sigma = \frac{1}{2}$  that will incorporate all nontrivial zeros [as Pseudo-zeroes to Zeroes conversion].

*Remark 2.2.* Given  $\delta = \frac{1}{10}$ , the left-shifted  $\sigma = \frac{1}{2} - \delta = \frac{2}{5}$ -non-critical line (Figure 5) and right-shifted  $\sigma = \frac{1}{2} + \delta = \frac{3}{5}$ -non-critical line (Figure 6) are **equidistant** from nil-shifted  $\sigma = \frac{1}{2}$ -critical line (Figure 4). Let  $x = (2n)$  or  $\frac{1}{(2n)}$  or  $(2n - 1)$  or  $\frac{1}{(2n - 1)}$ . With multiplicative inverse operation of  $x^\delta \cdot x^{-\delta} = 1$  or  $\frac{1}{x^\delta} \cdot \frac{1}{x^{-\delta}} = 1$  that is applicable, this imply intrinsic presence of **Multiplicative Inverse** in  $\text{sim-}\eta(s)$  or DSPL for all  $\sigma$  values with this function or law rigidly obeying relevant trigonometric identity. Then both  $f(n)$   $\text{sim-}\eta(s)$  and  $F(n)$  DSPL will manifest **Principle of Equidistant for Multiplicative Inverse** (as per Page 41 of [8]).

The dissertation based on Figure 8 with inverse functions  $\ln(x)$  &  $e(x)$  in Page 30 – 35 of [8] confirms Asymptotic law of distribution for prime numbers as  $\lim_{x \rightarrow \infty} \frac{\text{Prime-}\pi(x)}{\left[\frac{x}{\ln(x)}\right]} = 1$  and Asymptotic law of distribution for composite numbers as  $\lim_{x \rightarrow \infty} \frac{\text{Composite-}\pi(x)}{\left[\frac{x}{e(x)}\right]} = 1$ . This fully supports Prime number theorem [viz,  $\text{Prime-}\pi(x) \approx \frac{x}{\ln(x)}$ ] & derived Composite number theorem [viz,  $\text{Composite-}\pi(x) \approx \frac{x}{e(x)}$ ].

A number base, consisting of any whole number greater than 0, is number of digits or combination of digits that a number system uses to represent numbers e.g. decimal number system or base 10, binary number system or base 2, octal number system or base 8, hexa-decimal number system or base 16. Prime counting function,  $\text{Prime-}\pi(x)$  = number of primes  $\leq x$  and Composite counting function,  $\text{Composite-}\pi(x)$  = number of composites  $\leq x$ . As  $x \rightarrow \infty$ , derived properties of  $\text{Prime-}\pi(x)$  occur in, for instance, Prime number theorem for Arithmetic Progressions,  $\text{Prime-}\pi(x; b, a)$  [= number of primes  $\leq x$  with last digit of primes given by  $a$  in base  $b$ ]. For any choice of digit  $a$  in base  $b$  with  $\text{gcd}(a, b) = 1$ :  $\text{Prime-}\pi(x; b, a) \sim \frac{\text{Prime-}\pi(x)}{\phi(b)}$ . Here, Euler's totient function  $\phi(n)$  is defined as the number of positive integers  $\leq n$  that are relatively prime to (i.e., do not contain any factor in common with)  $n$ , where 1 is counted as being relatively prime to all numbers. Then each of the last digit of primes given by digit  $a$  in base  $b$  as  $x \rightarrow \infty$  is equally distributed between the permitted choices for digit  $a$  with this result being valid for, and is independent of, any chosen base  $b$ .

Numbers with their last digit ending in (i) 1, 3, 7 or 9 [which can be either primes or composites] constitute ~40% of all integers; and (ii) 0, 2, 4, 5, 6 or 8 [which must be composites] constitute ~60% of all integers. We validly ignore the only single-digit even prime number 2 and odd prime number 5. We note  $\geq 2$ -digit Odd Primes can only have their last digit ending in 1, 3, 7 or 9 but not in 0, 2, 4, 5, 6 or 8. These are given as the **complete List**:

The last digit of Odd Primes having their Prime gaps with last digit ending in 2 [viz, Gap 2, Gap 12, Gap 22, Gap 32...] can only be 1, 3 or 9 [but not (5) or 7] as three choices.

The last digit of Odd Primes having their Prime gaps with last digit ending in 4 [viz, Gap 4, Gap 14, Gap 24, Gap 34...] can only be 1, 3 or 7 [but not (5) or 9] as three choices.

The last digit of Odd Primes having their Prime gaps with last digit ending in 6 [viz, Gap 6, Gap 16, Gap 26, Gap 36...] can only be 3, 7 or 9 [but not (5) or 1] as three choices.

The last digit of Odd Primes having their Prime gaps with last digit ending in 8 [viz, Gap 8, Gap 18, Gap 28, Gap 38...] can only be 1, 7 or 9 [but not (5) or 3] as three choices.



The last digit of Odd Primes having their Prime gaps with last digit ending in 0 [viz, Gap 10, Gap 20, Gap 30, Gap 40...] can only be 1, 3, 7 or 9 [but not (5)] as four choices.

**AXIOM 1.** *Applications of the Prime number theorem for Arithmetic Progressions will confirm Modified Polignac's and Twin prime conjectures to be true (as per Page 31 – 32 in [8]).*

**Proof.** We use decimal number system (base  $b = 10$ ), and ignore the only single-digit even prime number 2 and odd prime number 5. For  $i = 1, 2, 3, 4, 5, \dots$ ; the last digit of all Gap  $2i$ -Odd Primes can only end in 1, 3, 7 or 9 that are each proportionally and equally distributed as  $\sim 25\%$  when  $x \rightarrow \infty$ , whereby this result is consistent with Prime number theorem for Arithmetic Progressions. The 100%-Set of, and its derived four unique 25%-Subsets of, Gap  $2i$ -Odd Primes based on their last digit being 1, 3, 7 or 9 must all be CIS-ALN-decelerating. "Different Prime numbers literally equates to different Prime gaps" is a well-known intrinsic property. Since the ALN of Gap  $2i$  as fully represented by all Prime gaps with last digit ending in 0, 2, 4, 6 or 8 are associated with various permitted combinations of last digit in Gap  $2i$ -Odd Primes being 1, 3, 7 and/or 9 as three or four choices [outlined above in **List** from preceding paragraph]; then these ALN unique subsets of Prime gaps based on their last digit being 0, 2, 4, 6 or 8 together with their correspondingly derived ALN unique subsets constituted by Gap  $2i$ -Odd Primes having last digit 1, 3, 7 or 9 must also all be CIS-ALN-decelerating. The Probability (any Gap  $2i$  abruptly terminating as  $x \rightarrow \infty$ ) = Probability (any Gap  $2i$ -Odd Primes abruptly terminating as  $x \rightarrow \infty$ ) = 0. Thus Modified Polignac's and Twin prime conjectures is confirmed to be true. With ordinary Riemann hypothesis being a special case, we also note the generalized Riemann hypothesis formulated for Dirichlet L-function holds once  $x > b^2$ , or base  $b < x^{\frac{1}{2}}$  as  $x \rightarrow \infty$ . The ["statistical" or "probabilistic"] proof is now complete for Axiom 1  $\square$ .

### 3. Generic Squeeze theorem as a novel mathematical tool in Number theory

We adopt abbreviations  $\mathbb{P}$  = Prime numbers,  $\mathbb{C}$  = Composite numbers, NTZ = nontrivial zeros,  $G[y=0]P$  = Gram[ $y=0$ ] points (usual / traditional Gram points), and  $G[x=0]P$  = Gram[ $x=0$ ] points.

Gram's Law and Rosser's Rule for Riemann zeta function via its proxy Dirichlet eta function at  $\sigma = \frac{1}{2}$  are perpetually associated with recurring violations (failures). Violations of Gram's Law equates to intermittently observing various geometric variants of two consecutive (positive first and then negative)  $G[y=0]P$  that is alternatingly followed by two consecutive NTZ. Violations of Rosser's Rule equates to intermittently observing various geometric variants of reduction in expected number of certain x-axis intercept points. Both types of violations may give rise to intermittent or cyclical events of two missing  $G[y=0]P$  or, equivalently, to two extra NTZ.

We hereby artificially and conveniently regard the  $G[y=0]P \leq G[x=0]P \leq \text{NTZ}$  inequality as being applicable for Theorem 3.1 below. Observe that this particular inequality has never been definitively confirmed to be true *over the large range of numbers*. With full analysis, one of the following alternative inequalities  $G[x=0]P \leq G[y=0]P \leq \text{NTZ}$  or  $\text{NTZ} \leq G[y=0]P \leq G[x=0]P$  or  $\text{NTZ} \leq G[x=0]P \leq G[y=0]P$  or  $G[x=0]P \leq \text{NTZ} \leq G[y=0]P$  or  $G[y=0]P \leq \text{NTZ} \leq G[x=0]P$  *over the large range of numbers* could instead be true.

Even the equality  $G[y=0]P = G[x=0]P = \text{NTZ}$  over the large range of numbers could instead also be true. It may even be the case that all types of inequalities mentioned above could cyclically co-exist over the large range of numbers. In principle, Theorem 3.1 should intuitively be validly applicable to the correctly chosen inequality [or equality].

**THEOREM 3.1.** (*Generic Squeeze theorem*). *Crucially applicable to all prime numbers, composite numbers and nontrivial zeros, our devised Theorem 3.1 is formally stated as follows (as per Page 51 – 53 in [8]).*

Let  $I$  be an interval containing point  $a$ . Let  $g$ ,  $f$ , and  $h$  be algorithms or functions defined on  $I$ , except possibly at  $a$  itself. Suppose for every  $x$  in  $I$  not equal to  $a$ , we have  $g(x) \leq f(x) \leq h(x)$  and also suppose  $\lim_{x \rightarrow a} g(x) = \lim_{x \rightarrow a} h(x) = L$ . Then  $\lim_{x \rightarrow a} f(x) = L$ . The algorithms or functions  $g$  and  $h$  are said to be lower and upper bounds (respectively) of  $f$ . Here,  $a$  is not required to lie in the interior of  $I$ . Indeed, if  $a$  is an endpoint of  $I$ , then the above limits are left- or right-hand limits. A similar statement holds for infinite intervals e.g. applicable to the IM  $t$ -valued NTZ (as CIS-IM-linear) obtained from Riemann zeta function via its proxy Dirichlet eta function, and the ALN of  $\mathbb{P}$  (as CIS-ALN-decelerating) obtained from Sieve-of-Eratosthenes and IM  $\mathbb{C}$  (as CIS-IM-accelerating) obtained from Complement-Sieve-of-Eratosthenes. In particular, if  $I = (0, \infty)$  or  $(0, \text{ALN})$ , then the conclusion holds, taking the limits as  $x \rightarrow \infty$  or ALN.

Let  $a_n, c_n$  be two sequences converging to  $\ell$ , and  $b_n$  a sequence. If  $\forall n \geq N, N \in \mathbb{N}$  we have  $a_n \leq b_n \leq c_n$ , then  $b_n$  also converges to  $\ell$ . From above arguments, we logically notice Generic Squeeze theorem is valid for carefully selected sequences e.g. those precisely derived from algorithm Sieve-of-Eratosthenes generating set of all unique  $\mathbb{P}$  2, 3, 5, 7, 11, 13, 17, 19, 23, 29... with progressive "cumulative" cardinality  $\equiv c_n$  and sub-algorithms from Complement-Sieve-of-Eratosthenes generating two subsets of all unique pre-prime-Gap 2-Even  $\mathbb{C}$  4, 6, 10, 12, 16, 18, 22, 28... with progressive "cumulative" cardinality  $\equiv b_n$  and of all unique 1<sup>st</sup> post-prime-Gap 1-Even  $\mathbb{C}$  8, 14, 20, 24, 32, 38, 44... with progressive "cumulative" cardinality  $\equiv a_n$ . We recognize even  $\mathbb{P}$  2 is not a pre-prime-Gap 2-Even  $\mathbb{C}$ , and 1<sup>st</sup>  $\mathbb{P}$  3, 5, 11, 17, 29, 41, 59... from all twin prime pairings (3, 5), (5, 7), (11, 13), (17, 19), (29, 31), (41, 43), (59, 61)... are never associated with 1<sup>st</sup> post-prime-Gap 1-Even  $\mathbb{C}$  as these even numbers 4, 6, 12, 18, 30, 42, 60... [which must be **\*eternally ubiquitous\***, not least, to comply with Law of Continuity] are all pre-prime-Gap 2-Even  $\mathbb{C}$ . Incorporating mixtures of  $\mathbb{P}$  &  $\mathbb{C}$ , our findings on twin prime pairings  $\implies \{c_n \text{ representing progressive total of all } \mathbb{P}\} > \{b_n \text{ representing progressive total of all pre-prime-Gap 2-Even } \mathbb{C}\} > \{a_n \text{ representing progressive total of all 1}^{st} \text{ post-prime-Gap 1-Even } \mathbb{C}\}$ . Since  $\lim_{n \rightarrow \text{ALN}} a_n = \lim_{n \rightarrow \text{ALN}} c_n = \text{CIS-ALN-decelerating}$ , then  $\lim_{n \rightarrow \text{ALN}} b_n = \text{CIS-ALN-decelerating}$ . Stated in another insightful way: The perpetual recurrence of intermittent inevitable DISAPPEARANCE of 1<sup>st</sup> post-prime-Gap 1-Even  $\mathbb{C}$  is solely due to coinciding intermittent inevitable APPEARANCE of twin primes  $\implies$  Twin prime conjecture is true.

\*The 1<sup>st</sup> post-prime-Gap 1-Even  $\mathbb{C}$  precisely forms OEIS sequence A014574 *Average of twin prime pairs* 4, 6, 12, 18, 30, 42, 60, 72, 102, 108, 138, 150, 180, 192, 198, 228, 240, 270, 282, 312, 348, 420, 432, 462, 522, 570, 600, 618... by R. K. Guy, N. J. A. Sloane & E. W. Weisstein (June 11, 2011) <https://oeis.org/A014574> whereby

(i) With an initial 1 added, these numbers form part of the complement of closure of  $\{2\}$  under the operations  $a * b + 1$  and  $a * b - 1$  within the set of all non-zero positive even numbers  $U = \{2, 4, 6, 8, 10, \dots\}$ . For  $a * b + 1$ :  $2 * 2 + 1 = 5$ . For  $a * b - 1$ :  $2 * 2 - 1 = 3$ . Under both operations, we obtain the set  $S = \{2, 3, 5\}$ . Therefore the complement of  $S$  within  $U$  would be all even numbers except 2 [and 5 & 3]; viz,  $S' = \{4, 6, 8, 10, 12, 14, 16, \dots\}$ .

(ii) These numbers are also the square root of the product of twin prime pairs + 1. Two consecutive odd numbers can be written as  $2k + 1, 2k + 3$ . Then  $(2k + 1)(2k + 3) + 1 = 4(k^2 + 2k + 1) = 4(k + 1)^2$ , a perfect square [where the countably infinite set of all perfect squares  $\equiv$  product of an integer multiplied by itself = 1, 4, 9, 16, 25, 36, 49, 64, 81, 100...]. Since twin prime pairs are two consecutive odd numbers, the statement is true for all CIS-ALN-decelerating twin prime pairs.

(iii) These numbers are single (or isolated) composites. Nonprimes  $k$  such that neither  $k - 1$  nor  $k + 1$  is nonprime.

(iv) These form the numbers  $n$  such that  $\sigma(n - 1) = \phi(n + 1)$ . This equation involves two arithmetic functions: the sum of divisors function  $\sigma$  [which calculates the sum of all positive divisors of  $n$  e.g. when  $n = 30$ : Prime factorization of  $(n - 1) = 29$  is  $29 = 29^1$ , and  $\sigma(29) = 1 + 29 = 30$ ] and Euler's totient function  $\phi$  [which gives the count of positive integers less than  $n$  that are coprime to  $n$  e.g. Prime factorization of  $(n + 1) = 31$  is  $31 = 31^1$ , and  $\phi(31) = 31 - 1 = 30$ ].

(v) Aside from first term 4 in the sequence, all remaining terms 6, 12, 18, 30, 42, 60, 72, 102, 108, 138, 150... have digital root 3, 6, or 9 e.g. digital root of 138 is 3 since  $138 = 1 + 3 + 8 = 12$  and  $1 + 2 = 3$ .

(vi) These form the numbers  $n$  such that  $n^2 - 1$  is a semiprime [a natural number that is the product of two prime numbers].

(vii) Every term but the first term 4 is a multiple of 6 [and all the multiple of 6 clearly constitute a countably infinite set].

From above synopsis that is valid for [mixed] prime & composite numbers as  $x \rightarrow$ ALN, we conclude: Since there is an ALN of all prime numbers as  $(c_n)$  and also an ALN of all 1<sup>st</sup> post-prime-Gap 1-Even composite numbers as  $(a_n)$ , then by the Generic Squeeze theorem, there must also be an ALN of all Gap 2-Even composite numbers as  $(b_n)$ . Thus  $\ell$  must have the value of ALN. In theory, even if there are [incorrectly] only finitely many twin primes, the mathematical relationship of  $a_n \leq b_n \leq c_n$  will still hold except that the Generic Squeeze theorem is no longer applicable as there will be inevitable "errors" present in the computed  $a_n, b_n$  and  $c_n$ .

By applying Generic Squeeze theorem [only] to Odd  $\mathbb{P}$ , we now prove Polignac's and Twin prime conjectures are true: We ignore even  $\mathbb{P}$  2. Let algorithm Sieve-of-Eratosthenes that generate the set of all unique Total Odd  $\mathbb{P}$  3, 5, 7, 11, 13, 17, 19, 23, 29... with progressive "cumulative" cardinality  $\equiv c_n$  and sub-algorithms from Sieve-of-Eratosthenes that generate the two [randomly selected] subsets of all unique Gap 4-Odd  $\mathbb{P}$  7, 13, 19, 37, 43, 67... with progressive "cumulative" cardinality  $\equiv a_n$  and of all unique Gap 2, 6, 8, 10, 12...-Odd  $\mathbb{P}$  3, 5, 11, 17, 23, 23, 29, 31, 41, 47, 53, 59, 61... [viz, not including Gap 4-Odd  $\mathbb{P}$ ] with progressive "cumulative" cardinality  $\equiv b_n$ . Instead of choosing  $b_n$  to be even Prime gap

4, one could choose any other eligible even Prime gap derived from the set of all even Prime gaps [which will inevitably also include Zhang's landmark result of an unknown even Prime gap  $N < 70$  million]. Since  $\lim_{n \rightarrow ALN} a_n = \lim_{n \rightarrow ALN} c_n = \text{CIS-ALN-decelerating}$ , then  $\lim_{n \rightarrow ALN} b_n = \text{CIS-ALN-decelerating}$ . Stated in another insightful way: In order for novel method Generic Squeeze theorem to be ubiquitously applicable for Odd  $\mathbb{P}$ , all even Prime gaps 2, 4, 6, 8, 10... must be associated with corresponding ALN of Odd  $\mathbb{P}$ .

On 17 April 2013, Yitang Zhang announced an incredible proof that there is an arbitrarily large number of Odd Primes with an unknown even Prime gap  $N$  of less than 70 million[9]; viz,  $\liminf_{n \rightarrow \infty} (p_{n+1} - p_n) < N$  with  $N = 7 \times 10^7$ . By optimizing Zhang's bound, subsequent Polymath Project collaborative efforts using a new refinement of GPY sieve in 2014 lowered  $N$  to 246; and assuming Elliott-Halberstam conjecture and its generalized form, lower  $N$  down as follow: there are infinitely many  $n$  such that at least two of  $n$ ,  $n + 2$ ,  $n + 6$ ,  $n + 8$ ,  $n + 12$ ,  $n + 18$ , or  $n + 20$  are prime. Under a stronger hypothesis,  $N$  is further lowered down to 6: there are infinitely many  $n$ , at least two of  $n$ ,  $n + 2$ ,  $n + 4$ , and  $n + 6$  are prime. Intuitively,  $N$  has more than one valid values such that the same condition holds for each  $N$  value. Using different methods, we can at most lower  $N$  to 2 and 4 in regards to Odd Primes having small even Prime gaps 2 and 4 with each uniquely generating CIS-ALN-decelerating Odd Primes. We anticipate there are all remaining even Prime gaps w.r.t. Odd Primes with large even Prime gaps  $\geq 6$  as denoted by corresponding  $N \geq 6$  values whereby each large even Prime gap generates its unique CIS-ALN-decelerating Odd Primes [Remark 3.1].

*Remark 3.1.* We justify "Zhang's optimized result  $\geq 3$  up to ALN even Prime gaps with each having ALN of elements": With just one or two existing even Prime gaps that have ALN of elements being simply "insufficient" in the large range of prime numbers, then the landmark result by Zhang on an unknown even Prime gap  $N < 70$  million is usefully extrapolated as "There must be at least one subset of Odd Primes having ALN of elements". Another insightful deduction: For  $n = 1, 2, 3, 4, 5, \dots$ ; it is a mathematical impossibility for this ["only existing"] unknown even Prime gap  $N$  to be constituted by an even Prime gap of  $6n$  format that manifest itself as consecutive Odd Primes of infinite length in the large range of prime numbers. Aesthetically, there is at least two, if not three, existing even Prime gaps generating corresponding CIS-ALN-decelerating Odd Primes. Modified Polignac's and Twin prime conjectures equates to all even Prime gaps 2, 4, 6, 8, 10... generating corresponding CIS-ALN-decelerating Odd Primes.

Near-identical arguments can be made for three types of Gram points located at  $\sigma = \frac{1}{2}$ -critical line of Riemann zeta function but we leave out the full exercise of applying Generic Squeeze theorem to NTZ as progressive "cumulative" cardinality  $\equiv c_n$ ,  $G[x=0]P$  as progressive "cumulative" cardinality  $\equiv b_n$  and  $G[y=0]P$  as progressive "cumulative" cardinality  $\equiv a_n$ . We immediately recognize the [trivial] conclusion: Since  $\lim_{n \rightarrow \infty} a_n = \lim_{n \rightarrow \infty} c_n = \text{CIS-IM-linear}$ , then  $\lim_{n \rightarrow \infty} b_n = \text{CIS-IM-linear}$ .

Eq. (4) manifests *exact* Dimensional analysis homogeneity when  $\sigma = \frac{1}{2}$  whereby  $\Sigma(\text{all fractional exponents}) = 2(-\sigma) = \text{exact negative whole number } -1$  [c.f. Eq. (5) manifests *inexact* Dimensional analysis homogeneity when  $\sigma = \frac{2}{3}$  whereby  $\Sigma(\text{all fractional exponents}) = 2(-\sigma) = \text{inexact negative fractional number } -\frac{4}{3}$ ]. Only Dirichlet eta function having parameter  $\sigma = \frac{1}{2}$  will mathematically depict [optimal]

"formula symmetry" on  $\Sigma$ (all fractional exponents) as an exact negative whole number, whereby absolute values of all fractional exponents =  $\frac{1}{2}$  when associated with constant 2 and variable  $(2n)$  or  $(2n-1)$ . This formula symmetry is not equivalent to geometrical symmetry about X-axis, Y-axis, Diagonal, or Origin point that do not exist for any Dirichlet eta function when considered for either  $-\infty < t < 0$  or  $0 < t < +\infty$  from full range  $-\infty < t < +\infty$ ; whereby we conventionally adopt the positive range. Simple observation of [optimal] "formula symmetry" implies only  $\sigma = \frac{1}{2}$ -Dirichlet eta function will perpetually & geometrically intercept  $\sigma = \frac{1}{2}$ -Origin point as Origin intercept points or Gram[x=0,y=0] points (i.e. will perpetually & mathematically lie on  $\sigma = \frac{1}{2}$ -critical line as nontrivial zeros) an infinite number of times.

Conforming to Langlands program "**Theory of Symmetry**", IL (sub-)algorithms or IL (sub-)equations and FL (sub-)algorithms or FL (sub-)equations will respectively generate infinitely-many and finitely-many entities. All the FL (sub-)algorithms or FL (sub-)equations are CP but the IL (sub-)algorithms or IL (sub-)equations can be either CP or IP. Here, we validly regard equation Dirichlet eta function (*proxy* for Riemann zeta function that generate nontrivial zeros when  $\sigma = \frac{1}{2}$ ), and algorithms Sieve-of-Eratosthenes [for prime numbers] and Complement-Sieve-of-Eratosthenes [for composite numbers] as **non-overlapping** "IP IL number generators".

*Remark 3.2.* Not least to maintain Dimensional analysis homogeneity and to conserve Total number of elements (cardinality), it is a crucial ***sine qua non*** *Pre-requisite Mathematical Condition that a parent IP IL algorithm which is precisely constituted by its IP IL sub-algorithms or a parent IP IL equation which is precisely constituted by its IP IL sub-equations must generally all be wholly IP IL [and not be mixed IP IL and CP FL]*. Useful self-explanatory analogy using CP IL (sub)algorithms or (sub)equations: Set "twin" even numbers 0, 2, 4, 6, 8, 10... with Even gap 2, Subset "cousin" even numbers 0, 4, 8, 12, 16, 20... with Even gap 4, Subset "sexy" even numbers 0, 6, 12, 18, 24, 30... with Even gap 6, etc must all be constituted by CP IL [and not mixed CP IL and IP IL] even numbers that are derived from, paradoxically, **overlapping** "CP IL number generators".

*Remark 3.3.* It was correctly asserted on Page 3 – 4 of [8] that any created Prime-tuplet or Prime-tuple is not able to be used to either prove or disprove Modified Polignac's and Twin prime conjectures. The main reason is Prime-tuplets or Prime-tuples are "**overlapping and incomplete**" (Sub)Tuples Classification of **consecutive primes**. In contrast, we can use "**non-overlapping and complete**" (Sub)Sets Classification of **grouped primes** to prove these conjectures. Thus even Prime gap 2 = Prime 2-tuplets of diameter 2 and even Prime gaps 4, 6, 8, 10, 12... = Prime 2-tuples of diameter 4, 6, 8, 10, 12....

#### 4. Applying Theorem of Divergent-to-Convergent series conversion for Prime numbers in Polignac's and Twin prime conjectures

Recall from section 2 the Sieve-of-Eratosthenes (S-of-E) and Modified-S-of-E. Both algorithms and their derived sub-algorithms faithfully generate set of all prime numbers 2, 3, 5, 7, 11, 13...; set of all Odd Primes 3, 5, 7, 11, 13, 17...; and subsets of Odd Primes derived from even Prime gaps 2, 4, 6, 8, 10....

By performing summation given by  $\sum_{n=i}^{ALN} p_{n+1} = 2 + \sum_{i=1}^n g_i$  and  $\sum_{n=i}^{ALN} p_{n+1} = 3 + \sum_{i=2}^n g_i$ , we will obtain (de novo) infinite series as diverging series for these two algorithms [and their derived sub-algorithms]. For Polignac's and Twin prime conjectures to be true, we deduce the cardinality for (i) set of all prime numbers, (ii) set of all Odd Primes, (iii) subsets of Odd Primes, and (iv) set of all even Prime gaps must all be CIS-ALN-decelerating. In contrast, we deduce below after Theorem 4.1 that all Brun's constants as (derived) infinite series are, in fact, converging series.

**Helpful preliminary information about Theorem 4.1:** Four basic arithmetic operations of addition [and complementary subtraction] and multiplication [and complementary division] obey Axioms of Addition and Multiplication, and Axioms of Order. Division of one number by another is equivalent to multiplying first number by reciprocal (or multiplicative inverse) of second number, whereby division by 0 is always undefined. Subtraction of one number from another is equivalent to adding additive inverse of second number (viz, a negative number) to first number (viz, a positive number). Completely Predictable properties arising from (non-)alternating addition of any Even numbers ( $\mathbb{E}$ ) 0, 2, 4, 6, 8, 10, 12... and any Odd numbers ( $\mathbb{O}$ ) 1, 3, 5, 7, 9, 11, 13...: (I)  $\mathbb{E} + \mathbb{E} + \mathbb{E} + \mathbb{E} \dots$  when involving any number of terms =  $\mathbb{E}$ . (II)  $\mathbb{O} + \mathbb{O} + \mathbb{O} + \mathbb{O} \dots$  when involving an even number of terms =  $\mathbb{E}$ ; and when involving an odd number of terms =  $\mathbb{O}$ . The alternating sum  $\mathbb{E} + \mathbb{O} + \mathbb{E} + \mathbb{O} + \mathbb{E} + \mathbb{O} \dots$  when involving  $(1 + n)$  terms for  $n = 1, 2, 3, 4, 5 \dots$  = repeating patterns of  $\mathbb{O}, \mathbb{O}, \mathbb{E}, \mathbb{E}, \mathbb{O}, \mathbb{O}, \dots$

A convergent series (CS) as an infinite series having its partial sums of sequence that tends to a finite limit is validly represented by the [defined] value of this finite limit. A divergent series (DS) as an infinite series having its partial sums of sequence that tends to a infinite limit is validly represented by the [undefined] value of this infinite limit. As previously discussed in section 2, the infinite-length sequence of a given CS or DS can theoretically be constituted by either positive terms OR alternating positive and negative terms. The following are Completely Predictable properties arising from addition of any infinite series constituted by  $\geq 1$  CS and/or  $\geq 1$  DS:

- I. DS+DS+DS+... when involving any number of DS terms = DS.
- II. CS+CS+...+DS+DS+... when involving any number of CS terms & any number of DS terms = DS.
- III. CS+CS+CS+... when involving a finite number of CS terms = CS.
- IV. CS+CS+CS+... when involving an infinite number of CS terms or arbitrarily large number (ALN) of CS terms = DS.

**THEOREM 4.1.** (*Theorem of Divergent-to-Convergent series conversion for Prime numbers*) (as per Page 53 – 54 in [8]).

We validly ignore even prime number 2. Theorem 4.1, aka **Smoothed asymptotics for Prime numbers with an enhanced regulator**, as given in next two paragraphs is further expanded below using three Brun's constants computed for twin primes, cousin primes and sexy primes.



For [eligible] homogenous entities of prime numbers with application of divergent series (DS) to convergent series (CS) conversion relationship, we obtain CS + CS + CS + ... when involving arbitrarily large number (ALN) of CS terms [that faithfully "represent" all Subsets of Odd Primes] = DS [that faithfully "represent" the Set of all Odd Primes]. We recognize the ALN of computed CS terms will precisely correspond to Brun's constants. The correctly chosen **enhanced regulator for prime numbers**  $\equiv$  *sine qua non* condition [that must be fully complied with by all Odd Primes]: *Derived from the set of all Odd Primes, there must be an ALN of subsets of Odd Primes derived from even Prime gaps 2, 4, 6, 8, 10... with each subset of Odd Primes containing an ALN of unique elements.*

The elimination of a DS to CS under our novel *Divergent-to-Convergent series theorem for Prime numbers* fully supports Polignac's and Twin prime conjectures to be true. As already alluded to in section 1, this procedure is reminiscent of invoking 'Method of Smooth asymptotics' and 'regularization of divergent series or integrals' to enable elimination of divergences in analytic number theory and preservation of gauge invariance at one loop in a wide class of non-abelian gauge theories coupled to Dirac fermions that preserves Ward identity for vacuum polarisation tensor [viz, a regularized quantum field theory]. This is achieved by Padilla and Smith via adopting suitable choices from their proposed families of enhanced regulators[4] with analytic continuation that converge to Riemann zeta function value  $\zeta(-1) = -\frac{1}{12}$  of common / extra relevance to quantum gravity, string theory, etc.

Considering Euler products  $\sum_{n=1}^{\infty} \frac{1}{n} = \prod_p \frac{1}{1-p^{-1}}$  when taken over the set of all infinitely many primes, Leonhard Euler in 1737 showed the [harmonic] **infinite series** of all infinitely many primes (as sum of the reciprocals of all infinitely many primes) **diverges** very slowly; viz,  $\sum_{p \text{ prime}} \frac{1}{p} = \frac{1}{2} + \frac{1}{3} + \frac{1}{5} + \frac{1}{7} + \frac{1}{11} + \frac{1}{13} + \frac{1}{17} + \frac{1}{19} + \dots = \infty$ . If it were the case that this sum of the reciprocals of twin primes (Prime gap 2), cousin primes (Prime gap 4), sexy primes (Prime gap 6), etc all diverged; then that fact would imply that there are infinitely many of twin primes, cousin primes, sexy primes, etc. However twin primes are less frequent than all infinitely many prime numbers by nearly a logarithmic factor with this bound giving intuition that sum of reciprocals of twin primes **converges** very slowly, or stated in other words, twin primes form a small set. The sum  $\sum_{p: p+2 \in \mathbb{P}} \left( \frac{1}{p} + \frac{1}{p+2} \right) = \left( \frac{1}{3} + \frac{1}{5} \right) + \left( \frac{1}{5} + \frac{1}{7} \right) + \left( \frac{1}{11} + \frac{1}{13} \right) + \left( \frac{1}{17} + \frac{1}{19} \right) + \dots = 1.902160583104\dots$  in explicit terms either has finitely many terms or has infinitely many terms but is very slowly convergent with its value known as Brun's constant for (consecutive) twin primes. Similar deductive arguments can be developed for the sum of the reciprocals of cousin primes, sexy primes, etc that also **converges** very slowly with their associated Brun's constant for (consecutive) cousin primes [ $\approx 1.19705479$ ], (consecutive) sexy primes [ $\approx 1.13583508$ ], etc. All these heuristically computed Brun's constants are irrational (transcendental) numbers ONLY IF there are infinitely many twin primes, cousin primes, sexy primes, etc. Based on Zhang's result[9], there must be at least one computed Brun's constant that is irrational (transcendental) associated with infinitely many Odd Primes having an even Prime gap < 70 million. We ignore solitary even prime number 2. We use "Arbitrarily Large Number" to denote "infinitely many". As an absolutely indispensable condition, there are ALN of subsets of Odd Primes with

each subset of Odd Primes containing ALN of elements – this is akin to choosing the correct "enhanced regulator". From above discussions, we heuristically deduce very slowly **diverging** sum (series) of the reciprocals of all ALN Odd Primes are fully constituted by very slowly **converging** sum (series) of the reciprocals of ALN Odd Primes derived from each and every subsets of Odd Primes.

Erdos primitive set conjecture, now proven as a theorem by Prof. Jared Lichtman[2], is the assertion that for any primitive set  $S$  with exactly  $k$  prime factors (with repetition),  $\sum_{n \in S} \frac{1}{n \log n} \leq \sum_p \frac{1}{p \log p} = \frac{1}{2 \log 2} + \frac{1}{3 \log 3} + \frac{1}{5 \log 5} + \frac{1}{7 \log 7} + \frac{1}{11 \log 11} + \dots = 1.6366\dots$  [as a very slowly converging sum when  $k = 1$  over infinitely-many integers 1, 2, 3, 4, 5...]  $\implies f_k$  is maximized by the prime sum  $f_1 = \sum_p \frac{1}{p \log p} = 1.6366\dots$  [representing the unique "largest" primitive set that ONLY contains all infinitely-many prime numbers 2, 3, 5, 7, 11, 13...]. As supporting Modified Polignac's and Twin prime conjectures to be true [with **all Odd Primes belonging to CIS-ALN-decelerating**]; one can calculate the equivalent  $f_1 = \sum_p \frac{1}{p \log p}$  [also as very slowly converging sums with values  $< 1.6366\dots$ ] for individual subsets of Odd Primes obtained from even Prime gaps 2, 4, 6, 8, 10... and notice these [derived] "**infinite series**" calculations must all, in principle and in synchrony, incorporate corresponding **CIS-ALN-decelerating Odd Primes from each subset**. This last statement is heavily supported by Yitang Zhang's result[9] which can be extrapolated as "There must be at least one subset of Odd Primes [obtained from an even Prime gap  $< 70$  million] having infinitely many elements".

### 5. Subtypes of Countably Infinite Sets with Incompletely Predictable entities from Sieve of Eratosthenes and Riemann zeta function / Dirichlet eta function

The sets of even numbers, odd numbers, numbers generated using power (exponent) of 2 or  $\frac{1}{2}$  such as  $x^2$  or  $x^{\frac{1}{2}}$  [for  $x = 0, 1, 2, 3, 4, 5\dots$ ], etc are morphologically constituted by *Completely Predictable (CP) numbers* in the sense that these sets of numbers are actually **not** random and do not behave like one. The sets of nontrivial zeros, prime numbers, composite numbers, etc are morphologically constituted by *Incompletely Predictable (IP) numbers* [or *pseudo-random numbers*] in the sense that these sets of numbers are actually **not** random but behave like one; thus giving rise to so-called "Mathematics for Incompletely Predictable Problems". The word *number* [singular noun] or *numbers* [plural noun] in reference to CP even and odd numbers, IP prime and composite numbers, IP Gram points and virtual Gram points can be interchanged with the word *entity* [singular noun] or *entities* [plural noun]. Caveat: Individual irrational numbers such as  $2^{\frac{1}{2}} = \sqrt{2} = 1.41421\dots$ , an (algebraic) irrational number, has infinitely-many IP decimal digits.

LEMMA 5.1. *We can formally define the elements from (sub)sets and (sub)tuples as Completely Predictable or Incompletely Predictable entities (as per Page 18 in [8]). Please also see Remark 3.2 & Remark 3.3 above in section 3 indicating the important significances arising from Lemma 5.1.*

**Proof.** A set is a collection of zero (viz, the empty set) or more elements (viz, a finite set with a finite number of elements or an infinite set with an infinite number of elements). A singleton refers to a finite



set with a single element. A set can be any kind of mathematical objects: numbers, symbols, points in space, lines, other geometrical shapes, variables, or even other sets whereby these [mutable] non-repeating elements are not arranged in an unique order. A subset can be a [smaller] finite set derived from its [larger] parent finite set or its [larger] parent infinite set. A subset can also be a [smaller] infinite set derived from its [larger] parent infinite set. A tuple, which can potentially be further subdivided into subtuples, is a finite ordered list (sequence) of elements whereby these [immutable] non-repeating elements are arranged in an unique order. Thus a tuple or a subtuple is regarded as a special type of finite set with the extra imposed restriction. As shown below using worked examples:

CP simple equation or algorithm generates CP numbers e.g. even numbers 0, 2, 4, 6, 8, 10... or odd numbers 1, 3, 5, 7, 9, 11.... Thus a generated CP number is **locationally defined** as a number whose  $i^{th}$  position is *independently* determined by simple calculations without needing to know related positions of all preceding numbers – this is a **Universal Property**.

IP complex equation or algorithm generates IP numbers e.g. prime numbers 2, 3, 5, 7, 11, 13, 17, 19, 23, 29, 31... or composite numbers 4, 6, 8, 9, 10, 12, 14, 15, 16, 18.... Thus a generated IP number is **locationally defined** as a number whose  $i^{th}$  position is *dependently* determined by complex calculations with needing to know related positions of all preceding numbers – this is a **Universal Property**.

We clearly note the elements in (sub)sets and (sub)tuples when generated by equations or algorithms will precisely constitute relevant entities or numbers of interest. *The proof is now complete for Lemma 5.1*□.

A formula for primes in Number theory is a formula generating all prime numbers 2, 3, 5, 7, 11, 13, 17, 19, 23... exactly and without exception. Computationally slow and inefficient formulas for calculating

primes exist e.g. 1964 Willans formula 
$$p_n = 1 + \sum_{i=1}^{2^n} \left[ \left( \frac{n}{\sum_{j=1}^i \left[ \left( \cos \frac{(j-1)! + 1}{j} \pi \right)^2 \right] \right)^{1/n} \right]$$
 which is

based on Wilson’s theorem  $n + 1$  is prime *iff*  $n! \equiv n \pmod{n + 1}$ . Then critics may ask the question "For  $n = 1, 2, 3, 4, 5, \dots$ ; does Willans formula that faithfully compute corresponding  $n^{th}$  prime number  $p_n$  for all infinitely-many primes contradict Sieve-of-Eratosthenes algorithm as being an Infinite Length (IL) and Incompletely Predictable (IP) algorithm?" The answer is categorically 'no' based on carefully analyzing this formula using following arguments [which lend further support to Polignac’s and Twin prime conjectures being true]: Willans formula has two sub-components  $\left[ \left( \cos \frac{(j-1)! + 1}{j} \pi \right)^2 \right] = \begin{cases} 1 & \text{if } j \text{ is prime or } 1 \\ 0 & \text{if } j \text{ is composite} \end{cases}$

&  $\sum_{j=1}^i \left[ \left( \cos \frac{(j-1)! + 1}{j} \pi \right)^2 \right] = (\# \text{ primes } \leq i) + 1$ . We recognize this second sub-component stipulating  $(\# \text{ primes } \leq i) + 1$  meant the actual position of every  $n^{th}$  prime number will have to be fully and indirectly computed each time, thus confirming the infinitely-many prime numbers are IP and of IL. Note all [complementary] composite numbers 4, 6, 8, 9, 10, 12, 14, 15, 16, 18... are simply obtained by discarding all prime numbers from integers 2, 3, 4, 5, 6, 7, 8, 9, 10... whereby "special" integers 0 & 1 are neither prime nor composite. We ignore even prime number 2. Zhang’s landmark result[9] states there are infinitely

many Odd Primes having an even Prime gap  $< 70$  million. One could extrapolate Zhang's result to: There must be at least two or three up to all even Prime gaps being each associated with infinitely many Odd Primes. All obtained consecutive Odd Primes  $p_n$  and  $p_{n+1}$  can have their calculated  $p_{n+1} - p_n$  values grouped together as belonging to even Prime gaps 2, 4, 6, 8, 10... whereby when the Zhang's result is maximally extrapolated, Polignac's and Twin prime conjectures are supported to be true.

LEMMA 5.2. *We can validly classify countably infinite sets as accelerating, linear or decelerating subtypes (as per Page 18 – 19 in [8]).* **Proof.** *We provide the following required mathematical arguments.*

**Cardinality:** Of increasing size, arbitrary Set [or Subset]  $\mathbf{X}$  can be countably finite set (**CFS**), countably infinite set (**CIS**) or uncountably infinite set (**UIS**). Denoted as  $\|\mathbf{X}\|$  in this paper, cardinality of Set  $\mathbf{X}$  measures *number of elements* in Set  $\mathbf{X}$ . E.g., Set **negative Gram[y=0] point** as constituted by a [solitary] rational ( $\mathbb{Q}$ ) t-value of 0 instead of a usual transcendental ( $\mathbb{R} - \mathbb{A}$ ) t-value has CFS of negative Gram[y=0] point with this particular  $\|\mathbf{negative\ Gram[y=0]\ point}\| = 1$ , Set even Prime number ( $\mathbb{P}$ ) has CFS of solitary even  $\mathbb{P} 2$  with  $\|\mathbf{even\ P}\| = 1$ , Set Natural numbers ( $\mathbb{N}$ ) has CIS of  $\mathbb{N}$  with  $\|\mathbb{N}\| = \aleph_0$ , and Set Real numbers ( $\mathbb{R}$ ) has UIS of  $\mathbb{R}$  with  $\|\mathbb{R}\| = \mathfrak{c}$  (cardinality of the continuum). With  $\|\mathbf{CIS}\| = \aleph_0 = [\text{countably}]$  infinitely many elements; we provide a novel classification for CIS based on its number of elements (cardinality) manifesting linear, accelerating or decelerating property constituting three subtypes of CIS.

**CIS-IM-accelerating:** CIS with cardinality =  $\|\mathbf{CIS-IM-accelerating}\| = \aleph_0$ -accelerating = [countably] infinitely many elements that (overall) acceleratingly reach an *infinity value*. Examples: CP integers 0, 1, 4, 9, 16, 25, 36... generated by simple equation  $y = x^2$  for  $x = 0, 1, 2, 3, 4, 5, 6...$  and CP values obtained from natural exponential function  $y = e(x)$ ; and IP composite numbers 4, 6, 8, 9, 10, 12, 14, 15... faithfully generated by complex Complement-Sieve-of-Eratosthenes algorithm [which is equivalent to simply discarding integers 0, 1 and all generated prime numbers 2, 3, 5, 7, 11, 13... (via Sieve-of-Eratosthenes algorithm) from the entire set of +ve integers 0, 1, 2, 3, 4, 5, 6, 7, 8, 9, 10, 11, 12, 13, 14, 15...].

**CIS-IM-linear:** CIS with cardinality =  $\|\mathbf{CIS-IM-linear}\| = \aleph_0$ -linear = [countably] infinitely many elements that (overall) linearly reach an *infinity value*. Examples: CP entities 0, 1, 2, 3, 4, 5... [representing all +ve integer numbers] generated by simple equation  $y = x$  for  $x = 0, 1, 2, 3, 4...$ ; CP entities 0, 2, 4, 6, 8, 10... [representing all +ve even numbers] generated by simple equation  $y = 2x$  for  $x = 0, 1, 2, 3, 4...$ ; CP entities 1, 3, 5, 7, 9, 11... [representing all +ve odd numbers] generated by simple equation  $y = 2x - 1$  for  $x = 1, 2, 3, 4, 5...$ ; and IP nontrivial zeros, Gram[y=0] points and Gram[x=0] points (all given as  $\mathbb{R} - \mathbb{A}$  t-values) generated by complex equation Riemann zeta function via *proxy* Dirichlet eta function. These IP entities will inevitably manifest IP perpetual repeating violations (failures) in Gram's Law and Rosser's Rule occurring infinitely many times. E.g., the former give rise to Set **negative Gram[y=0] points** whereby CIS negative Gram[y=0] points is constituted by  $\mathbb{R} - \mathbb{A}$  t-values classified as having  $\|\mathbf{negative\ Gram[y=0]\ points}\| = \|\mathbf{CIS-IM-linear}\| = \aleph_0$ -linear.

**CIS-ALN-decelerating:** CIS with cardinality =  $\|\mathbf{CIS-ALN-decelerating}\| = \aleph_0$ -decelerating = [countably] arbitrarily large number of elements that (overall) deceleratingly reach an *Arbitrarily Large Number* value. Examples: CP entities 0, 1,  $\sqrt{2}$ ,  $\sqrt{3}$ , 2,  $\sqrt{5}$ ... generated by simple equation  $y = \sqrt{x}$  for  $x = 0, 1, 2,$

3, 4, 5... and CP values obtained from natural logarithm function  $y = \ln(x)$ ; and IP prime numbers 2, 3, 5, 7, 11, 13, 17, 19, 23... faithfully generated by complex Sieve-of-Eratosthenes algorithm.

The proof is now complete for Lemma 5.2□.

### 6. Conclusions including applying infinitesimals to outputs from Sieve of Eratosthenes and Riemann zeta function / Dirichlet eta function

Additional materials regarding L-functions of relevance to Riemann hypothesis, and Birch and Swinnerton-Dyer conjecture are supplied in Appendix A [containing many important computations and an Overall SUMMARY where we imply the "simplest version" of BSD conjecture to be true]. See Remark A.1 on Q I Z(t) positivity / Q IV Z(t) negativity criterion in Graphs of Z-function for elliptic curves. We outline a "research method" of *geometrically studying nontrivial zeros (spectrum) using Graphs of Z-function plots vs Polar graphs plots to characterize L-functions of different Analytic rank 0, 1, 2, 3, 4, 5...*

Figure 1 [depicting +ve & -ve prime numbers and composite numbers] and Figure 2 [depicting the Co-linear Riemann zeta function for +ve & -ve range] will manifest perfect Mirror symmetry and fully comply with Law of Continuity. Valid comments: Whereas the continuous-like equation Riemann zeta function  $\zeta(s)$  Eq. (1) [via proxy Dirichlet eta function  $\eta(s)$  Eq. (2)] for  $s = \sigma \pm t$  range that generate mutually exclusive CIS-IM-linear  $\sigma$ -valued co-lines be mathematically regarded as smoothly *continuous everywhere* thus obeying Law of continuity; so must the discrete-like algorithms Sieve-of-Eratosthenes and Complement-Sieve-of-Eratosthenes that generate mutually exclusive Primes and Composites be conceptually regarded as jaggedly *continuous everywhere* thus also obeying Law of continuity. CIS-ALN-decelerating Primes and CIS-IM-accelerating Composites are dependent complementary entities. In  $\zeta(s)$  Eq. (1), the equivalent Euler product formula with product over prime numbers represents  $\zeta(s) \implies$  all primes and, by default, [complementary] composites are intrinsically encoded in  $\zeta(s)$ . Since via analytic continuation,  $\eta(s) = \gamma \cdot \zeta(s)$  [proxy function for  $\zeta(s)$  in  $0 < \sigma < 1$ - critical strip]; then all primes and, by default, [complementary] composites are also intrinsically encoded in  $\eta(s)$  Eq. (2) – this is confirmed by equivalent Euler product formula for  $\eta(s)$  with product over prime numbers.

For  $i = 1, 2, 3, 4, 5, \dots, n$  (Page 14 of [8]): Recurring *Accelerating primes as Prime gap<sub>i+2</sub> – Prime gap<sub>i+1</sub> > Prime gap<sub>i+1</sub> – Prime gap<sub>i</sub>, Decelerating primes as Prime gap<sub>i+2</sub> – Prime gap<sub>i+1</sub> < Prime gap<sub>i+1</sub> – Prime gap<sub>i</sub>* and *Steady primes as Prime gap<sub>i+2</sub> – Prime gap<sub>i+1</sub> = Prime gap<sub>i+1</sub> – Prime gap<sub>i</sub>* [ $\equiv$  "Alternating Prime Gaps series" with Prime gaps alternatingly  $\uparrow$  &  $\downarrow$ ] are computed by (sub-)algorithms to obtain mutually exclusive (solitary) even prime number 2 with odd Prime gap 1; odd Twin primes, odd Cousin primes & odd Sexy primes with even Prime gaps 2, 4 & 6.

(a) For IP IL algorithm [Gap 2, 4, 6, 8, 10...]-Sieve of Eratosthenes  $p_{n+1} = 3 + \sum_{i=1}^n g_i$  [where  $n = \text{ALN}$ ] that faithfully generates all Odd  $\mathbb{P}$  {3, 5, 7, 11, 13, 17, 19...} with cardinality  $\aleph_0$ -decelerating, the  $n^{\text{th}}$  even Prime gap between two successive Odd  $\mathbb{P}$  is denoted by  $g_n = (n + 1)^{\text{st}}$  Odd  $\mathbb{P} - (n)^{\text{th}}$  Odd  $\mathbb{P}$ , i.e.  $g_n = p_{n+1} - p_n = 2, 2, 4, 2, 4, 2, \dots$

(b) For CP FL sub-algorithm [Gap 1]-Sieve of Eratosthenes  $p_{n+1} = 2 + \sum_{i=1}^n g_i$  [where  $n = 1$  and not ALN] that faithfully generates the first and only Even  $\mathbb{P}$  {2}  $\equiv$  first and only paired Even  $\mathbb{P}$  {(2,3)} with cardinality CFS of 1, the solitary  $n^{\text{th}}$  odd prime gap between two successive primes is denoted by  $g_n = (n+1)^{\text{st}}$  Odd  $\mathbb{P} - (n)^{\text{th}}$  Even  $\mathbb{P}$ , i.e.  $g_n = p_{n+1} - p_n = 3 - 2 = 1$ .

(c) For IP IL sub-algorithm [Gap 2]-Sieve of Eratosthenes  $p_{n+1} = 3 + \sum_{i=1}^n g_i$  [where  $n = \text{ALN}$ ] that faithfully generates all Odd twin  $\mathbb{P}$  {3, 5, 11, 17, 29, 41, 59...}  $\equiv$  all paired Odd twin  $\mathbb{P}$  {(3,5), (5,7), (11,13), (17,19), (29,31), (41,43), (59,61)...} with cardinality  $\aleph_0$ -decelerating, the  $n^{\text{th}}$  even Prime gap between two successive Odd twin  $\mathbb{P}$  is denoted by  $g_n = (n+1)^{\text{st}}$  Odd twin  $\mathbb{P} - (n)^{\text{th}}$  Odd twin  $\mathbb{P}$ , i.e.  $g_n = p_{n+1} - p_n = 2, 6, 6, 12, 12, 18, \dots$

(d) For IP IL sub-algorithm [Gap 4]-Sieve of Eratosthenes  $p_{n+1} = 7 + \sum_{i=1}^n g_i$  [where  $n = \text{ALN}$ ] that faithfully generates all Odd cousin  $\mathbb{P}$  {7, 13, 19, 37, 43, 67...}  $\equiv$  all paired Odd cousin  $\mathbb{P}$  {(7,11), (13,17), (19,23), (37,41), (43,47), (67,71)...} with cardinality  $\aleph_0$ -decelerating, the  $n^{\text{th}}$  even Prime gap between two successive Odd cousin  $\mathbb{P}$  is denoted by  $g_n = (n+1)^{\text{st}}$  Odd cousin  $\mathbb{P} - (n)^{\text{th}}$  Odd cousin  $\mathbb{P}$ , i.e.  $g_n = p_{n+1} - p_n = 6, 6, 8, 6, 24, \dots$

(e) For IP IL sub-algorithm [Gap 6]-Sieve of Eratosthenes  $p_{n+1} = 23 + \sum_{i=1}^n g_i$  [where  $n = \text{ALN}$ ] that faithfully generates all Odd sexy  $\mathbb{P}$  {23, 31, 47, 53, 61, 73, 83...}  $\equiv$  all paired Odd sexy  $\mathbb{P}$  {(23,29), (31,37), (47,53), (53,59), (61,67), (73,79), (83,89)...} with cardinality  $\aleph_0$ -decelerating, the  $n^{\text{th}}$  even Prime gap between two successive Odd sexy  $\mathbb{P}$  is denoted by  $g_n = (n+1)^{\text{st}}$  Odd sexy  $\mathbb{P} - (n)^{\text{th}}$  Odd sexy  $\mathbb{P}$ , i.e.  $g_n = p_{n+1} - p_n = 8, 16, 6, 8, 12, 10, \dots$

With  $n = \text{ALN}$  or, traditionally,  $\infty$ ; rigorous algorithm-type proof for Modified Polignac's and Twin prime conjectures can be stated here as two statements. Statement 1: All known prime numbers = IP IL algorithm (a) + CP FL sub-algorithm (b). Statement 2: IP IL algorithm (a) = IP IL sub-algorithm (c) + IP IL sub-algorithm (d) + IP IL sub-algorithm (e) +... [that involves all even Prime gaps 2, 4, 6, 8, 10...].

As *proxy* function for Riemann zeta function in  $0 < \sigma < 1$  critical strip, Dirichlet eta function when treated as equation and sub-equation at (unique)  $\sigma = \frac{1}{2}$ -critical line will faithfully generate all x-axis intercept points as *usual* Gram points or Gram[y=0] points, all y-axis intercept points as Gram[x=0] points, and all Origin intercept points as Gram[x=0,y=0] points or nontrivial zeros. Confirming Riemann hypothesis to be true, these entities that constitute the three types of Gram points are mutually exclusive, dependent and endowed with  $t$ -valued irrational (transcendental) numbers except for initial Gram[y=0] point endowed with a  $t$ -valued rational number:

(a) Considered for  $t = 0$  to  $+\infty$  at  $\sigma = \frac{1}{2}$ , Dirichlet eta function as IP IL equation will faithfully generate all above-mentioned three types of Gram points that are endowed with  $t$ -valued irrational (transcendental) numbers except for first Gram[y=0] point.

(b) Considered only for  $t = 0$  at  $\sigma = \frac{1}{2}$ , Dirichlet eta function as CP FL sub-equation will faithfully generate the first and only Gram[y=0] point that is endowed with  $t$ -valued rational number 0.

We analyze the data of all CIS-IM-linear computed nontrivial zeros (NTZ) when extrapolated out over a wide range of  $t \geq 0$  real number values. Akin to Prime counting function Prime- $\pi(x)$  = number of primes  $\leq x$ , we can symbolically define nontrivial zeros counting function NTZ- $\pi(t)$  = number of NTZ  $\leq t$  with  $t$  assigned to having real number values which are conveniently designated by  $10^n$  whereby  $n = 1, 2, 3, 4, 5, \dots$ . The *cumulative Prevalence of nontrivial zeros* = NTZ- $\pi(t) / t = \text{NTZ-}\pi(t) / (10^n)$  when  $t = 0$  to  $10^n$ , whereby denominator  $t$  is [artificially] regarded as having integer number values. We conceptually define all consecutive NTZ gaps as  $i^{\text{th}}$   $t$ -valued NTZ  $- (i-1)^{\text{th}}$   $t$ -valued NTZ. Thus there are CIS-IM-linear computed NTZ gaps. The numbers of NTZ between  $10^0 - 10^1$  [interval = 9],  $10^1 - 10^2$  [interval = 90],  $10^2 - 10^3$  [interval = 900],  $10^3 - 10^4$  [interval = 9000],  $10^4 - 10^5$  [interval = 90000],  $10^5 - 10^6$  [interval = 900000],  $10^6 - 10^7$  [interval = 9000000],  $10^7 - 10^8$  [interval = 90000000]... are 0, 29, 620, 9493, 127927, 1609077, 19388979, 226871900... with corresponding *rolling Prevalence of nontrivial zeros* = 0, 0.322, 0.689, 1.055, 1.421, 1.788, 2.154, 2.521...  $\implies$  *rolling Prevalence of nontrivial zeros* seems to overall fluctuatingly increase by around 0.366 in a "linear" manner; viz, Cardinality of nontrivial zeros = ||CIS-IM-linear|| =  $\aleph_0$ -linear. Denote  $a(n)$  to be the number of nontrivial zeros for each integer  $n = 1, 2, 3, 4, 5, \dots$  in the interval  $\frac{1}{2} + i[n, n + 1]$ . Then the average value is  $a(n) \sim \frac{\log n}{2\pi}$ .

$\frac{1}{2} + i 7005.06266 \dots$

Lehmer pair [e.g. pair of NTZ at the 6709<sup>th</sup> and 6710<sup>th</sup> position] can be defined

$\frac{1}{2} + i 7005.10056 \dots$

as having the nontrivial zeros property that their complex coordinates  $\gamma_n$  and  $\gamma_{n+1}$  obey the inequality  $\frac{1}{(\gamma_n - \gamma_{n+1})^2} \geq C \sum_{m \notin \{n, n+1\}} \left( \frac{1}{(\gamma_m - \gamma_n)^2} + \frac{1}{(\gamma_m - \gamma_{n+1})^2} \right)$  for a constant  $C > \frac{5}{4}$ . Analogically equivalent to identical consecutive primes [always of finite length] occurring VERY RARELY but infinitely-many times with prime gaps  $6n, 6n, 6n, \dots$  [for  $n = 1, 2, 3, 4, 5, \dots$ ]; we argue Lehmer's phenomenon simply represents those NTZ occurring as [infinitely-many] Lehmer pairs that "lie extremely close together".

In comparison, we notice the numbers of NTZ between  $10^0 - 10^1$  [interval = 9],  $10^0 - 10^2$  [interval = 99],  $10^0 - 10^3$  [interval = 999],  $10^0 - 10^4$  [interval = 9999],  $10^0 - 10^5$  [interval = 99999],  $10^0 - 10^6$  [interval = 999999],  $10^0 - 10^7$  [interval = 9999999],  $10^0 - 10^8$  [interval = 99999999]... are 0, 29, 649, 10142, 138069, 1747146, 21136125, 248008025... with corresponding *cumulative Prevalence of nontrivial zeros* = 0, 0.293, 0.650, 1.014, 1.381, 1.747, 2.114, 2.480.... Gram's Law is tendency for zeros of Riemann-Siegel Z-function  $Z(t)$  [see Appendix A] to alternate with Gram points [ $\theta(g_n) = \pi n$  where  $n = 0, 1, 2, 3, 4, 5, \dots$ ]; viz, tendency for  $(-1)^n Z(g_n) > 0$  to hold where  $g_n$  is a Gram point. In the long run, Gram's Law fails for  $\approx 1/4$  of all Gram-intervals to contain exactly one NTZ of Riemann zeta-function / Dirichlet eta function.

On the overall objective to rigorously derive Algorithm-type proofs for Modified Polignac's and Twin prime conjectures [as based on Figure 9] and Equation-type proof for Riemann hypothesis [as based on Figure 10], we apply infinitesimal numbers  $\frac{1}{\infty}$  at two places using the following colloquially-stated propositions with their formal proofs given in Page 44 – 45 of [8].

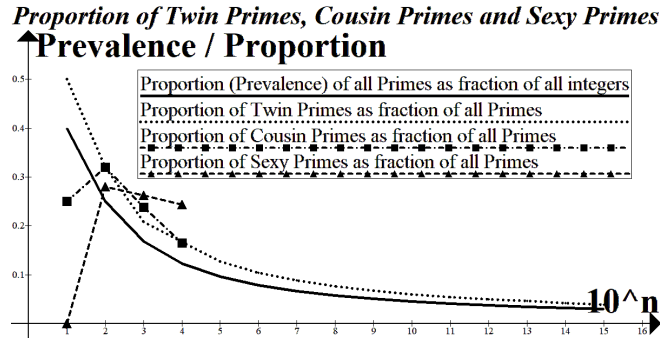

Figure 9. Proportion (Prevalence) of Twin primes, Cousin primes [as partial calculations] and Sexy Primes [as partial calculations] with Proportion (Prevalence) of all Primes included. These Proportions (Prevalences) are essentially *self-similar fractal objects*. The  $n = 1, 2, 3, 4, 5, 6, 7, 8, \dots$  in  $10^n$  that is denoted with horizontal x-axis  $\implies$  the scale of this axis is non-linearly depicted using increasing powers of 10.

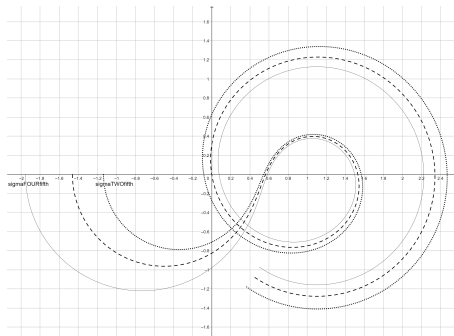

Figure 10. Simulated dynamic trajectories showing Origin intercept points when  $\sigma = \frac{1}{2}$  and virtual Origin intercept points when  $\sigma = \frac{2}{5}$  and  $\sigma = \frac{4}{5}$ . Horizontal axis:  $Re\{\zeta(\sigma + it)\}$ , and vertical axis:  $Im\{\zeta(\sigma + it)\}$ . Total presence of all Origin intercept points at the [static] Origin point. Total presence of all virtual Origin intercept points as additional negative virtual Gram[ $y=0$ ] points on the x-axis (e.g. when using  $\sigma = \frac{2}{5}$  value) at the [infinitely many varying] virtual Origin points; viz, these negative virtual Gram[ $y=0$ ] points on the x-axis cannot exist at the solitary Origin point since the two trajectories form two colinear lines (or co-lines) [**\*two parallel lines that never cross over NEAR the Origin point\***].

PROPOSITION 6.1. *In the limit of never reaching a [nonexisting] zero hereby conceptually visualized as Prevalences of both even Prime gaps and the associated [positive and negative] Odd Primes never becoming zero whereby arbitrarily large number of different even Prime gaps that uniquely accompany all Odd Primes in totality will never stop recurring. Foundation Figure 9 is roughly and analogically based on cohomology as an algebraic tool in topology allowing Geometrical-Mathematical interpretation for positive Odd Primes. We note these Prevalences can only have  $\frac{1}{\infty}$  values above zero in the large range of prime numbers [but must never have zero values].*

PROPOSITION 6.2. *In the limit of reaching an [existing] zero hereby conceptually visualized as the entire  $-\infty < t < +\infty$  trajectory of Dirichlet eta function, proxy for Riemann zeta function, touching (symbolic)*



zero-dimensional  $\sigma = \frac{1}{2}$ -Origin point only when parameter  $\sigma = \frac{1}{2}$  whereby all nontrivial zeros [mathematically] located on (symbolic) one-dimensional  $\sigma = \frac{1}{2}$ -critical line will [geometrically] declare themselves in totality as corresponding Origin intercept points. Foundation Figure 10 [see **colinear lines or co-lines definition**] is roughly and analogically based on cohomology as an algebraic tool in topology allowing Geometrical-Mathematical interpretation for  $0 < t < +\infty$  range. **Corollary:** Any  $\sigma \neq \frac{1}{2}$  co-lines that are  $\frac{1}{\infty}$  above or below zero-dimensional  $\sigma = \frac{1}{2}$ -Origin point are never classified as having nontrivial zeros. **Proposition:** Only one unique  $\sigma = \frac{1}{2}$  co-line that [repeatedly] touch zero-dimensional  $\sigma = \frac{1}{2}$ -Origin point is always classified as having [infinitely-many] nontrivial zeros. \* Useful analogy: Let Origin point intercept  $\equiv$  nontrivial zeros. Always having Origin point intercept  $\Leftrightarrow \sin x = \cos(x - \frac{C\pi}{2})$  uniquely when  $C = 1$ . Never having Origin point intercept  $\Leftrightarrow \sin x \neq \cos(x - \frac{C\pi}{2})$  non-uniquely when  $C = 1 \pm \frac{1}{\infty}$ .\*

$(0 < \sigma < 1) \equiv (0 < \sigma < \frac{1}{2}) + (\sigma = \frac{1}{2}) + (\frac{1}{2} < \sigma < 1)$ . Usefully regarded as *variants* of infinite series are various power series and harmonic series [e.g. (with  $s = \sigma \pm it$ ) Riemann zeta function  $\zeta(s)$  via Dirichlet eta function  $\eta(s)$  generating infinitely-many  $0 < \sigma < 1$ -associated trajectories that are all of  $-\infty < t < +\infty$  infinite length such as depicted by Figure 2 when  $\sigma = \frac{1}{2}$ ], and various (sub)algorithms [e.g. Sieve of Eratosthenes generating Set of  $(\pm)$  prime numbers in its entirety and Subsets of  $(\pm)$  Odd Primes from even Prime gaps 2, 4, 6, 8, 10... that all have cardinality of ALN]. \*\*Note that each  $0 < \sigma < 1$ -associated trajectory represents a unique infinite series that is, crucially, *mutually exclusive* by being **mathematically, geometrically and topologically** different from other infinite series\*\*. Analogous to term 'centroid' referring to fixed invariant (0-dimensional) point with PERFECT Point Symmetry representing *center of a geometric object in (n-dimensional) Euclidean space*; there must be: (i) [being valid for entire range +ve & -ve integers] the easily deduced integer number 0 in (1-dimensional) Figure 1 as **Centroid point** and (ii) [being valid for entire range  $-\infty < t < +\infty$ ] Origin point in (2-dimensional)  $\sigma = \frac{1}{2}$  Figure 4 when combined together with (2-dimensional)  $0 < \sigma < \frac{1}{2}$  Figure 5 and (2-dimensional)  $\frac{1}{2} < \sigma < 1$  Figure 6 [while fully satisfying (Remark 2.2) Principle of Equidistant for Multiplicative Inverse as previously discussed in Figure 7 with ONLY  $\sigma = \frac{1}{2}$  containing the **most frequently & infinitely-often traversed or visited Centroid (Origin) point**]. Our unique Centroid (Origin) point for  $\eta(s)$  is conceptually the Point Symmetry with ASSIGNED Central value as  $\eta(\frac{1}{2} \pm it) = 0.0 + 0.0i = 0$  at intersection of horizontal real axis & vertical imaginary axis [and having two Line Symmetry of horizontal real axis as depicted by Figure 2 and vertical line  $\sigma = \frac{1}{2}$  as depicted by Figure 3]. In comparison, COMPUTED Central value for  $\zeta(s)$  via its functional equation having Line Symmetry of vertical line  $s = \frac{1}{2}$  [that intersect horizontal real axis] is  $\zeta(\frac{1}{2}) \approx -1.4603545 + 0.0i \approx -1.4603545$ . As overall summary, we insightfully conclude mutually exclusive (sub)sets arising from prime numbers, composite numbers, Gram points and virtual Gram points MUST all conceptually comply in full with *Theory of Symmetry from Langlands program and Inclusion-Exclusion Principle* when "extended to the infinite (sub)sets".

#### **Acknowledgements, Declarations, Data Availability Statement, and Conflict of Interest Statement**

The author is grateful to Reviewers and LMFDB Managing (and Associate) Editors for feedbacks. All the



generated data are included. There is no conflict of interest. This paper is dedicated to his daughter Jelena born 13 weeks early on May 14, 2012 with Very Low Birth Weight of 1010 grams. **Ethical approval:** Not applicable. **Funding:** AUS \$5,000 research grant was provided by Mrs. Connie Hayes and Mr. Colin Webb on January 20, 2020. An extra AUS \$3,250 reimbursement was received from Q-Pharm for participation in EyeGene Shingles trial commencing on March 10, 2020. From Doctor of Philosophy (PhD) viewpoint on Ageing, Dementia, Sleep, Learning, Memory and Number theory; the author possesses average level of working, short-term and long-term memory, and *Concrete Mathematics* ability. While conducting research that requires advance *Abstract Mathematics*, he routinely practices behavioral augmentation on personal Stage 3 Deep Sleep which contributes to insightful thinking, creativity and memory, and Stage 4 REM Sleep which is essential to cognitive functions memory, learning and creativity.

### References

- [1] Gross B.H. & Zagier D. (1980). On the critical values of Hecke L-series. *Bulletin de la Societe Mathematique de France*, 108(2), pp. 49 – 54.
- [2] Lichtman J. (2023). A proof of the Erdos primitive set conjecture. *Forum of Mathematics, Pi*, 11, E18, pp. 1 – 21. <http://dx.doi:10.1017/fmp.2023.16>
- [3] LMFDB Collaboration. (2024). *The L-functions and modular forms database*. <https://www.lmfdb.org> [Online accessed on 5 May 2024]
- [4] Padilla A. & Smith R.G.C. (2024). Smoothed asymptotics: from number theory to QFT. *arXiv:2401.10981v1*, pp. 1–28. <https://doi.org/10.48550/arXiv.2401.10981>
- [5] Rodriguez-Villegas F. & Zagier D. (1993). Square roots of central values of Hecke L-series. In *Advances in number theory (Kingston, ON, 1991)*, pp. 81 – 99. Oxford Sci. Publ., Oxford Univ. Press, New York.
- [6] Ting J.Y.C. (2020). Mathematical Modelling of COVID-19 and Solving Riemann Hypothesis, Polignac's and Twin Prime Conjectures Using Novel Fic-Fac Ratio With Manifestations of Chaos-Fractal Phenomena. *J. Math. Res.*, 12(6) pp. 1 – 49. <https://doi.org/10.5539/jmr.v12n6p1>
- [7] Ting J.Y.C. (2023). Origin Point Must Represent Critical Line as Location for Nontrivial Zeros of Riemann Zeta Function, and Set Prime Gaps With Subsets Odd Primes Are Arbitrarily Large in Number. *J. Math. Res.*, 15(4) pp. 1 – 55. <https://doi.org/10.5539/jmr.v15n4p1>
- [8] Ting J.Y.C. (2024). On the Universal Presence of Mathematics for Incompletely Predictable Problems in Rigorous Proofs for Riemann Hypothesis, Modified Polignac's and Twin Prime Conjectures. *J. Math. Res.*, 16(2) pp. 1 – 61. <https://doi.org/10.5539/jmr.v16n2p1>
- [9] Zhang Y. (2014). Bounded gaps between primes. *Ann. of Math.*, 179, pp. 1121 – 1174. <http://dx.doi.org/10.4007/annals.2014.179.3.7>

### Appendix A. Predictability properties of Dirichlet L-series from Dirichlet L-functions that are relevant to Riemann hypothesis, and Birch and Swinnerton-Dyer conjecture

L-functions literally encode "arithmetic information" e.g. Riemann zeta function connects through values at +ve even integers (and –ve odd integers) to Bernoulli numbers, with appropriate generalization of this phenomenon obtained via  $p$ -adic L-functions, which describe certain Galois modules. Distribution of

nontrivial zeros (spectrum), orders, conductors, etc are connected to Chaos theory / Fractal geometry, random matrix theory and quantum chaos; manifesting as self-similarity or large fractal dimension.

Recall the 'general' Dirichlet series is an infinite series of form  $\sum_{n=1}^{\infty} a_n e^{-\lambda_n s}$  where  $a_n, s [= \sigma \pm it]$  are complex numbers and  $\{\lambda_n\}$  is a strictly increasing sequence of nonnegative real numbers that tends to infinity. An 'ordinary' Dirichlet series  $\sum_{n=1}^{\infty} \frac{a_n}{n^s}$  is obtained by substituting  $\lambda_n = \ln n$  while a power series  $\sum_{n=1}^{\infty} a_n (e^{-s})^n$  is obtained when  $\lambda_n = n$ . Parallel to 'ordinary' Dirichlet series, we define a useful 'extra-ordinary' Dirichlet series [for non-polynomial (transcendental) equations e.g. for  $\cos s$  and  $e^s$ ].

$$(7) \quad \text{Generic-}L(s) = \sum_{n=0}^{\infty} \frac{a_n}{f(n)} = \frac{a_0}{f(0)} + \frac{a_1}{f(1)} + \frac{a_2}{f(2)} + \frac{a_3}{f(3)} + \frac{a_4}{f(4)} + \dots$$

We characterize the Predictability property of Eq. (7) Generic  $L$ -function [referring to non-polynomial equations with having denominator =  $f(n)$  thus forming any mathematical expressions that do not involve  $s$ ], denoted by Generic- $L(s)$ , which is our **\*\*\*useful 'extra-ordinary' Dirichlet series [(non-)alternating power series]\*\*\*** where  $a_n = a_0, a_1, a_2, a_3, a_4, \dots$  are the Dirichlet coefficients that are, in theory, either Completely Predictable (CP) or Incompletely Predictable (IP) entities.

The Generic- $L(s)$  for  $\cos s = \sum_{n=0}^{\infty} \frac{(-1)^n s^{2n}}{(2n)!} = \frac{s^0}{0!} - \frac{s^2}{2!} + \frac{s^4}{4!} - \frac{s^6}{6!} + \frac{s^8}{8!} - \dots$ . When  $s = 1 + 0i = 1$ , we obtain  $\cos 1 = \frac{1^0}{0!} - \frac{1^2}{2!} + \frac{1^4}{4!} - \frac{1^6}{6!} + \frac{1^8}{8!} - \dots$  as alternating power series where  $a_n = (-1)^n \cdot (1)^{2n} = a_0, a_1, a_2, a_3, a_4, \dots = 1, -1, 1, -1, 1, \dots$  are [computed] Dirichlet coefficients as CP entities. When  $s = 0 + i = i$ , we obtain  $\cos i = \frac{1^0}{0!} + \frac{1^2}{2!} + \frac{1^4}{4!} + \frac{1^6}{6!} + \frac{1^8}{8!} + \dots$  as non-alternating power series where  $a_n = (-1)^n \cdot (i)^{2n} = (1)^{2n} = a_0, a_1, a_2, a_3, a_4, \dots = 1, 1, 1, 1, 1, \dots$  are [computed] Dirichlet coefficients as CP entities.

The Generic- $L(s)$  for  $e^s = \sum_{n=0}^{\infty} \frac{s^n}{n!} = \frac{s^0}{0!} + \frac{s^1}{1!} + \frac{s^2}{2!} + \frac{s^3}{3!} + \frac{s^4}{4!} + \frac{s^5}{5!} + \dots$ . When  $s = 1 + 0i = 1$ , we obtain  $e^1 = \sum_{n=0}^{\infty} \frac{1^n}{n!} = \frac{1^0}{0!} + \frac{1^1}{1!} + \frac{1^2}{2!} + \frac{1^3}{3!} + \frac{1^4}{4!} + \frac{1^5}{5!} + \dots$  as non-alternating power series where  $a_n = (1)^n = a_0, a_1, a_2, a_3, a_4, \dots = 1, 1, 1, 1, 1, \dots$  are [computed] Dirichlet coefficients as CP entities. When  $s = 0 + i = i$ , we obtain  $e^i = \sum_{n=0}^{\infty} \frac{i^n}{n!} = \frac{i^0}{0!} + \frac{i^1}{1!} + \frac{i^2}{2!} + \frac{i^3}{3!} + \frac{i^4}{4!} + \frac{i^5}{5!} + \dots = \frac{1}{0!} + \frac{i}{1!} - \frac{1}{2!} - \frac{i}{3!} + \frac{1}{4!} + \frac{i}{5!} - \dots$  as alternating power series where  $a_n = (i)^n = a_0, a_1, a_2, a_3, a_4, a_5, \dots = +1, +i, -1, -i, +1, +i, \dots$  [as perpetual repeating (periodic) patterns of  $+1, +i, -1, -i$ ] are [computed] Dirichlet coefficients as CP entities.

$$(8) \quad \text{General-}L(s) = \sum_{n=1}^{\infty} \frac{a_n}{n^s} = \frac{a_1}{1^s} + \frac{a_2}{2^s} + \frac{a_3}{3^s} + \frac{a_4}{4^s} + \frac{a_5}{5^s} + \dots$$

We next characterize the Predictability property of Eq. (8) General  $L$ -function [referring to polynomial equations with having denominator =  $f(n, s)$ ], denoted by General- $L(s)$ , which is **\*\*\*the 'ordinary'**

**Dirichlet series [(non-)alternating harmonic series]\*\*\*\* where  $a_n = a_1, a_2, a_3, a_4, a_5, \dots$  are the Dirichlet coefficients that are, in theory, either CP or IP entities.**

Eq. (1) Riemann zeta function  $\zeta(s)$  is the **most basic** General  $L$ -function, denoted here by  $L_\zeta(s)$  [as non-alternating harmonic series], where  $a_n = (1)^n = a_1, a_2, a_3, a_4, a_5, \dots = 1, 1, 1, 1, 1, \dots$  are [computed] Dirichlet coefficients as CP entities. Eq. (2) Dirichlet eta function  $\eta(s)$  is the **most basic** General  $L$ -function, denoted here by  $L_\eta(s)$  [as alternating harmonic series], where  $a_n = (-1)^{n+1} = a_1, a_2, a_3, a_4, a_5, \dots = 1, -1, 1, -1, 1, -1, \dots$  are [computed] Dirichlet coefficients as CP entities. Eq. (2) [that converges for  $\Re(s) > 0$ ] is the Analytic continuation of Eq. (1) [that converges for  $\Re(s) > 1$ ].

We derive an [motivic]  $L$ -function from a polynomial and obtain coefficient sequence of this  $L$ -function associated to middle cohomology of projective closure of hyperspace defined by the given polynomial equation.  $\mathbb{C}$  = complex numbers are usually represented by  $z = a + bi$ . Based on complex unit equation  $i^2 + 1 = 0$  that define imaginary unit  $i$ , Gaussian integers are set  $Z[i] = \{a + bi \mid a, b \in \mathbb{Z}\}$  and Complex numbers are set  $\mathbb{C} = R[i] = \{a + bi \mid a, b \in \mathbb{R}\}$ . The " $\mathbb{R}$ -to- $\mathbb{C}$ " polynomial equation " $K$ " is a case of motivic  $L$ -function [which is a non-alternating harmonic series] referred to as Dedekind zeta function of number field  $K$  defined by this specific one-variable polynomial equation [of degree 2 and rank of its Unit group = 0]:  $x^2 + 1 = 0 \equiv x^2 = -1 \equiv x = \pm \sqrt{-1} \equiv x = \pm i$ . Its  $L$ -function,  $L_K(s)$ , has [computed] Dirichlet coefficients  $a_n = a_1, a_2, a_3, a_4, a_5, \dots = 1, 1, 0, 1, 2, 0, 0, 1, 1, 2, 0, 0, 2, \dots$  that are Incompletely Predictable entities [viz,  $L_K(s) = \zeta_K(s) = \frac{1}{1^s} + \frac{1}{2^s} + \frac{0}{3^s} + \frac{1}{4^s} + \frac{2}{5^s} + \dots$ ]. The norm is defined as  $N(a + bi) = a^2 + b^2$ . Then the computed  $a_n$  values for Gaussian integers are precisely the Number of Points corresponding to the norm  $N(a + bi)$  of values  $n = 1, 2, 3, 4, 5, 6, 7, 8, 9, 10, 11, 12, 13, \dots$  [Note:  $L_K(0) = -\frac{1}{4}$  is a special case of class number formula that relates many important invariants of an algebraic number field to a special value of its Dedekind zeta function.] When combined with  $a_n = (1)^n = a_1, a_2, a_3, a_4, a_5, \dots = 1, 1, 1, 1, 1, \dots$  from  $\zeta(s)$ 's  $L_\zeta(s)$ , one can construct the associated ["diagonal"] Automorphic  $L$ -function [which is an alternating harmonic series] for  $L_K(s)$  having eternally repeating (periodic) patterns given by [Completely Predictable entities]  $1, 0, -1, 0$  to recursively derive all the  $a_n$  values in Motivic  $L$ -function  $L_K(s)$  [with Analytic rank 0]. This fundamental Automorphic  $L$ -function for  $L_K(s)$ , denoted by  $L_A(s)$  [with Analytic rank 0 and its unique eternally repeating (periodic)  $a_n$  pattern of  $1, 0, -1, 0$ ], is one of the simplest Automorphic  $L$ -function in nature. Here  $L_A(s) = \zeta_A(s) = \frac{1}{1^s} + \frac{0}{2^s} - \frac{1}{3^s} + \frac{0}{4^s} + \frac{1}{5^s} + \dots = \frac{1}{1^s} + \frac{0}{2^s} + \frac{-1}{3^s} + \frac{0}{4^s} + \frac{1}{5^s} + \dots$ . Having Euler product and functional equation for  $\zeta_A(s)$  [denoting Automorphic  $L$ -function  $L_A(s)$ ]:  $\zeta_A(s)$  converges for  $Re(s) > 1$ , Trivial zeros occurs at  $s =$  all negative odd integers but not including 0, and Nontrivial zeros (spectrum) via Analytic continuation occurs at its Critical Line  $\sigma = \frac{1}{2}$ . Having Euler product and functional equation for  $\zeta_K(s)$  [denoting  $L$ -function for  $L_K(s)$ ]:  $\zeta_K(s)$  converges for  $Re(s) > 1$ , Trivial zeros occurs at  $s =$  all negative integers but not including 0, and Nontrivial zeros (spectrum) via Analytic continuation occurs at its Critical Line  $\sigma = \frac{1}{2}$ . [See the values for  $L_A(s)$  and  $L_K(s)$  given below.]

Having Euler product and functional equation for **Sum-of-Divisors function**  $\sigma$  for a real or complex number  $z$  [viz,  $\sigma_z(n) = \sum_{d|n} d^z$ , where  $d | n$  is shorthand for " $d$  divides  $n$ "], its  $L$ -function [with Analytic rank 0] has Dirichlet  $L$ -series giving rise to this (complex) non-alternating harmonic series  $L_\sigma(s) = \zeta_\sigma(s)$

$= \frac{1}{1^s} + \frac{3}{2^s} + \frac{4}{3^s} + \frac{7}{4^s} + \frac{6}{5^s} + \dots$  having Incompletely Predictable +ve  $a_n$  integer values 1, 3, 4, 7, 6, 12, 8, 15, 13, 18, 12, 28, 14, 24, 24, 31... that alternately increase and decrease in a perpetual manner [and is overall slowly increasing]. We limit discussing this remarkable function by commenting that  $\sigma_z(n)$  appears in a number of special identities, and has relationships with Riemann zeta function and Eisenstein series of modular forms. Two Dirichlet series involving  $\sigma_z(n)$  are  $\sum_{n=1}^{\infty} \frac{\sigma_a(n)}{n^s} = \zeta(s)\zeta(s-a)$  for  $s > 1, s > a + 1$ ,

where  $\zeta(s)$  is the Riemann zeta function. The series for  $d(n) = \sigma_0(n)$  gives  $\sum_{n=1}^{\infty} \frac{d(n)}{n^s} = \zeta^2(s)$  for  $s > 1$ , and

a Ramanujan identity  $\sum_{n=1}^{\infty} \frac{\sigma_a(n)\sigma_b(n)}{n^s} = \frac{\zeta(s)\zeta(s-a)\zeta(s-b)\zeta(s-a-b)}{\zeta(2s-a-b)}$ . This identity is a special case

of Rankin–Selberg convolution. Here,  $\sigma_0(n) = \prod_{i=1}^r (a_i + 1)$  e.g.  $\sigma_0(12)$  is the number of the divisors of 12; viz,  $\sigma_0(12) = 1^0 + 2^0 + 3^0 + 4^0 + 6^0 + 12^0 = 1 + 1 + 1 + 1 + 1 + 1 = 6$ .

Definition: An elliptic curve is **semistable** if it has multiplicative reduction at every "bad" prime.

Example "[**semistable**] Elliptic curve LMFDB label 11.a2" having **Analytic rank 0** [with trivial zeros 0, -1, -2, -3, -4, -5,... and nontrivial zeros 6.36, 8.60, 10.03, 11.45, 13.56, 15.91, 17.03, 17.94,... (**that DO NOT start at t = 0**)] can equivalently be written as  $y^2 + y = x^3 - x^2 - 10x - 20$  (Minimal Weierstrass equation; viz,  $y^2 + a_1xy + a_3y = x^3 + a_2x^2 + a_4x + a_6$  whereby  $a_1, a_3 = 0$  or 1 and  $a_2 = -1, 0$  or 1 are Weierstrass coefficients in  $\mathbb{Z}$ ) OR  $y^2z + yz^2 = x^3 - x^2z - 10xz^2 - 20z^3$  (Minimal Weierstrass equation, homogenize with extra variable  $z$ ) OR  $y^2 = x^3 - 13392x - 1080432$  (simplified equation; viz  $y^2 = x^3 + Ax + B$ ). The 2001 modularity theorem asserts that every elliptic curve [viz, fundamental mathematical objects defined by Genus 1 cubic (or degree 3) polynomial diophantine equations in two variables] over  $\mathbb{Q}$  is modular, meaning it is associated with an "infinite series" modular form. The unique correspondence in Langland program is given as {Counting problem  $1 + p -$  number of solutions mod  $p$  [in *finite series* Elliptic curves]  $\leftrightarrow$  Coefficients of  $q^p$  [in *infinite series* Modular forms]} whereby nome  $q = e^{\pi i \tau}$  &  $p =$  prime numbers from Modular forms act as the (periodic) 'generating series or functions' having Group of symmetry =  $SL_2(\mathbb{Z})$  [involving unit disk in complex plane]. Let  $E$  be an elliptic curve, and let  $N_p$  denote the number of points on  $E \pmod p$ . Set  $a_p = p + 1 - N_p$ . We can define the incomplete L-function of  $E$  [viz, Hasse-Weil L-function  $L(E, s)$  of  $E$ ]. We provide the modern formulation of BSD conjecture that relates arithmetic data associated with  $E$  over a number field  $K$  to behavior of this  $L(E, s)$  of  $E$  at  $s = 1$ . More specifically, it is conjectured that algebraic  $r_E = \text{ord}_{s=1} L(E, s)$ ; viz, the rank of abelian group  $E(K)$  of points of  $E$  is the order of the zero of  $L(E, s)$  at  $s = 1$ . By modularity theorem, for any  $E$ ,  $L(E, s)$  has a holomorphic continuation to the entire complex plane. Then there exist analytic  $r'_E$  as an integer such that the Taylor expansion of  $L(E, s)$  at  $s = 1$  is of a certain form that involves  $r'_E$ . BSD conjecture asserts that  $r_E = r'_E$ . Known results involving  $r_E$  or  $r'_E$ : If  $r'_E = 0$  or 1 for an elliptic curve  $E$ , then BSD conjecture is true for  $E$ , whereby most  $E$  [viz, at least 83%] have rank 0 or 1. BSD conjecture is true for > 66% of all  $E$  [of rank 0, 1 or > 1]. Eventhough " $\approx 100\%$  of  $E$ " are conjectured to have rank 0 or 1 [infinite in numbers], the remaining " $\approx 0\%$  of  $E$ " having rank at least 2, while extremely rare, will also be infinite in number.

There are approaches to determine whether ranks of elliptic curves over  $\mathbb{Q}$  are bounded or not e.g. computing an upper bound on  $p$ -Selmer rank of  $E$ , which translates into obtaining the "bound for Mordell-Weil rank  $r$  of  $E(\mathbb{Q})$  on average" as well. \*Analogous to distribution of prime numbers being deceleratingly infinitely-many or arbitrarily large in number (ALN), then rank  $r_E \geq 2$  are heuristically ALN associated with increasing rank size of 2, 3, 4, 5...\*. Two elliptic curves  $E$  having large exact  $r_E = 20$  (by Noam Elkies & Zev Klagsbrun in 2020) and  $r_E = 28$  (by Noam Elkies in 2006) are given below.

$$r_E = 20: y^2 + xy + y = x^3 - x^2 - 244537673336319601463803487168961769270757573821859853707x + 961710182053183034546222979258806817743270682028964434238957830989898438151121499931$$

$$r_E = 28: y^2 + xy + y = x^3 - x^2 - 20067762415575526585033208209338542750930230312178956502x + 34481611795030556467032985690390720374855944359319180361266008296291939448732243429$$

Example of a Family of L-function  $L_n(s)$  from elliptic curves: For  $n = 1, 2, 3, 4, 5, \dots$ ,  $y^2 = x^3 - n^2x$ . This family is related to the **congruent number problem**; viz, finding a congruent number which is a positive integer [or positive rational number] that is the area of a right triangle with three rational number sides.

Example "[semistable] Elliptic curve LMFDB label 14.a5" ["mixed" polynomial equation  $E$  as two-variable equation having **Analytic rank 0** with trivial zeros 0, -1, -2, -3, -4, -5,... and nontrivial zeros 5.57, 7.57, 9.76, 11.23, 12.30, 14.60, 16.33, 17.21,... (**that DO NOT start at  $t = 0$** )] is an alternating harmonic series that is expressed in terms of a simpler periodic sequence; viz, an Automorphic object called a Dirichlet L-function or an L-function of a modular form]:  $y^2 + xy + y = x^3 - x \equiv$  [factorized]  $y(y + x + 1) = x(x + 1)(x - 1)$ . Its degree 2 Euler product  $L_E(s) = \prod_p F_p(p^{-s})^{-1}$  has [finitely-many] "bad" primes of 2 and 7 corresponding to  $F_p T$  of  $(1 + T)$  and  $(1 - T)$ , and [infinitely-many] "good" primes 3, 5, 11... corresponding to  $F_p T$  of  $(1 + 2T + pT^2)$ ,  $(1 + pT^2)$ ,  $(1 + pT^2)$ .... Its  $L_E(s)$  [which is a (complex) alternating harmonic series] has "Counting solutions mod  $p$ " as  $a_n = a_1, a_2, a_3, a_4, a_5, \dots = 1, -1, -2, 1, 0, 2, 1, -1, 1, 0, 0, -2, -4, -1, 0, 1, 6, -1, 2, \dots$ . These [computed] Dirichlet coefficients are Incompletely Predictable entities **with perpetually alternating increasing and decreasing +ve and -ve integer values**. All  $a_n$  values can now be precisely obtained from the particular generating series below for this  $L_E(s)$  [with FINITE unique numbers 1, 2, 7, 14 in the exponents of Euler product formula]:

$$f(z) = \eta(z)\eta(2z)\eta(7z)\eta(14z) = q \prod_{n=1}^{\infty} (1 - q^n)(1 - q^{2n})(1 - q^{7n})(1 - q^{14n}).$$

Here  $f(z)$  is some of the simplest modular forms known as **eta quotient**, and can be described in combinatorial terms. The  $q$ -expansion is  $f(q) = q - q^2 - 2q^3 + q^4 + 2q^6 + q^7 - q^8 + q^9 + O(q^{10})$ . Here, as alternating harmonic series,  $L_E(s) = \zeta_E(s) = \frac{1}{1^s} - \frac{1}{2^s} - \frac{2}{3^s} + \frac{1}{4^s} + \frac{0}{5^s} + \dots = \frac{1}{1^s} + \frac{-1}{2^s} + \frac{-2}{3^s} + \frac{1}{4^s} + \frac{0}{5^s} + \dots$ .

\*Compare and contrast  $L_E(s)$  for Elliptic curve  $\zeta_E(s)$  VERSUS  $L_\zeta(s)$  for Riemann zeta function  $\zeta(s)$ . [1] Convergence:  $\zeta_E(s)$  converges for  $Re(s) > \frac{3}{2}$ .  $\zeta(s)$  converges for  $Re(s) > 1$ . [2] The trivial zeros: For  $\zeta_E(s)$  occurs at  $s =$  all negative integers including 0. For  $\zeta(s)$ , occurs at  $s =$  all negative even integers but not including 0 / For  $\eta_E(s)$  occurs at  $s =$  all negative integers but not including 0. [3] The nontrivial zeros (spectrum) obtained via Analytic continuation: For  $\zeta_E(s)$ , nontrivial zeros occurs ONLY at its Critical Line  $\sigma = 1$ . For  $\zeta(s)$  there is NO nontrivial zeros / For  $\eta(s)$ , nontrivial zeros occurs ONLY at its Critical Line  $\sigma = \frac{1}{2}$ \*. We multiply  $\zeta_E(s)$  by gamma factor  $\Gamma_{\mathbb{C}}(s) = 2 \cdot (2\pi)^{-s} \Gamma(s)$  to obtain a **symmetric version** of

this elliptic curve's functional equation applied to Lambda-function  $\Lambda_E(s) = 14^{\frac{5}{2}} \cdot 2 \cdot (2\pi)^{-s} \Gamma(s) \zeta_E(s)$ ; viz,  $\Lambda_E(s) = 14^{\frac{5}{2}} \Gamma_{\mathbb{C}}(s) L_E(s) = \Lambda_E(2-s)$  [which is Analytically normalized to be  $\Lambda_E(s) = 14^{\frac{5}{2}} \Gamma_{\mathbb{C}}(s + \frac{1}{2}) L_E(s) = \Lambda_E(2-s)$ ], whereby Conductor = 14 for this elliptic curve with LMFDB label 14.a5. This is associated with perfect Line Symmetry at vertical line  $s = 1$ . In other words, we perform **Analytic normalization** for  $\zeta_E(s)$  in elliptic curves by shifting  $\Gamma_{\mathbb{C}}(s)$  to  $\Gamma_{\mathbb{C}}(s + \frac{1}{2})$  to instead obtain convergence for  $Re(s) > 1$ , Critical Line as  $\sigma = \frac{1}{2}$  and perfect Line Symmetry as vertical line  $s = \frac{1}{2}$  that is present in, e.g.,  $\zeta_A(s)$ ,  $\zeta_K(s)$ ,  $\zeta(s)$ ,  $\eta(s)$ , etc [as the uniformly adopted "notation" in *Generalized Riemann hypothesis*].

Here we reiterate again that Hasse-Weil zeta function, attached to an algebraic variety  $V$  defined over an algebraic number field  $K$ , is a meromorphic function on complex plane defined in terms of number of points on the variety after reducing modulo each prime number  $p$ . It is a global L-function defined as an Euler product of local zeta functions, and is conjecturally related to the group of rational points of elliptic curve over  $K$  by BSD conjecture. It is a **variant** of Riemann zeta function  $\zeta(s)$  and Dirichlet L-function. The natural definition of  $L(E, s)$  for elliptic curves converges for values of  $s$  in complex plane with  $Re(s) > \frac{3}{2}$  [or  $Re(s) > \frac{1}{2}$  via **Analytic normalization** by shifting  $\Gamma_{\mathbb{C}}(s)$  to  $\Gamma_{\mathbb{C}}(s + \frac{1}{2})$  thus conforming with Generalized Riemann hypothesis]. Helmut Hasse conjectured that  $L(E, s)$  could be extended by Analytic continuation to whole complex plane. This conjecture was first proved by Deuring in 1941 for elliptic curves with complex multiplication [always Analytic rank 0] defined over fields of characteristic zero [whose endomorphism ring is larger than  $\mathbb{Z}$  and is isomorphic to an order in an imaginary quadratic field, with the discriminant of this order called CM discriminant]. {Complex multiplication for complex number  $z = a + bi$  is carried out using only three real multiplications  $ac, bd$ , and  $(a+b)(c+d)$  as  $\mathcal{R}[(a+ib)(c+id)] = ac - bd$ ,  $\mathcal{I}[(a+ib)(c+id)] = (a+b)(c+d) - ac - bd$ .} It was subsequently shown to be true for all elliptic curves over  $\mathbb{Q}$ , as a consequence of modularity theorem in 2001. Reiterating: BSD conjecture relates the order of vanishing and the first non-zero Taylor series coefficient of L-function associated to an elliptic curve  $E$  defined over  $\mathbb{Q}$  at central point  $s = 1$  to certain arithmetic data, the BSD invariants of  $E$ .

Example Elliptic curve LMFDB label 49.a4 **that is NOT a semistable elliptic curve**; Minimal Weierstrass equation  $y^2 + xy = x^3 - x^2 - 2x - 1$ : Integral point / Torsion generator =  $(2, -1)$ , Conductor = 49 [with its Modular form 49.2.a.a given by  $q + q^2 - q^4 - 3q^8 - 3q^9 + 4q^{11} - q^{16} - 3q^{18} + O(q^{20})$  (Modular degree 1)], Discriminant =  $-343$  with all  $p$ -adic regulators being identically 1 since its **Analytic rank = 0** [with trivial zeros  $0, -1, -2, -3, -4, -5, \dots$  and nontrivial zeros  $3.45, 5.08, 6.47, 8.49, 9.48, 11.30, 12.27, 13.55, \dots$  (**that DO NOT start at  $t = 0$** )]  $\implies$  finite  $E(\mathbb{Q})$  solutions. At Central Point  $s = 1$ , Special value  $L(E, 1)$  is the first non-zero value among  $L(E, 1), L'(E, 1), L''(E, 1), \dots \approx 0.96665585280840577336653841951$  for elliptic curve 49.a4 computed using formula  $\frac{1}{r!} L^{(r)}(E, 1)$  listed in Remark 1.2. This is depicted below:  

$$0.966655853 \approx L(E, 1) = \frac{\#\text{III}(E/\mathbb{Q}) \cdot \Omega_E \cdot \text{Reg}(E/\mathbb{Q}) \cdot \prod_p c_p}{\#E(\mathbb{Q})_{\text{tor}}^2} \approx \frac{1 \cdot 1.933312 \cdot 1.000000 \cdot 2}{2^2} \approx 0.966655853.$$

We now regard center of the critical strip as being  $s = \frac{1}{2}$ ; viz, analytically normalized Central Point is  $s = \frac{1}{2}$ . Then computing Central value of  $L(s, \chi^{2n-1})$  at this Central Point of elliptic curve 49.a4 that obeys Complex Multiplication is possible; as per formula on computing this Central value listed in Remark 1.2.

Broadly, operations on L-functions using L-series include Unary operation [e.g.  $\lambda$ -operation], Binary operation [e.g. Addition, Multiplication, Selberg inner product], Pairing, Property, Relation, Family and Invariants [e.g. Sign, Self-dual (viz, Dirichlet coefficients  $a_n$  in L-function  $L(s) = \sum_{n=1}^{\infty} \frac{a_n}{n^s}$  are real), Primitive, Degree of elliptic curves, Motivic (Arithmetic) weight  $w_{ar}$ , Algebraic weight  $w_{alg}$  (whereby **Hodge conjecture asserts that  $w_{alg} = w_{ar}$  for any motivic L-function**); Conductor for various "classes" of the elliptic curves e.g. Conductor for elliptic curves with Analytic rank = 0 include integer values 11, 14, 15, 17, 19, 20, 21, 24, 26, 27, 30, 32, 33, 34,...; etc]. Two specific operations: Addition (Direct Sum) e.g.  $L_{\zeta}(s) \oplus L_A(s) = L_K(s)$ ; and Multiplication (Tensor product or Rankin-Selberg convolution) e.g.  $L_A(s) \otimes L_K(s) = L_K(s)$ ,  $L_A(s) \otimes L_A(s) = L_{\zeta}(s)$ ,  $L_{\zeta}(s) \otimes L_E(s) = L_E(s)$  where  $L_{\zeta}(s)$  is identity element for  $\otimes$ .

Trivial zeros for  $L_K(s) = -1, -2, -3, -4, -5, -6, -7...$  (most frequent as all  $-ve$  integers, but not 0).

Trivial zeros for  $L_A(s) = -1, -3, -5, -7, -9, -11, -13...$  (intermediate frequency as  $-ve$  Odd numbers).

Trivial zeros for  $L_{\eta}(s) = -2, -4, -6, -8, -10, ...$  (intermediate frequency as  $-ve$  Even numbers).

Trivial zeros for  $L_{\zeta}(s) = -2, -4, -6, -8, -10, ...$  (intermediate frequency as  $-ve$  Even numbers).

Nontrivial zeros for [rank 0]  $L_K(s) = 6.02, 10.24, 12.99, 14.13, 16.34, 18.29, 21.02...$  (most frequent).

Nontrivial zeros for [rank 0]  $L_A(s) = 6.02, 10.24, 12.99, 16.34, 18.29...$  (intermediate frequency).

Nontrivial zeros for [rank 0]  $L_{\eta}(s) = 14.13, 21.02, 25.01, 30.42, 32.93, 37.58...$  (least frequent).

**Note:** Nontrivial zeros for  $L_{\zeta}(s)$  DO NOT exist. Polynomial equation  $P(s) = x^2 + 1$  for Equation "K" [representing a Number field] is "simplest" defining polynomial of degree 2 [and rank of its Unit group = 0]. Its L-function  $L_K(s)$  has Analytic rank 0, and DO NOT have first nontrivial zero located at  $t = 0$ .

We adopt here  $\zeta(\sigma + it)$  when  $0 < t < \infty$  and ignore its complex conjugate  $\zeta(\sigma - it)$  when  $-\infty < t < 0$ . As determining the obvious relationship on above listed entities of trivial zeros and nontrivial zeros [located at  $\sigma = \frac{1}{2}$ -Critical Line] derived from  $L_K(s)$ ,  $L_A(s)$ ,  $L_{\zeta}(s)$  and  $L_{\eta}(s)$  [when Analytically continued from Convergence for  $R > 1$  to entire complex plane; viz, Convergence for  $R > 0$ ], **we confirm these entities derived from  $L_K(s)$  faithfully represent the combined entities derived from  $L_A(s)$  and  $L_{\zeta}(s) / L_{\eta}(s)$ .**

The gamma factors are  $\Gamma_{\mathbb{R}}(s) = \pi^{-\frac{s}{2}} \Gamma(\frac{s}{2})$  and  $\Gamma_{\mathbb{C}}(s) = 2(2\pi)^{-s} \Gamma(s)$ . Functional equations  $\Lambda(s) = \Lambda(1-s)$  is from  $\Gamma_{\mathbb{R}}(s)$ ; and  $\Lambda(s) = \varepsilon \bar{\Lambda}(1-s)$  [ $\equiv \pm \Lambda(2-s)$ ] is from  $\Gamma_{\mathbb{C}}(s)$ . Functional equations for Riemann zeta function  $\zeta(s)$  in  $L_{\zeta}(s)$  requires gamma factor  $\Gamma_{\mathbb{R}}(s)$  [with Conductor = 1]; for  $\zeta_A(s)$  in  $L_A(s)$  requires gamma factor  $\Gamma_{\mathbb{R}}(s+1)$  [with Conductor = 4]; for  $\zeta_K(s)$  in  $L_K(s)$  requires gamma factor  $\Gamma_{\mathbb{C}}(s)$  [with Conductor = 4]; and for  $\zeta_E(s)$  in  $L_E(s)$  require gamma factor  $\Gamma_{\mathbb{C}}(s)$  [with different Conductor integer values for different elliptic curves;  $\Lambda(s) = +\Lambda(2-s)$  when Analytic rank = 0, 2, 4, 6... "manifesting \*\*Line Symmetry"; and  $\Lambda(s) = -\Lambda(2-s)$  when Analytic rank = 1, 3, 5, 7... "manifesting \*\*Point Symmetry"]. For Analytic normalization in elliptic curves, the required "shifted" gamma factor is instead  $\Gamma_{\mathbb{C}}(s + \frac{1}{2})$ .



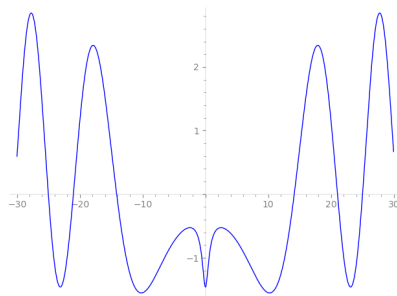

Figure 11. Graph of Z-function along  $\Re(s) = \frac{1}{2}$ -critical line for  $-\infty < t < \infty$  depicting UNIQUE nontrivial zeros spectrum for [Analytic rank 0] Dirichlet eta function  $\eta(s)$ ; the *Analytic continuation* of Riemann zeta function  $\zeta(s)$ . Note \*\*Line Symmetry of vertical y-axis and trajectory DO NOT intersect Origin point. Integral basis 1. [An integral basis of a number field  $K$  is a  $\mathbb{Z}$ -basis for ring of integers of  $K$ . This is also a  $\mathbb{Q}$ -basis for  $K$ .]

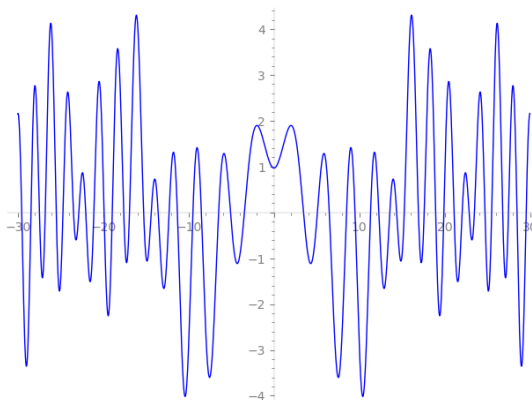

Figure 12. Graph of Z-function along [Analytically normalized]  $\Re(s) = \frac{1}{2}$ -critical line for  $-\infty < t < \infty$  depicting UNIQUE nontrivial zeros spectrum for Elliptic curve LMFDB label 49.a4 [with Analytic rank of 0]. Note \*\*Line Symmetry of vertical y-axis and trajectory DO NOT intersecting Origin point. Integral point is (2, -1).

We again adopt here  $\zeta(\sigma+it)$  when  $0 < t < \infty$  and ignore its complex conjugate  $\zeta(\sigma-it)$  when  $-\infty < t < 0$ . WITH applying Analytic normalization, we supply trivial zeros and nontrivial zeros [located at  $\sigma = \frac{1}{2}$ -Critical Line (instead of  $\sigma = 1$ -Critical Line)] derived from a **randomly selected [Conductor 389, semi-stable] Analytic rank 2** Elliptic curve with LMFDB label 389.a1 {  $y^2 + y = x^3 + x^2 - 2x$  } [when analytically continued from Convergence for  $R(s) > 1$  (instead of Convergence for  $R(s) > \frac{3}{2}$ ) to the entire complex plane; viz,  $R(s) > 0$ ]. We comparatively observe [unrelated] \*even MORE frequently occurring\* entities of trivial zeros and nontrivial zeros for this [**non-zero**] **Analytic rank 2 Elliptic curve** to be:  
 Trivial zeros  $L_E(s) = 0, -1, -2, -3, -4, -5, -6...$  [involve all *-ve* integers, **including 0**]  
 Nontrivial zeros  $L_E(s) = 0, 2.87, 4.41, 5.79, 6.98, 7.47, 8.63, 9.63, 10.35...$  [**1<sup>st</sup> nontrivial zero at  $t = 0$** ]

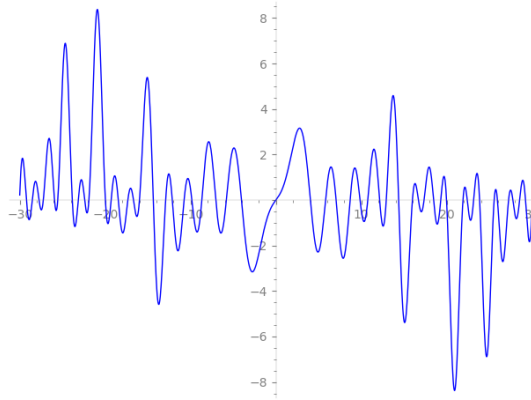

Figure 13. Graph of Z-function along [Analytically normalized]  $\Re(s) = \frac{1}{2}$ -critical line for  $-\infty < t < \infty$  depicting UNIQUE nontrivial zeros spectrum for Elliptic curve LMFDB label 65.a1 [with non-zero Analytic rank of 1]. Note \*\*Point Symmetry of Origin point and trajectory intersecting Origin point. Integral points are  $(-1, 1)$ ,  $(-1, 0)$ ,  $(0, 0)$ ,  $(1, 0)$ ,  $(1, -1)$ ,  $(4, 6)$ ,  $(4, -10)$ .

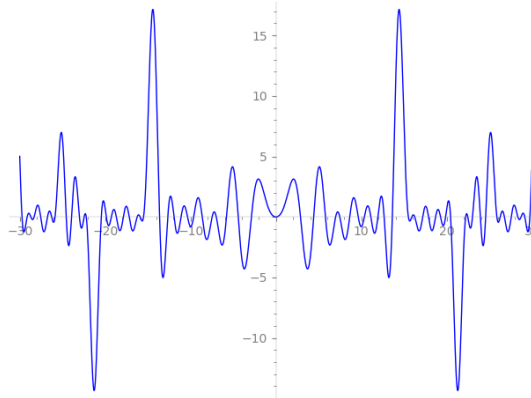

Figure 14. Graph of Z-function along [Analytically normalized]  $\Re(s) = \frac{1}{2}$ -critical line for  $-\infty < t < \infty$  depicting UNIQUE nontrivial zeros spectrum for Elliptic curve LMFDB label 389.a1 [with non-zero Analytic rank of 2]. Note \*\*Line Symmetry of vertical y-axis and trajectory intersecting Origin point. Integral points are  $(-2, 0)$ ,  $(-2, -1)$ ,  $(-1, 1)$ ,  $(-1, -2)$ ,  $(0, 0)$ ,  $(0, -1)$ ,  $(1, 0)$ ,  $(1, -1)$ ,  $(3, 5)$ ,  $(3, -6)$ ,  $(4, 8)$ ,  $(4, -9)$ ,  $(6, 15)$ ,  $(6, -16)$ ,  $(39, 246)$ ,  $(39, -247)$ ,  $(133, 1539)$ ,  $(133, -1540)$ ,  $(188, 2584)$ ,  $(188, -2585)$ .

Complying with "simplest version" of BSD conjecture: Analytic  $L_E(\frac{1}{2}) = 0$  associated with this Rank 2 [viz, Rank  $\neq 0$ ] elliptic curve LMFDB label 389.a1  $\implies$  infinitely many  $E(\mathbb{Q})$  solutions. In comparison, Analytic  $L_E(\frac{1}{2}) \neq 0$  associated with all Rank 0 elliptic curves  $\implies$  finitely many or zero  $E(\mathbb{Q})$  solutions.

This Elliptic curve LMFDB label 389.a1 has **Euler product**:  $L(s) = \prod_p F_p(p^{-s})^{-1}$ . One can look up in LMFDB website [single] "bad" prime at  $p$  389 with  $F_p(T) = 1 - T$  of degree 1, and [infinitely-many] "good" primes with their corresponding  $F_p(T)$  e.g. at  $p = 2$ ,  $F_p(T) = 1 + pT + pT^2$  of degree 2.

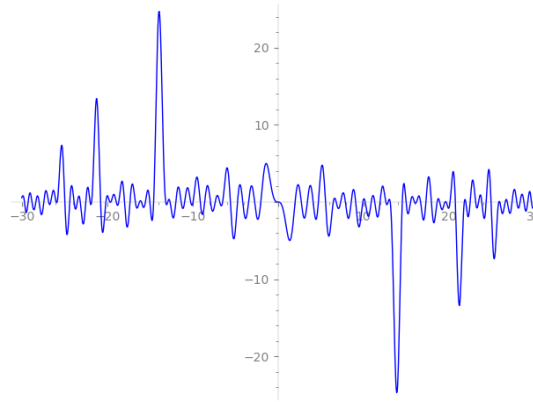

Figure 15. Graph of Z-function along [Analytically normalized]  $\Re(s) = \frac{1}{2}$ -critical line for  $-\infty < t < \infty$  depicting UNIQUE nontrivial zeros spectrum for Elliptic curve LMFDB label 21858.a1 [with non-zero Analytic rank of 3]. Note \*\*Point Symmetry of Origin point and trajectory intersecting Origin point. Integral points are  $(-7, 5), (-7, 2), (-6, 12), (-6, -6), (-4, 14), (-4, -10), (-2, 12), (-2, -10), (1, 5), (1, -6), (2, 2), (2, -4), (3, 0), (3, -3), (4, 2), (4, -6), (5, 5), (5, -10), (7, 12), (7, -19), (11, 29), (11, -40), (14, 44), (14, -58), (22, 92), (22, -114), (30, 150), (30, -180), (68, 530), (68, -598), (119, 1244), (119, -1363), (122, 1292), (122, -1414), (137, 1541), (137, -1678), (786, 21660), (786, -22446), (1069, 34437), (1069, -35506), (38746, 7607514), (38746, -7646260), (783868, 693616502), (783868, -694400370)$ .

This Elliptic curve LMFDB label 389.a1 has **Dirichlet series**, an (infinite) alternating harmonic series, of  $L_E(s) = 1 - 2 \cdot 2^{-s} - 2 \cdot 3^{-s} + 2 \cdot 4^{-s} - 3 \cdot 5^{-s} + 4 \cdot 6^{-s} - 5 \cdot 7^{-s} + 9^{-s} + 6 \cdot 10^{-s} - 4 \cdot 11^{-s} - 4 \cdot 12^{-s} - 3 \cdot 13^{-s} + 10 \cdot 14^{-s} + 6 \cdot 15^{-s} - 4 \cdot 16^{-s} - 6 \cdot 17^{-s} - 2 \cdot 18^{-s} + 5 \cdot 19^{-s} - 6 \cdot 20^{-s} + 10 \cdot 21^{-s} + 8 \cdot 22^{-s} - 4 \cdot 23^{-s} + 4 \cdot 25^{-s} + 6 \cdot 26^{-s} + 4 \cdot 27^{-s} - 10 \cdot 28^{-s} - 6 \cdot 29^{-s} - 12 \cdot 30^{-s} + \dots$  **Functional equation** (Analytically normalized) for this Elliptic curve LMFDB label 389.a1:  $\Lambda(s) = 389^{\frac{s}{2}} \Gamma_{\mathbb{C}}(s + \frac{1}{2}) L(s) = \Lambda(2 - s)$ .

The nontrivial zeros, as denoted by +ve  $\mathbb{R}$   $\gamma$  values, of an L-function  $L(s)$  are complex numbers  $\rho$  for which  $L(\rho) = L(\frac{1}{2} + i\gamma) = 0$ . (Hardy or Riemann-Siegel) **Z-function** for Riemann zeta-function is a real-valued function defined in terms of values of  $\zeta(s)$  on Critical Line via formula  $Z(t) := e^{i\theta(t)} \zeta\left(\frac{1}{2} + it\right)$ , where  $\theta(t)$  is **Riemann-Siegel theta function**  $\theta(t) := \arg\left(\Gamma\left(\frac{2it+1}{4}\right)\right) - \frac{\log \pi}{2}t$ . There is a bijection between zeros  $t_0$  of  $Z(t)$  and zeros  $\frac{1}{2} + it_0$  of  $\zeta(s)$ . Z-function of a general L-function is a smooth real-valued function of a real variable  $t$  such that  $|Z(t)| = |L(\frac{1}{2} + it)|$ . Specifically, if we write the completed L-function as  $\Lambda(s) = \gamma(s)L(s)$ , where  $\Lambda(s)$  satisfies functional equation  $\Lambda(s) = \varepsilon \overline{\Lambda}(1 - s)$ , then  $Z(t)$  is defined by  $Z(t) = \frac{\varepsilon^{\frac{1}{2}} \gamma(\frac{1}{2} + it)}{|\gamma(\frac{1}{2} + it)|} L(\frac{1}{2} + it)$ . In portion  $\varepsilon^{\frac{1}{2}} = \sqrt{\varepsilon}$ , the square root is chosen so that  $Z(t) > 0$  for sufficiently small  $t > 0$ ; viz, e.g.  $\sqrt{9} = 3, \sqrt{4} = 2, \sqrt{0.002} = \text{"larger value"} 0.0447213\dots, \sqrt{0.0002} = \text{"larger value"} 0.014142\dots$ , etc  $\equiv$  **LMFDB normalization**". Denote  $r =$  Analytic rank. Then LMFDB normalization is different / separate to **"Sign normalization"** for  $\varepsilon$  which we advocate to be represented by  $(1)^{r-1}$  for

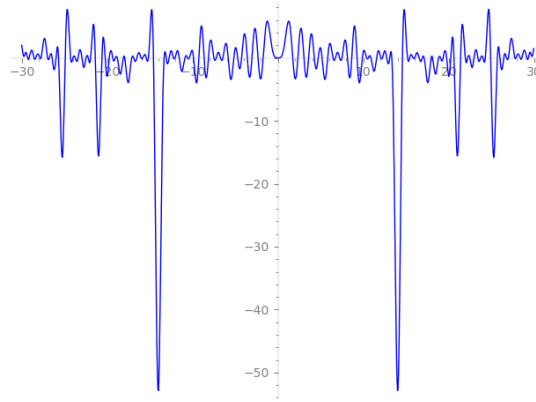

Figure 16. Graph of Z-function along [Analytically normalized]  $\Re(s) = \frac{1}{2}$ -critical line for  $-\infty < t < \infty$  depicting UNIQUE nontrivial zeros spectrum for Elliptic curve LMFDB label 234446.a1 [with non-zero Analytic rank of 4]. Note \*\*Line Symmetry of vertical y-axis and trajectory intersecting Origin point. Integral points are  $(-10, 7), (-10, 3), (-9, 19), (-9, -10), (-8, 23), (-8, -15), (-7, 25), (-7, -18), (-4, 25), (-4, -21), (0, 17), (0, -17), (1, 14), (1, -15), (3, 7), (3, -10), (4, 3), (4, -7), (5, -2), (5, -3), (6, -1), (6, -5), (7, 3), (7, -10), (8, 7), (8, -15), (12, 25), (12, -37), (13, 30), (13, -43), (22, 83), (22, -105), (27, 118), (27, -145), (29, 133), (29, -162), (38, 207), (38, -245), (60, 427), (60, -487), (70, 543), (70, -613), (91, 815), (91, -906), (123, 1295), (123, -1418), (129, 1393), (129, -1522), (176, 2239), (176, -2415), (292, 4835), (292, -5127), (992, 30735), (992, -31727), (1140, 37907), (1140, -39047), (1656, 66545), (1656, -68201), (4532, 302803), (4532, -307335), (10583, 1083382), (10583, -1093965), (19405, 2693397), (19405, -2712802).$

**even  $r$  with  $\epsilon = 1$  and by  $(i)^{r-1}$  for odd  $r$  with  $\epsilon = i$  [that obeys  $n^{\text{th}}$  root of unity for  $i$ ].** Intuitively, one anticipate Sign changes to occur exactly when  $r \equiv 1, 2 \pmod{4}$  but: [I] For even  $r = 0, 2, 4, 6, 8, \dots$ ;  $1^{r-1} = (1)^{-1}, (1)^1, (1)^3, (1)^5, (1)^7, \dots =$  same  $+1$  sign [of  $+1, +1, +1, +1, +1, \dots$ ]. c.f. [II] For odd  $r = 1, 3, 5, 7, 9, \dots$ ;  $i^{r-1} = (i)^0, (i)^2, (i)^4, (i)^6, (i)^8, \dots =$  alternating  $\pm 1$  sign [of  $+1, -1, +1, -1, +1, \dots$ ]. For all elliptic curves, we confirm with LMFDB Support [Email: [lmfdb-support@googlegroups.com](mailto:lmfdb-support@googlegroups.com)] on its source code that  $+1$  from  $\pm 1$  choices and  $+i$  from  $\pm i$  choices had, respectively, been arbitrarily chosen [standardized] for even Analytic rank and odd Analytic rank. The multiset of zeros of  $Z(t)$  matches that of  $L(\frac{1}{2} + it)$  and  $Z(t)$  changes sign at zeros of  $L(\frac{1}{2} + it)$  of odd multiplicity. Graph of Z-function depicting nontrivial zeros (spectrum) for (even) Analytic rank 2 Elliptic curve LMFDB label 389.a1 is in Figure 14 with Q I Z(t) positivity. That for "most basic" (even) Analytic rank 0 Dirichlet eta function is in Figure 11 with Q IV Z(t) negativity; for (even) Analytic rank 0 [of varying proximity to  $t = 0$ ] Elliptic curve LMFDB label 49.a4 is in Figure 12 with Q I Z(t) positivity; for (odd) Analytic rank 1 Elliptic curve LMFDB label 65.a1 is in Figure 13 with Q I Z(t) positivity; for (odd) Analytic rank 3 Elliptic curve LMFDB label 21858.a1 is in Figure 15 with Q IV Z(t) negativity; and for (even) Analytic rank 4 Elliptic curve LMFDB label 234446.a1 is in Figure 16 with Q I Z(t) positivity. By our Sign normalization, we anticipate all LMFDB

(odd) Analytic rank 3 Elliptic curves to manifest Q I Z(t) positivity, but we observe this need not always happen as exception [e.g. for elliptic curve 5077.a1].

**Remark A.1. Conjecture on "Altered Q I Z(t) positivity / Q IV Z(t) negativity" criterion in Graphs of Z-function (observational LMFDB study):** Analytic rank  $r$  of elliptic curves  $E$  consist of even  $r = 0, 2, 4, 6, 8, 10, \dots$  [with Line symmetry and  $\varepsilon = 1, \varepsilon^{\frac{1}{2}} = +1$  or  $-1$  that can arbitrarily be chosen or assigned to display Z(t) plots in two reciprocal manners "+1 Z(t)" or "-1 Z(t)"], and odd  $r = 1, 3, 5, 7, 9, \dots$  [with Point symmetry and  $\varepsilon = -1, \varepsilon^{\frac{1}{2}} = +i$  or  $-i$  that can arbitrarily be chosen or assigned to display Z(t) plots in two reciprocal manners "+i Z(t)" or "-i Z(t)"]. Note:  $r = 0$  for (non-elliptic) Riemann zeta function  $\zeta(s)$  / Dirichlet eta function  $\eta(s)$ . Polar graphs e.g. all Analytically normalized  $\sigma = \frac{1}{2}$ -Critical Line Polar graphs of  $E$ , Polar graph Figure 2 on  $\sigma = \frac{1}{2}$ -Critical Line for (non-elliptic)  $\zeta(s)$  /  $\eta(s)$ , etc manifest features of even functions [when having even  $r$ ] and odd functions [when having odd  $r$ ]. Caveat: The horizontal x-axis and vertical y-axis are arbitrarily chosen such that Line symmetry is [dependently] the horizontal x-axis for Polar graphs having even  $r$ , but Point symmetry is [independently] the Origin point for Polar graphs having odd  $r$ . Cf: Line symmetry is [dependently] the vertical y-axis for Graphs of Z-functions having even  $r$ , but Point symmetry is [independently] the Origin point for Graphs of Z-functions having odd  $r$ . Considering  $0 < t < +\infty$  range in plotted trajectory of Polar graph or Graph of Z-function, let distance  $d =$  difference between  $P_1$  (trajectory initially intersecting horizontal x-axis of Polar graph / vertical y-axis in Graph of Z-function) and  $P_2$  (trajectory initially intersecting Origin point of Polar graph / Graph of Z-function). Then (i)  $d = P_2 - P_1 \neq 0$  for  $r = 0$   $\zeta(s)$  /  $\eta(s)$  and for  $r = 0$   $E$ , and (ii)  $d = P_2 - P_1 = 0$  for  $r = 1, 2, 3, 4, 5, \dots$   $E$  [with these findings being equally valid for  $-\infty < t < 0$  range].

Recall the parity of (simple) polynomial functions as being EITHER  $\pm$  even functions OR  $\pm$  odd functions: [I] e.g.  $y = \pm x^{0,2,4,6,8,10, \dots}$  being even functions with corresponding entire functions of  $-\infty < x < +\infty$  range being located in Quadrant I and II when "y is a +ve function" / in Quadrant III and IV when "y is a -ve function". [II] e.g.  $y = \pm x^{1,3,5,7,9,11, \dots}$  being odd functions with corresponding entire functions of  $-\infty < x < +\infty$  range being located in Quadrant I and III when "y is a +ve function" / in Quadrant II and IV when "y is a -ve function". Nomenclature: Let  $y$  and its exponents be denoted by  $\pm Z(t)$  and  $r$ . We analyze  $0 < t < +\infty$  range utilizing the [so-called] "first sinusoidal wave" of plotted Z-function for  $E$  which represent in a *de-facto* manner  $+Z(t)$  with even  $r$  [viz, Q I Z(t) positivity], and  $\pm Z(t)$  with odd  $r$  [viz, alternating Q I Z(t) positivity / Q IV Z(t) negativity]. This approach is valid despite Z(t) plots will infinitely often and "meaninglessly" oscillate above / below horizontal  $t$  axis after "first sinusoidal wave".

Then the above nomenclature explicitly  $\implies$   $\zeta(s)$  /  $\eta(s)$  in Figure 11 is an "EXCEPTION"  $-Z(t)$  with even  $r = 0$  [viz, showing Q IV Z(t) negativity].  $E$  in Figure 12 is an  $+Z(t)$  with even  $r = 0$  [viz, showing Q I Z(t) positivity].  $E$  in Figure 13 is an  $+Z(t)$  with odd  $r = 1$  [viz, showing Q I Z(t) positivity].  $E$  in Figure 14 is an  $+Z(t)$  with even  $r = 2$  [viz, showing Q I Z(t) positivity].  $E$  in Figure 15 is an  $-Z(t)$  with odd  $r = 3$  [viz, showing Q IV Z(t) negativity].  $E$  in Figure 16 is an  $+Z(t)$  with even  $r = 4$  [viz, showing Q I Z(t) positivity and prominent *flattening* of "first sinusoidal wave" at Origin point]. We propose all  $E$  with even  $r$  are represented by  $+Z(t)$  showing Q I Z(t) positivity; viz, complying with "Sign normalization" for even  $r$ ;

and all  $E$  with odd  $r$  are represented by  $\pm Z(t)$  showing alternating Q I Z(t) positivity / Q IV Z(t) negativity; viz, [inconsistently for exception elliptic curve 5077.a1] complying with "Sign normalization" for odd  $r$ . Additionally via various Incompletely Predictable "complex interactions", we intuitively expect frequency / complexity of nontrivial zeros (spectrum) and integer  $N$  values of conductor (or level) in L-functions of elliptic curves to be empirically correlated with Analytic rank 0, 1, 2, 3, 4, 5....

**Axes definitions for Polar graph VERSUS Graph of Z-function.** Involving complex variable  $s = \sigma \pm it$  for range  $-\infty < t < +\infty$  and for complete accuracy, we must notationally replace  $\zeta(s)$  (having Convergence for  $\sigma > 1$ ) with  $\eta(s)$  (having Convergence for  $\sigma > 0$ ) since nontrivial zeros only occur at  $\sigma = \frac{1}{2}$ -Critical Line [whereby for elliptic curves, this require Analytic normalization]. Polar graphs [viz, Figure 2]: Horizontal axis is  $Re\{\eta(\frac{1}{2} \pm it)\}$ . Vertical axis is  $Im\{\eta(\frac{1}{2} \pm it)\}$ . Graph of Z-function: Horizontal axis is variable  $t$ . Vertical axis is  $Z(t)$ . Here, LMFDB use  $Z(t) = \bar{\varepsilon}^{\frac{1}{2}} \frac{\gamma(\frac{1}{2} + it)}{|\gamma(\frac{1}{2} + it)|} L(\frac{1}{2} + it)$  BUT one could also use  $Z(t) = \bar{\varepsilon} \frac{\gamma(\frac{1}{2} + it)}{|\gamma(\frac{1}{2} + it)|} L(\frac{1}{2} + it)$  [without incorporating  $\sqrt{\varepsilon}$ ; viz, without having LMFDB normalization].

**Overall SUMMARY:** All infinitely-many nontrivial zeros are always Incompletely Predictable entities irrespective of their L-function source. Graphs of Z-function for elliptic curves in LMFDB website with non-zero Analytic rank 1, 2, 3, 4, 5... HAVE trajectories that intersect Origin point. Graphs of Z-function for elliptic curves in LMFDB website with Analytic rank 0 [viz, having zero independent basis point (with infinite order) which can be associated with either finitely many or zero  $E(\mathbb{Q})$  solutions] DO NOT HAVE trajectories that intersect the Origin point. [Ditto for Graph of Z-function on (non-elliptic) Riemann zeta function / Dirichlet eta function with Analytic rank 0.] **This implies the "simplest version" of BSD conjecture to be true.** The **Altered Q I Z(t) positivity / Q IV Z(t) negativity criterion in Graphs of Z-function** is used to further characterize odd and even Analytic rank elliptic curves (see Remark A.1) whereby our preliminary findings seem to suggest the semi-qualitative classification of odd Analytic rank  $\geq 3$ -elliptic curves may [intrinsically] be slightly counterfactual. *Geometrically studying nontrivial zeros (spectrum) using **Graphs of Z-function plots vs Polar graphs plots** to determine various altered features in patterns, symmetry, frequency, etc promises to be a useful analytic method to characterize L-functions of different Analytic rank 0, 1, 2, 3, 4, 5....*

(Received: August 4, 2024)

Prof. Dr. John Yuk Ching Ting, Dental and Medical Surgery, 12 Splendid Drive, Bridgeman Downs, Queensland 4035, Australia.

Affiliated with University of Tasmania, Churchill Avenue, Hobart, Tasmania 7005, Australia. ORCID 0000-0002-3083-5071

E-mail : [jycting@utas.edu.au](mailto:jycting@utas.edu.au)

<https://jycting.wordpress.com>